

PLAN - SUB AQUEOUS OUTFALL & DIFFUSER
SCALE: 1" = 50'

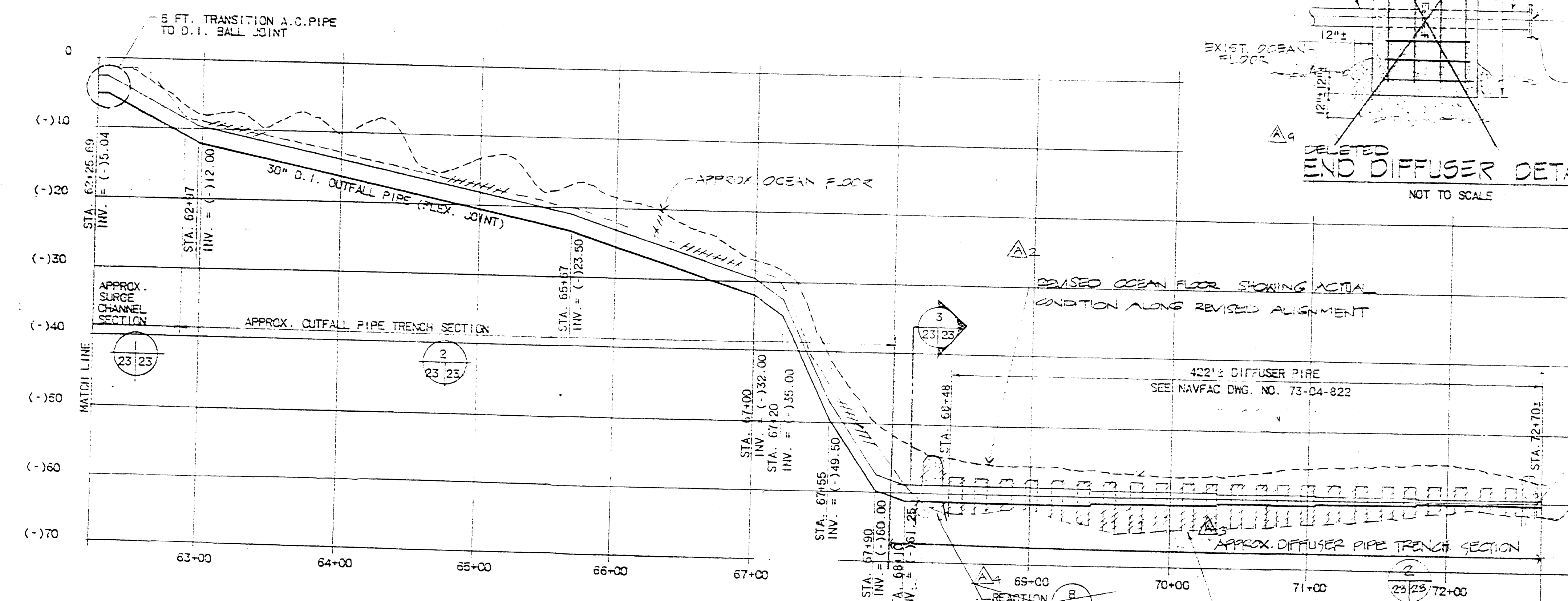

PROFILE - SUB AQUEOUS OUTFALL & DIFFUSER

NOTE:
ALL UNDERWATER REINFORCING STEEL TO HAVE A MIN. OF 6" COVER.

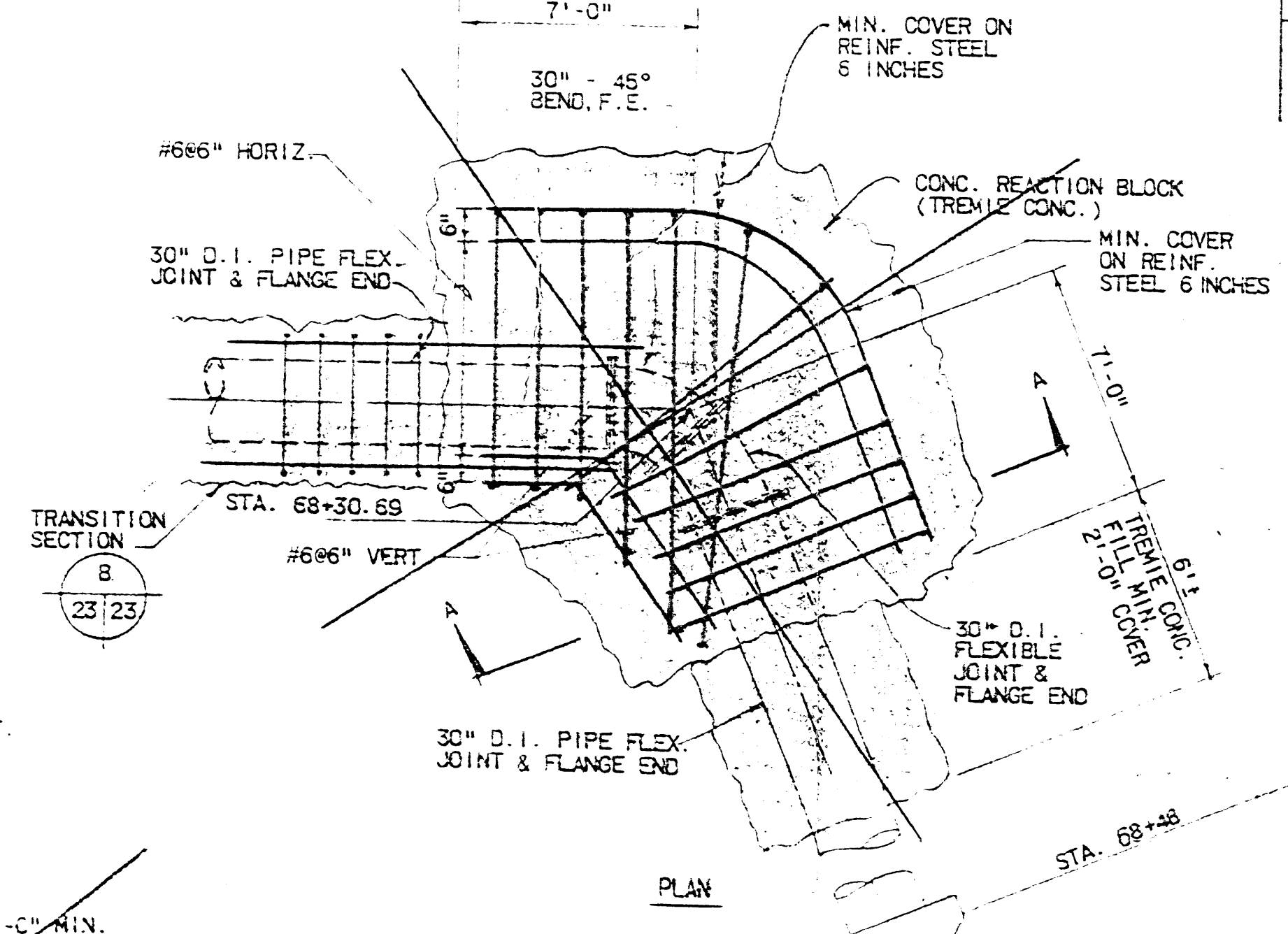

REACTION BLOCK DETAIL (A)
SCALE: 1/4" = 1'-0"

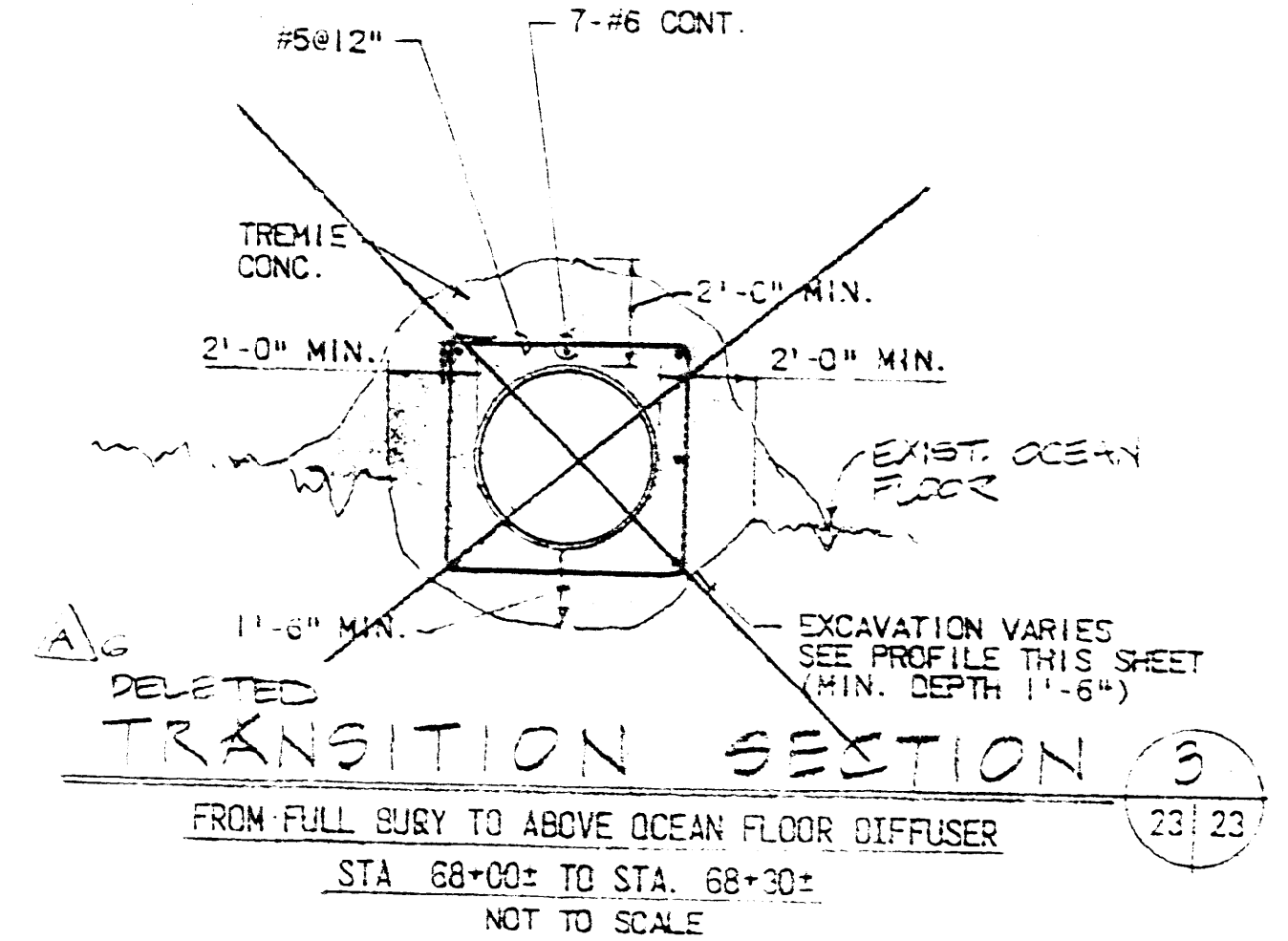

TRANSITION SECTION (B)
FROM FULL BURY TO ABOVE OCEAN FLOOR DIFFUSER
STA. 68+00 TO STA. 68+30
NOT TO SCALE

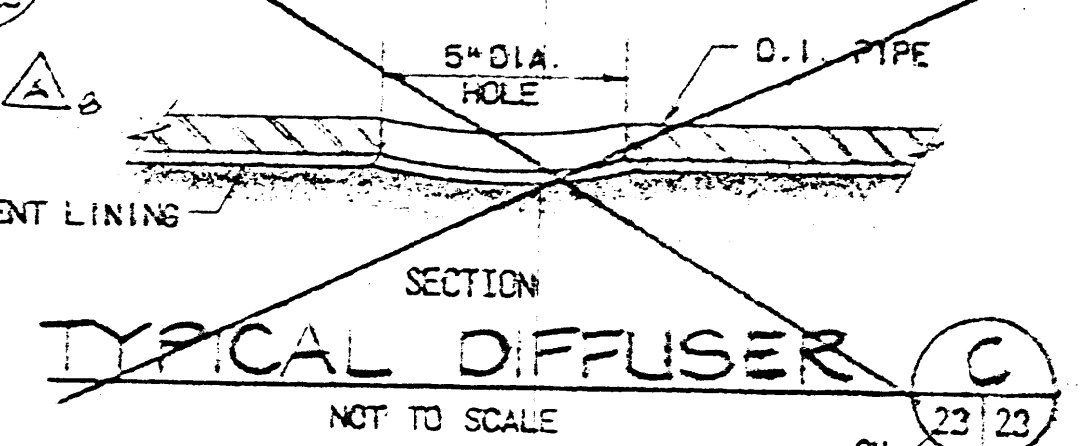
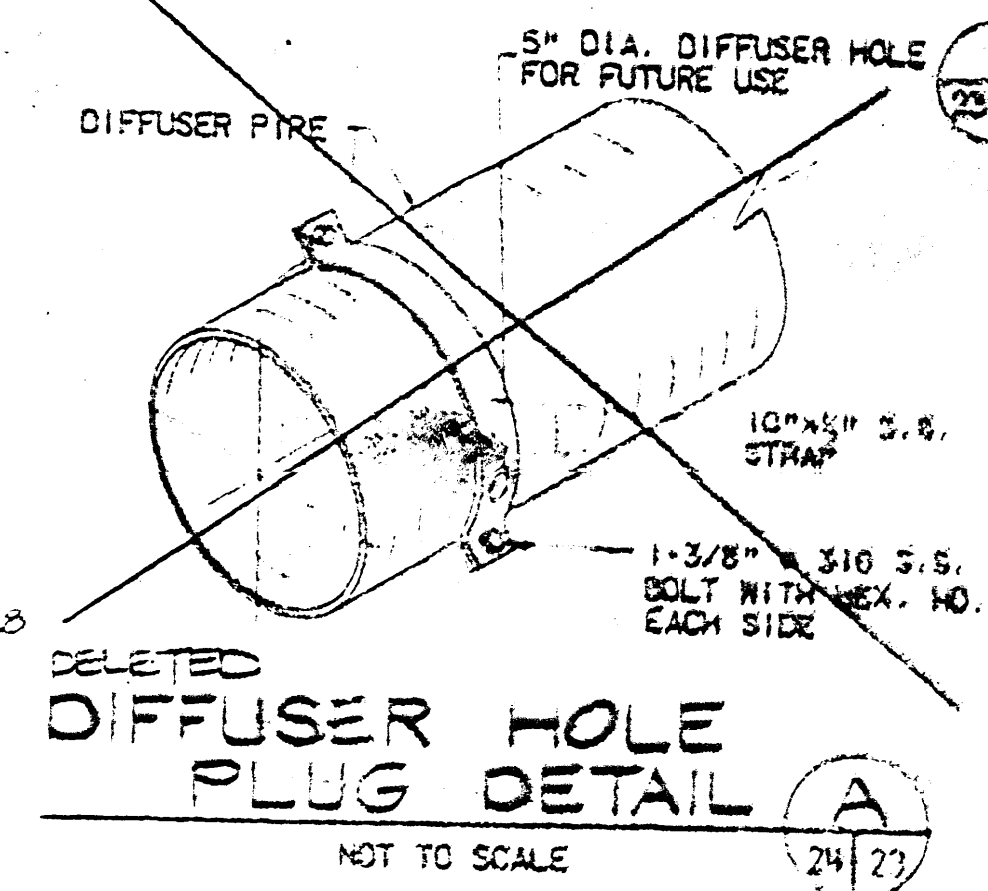

NOT TO SCALE

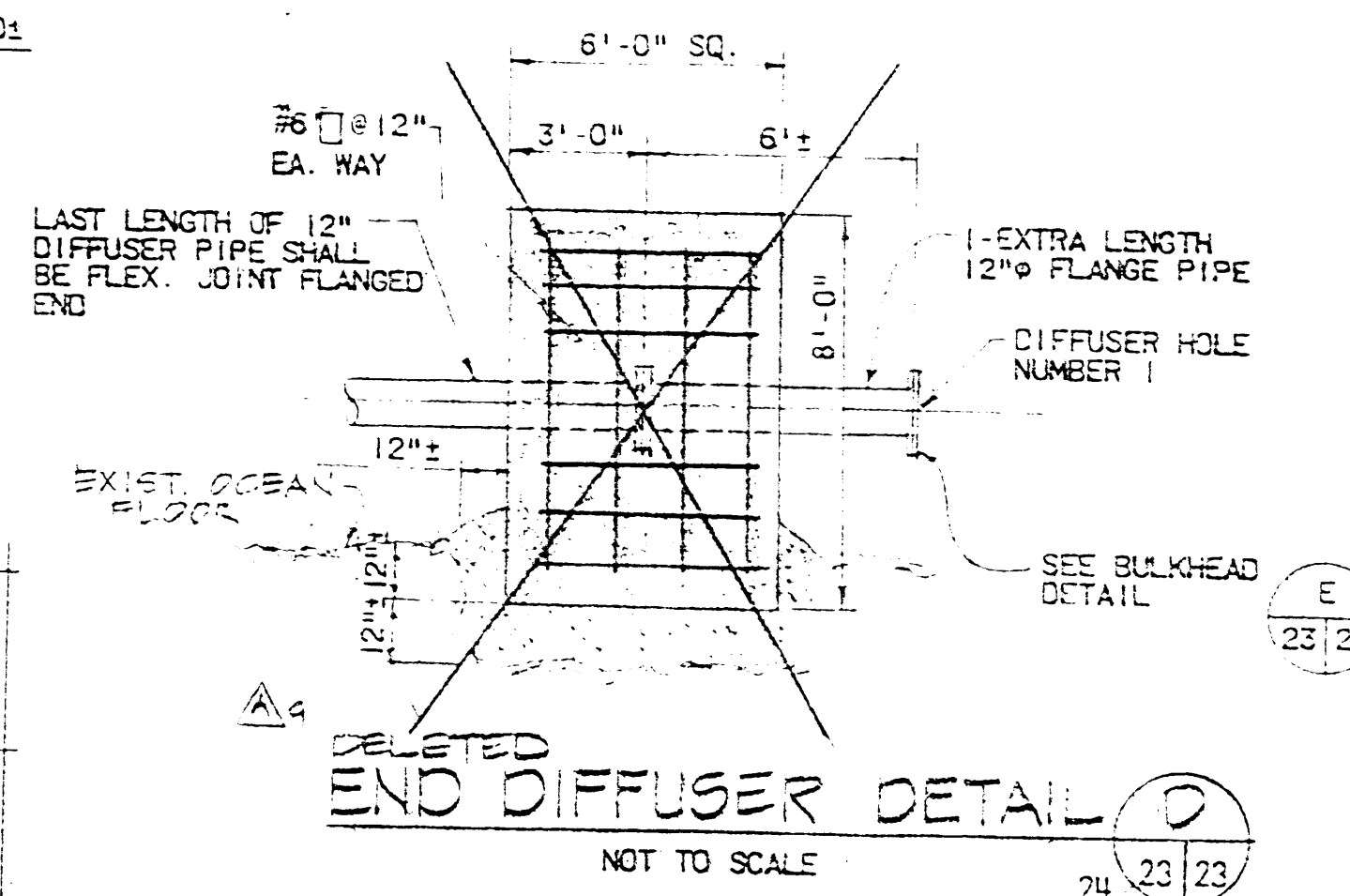

NOT TO SCALE

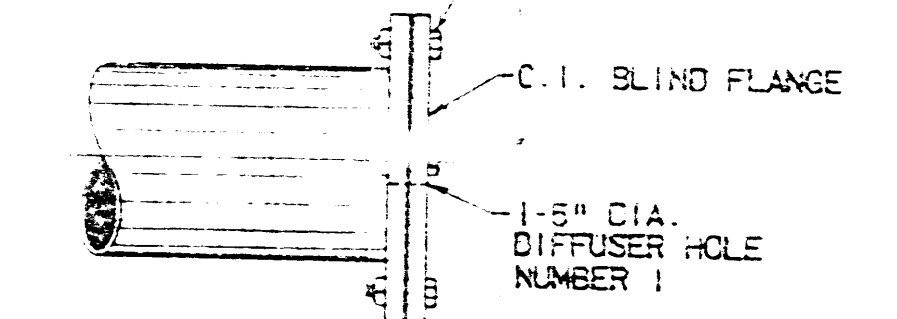

NOT TO SCALE

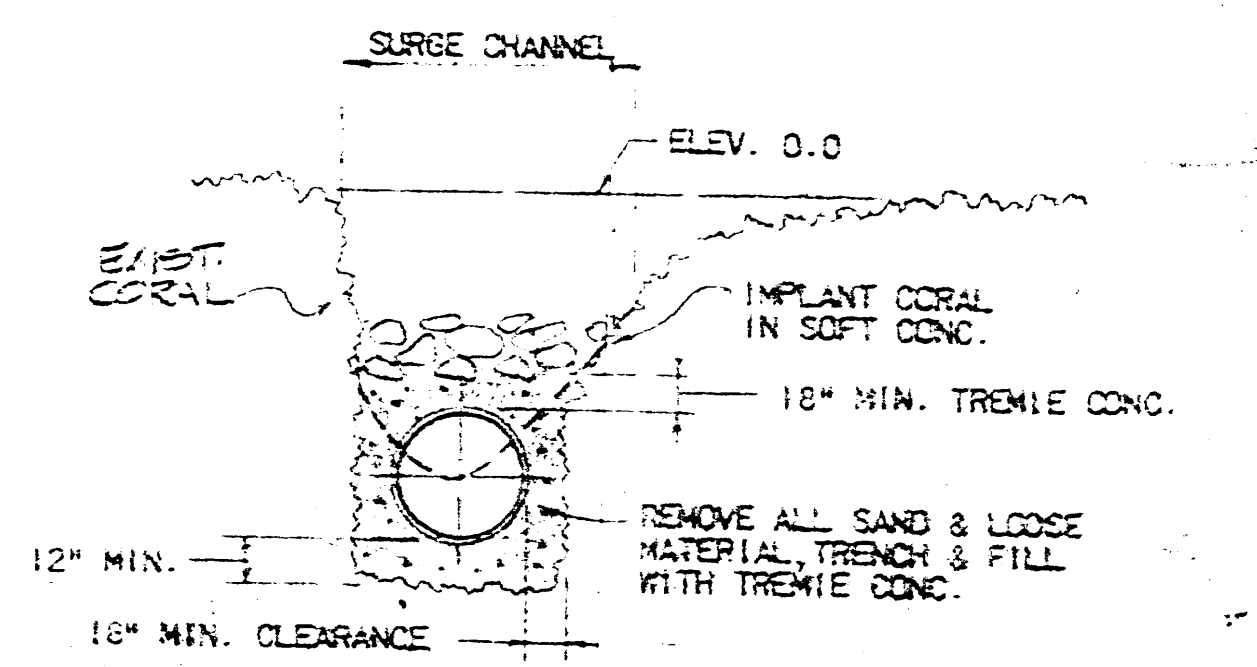

NOT TO SCALE

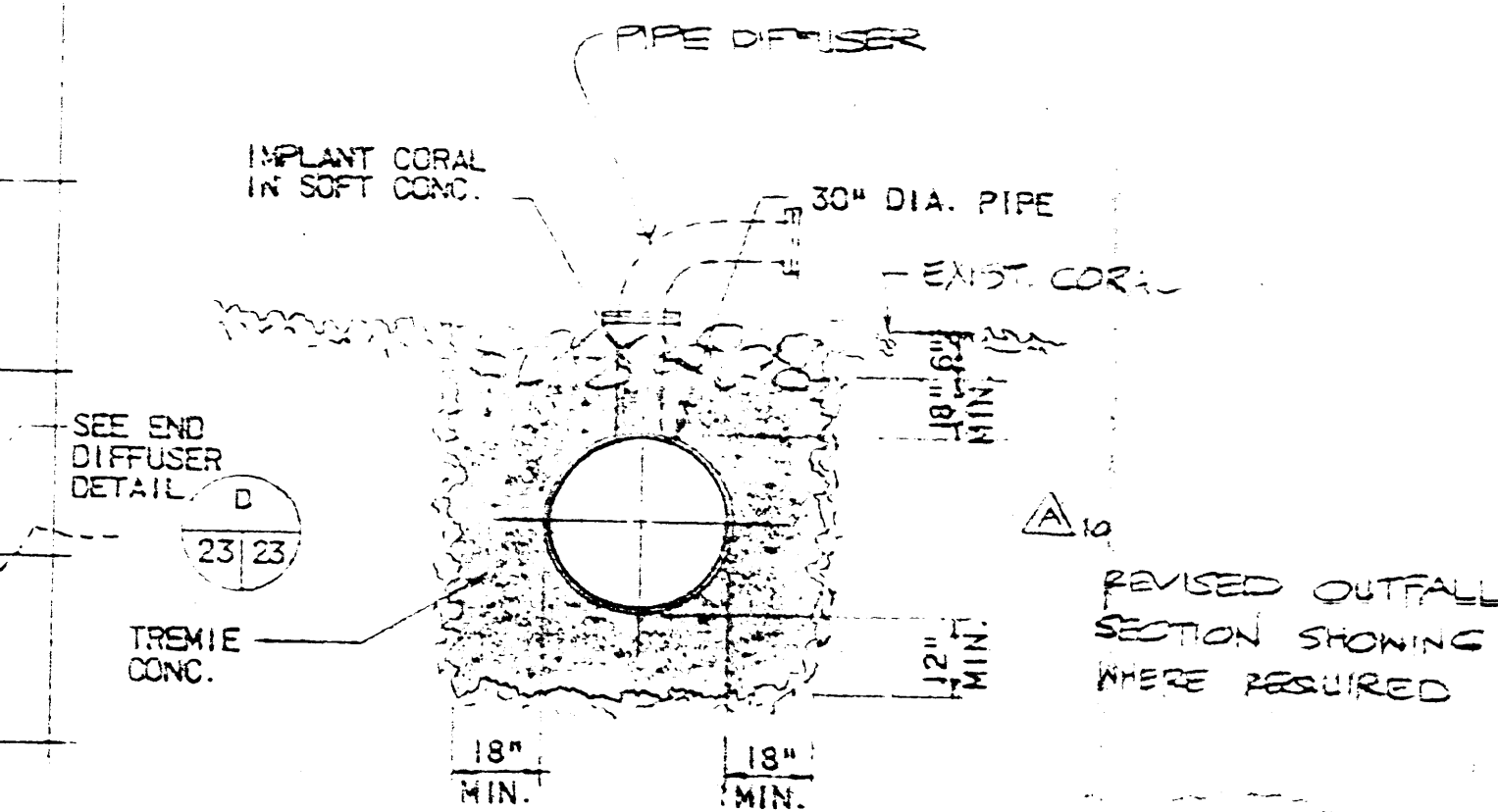

NOT TO SCALE

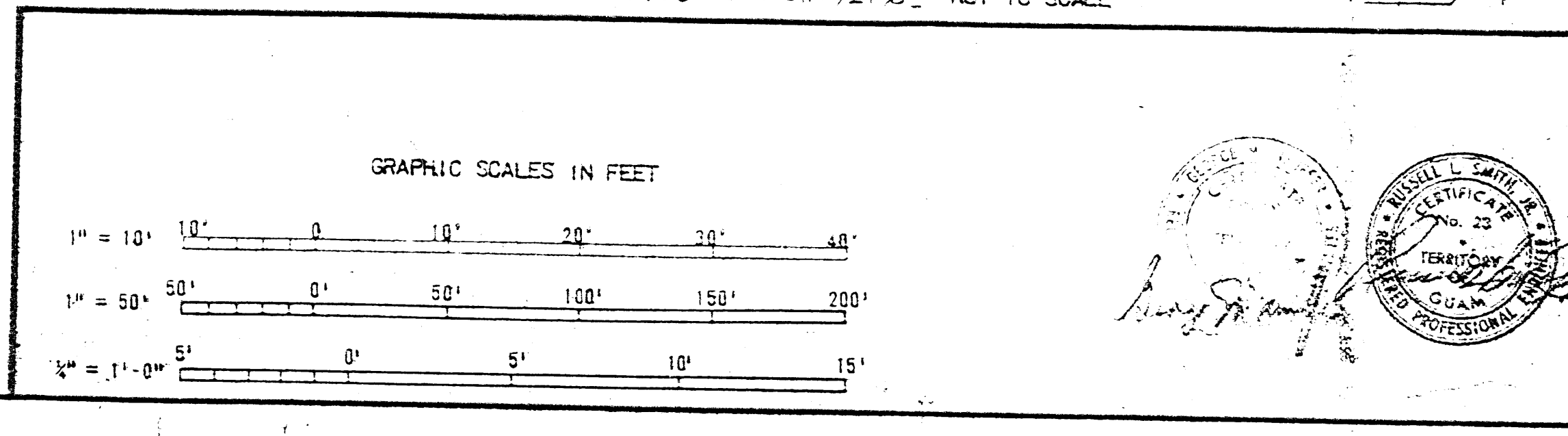

ASA AUSTIN SMITH & ASSOC., INC.		DEPARTMENT OF THE NAVY - NAVAL FACILITIES ENGINEERING COMMAND	
OFFICE IN CHARGE OF CONSTRUCTION		OFFICER IN CHARGE OF CONSTRUCTION	
NAVAL FACILITIES ENGINEERING COMMAND CONTRACTS, MARINA GUAM, H. I.		NAVAL FACILITIES ENGINEERING COMMAND CONTRACTS, MARINA GUAM, H. I.	
PROJECT: NORTHERN DISTRICT SEWERAGE SYSTEM		PROJECT: NORTHERN DISTRICT SEWERAGE SYSTEM	
SUBJECT: NORTHERN LINK AND TREATMENT PLANT		SUBJECT: NORTHERN LINK AND TREATMENT PLANT	
DRAWING NO.: 73-04-822		DRAWING NO.: 73-04-822	
SCALE: AS SHOWN		SCALE: AS SHOWN	
DATE: 2.23.75		DATE: 2.23.75	
DRAWN BY: [Signature]		DRAWN BY: [Signature]	
CHECKED BY: [Signature]		CHECKED BY: [Signature]	
APPROVED BY: [Signature]		APPROVED BY: [Signature]	
OFFICER IN CHARGE		OFFICER IN CHARGE	
F 800S1		F 800S1	
73-04-822		73-04-822	
CONTRACT NO. 73-04-822		CONTRACT NO. 73-04-822	
SCALE: AS SHOWN		SCALE: AS SHOWN	