

Novel and Emerging Technologies for Produced Water Treatment

Pei Xu, Tzahi Cath and Jörg E. Drewes

Colorado School of Mines

US EPA Technical Workshops for the Hydraulic Fracturing

Wednesday, March 30, 2011, Arlington, VA



Selection of Treatment Technologies

▶ Water Chemistry

▶ Pressure

- Some producers inject produced water at high pressure

▶ Thermal resources

- Low-grade heat can be utilized for thermal desalination



Produced Water Treatment Technologies

► Requirements

- High recovery: minimize waste volume and disposal
- High rejection of contaminants: meet stringent discharge requirements
- Robustness and low-maintenance: reduce labor and supervision requirement
- Flexibility: able to handle high variation in water quality and quantity
- Modular:
 - small footprint
 - minimal environmental disturbance

Treatment Technology Assessment

▶ Review identified 34 fundamental treatment technologies and 21 integrated systems/processes

- Commercial status of technology
- Feed and product water quality
- Removal efficiencies
- Recovery
- Infrastructure considerations
- Energy consumption
- Chemical demand
- Life cycle and costs
- O&M considerations

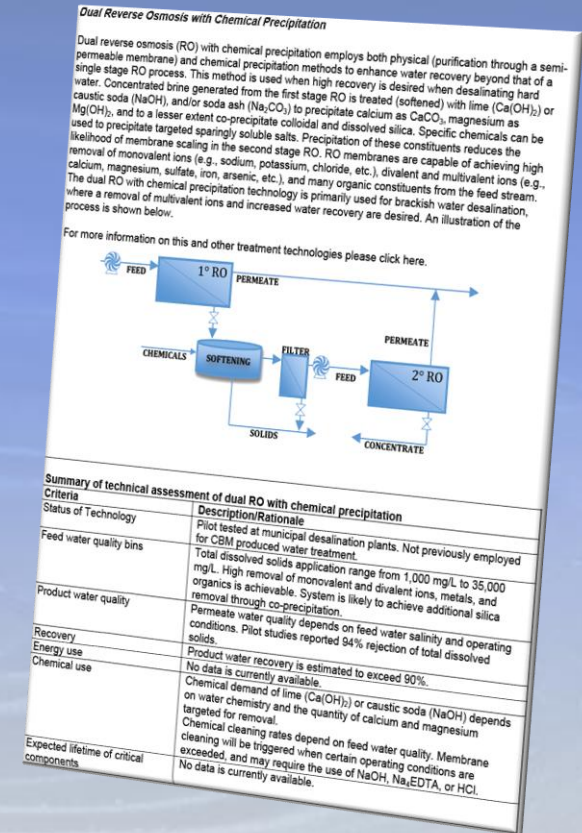

Fundamental Treatment Technologies

Pretreatment

Basic Separation

- Settling
- Electrocoagulation
- Flotation
- Hydrocyclone

Adsorption

- Activated carbon
- Zeolite
- Ion exchange

Advanced

- Chemical oxidation
- Microfiltration
- Ultrafiltration



Submerged Ultrafiltration
Membrane System by Zenon

Desalination Treatment Technologies

Membrane Separations

High Pressure Membrane

- Reverse osmosis
- Nanofiltration
- VSEP

Electrically Driven Processes

- Electrodialysis
- Electrodionization
- CDI

Novel Membrane Processes

- Membrane distillation
- Forward osmosis

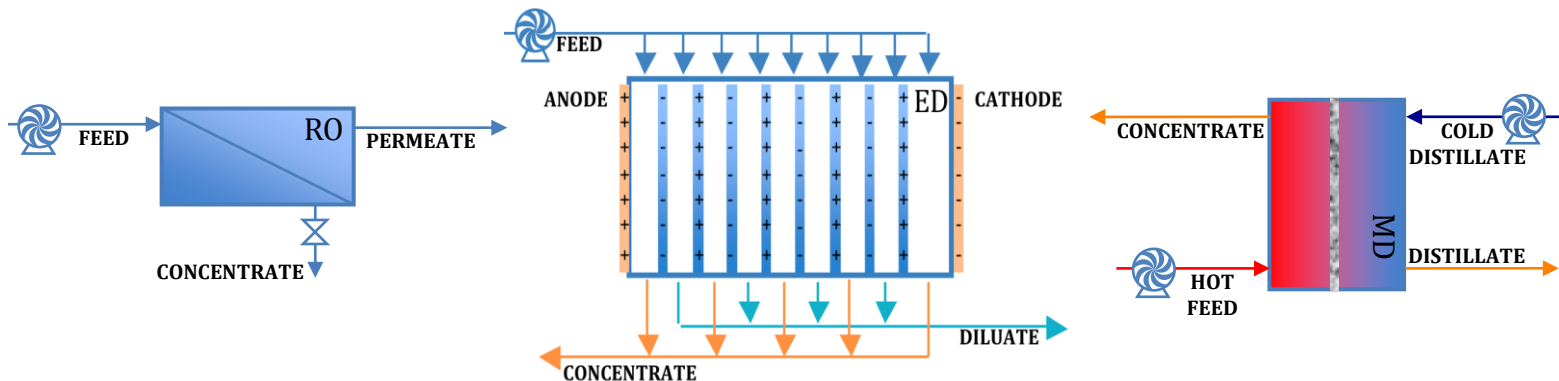



Desalination Treatment Technologies

Membrane Separations

High Pressure Membrane

- Reverse osmosis
- Nanofiltration
- VSEP

Electrically Driven Processes

- Electrodialysis
- Electrodionization
- CDI

Novel Membrane Processes

- Membrane distillation
- Forward osmosis

Thermal Technologies

- Vapor compression
- Multi-effect distillation
- Multi-stage flash
- Dewvaporation
- Freeze-thaw

Zero-liquid Discharge

- Evaporation
- Crystallizer
- Wind aided intensified evap.



Integrated Systems

Pressure Driven

Two Stage RO Hybrids

- Dual RO: chemical precip.
- Dual RO: high pH operation
- Dual RO: slurry precipitation
- Forward osmosis / RO

Commercial Solutions

- Veolia: Opus™
- Eco-Sphere: Ozonix™
- CDM produced water sys.
- Sal-Proc™

Enhanced Distillation

- Mechanical vapor compression
Aquatech and GE
- Mechanical vapor recompression
Aqua-Pure and 212 Resources
- Intevras: EVRAS™
- Total Separation Solutions: SPR-PYROS™

Produced Water Treatment and Beneficial Use Information Center

Sustainable and beneficial use of produced water from coalbed methane resources

[Home](#)

[Introduction](#)

[Assessing Beneficial Uses](#)

[Treatment Options](#)

[Tools](#)

[Documents](#)

[Regulations](#)

The Produced Water Treatment and Beneficial Use Information Center is an online resource for technical and regulatory information on quantity, quality, and treatment technologies for produced water from coalbed methane (CBM) resources in the western United States.

This site provides information on location and quality of CBM produced water, current and potential future treatment and use of CBM produced water, state and federal regulations pertaining to discharge and use, and guidelines and tools for selection of treatment technologies for optimal management practices.

Site Contents

▶ Introduction

Introductory information on beneficial uses and produced water

▶ Assessing Beneficial Uses

Beneficial use matrix, key criteria, and case studies

▶ Treatment Options

Summaries of treatment options and related fact sheets

▶ Tools

Tools for water quality, treatment technology, costs, key elements

▶ Documents

Service provider/broker list, model contract

▶ Regulations

Regulatory requirements for produced water management for selected states

News

December 27, 2010

[The CBM Produced Water Management Tool is now available to the public](#)

September 12, 2010

[CSM presentations at IPEC 2010](#)

Subscribe

Enter your e-mail address below to receive updates and announcements.

[Subscribe](#)

http://aqwatec.mines.edu/produced_water/



More About Novel and Emerging Treatment Technologies



Ion Exchange Process

► Pros

- Cost competitive to low salinity and sodium bicarbonate type water
- Robust
- High water recovery (~ 97-99%)

► Cons

- Waste disposal
- Use of chemicals for regeneration (desalination)
- Might not be cost-effective for other types of water



Pressure-Driven Membrane Separation

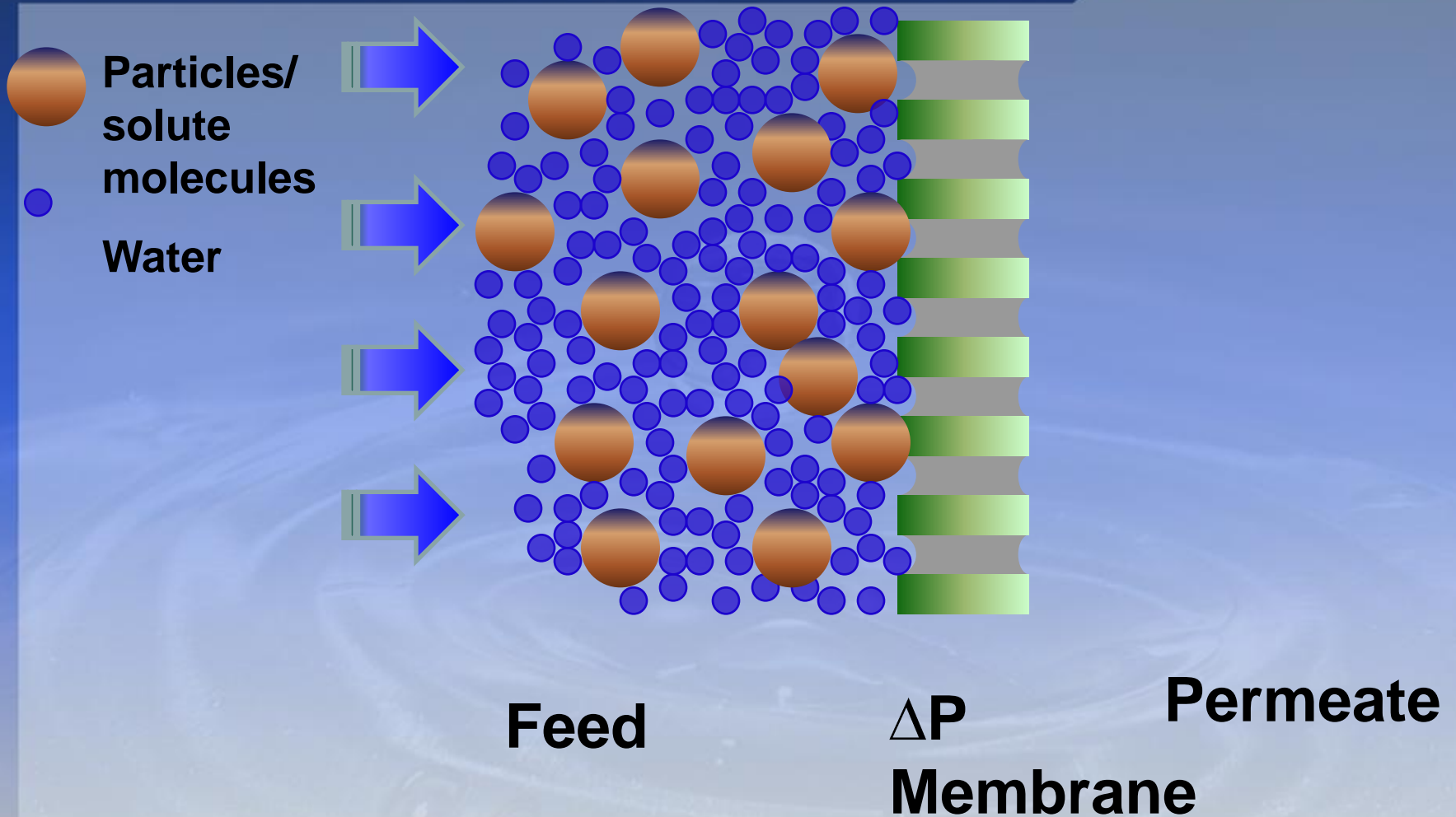

Pressure-Driven Membrane Separation

▶ Pros

- Cost competitive to low and high salinity water (<40,000 mg/L TDS)
- Flexible
- Robust

▶ Cons

- Membrane fouling and scaling
- Limited recovery
- Extensive pretreatment for complex water chemistry
- Waste disposal

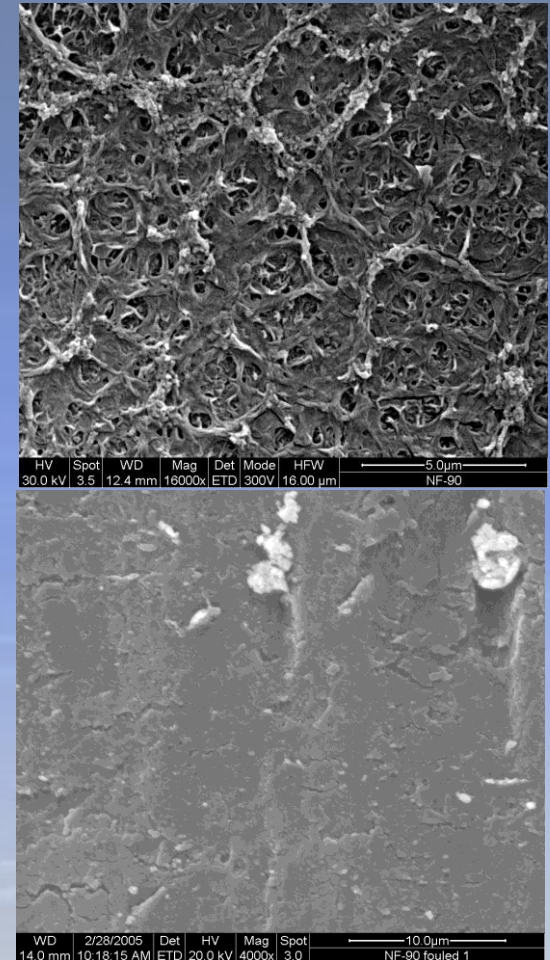

Source: Xu & Drewes, 2006

Ceramic Ultrafiltration and Nanofiltration

- ▶ Typical materials oxides, nitrides, or carbides of metals (alumina, zirconia, titania)
- ▶ Benefits
 - High mechanical strength
 - High chemical compatibility
 - High flux (up to 150 gfd)
 - Long operational life
 - Thermal stability
 - Potentially lower life-cycle cost
- ▶ Potential limitations
 - High capital cost
 - Large footprint (low packing density)



Electro-Driven Membrane Separation

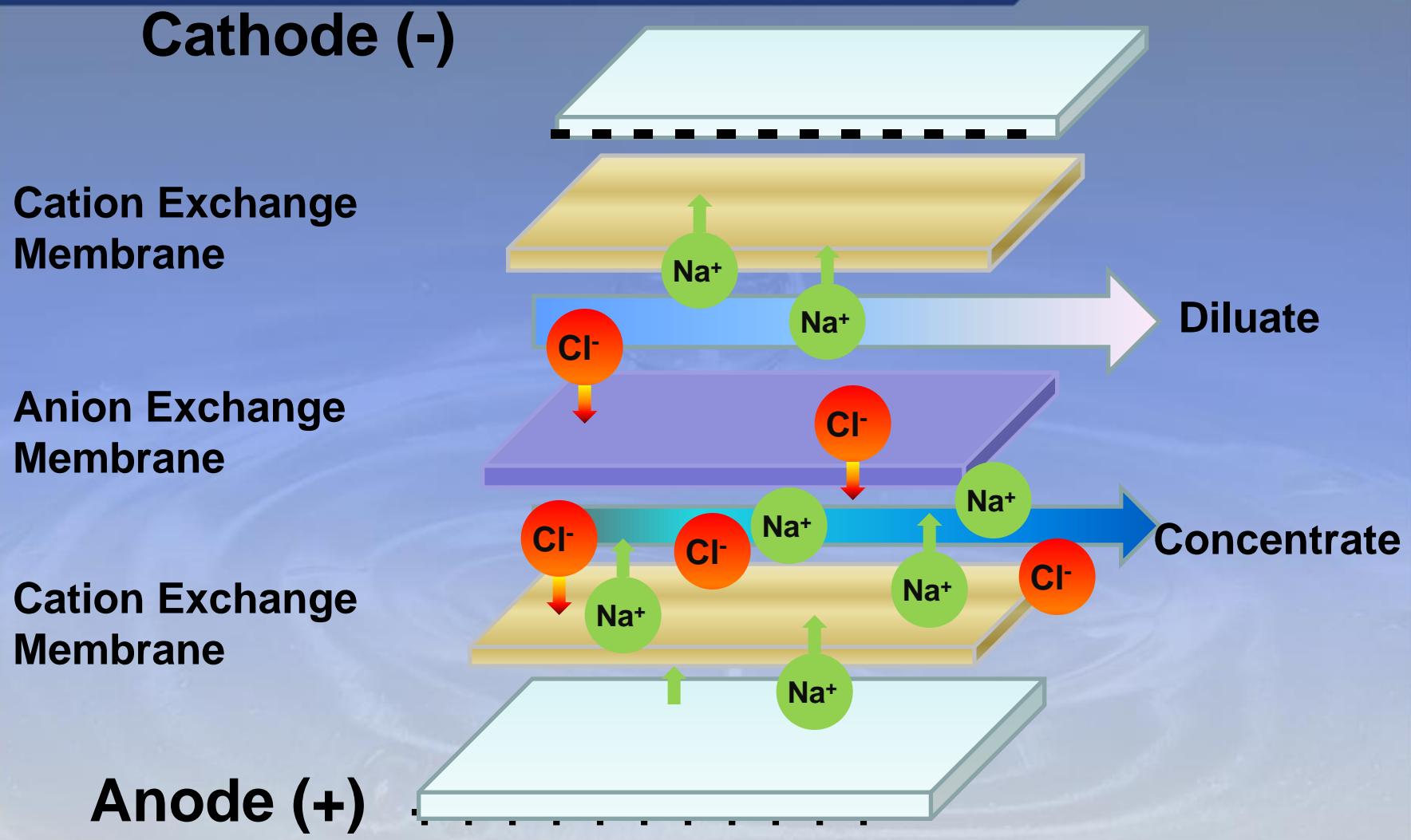

Electrodialysis (ED) and Electrodialysis Reversal (EDR)

- ▶ Mature and robust technology for brackish water desalination
- ▶ Have been tested for produced water treatment at laboratory-scale
- ▶ Relatively lower fouling propensity and higher recovery as compared to RO systems

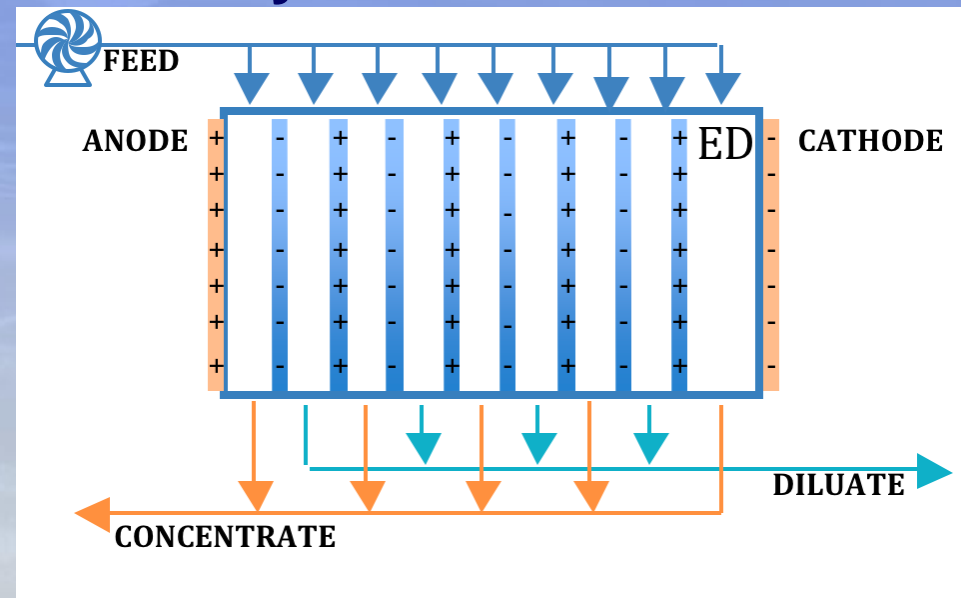

Electrodeionization (EDI)

Field test EDI vs. Ion-Exchange Col. (IEC)

- Decreased chemical usage, waste stream volume
- Smaller footprint (~50 % for same resin capacity)
- Reduced operating/capital costs
- Used standard ED cell stack components

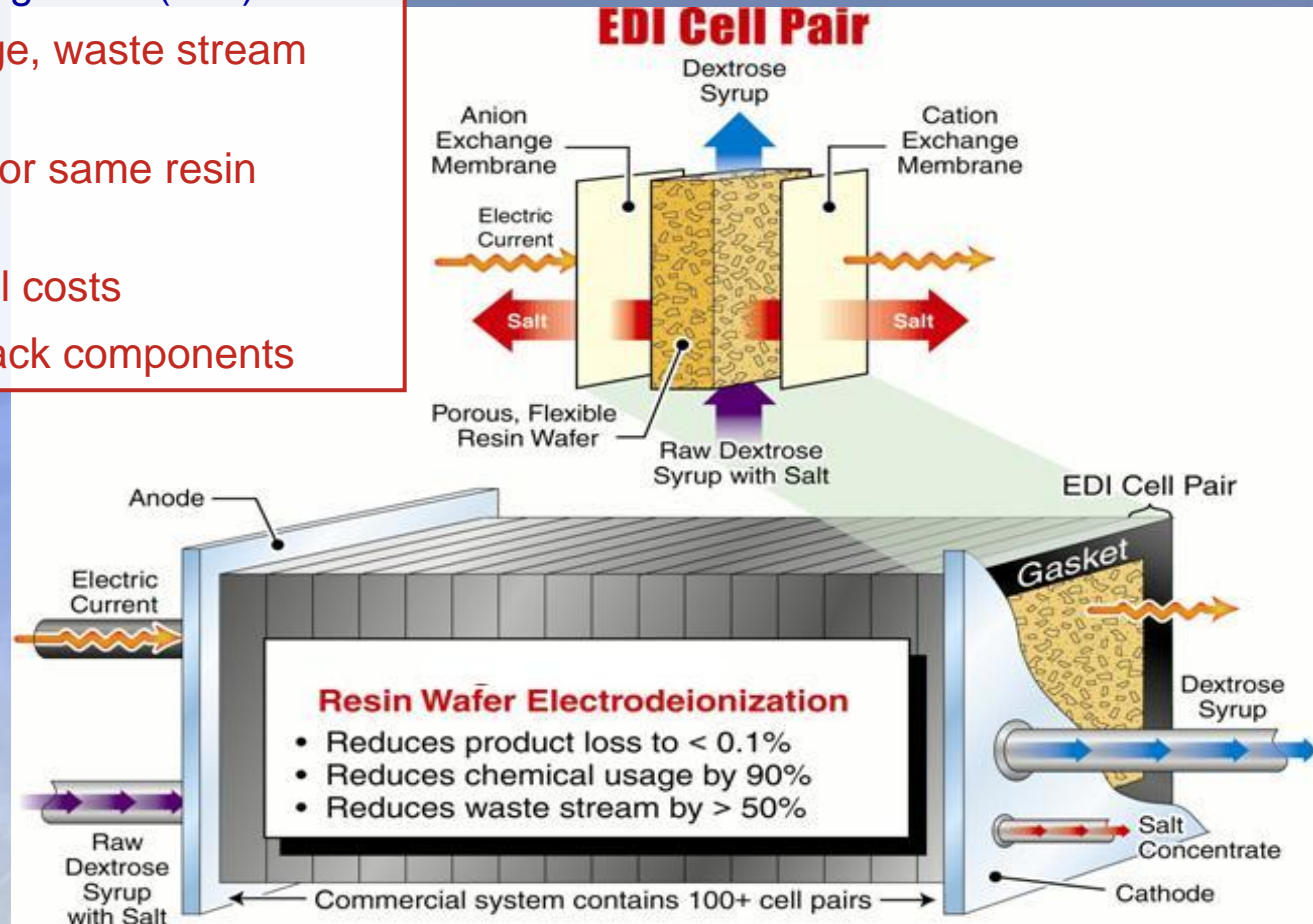



Capacitive Deionization

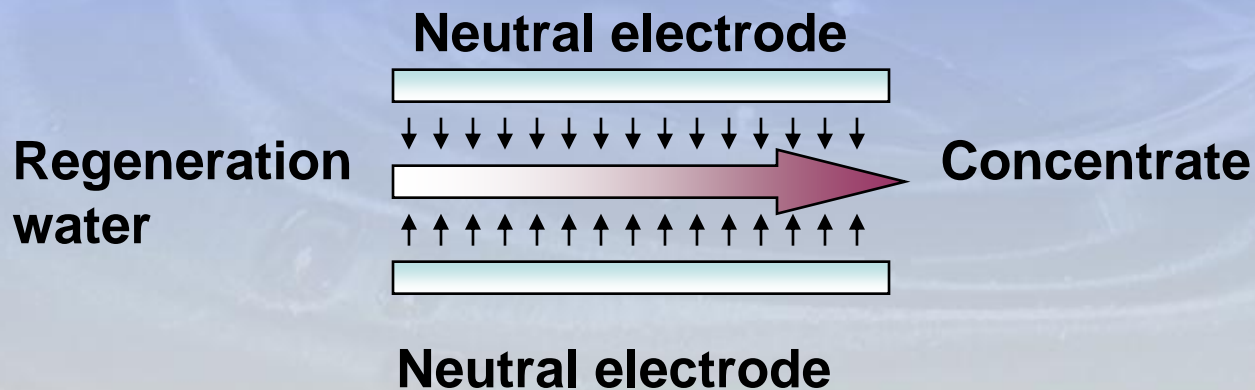
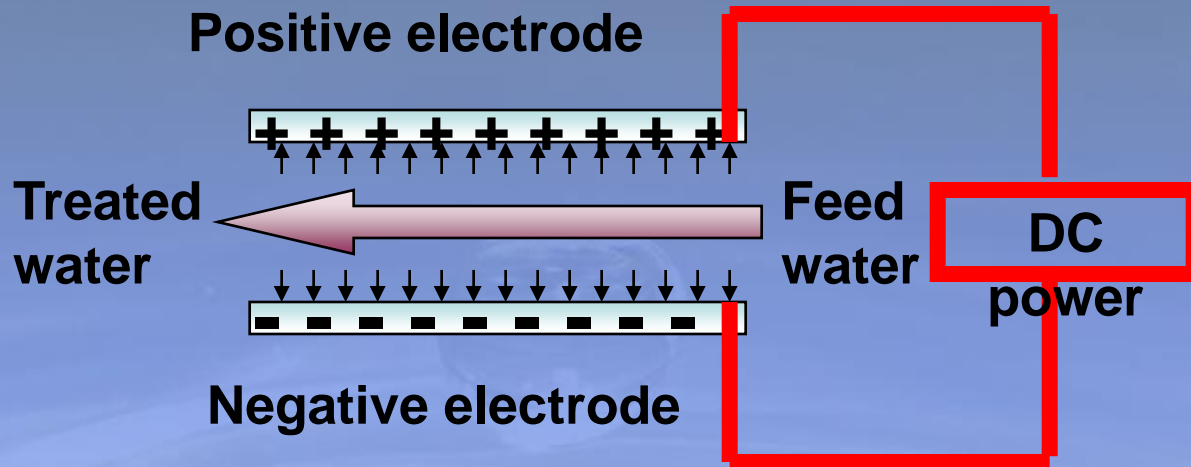



Capacitive Deionization

- ▶ **Low fouling/scaling potential**
- ▶ **Minimum pretreatment**
- ▶ **As a novel and emerging desalination technology, the system design and operation need further optimization:**
 - Low adsorption capacity of electrode materials
 - Energy loss during regeneration
 - Minimization of carry-over of ions after regeneration
 - Not competitive to treat high TDS water (>1500 mg/L)
 - **Long-term field testing and operation experiences**

Direct Contact Membrane Distillation (DCMD)

Transport of water vapor through microporous, hydrophobic membrane driven by difference in partial-vapor pressure across the membrane

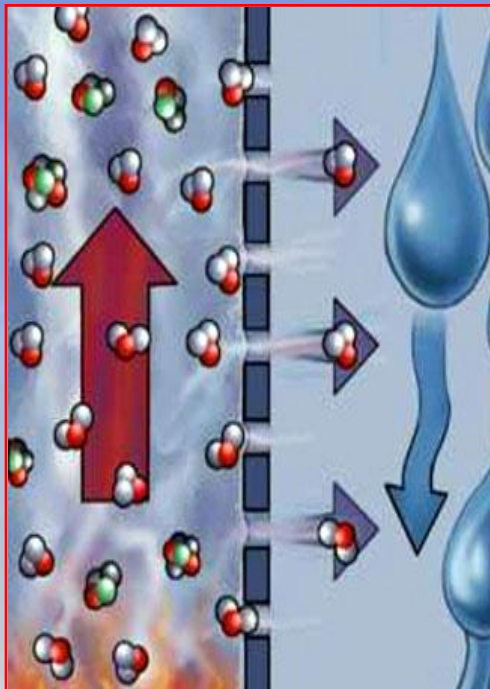

- ▶ Heated feed stream in contact with the active side of the membrane
- ▶ Penetration of aqueous solution into the membrane pores is prevented by the hydrophobic nature of the membrane
- ▶ Cold, fresh water stream in contact with the support side induces partial-vapor pressure gradient
- ▶ Direct condensation of vapor upon contact with the cold stream



DCMD of Extreme Brines

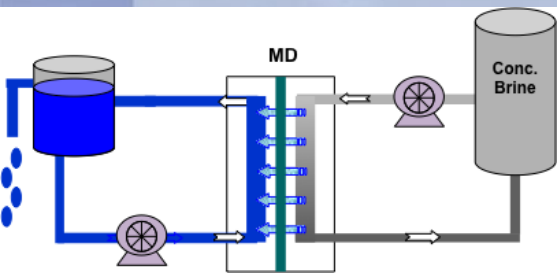
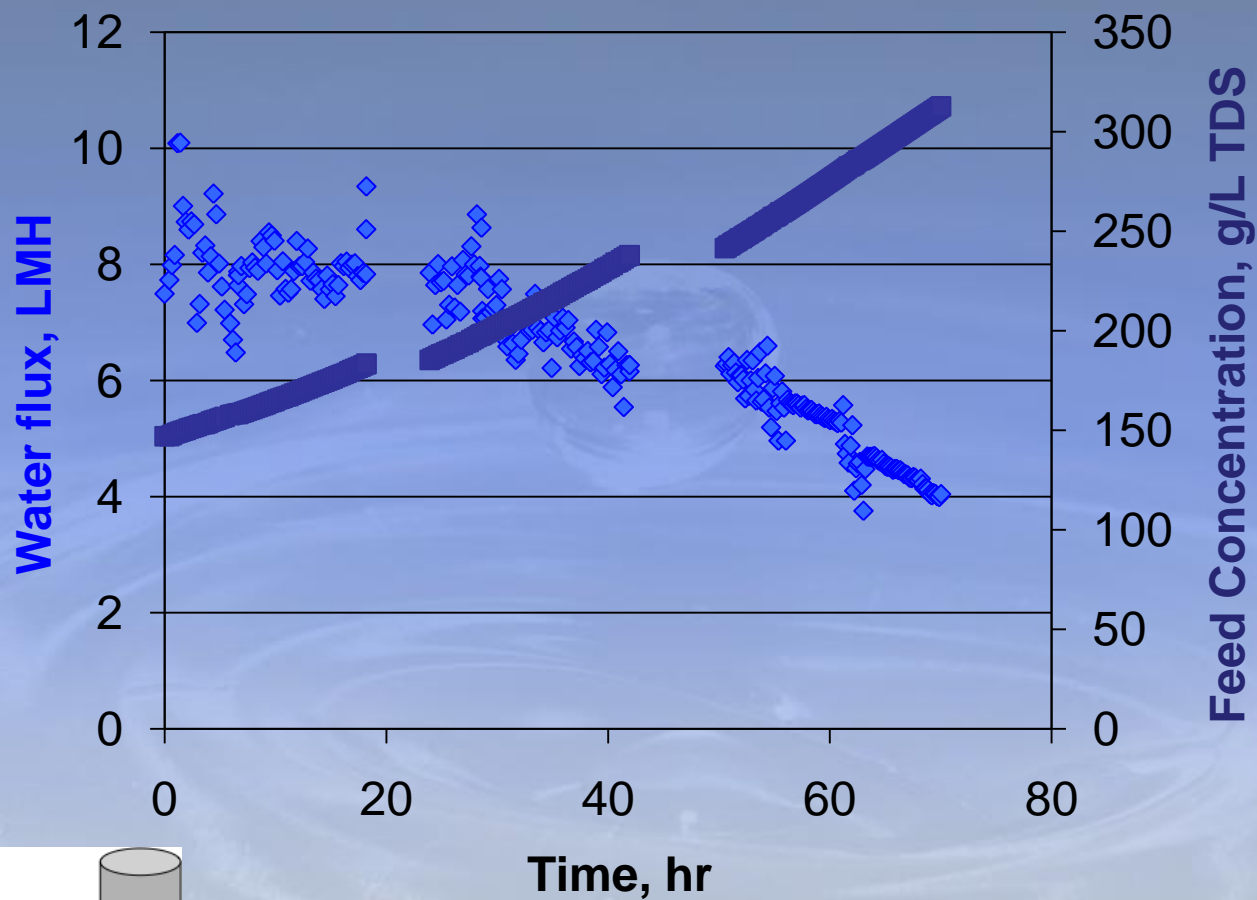

Feed temperature: 40 °C
Distillate temperature: 20 °C

Osmotically-driven Membrane Processes

- ▶ Forward osmosis (wastewater treatment, pretreatment, desalination)

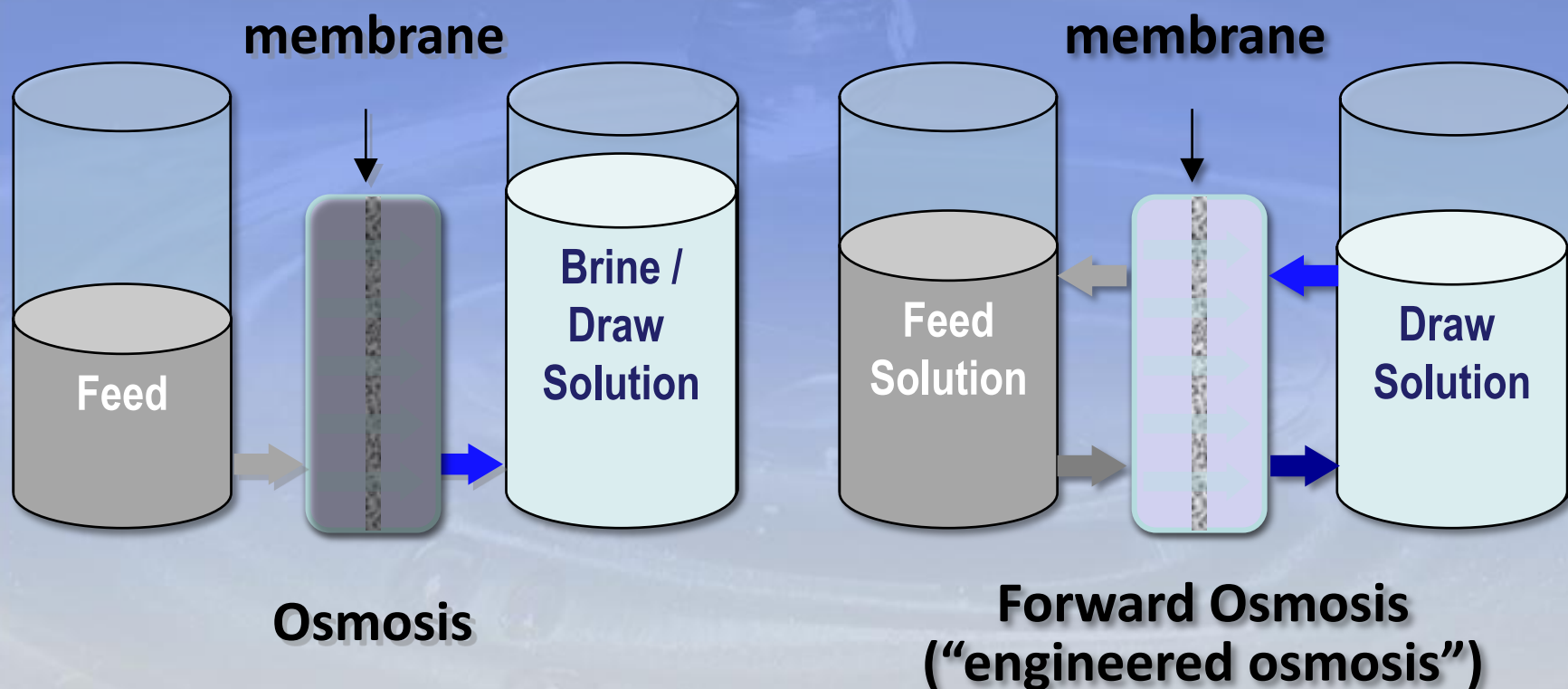

Forward Osmosis for Produced Water

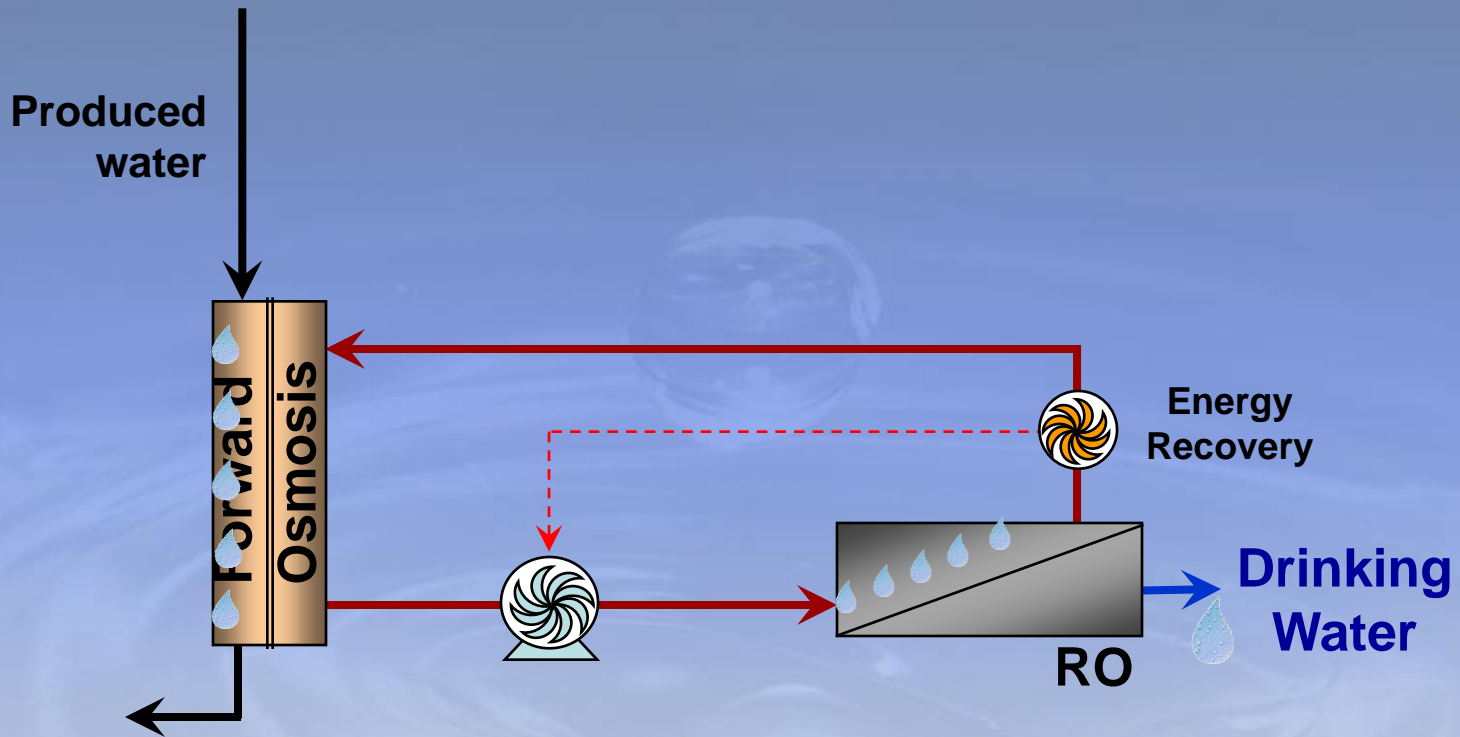

Forward Osmosis of Shale Gas Drilling Mud and Return Flow

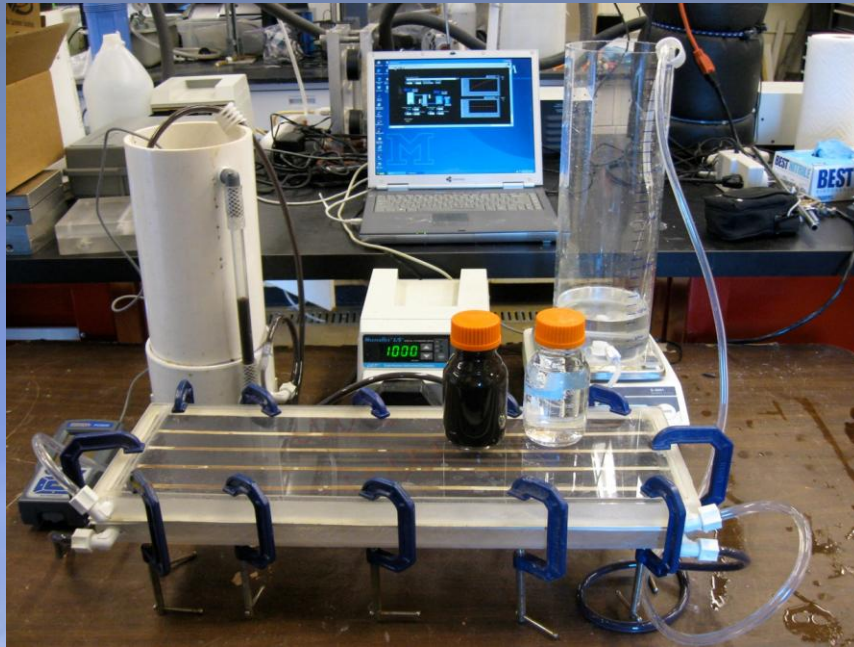



Forward Osmosis of Shale Gas Drilling Mud and Return Flow

▶ Pros

- High rejection of all contaminants
- Reversible membrane fouling
- Can achieve high water flux
- High salinity produced water can be used as draw solution

▶ Cons

- Draw solution needs reconcentration
- Periodic membrane cleaning



Summary

- ▶ **Many novel and improved processes are emerging**
- ▶ **Site specific conditions will dictate the type of technologies most suitable for implementation**
- ▶ **Both lab and field-scale testing need to be conducted to investigate the feasibility of the novel and emerging technologies for shale gas flowback and produced water treatment**

Novel and Emerging Technologies for Produced Water Treatment

Pei Xu, Tzahi Cath and Jörg E. Drewes

AQWATEC, Environmental Science and Engineering Division, Colorado School of Mines

The statements made during the workshop do not represent the views or opinions of EPA. The claims made by participants have not been verified or endorsed by EPA.

Introduction

Development of unconventional gas resources, including coalbed methane (CBM), shale gas, and tight sand is currently one of the most rapidly growing trends in domestic oil and gas exploration and production. The U.S. Energy Information Administration (EIA) projects that shale gas and CBM will make up 34% of total U.S. production in 2035, doubling their 17% share in 2008 [1]. Shale gas is the largest contributor to the growth natural gas production, while production from CBM deposits remains relatively stable from 2008 to 2035.

The rapid rise in production from shale formations is in large part attributed to the advances in horizontal drilling and hydraulic fracturing techniques. Hydraulic fracturing is the most significant technique that has enhanced the commercial shale gas production. Shale formation commonly has low permeability; therefore the wells need to be stimulated by hydraulic fracturing techniques. Hydraulic fracturing involves pumping fluids and proppant (i.e., grains of sand or other material used to hold the cracks open) down the wellbore under high pressure so that the gas can flow to the wellbore. A general estimate of water requirement for multi-stage fracture treatment of a horizontal well varies between 2.3 and 6 million gallons of water [2-4]. Development of shale gas resources also requires significant quantities of water for drilling and plant operations. Additionally, the majority of the frac water, from lower than 15% to as much as nearly 80%, returns to the surface [2, 5]. The flowback water typically contains sand, chemical additives, hydrocarbons, salts, and occasionally low level of naturally occurring radioactive materials (NORM) that are found in many geological formations. In addition to frac flowback water, large volumes of produced water are generated in the early stages of gas production to reduce pressure in the formation before the gas can be produced. Produced water is typically salty and often requires treatment prior to discharge.

Water usage, water quality, and disposal are the pressing issues that may potentially inhibit the projected growth in unconventional gas production, in particular considering new environmental legislation and public perception [6]. Operators must manage flowback and produced waters in a cost-effective manner that complies with regulatory requirements. This requires the treatment processes to be robust, mobile and modular, sustainable, inexpensive, and to have low energy demand. Furthermore, technologies should be versatile and flexible and can be used to treat water with variable quantity and quality containing different contaminants and having different characteristics.

Various treatment technologies have been used or under development to address water supply and disposal issues during oil and gas development. Funded by the DOE/RPSEA program, we conducted a literature review and technical assessment to evaluate existing and emerging technologies that have been used for treatment of produced water and novel technologies that could be tested and considered in the future. The evaluation criteria for technical assessment include commercial status of technology and applications; applicable feed and expected product water quality; removal efficiencies of key constituents; infrastructure considerations (modularity, mobility, etc); energy use and consumption; chemical demand; life cycle and costs; operation and maintenance considerations (ease of operation, reliability, etc); pre- and post-treatment; and waste disposal. Laboratory and field testing were conducted to explore the most appropriate and cost-efficient technologies for treatment of CBM produced waters that will allow beneficial use of the treated water. A modeling framework was developed to evaluate the technical aspects, institutional complexity, and economic viability of multiple beneficial use and discharge options. The decision making framework is comprised of four modules: 1) Water Quality Module (WQM); 2) Treatment Selection Module (TSM); 3) Beneficial Use Screening Module (BSM); and 4) Beneficial Use Economic Module (BEM). The detailed description of this RPSEA project and the downloadable tools and technology factsheets can be found at the website “Produced Water Treatment and Beneficial Use Information Center” (http://aqwatec.mines.edu/produced_water/index.htm).

This paper will summarize briefly the technical assessment and testing results of novel and emerging technologies for produced water treatment.

Electrochemical Charge Driven Separation Processes

Electrochemical charge driven separation processes separate dissolved ions from water through ion permeable membranes or conductive adsorbers under the influence of an electrical potential gradient. These processes include electrodialysis (ED), electrodialysis reversal (EDR), electrodeionization (EDI), and capacitive deionization (CDI). An ED stack consists of a series of anion exchange membranes (AEM) and cation exchange membranes (CEM) arranged in an alternating mode between anode and cathode. The positively charged cations migrate toward the cathode, pass the cation exchange membrane, and are rejected by the anion-exchange membrane. The opposite occurs when the negatively charged anions migrate to the anode. This results in an alternating increasing ion concentration in one compartment (concentrate) and decreasing concentration in the other (diluate). The EDR process is similar to the ED process, except that it also uses periodic reversal of polarity to effectively reduce and minimize membrane scaling and fouling, thus allowing the system to operate at relatively higher water recoveries.

Electrodeionization (EDI) is a commercial desalination technology that combines ED and conventional ion exchange (IX) technologies. A mixed-bed ion exchange resin or fiber is placed into the diluate cell of a conventional electrodialysis cell unit to increase the conductivity in the substantially non-conductive water. The IX resins are regenerated via water splitting under current. The process can be performed continuously without chemical regeneration of the IX resin, and reduce the energy consumption when treating low salt solutions.

Capacitive deionization (CDI) is an emerging desalination technology. In CDI, ions are adsorbed onto the surface of porous electrodes (e.g., activated carbon, carbon aerogel, carbon fibers, etc) by applying a low voltage electric field, producing deionized water.

Electrochemical charge driven separation processes are typically used in desalination of brackish water (up to about 8,000 mg/L TDS for EDR) and not highly saline water. This is because the cost of these processes and energy consumption increase substantially with increasing salinity or TDS concentration. ED and EDR have been successfully used at a number of municipal water and wastewater treatment plants to desalinate brackish water and reclaimed water. Laboratory experiments and pilot scale testing have been conducted to investigate the feasibility of these technologies to treat produced water. Although these processes are less prone to fouling as compared to reverse osmosis (RO) and nanofiltration (NF) membranes, the efficiency of ED, EDR and EDI is degraded by fouling/scaling. Sparingly soluble inorganic salts (e.g., CaSO_4 , CaCO_3) and multivalent ions (e.g., iron and manganese) can still scale the IX membranes by precipitation and fixation. This can be controlled by pretreatment of the feedwater with processes such as filtration for suspended solids, softening or pH lowering, and addition of antiscalant into the concentrate compartments. A disadvantage of these processes is the limited removal of non-charged constituents, including organics molecules, silica, boron, and microorganisms.

Ceramic MF/UF membrane

Ceramic ultrafiltration and microfiltration membranes are made from oxides, nitrides, or carbides of metals such as aluminum, titanium, or zirconium. Ceramic membranes are much more resilient than polymeric membranes and are mechanically strong, chemically and thermally stable, and can achieve high flux rates. Typically, a tubular configuration is used with an inside-out flow path, where the feed water flows inside the membrane channels and permeates through the support structure to the outside of the module.

Ceramic membranes are capable of removing particulates, organic matter, oil and grease, and metal oxides. Ceramic MF/UF membranes alone cannot remove dissolved ions and dissolved organics. Pre-coagulation, injection of a chemical coagulant upstream from the membrane, improves removal efficiencies of dissolved organic carbon and smaller particulates. As with conventional ultrafiltration and microfiltration, a strainer or cartridge filter is necessary as pretreatment for ceramic membranes. Numerous research studies have been conducted on using ceramic membranes to treat oil-containing wastewater and produced water [7-8]. These research studies have shown that ceramic membranes perform better than polymeric membranes on oil-containing waters. Ceramic membranes have also been employed commercially as part of a large treatment train consisting of multiple unit process at the Wellington Water Works to treat oilfield produced water [9].

Energy requirements for ceramic membranes are lower than those required for polymeric membranes. Ceramic membranes have a higher capital cost than polymeric membranes. The

application of ceramic membranes for produced water treatment may increase as more research and pilot studies are conducted.

Membrane Distillation

Membrane distillation (MD) is a novel thermally driven membrane separation process that utilizes a low-grade heat source to facilitate mass transport through a hydrophobic, microporous membrane [10-11]. The driving force for mass transfer is a vapor pressure gradient between a feed solution and the distillate, and is the only membrane process that can maintain process performance (i.e., water flux and solute rejection) almost independently of feed solution TDS concentration. MD is most likely capable of producing ultra-pure water at a lower cost compared to conventional distillation processes; however, compounds with higher volatility than water, such as BTEX and other organic compounds, will diffuse preferentially faster through the membrane. Membrane materials commonly employed for MD include polytetrafluorethylene (PTFE), polypropylene (PP), and polyvinylidene difluoride (PVDF). MD membranes may be packaged in either flat-sheet or hollow-fiber configurations. For pretreatment, MD processes require a pre-filter to screen out large particles and the complete removal of any surfactants present in the feed stream. If surfactants are present in the MD feed stream they will wet the hydrophobic pores of the MD membrane and cause pore flooding, which results in a substantial reduction in membrane solute rejection.

MD is flexible for most variations in feed water quality and quantity. It may become a potential technology for produced water treatment with the improvement in MD membranes and system design.

Osmotically Driven Membrane Processes

Forward osmosis (FO) is an osmotically driven membrane process. During FO, water diffuses spontaneously from a stream of low osmotic pressure (the feed solution) to a hypertonic (draw) solution having a very high osmotic pressure. Unlike RO and NF, FO systems operate without the need for applying hydraulic pressure. The membranes used for this process are dense, non-porous barriers similar to RO and NF membranes, but are composed of a hydrophilic, *cellulose acetate* active layer cast onto either a woven polyester mesh or a micro-porous support structure.

Typically, the FO draw solution is composed of NaCl, but other draw solutions composed of NH_4HCO_3 , sucrose, and MgCl_2 have been proposed. During FO the feed solution is concentrated while the draw solution becomes more dilute. FO requires the continuous reconcentration of the draw solution for sustainable system operation. One option is the use of RO for reconcentrating the draw solution and producing fresh product water for beneficial use or discharge.

FO membranes are capable of operating with feed TDS ranging from 500 mg/L to more than 35,000 mg/L, and rejecting all particulate matter and almost all dissolved constituents (greater than 95% rejection of TDS). These attributes also allow FO to achieve very high theoretical

recoveries while minimizing energy and chemical demands. An additional benefit of FO is that the process occurs spontaneously, without the need of applied hydraulic pressure. Therefore fouling layers that accumulate on FO membranes may be readily removed with cleaning (e.g., increasing cross-flow velocity, osmotic backwashing) or with chemicals, and irreversible flux decline is minimized [12]. FO membranes may be packaged in flat sheet or spiral-wound configurations. These packages allow for relatively small process footprints, but are still not optimized to the extent of pressure driven processes.

The testing results of FO process for produced water treatment at laboratory and field are promising. With the development of more suitable draw solution and appropriate semi-permeable membrane, FO process can become a potentially industrial technology to address the challenges of shale gas flowback and produced water treatment.

References

- [1] U.S. Energy Information Administration, Annual Energy Outlook 2010 with Projections to 2035. Report #:DOE/EIA-0383(2010). Release Date: May 11, 2010. Available at: <<http://www.eia.doe.gov/oiaf/aeo/gas.html>>. [cited October 16, 2010].
- [2] GWPC and ALL, Modern Shale Gas Development in the United States: A Primer. Prepared for the U.S. Department of Energy, Office of Fossil Energy, National Energy Technology Laboratory (NETL). Prepared by the Ground Water Protection Council and ALL Consulting. April 2009. Available at: <<http://www.oilandgasinvestor.com/Files/DOEShaleGasPrimer.4.14.09.pdf>>.
- [3] Railroad Commission of Texas web site: June 4, 2007. "Water Use in the Barnett Shale." Available at: <http://www.rrc.state.tx.us/divisions/og/wateruse_barnettshale.html>. [Cited October 16, 2010],
- [4] D.B. Burnett and C.J. Vavra, Desalination of Oil Field Brine - Texas A&M Produced Water Treatment. Available at: <<http://www.pe.tamu.edu/gpri-new/home/BrineDesal/MembraneWkshpAug06/Burnett8-06.pdf>>. [Cited October 16, 2010].
- [5] J. Veil, Water Management Technologies Used by Marcellus Shale Gas Producers. Prepared for: United States Department of Energy National Energy Technology Laboratory. Final Report July 2010.
- [6] PADEP, Notice of Final Rulemaking Department of Environmental Protection Environmental Quality Board [25 PA. CODE CH. 95]. Wastewater Treatment Requirements. Available at: <<http://files.dep.state.pa.us/PublicParticipation/Advisory%20Committees/AdvCommPortalFiles/WRAC/Preamble%20TDS%20Final%20Rulemaking%20to%20WRAC.pdf>>. [cited October 16, 2010].
- [7] R.S. Faibish, and Y. Cohen, Fouling and rejection behavior of ceramic and polymer-modified ceramic membranes for ultrafiltration of oil-in-water emulsions and microemulsions, Colloids and Surfaces A: Physicochemical and Engineering Aspects 191 (2001) 27-40.
- [8] G. Gutierrez, A. Lobo, D. Allende, A. Cambiella, C. Pazos, J. Coca, and J.M. Benito, Influence of Coagulant Salt Addition on the Treatment of Oil-in-Water Emulsions by Centrifugation, Ultrafiltration, and Vacuum Evaporation, Separation Science and Technology 43 (2008) 1884 - 1895.
- [9] D.R. Stewart, Developing a new water resource from production water. Available at: http://www.crwcd.org/media/uploads/Dave_Steward.pdf. [cited October 1, 2010]

[10] T.Y. Cath, V.D. Adams, and A.E. Childress, Experimental study of desalination using direct contact membrane distillation: A new approach to flux enhancement, *Journal of Membrane Science* 228 (2004) 5-16.

[11] K.K. Sirkar, and B. Li, Novel membrane and device for direct contact membrane distillation-based desalination process: phase II, 2003, Bureau of Reclamation, Denver, Colorado.

[12] T.Y. Cath, A.E. Childress, and M. Elimelech, Forward osmosis: principles, applications, and recent developments, *Journal of Membrane Science* 281 (2006) 70-87.