

ThermoFisher
S C I E N T I F I C

Expanded Analysis of Human Hormones in Drinking Water Using Solid-Phase Extraction and Liquid Chromatography Tandem Mass Spectrometry

Carl Fisher, Claudia Martins, Ed George, and Pranathi Perati
Thermo Fisher Scientific

The world leader in serving science

Pharmaceutical Residues in Water Supplies

- In 2008, the U.S. Geological Survey (USGS) tested tap water in nine states across the country and found 85 man-made chemicals, including some medications.
- Other research has reported traces of various pharmaceuticals in drinking water supplies, including:
 - Antibiotics
 - Anticonvulsants
 - Mood stabilizers
 - **Synthetic hormones (oral contraceptives)**



How Do Hormones Get into Drinking Water?

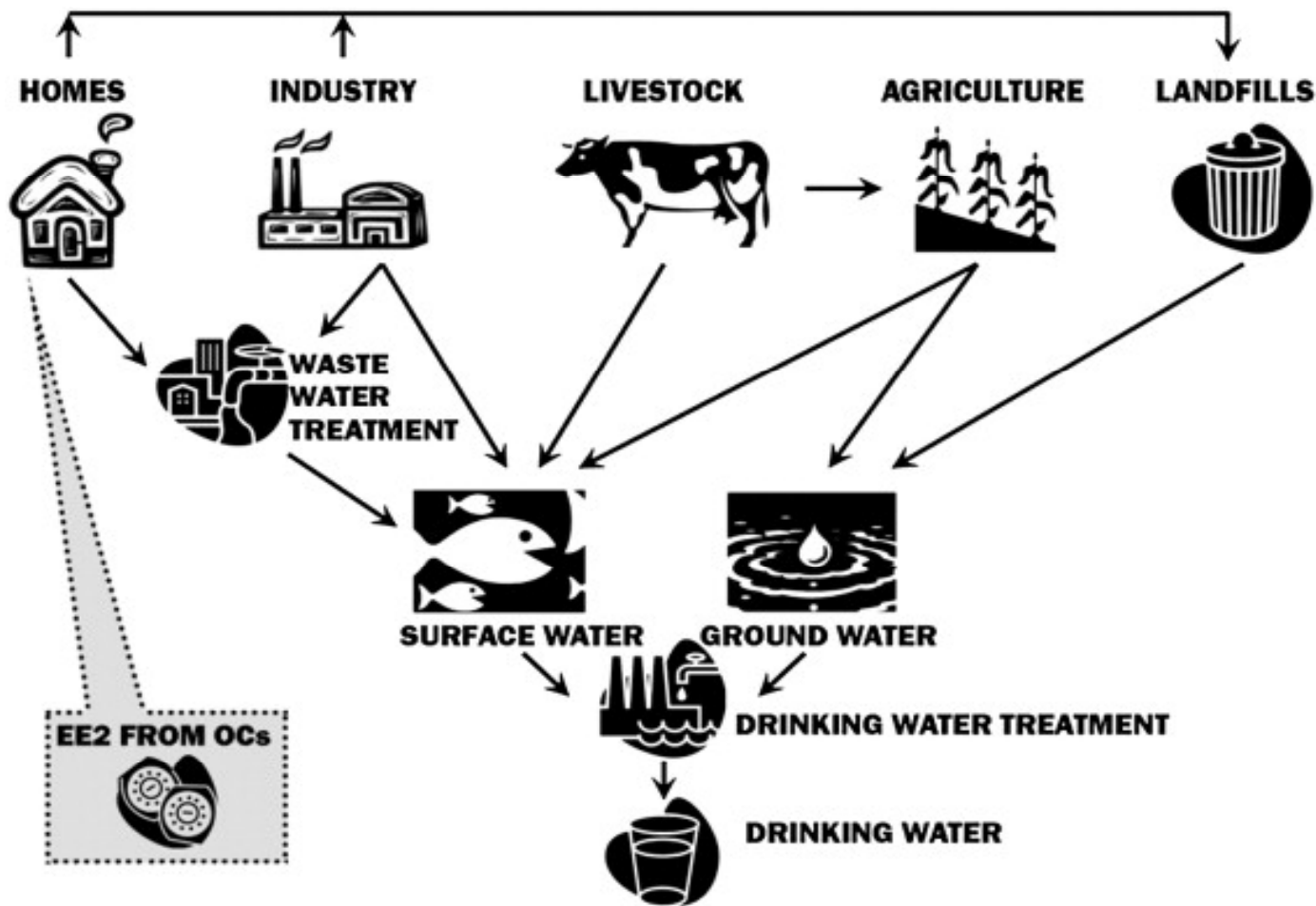

Wise A, O'Brien K, Woodruff T.; *Environ Sci Tech.* 2011;1:51-60

Health Risks of Hormones in Water Supplies

- Hormones in water supplies are typically at very low concentrations (ppb or ppt levels)
- Even extremely diluted concentrations of hormone residues can harm aquatic life
- Long-term consequences
 - Cancer: a number of types of cancers are hormone-responsive
 - Male infertility:
 - Links have been established between reduced sperm count in fish and estrogen in water
 - Studies in humans are ongoing
 - Obesity: weight gain has been linked to rising estrogen levels
- “Stew Effect”
 - Potential interactions between trace amounts of chemicals in water

U.S. EPA Method 539

- Determination of Hormones in Drinking Water by Solid-Phase Extraction (SPE) and Liquid Chromatography Electrospray Ionization Tandem Mass Spectrometry (LC-ESI-MS/MS)
- On April 16, 2012, the U.S. EPA signed the third Unregulated Contaminant Monitoring Rule (UCMR 3)
 - Requires monitoring for 30 contaminants using U.S. EPA and/or consensus organization analytical methods during 2013–2015.
 - U.S. EPA Method 539 is included in UCMR 3:

Screening Survey	
7 Hormones using EPA Method 539 (LC/MS/MS):	
17- β -estradiol	estrone.
17- α -ethynylestradiol (ethinyl estradiol)	testosterone.
estriol (16- α -hydroxy-17- β -estradiol)	4-androstene-3,17-dione.
equilin.	



Hormones Monitored: U.S. EPA Method 539

Estrogens

Estriol

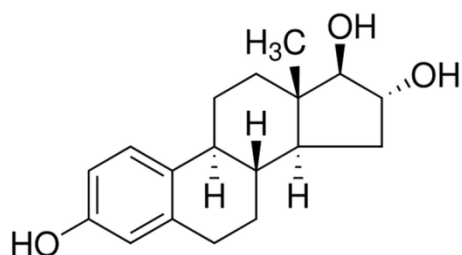

Estrone

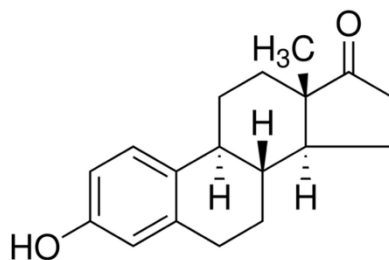

17-β-Estradiol

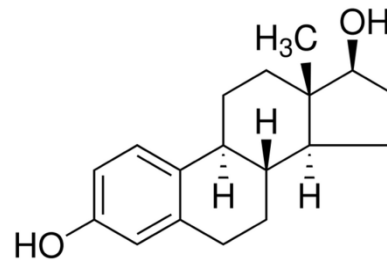

17-α-Ethynylestradiol

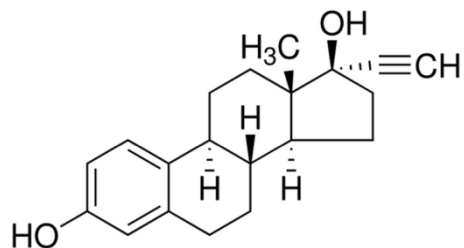

Equilin

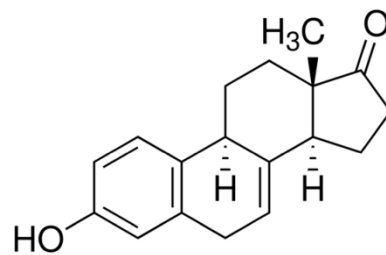

Androgens

Testosterone

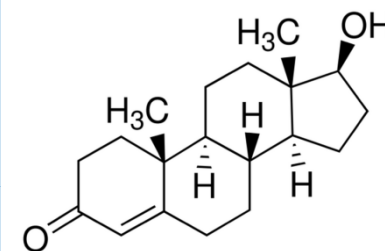

Androstenedione

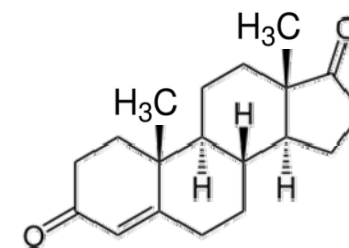

U.S. EPA Method 539.1: Additional Hormones

Estrogens

Equilenin

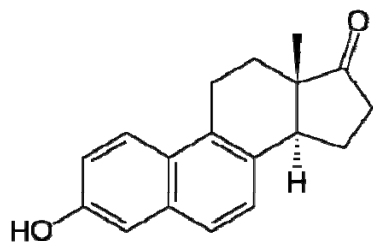

17- α -estradiol

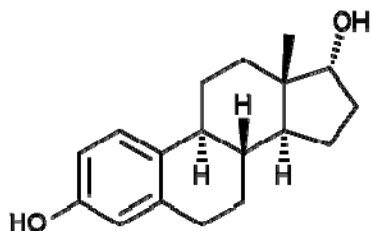

Progestagens

Norethindrone

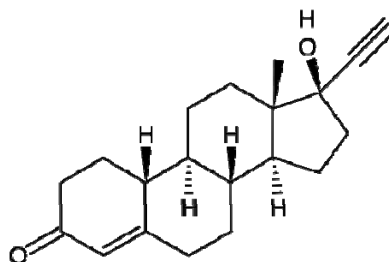

Progesterone

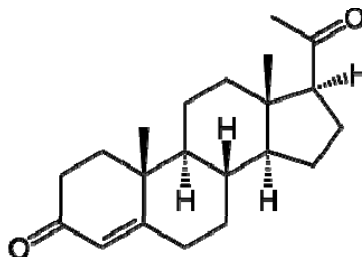

Bisphenol A

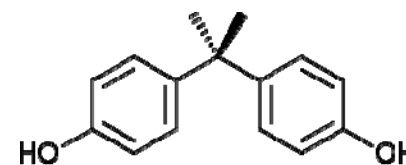

- Use of cartridges specified

Hormone Analysis: Instrumentation

- SPE

- Thermo Scientific™ Dionex™ AutoTrace™ 280 Solid-Phase Extraction Instrument
- Thermo Scientific™ Dionex™ SolEx™ SPE HRPHS Cartridges

- LC-MS/MS

- Thermo Scientific™ Dionex™ UltiMate™ 3000 LC system and Thermo Scientific™ TSQ Endura™ Triple Quadrupole Mass Spectrometer



Dionex AutoTrace 280 Solid-Phase Extraction

- Automated SPE of large-volume aqueous or water samples
 - 20 mL to 4 L sample volume
 - Drinking water and ground water
 - Positive pressure
- Sample prep for organic analytes
 - Priority organic pollutants, personal care products, and endocrine disruptors
- Automated SPE
 - Automate all SPE steps: condition, load, rinse, and elute
 - Use normal or reversed-phase cartridges and disks
 - 1, 3, and 6 mL SPE cartridges



Saves time and solvent; ensures reproducibility and analytical precision

AutoTrace 280 Fluid Schematic

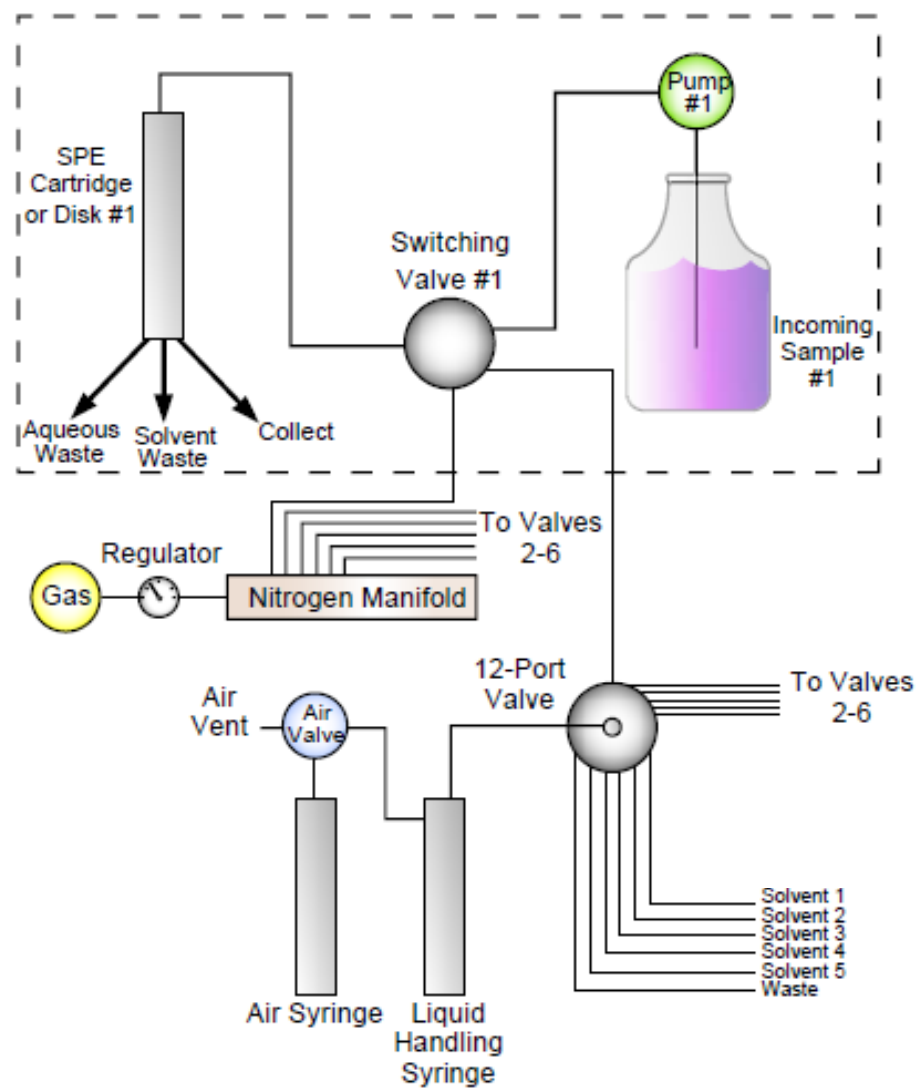

Figure 2-6. AutoTrace 280 Fluid Connections

SPE Cartridges

- Dionex SolEx cartridges
 - Silica-, Carbon-, Polymer-based
 - HRPHS
 - Neutral resin comprised of high-surface area, divinylbenzene-based particle
 - Hydrophilic, reversed-phase properties
 - High recovery of hydrophobic targets
 - 6 mL with 200 mg resin



Sample Concentration: Solid Phase Extraction

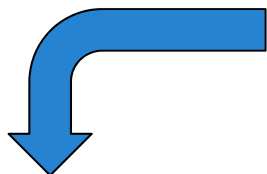

0.5 L
Water

Sodium Omadine (Biocide)
Sodium Chloride (Extraction Salt)
Ethinylestradiol- d_4 (MS Surrogate)
+ Hormones



Condition	MeOH; Water; N ₂
Load	10 mL/min
Rinse	2% Acetic Acid; Water
Dry	N ₂ , 10 min
Elute	2 x 3 mL + 4 mL MeOH

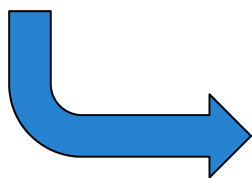

Concentrate
to dryness
(N₂, 40 °C)

+

1 mL
50% MeOH

+

MS
Internal
Standards

HPLC System

- UltiMate 3000 RSLC system



- Degasser
- Dual-gradient Pump
- Thermostatted Autosampler
- Thermostatted Column Compartment
- Diode Array Detector



- Thermo Scientific™ Acclaim™
Rapid Separation LC (RSLC)
Polar Advantage II column
- 2.2 μm particle size, 2.1 \times 150 mm
 - pH 1.5–10

HPLC Conditions

Injection volume	50 μ L
Column temperature	30 $^{\circ}$ C
Mobile phase A	1 mM Ammonium fluoride in water
Mobile phase B	1 mM Ammonium fluoride in methanol
Flow rate	200 μ L/min

Gradient:

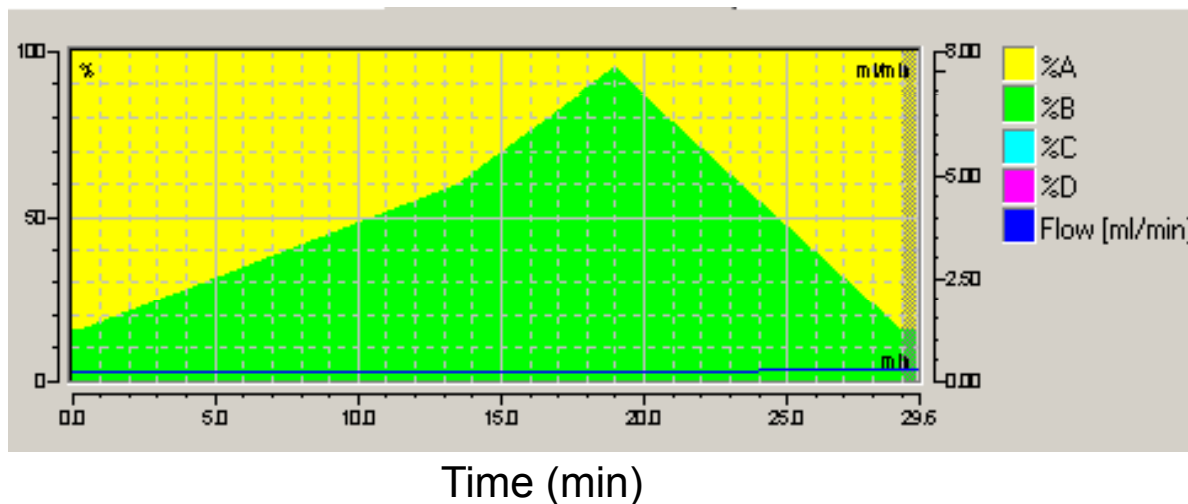

TSQ Endura MS



TSQ Endura MS

Extreme Quantitative Value

- Best-in-class performance
- Unprecedented usability
- Exceptional robustness

AIM TECHNOLOGY

Active Ion Management:

Precision design of all electric fields, optimized in concert, to produce maximum signal and prevent contamination.

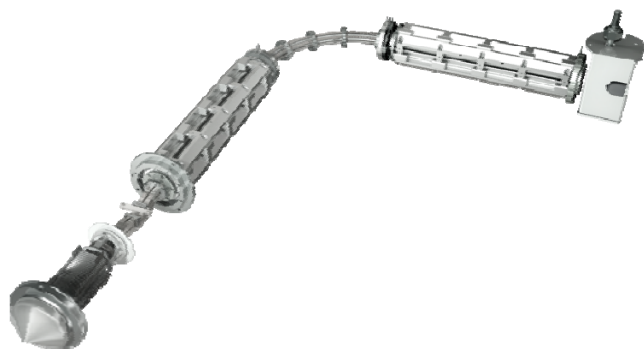

Mass Spectrometry Conditions

Ion source	HESI III
Spray voltage (Polarity Switching)	3000 V (-) 3250 V (+)
Sheath gas pressure	50 arbitrary units
Auxiliary gas pressure	15 arbitrary units
Sweep gas pressure	1 arbitrary units
Ion transfer capillary temperature	300 °C
Vaporizer temperature	350 °C
Scan type	SRM
Q1 and Q3 peak width (FWHM)	0.7 Da
Collision gas and pressure	Argon at 1.5 mTorr

Analyte Chromatograms – Negative Ionization

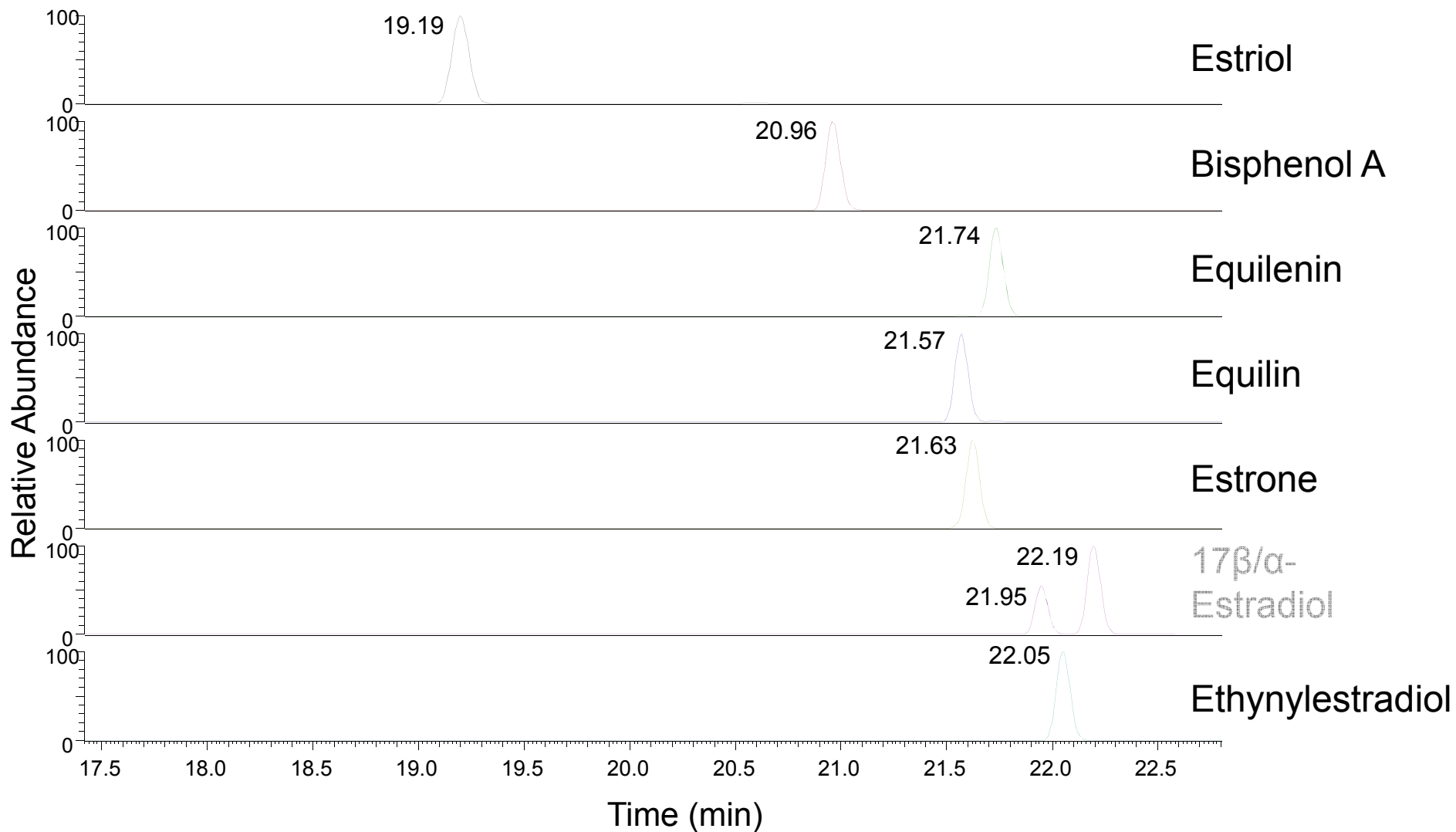

Analyte Chromatograms – Positive Ionization

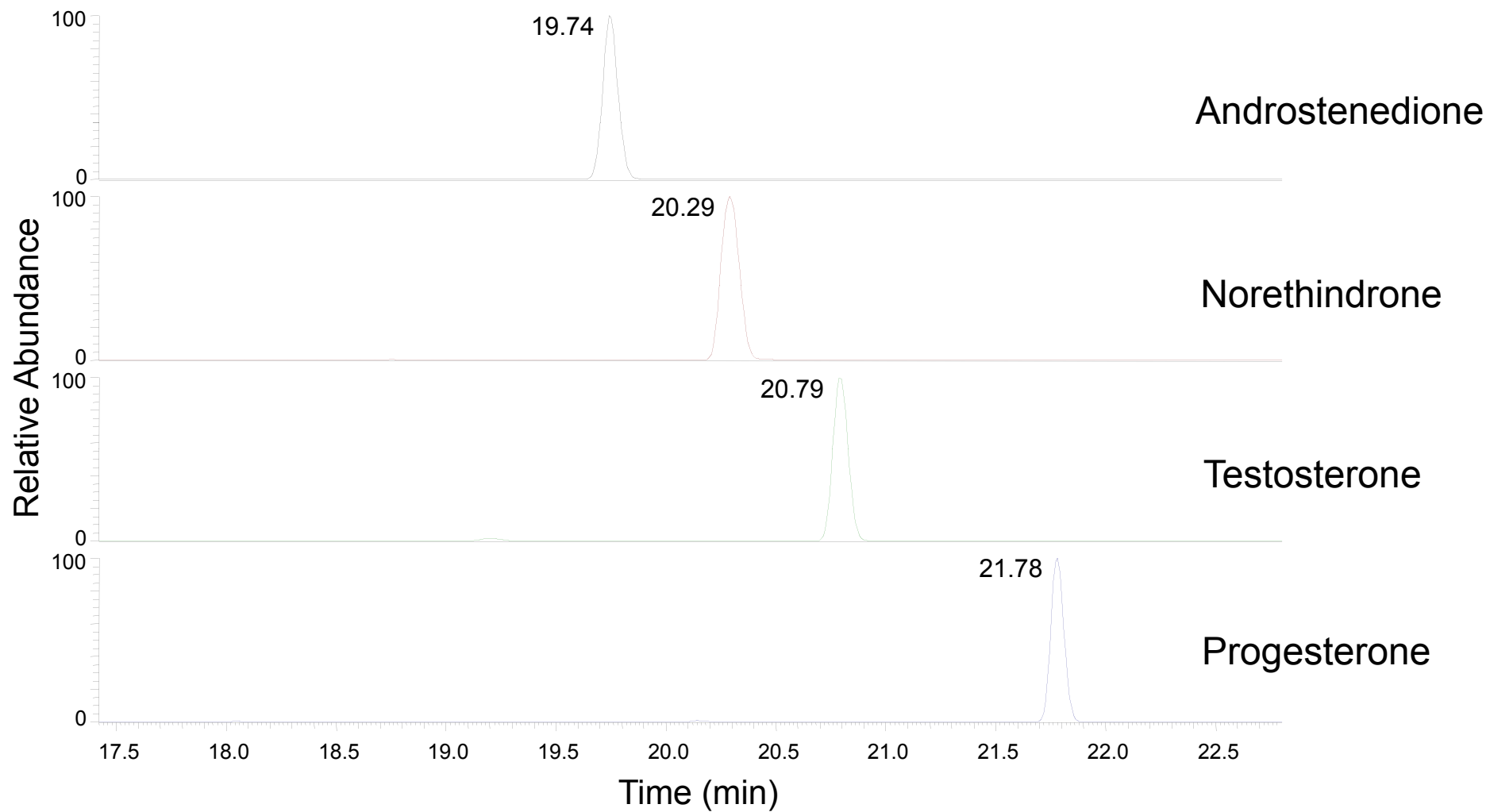

Standard Curve Linearity

- Standard Dilutions
 - Hormones
 - Surrogate
 - Internal Standards

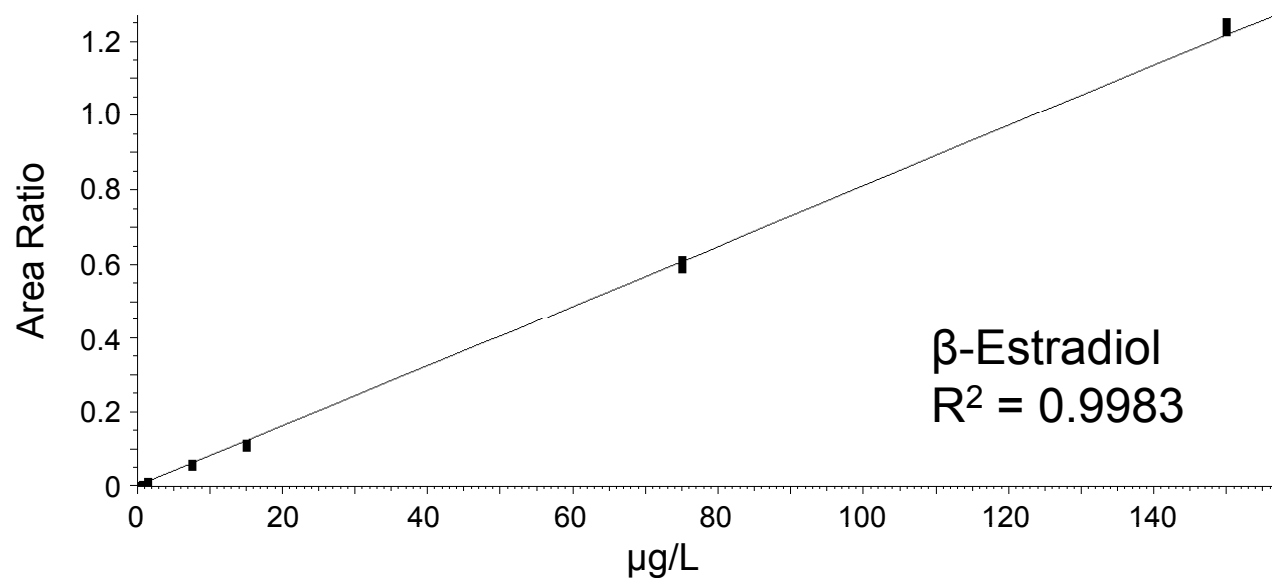
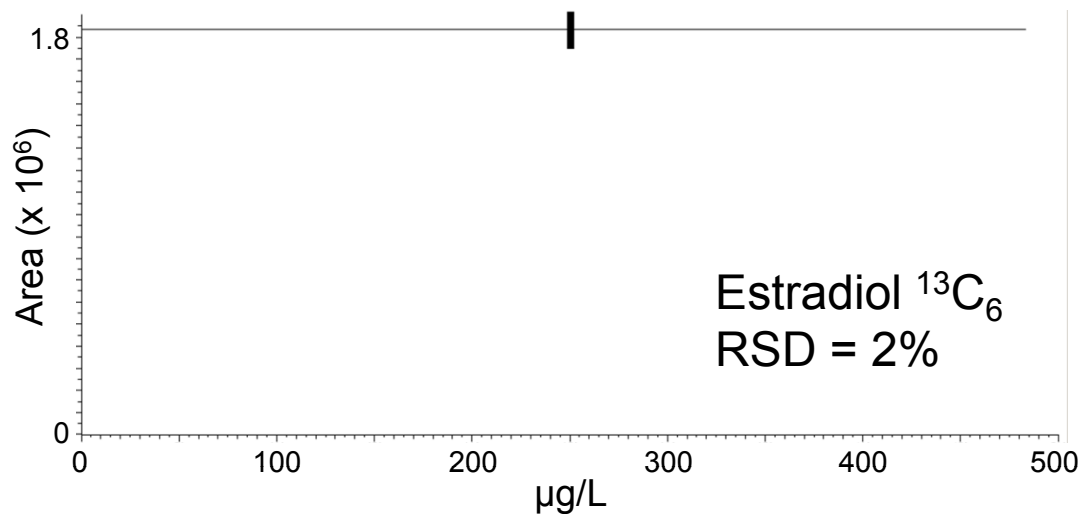

Recovery of Hormones: Fortified Reagent Water

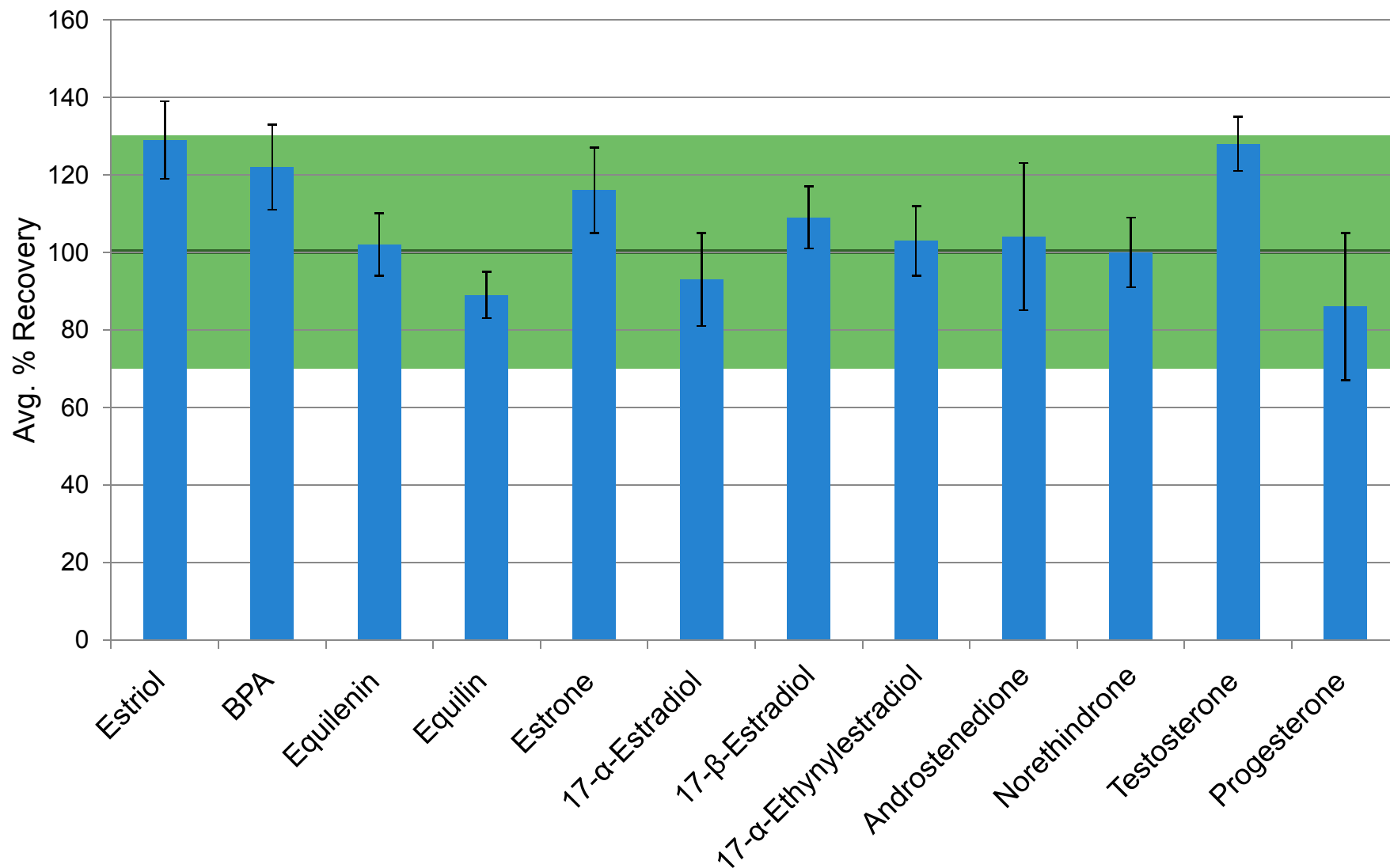

Recovery ranged from 86–129 %

Recovery of Hormones: Fortified Drinking Water

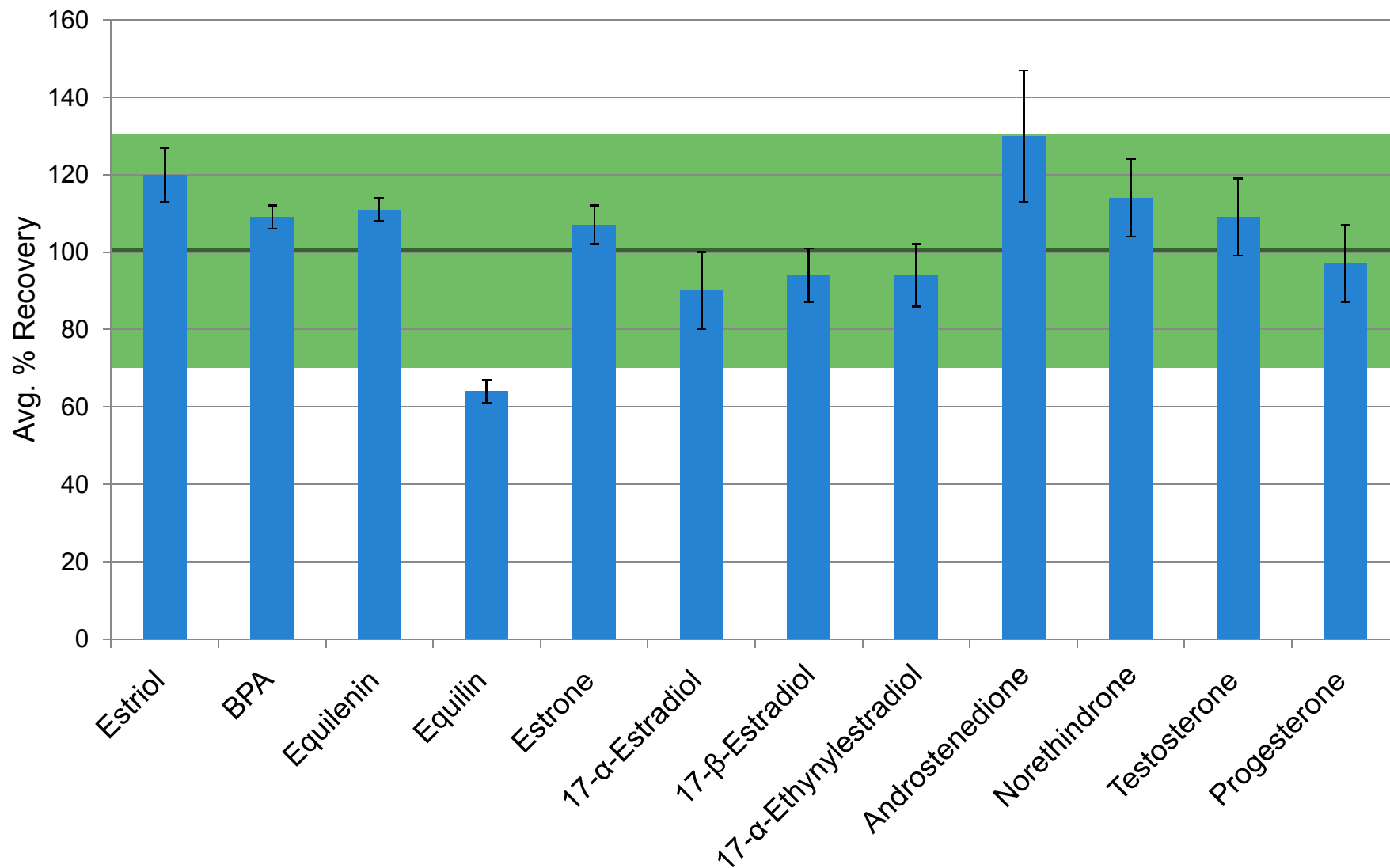

Recovery ranged from 64–130 %

Lowest Concentration Minimum Reporting Level

Hormone	Draft Method Data (ng/L)	Calculated (ng/L)*
Estriol	4.3	63
Bisphenol A	111	80
Equilenin	2.7	6.7
Equilin	5.2	0.15
Estrone	2.4	3.3
17- α -Estradiol	3.5	1.8
17- β -Estradiol	6	0.67
17- α -Ethinylestradiol	23	9.2
Androstenedione	0.17	0.16
Norethindrone	0.36	0.71
Testosterone	0.031	0.021
Progesterone	0.072	0.069

*Four replicates of seven concentrations

LCMRLs were comparable if not better

Conclusion

- Solid-Phase Extraction -> HPLC -> Triple Quadrupole MS



Dionex AutoTrace 280 Solid-phase
Extraction Instrument



UltiMate 3000 LC
System



TSQ Endura MS
System

- Well-differentiated MS peaks
- Hormones in drinking_w ater concentrated with ~100% recovery
- Low ng/L LCMRLs

Thermo Scientific Dionex Sample Prep Product Line



Thermo Scientific™
Dionex™ ASE™ 150/350
Accelerated Solvent
Extractor Systems



Dionex AutoTrace
280 Solid-Phase
Extraction
Instrument



Dionex SolEx
SPE
Cartridges



Thermo
Scientific™
Rocket™
Evaporator
System

Thank you for your interest!

Recovery of Hormones: Fortified Reagent Water

Hormone	Fortified Conc. (µg/L)	Avg. % Recovery	% RSD
Estriol	12	129	10
BPA	100	122	11
Equilenin	5	102	8
Equilin	7.5	89	6
Estrone	5	116	11
17-α-Estradiol	5	93	12
17-β-Estradiol	7.5	109	8
17-α-Ethynylestradiol	37	103	9
Androstenedione	0.25	104	19
Norethindrone	10	100	9
Testosterone	0.1	128	7
Progesterone	0.1	86	19

N=5

Recovery ranged from 86–129 %

Recovery of Hormones: Fortified Drinking Water

Hormone	Fortified Conc. (µg/L)	Avg. % Recovery	% RSD
Estriol	12	120	7
BPA	100	109	3
Equilenin	5	111	3
Equilin	7.5	64	3
Estrone	5	107	5
17- α -Estradiol	5	90	10
17- β -Estradiol	7.5	94	7
17- α -Ethinylestradiol	37	94	8
Androstenedione	0.25	130	17
Norethindrone	10	114	10
Testosterone	0.1	109	10
Progesterone	0.1	97	10

N=5

Recovery ranged from 64-130 %