

**APPENDIX I**

**TVA Pumping Tests**  
**(Boggs, 1983 and Boggs & Jenkins, 1980)**

## **Table of Contents**

<b>ANALYSIS OF AQUIFER TESTS CONDUCTED AT THE PROPOSED BURDOCK URANIUM MINE SITE BURDOCK, SOUTH DAKOTA (Boggs and Jenkins, 1980).....</b>	<b>I-1</b>
<b>HYDROGEOLOGIC INVESTIGATIONS AT PROPOSED URANIUM MINE NEAR DEWEY, SOUTH DAKOTA (Boggs, 1983).....</b>	<b>I-83</b>

*KEITH ANDERSON*

**WR28-1-520-109**

**ANALYSIS OF AQUIFER TESTS CONDUCTED  
AT THE PROPOSED BURDOCK URANIUM MINE SITE  
BURDOCK, SOUTH DAKOTA**

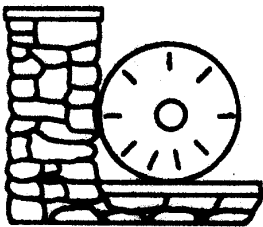

**TENNESSEE VALLEY AUTHORITY  
OFFICE OF NATURAL RESOURCES  
DIVISION OF WATER RESOURCES  
WATER SYSTEMS DEVELOPMENT BRANCH  
NORRIS, TENNESSEE**

Tennessee Valley Authority  
Office of Natural Resources  
Division of Water Resources  
Water Systems Development Branch

ANALYSIS OF AQUIFER TESTS CONDUCTED  
AT THE PROPOSED BURDOCK URANIUM MINE SITE  
BURDOCK, SOUTH DAKOTA

Report No. WR28-1-520-109

Prepared by  
J. M. Boggs  
and  
A. M. Jenkins

Norris, Tennessee  
May 1980

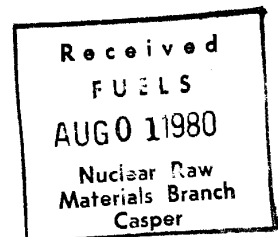

## CONTENTS

	Page
Abstract . . . . .	i
Introduction . . . . .	1
Hydrogeology . . . . .	3
Regional Setting . . . . .	3
Aquifers . . . . .	3
Aquifer Test Design . . . . .	7
Lakota Aquifer Test . . . . .	11
Test Procedures and Result . . . . .	11
Interpretation of Test Results . . . . .	15
Fall River Aquifer Test . . . . .	18
Test Procedures and Results . . . . .	18
Interpretation of Test Results . . . . .	21
Fuson Aquitard Properties . . . . .	23
Computer Model Simulations . . . . .	27
Summary and Conclusions . . . . .	31
References . . . . .	33
Appendix . . . . .	34

LIST OF FIGURES

<u>No.</u>	<u>Title</u>	<u>Page</u>
1	Generalized Geologic Map of Site Region . . . . .	35
2	Burdock Well Profile . . . . .	36
3	Well Location Map . . . . .	37
4	Hydrographs for Burdock Test Well, January 1 Through April 17, 1979 . . . . .	38
5	Hydrographs for B-10 Observation Well Group, January 1 Through April 17, 1979 . . . . .	39
6	Pre-test Ground-water Level Contours for the Lakota Aquifer . . . . .	40
7	Semilogarithmic Graph of Drawdown for the Pumped Well, Lakota Aquifer Test . . . . .	41
8	Semilogarithmic Graphs of Drawdown for B-10 Observation Well Group, Lakota Aquifer Test . . . .	42
9	Semilogarithmic Graphs of Drawdown for B-1 Observation Well Group, Lakota Aquifer Test . . . .	43
10	Seimlogarithmic Graphs of Drawdown for B-11 Observation Well Group, Lakota Aquifer Test . . . .	44
11	Semilogarithmic Graphs of Drawdown for B-9 Observation Well Group, Lakota Aquifer Test . . . .	45
12	Semilogarithmic Graphs of Drawdown for B-7 Observation Well Group, Lakota Aquifer Test . . . .	46
13	Logarithmic Graphs of Drawdown for B-10 Observation Well Group, Lakota Aquifer Test . . . .	47~
14	Logarithmic Graphs of Drawdown for B-1 Observation Well Group, Lakota Aquifer Test . . . .	48
15	Logarithmic Graphs of Drawdown for B-11 Observation Well Group, Lakota Aquifer Test . . . .	49
16	Logarithmic Graphs of Drawdown for B-9 Observation Well Group, Lakota Aquifer Test . . . .	50
17	Logarithmic Graphs of Drawdown for B-7 Observation Well Group, Lakota Aquifer Test . . . .	51

LIST OF FIGURES (continued)

<u>No.</u>	<u>Title</u>	<u>Page</u>
18	Drawdown Versus Distance from the Pumped Well, Lakota Aquifer Test . . . . .	52
19	Drawdown in Lakota Aquifer at End of Lakota Test . . . . .	53
20	Drawdown in Fall River Aquifer at End of Lakota Test . . . . .	54
21	Recovery Graphs for B-10 Observation Well Group, Lakota Aquifer Test . . . . .	55
22	Recovery Graphs for B-1 Observation Well Group, Lakota Aquifer Test . . . . .	56
23	Recovery Graphs for B-11 Observation Well Group, Lakota Aquifer Test . . . . .	57
24	Recovery Graphs for B-9 Observation Well Group, Lakota Aquifer Test . . . . .	58
25	Recovery Graphs for B-7 Observation Well Group, Lakota Aquifer Test . . . . .	59
26	Semilogarithmic Graph of Drawdown for the Pumped Well, Fall River Aquifer Test . . . . .	60
27	Semilogarithmic Graphs of Drawdown for B-10 Observation Well Group, Fall River Aquifer Test . .	61
28	Semilogarithmic Graphs of Drawdown for B-1 Observation Well Group, Fall River Aquifer Test . .	62
29	Semilogarithmic Graphs of Drawdown for B-11 Observation Well Group, Fall River Aquifer Test . .	63
30	Logarithmic Graphs of Drawdown for the Pumped Well, Fall River Aquifer Test . . . . .	64
31	Logarithmic Graphs of Drawdown for B-10 Observation Well Group, Fall River Aquifer Test . .	65
32	Logarithmic Graphs of Drawdown for B-1 Observation Well Group, Fall River Aquifer Test . .	66

LIST OF FIGURES (continued)

<u>No.</u>	<u>Title</u>	<u>Page</u>
33	Logarithmic Graphs of Drawdown for B-11 Observation Well Group, Fall River Aquifer Test . . .	67
34	Recovery Graph for the Pumped Well, Fall River Aquifer Test . . . . .	68
35	Recovery Graphs for B-10 Observation Well Group, Fall River Aquifer Test . . . . .	69
36	Recovery Graphs for B-1 Observation Well Group, Fall River Aquifer Test . . . . .	70
37	Recovery Graphs for B-11 Observation Well Group, Fall River Aquifer Test . . . . .	71
38	Results of Initial Lakota Aquifer Test Simulation . .	72
39	Results of Final Lakota Aquifer Test Simulation . .	73



LIST OF TABLES

<u>No.</u>	<u>Title</u>	<u>Page</u>
1	Generalized Stratigraphic Column for Site Region . . . . .	4
2	Observation Well Construction Details . . . . .	8
3	Lakota Aquifer Properties . . . . .	13
4	Fall River Aquifer Properties . . . . .	20
5	Fuson Aquitard Properties . . . . .	25
6	Parameters Used in Computer Simulations . . . . .	28

## ABSTRACT

Separate aquifer tests were conducted in two aquifers which may be affected by TVA's proposed uranium mining operation near Burdock, South Dakota. In April 1979, a constant-discharge test was conducted in the Chilson member of the Lakota formation which comprises the principal ore body and an aquifer of regional importance. The hydraulic properties of both the Lakota (Chilson) aquifer and the overlying Fuson shale aquitard were determined. A second test was conducted in July 1979 in the Fall River aquifer which overlies the Fuson. The hydraulic characteristics of the Fall River aquifer and a second estimate of the Fuson aquitard properties were obtained from the test. The test results indicate that the two aquifers are hydrologically connected via (1) general leakage through the Fuson shale, and (2) direct pathways, probably in the form of numerous old (pre-TVA) unplugged exploration boreholes.

The hydraulic properties of the Fall River, Fuson and Lakota units obtained from the aquifer test analyses were incorporated into a computer model of the site geohydrologic system. These parameters were refined in a calibration process until the model could reproduce the drawdown responses observed during the Lakota aquifer test. Results indicate the transmissivity and storativity of the Lakota (Chilson) aquifer are approximately 1400 gallons per day per foot (gpd/ft) and  $1.0 \times 10^{-4}$ , respectively. The Fall River aquifer has an estimated transmissivity of 400 gpd/ft and a storativity of about  $1.4 \times 10^{-5}$ . The hydraulic conductivity of the Fuson aquitard is estimated at approximately  $10^{-3}$  foot per day. The specific storativity of the Fuson was not measured but is assumed to be about  $10^{-6}$  feet<sup>-1</sup>.

## INTRODUCTION

This report describes the aquifer testing program conducted at the proposed uranium mine site in Burdock, South Dakota. The purpose of the program was to determine the hydrogeologic conditions in the mining area in order to predict mine dewatering requirements and impacts.

The Fall River formation and the Chilson member of the Lakota formation comprise the principal aquifers in the vicinity of the proposed mine. These aquifers are separated by the Fuson shale member of the Lakota formation which acts as an aquitard. The uranium deposits to be mined lie within the Chilson unit.

Two unsuccessful aquifer tests were conducted at the site prior to those described in this report. The first test was conducted at the Burdock test well in February 1977. Pumping took place from both the Fall River and Lakota aquifers during the 14-day test. The test results were invalidated by questionable well discharge measurements and by mechanical difficulties with a deep-well current meter used to measure the quantity of water pumped from each aquifer. A second test lasting three days was performed in November 1977. Pumping was restricted to the Lakota aquifer during the test in order to determine the potential for leakage through the Fuson shale from the overlying Fall River aquifer. The results of the test were inconclusive because (1) five observation wells used in the test were subsequently found to be improperly constructed and (2) pressure gauges used to monitor pumping response at several wells malfunctioned during the test.

The problems associated with the two earlier tests were corrected for the tests described in this report. The defective observation wells were pressure sealed with cement grout and replaced with properly constructed wells. More reliable instrumentation for monitoring potentiometric heads in observation wells was used in subsequent tests.

## HYDROGEOLOGY

### Regional Setting

The proposed mine site is located in the northwestern corner of Fall River County, South Dakota, less than one mile southeast of the community of Burdock. Geologically, the site is situated on the southwest flank of the Black Hills Uplift (see Appendix, Figure 1). The stratigraphy of the region consists of a sequence of rocks ranging in age from Precambrian to Recent which crop out peripherally to the Black Hills. The Precambrian rocks crop out near the center of the Black Hills, and progressively younger rocks crop out to the southwest. Surficial rocks in the site area range in age from lower Cretaceous to Recent. A generalized stratigraphic column for the site is shown in Table 1.

The major structural features of the region are the southwesterly-trending Dewey and Long Mountain structural zones. Faults, fractures and breccia pipes in these zones are believed to affect the ground-water regime.

### Aquifers

The principal aquifers in the region are the alluvial deposits associated with the Cheyenne River and its major tributaries, the Fall River formation, the Lakota formation, the Sundance formation, and the Pahasapa (or Madison) formation. Except for the alluvium, these aquifers crop out peripherally to the Black Hills where they receive recharge from precipitation. Ground-water movement is in the direction of dip, radially from the central Black Hills. In most instances, ground water in these aquifers is under artesian conditions away from the

TABLE 1: GENERALIZED STRATIGRAPHIC COLUMN FOR SITE REGION  
(FROM KEENE, 1973)

PERIOD	FORMATION NAME	SYMBOL	COLUMN	LITHOLOGIC DESCRIPTION	THKNS. IN FEET	HYDROLOGIC CHARACTERISTICS
Quaternary	Alluvium	Qal		Gravel, sand, and silt floodplain deposits. Alluvial terraces and windblown material.	1-30	Good to excellent aquifer along floodplains; terraces generally non-productive except for scattered springs.
	Pierre Fm.	Kp		Dark gray shale, weathering brown or buff and containing many fossiliferous concretions.  Scattered concretions which form "tepee buttes"	1000+	Relatively no value as an aquifer; locally large diameter wells in stream valleys may yield small amounts of highly mineralized water during wet seasons.
Cretaceous	Niobrara Fm.	Kn		Black fissile shale, cone-in-cone concretions. Gray calcareous shale, weathering yellow and impure chalk with <i>Ostrea Congesta</i> .	100-225	No known wells.
	Turner sand	Kcr		Light gray shale with large concretions.	520-540	Relatively impermeable; possible small yields from Turner and Wall Creek sands.
	Wall Creek sand			Gray shale with thin sandstone layers.		
	Greenhorn Lms.	Kg		Thin bedded hard limestone, weathering creamy white, contains <i>Inoceramus labatus</i> .	50	Too thin and dense to be an aquifer.
	Belle Fourche Fm.	Kgs		Light gray shale, bentonite, large concretions.	870	Newcastle sand may yield water, permeability is variable.
	Mowry Shale			Light gray siliceous shale.		
	Graneros Group			Thin brown-to-yellow sandstone.		
	Newcastle sand			Black shale		
	Skull Creek Shale					
	Fall River Fm.	Kfr		Interbedded red-brown massive sandstone and Carbonaceous shales.	30-165	Largest producer in the area. Yields up to 60 gpm of highly mineralized water (flow). Water quality generally poor, sometimes yields hydrogen sulfide.
Fuson Shale	Kik		Gray-to-purple shale, thin shales.	0-180	Relatively good aquifer from the lower Chisnon member, up to 30 gpm artesian flow	
Minnewasta Lms.			Light gray massive limestone.	0-25		
Lakota Fm.			Coarse, hard, cross-bedded sandstone, buff-to-gray, coal beds locally near base.	130-230		
Morrison Fm.	Km		Green-to-maraon shale, thin sandstone.	0-125	No known wells, possible aquifer.	
Jurassic	Unkpapa Fm.	Ju		Fine grained, massive, vari-colored sandstone.	0-240	No known wells, possible aquifer
	Sundance Fm.	Jsd		Alternating beds of red sandstone and red-to-green marine shales.	250-450	Produces small amounts of water from the sands suitable for domestic use.
	Speartfish Fm.	Rs		Red silty shale, limestone, and anhydrite near the top. Redbeds. Gypsum locally near the base.	400	Poor producer, small yields of sulfate water
?	Minnekahta Lms.	Cmk		Pale brown, to gray dense, crystalline limestone.	50	Locally secondary fracture porosity
Permian	Opeche Fm.	Co		Red thinly bedded sandstones and shales, purple shale near top.	100	No known wells
?						
Pennsylvanian	Minnelusa Fm.	Cml		Converse sand, red-to-yellow cross bedded sand. Red marker, thin red shale near middle. Leo sands, series of thin limestones. Dolomite at bottom with basal laterite zone.	755-1040	Permeability variable; tremendous flows of warm mineralized water recorded near the periphery of the Black Hills. Excellent potential.
Mississippian	Pahasapa Fm.	Cps		Massive, light colored dolomite and limestone, cavernous in upper 100 feet	165-465	Most promising aquifer in the area. The 2 wells in this aquifer produce large amounts of water suitable for domestic use
Precambrian	Metamorphic and igneous rocks	PC		Granite, schists, quartzite, and slates.	---	No potential.

outcrop area, and water flows from numerous wells in the area at ground surface.

The Fall River and Lakota formations which form the Inyan Kara Group are the principal aquifers in the region. The alluvium is used locally as a source of domestic and stock water. The Sundance formation is used near its outcrop area in central and northwestern Fall River County. The Pahasapa (Madison) formation is locally accessible only by very deep wells and is the source for five wells in the city of Edgemont.

The Fall River and Lakota aquifers are of primary concern because of the potential impact of mine dewatering on the numerous wells developed in these aquifers in the vicinity of the mine. At the proposed mine site, the Fall River consists of approximately 120 feet of interbedded fine-grained sandstone, siltstone and carbonaceous shale. The Fall River aquifer is overlain by approximately 250 feet of the Mowry and Skull Creek shales unit, which act as confining beds. Twenty-six domestic and stock-watering wells are known to be developed in the Fall River formation within a four-mile radius of the mine site. Many of these are flowing at the surface.

The Fall River formation is underlain by Fuson shale member of the Lakota formation. Thickness of the Fuson is on the order of 60 feet in the site vicinity. The Fuson acts as a leaky aquitard between the Fall River and Lakota aquifers. A physical examination of undisturbed core samples of Fuson indicates that the shale itself has a very low permeability. However, aquifer tests suggest a direct connection through the Fuson which may be the result of some as-yet-unidentified structural features or old unplugged exploration holes.

The Chilson member of the Lakota formation is the second most widely used aquifer in western Fall River County, as the source for some 23 wells within a four-mile radius of the mine site. It is also the uranium-bearing unit to be mined. The Chilson consists of about 120 feet of consolidated to semi-consolidated, fine-grained sandstone and siltstone. It is underlain by the Morrison formation consisting of interbedded shale and fine-grained sandstone. Regionally, the Morrison is not considered an aquifer. Under conditions of groundwater withdrawal from the Chilson, the Morrison is expected to act as an aquitard.

Recharge to the Fall River and Lakota aquifers is believed to occur at their outcrop areas. Bowles (1968) has theorized that recharge to these aquifers may also be derived from the upward movement of ground water along solution collapses and breccia pipes from the deeper Minnelusa and Pahasapa aquifers. The solution collapse and breccia pipe features lie within the Dewey and Long Mountain structural belts.



## AQUIFER TEST DESIGN

The objective of the aquifer testing program was to obtain sufficient quantitative information about local hydrogeologic conditions to enable prediction of mine dewatering requirements and impacts to both the Fall River and Lakota aquifers. Since the two aquifers involved are separated by the Fuson aquitard, two distinct pumping tests were required to obtain the necessary information about each formation: one test in which the Lakota aquifer was pumped, and another in which pumping was limited to the Fall River aquifer. During both tests ground-water levels were monitored in observation wells developed in each of the three formations. Data obtained from these tests were then analyzed to obtain estimates of the hydraulic properties of the aquifers and aquitard.

The Burdock test well was constructed approximately 600 feet north of the proposed mine shaft. Total depth of the well is 559 feet. The well is screened in both the Fall River and Lakota aquifers as shown in Figure 2.

Fifteen observation wells were constructed within an approximate one-mile radius of the pumping well as indicated in Figure 3. Seven of these wells are developed in the Fall River formation, five in the Lakota, and three in the Fuson. In addition, there is a single well developed in the Sundance formation located approximately one mile from the test well. This well was not constructed specifically for the aquifer tests, but was monitored periodically during the Lakota aquifer test. Construction details for these wells are given in Table 2.

TABLE 2. Observation Well Construction Details

<u>Well No.</u>	<u>Total Depth (feet)</u>	<u>Casing Diameter (inches)</u>	<u>Depth Interval of Open Borehole or Well Screen (feet)</u>	<u>Distance From Pumped Well (feet)</u>
B-10LAK	550	4	510-550	195
B-10FU	395	4	377-395	255
B-10FR	350	4	300-350	177
B-1LAK	570	4	525-570	405
B-1FU	440	4	420-440	350
B-1FR	376	4	334-376	373
B-11LAK	550	4	504-550	618
B-11FR	360	4	315-360	620
B-9LAK	545	1	503-545	1540
B-9FR	293	1	251-293	1540
B-7LAK	441	1	399-441	2507
B-7FR	252	1	210-252	2540
Sundance Well	880	7 7/8	666-780	4763

Inasmuch as water levels in each hydrogeologic unit will respond differently during pumping tests, it is important that each observation well reflect the potentiometric head in the intended uncased borehole interval. Several observation wells used in previous tests were suspected of leaking along the grout seal placed in the annular space between well casing and borehole wall. As a result, special precautions were taken to ensure proper construction of the observation wells used in the present tests. A geophysical device known as a cement logging probe was used to check the continuity of the cement grout seal in each well after construction. All were found to be properly sealed.

The so-called ratio-method of multiple-aquifer test analysis (Neuman and Witherspoon, 1973) requires that the response of water levels in both the pumped and unpumped aquifers and in the intervening aquitard be monitored during the test. Water level responses in these units must be measured in wells located at approximately the same radial distance from the pumped well. To obtain the necessary data, two groups of observation wells were constructed, each group having one well developed in the Fall River, one in the Fuson, and one in the Lakota (Chilson member). The B-10 group was located approximately 200 feet northeast of the pumping well, while the B-1 group was located approximately 375 feet to the southwest. These well groups were located close to the pumped well to ensure response in the aquitard and in the unpumped aquifer, if such responses were to occur at all. The remaining well groups (B-7, B-9 and B-11 series) contain only Fall River and Lakota wells.

Under natural conditions, the test well and all monitor wells except for those of the B-7 group flow at ground surface if not capped. The two previous tests conducted at the site indicated that observation wells in the pumped aquifer located close to the pumping well would become non-flowing at some point during the test. Thus, pressure sensing devices would be required during the early part of the test and depth measuring techniques during later periods. To ensure adequate data records, each flowing well was equipped with two pressure measuring devices. Malfunctions of several pressure gauges on previous tests pointed out the need for a back-up pressure measuring device.

Three types of pressure sensors were used: mercury manometers, electronic pressure transducers, and mechanical pressure gauges. The B-1 and B-10 observation well groups were equipped with mercury manometers and pressure transducers. As the closest wells to the pumping center, the data from these wells are most important in the multiple aquifer analysis and warrant the best instrumentation. Pressure transducers from all wells were wired to a central terminal and could be monitored frequently during the tests. Each well in groups B-9 and B-11 was equipped with a mercury manometer and a mechanical pressure gauge. Electric probes were used to measure water levels in the non-flowing wells of the B-7 group. These devices were also used to measure water levels in other wells which became non-flowing during pumping tests. Potentiometric head in the pumped well was measured with a mercury manometer, an air line and an electric probe.

## LAKOTA AQUIFER TEST

Several months prior to the Lakota test, a pneumatic packer was set within the Fuson section of the test well to prevent communication between the Fall River and Lakota aquifers through the well. A submersible pump was set below packer to restrict pumping to the Lakota aquifer. Well-head valves on the test well and other artesian observation wells were closed to prevent flow in order to bring the ground-water system into equilibrium before testing.

Hydrographs for the test well and observation wells prior to test are shown in Figures 4 and 5. These hydrographs typify the basic relationship between the potentiometric heads in the Fall River, Fuson and Lakota, i.e., heads are highest in the Lakota, lowest in the Fall River, and at an intermediate position within the Fuson. The irregular readings recorded during January and February 1979 were due to depressurization of the aquifers during the installation of instrumentation and new wells. The pre-test ground-water level configuration in the Lakota aquifer on April 18 is shown in Figure 6.

### Test Procedures and Results

A constant-discharge aquifer test was initiated at 1300 hours on April 18, 1979. Discharge from the well was pumped via pipeline to a stock-watering pond located approximately 0.75 miles from the test well. Pumpage was measured with an in-line flow meter and with an orifice plate and manometer device at the end of the discharge line. The pumping rate varied little during the test ranging from 201 to 205 gpm and averaging 203 gpm. The pumping phase of the test lasted for

73 hours (3.04 days) and was followed by a 30 day period of recovery measurements.

Figure 7 shows a semilogarithmic graph of drawdown (s) versus time (t) for the pumping well (Lakota aquifer). Erratic readings during the first 200 minutes of the test are the result of problems with the airline equipment, and are not due to discharge variations. These difficulties were subsequently corrected, but in general airline measurements are believed to be accurate only to within about  $\pm 2$  feet.

Semilog graphs for the observation well groups are shown in Figures 8 through 12. Note that a slight initial increase in hydrostatic pressure is indicated in the Fall River and Fuson wells of the B-10 and B-1 well groups. This anomalous trend is more pronounced in the Fuson wells than in the Fall River wells and persists for approximately 90 minutes in B-10FU. The response is believed to be due to an increase in pore pressure resulting from deformation of the matrix of these formations.<sup>1</sup> In any case, the anomalous trend was recorded by both the pressure transducers and mercury manometers, and is not the result of measurement error.

The Jacob straight-line method (see Walton, 1970, pp. 130-133) was applied to the semilog graphs for the Lakota wells to obtain the values of transmissivity (T) and storativity (S) presented in Table 3. In the case of the closer observation wells, two straight-line

<sup>1</sup>During the early stages of pumping, water removed from the Lakota in the immediate vicinity of the well causes compaction of the aquifer. This, in turn, may cause the overlying strata to flex slightly in the area where the underlying support of the Lakota has been reduced. The resulting deformation in the overlying formations causes compressive forces which temporarily increase pore pressures in these materials. Subsequently, the effect of pumping-induced depressurization is transmitted through the overlying materials, gradually lowering the hydrostatic pressure.

TABLE 3. Lakota Aquifer Properties

Well No.	r (ft)	Jacob Method				Theis Method				Recovery Method	
		$T_e$ (gpd/ft)	$S_e$ --	$T_l$ (gpd/ft)	$S_l$ --	$T_e$ (gpd/ft)	$S_e$ --	$T_l$ (gpd/ft)	$S_l$ --	$T_e$ (gpd/ft)	$T_l$ (gpd/ft)
PW-LAK	0.67	1980	--	1260	--	--	--	--	--	--	--
B-10LAK	195	2680	$7.6 \times 10^{-5}$	1370	$3.5 \times 10^{-4}$	2530	$8.4 \times 10^{-5}$	1660	$1.6 \times 10^{-4}$	2060	1300
B-11LAK	405	2140	$4.4 \times 10^{-5}$	1340	$1.2 \times 10^{-4}$	2120	$4.8 \times 10^{-5}$	1550	$8.4 \times 10^{-5}$	1970	1240
B-111LAK	620	--	--	--	--	2530	$1.1 \times 10^{-4}$	1530	$1.5 \times 10^{-4}$	--	1250
B-9LAK	1540	--	--	--	--	--	--	1370	$1.3 \times 10^{-4}$	--	1290
B-7LAK	2507	--	--	--	--	--	--	1760	$6.5 \times 10^{-5}$	--	1500
Average:		2270	$6.0 \times 10^{-5}$	1320	$2.4 \times 10^{-4}$	2390	$8.1 \times 10^{-5}$	1570	$1.2 \times 10^{-4}$	2015	1270

NOTE: Subscript "e" denotes an aquifer parameter determined using early drawdown (or recovery) data. Similarly, subscript "l" denotes a parameter computed from late data.

solutions were possible: one using the early data and another using the late data. Note that data for wells B-7L, B-9L and B-11L cannot be analyzed by the Jacob method because data do not satisfy the criterion that  $r^2S/4Tt \leq 0.01$  (consistent units), where  $r$  is the distance between the pumped well and the observation well.

Logarithmic graphs of drawdown data for all observation wells are given in Figures 13 through 17. Their curve-matching techniques (Walton, 1970, pp. 209-211) were applied to the Lakota curves to obtain  $T$  and  $S$  estimates for the Lakota aquifer. As with the Jacob analyses, two curve-match solutions were possible: one using the early, steeply-rising portions of the  $s-t$  curves, and another using the later data. Both solutions are given in Table 3.

A semilogarithmic graph of distance versus drawdown (Figure 18) was constructed by plotting the final drawdown in each Lakota well versus its radial distance from the pumped well. The Jacob straight-line techniques were applied to these data to obtain  $T$  and  $S$  values for the Lakota of 1780 gpd/ft and  $7.7 \times 10^{-5}$ , respectively. However, this type of analysis is applicable only to nonleaky aquifer systems. Since leakage obviously occurred during the test, the results are considered unreliable.

Contour maps of the final drawdown in the Lakota and Fall River aquifers at the end of the test are shown in Figures 19 and 20, respectively. The drawdown cone in both aquifers is slightly elongated in a northwesterly direction. This is probably an indication of anisotropic transmissivity, with the transmissivity in the direction parallel to the axis of elongation being somewhat greater than that in the direction normal to the axis of elongation. The principal direction of trans-



missivity parallels the strike of a regional fracture-joint set, suggesting a possible explanation for the observed drawdown configuration.

Following the pumping phase of the test, water level recovery measurements were made at all observation wells for a period of 30 days. Attempts were also made to monitor recovery in the pumped well using an airline. However, data collected were highly erratic suggesting a malfunction of the airline equipment. Semilogarithmic graphs of residual drawdown versus  $t/t'$  (ratio of time since pumping started to time since pumping stopped) for the observation wells are shown in Figures 21 through 25. Lakota graphs were analyzed using Jacob straight-line techniques to obtain the estimates of transmissivity presented in Table 3. Again, two straight-line fits are possible for the closer Lakota wells. Both are given in Table 3.

#### Interpretation of Test Results

The drawdown trends recorded in the observation wells indicate some important qualitative information about hydrogeologic conditions at the proposed mine site, in addition to providing a basis for determining hydraulic properties of materials. The relative response of the Fall River, Fuson and Lakota formations as reflected in the B-10 and B-1 groups (Figures 13 and 14), is not typical of the response that would be expected in an ideal leaky multiple aquifer system. Ideally, the  $s-t$  curve for the intervening aquitard lies between the curves for the pumped and unpumped aquifers. That is, in a logarithmic plot of  $s-t$  data the aquitard (Fuson) curve would lie below the curve for the pumped aquifer (Lakota), and above the curve for the unpumped aquifer (Fall River). However, "ideal" trends are not evident in the

observed data until after 300 minutes of pumping in the case of the B-10 group, and not until after 2000 minutes in the case of the B-1 group. The fact that a greater pumping response is observed in Fall River formation than in the Fuson during the early part of the test indicates that direct (though restricted) avenues through the Fuson must exist. This condition was suspected before the test, and is believed to be the result of numerous old, unplugged uranium exploration boreholes in the test site vicinity. The shift to a more ideal relationship among the s-t curves exhibited during the latter part of test possibly indicates that general leakage through the Fuson itself has caught up with leakage through the open boreholes.

The leakage condition which is apparent in the response of the Fuson and Fall River wells is not evident in the Lakota well data. Under ideal conditions, the rate of drawdown in the Lakota observation wells would be expected to gradually decrease and perhaps even level off completely for some period of time. However, the opposite effect is noted in Lakota s-t plots, particularly the semilog graphs for B-10 LAK and B-1 LAK (Figures 8 and 9). The rate of drawdown increases in the latter stages of pumping which might indicate decreasing transmissivity of the Lakota aquifer in the site vicinity. The decrease in transmissivity may be due to aquifer thinning or possibly a facies change to less permeable materials. In any case, it is suspected that the leakage effects in the Lakota drawdown data are masked by the conflicting effect of a decreasing transmissivity in the site vicinity.

In general, the agreement between the Theis and Jacob analyses of s-t data is good. T values computed using early drawdown data average 2390 gpd/ft using the Theis method, and about 2270

gpd/ft using the Jacob method. Early data storativities are also in good agreement averaging  $6.0 \times 10^{-5}$  for the Jacob method and  $8.1 \times 10^{-5}$  for the Theis method. The T values computed from the late data ( $T_{\ell}$ ) are significantly lower than those determined from the early data, whereas late storativities are larger. The Jacob method yields  $T_{\ell}$  values which average 1320 gpd/ft and storativities averaging  $2.4 \times 10^{-4}$ . The Theis method produced an average  $T_{\ell}$  of 1570 gpd/ft and an average  $S_{\ell}$  of  $1.2 \times 10^{-4}$ . The late Theis T values are somewhat higher than the Jacob T's because the Theis method gives some consideration to the earlier data which the Jacob method does not. Transmissivities estimated by the recovery data average 1270 gpd/ft, and are in close agreement with the late Jacob results, although slightly lower.

Ordinarily, in selecting representative T and S for the pumped aquifer in a leaky multiple aquifer system, more emphasis would be placed on the early data collected in the pumped aquifer at the pumped well and closest observation wells. These data are considered least affected by leakage. However, because of the apparent decrease in transmissivity of the Lakota aquifer during the latter stages of the test, it is believed that Lakota parameters computed from the late data are more representative of aquifer properties under a long-term pumping situation such as mine dewatering. On this basis the average transmissivity of the Lakota is estimated to be 1400 gpd/ft and the average storativity  $1.8 \times 10^{-4}$ .

### FALL RIVER AQUIFER TEST

Following completion of recovery measurements associated with the Lakota aquifer test, pumping equipment in the Burdock well was rearranged for the Fall River test. A submersible pump was set within the Fall River section of the well and the pneumatic packer reset below the pump in the Fuson section of the well in order to restrict pumping to the Fall River. A preliminary test of the pump and other equipment lasting less than one hour was conducted on May 29. Unexpectedly, the Fall River aquifer was capable of yielding only about 10 gpm on a sustained basis. Since other Fall River wells in the region yield up to 40 gpm, it was assumed that either the well screen was encrusted or the well was not fully developed, or both. An unsuccessful effort was made to develop the well by pumping. A television camera was subsequently lowered into the well to examine the well screen. Little or no encrustation was observed on the screen. Ultrasonics were used in the well to remove any existing encrustation but the yield of the well was not improved. The low productivity of the well is, therefore, attributed to locally poor water-bearing characteristics of the Fall River formation.

#### Test Procedures and Results

A constant discharge test commenced at 1100 hours on July 24. Water levels in all geologic units were stable prior to the test, as there was no pumping activity in the site vicinity since the completion of well development on July 3. Discharge was measured with an in-line flowmeter, and checked with a 55-gallon container and stopwatch.

During the test the pumping rate varied from 7.6 to 10.4 gpm, and averaged 8.5 gpm. Ground-water levels were monitored in all observation wells shown in Figure 3. The constant discharge test was terminated at 1200 hours on July 26 after 49 hours of pumping. Subsequently, ground-water level recovery measurements were made for a period of six days.

Semilog graphs of drawdown data recorded at the pumped well and observation well groups B-1, B-10 and B-11 are shown in Figures 26 through 29, respectively. No graphs are presented for B-11LAK or the B-7 and B-9 groups as there was no measureable drawdown in these wells. Except for B-11FR, these graphs exhibit a typical straight-line drawdown trend during the first part of the test, followed by a gradual decrease in slope towards the end of the test. This slope change is the result of leakage from adjacent formations, and/or an increase in aquifer transmissivity at some distance from the pumped well. The Jacob method was applied to the semilog graphs to obtain the transmissivity and storativity values shown in Table 4. The  $T_e$  and  $S_e$  values were obtained using early drawdown data recorded during approximately the first 500 minutes of the test.  $T_1$  and  $S_1$  values were computed from data recorded after about 1000 minutes. The only reliable estimates are considered to be those computed for B-1FR and B-10FR. Drawdown data for the pumped well is affected by wellbore storage which is significant in this test because of the relatively low pumping rate. The pumped well drawdown data may also be affected by low well efficiency. The semilog plot for B-11FR cannot be analyzed by the Jacob method because the criterion that  $r^2S/4Tt \leq 0.01$  is not satisfied for any of the data.

TABLE 4. Fall River Aquifer Properties

Well No.	r (ft)	Jacob Method				Theis Method		Recovery Method	
		$T_e$ (gpd/ft)	$S_e$ --	$T_l$ (gpd/ft)	$S_l$ --	$T_e$ (gpd/ft)	$S_e$ --	$T_e$ (gpd/ft)	$T_l$ (gpd/ft)
PW-FR	0.67	16.(?)	--	--	--	--	--	11(?)	--
B-10FR	177	140.	$1.8 \times 10^{-5}$	410.	--	150.	$1.7 \times 10^{-5}$	80.	340.
B-1FR	373	150.	$0.8 \times 10^{-5}$	420.	--	150.	$1.1 \times 10^{-5}$	90.	350.
B-11FR	618	--	--	--	--	--	--	--	--
Average:		145	$1.3 \times 10^{-5}$	415.	--	150.	$1.4 \times 10^{-5}$	85.	345.

Logarithmic graphs of drawdown data for the pumped well and observations well groups B-10, B-1 and B-11 are presented in Figures 30 through 33, respectively. These curve-matching techniques were applied to the Fall River curves to obtain the aquifer properties given in Table 4.

Semilog recovery curves for the pumped well and well groups B-10, B-1 and B-11 are shown in Figures 34 through 37, respectively. Again, properties computed from the pumped well recovery data are invalidated by well-bore storage effects. Separate estimates of transmissivity obtained from early and late phases of the recovery data are given in Table 4.

#### Interpretation of Fall River Aquifer Test Results

There is good agreement between the early Jacob and Theis results for B-1FR and B-10FR. These analyses indicate an average  $T_e$  of about 150 gpd/ft and an average  $S_e$  of approximately  $1.4 \times 10^{-5}$ . Application of the Jacob method to the late drawdown data yields an average  $T_1$  of 415 gpd/ft. No meaningful storativity values could be computed from the late data. The  $T_e$  values computed by the recovery method are considerably lower than those computed by the other two methods and are believed to be unrealistic. The  $T_1$  values derived from the recovery analyses compare reasonably well with the Jacob late drawdown results.

The computed transmissivity and storativity values are representative of the aquifer only within the relatively small area influenced by the pumping test. The yield of the test well is substantially less than that of several other wells in the region. The difference in well

yields suggests that the Fall River aquifer is less permeable in the mine site vicinity than in certain surrounding areas. The aquifer parameters computed from the early drawdown and recovery data are believed to be representative of the aquifer in the immediate vicinity of the test wells. Parameters obtained from analysis of the late data are probably more representative of regional aquifer characteristics.



### FUSON AQUITARD PROPERTIES

The hydraulic properties of the Fuson aquitard were estimated using an analytical technique known as the "ratio method" developed by Neuman and Witherspoon (1973). The method requires (1) a knowledge of the transmissivity and storativity of the pumped aquifer; (2) draw-down data for the pumped and unpumped aquifers and the aquitard measured in wells located at approximately the same radial distance from the pumped well; and (3) the vertical distance between the aquifer-aquitard boundary and the perforated section of each aquitard well ( $Z$ ). The method yields a value of aquitard hydraulic diffusivity,  $\alpha'$ , equal to  $K'_v/S'_s$ , where  $K'_v$  is the vertical hydraulic conductivity of the aquitard and  $S'_s$  is the specific storativity of the aquitard. To determine  $K'_v$  or  $S'_s$  from  $\alpha'$ , either  $K'_v$  or  $S'_s$  must first be known. In the following analyses a value of  $S'_s = 10^{-6} \text{ ft}^{-1}$  is assumed for the Fuson aquitard. Experience indicates that specific storativities of geologic materials do not vary over as wide a range as do hydraulic conductivities. For this reason, and considering the difficulty and expense of obtaining an accurate measure of  $S'_s$  over the site vicinity, it appears justifiable to assume a value of  $S'_s$  typical of similar geologic materials.

The first step in the analysis is to compute a value of  $s'/s$  at a given radial distance from the pumped well,  $r$ , and at a given time,  $t$ . Next a value of  $t_D$  (dimensionless time for the aquifer equal to  $tT/r^2S$ ) is determined. The values of  $s'/s$  and  $t_D$  are used to compute a value for  $t'_D$  (dimensionless time for the aquitard equal to  $K't/S'_sZ^2$ ) using a family of type curves given in Figure 3 of Neuman and Witherspoon (1973). The vertical hydraulic conductivity of the aquitard  $K'_v$  is then obtained from the following equation:

### FUSON AQUITARD PROPERTIES

The hydraulic properties of the Fuson aquitard were estimated using an analytical technique known as the "ratio method" developed by Neuman and Witherspoon (1973). The method requires (1) a knowledge of the transmissivity and storativity of the pumped aquifer; (2) draw-down data for the pumped and unpumped aquifers and the aquitard measured in wells located at approximately the same radial distance from the pumped well; and (3) the vertical distance between the aquifer-aquitard boundary and the perforated section of each aquitard well ( $Z$ ). The method yields a value of aquitard hydraulic diffusivity,  $\alpha'$ , equal to  $K'_v/S'_s$ , where  $K'_v$  is the vertical hydraulic conductivity of the aquitard and  $S'_s$  is the specific storativity of the aquitard. To determine  $K'_v$  or  $S'_s$  from  $\alpha'$ , either  $K'_v$  or  $S'_s$  must first be known. In the following analyses a value of  $S'_s = 10^{-6}$  ft<sup>-1</sup> is assumed for the Fuson aquitard. Experience indicates that specific storativities of geologic materials do not vary over as wide a range as do hydraulic conductivities. For this reason, and considering the difficulty and expense of obtaining an accurate measure of  $S'_s$  over the site vicinity, it appears justifiable to assume a value of  $S'_s$  typical of similar geologic materials.

The first step in the analysis is to compute a value of  $s'/s$  at a given radial distance from the pumped well,  $r$ , and at a given time,  $t$ . Next a value of  $t_D$  (dimensionless time for the aquifer equal to  $tT/r^2S$ ) is determined. The values of  $s'/s$  and  $t_D$  are used to compute a value for  $t'_D$  (dimensionless time for the aquitard equal to  $K't/S'_sZ^2$ ) using a family of type curves given in Figure 3 of Neuman and Witherspoon (1973). The vertical hydraulic conductivity of the aquitard  $K'_v$  is then obtained from the following equation:

$$K'_v = t'_D Z^2 S'_s / t \quad (1)$$

Since separate pumping tests were conducted in the Lakota and Fall River aquifers, it is possible to calculate two independent values of  $K'_v$  for each well group. Fuson aquitard properties computed by the ratio method along with certain pertinent parameters used in the calculations are presented in Table 5.

Note that since the Fall River, Fuson and Lakota observation wells in each well group do not lie at exactly the same radial distance from the pumped well, an average radial distance  $r_{avg}$  is used in the calculations. The  $r_{avg}$  values shown in Table 5 were obtained by averaging the radial distance for the pumped aquifer observation well and the radial distance for the aquitard observation well. Also note that the column labeled "Time Interval" represents the time interval during which  $K'_v$  values were computed. Generally, three or four values of  $K'_v$  were computed at specific times within this interval. These values were then averaged to obtain the  $K'_v$  values shown in Table 5.

The vertical hydraulic conductivity of the Fuson ranges from about  $10^{-4}$  ft/d at the B-1 well group to about  $10^{-3}$  ft/d at the B-10 well group. The agreement between the conductivities computed at each well group site for both tests is good. The reason for the order of magnitude difference between the conductivities at the different well sites is unknown, but may be related to errors caused by differences in the radial distances of observation wells--these differences being somewhat greater for the wells of the B-10 group.

TABLE 5. Fuson Aquitard Properties

<u>Test</u>	<u>Well Group</u>	<u>r<sub>avg.</sub> (ft)</u>	<u>Z (ft)</u>	<u>Time Interval (min.)</u>	<u>(gpd/ft<sup>2</sup>)<sup>K'<sub>v</sub></sup></u>	<u>(ft/d)</u>
Lakota	B-10	225	28	100-393	$2.0 \times 10^{-2}$	$2.7 \times 10^{-3}$
	B-1	378	11	100-393	$1.0 \times 10^{-3}$	$1.3 \times 10^{-4}$
Fall R.	B-10	216	25	100-300	$4.8 \times 10^{-3}$	$6.6 \times 10^{-4}$
	B-1	362	40	1200-2350	$1.3 \times 10^{-3}$	$1.8 \times 10^{-4}$

The magnitudes of computed conductivities are slightly higher than expected on the basis of the physical characteristics of the Fuson, although they are still within reason. The presence of open boreholes may have caused a more rapid drawdown response in the Fuson monitor wells than would have occurred otherwise. As a result, the calculated  $K'_v$  values are probably larger than the actual conductivity of the Fuson shale. The calculated  $K'_v$  values are, however, probably smaller than the effective  $K'_v$  of the aquitard in the areas where it is breached by open boreholes.

### COMPUTER MODEL SIMULATIONS

The hydraulic properties estimated for the Fall River, Fuson and Lakota formations were incorporated into a computer model of the site geohydrologic system. Simulations of the Lakota aquifer test were performed to see if the model could reproduce the drawdown responses observed during the test. An acceptable match between the measured and computed responses would indicate the validity of the estimated formation properties, and thus enhance the credibility of the model for predicting mine dewatering requirements and impacts.

A finite element numerical model developed by Narasimhan et al. (1978) was used for the aquifer test simulations. The aquifer/well-field system was modeled in three dimensions using axial symmetry. The hydraulic properties of the Fall River, Fuson and Lakota formations obtained from the aquifer test analyses were used as initial input data (see Table 6). Uniform properties were assumed for each hydrogeologic unit. The shale units which lie above the Fall River formation and those which lie below the Lakota were assumed to be impermeable in the model. All simulation comparisons were made for the Lakota aquifer test. The Lakota test stressed a larger portion of the multiple aquifer system than did the Fall River test, and more closely approximates the flow regime expected during mine dewatering.

A comparison of the measured and computed results for the initial simulation run are shown in Figure 38. In general, the agreement between the computed and observed drawdown graphs for the Lakota aquifer are good. However, there are large discrepancies in the Fall River and Fuson responses.

TABLE 6. Parameters Used In Computer Simulations

Formation	Initial Parameters					Final Parameters				
	T (gpd/ft)	S (--)	$K_v$ (ft/d)	$K_v/K_h$ (--)	Ss (ft <sup>-1</sup> )	T (gpd/ft)	S --	$K_v$ (ft/d)	$K_v/K_h$ --	Ss (ft <sup>-1</sup> )
Fall River	150.	$1.4 \times 10^{-5}$	$5.6 \times 10^{-2}$	1/3	$1.2 \times 10^{-7}$	400	$1.4 \times 10^{-5}$	$4.6 \times 10^{-2}$	1/10	$1.2 \times 10^{-7}$
Fuson	0.13	$6.0 \times 10^{-5}$	$1.7 \times 10^{-4}$	1/3	$1.0 \times 10^{-6}$	0.45	$6.0 \times 10^{-5}$	$1.0 \times 10^{-3}$	1/1	$1.0 \times 10^{-6}$
Lakota (Chilson)	1400.	$1.8 \times 10^{-4}$	$5.0 \times 10^{-1}$	1/3	$1.5 \times 10^{-6}$	1400.	$1.0 \times 10^{-4}$	$1.5 \times 10^{-1}$	1/10	$8.3 \times 10^{-7}$

Several attempts were made to improve the match between the computed and observed drawdown responses by trial-and-error adjustment or calibration of model parameters. The most reliable parameters, such as the computed Lakota and Fall aquifer coefficients, were only slightly altered in the calibration process, whereas the least reliable parameters, including the ratio of vertical to horizontal permeability and the Fuson properties, were allowed to vary over a wider (though reasonable) range. The hydraulic properties within each hydrogeologic unit were assumed to be uniform throughout the calibration process.

The set of hydraulic parameters yielding the best agreement between measured and observed drawdown data is given in Table 6. The final parameter set differs only slightly from the original. The largest changes were made in the  $K_v/K_h$  terms which were unknown to begin with; and in the Fuson hydraulic conductivity which was increased by a factor of five. Both the early and late Fall River T values computed from the aquifer test analyses (150 and 415 gpd/ft, respectively) were tested during model calibration. The drawdown response of the model was found to be relatively insensitive to the value of T used. A transmissivity of 400 gpd/ft is included in the final parameter set as it is believed to be more characteristic of the aquifer regionally.

The match between the measured and computed drawdown responses, shown in Figure 39, is considered acceptable in light of the fact that uniform aquifer-aquitard properties were used in the model. The apparent discrepancies are believed to be due to the heterogeneity and anisotropy of the actual system. The departures which occur during the early phase of the simulation appear large, but are not significant.



The ability of the model to predict the long-term response of system is more important. Thus, more significance is attached to the agreement between the simulated and observed results for the latter part of the test which, in most cases, is quite good. The final set of aquifer-aquitard properties are considered to represent a valid basis for future predictive modeling.

## SUMMARY AND CONCLUSIONS

The aquifer test results indicate that the Fuson member of the Lakota formation is a leaky aquitard separating the Fall River and Lakota aquifers. The hydraulic communication between the two aquifers observed during the tests is believed to be the result of (1) general leakage through the primary pore space and naturally occurring joints and fractures of the Fuson shale, and (2) direct connection of aquifers via numerous old unplugged exploratory boreholes. Whereas, the former leakage mechanism is a regional characteristic of the Fuson, leakage caused by borehole short-circuiting is probably limited to the relatively small area of intensive uranium exploration in the Burdock vicinity.

The Lakota (Chilson) aquifer has an estimated transmissivity of approximately 1400 gpd/ft and a storativity of about  $1.0 \times 10^{-4}$ . These properties are representative of the Lakota in the area affected by the pumping test, and are consistent with what is known or suspected about the aquifer regionally. The transmissivity and storativity of the Fall River aquifer are estimated at approximately 400 gpd/ft and  $1.4 \times 10^{-5}$ , respectively. Test results indicate that the transmissivity of the Fall River may be considerably less than 400 gpd/ft in the immediate vicinity of the test site. However, the selected transmissivity value is more consistent with regional aquifer characteristics.

The hydraulic conductivity of the Fuson aquitard is estimated at approximately  $10^{-3}$  ft/d. The specific storativity of the Fuson was not measured but is assumed to be about  $10^{-6}$  ft<sup>-1</sup>. If open boreholes

are present at the test site as suspected, the computed hydraulic conductivity is probably higher than the true conductivity of the shale, yet lower than the effective conductivity of the aquitard where short-circuited by open boreholes. For this reason, the selected aquitard conductivity of  $10^{-3}$  ft/d should provide a conservative estimate of mine dewatering impacts. Outside of the relatively small area where the aquitard is breached by boreholes, leakage between the two aquifers will be governed by the true conductivity of the shale which is probably on the order of  $10^{-4}$  ft/d or less.

The hydraulic properties of the Fall River, Fuson and Lakota (Chilson) formations computed from aquifer test data were incorporated into a computer model of the site geohydrologic system. These parameters were refined through repeated simulations of the Lakota aquifer test until the model could reproduce the drawdown responses observed during the test. The agreement between the observed and computed responses indicates the validity of the aquifer-aquitard properties, and should enhance the credibility of future predictive models using these parameters.

#### REFERENCES

1. Gott, G. B., D. E. Walcott, and C. G. Bowles, "Stratigraphy of the Inyan Kara Group and Localization of Uranium Deposits, Southern Black Hills, South Dakota and Wyoming." USGS Prof. Paper 763, 1974.
2. Keene, J. R., "Ground-water Resources of the Western Half of Fall River County, South Dakota." Rept. of Inv. No. 109, S. D. Geol. Survey, 1973.
3. Narasimhan, T. N., S. P. Neuman, and P. A. Witherspoon, "Finite Element Method for Subsurface Hydrology Using a Mixed Explicit-Implicit Scheme," Water Resources Research, Vol. 14, No. 5, 1978.
4. Neuman, S. P. and P. A. Witherspoon, "Field Determination of the Hydraulic Properties of Leaky Multiple Aquifer Systems," Water Resources Research, Vol. 8, No. 5, 1973.
5. Walton, W. C., Groundwater Resource Evaluation, McGraw-Hill, New York, 1970.

APPENDIX

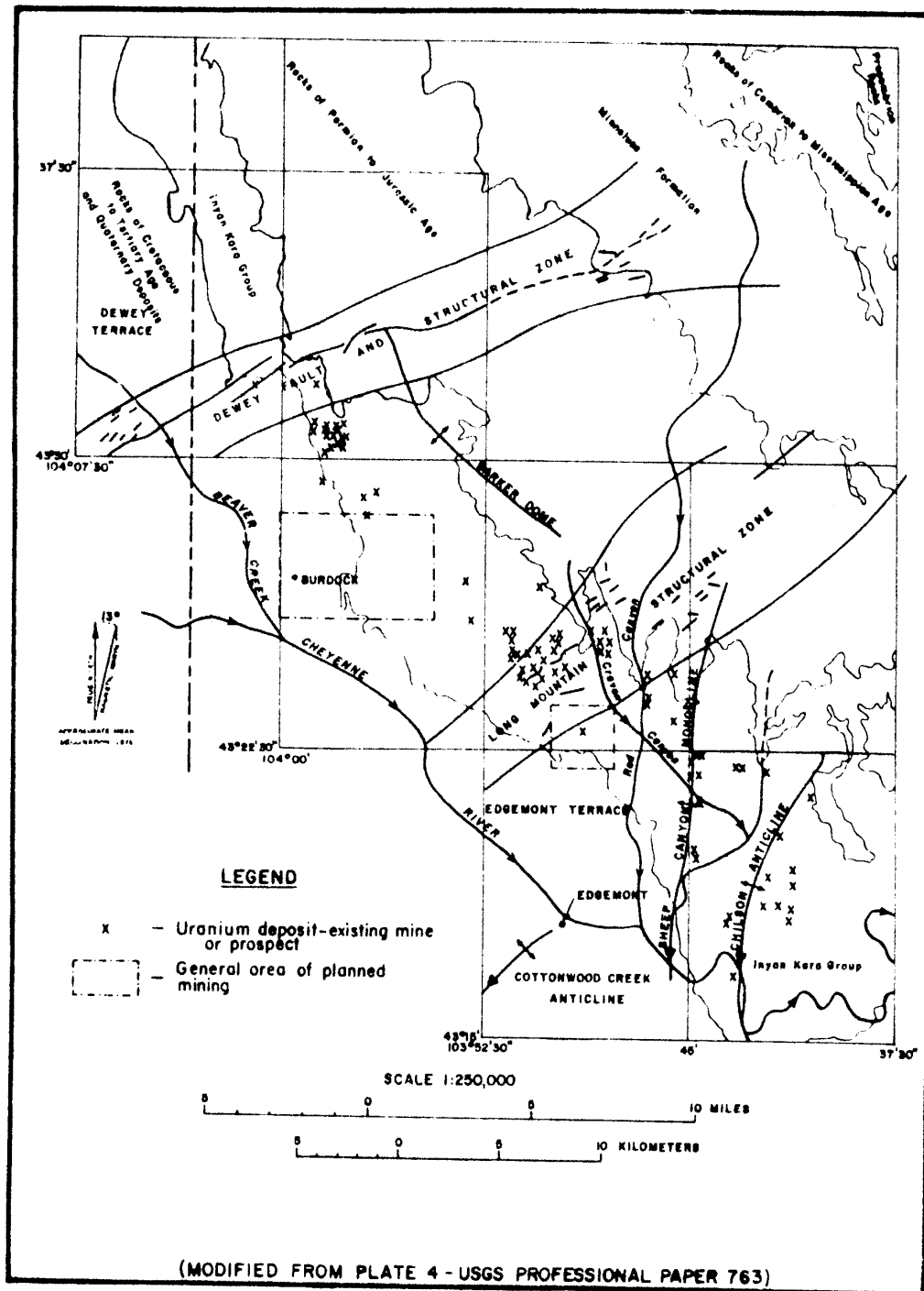

Figure 1 : Generalized Geologic Map of Site Region

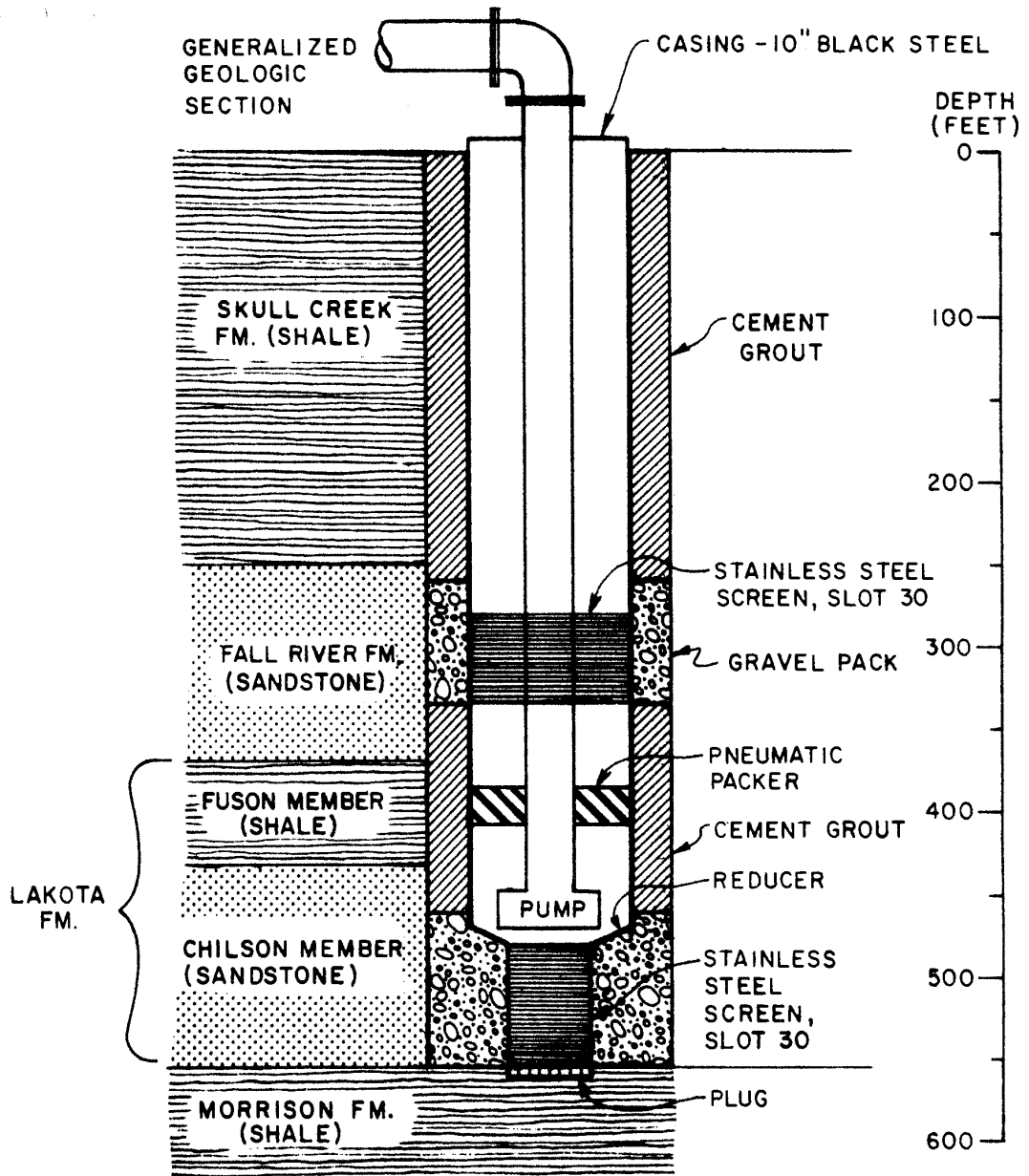

Figure 2 : Burdock Well Profile

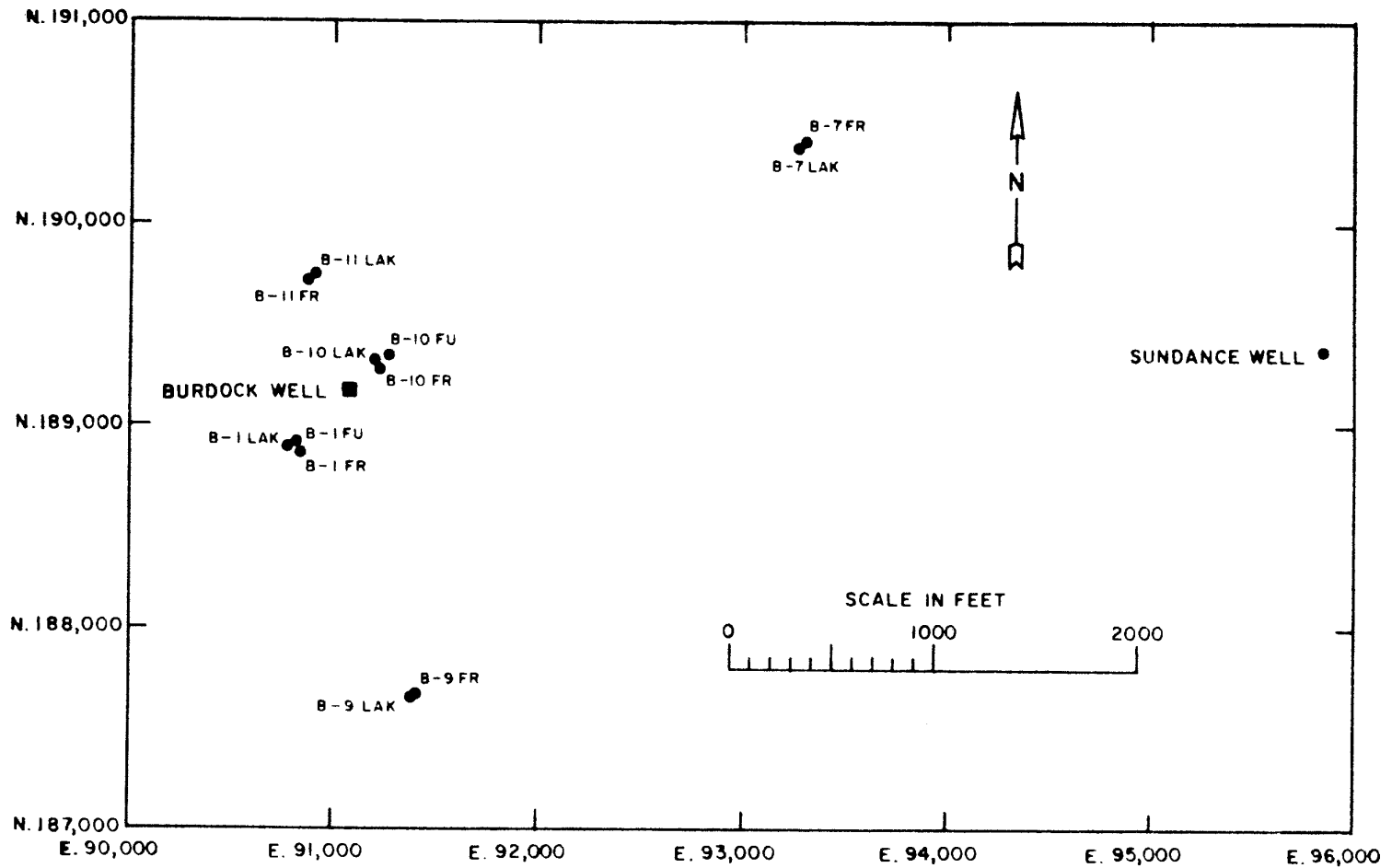

Figure 3: Well Location Map



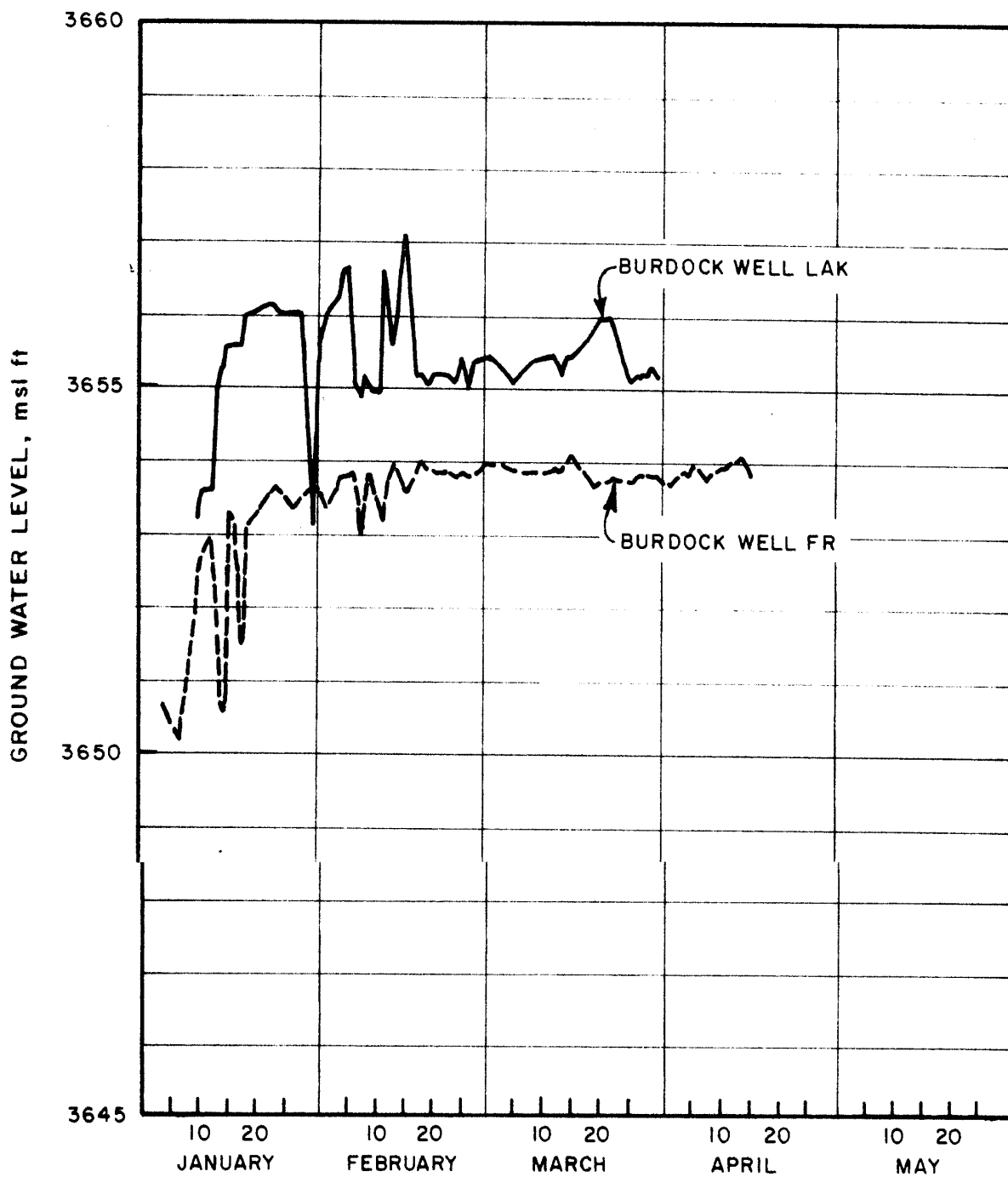

Figure 4 : Hydrographs for Burdock Test Well, January 1 through April 17, 1979

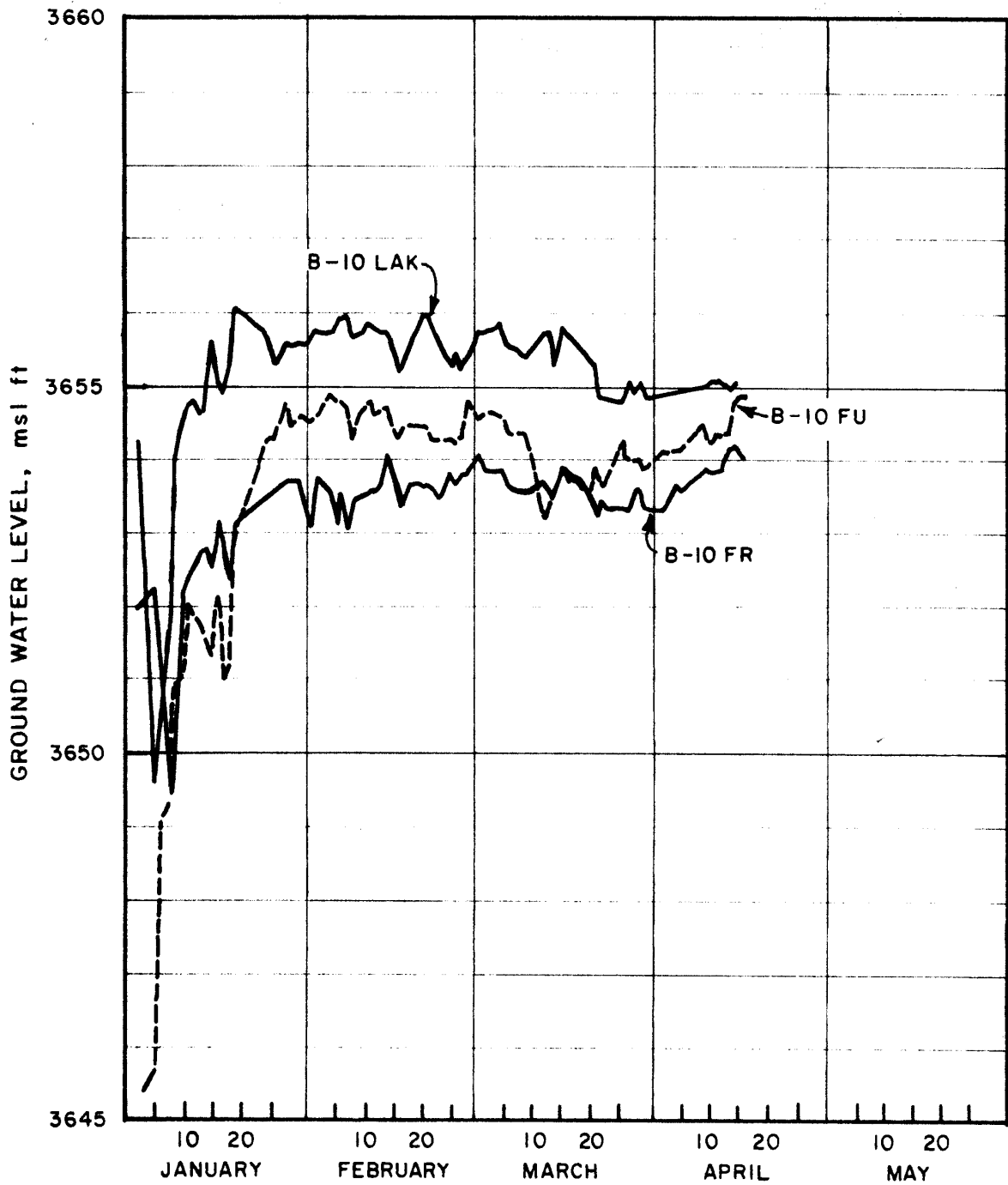

Figure 5 : Hydrographs for B-10 Observation Well Group, January 1 through April 17, 1979

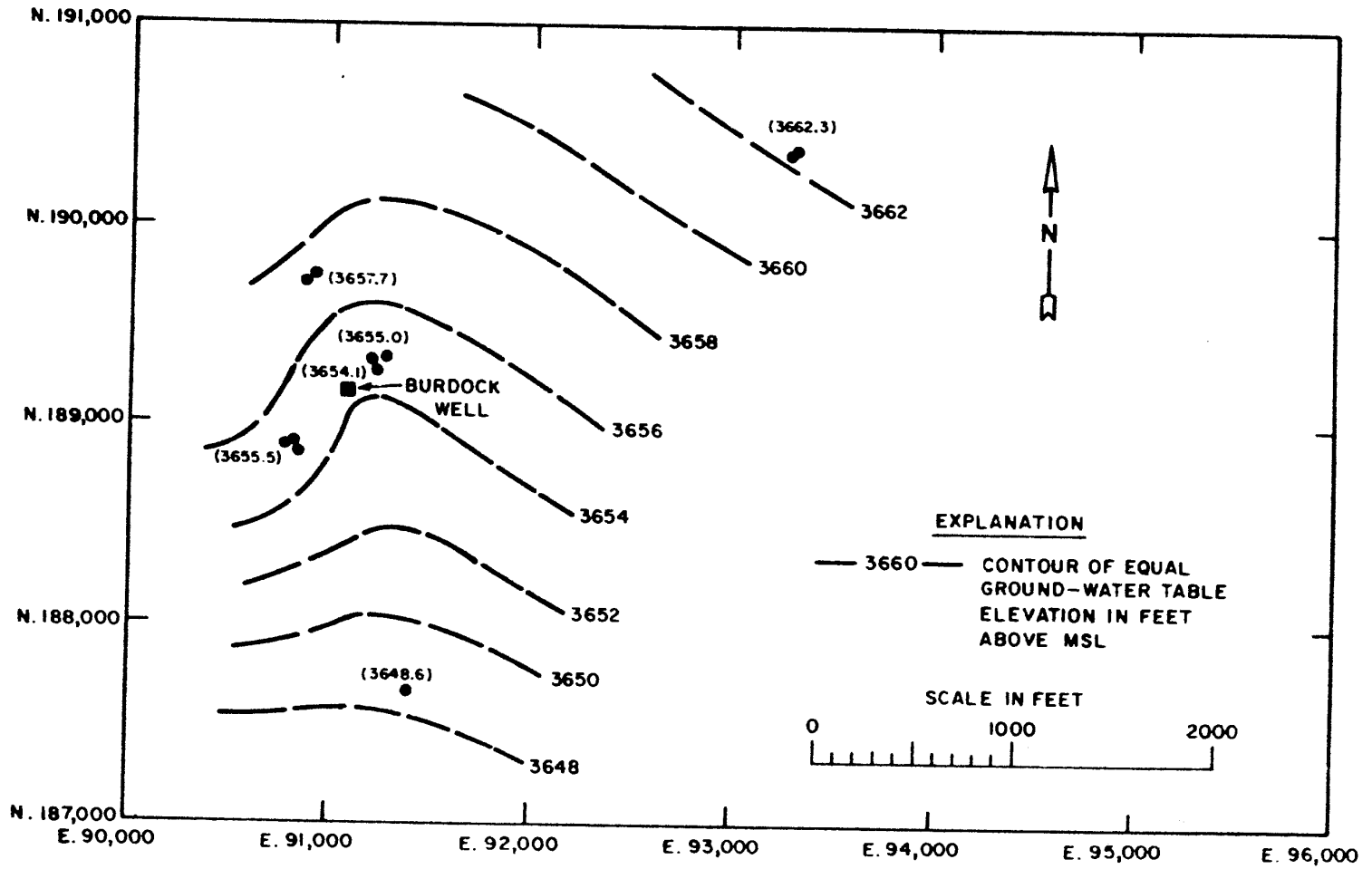

Figure 6 : Pre-Test Ground-Water Level Contour Map for Lakota Aquifer

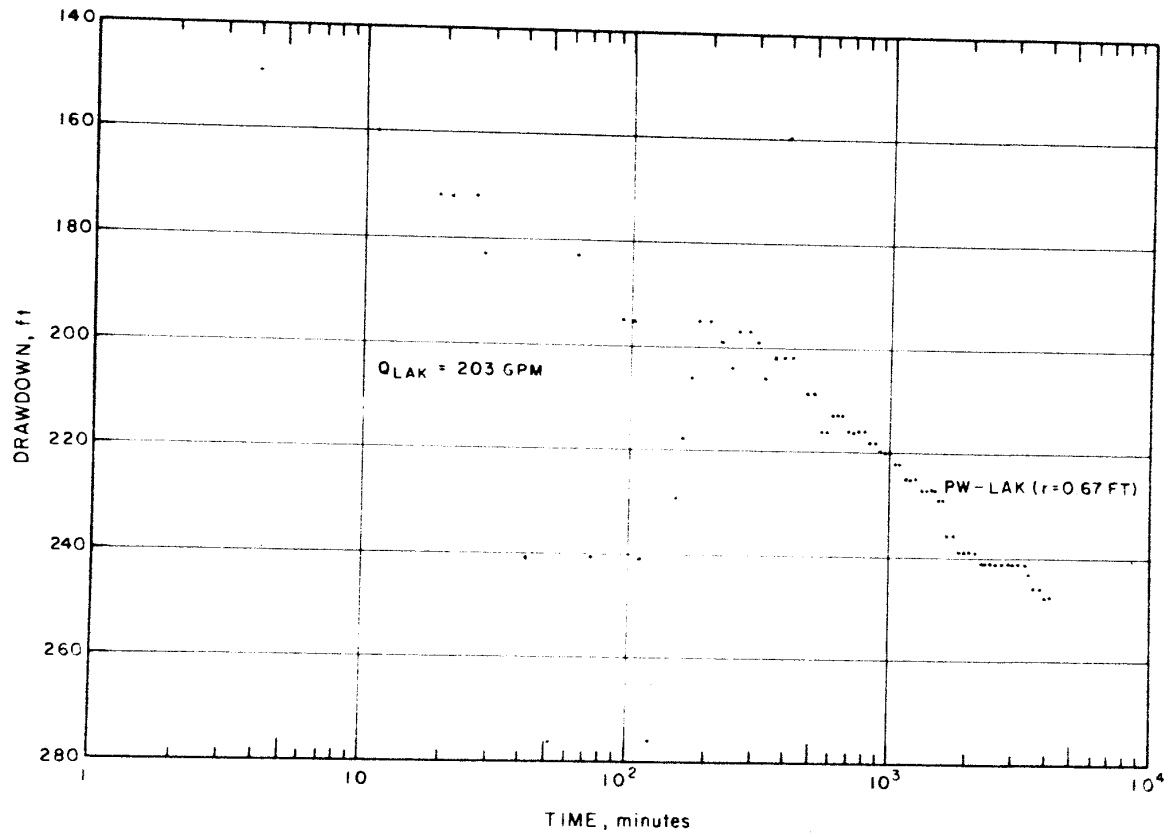

Figure 7: Semilogarithmic Graph of Drawdown for Pumped Well, Lakota Aquifer Test

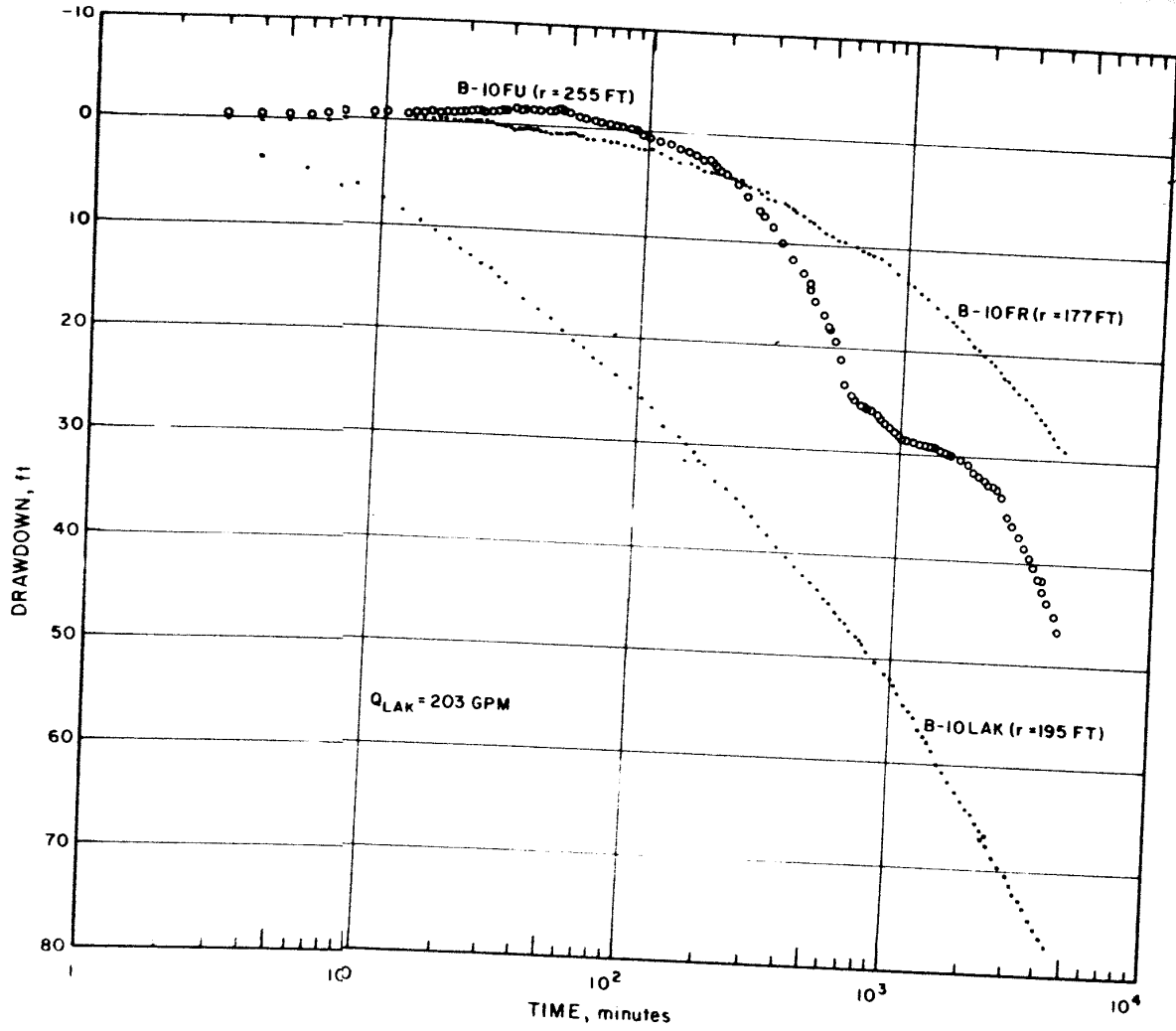

Figure 8 : Semilogarithmic Graphs of Drawdown for B-IO Observation Well Group, Lakota Aquifer Test

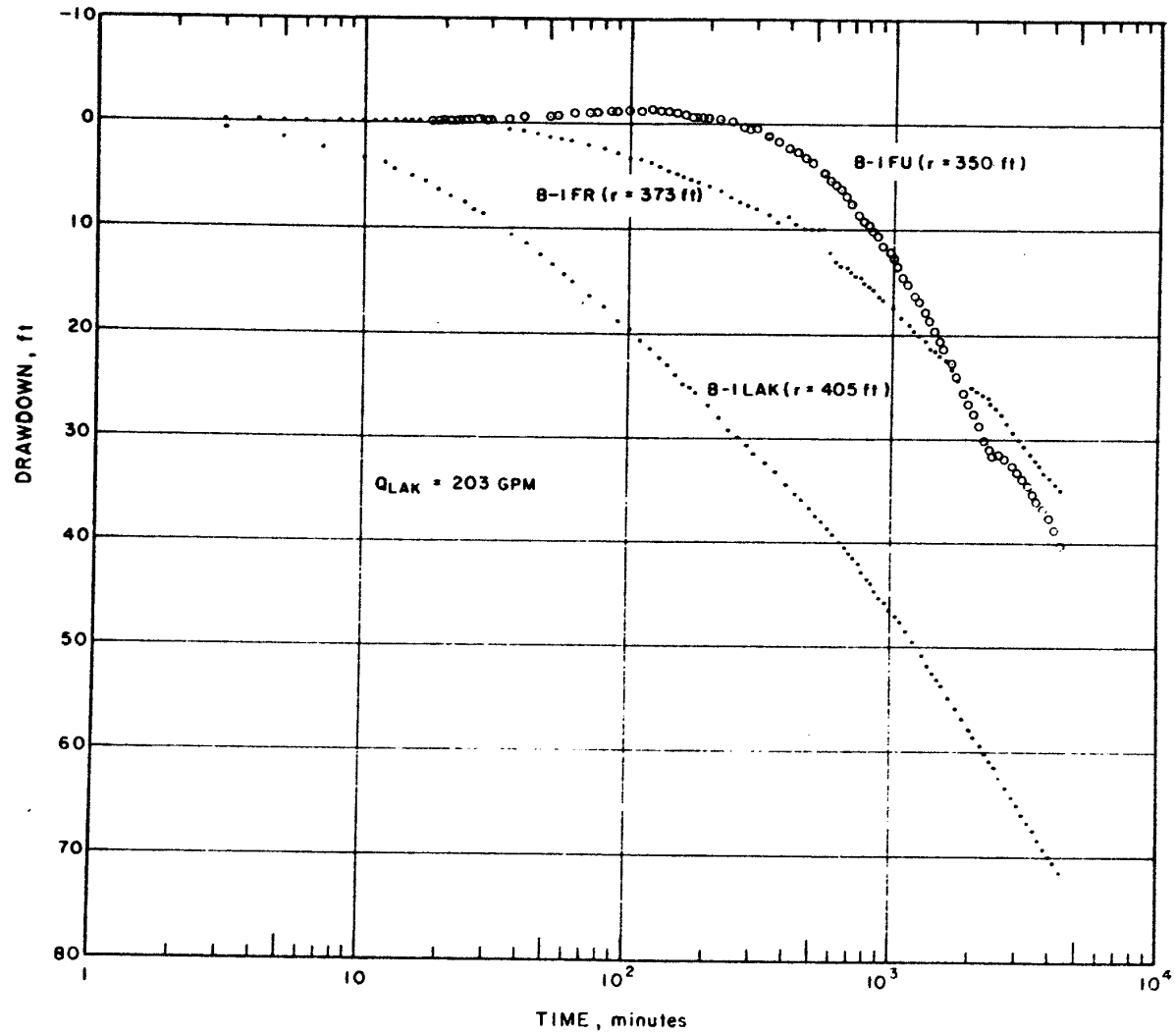

Figure 9: Semilogarithmic Graphs of Drawdown for B-I Observation Well Group, Lakota Aquifer Test

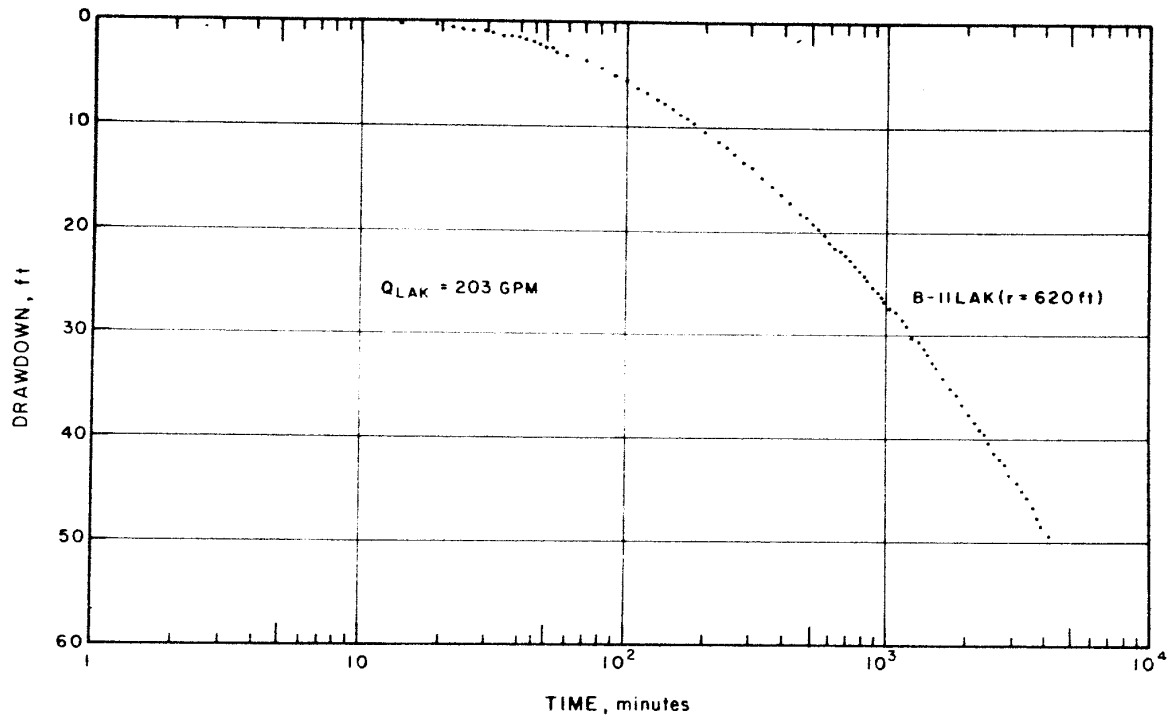

Figure 10: Semilogarithmic Graph of Drawdown for B-II Observation Well Group, Lakota Aquifer Test

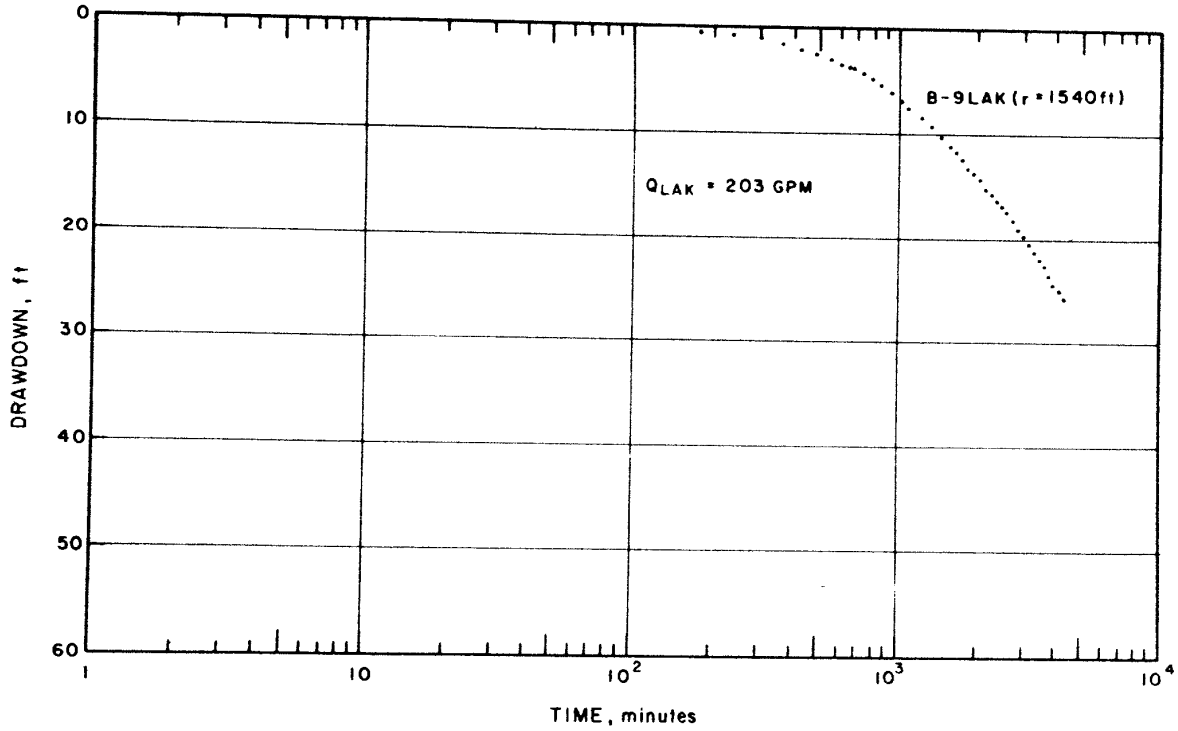

Figure II: Semilogarithmic Graph of Drawdown for B-9 Observation Well Group, Lakota Aquifer Test



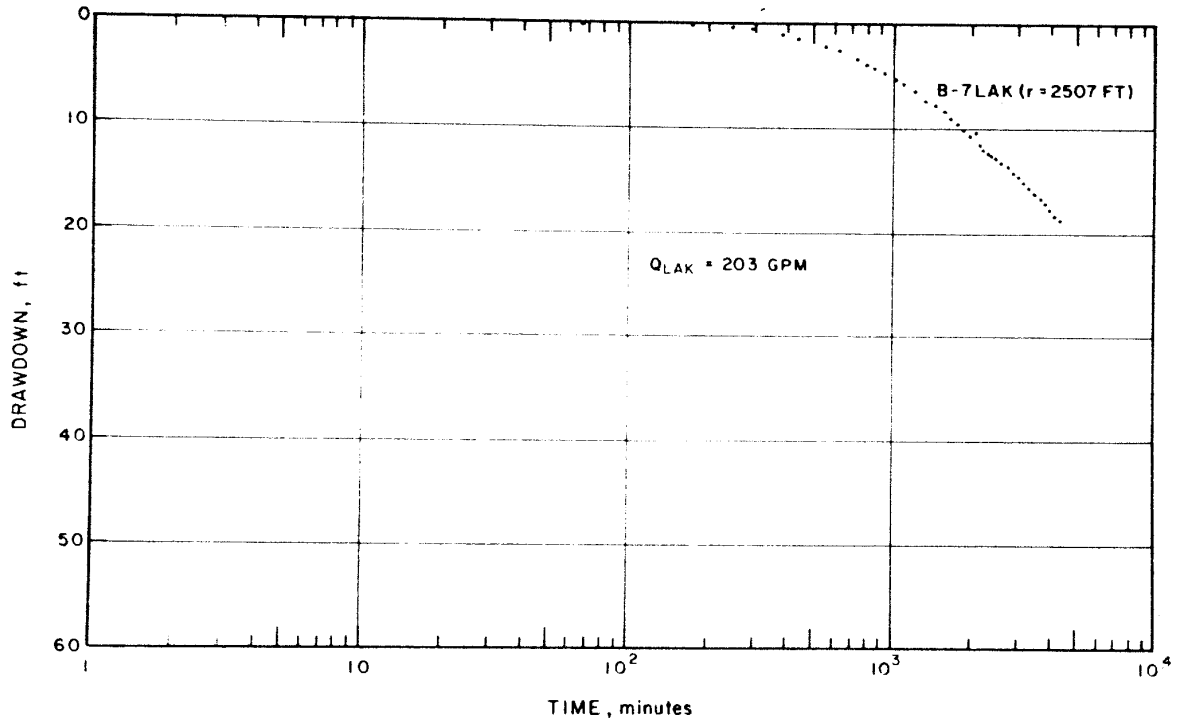

Figure 12: Semilogarithmic Graph of Drawdown for B-7 Observation Well Group, Lakota Aquifer Test

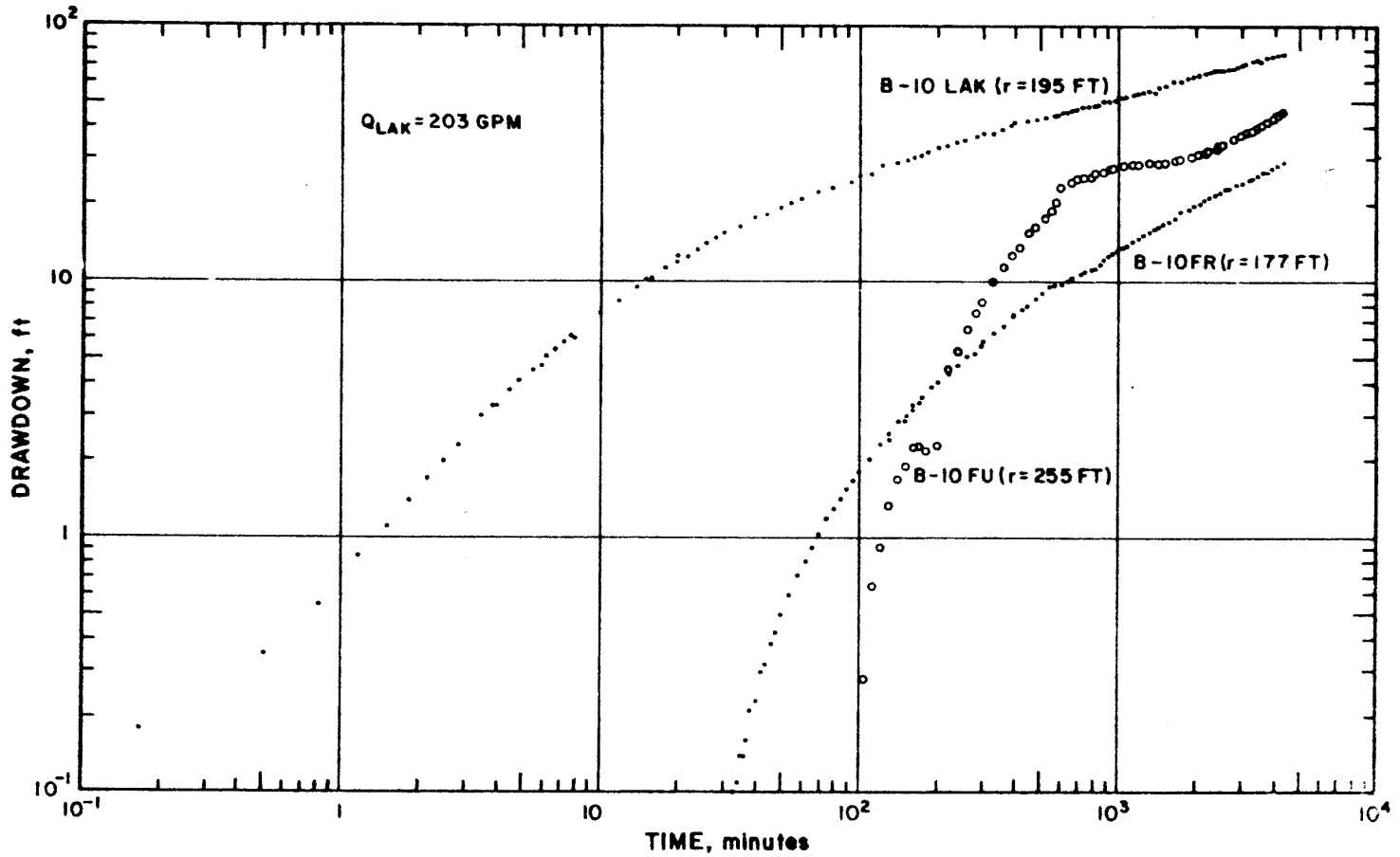

Figure 13 : Logarithmic Graphs of Drawdown for B-10 Observation Well Group, Lakota Aquifer Test

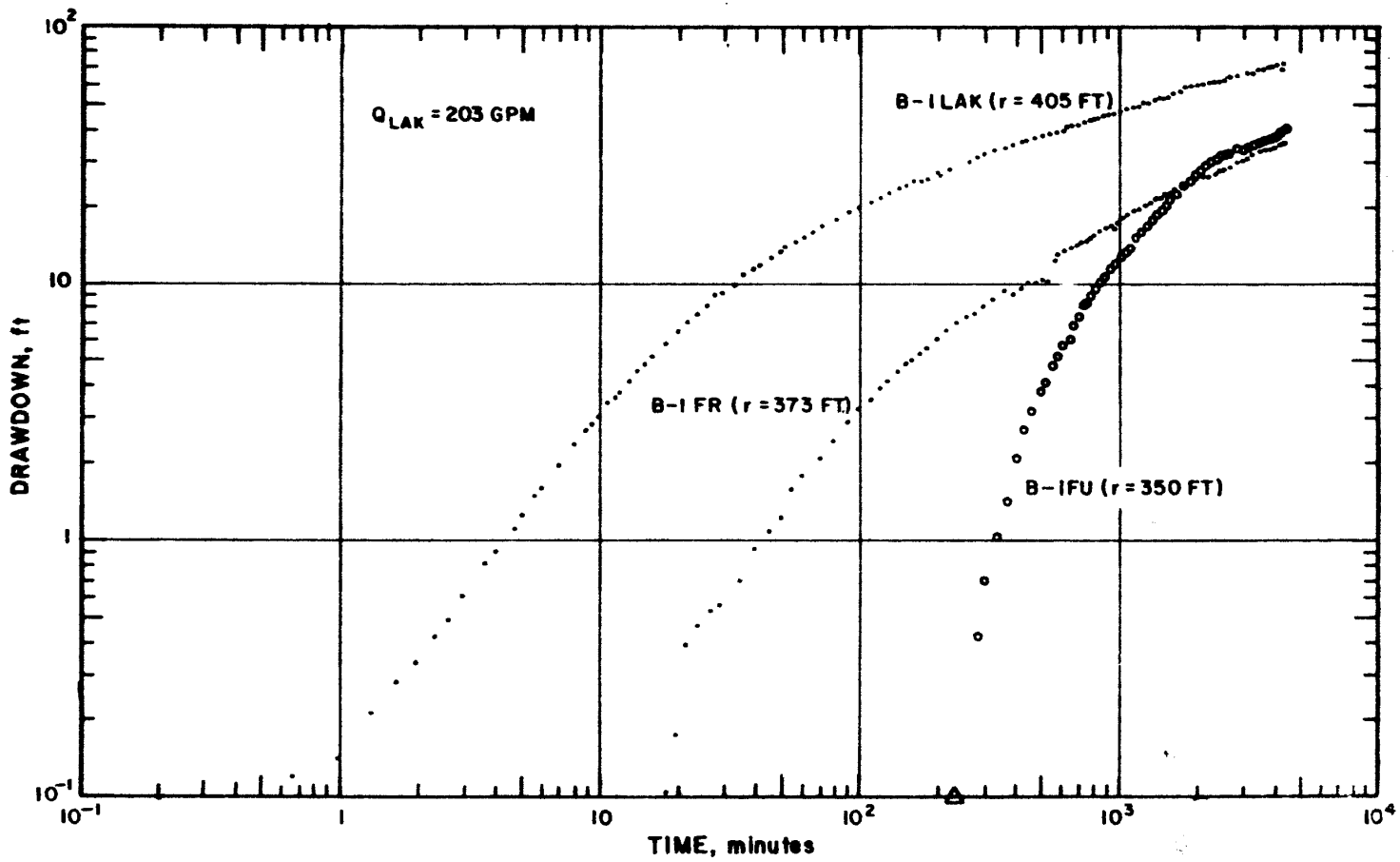

Figure 14 : Logarithmic Graphs of Drawdown for B-1 Observation Well Group, Lakota Aquifer Test

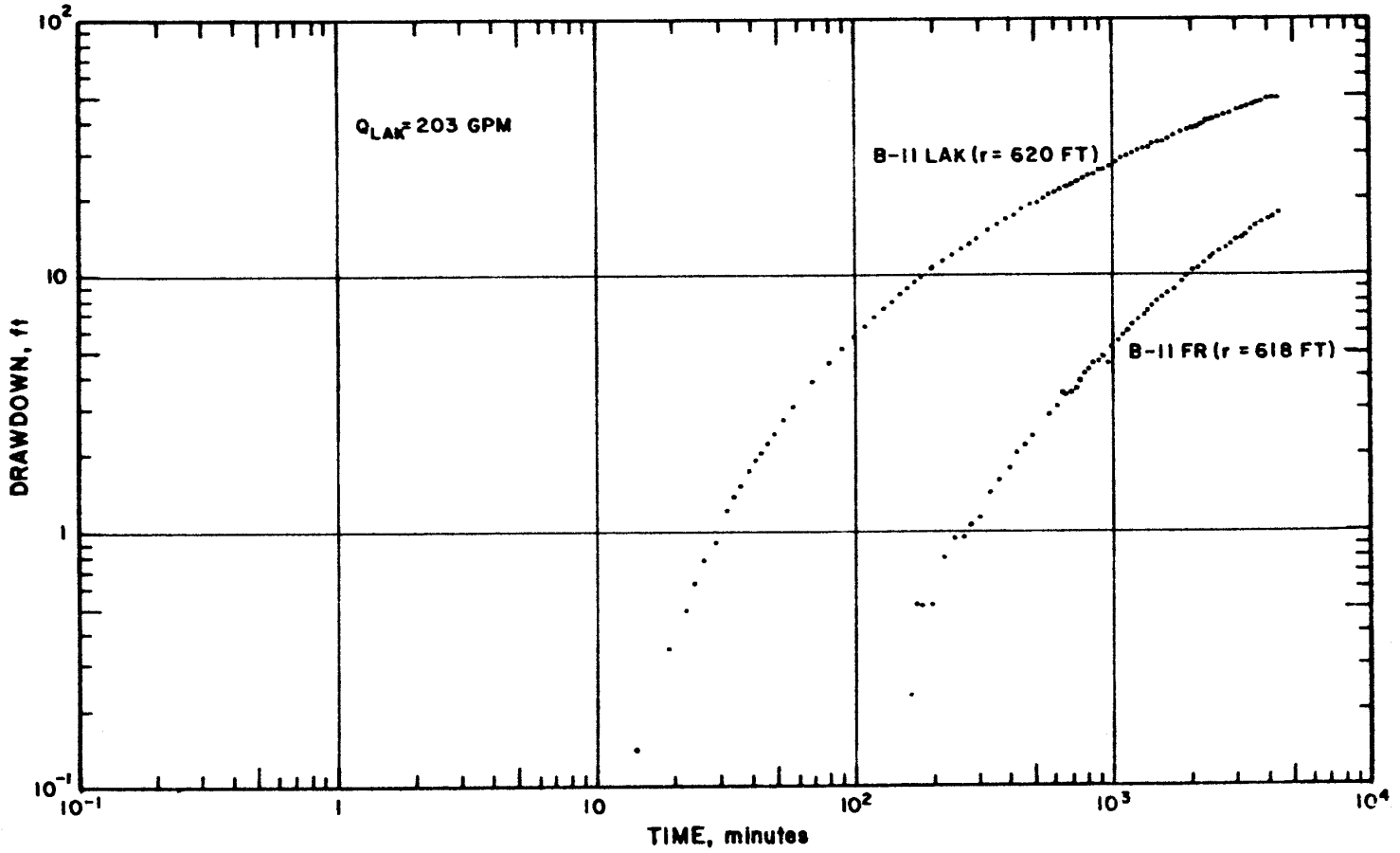

Figure 15: Logarithmic Graphs of Drawdown for B-II Observation Well Group, Lakota Aquifer Test

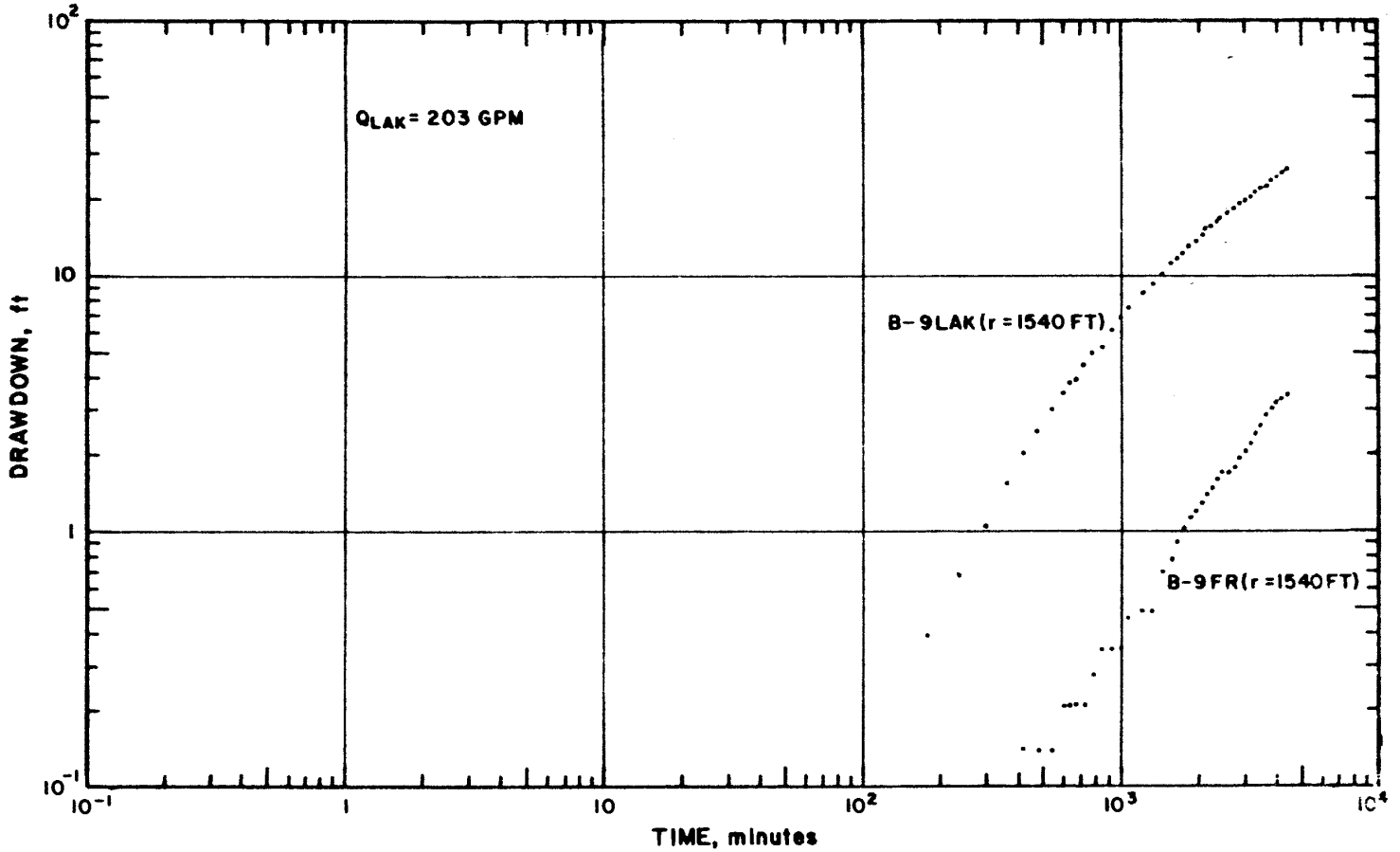

Figure 16 : Logarithmic Graphs of Drawdown for B-9 Observation Well Group, Lakota Aquifer Test

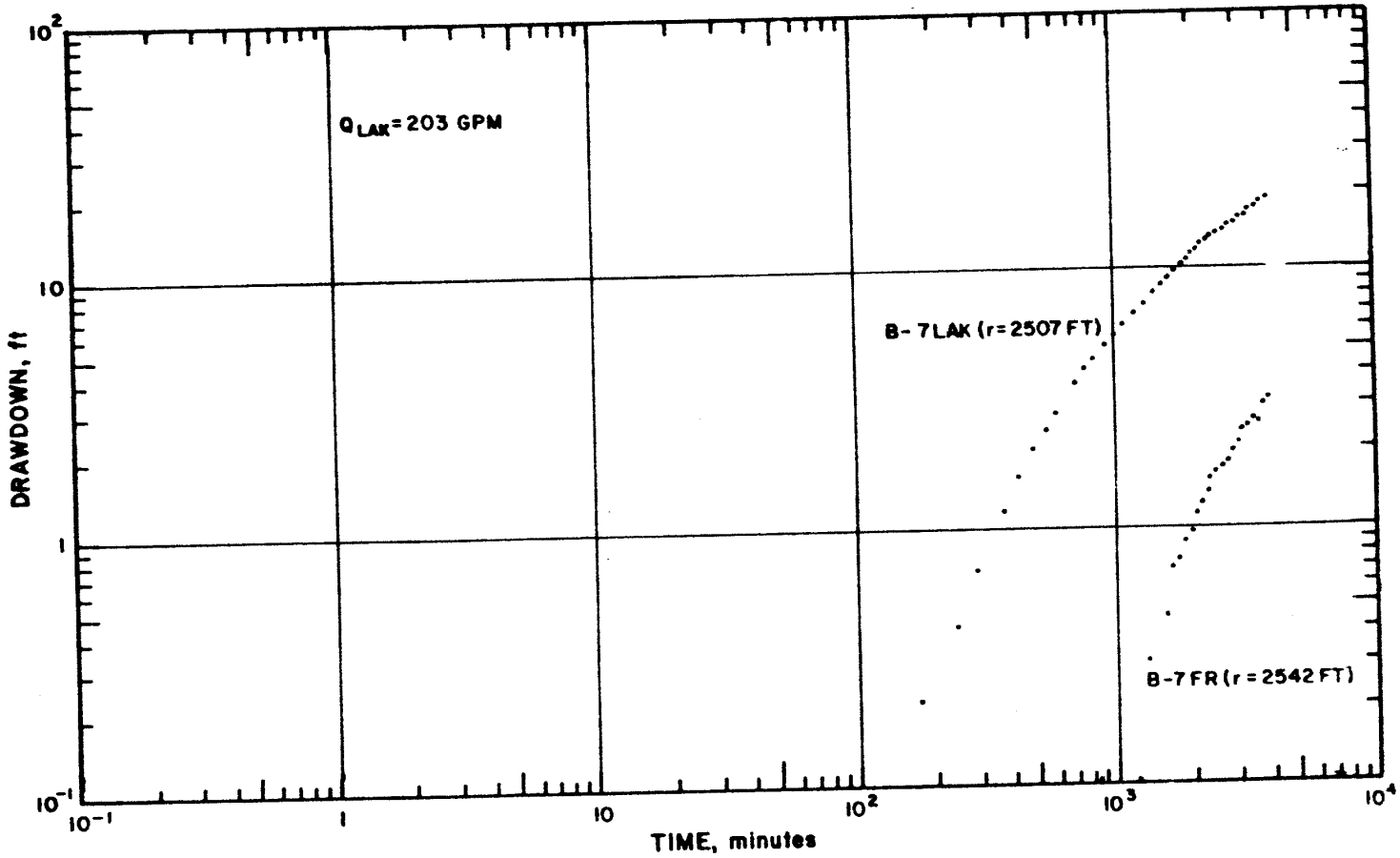

Figure 17 : Logarithmic Graphs of Drawdown for B-7 Observation Well Group, Lakota Aquifer Test

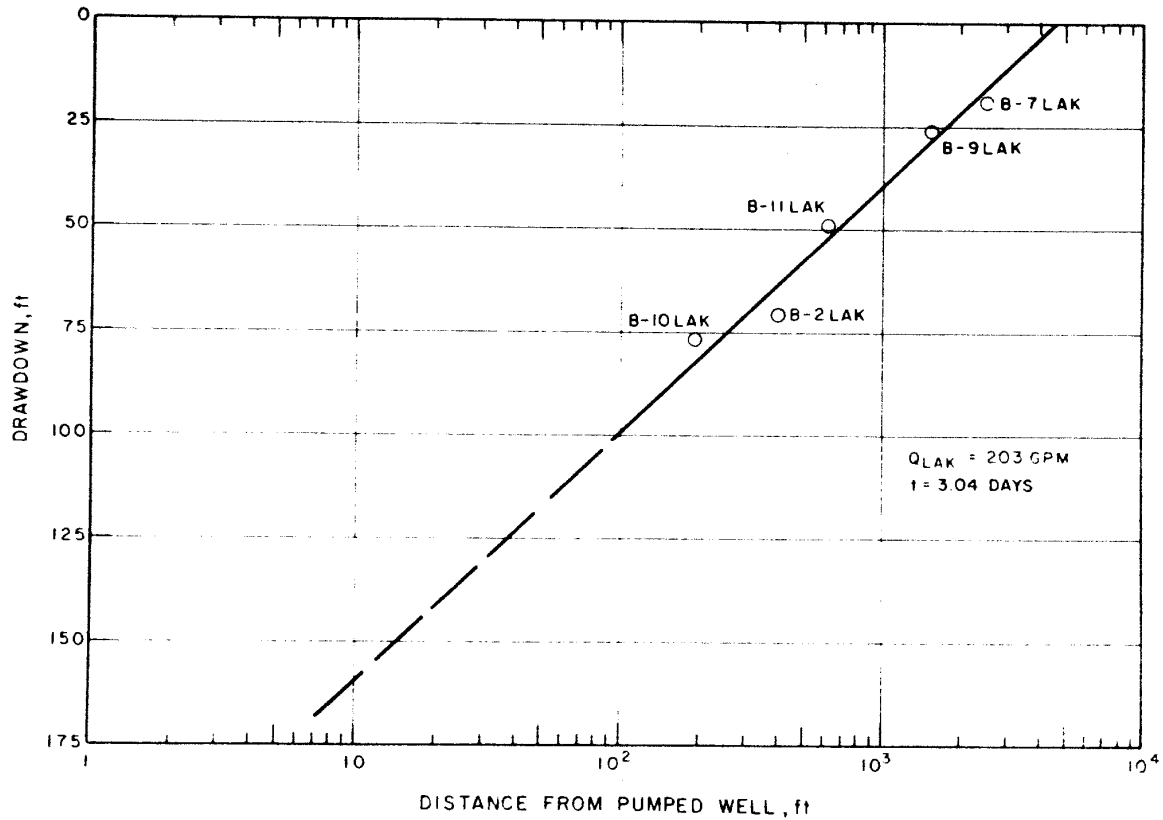

Figure 18 : Semilogarithmic Graph of Distance vs. Drawdown at End of Pumping Test, Lakota Aquifer Test

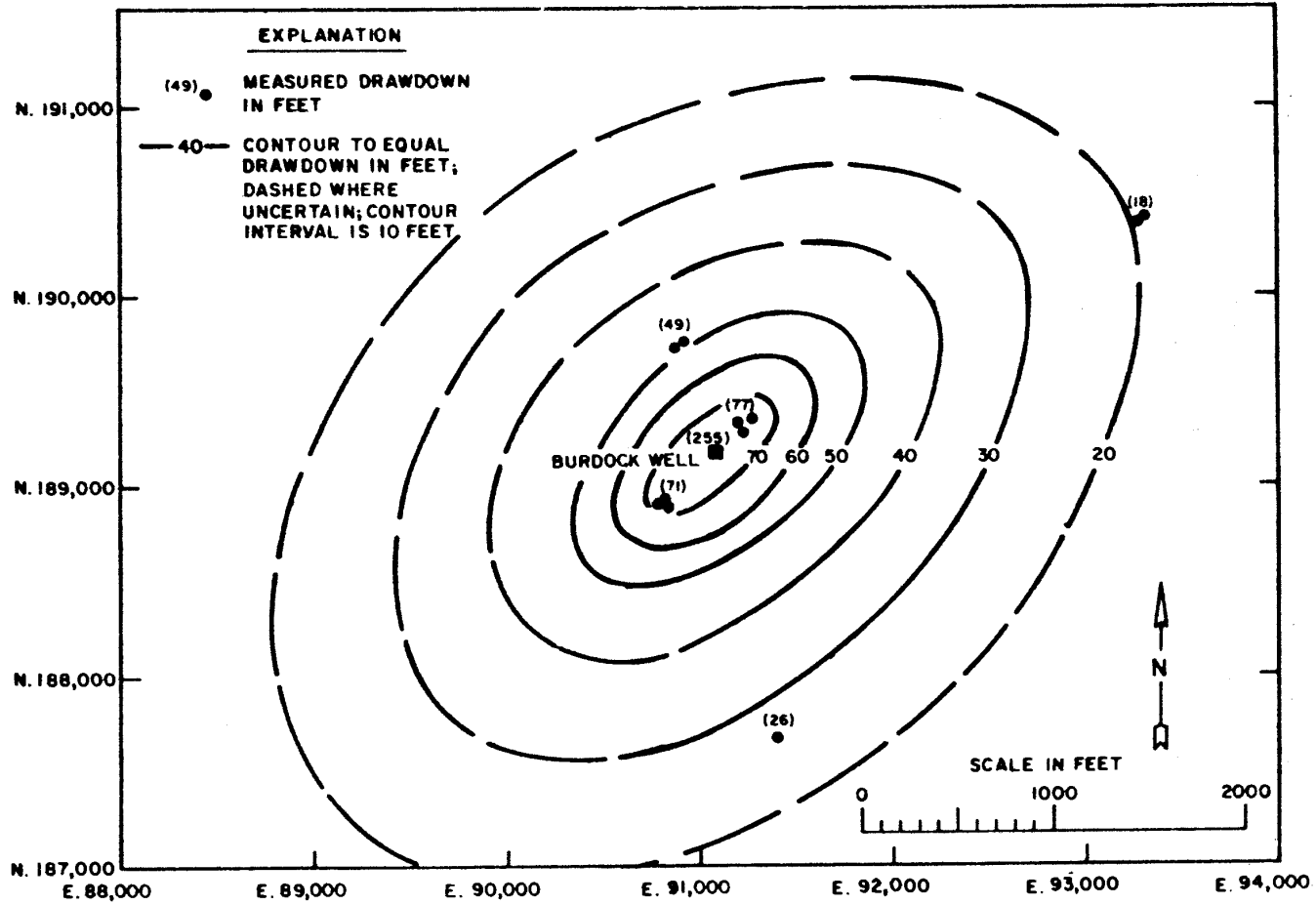

Figure 19 : Drawdown in Lakota Aquifer at End of Lakota Test



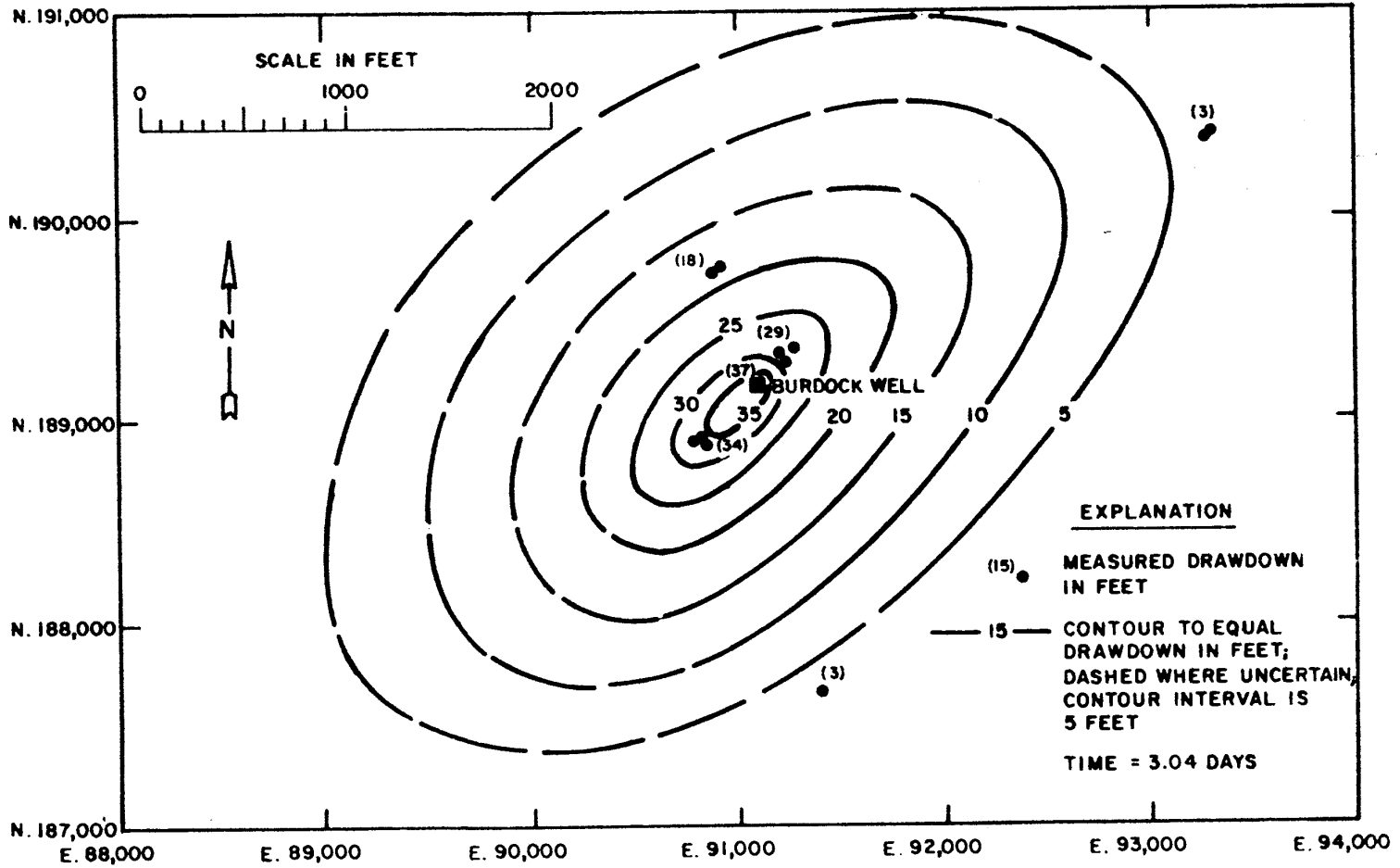

Figure 20 : Drawdown in Fall River Aquifer at End of Lakota Test

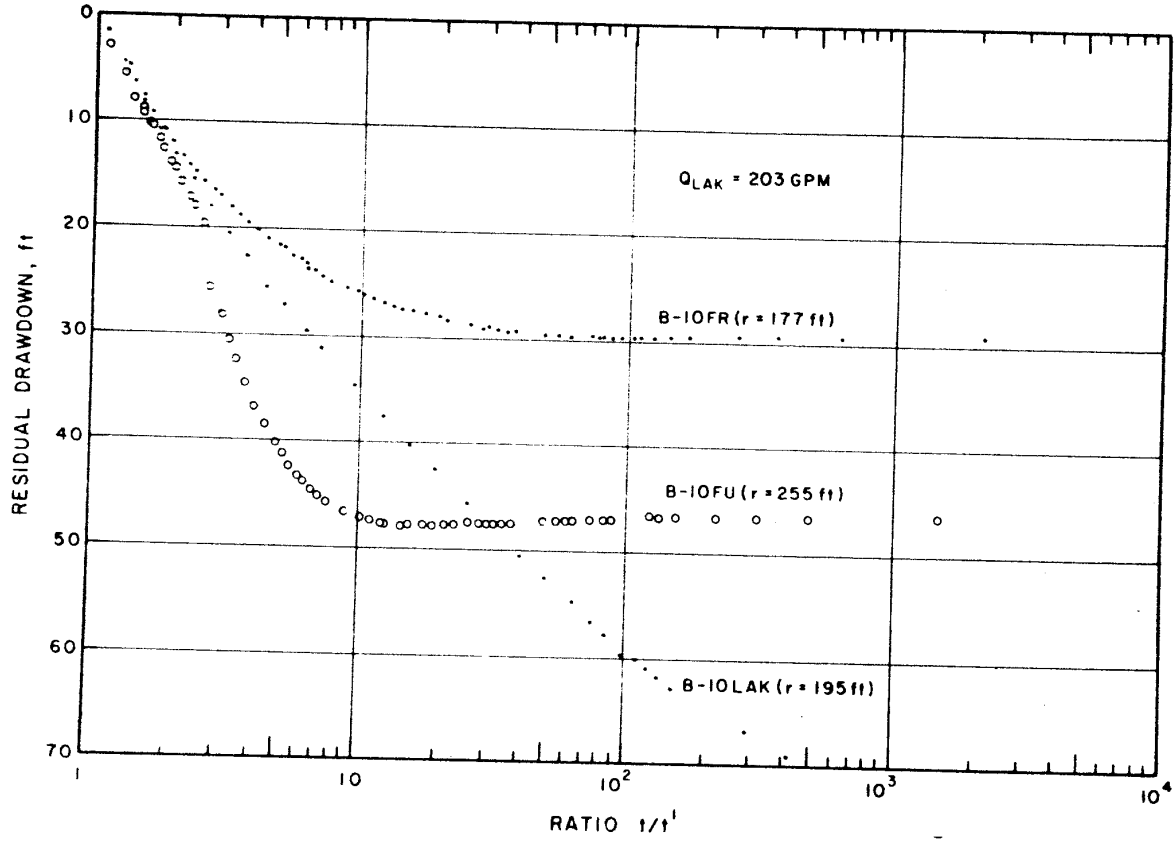

Figure 21: Recovery Graphs for B-10 Observation Well Group, Lakota Aquifer Test

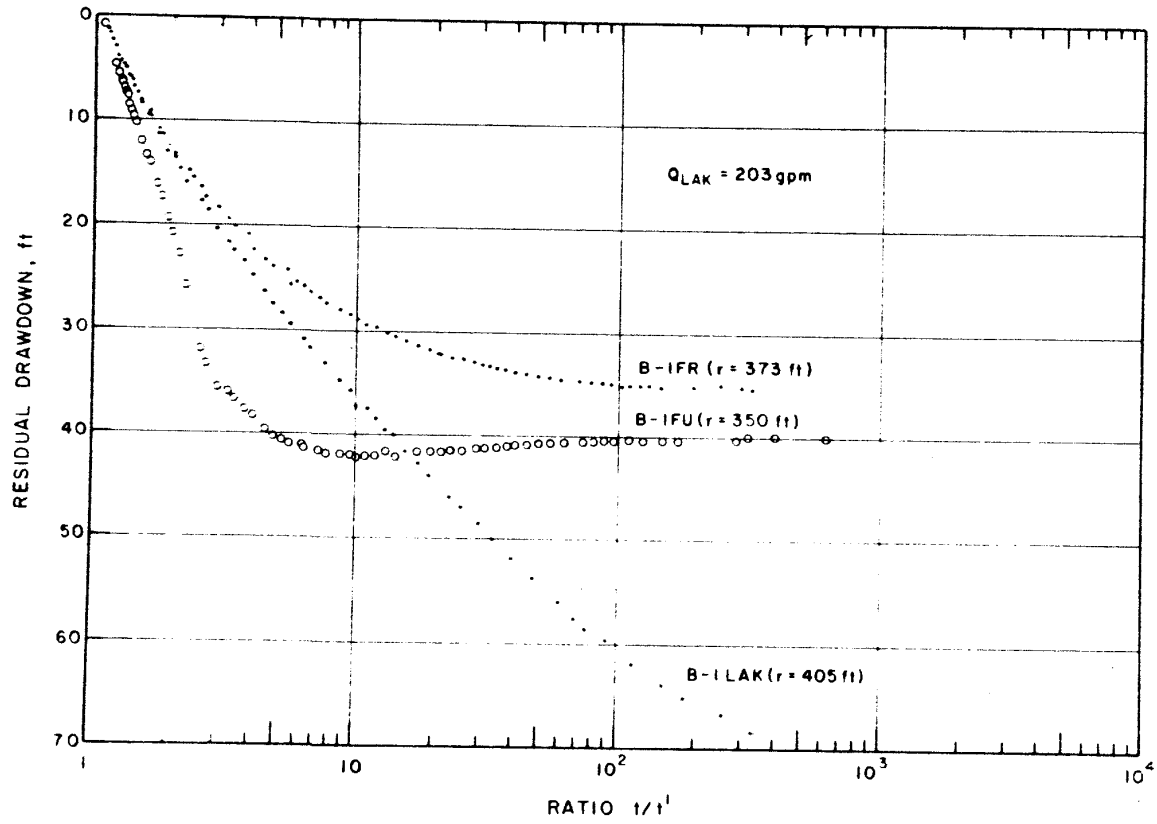

Figure 22: Recovery Graphs for B-I Observation Well Group, Lakota Aquifer Test

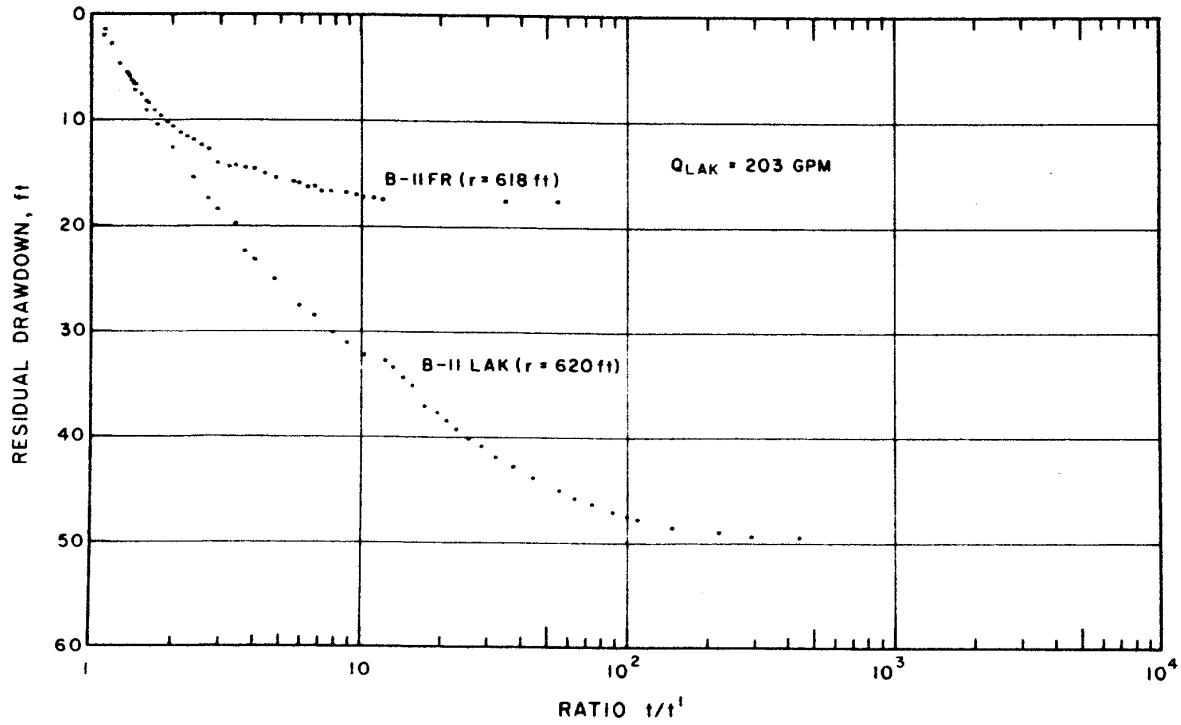

Figure 23: Recovery Graphs for B-II Observation Well Group, Lakota Aquifer Test

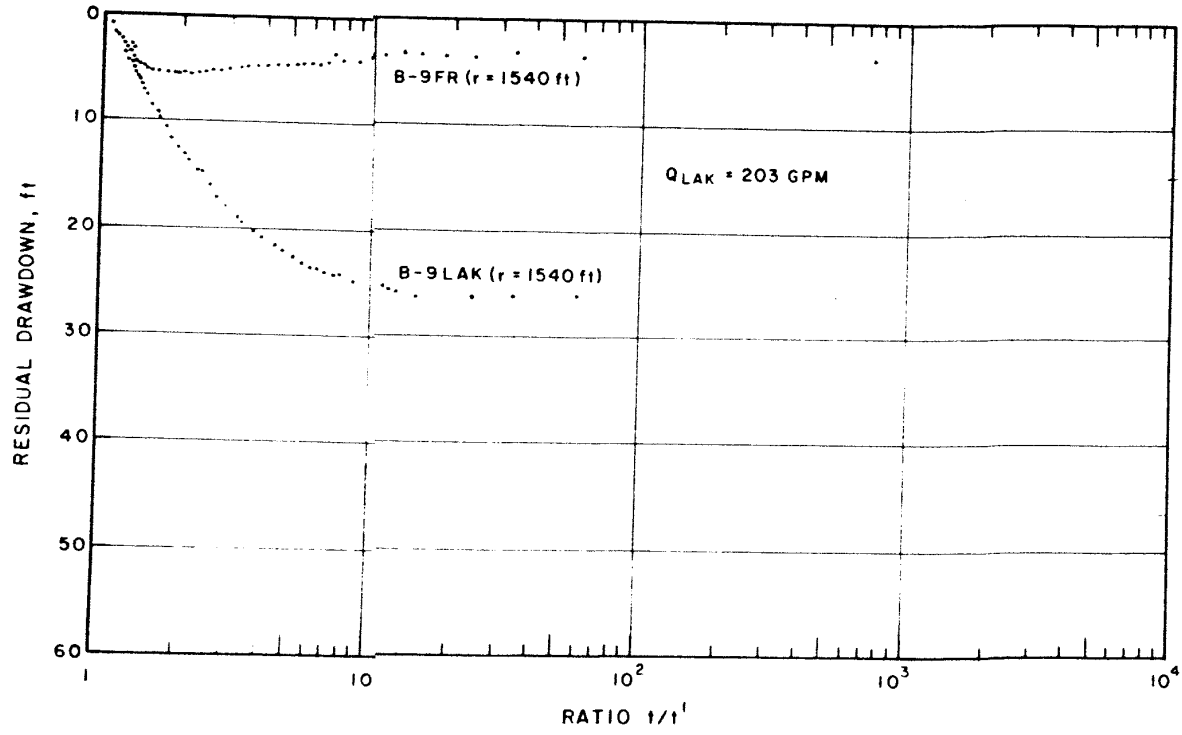

Figure 24 Recovery Graphs for B-9 Observation Well Group, Lakota Aquifer Test

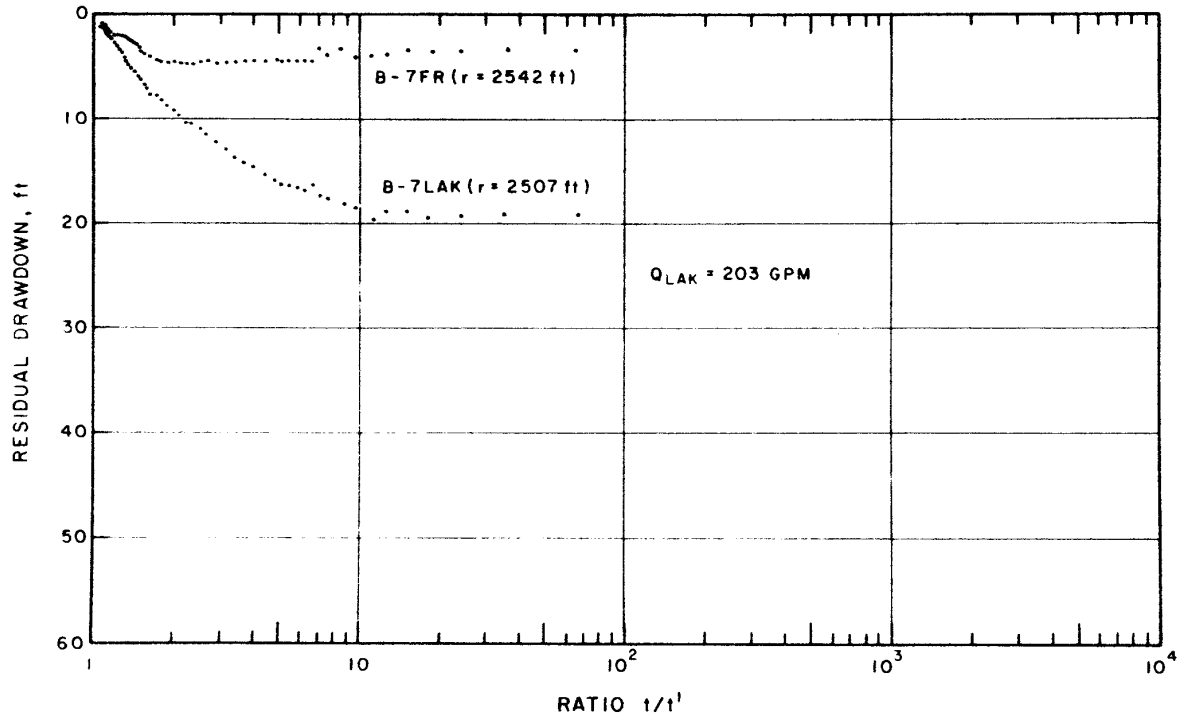

Figure 25: Recovery Graphs for B-7 Observation Well Group, Lakota Aquifer Test

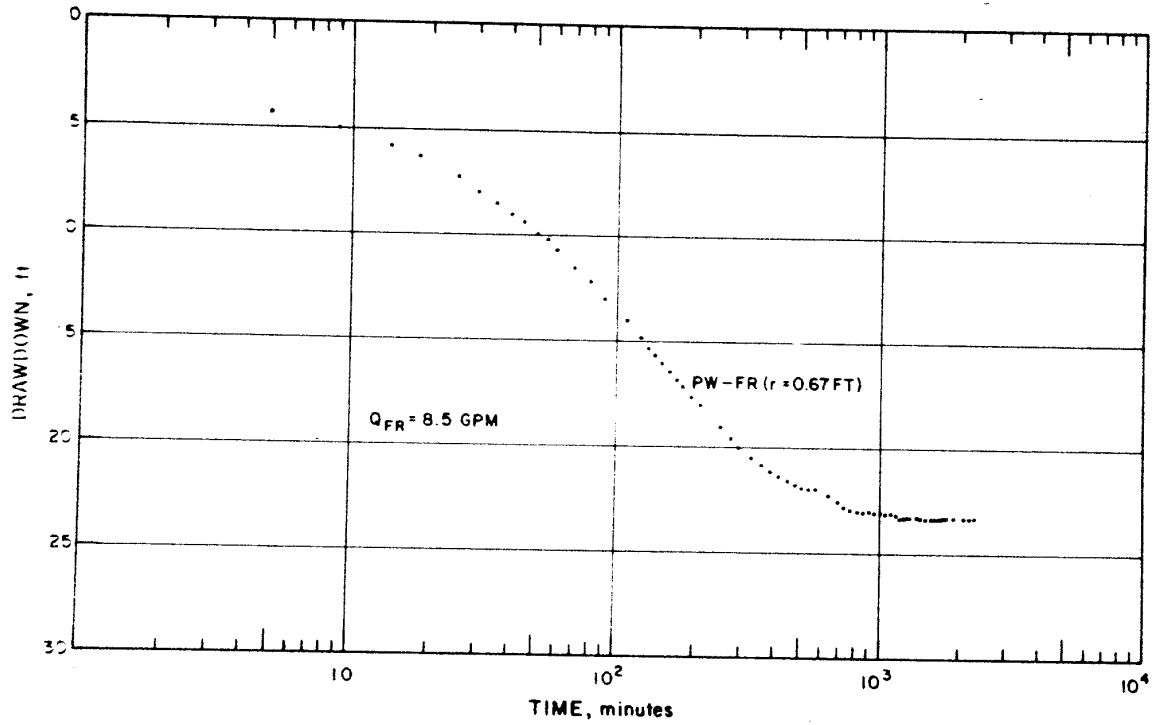

Figure 26: Semilogarithmic Graph of Drawdown for the Pumped Well, Fall River Aquifer Test

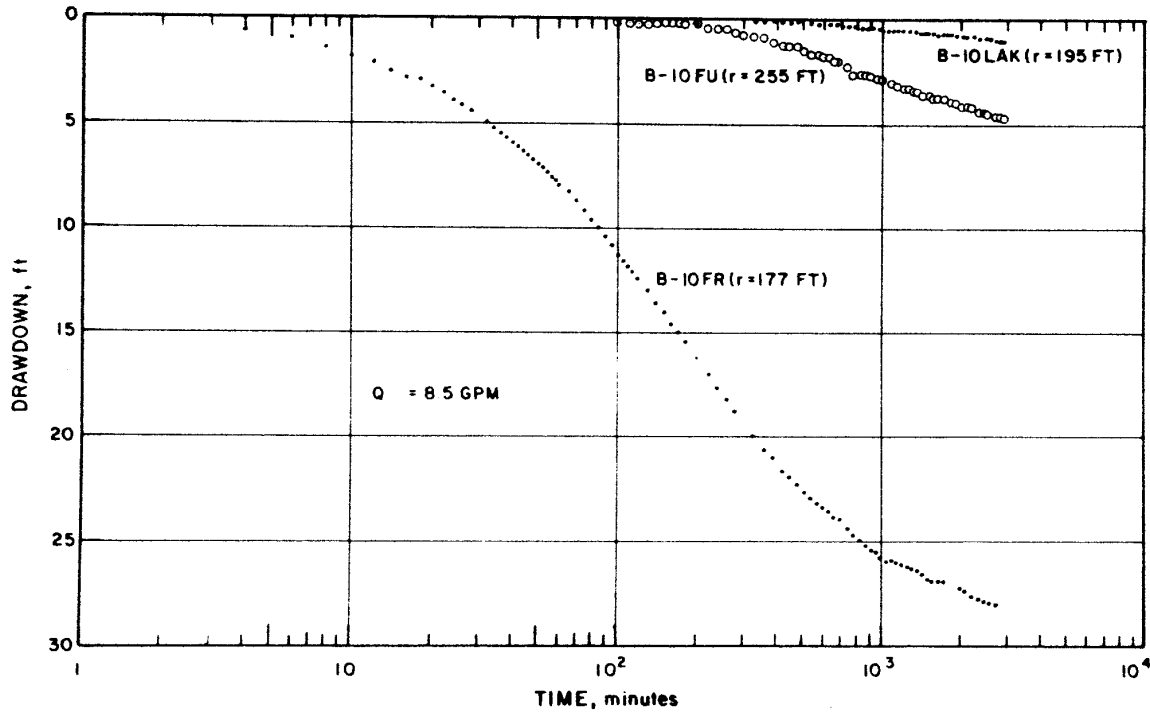

Figure 27: Semilogarithmic Graphs of Drawdown for B-10 Observation Well Group, Fall River Aquifer Test



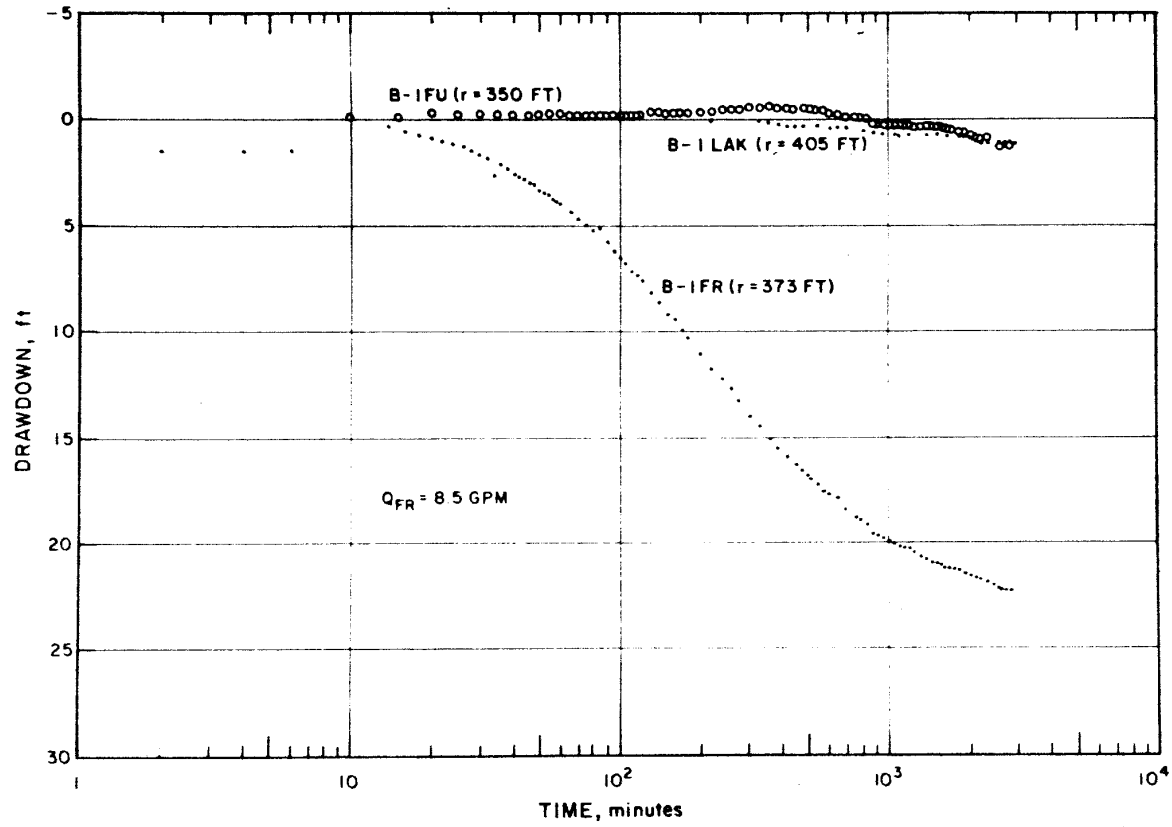

Figure 28 : Semilogarithmic Graphs of Drawdown for B-I Observation Well Group, Fall River Aquifer Test

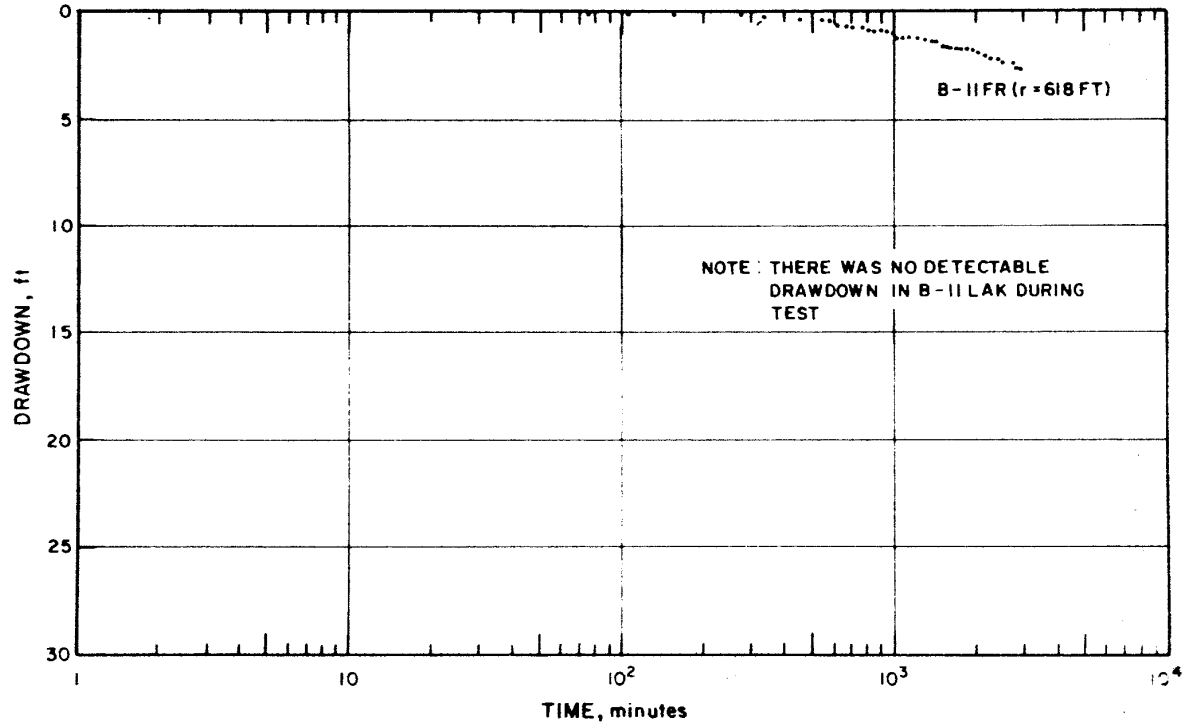

Figure 29: Semilogarithmic Graph of Drawdown for B-II Observation Well Group, Fall River Aquifer Test

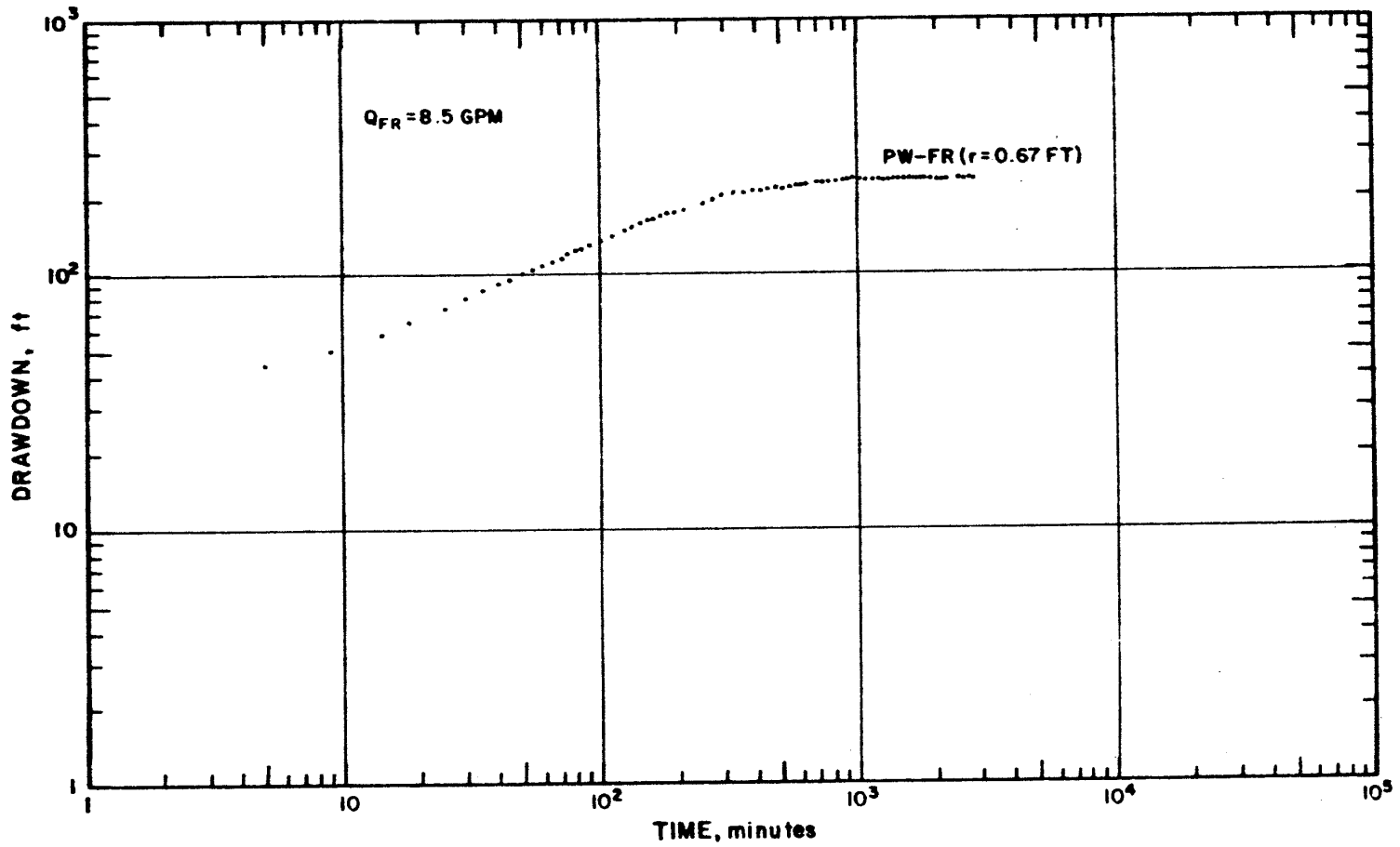

Figure 30: Logarithmic Graph of Drawdown for Pumped Well, Fall River Aquifer Test

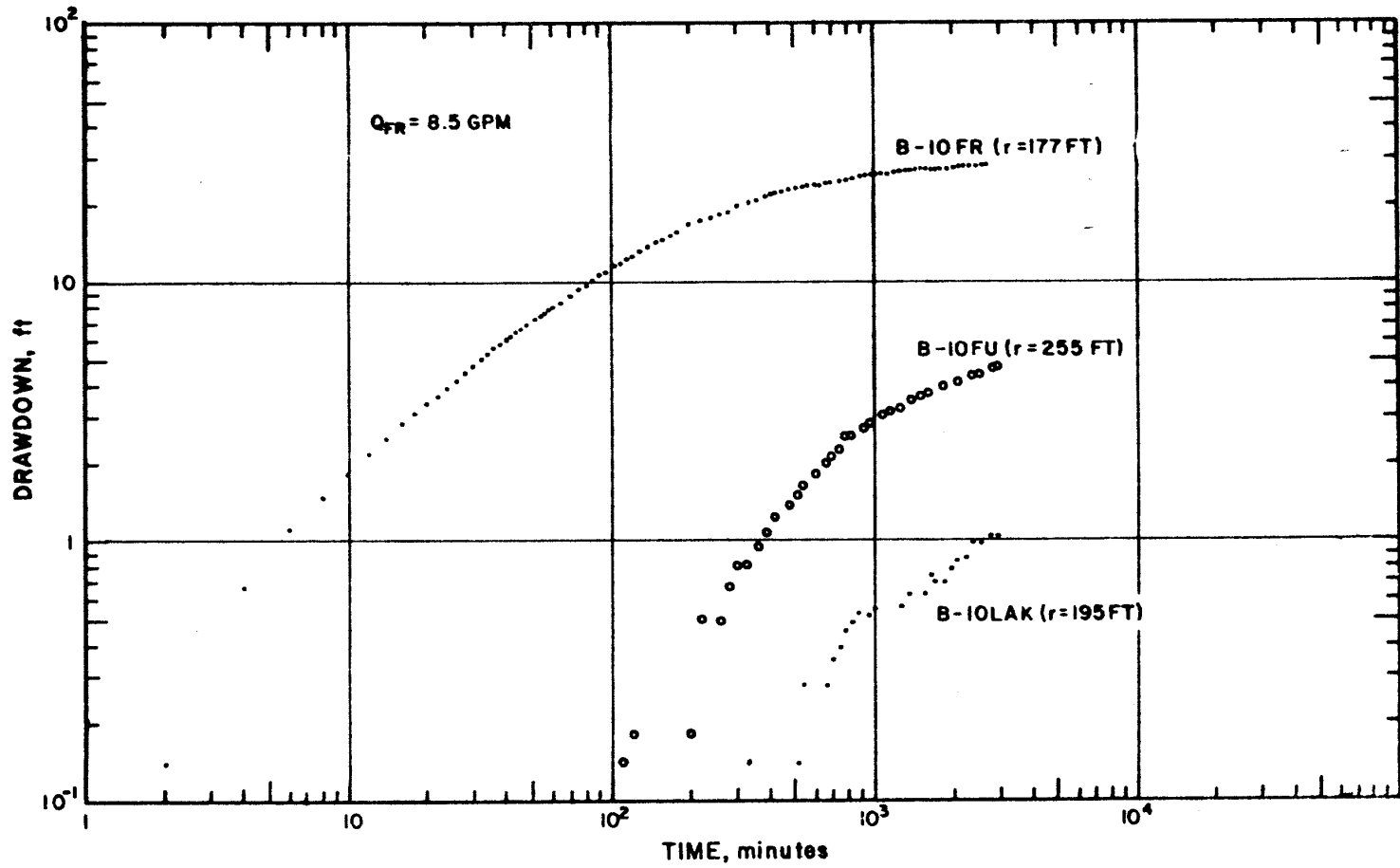

Figure 31: Logarithmic Graphs of Drawdown for B-10 Observation Well Group, Fall River Aquifer Test

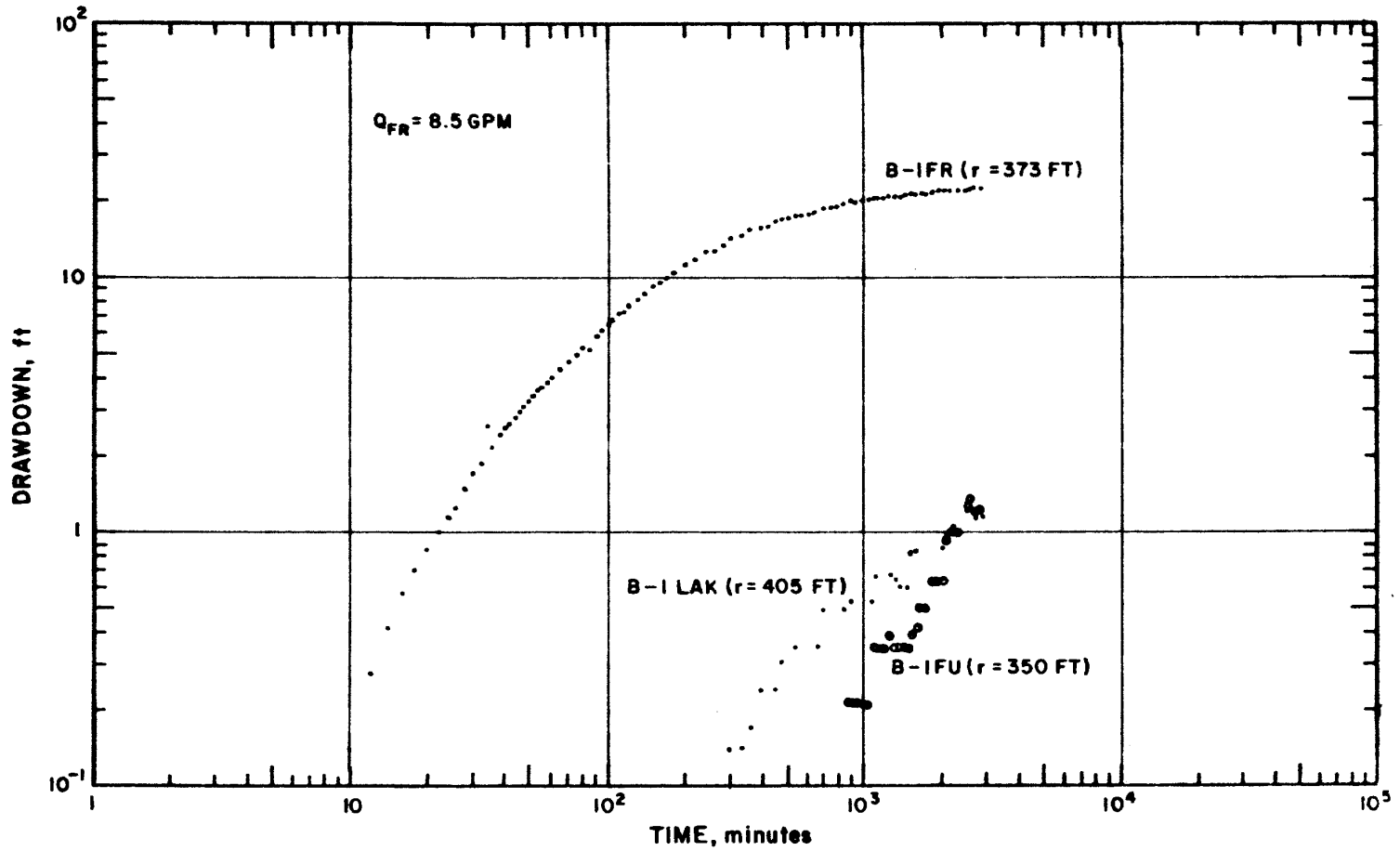

Figure 32: Logarithmic Graphs of Drawdown for B-1 Observation Well Group, Fall River Aquifer Test

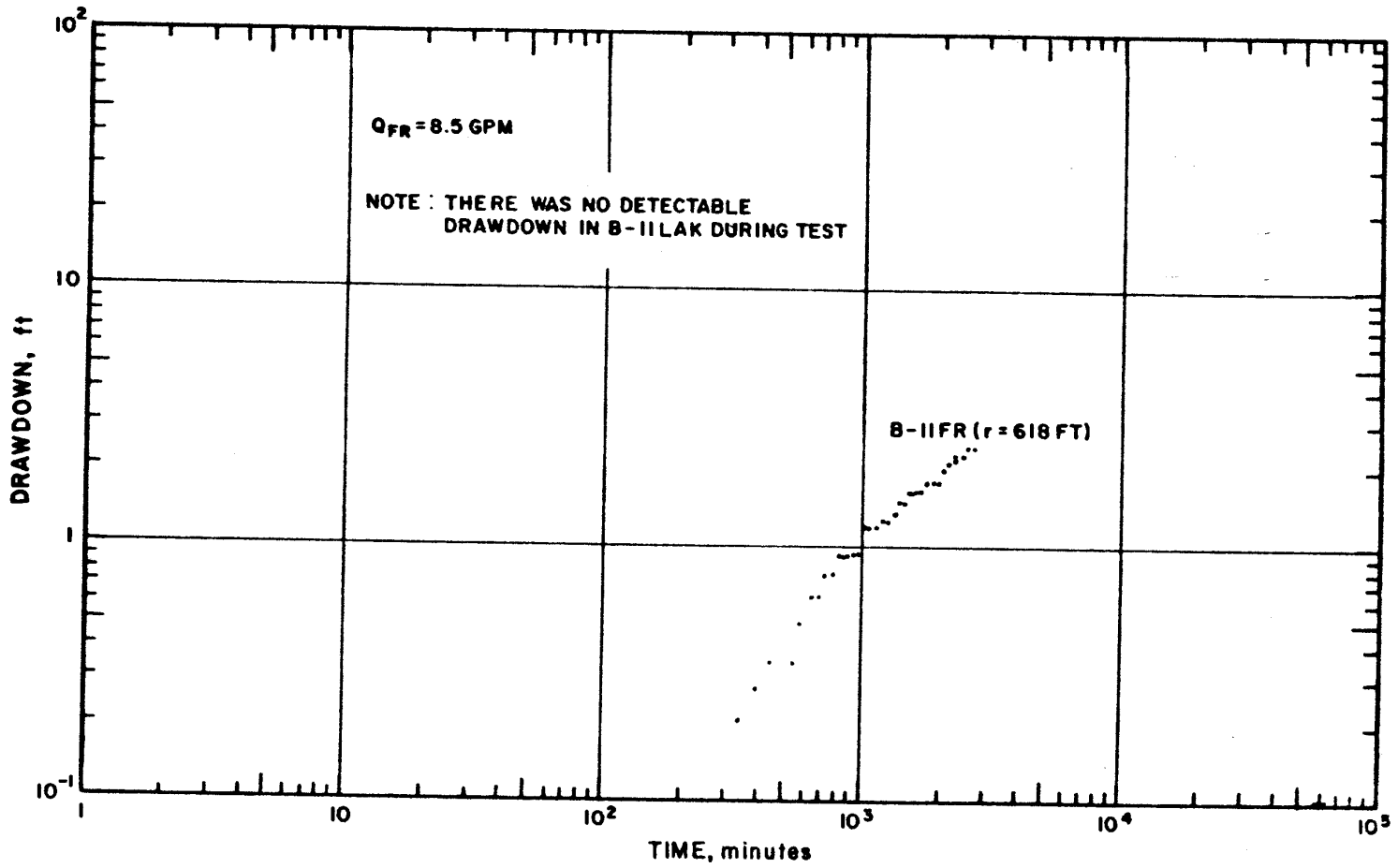

Figure 33: Logarithmic Graphs of Drawdown for B-II Observation Well Group, Fall River Aquifer Test

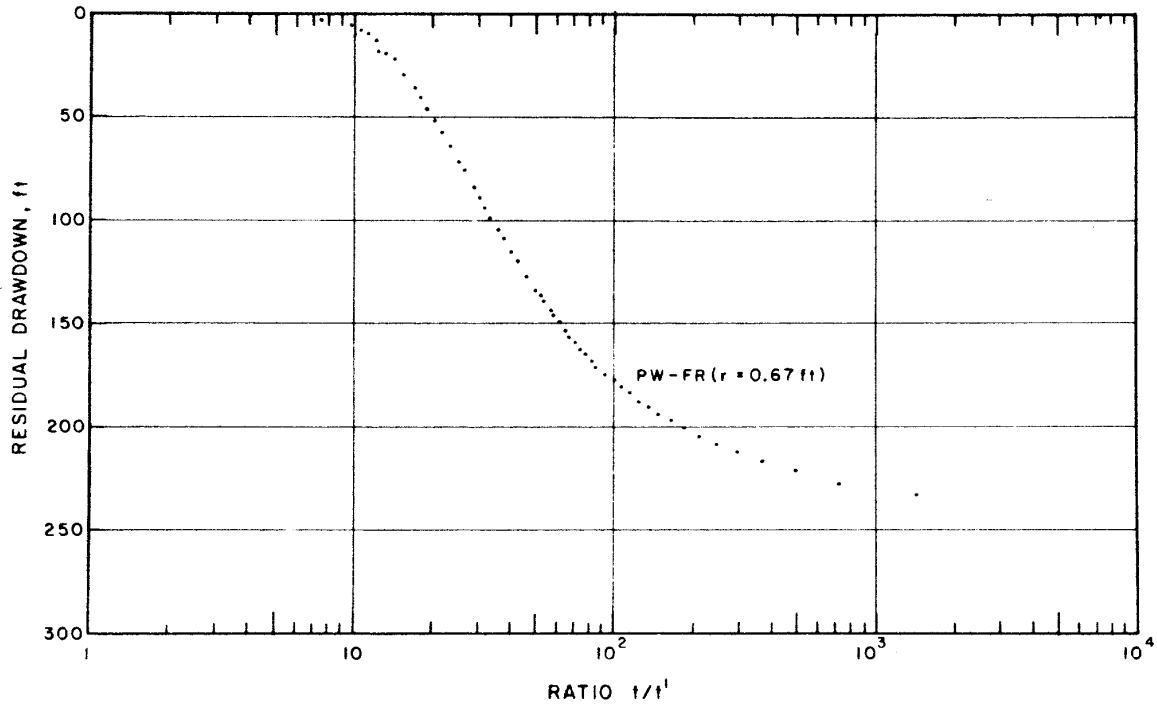

Figure 34: Recovery Graph for Pumped Well, Fall River Aquifer Test

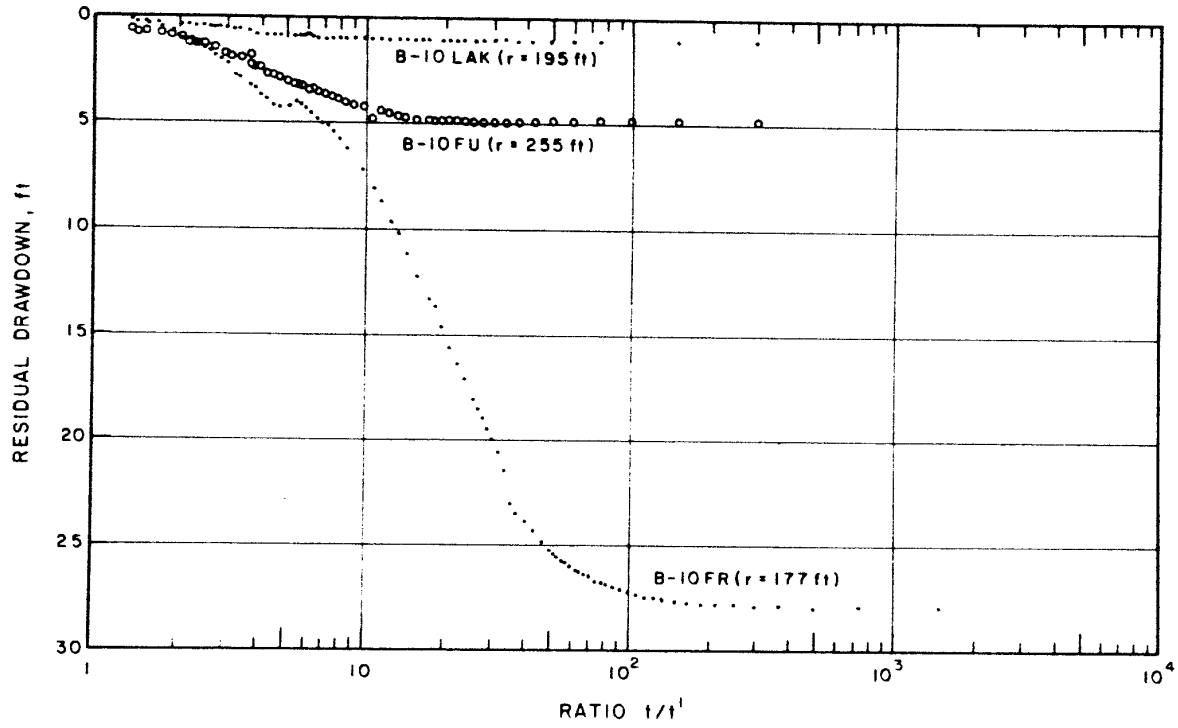

Figure 35: Recovery Graphs for B-10 Observation Well Group, Fall River Aquifer Test



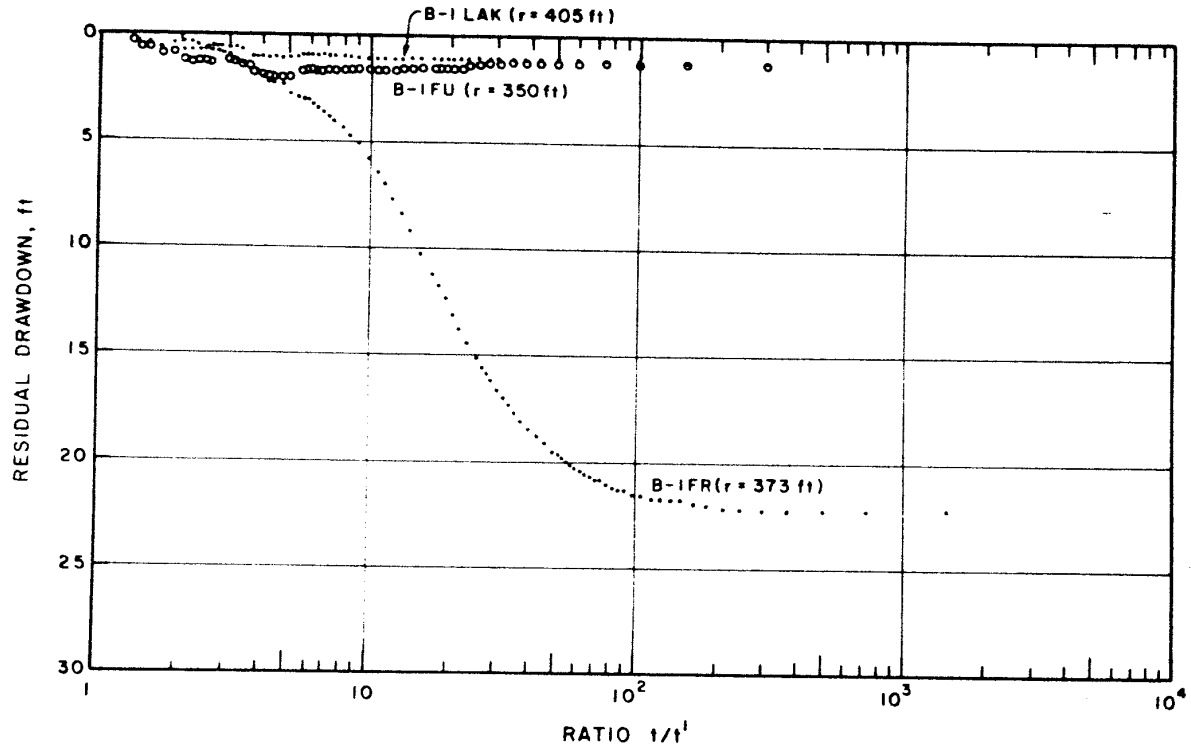

Figure 36: Recovery Graphs for B-1 Observation Well Group, Fall River Aquifer Test

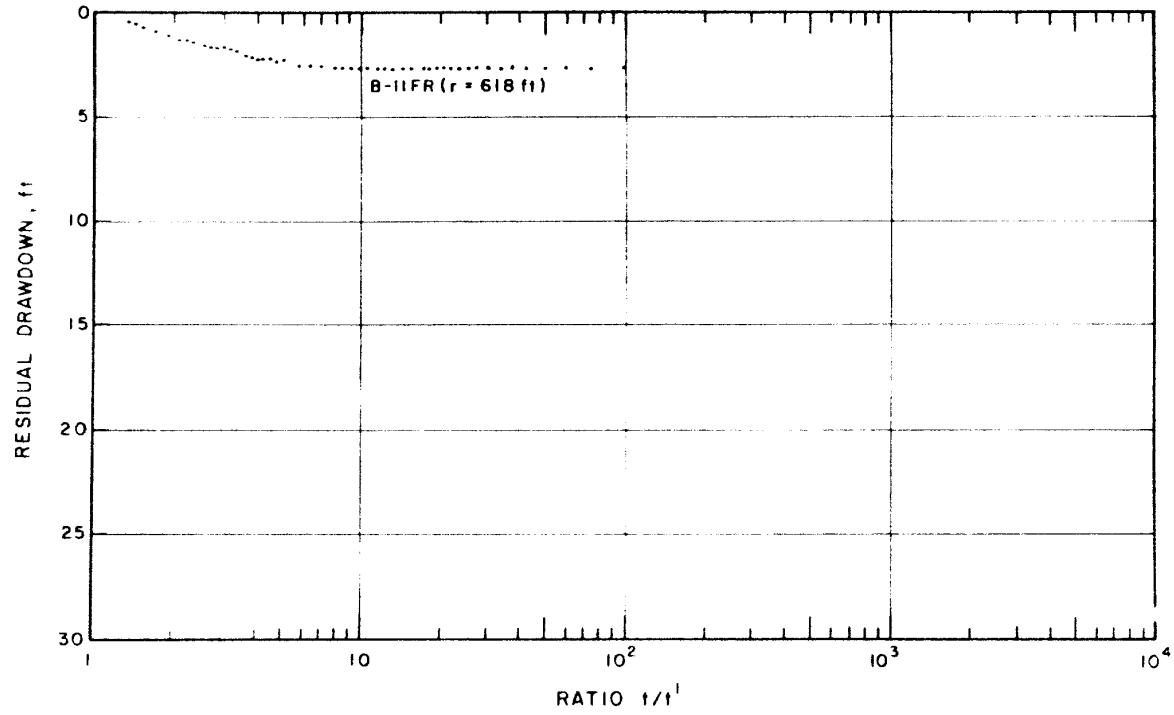

Figure 37 Recovery Graph for B-II Observation Well Group, Fall River Aquifer Test

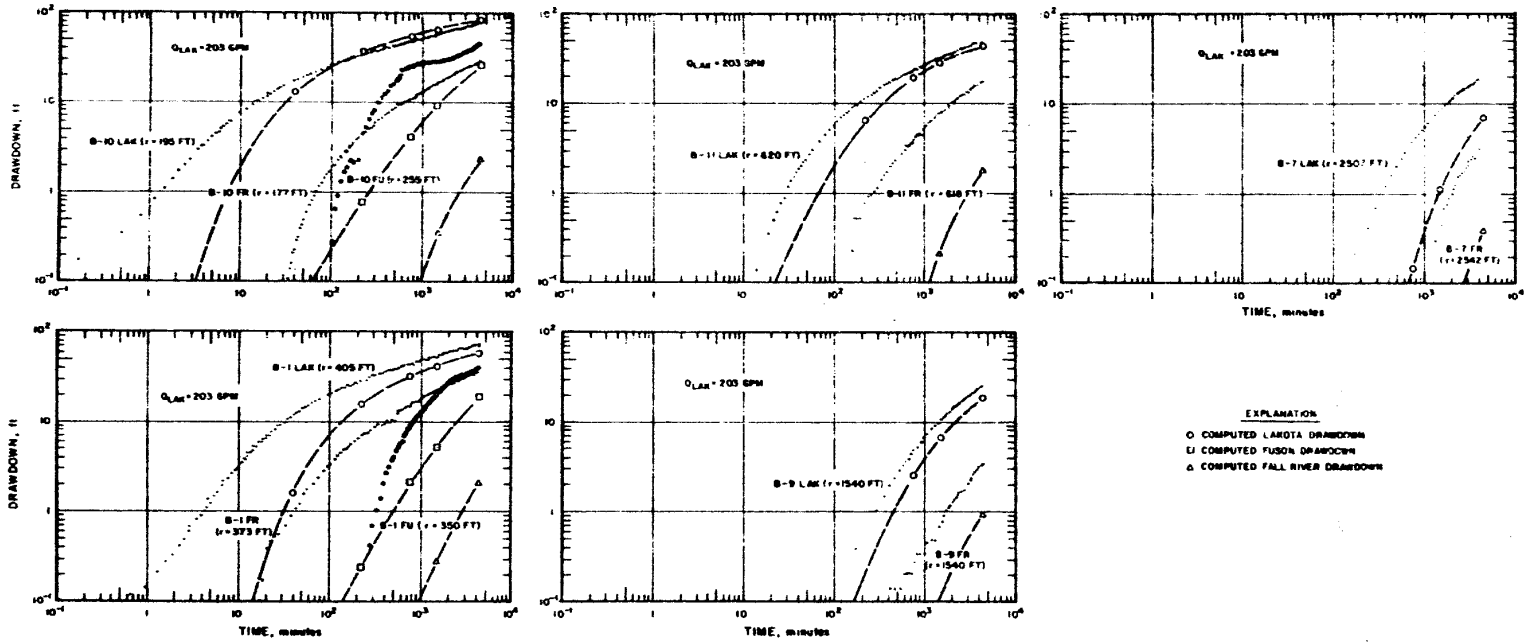

Figure 38 : Results of Initial Lakota Aquifer Test Simulation

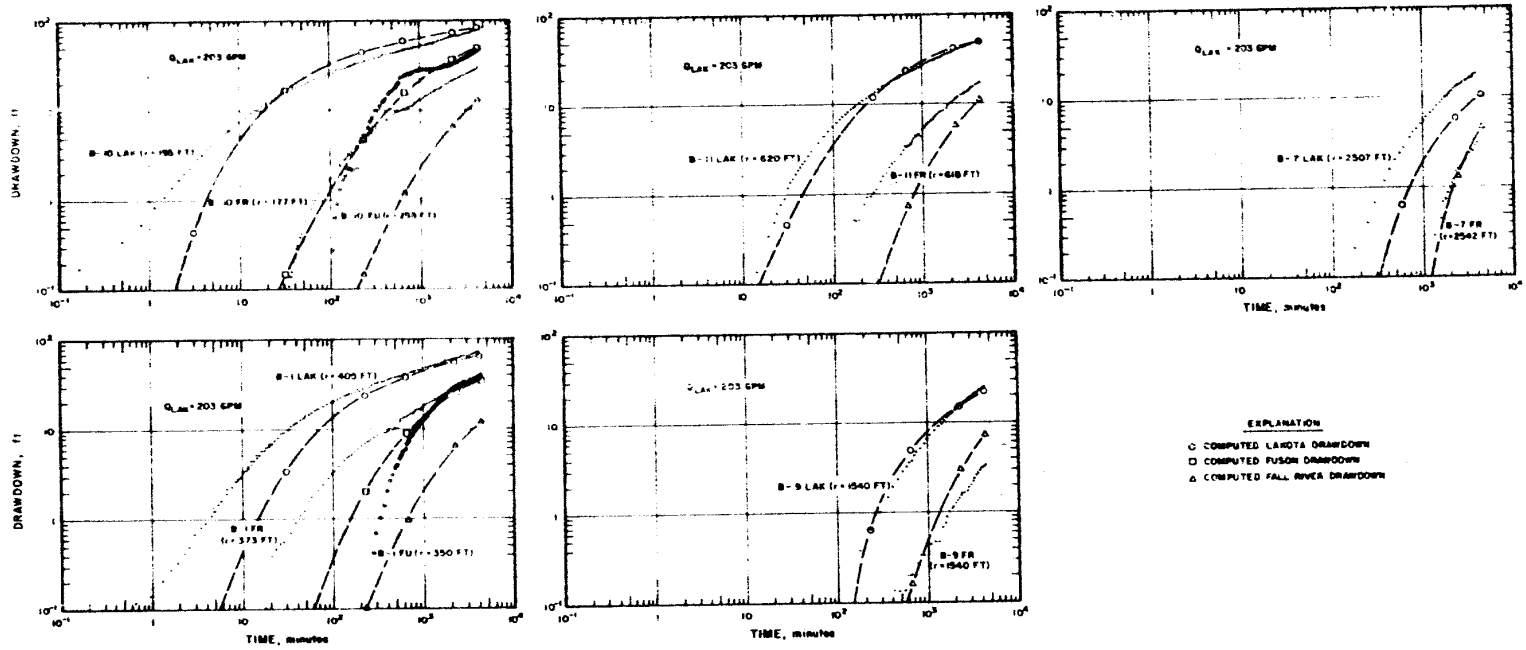
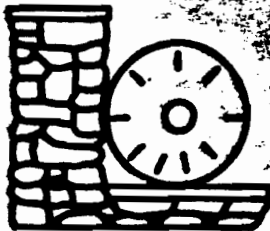

Figure 39 : Results of Final Lakota Aquifer Test Simulation

**WR28-2-520-128**

**HYDROGEOLOGIC INVESTIGATIONS  
AT PROPOSED URANIUM MINE  
NEAR DEWEY, SOUTH DAKOTA**

**RECEIVED**  
Division of Fuels  
**FEB 09 1984**  
Operations Research Center



**TENNESSEE VALLEY AUTHORITY  
OFFICE OF NATURAL RESOURCES  
DIVISION OF AIR AND WATER RESOURCES  
WATER SYSTEMS DEVELOPMENT BRANCH  
NORRIS, TENNESSEE**

Tennessee Valley Authority  
Office of Natural Resources  
Division of Air and Water Resources  
Water Systems Development Branch

HYDROGEOLOGIC INVESTIGATIONS AT  
PROPOSED URANIUM MINE NEAR  
DEWEY, SOUTH DAKOTA

Report No. WR28-2-520-128

Prepared by  
J. Mark Boggs  
Norris, Tennessee  
October 1983

ABSTRACT

The Lakota and Fall River Formations represent aquifers of major importance in the Southern Black Hills Region as well as host rock for uranium ore. An 11-day constant discharge test involving 13 observation wells and numerous private wells was conducted in the Lakota aquifer at TVA's proposed uranium mine near Dewey, South Dakota. The pumping phase of the test was followed by several months of water-level recovery measurements. Results indicate that the test site is located in an area where the Lakota is exceptionally permeable having a transmissivity of 4,400 gpd/ft and a storativity of about  $1 \times 10^{-4}$ . Outside of this locality the Lakota transmissivity decreases substantially due to aquifer thinning and a change to finer-grained sedimentary facies. The drawdown response in the Fall River aquifer was substantially less than that observed during a similar test conducted at TVA's proposed Burdock mine, indicating that the Fuson shale unit lying between the two aquifers is a more effective aquitard in the Dewey area. It is further concluded that the nearby Dewey fault acts as a barrier to horizontal ground-water movement in the Lakota and Fall River aquifers.

CONTENTS

	<u>Page</u>
Abstract . . . . .	i
Introduction . . . . .	1
Hydrogeologic Environment . . . . .	1
Lakota Aquifer Test . . . . .	4
Design . . . . .	4
Procedures . . . . .	6
Analysis . . . . .	8
Interpretation . . . . .	10
Computer Simulations . . . . .	13
Conclusions . . . . .	20
Recommendations for Future Ground-Water Impact Assessment . . .	22
References . . . . .	24
Appendix A Semilogarithmic Time-Drawdown Graphs . . . . .	25
Appendix B Logarithmic Time-Drawdown Graphs . . . . .	35
Appendix C Semilogarithmic Time-Residual Drawdown Graphs. . .	45

FIGURES

1. Site Location and Potentiometric Surface Map . . . . .	2
2. Well Location Map . . . . .	5
3. Distance-Drawdown Graph . . . . .	11
4. Ground-Water Model Grid . . . . .	14
5. Comparison of Observed and Computed Drawdown, Case I. . .	16
6. Transmissivity Distribution, Case II . . . . .	17
7. Comparison of Observed and Computed Drawdown, Case II . .	19

TABLES

1. Well Construction Data . . . . .	7
2. Computed Lakota Aquifer Properties . . . . .	9



## INTRODUCTION

The following report describes a hydrogeologic test conducted February 1982 at TVA's proposed uranium mine shaft site near Dewey, South Dakota (Figure 1). The Dewey test is one of a series of tests TVA has conducted in aquifer units of the Inyan Kara Group in the southwestern Black Hills area. The purpose of these tests is to obtain sufficient quantitative information about local hydrogeologic conditions to enable prediction of mine depressurization requirements and impacts to local ground-water users.

## HYDROGEOLOGIC ENVIRONMENT

The principal aquifers in the region are the alluvial deposits associated with the Cheyenne River and its major tributaries, the Fall River formation, the Lakota formation, the Sundance formation, and the Pahasapa (or Madison) formation. Except for the alluvium, these aquifers crop out peripherally to the Black Hills where they receive recharge from precipitation. Ground-water movement is in the direction of dip, radially from the central Black Hills. In most instances, ground water in these aquifers is under artesian conditions away from the outcrop area, and water flows at ground surface from numerous wells in the area.

The Fall River and Lakota formations which form the Inyan Kara Group are the most widely used aquifers in the region. The alluvium is used locally as a source of domestic and stock water. The Sundance formation is used near its outcrop area in central and northwestern Fall River County. The Pahasapa (Madison) formation is locally accessible only by very deep wells and is the source for five wells in the city of Edgemont.

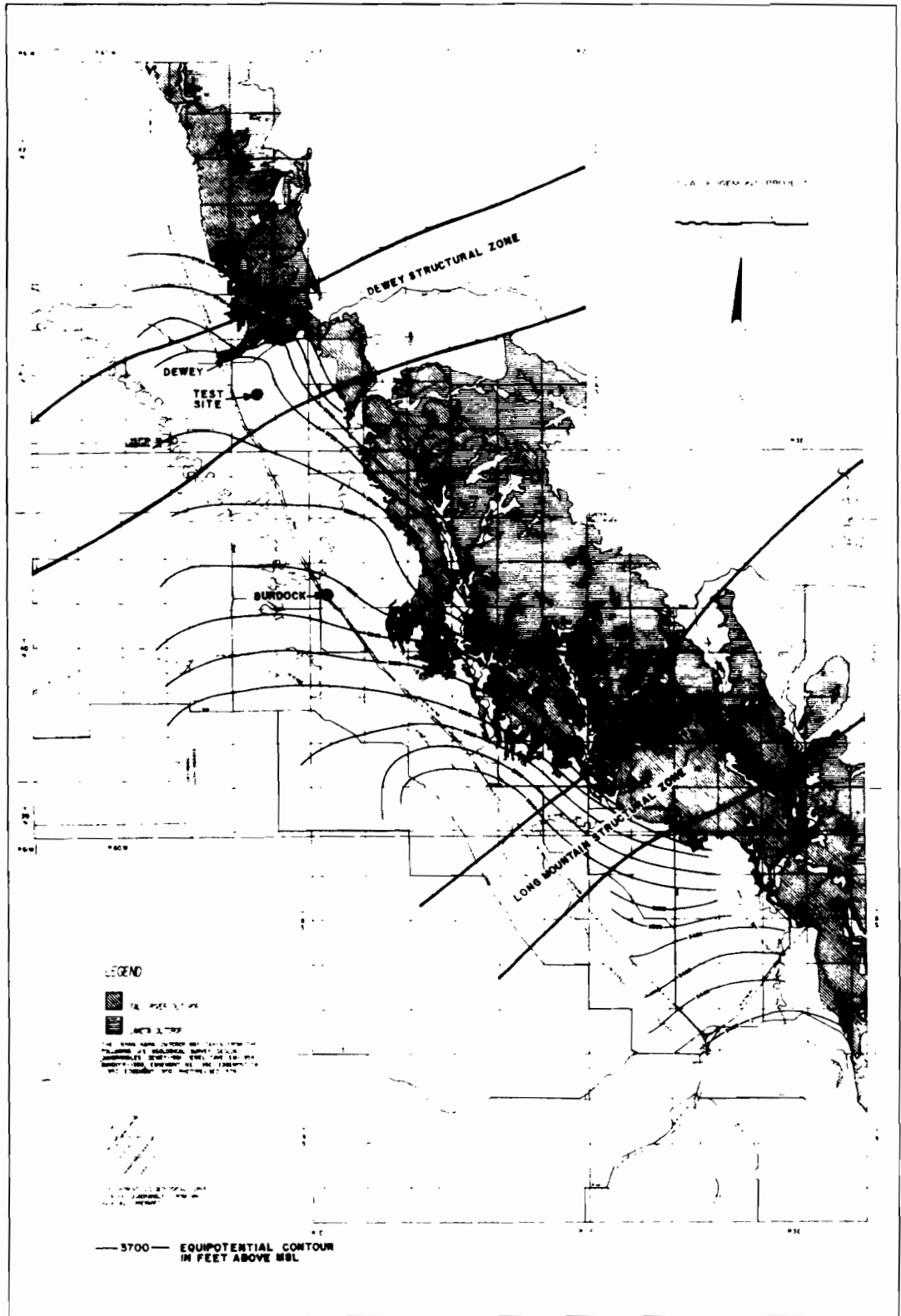

Figure 1: Site Location and Potentiometric Surface Map

IR28-28-2-520-128

The Fall River and Lakota aquifers are of primary concern because of the potential impact of mine dewatering on the numerous wells developed in these aquifers in the vicinity of the mine. At the proposed mine site, the Fall River consists of approximately 180 feet of interbedded fine-grained sandstone, siltstone and carbonaceous shale. The Fall River aquifer is overlain by approximately 400 feet of the Mowry and Skull Creek shales unit, which act as confining beds. Five domestic and stock-watering wells are known to be developed in the Fall River formation within a four-mile radius of the mine site.

The Fall River formation is underlain by Fuson member of the Lakota formation consisting primarily of siltstone and shale with occasional fine-grained sandstone lenses. Thickness of the Fuson is on the order of 100 feet in the site vicinity. The Fuson acts as a leaky aquitard between the Fall River and Lakota aquifers.

The Chilson member of the Lakota formation is the source for some 30 wells within a four-mile radius of the mine site. It also represents the primary uranium-bearing unit targeted for mining. The Chilson (also referred to as the "Lakota aquifer" in this report) consists of about 120 feet of consolidated to semi-consolidated, fine-to-coarse grained sandstone with interbedded siltstone and shale. It is underlain by the Morrison formation consisting of interbedded shale and fine-grained sandstone. Regionally, the Morrison is not considered an aquifer. Under conditions of ground-water withdrawal from the Chilson, the Morrison is expected to act as an aquitard.

Recharge to the Fall River and Lakota aquifers is believed to occur at their outcrop areas. Gott, et al. (1974), suggest on the basis of geochemical data that recharge to these aquifers may also be derived from the upward movement of ground water along solution collapses and breccia

pipes from the deeper Minnelusa and Pahasapa aquifers. The solution collapse and breccia pipe features lie within the Dewey and Long Mountain structural zones (Figure 1).

Inasmuch as the proposed mine site lies only about one mile south of the Dewey fault trace, one of the primary objectives of the test was to determine the hydrologic significance of the fault and its affect on the propagation of drawdown in the vicinity of the mine during depressurization. Vertical displacement on the major fault generally increases toward the southwest, and is on the order of 200 feet at the point where the fault trace crosses the South Dakota-Wyoming border. Thus, it appears that the Fall River and Lakota aquifers are completely offset by the fault in the site vicinity.

### LAKOTA AQUIFER TEST

#### Design

The shaft site for the Dewey mining area had not been selected at the time the aquifer testing designs were made. The test site was, therefore, located in the general vicinity of the proposed mine site within close proximity to the Dewey fault. The test well was completed to a depth of 804 feet and was screened within the Chilson member of the Lakota Formation. A network of eleven observation wells were constructed along two perpendicular lines intersecting at the pumped well for the purpose investigating hydrologic boundary conditions. One line of wells was oriented normal to the Dewey fault trace, and the other was approximately normal to the aquifer outcrop belt to the east (see Figure 2). Seven of these wells were developed in the Chilson member, three in the Fall River formation,

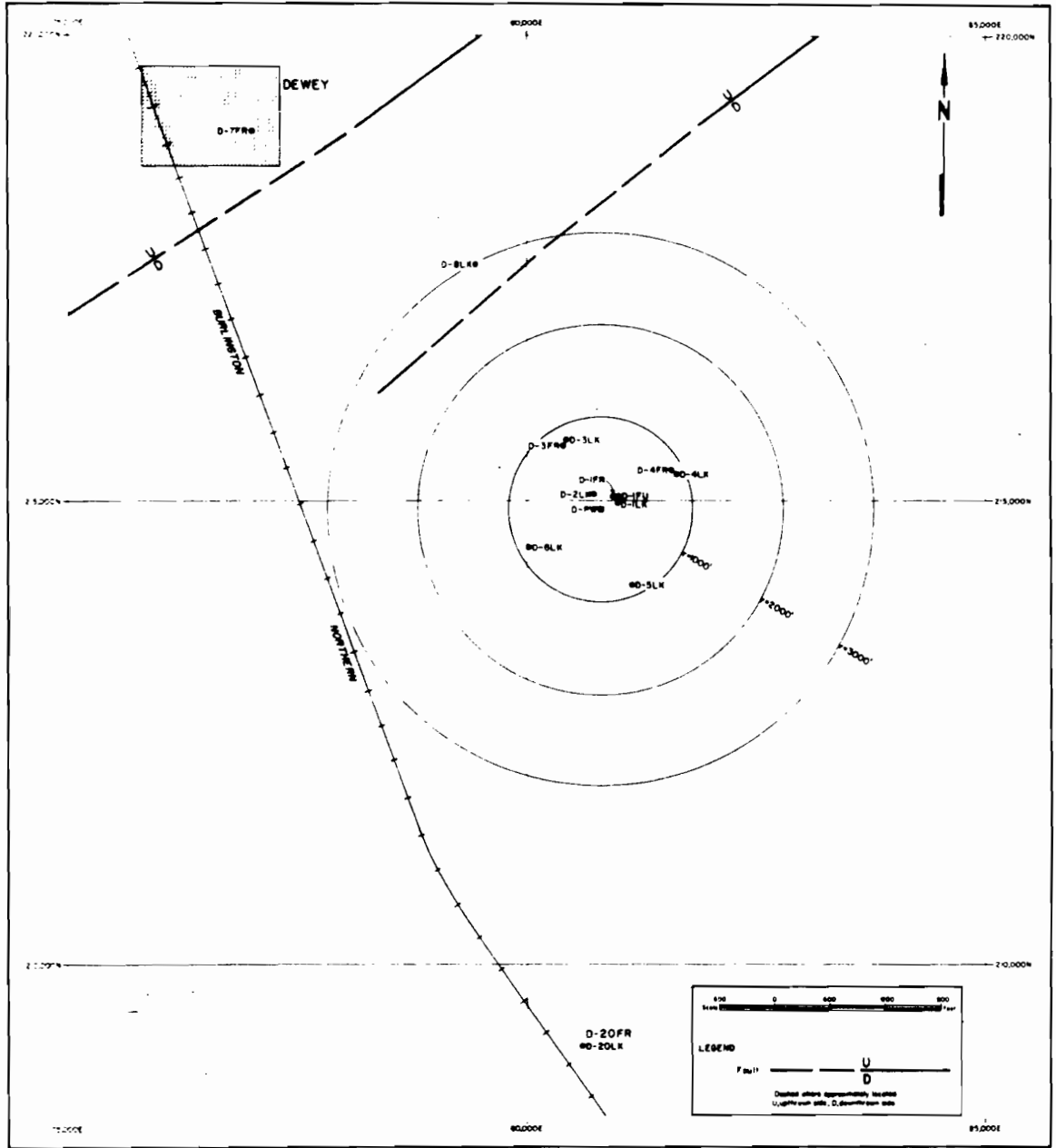

Figure 2: Well Location Map

RZB - 2 - 520 - 128.2

and one in the Fuson. Preexisting observation wells BPZ-20LAK and BPZ-20FR (hereafter referred to as D-20LK and D-20FR, respectively) located about one mile south of the test well were also monitored during the test. Construction details for these wells are given in Table 1. In addition, periodic measurements of water level (or well flowrate) were made during the test at all private wells within the test site vicinity.

Based upon preliminary drilling results in the Dewey test site area and experience from the Burdock aquifer tests, it was expected that the Fall River and Lakota aquifers in the Dewey area would respond essentially as a single aquifer system. As a result less emphasis was placed on measurement of the Fuson aquitard properties.

### Procedures

A constant-discharge aquifer test was initiated at 1000 hours on February 16, 1982. Discharge from the well was pumped into an arroyo which ultimately drained into a stock pond located about one mile west of the test site. There was no possibility of recirculation of well discharge water during the test due to the 400+ feet thickness of shale between ground surface and the top of the Fall River aquifer. The well pumping rate was monitored with an in-line flow meter and with an orifice plate and manometer device at the end of the discharge line. The pumping rate varied little during the test ranging from 493 to 503 gpm and averaging 495 gpm. The pumping phase of the test lasted 11 days and was followed by approximately 10 months of recovery measurements. Water level measurements in all wells were made with electric probes. Flow rates associated with offsite private wells were checked with a bucket and stop watch.

TABLE 1. Well Construction Data

<u>Well No.</u>	<u>Depth (feet)</u>	<u>Casing Diameter (inches)</u>	<u>Depth Interval of Open Borehole or Well Screen (feet)</u>	<u>Distance From Pumped Well (feet)</u>
D-PW	804	10	695-725, 755-800	--
D-1LK	800	4	712-800	189
D-1FU	620	4	609-620	229
D-1FR	580	4	504-580	186
D-2LK	800	4	692-800	191
D-3LK	800	4	715-800	851
D-3FR	590	4	505-590	810
D-4LK	780	4	714-780	905
D-4FR	580	4	503-580	879
D-5LK	835	4	735-835	872
D-6LK	810	4	715-810	890
D-7FR	120	4	119-120	5610
D-8LK	750	4	650-750	2785
D-20LK	860	4	798-860	5700
D-20FR	672	1	671-672	5700

### Analysis

Semilogarithmic graphs of drawdown ( $s$ ) versus time ( $t$ ) for the pumped well and observation wells are given in Appendix A. The drawdown trends in wells D-PW, D-1LK and D-2LK are essentially the same, i.e., there is a period of roughly linear drawdown during the first 1000 minutes of the test, followed by a gradual increase in the rate of drawdown during the remainder of the test. The remaining Lakota wells exhibit  $s$ - $t$  curves which have a continuous increase in slope throughout the test without stabilizing to a linear drawdown trend. A slight increase in hydrostatic water level was observed during the early period of the test in the Fall River and Fuson wells. This seemingly paradoxical behavior, known as the Noordbergum effect, is due to a transfer of stress from the pumped aquifer to the adjacent aquitards and aquifers (Gambolati, 1974). Drawdowns observed in the Fall River and Fuson wells were much less than those recorded during a similar test conducted near Burdock (Boggs and Jenkins, 1980). The Jacob straight-line method (Walton, 1970) was applied to the semilog graphs for the Lakota wells to obtain the values of transmissivity ( $T$ ) and storativity ( $S$ ) presented in Table 2. In the case of the closer observation wells, two straight-line data fits were possible: one using the early data and another using the late data. Only the late data for the more distant observation wells were analyzed by this method.

Logarithmic  $s$ - $t$  graphs for all test wells are given in Appendix B. Theis curve-matching techniques (Walton, 1970) were applied to the Lakota aquifer curves to obtain the  $T$  and  $S$  estimates presented in Table 2. Due to the somewhat unusual shape of the  $s$ - $t$  response curves, the only curve-match solutions possible were those using the early data.



TABLE 2. Computed Lakota Aquifer Properties

Well	r (ft)	Jacob Method					Theis Method	
		Drawdown			Recovery		$T_e$	$S_e$
		$T_e$	$S_e$	$T_1$	$T_e$	$T_1$		
D-PW	0.67	4400	--	890	4890	680	--	--
D-1LK	189	5280	3.E-05	890	4890	650	5210	3.E-05
D-2LK	191	4400	3.E-04	910	4710	650	4090	2.E-04
D-3LK	851	--	--	920	--	670	6900	7.E-05
D-4LK	905	--	--	900	--	680	4090	8.E-05
D-5LK	872	--	--	900	--	670	4410	7.E-05
D-6LK	890	--	--	900	--	650	6030	8.E-05
D-8LK	2785	--	--	940	--	680	3180	5.E-05
D-20LK	5700	--	--	--	--	680	1400	3.E-05

Note: Transmissivity ( $T_e$ ,  $T_1$ ) in units of gpd/ft.

A semilog plot of the final drawdown in each Lakota well versus its radial distance from the pumped well is shown in Figure 3. The Jacob straight-line method was applied to this plot to obtain T and S values of 4400 gpd/ft and  $10^{-6}$ , respectively, for the Lakota aquifer. The storativity value computed by this method is considered highly unreliable since it is two orders of magnitude lower than expected.

Water level recovery data for all wells are presented in Appendix C. Data are plotted as semilog graphs of residual drawdown versus  $t/t'$  (ratio of time since pumping started to time since pumping stopped). The Lakota graphs were analyzed using the Jacob method. Again, two straight-line fits are possible for the closer Lakota wells. Both are given in Table 2.

Fuson aquitard properties were estimated from the D-1 well group data using the ratio method (Neuman and Witherspoon, 1973). The vertical hydraulic conductivity of the aquitard ( $K'_v$ ) is computed to be approximately  $2 \times 10^{-4}$  ft/d based on the average of several computed  $K'_v$  during the interval between 1800 and 5000 minutes. For purposes of the analysis, the specific storativity ( $S'_s$ ) of the aquitard was assumed to be approximately equal to that computed for the Lakota aquifer (about  $7 \times 10^{-7}$  ft<sup>-1</sup>).

### Interpretation

The T estimates obtained from all methods using the early drawdown and recovery data are in reasonably good agreement. Values range from 3180 to 6900 gpd/ft and average approximately 4800 gpd/ft. The T of 4400 gpd/ft derived from the distance drawdown analysis is also consistent with the early T estimates. These values are believed to represent the transmissivity of the Lakota aquifer within the immediate vicinity of the test

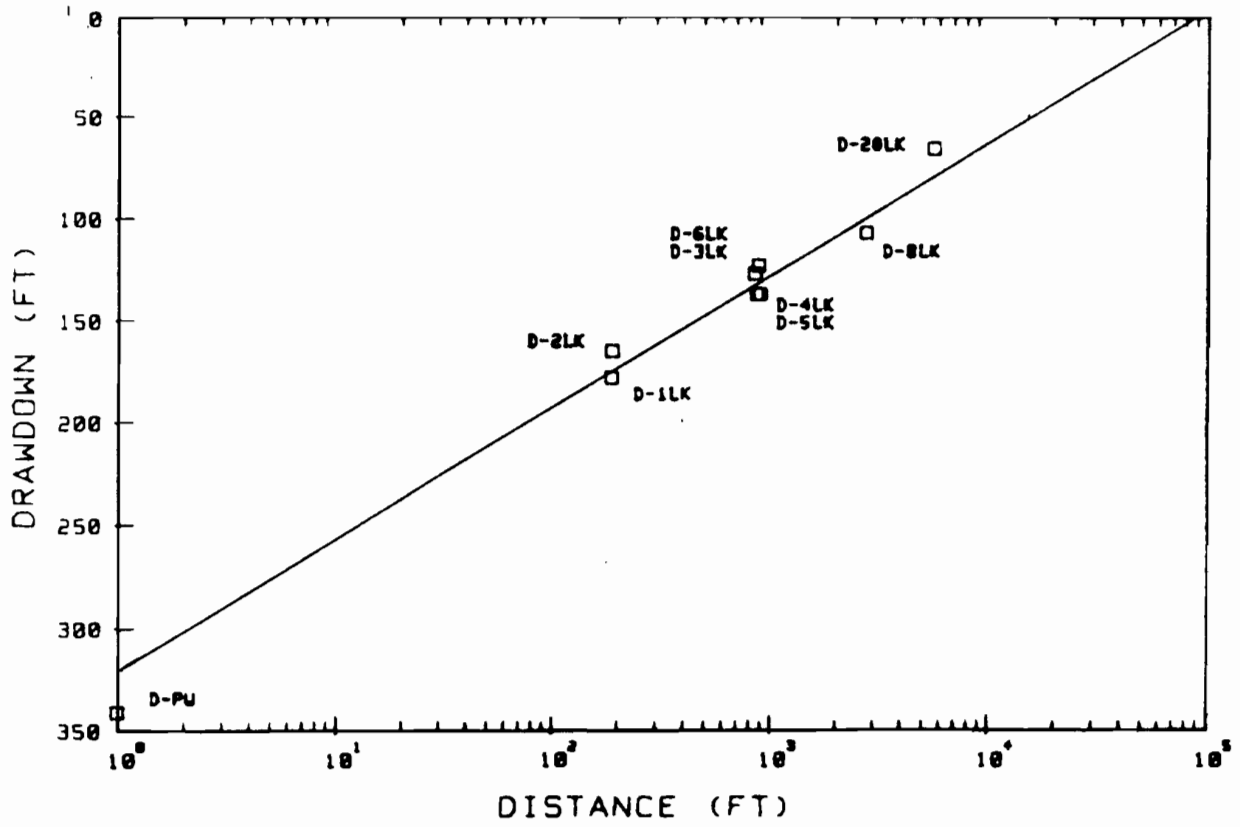

FIGURE 3. DISTANCE-DRAWDOWN GRAPH

site, and are consistent with the physical characteristics of the aquifer materials within this area. The T values computed from the late drawdown data, although consistent from well to well, are not reliable since the rate of drawdown during the later stage of the test never stabilized to the linear or ideal Theis-curve trend. The late recovery data provide the best estimates of the regional or long-term transmissivity of the Lakota aquifer in the Dewey region because of the long duration of this phase of the test.

In general, drawdown response in the pumped well and closer observation wells is characterized by a period of approximately linear drawdown during the first 1000 minutes of the test, followed by a steadily increasing rate of drawdown until the end of the test. The recovery data reflects the same sort of trend. The late response may be interpreted as either the effect of barrier boundary conditions or a decrease in transmissivity with distance from the test site or both.

Most of the available hydrogeologic information indicates that the Dewey fault acts as a barrier to horizontal ground-water movement in the Inyan Kara aquifers. Vertical displacement along the Dewey fault is on the order of 200 feet in the test site vicinity causing the complete separation of the Lakota aquifer on either side of the fault. Despite the geochemical evidence of Gott, et al. (1974), that the fault may act as conduit for upward circulation of ground water from deeper aquifers to the Inyan Kara Group, a recharge condition is not reflected in the potentiometric surface configuration in the fault zone (Figure 1) or in the test results. A reduction in the rate of drawdown would be expected in the s-t graphs for observation wells closest to the fault if significant recharge occurred in the fault zone. Instead the opposite response is observed in the test data. The s-t curve for well D-8LK (the closest observation well to the fault)

exhibits the steepest slope during the late stage of the test, supporting the idea that the fault is a hydrogeologic barrier. Upward recharge may occur in the fault zone but at relatively low rates. Consequently, the fault does not behave as a recharge boundary.

### Computer Simulations

A computer ground-water model of the Dewey region was developed to aid in interpreting the test results and refining aquifer parameters. A three-dimensional ground-water flow code developed by Trescott (1975) was used for the simulations. The Inyan Kara is conceptualized as a three-layer aquifer system consisting of the Lakota (Chilson) aquifer, the Fuson aquitard and the Fall River aquifer, with model layers having uniform thicknesses of 120, 100, and 180 feet, respectively. Impervious boundaries are set above the Fall River layer and below the Lakota layer to represent the relatively impermeable shales which bound the Inyan Kara Group. The model area and finite-difference grid are shown in Figure 4. The outcrop area of the Inyan Kara represents the eastern limit of the modeled region. The remaining three sides of the model are set at sufficient distances from the test pumping well to eliminate the possibility of artificial boundary effects in model simulations. The Dewey fault zone was treated as a barrier boundary.

Simulations were made using two basic conceptual models of the Inyan Kara aquifer system to determine which model best represented observed responses during the Dewey test. For case I, uniform T and S values of 4,400 gpd/ft and  $1 \times 10^{-4}$ , respectively were assigned to the Lakota aquifer. A uniform T was used for this case despite evidence of a much lower transmissivity outside of the immediate test site in order to determine

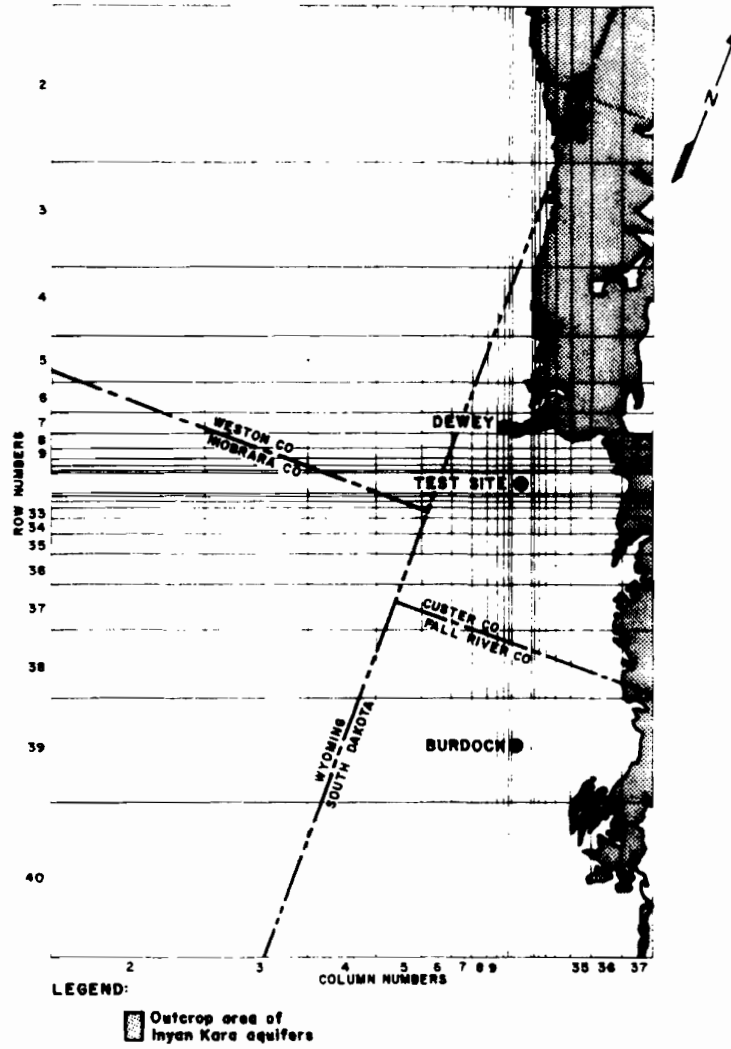

Figure 4: Ground-Water Model Grid

WR28 -2 -520 -- 128.4

whether the fault alone could account for late drawdown trends. The Fuson aquitard was assigned a uniform  $K'_v$  of  $10^{-4}$  ft/d. The Fall River aquifer was represented by uniform T and S values of 400 gpd/ft and  $10^{-4}$  respectively, based on the results of the Burdock tests (Boggs and Jenkins, 1980). A simulation was then made of the 11-day Dewey aquifer test using the average pumping rate of 495 gpm in an attempt to reproduce the test results. A comparison of computed and observed s-t graphs for the Lakota observation wells is shown in Figure 5. Clearly, the barrier boundary condition created by the fault does not fully account for the observed increase in drawdown rate during the latter part of the test.

In Case II, the model was modified to account for the suspected spatial variability of transmissivity in the Lakota aquifer. Geologic evidence indicates that the test site is located in an area where the Lakota is composed of an exceptionally thick coarse-grained sandstone. Outside of this locality the aquifer becomes thinner and its composition changes to finer-grained sedimentary facies. These changes are particularly evident in the area east of the site. The test results indicate a local T in the immediate site area of about 4,400 gpd/ft and a regional average of about 670 gpd/ft. These T estimates were used along with areal variations in the sandstone-shale composition of the Lakota aquifer in the site vicinity to arrive at the T distribution shown in Figure 6. Exploration borehole geophysical logs were used to estimate the relative amounts of sandstone and shale in the Lakota across the site area. The horizontal hydraulic conductivity of the sandstone is estimated at approximately  $5.7 \times 10^{-5}$  ft/sec based upon the near-field T estimate of 4,400 gpd/ft, an aquifer thickness of 120 feet, and the assumption that the aquifer in the immediate vicinity of the test well and closest observation wells is essentially all sandstone. The

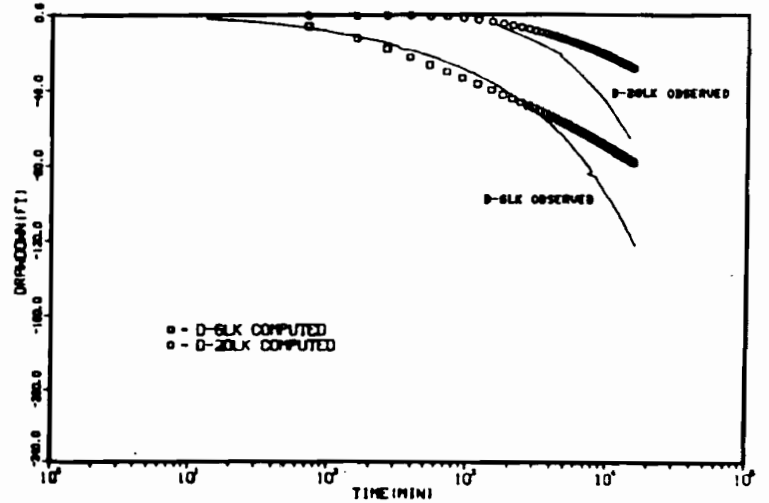
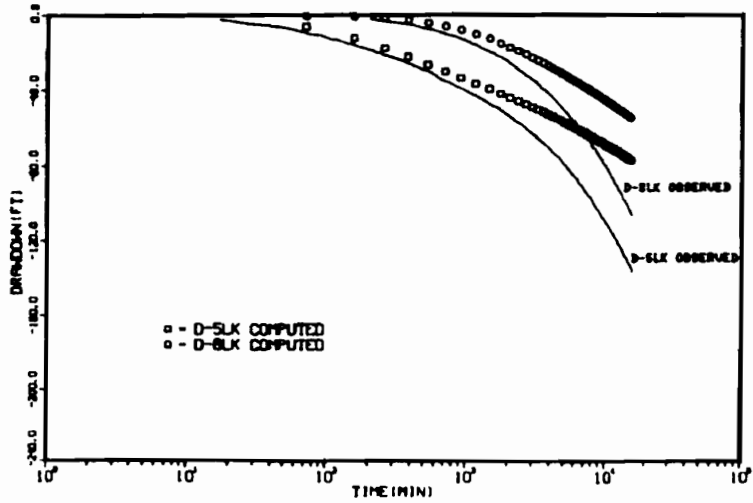
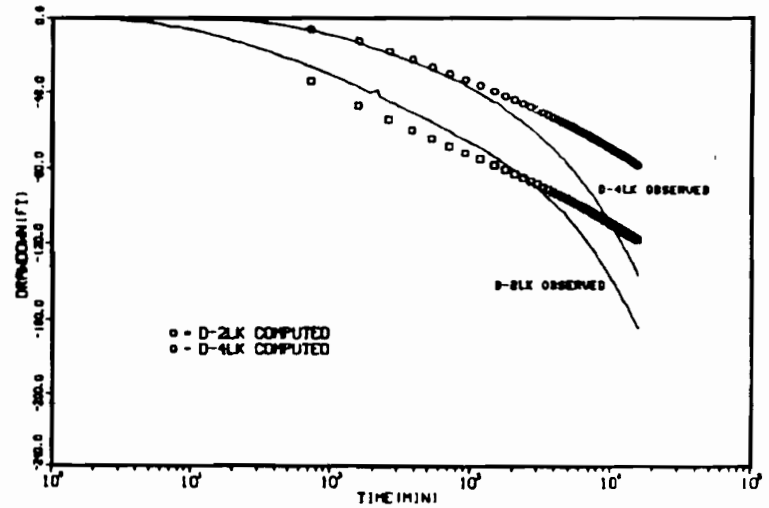
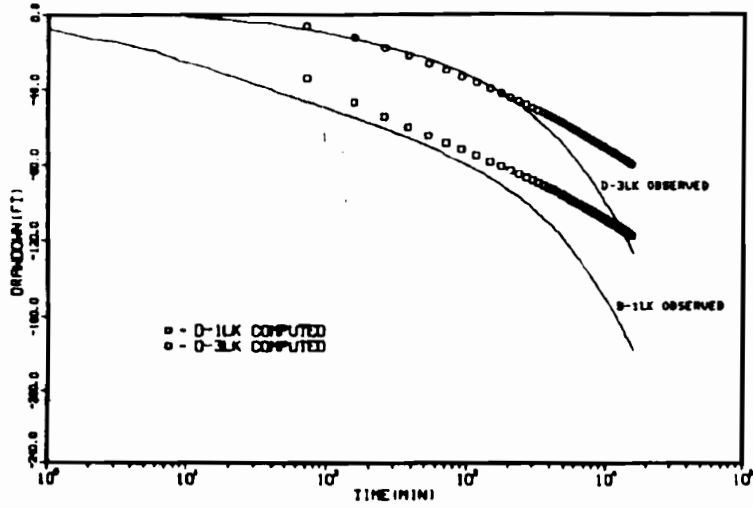

Figure 5. Comparison of Observed and Computed Drawdown, Case I



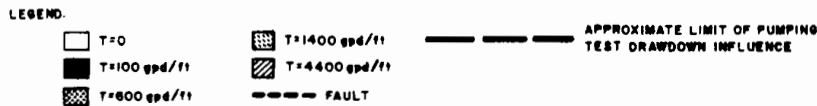
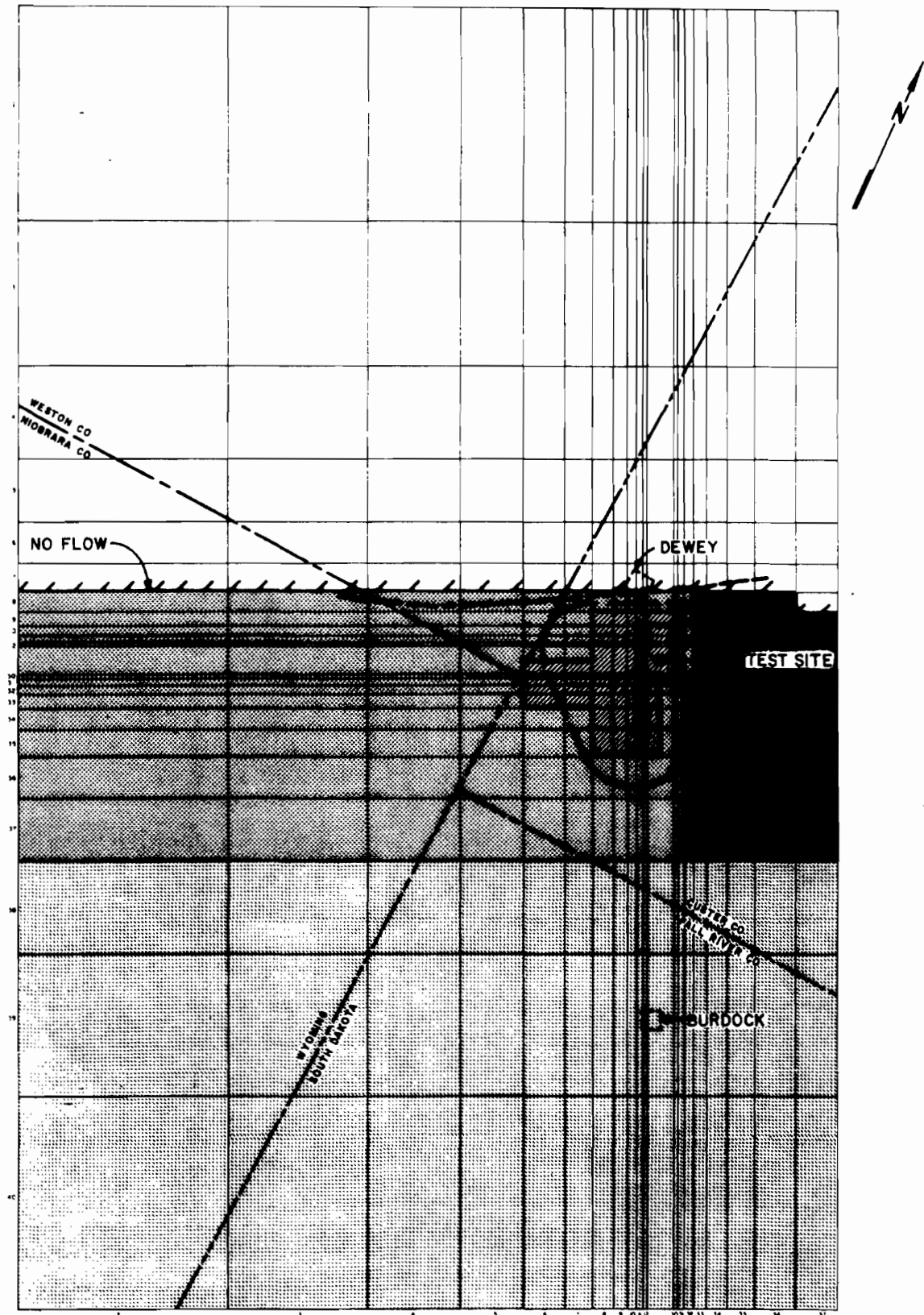

Figure 6: Transmissivity Distribution, Case II

WR28-2-520-128.6

horizontal conductivity of the shale is estimated to be about  $10^{-8}$  ft/sec assuming (1) the measured vertical conductivity of the Fuson shale is also representative of shale in the Lakota aquifer and (2) the ratio of horizontal to vertical conductivity is about 10:1. Given the estimated horizontal conductivities for the sandstone and shale, a representative average conductivity was computed for areas having similar aquifer sandstone-shale ratios. The representative average conductivity was computed from the geometric mean of the conductivity samples as suggested by Bouwer (1969). The transmissivity of 1,400 gpd/ft assigned to the southern portion of the model is based on results of the Burdock aquifer test. Note that although an attempt was made to assign realistic transmissivity values to the entire model region, model simulation results are mainly affected by the transmissivity distribution within the observed limits of influence of the 11-day aquifer test as indicated in Figure 6. Outside of this region the model is relatively insensitive to the assigned T values.

The Case II simulation results are shown in Figure 7. The agreement between the computed and observed drawdown trends in the Lakota wells is quite good overall. At least part of the discrepancy between observed and computed responses in these units is due to the fact that computed hydraulic heads are average values over the thickness of the aquifer or aquitard layer.

The observed drawdown trends could, perhaps, be reproduced using some alternative T distribution without the barrier boundary condition assumed for the Dewey fault. However, if the fault did not represent a barrier, substantial pressure changes should have been observed during the test in the private Lakota wells located north of the fault. These wells are located at approximately the same radial distance as observation well

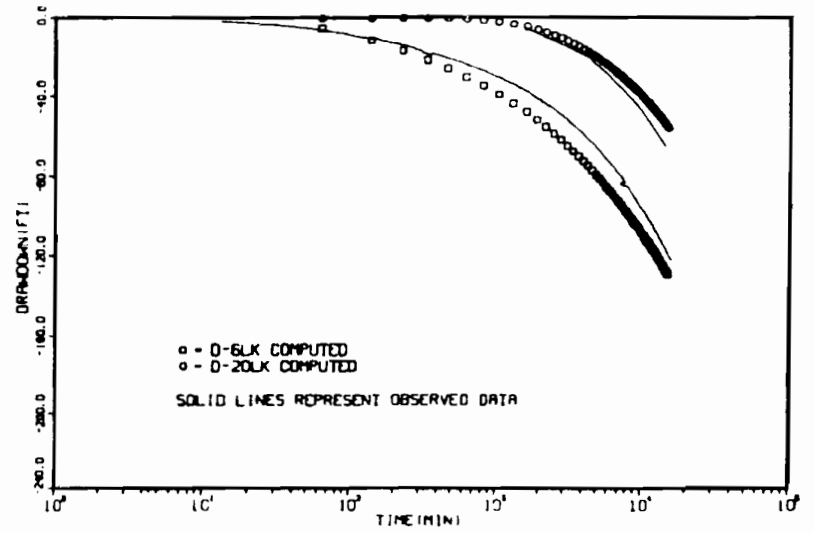
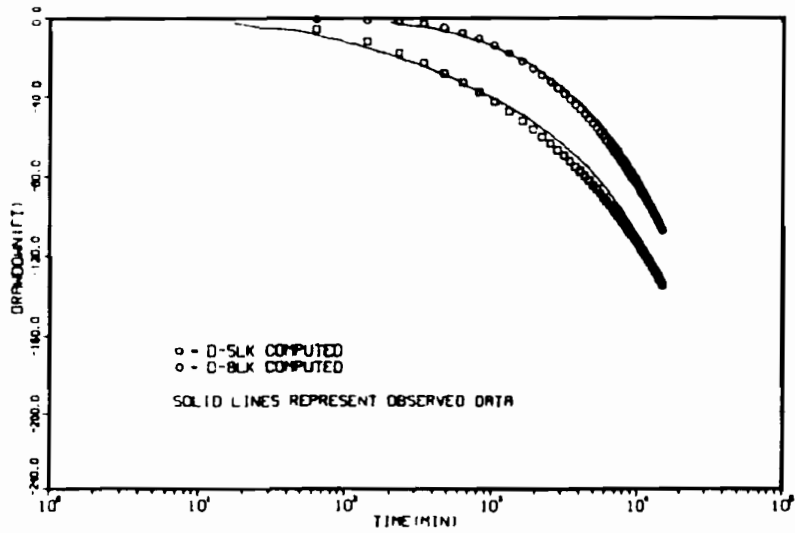
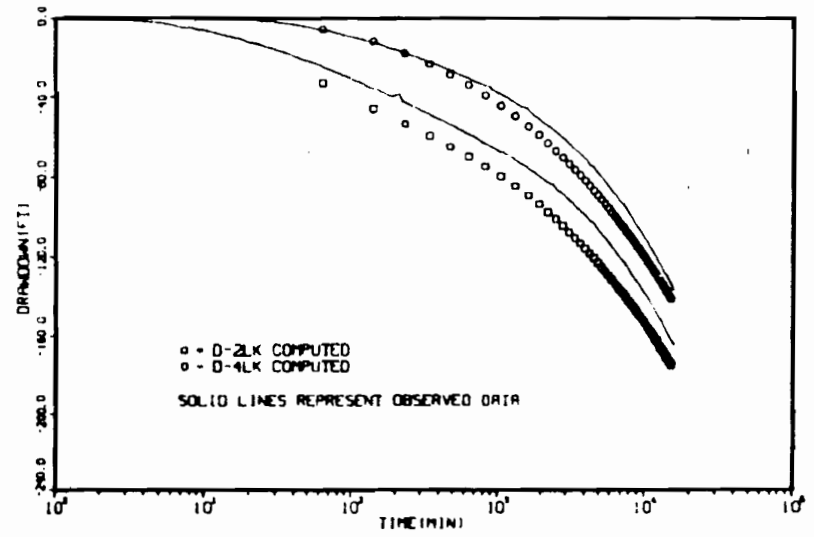
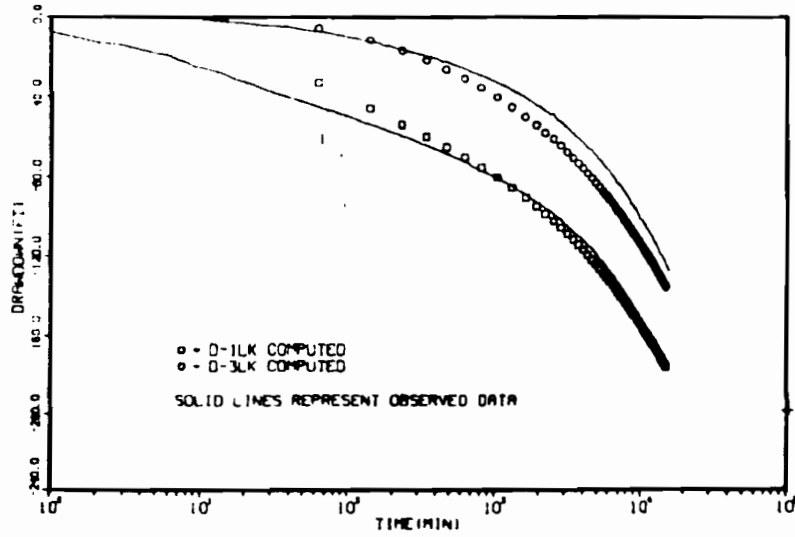

Figure 7. Comparison of Observed and Computed Drawdown, Case II

D-20LK which exhibited 66 feet of drawdown at the end of the test. As no drawdown occurred in these wells, it is concluded that the Dewey fault represents a hydrogeologic barrier.

The Case II simulation results support the concept of the Lakota as a patchy aquifer of relatively low-transmissivity overall but having within it localized zones of substantially higher transmissivity. The proposed mine site lies within one of these high transmissivity localities. Although the T distribution used in the Case II model is based upon reasonable assumptions, it is considered only an approximation of actual conditions in the test site area. Nevertheless, this approximation is adequate for assessing long-term mine depressurization impacts. The significance of the Case II model result is that it provides an interpretation of the test results which is consistent with what is known or suspected about the hydrogeologic conditions in the site region.

### CONCLUSIONS

Hydrogeologic investigations in the Dewey area indicate that the proposed mine site lies within an area where the Lakota Formation is composed of relatively thick permeable sandstone. The transmissivity of the Lakota aquifer in this locality is estimated to be approximately 4,400 gpd/ft. Storativity of the aquifer is about  $10^{-4}$ . Outside of this area the Lakota transmissivity decreases substantially. The variation in transmissivity over the region is consistent with geologic evidence of thinning of the Lakota sandstone away from the test site and a change to finer-grained sand and shale facies. The significance of this condition is that long-term mine depressurization rates and drawdown response in the Dewey vicinity will be

governed by the lower transmissivity material. As a result, dewatering rates will be lower and the areal extent of drawdown impacts smaller than if the higher transmissivity prevailed.

There is evidence that hydraulic communication between the Fall River and Lakota aquifers occurred during the Dewey test. However, the degree of interconnection between these units is substantially less than that observed at the Burdock test site. The vertical hydraulic conductivity of the intervening Fuson aquitard estimated from the Dewey test data is approximately  $10^{-4}$  ft/d. This value is about an order of magnitude lower than the estimate obtained at Burdock. The difference is somewhat surprising in that the Fuson aquitard is thinner in the Dewey area than at Burdock. A possible explanation may be that the direct avenues of hydraulic communication (e.g., numerous open pre-TVA exploration boreholes) believed to exist at Burdock, are not present in the Dewey area.

Evaluation of the drawdown responses recorded in test wells and private wells during the aquifer test and review of existing subsurface geologic data indicates that the Dewey fault zone acts as a hydrogeologic barrier to horizontal ground-water movement between the Inyan Kara aquifers located on opposite sides of the fault zone. Some upward vertical recharge to the Inyan Kara may occur in the fault zone as suggested by Gott, et al. (1968). However, rate of recharge from this source must be relatively small, otherwise recharge effects would be apparent in the aquifer test results and in the configuration of the steady-state potentiometric surface. It is expected that the fault will significantly reduce mining drawdown impacts on ground-water supplies located north of the fault zone.

3. The model should be calibrated by adjustment of hydraulic parameters to reproduce the existing steady-state potentiometric surface shown in Figure 1. The hydraulic properties for the Inyan Kara units measured at the Dewey and Burdock test sites should be held constant in the calibration process, while parameter adjustments are made in other areas to obtain a reasonable match between the computed and observed potentiometric levels. An estimate of net ground-water recharge can be obtained from the calibrated model by assigning observed potentiometric head values to the model nodes which lie within the aquifer recharge (outcrop) area. The aquifer recharge fluxes may be incorporated directly into the model to more accurately represent drawdown conditions in the outcrop areas during mine depressurization simulations.

4. Significant pumping stresses on the Inyan Kara aquifers other than the TVA mining operations should be identified and incorporated into the model.

REFERENCES

- Boggs, J. M., and A. M. Jenkins, 1980, "Analysis of Aquifer Tests Conducted at the Proposed Burdock Uranium Mine Site, Burdock, South Dakota," TVA Report No. WR28-1-520-109.
- Bouwer, H., 1969, "Planning and Interpreting Soil Permeability Measurements," ASCE Journal of Irrigation and Drainage Division, V. 95, No. IR3, pp. 391-402.
- Gambolati, G., 1974, "Second-Order Theory of Flow in Three-Dimensional Deforming Media," Water Resources Research, V. 10, No. 6, pp. 1217-1228.
- Gott, G. B., D. E. Wolcott, and C. G. Bowles, 1974, "Stratigraphy of the Inyan Kara Group and Localization of Uranium Deposits, Southern Black Hills, South Dakota and Wyoming," USGS Prof. Paper 763.
- Trescott, P. C., 1975, "Documentation of Finite-Difference Model for Simulation of Three-Dimensional Ground-Water Flow," USGS Open File Report 75-438.
- Walton, W. C., 1970, Groundwater Resource Evaluation, McGraw-Hill, New York.

FIGURE A-1: DRAWDOWN GRAPH FOR WELL D-PW

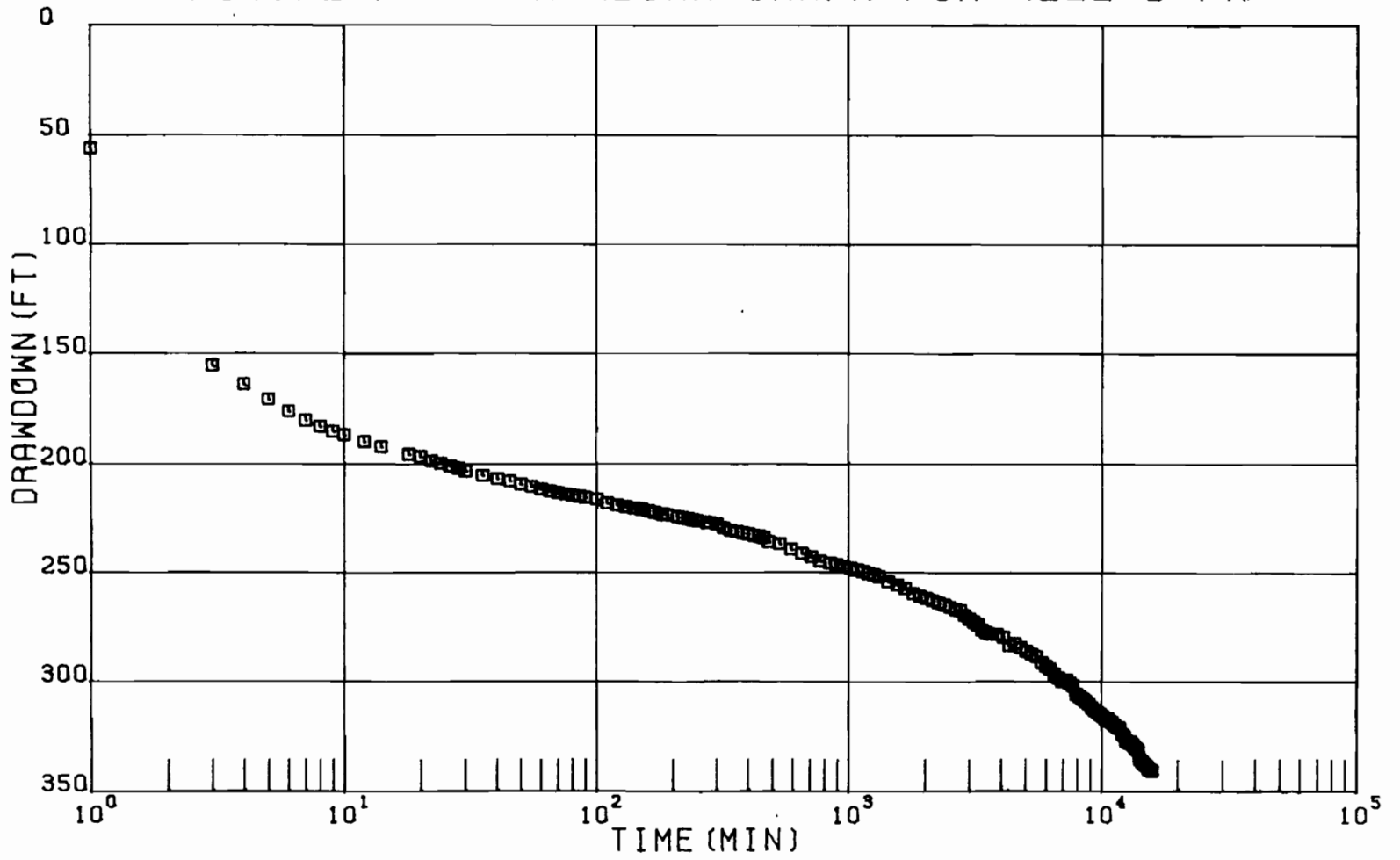



FIGURE A-2: DRAWDOWN GRAPH FOR D-1 WELL GROUP

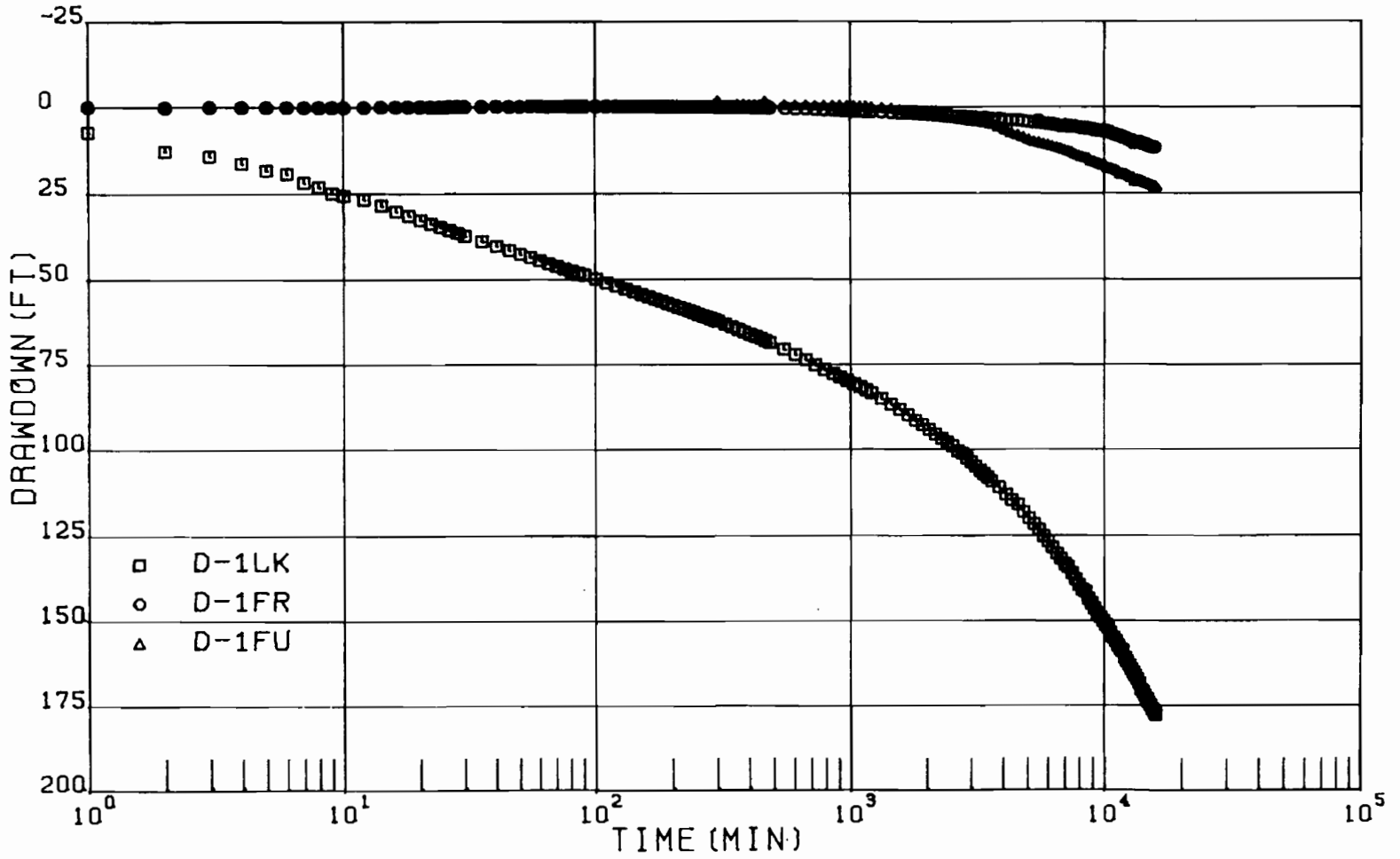

FIGURE A-3: DRAWDOWN GRAPH FOR WELL D-2LK

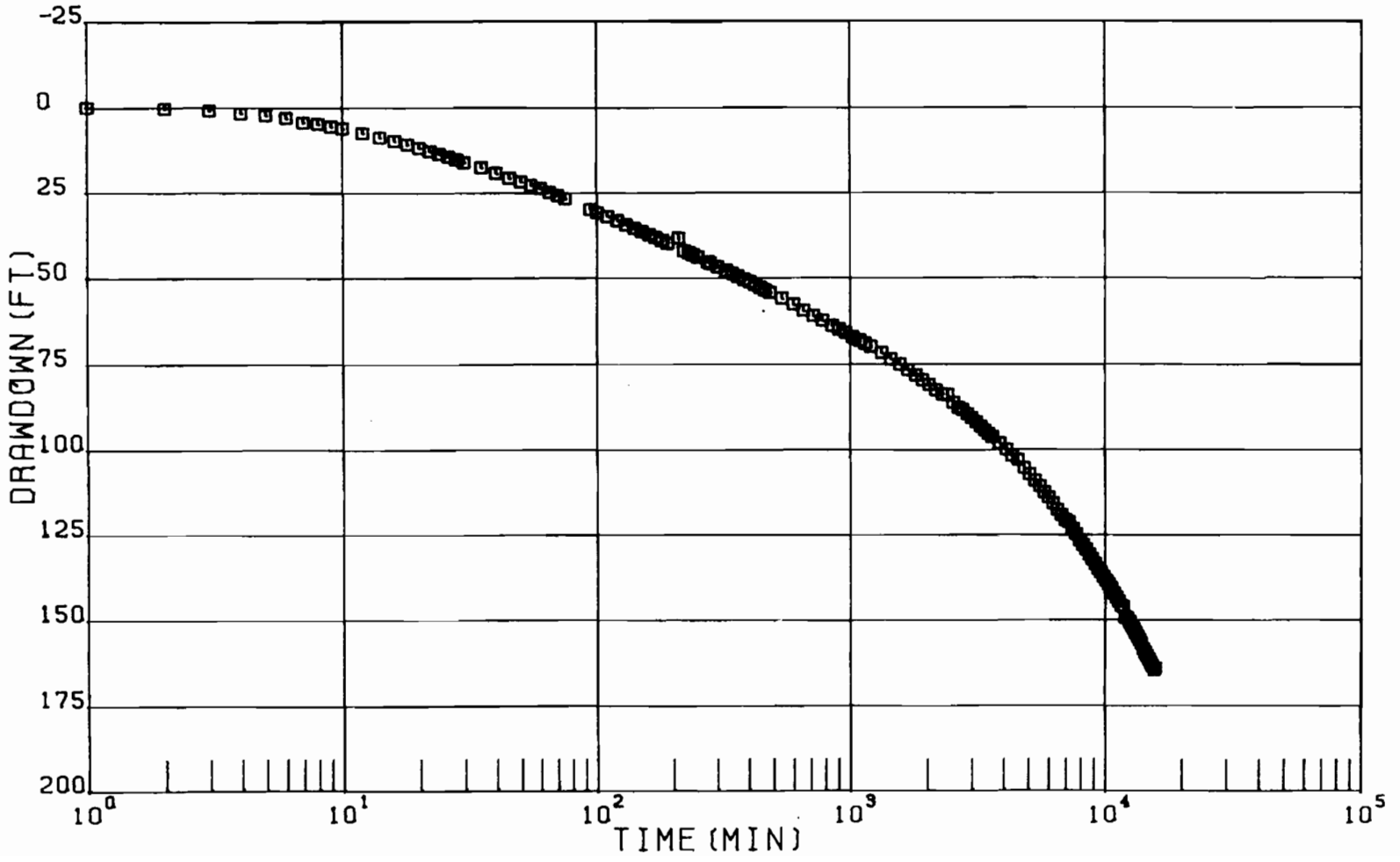

FIGURE A-4: DRAWDOWN GRAPH FOR D-3 WELL GROUP

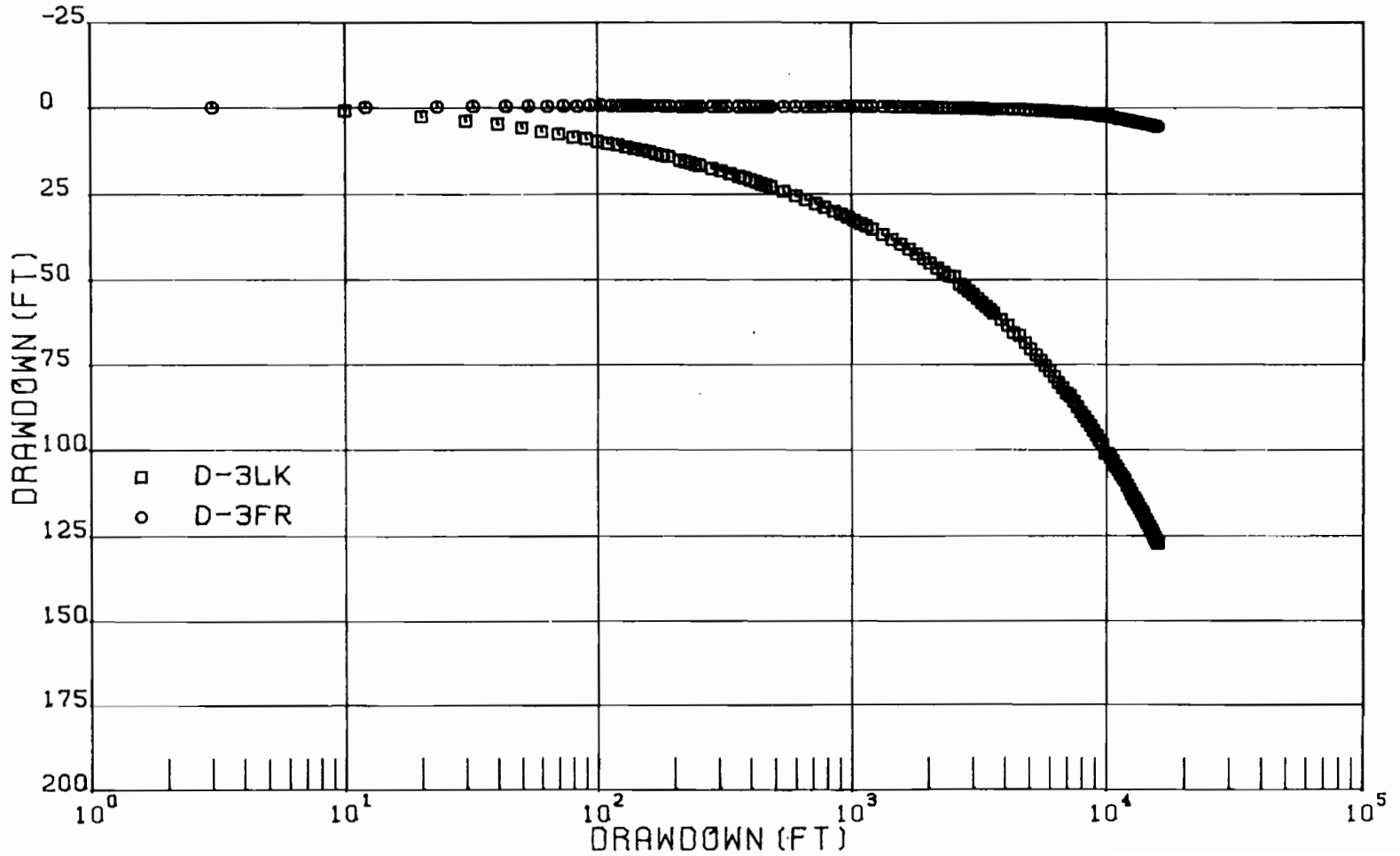

FIGURE A-5: DRAWDOWN GRAPH FOR D-4 WELL GROUP

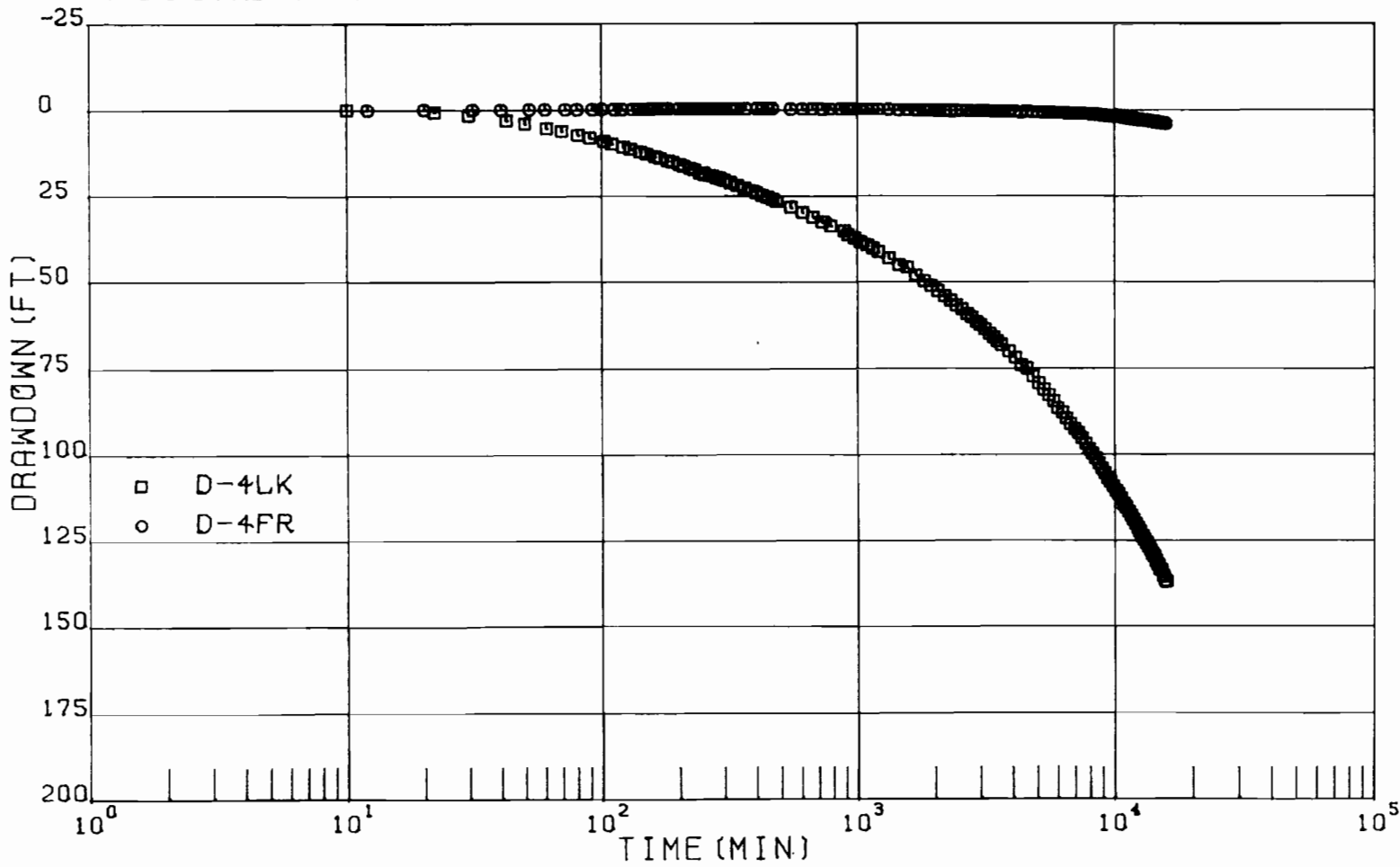

FIGURE A-6: DRAWDOWN GRAPH FOR WELL D-5LK

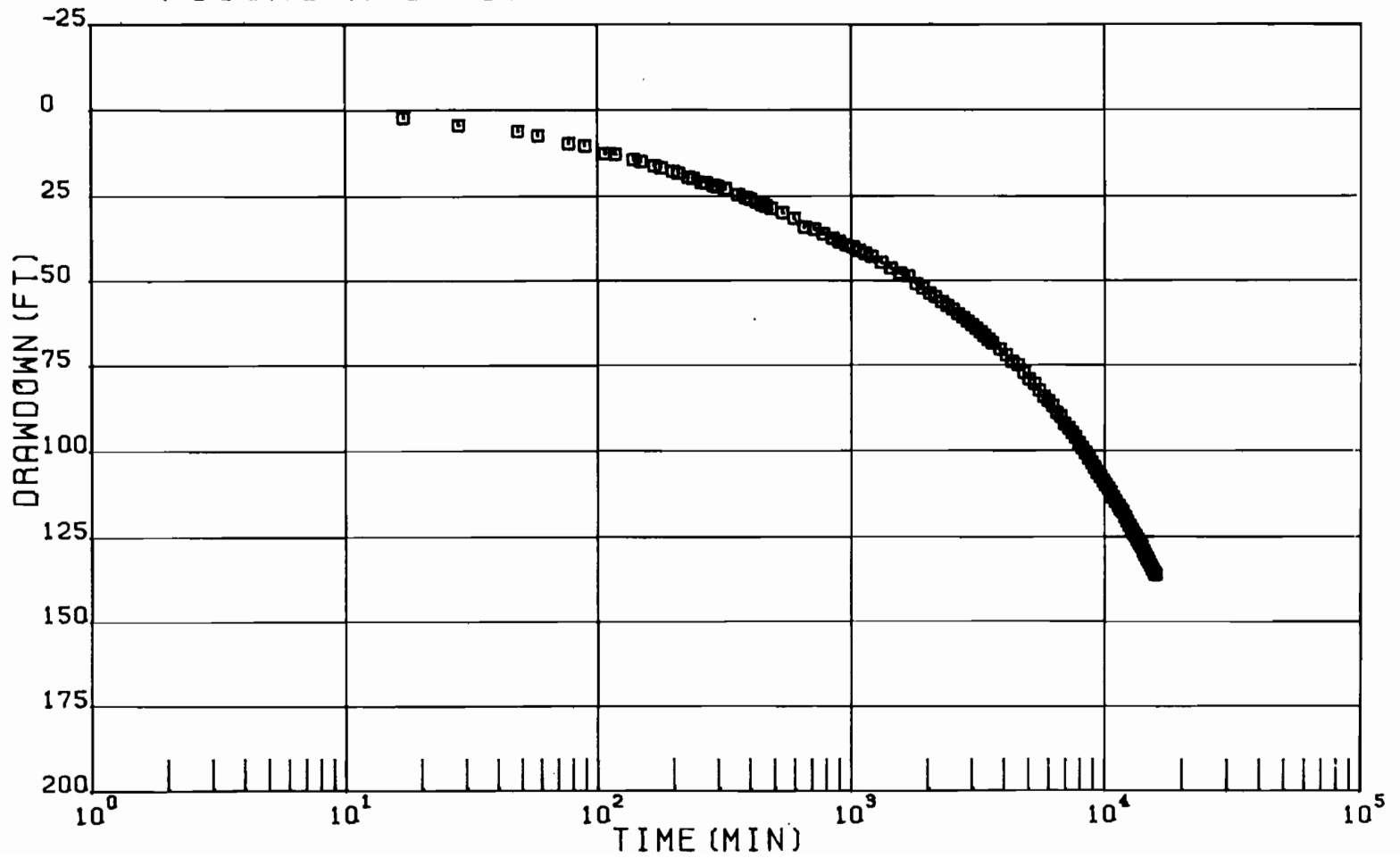

FIGURE A-7: DRAWDOWN GRAPH FOR WELL D-6LK

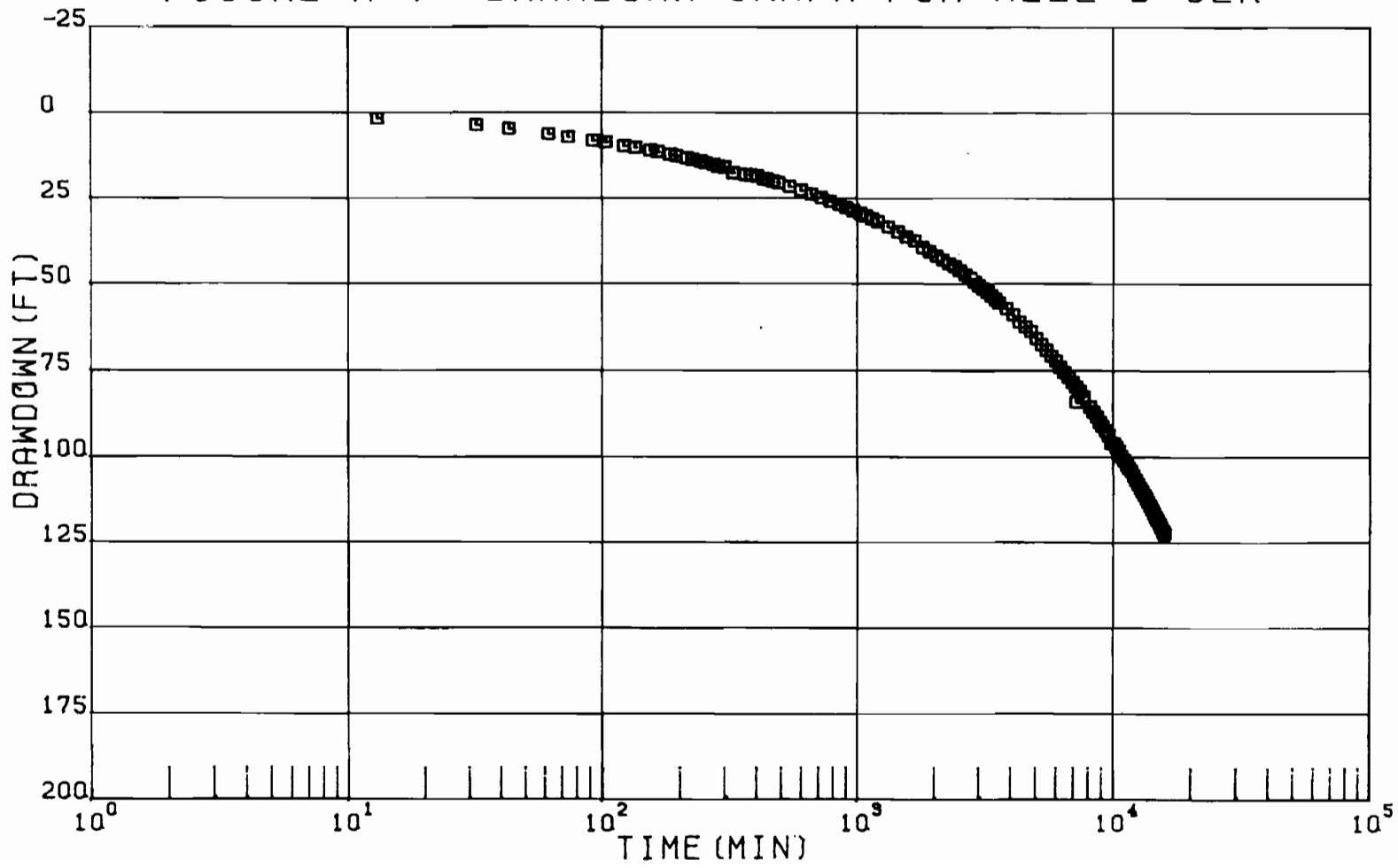

FIGURE A-8: DRAWDOWN GRAPH FOR WELL D-8LK

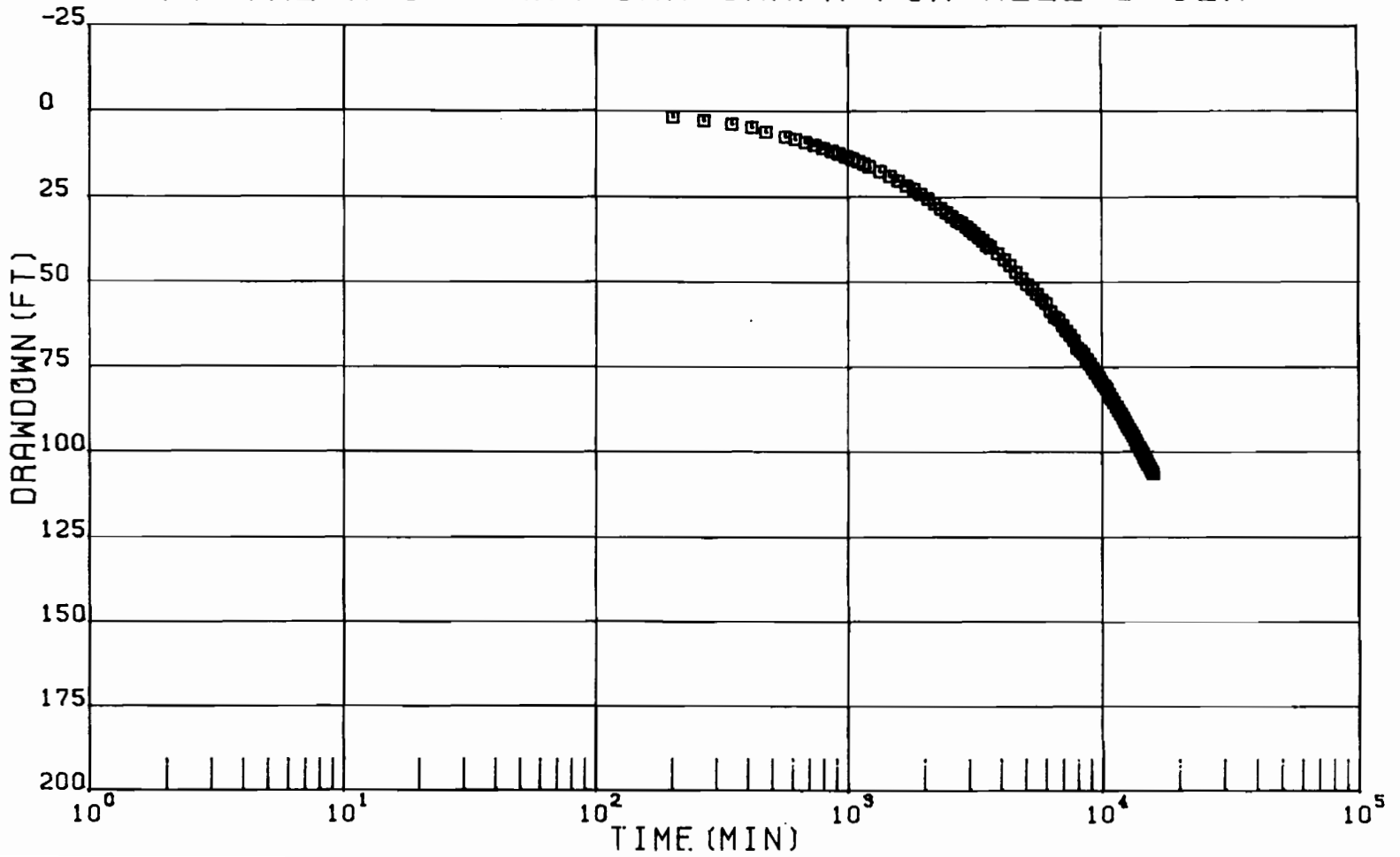
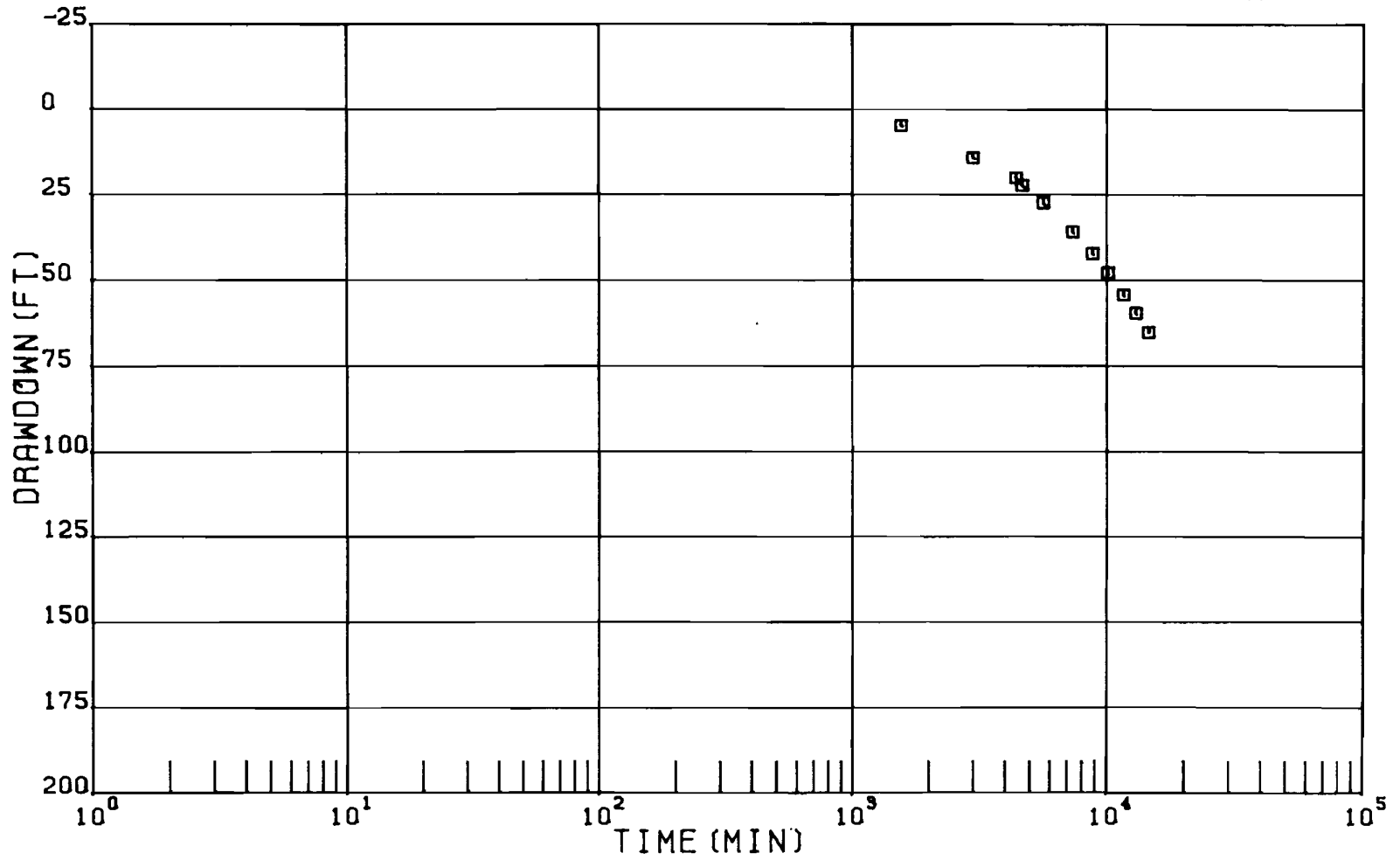

FIGURE A-9: DRAWDOWN GRAPH FOR WELL D-20LK





APPENDIX B

LOGARITHMIC TIME-DRAWDOWN GRAPHS

FIGURE B-1: DRAWDOWN GRAPH FOR WELL D-PW

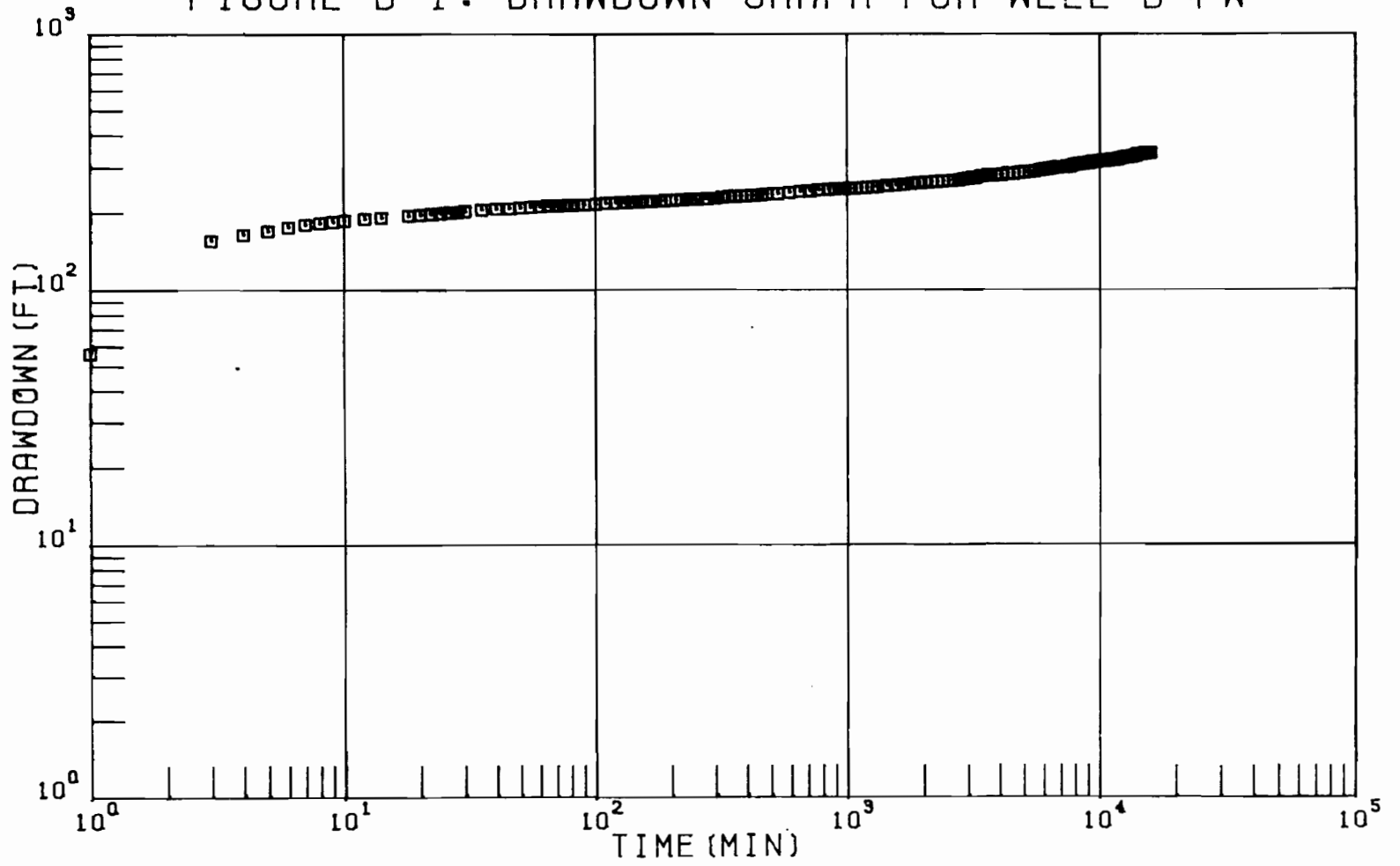

FIGURE B-2: DRAWDOWN GRAPH FOR D-1 WELL GROUP

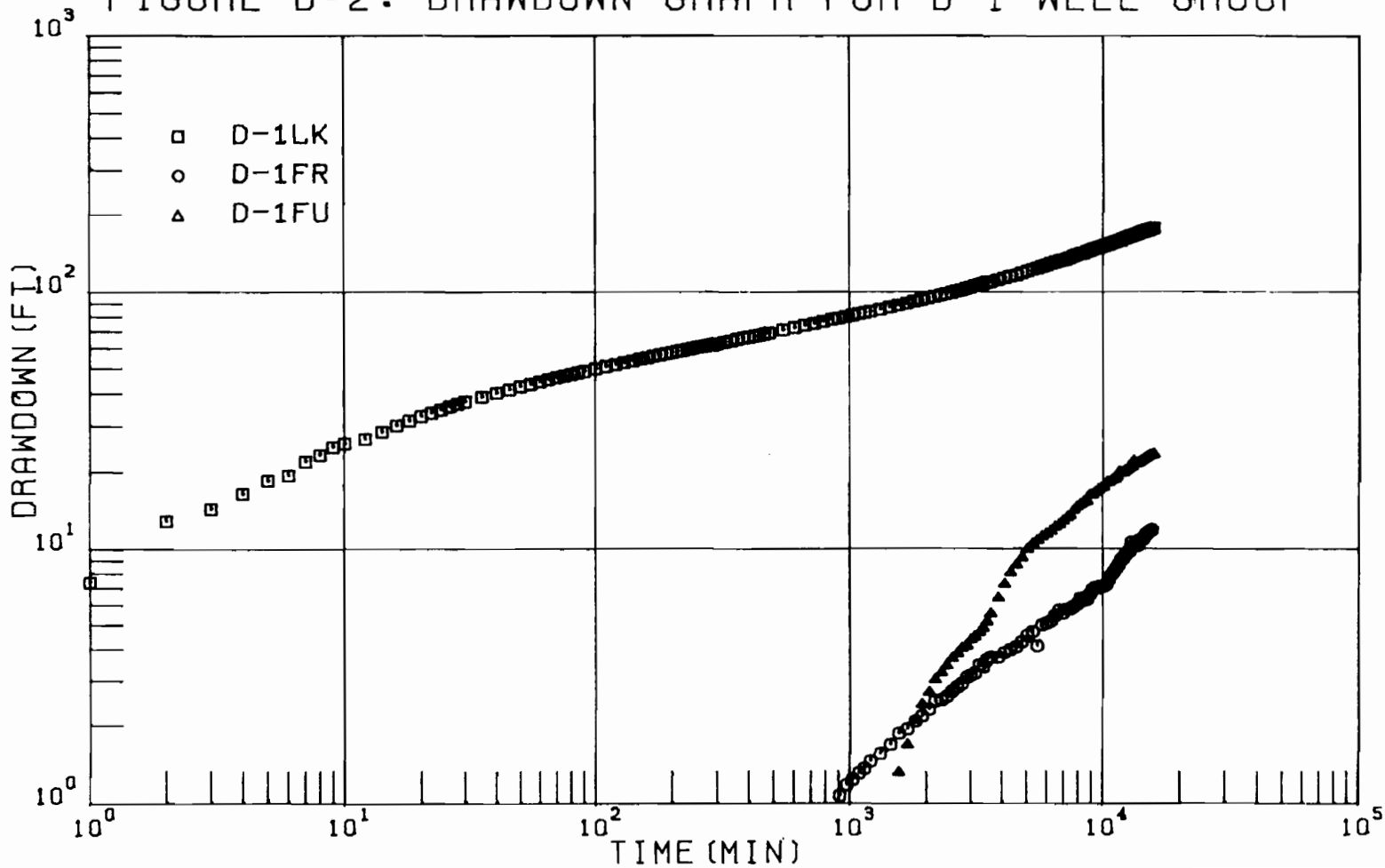
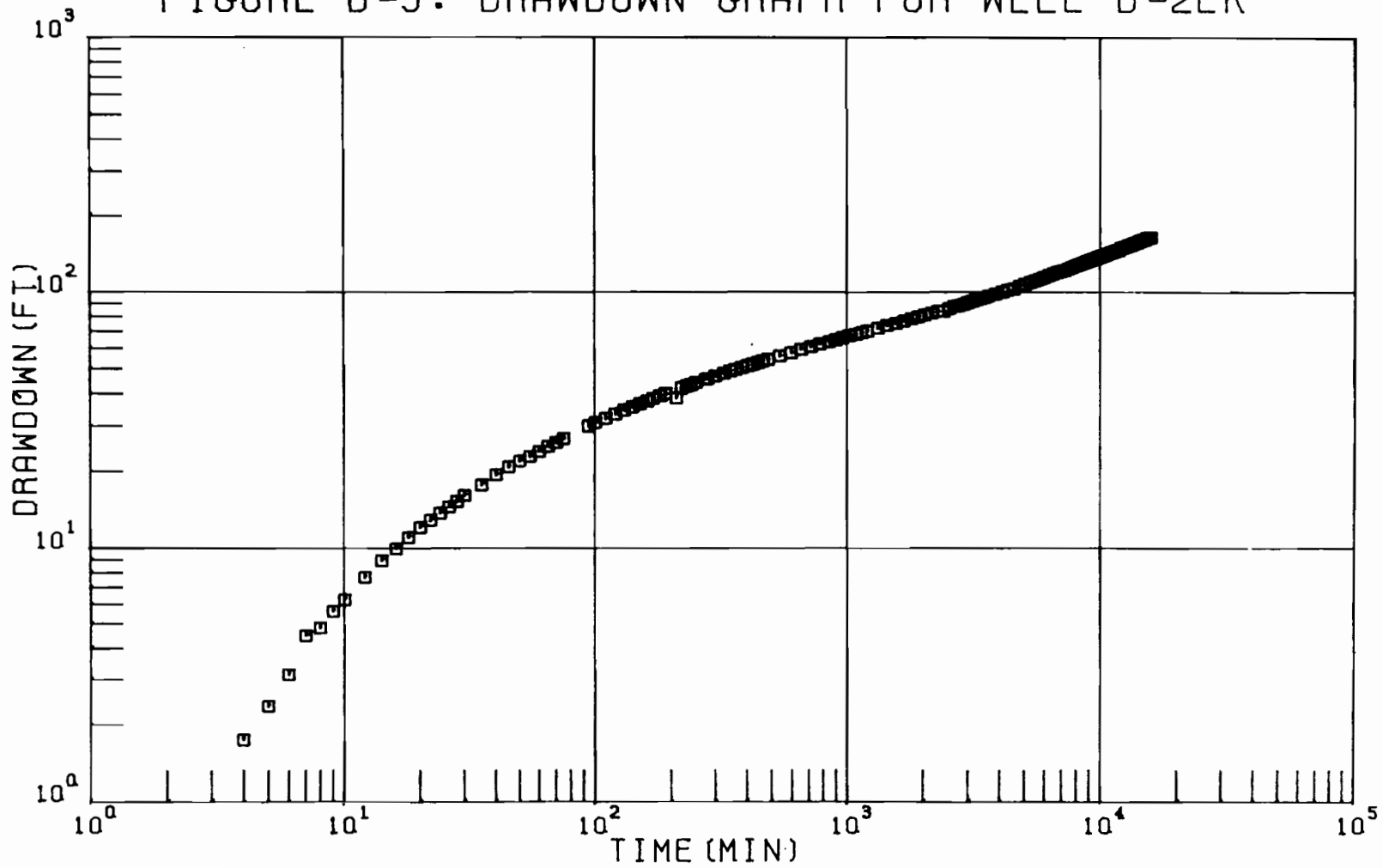
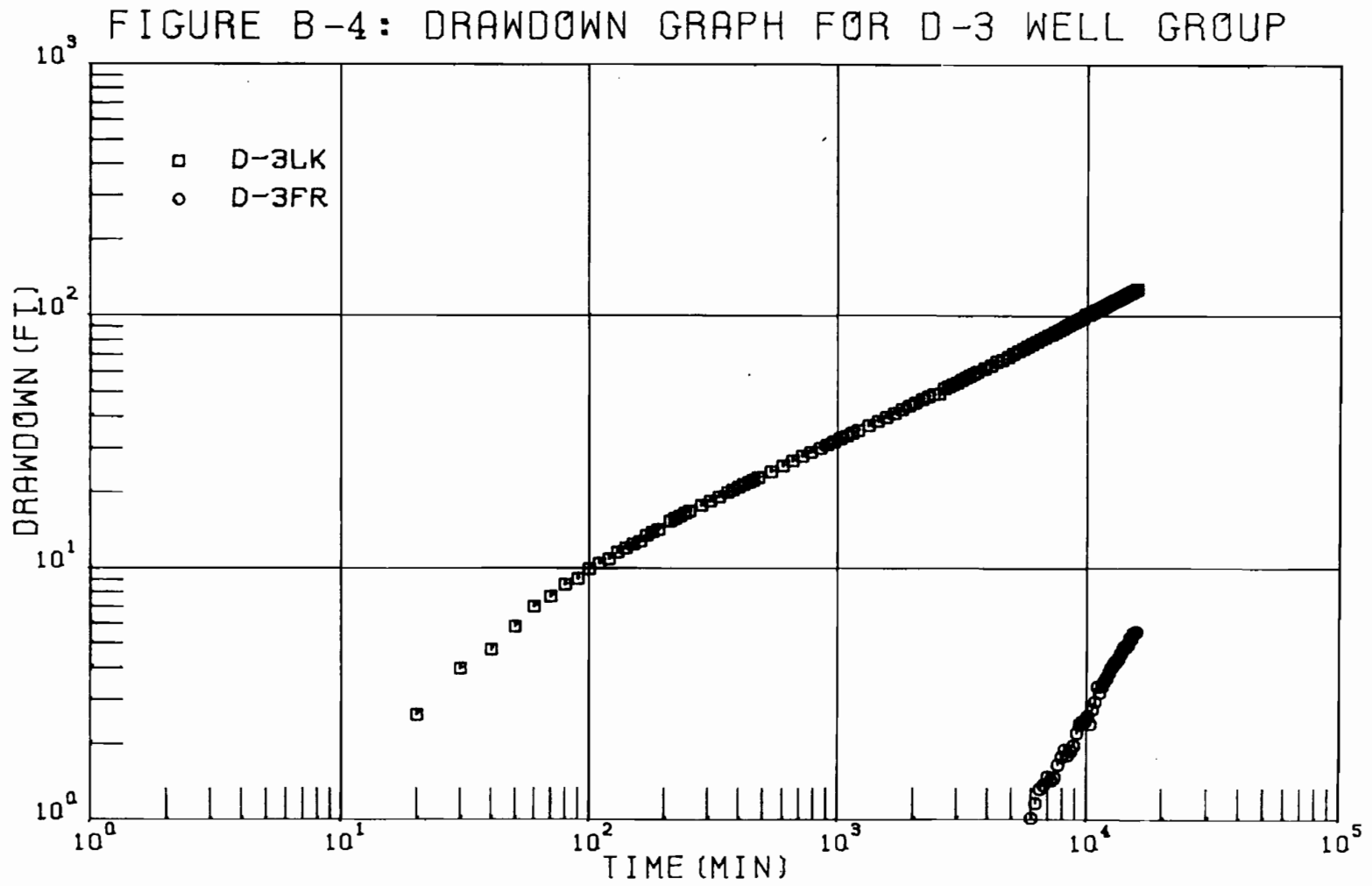

FIGURE B-3: DRAWDOWN GRAPH FOR WELL D-2LK





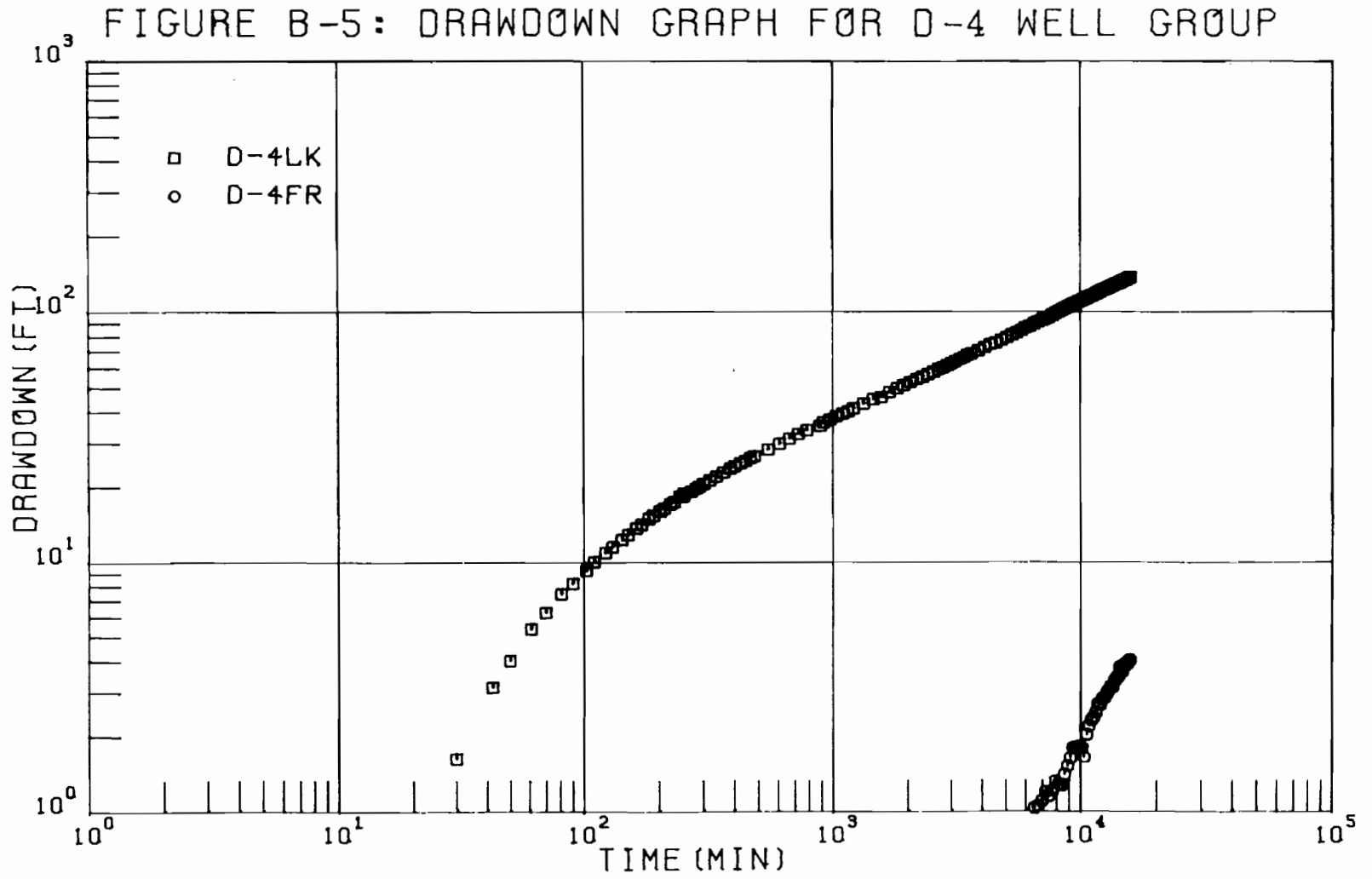

FIGURE B-6: DRAWDOWN GRAPH FOR WELL D-5LK

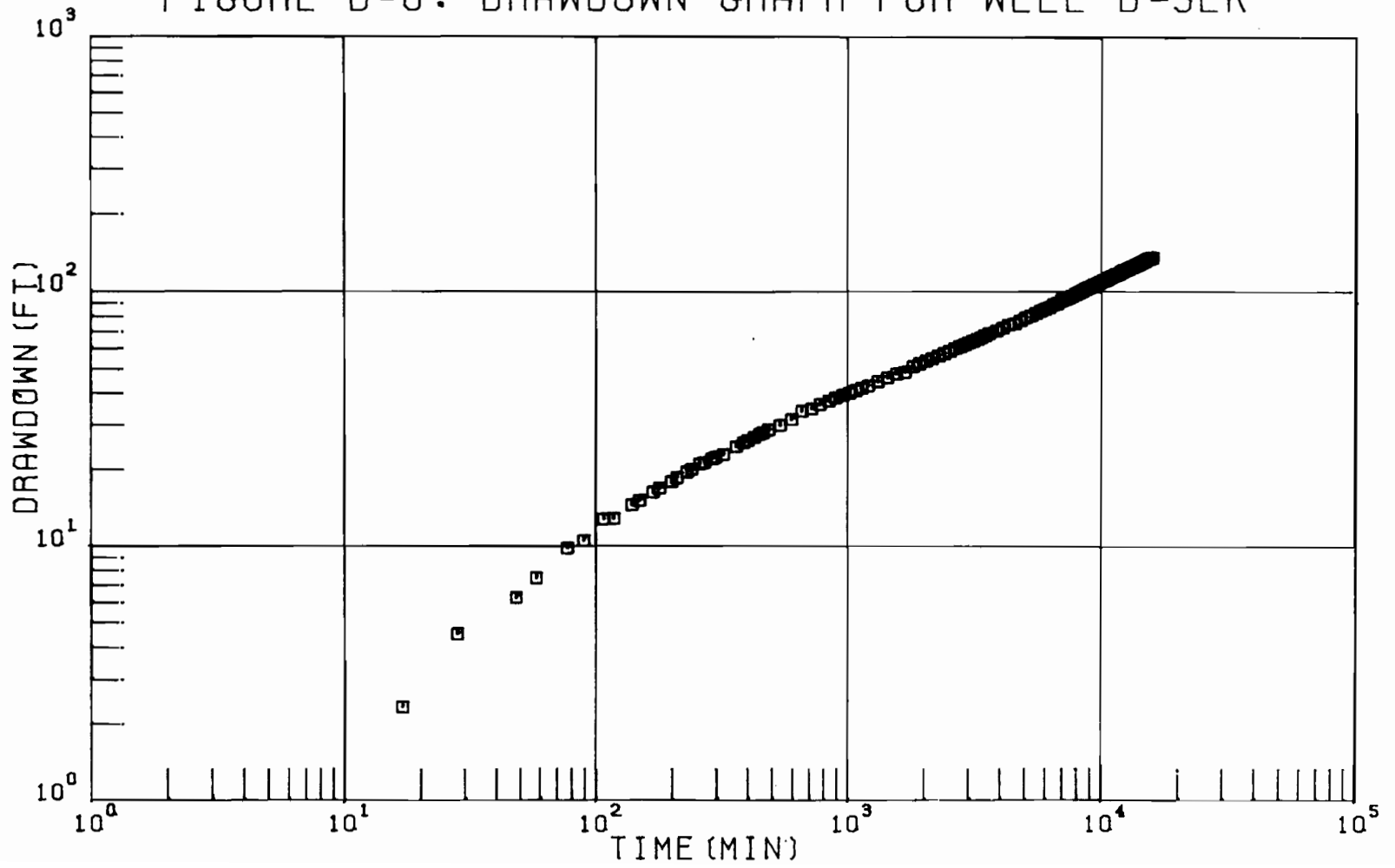

FIGURE B-7: DRAWDOWN GRAPH FOR WELL D-6LK

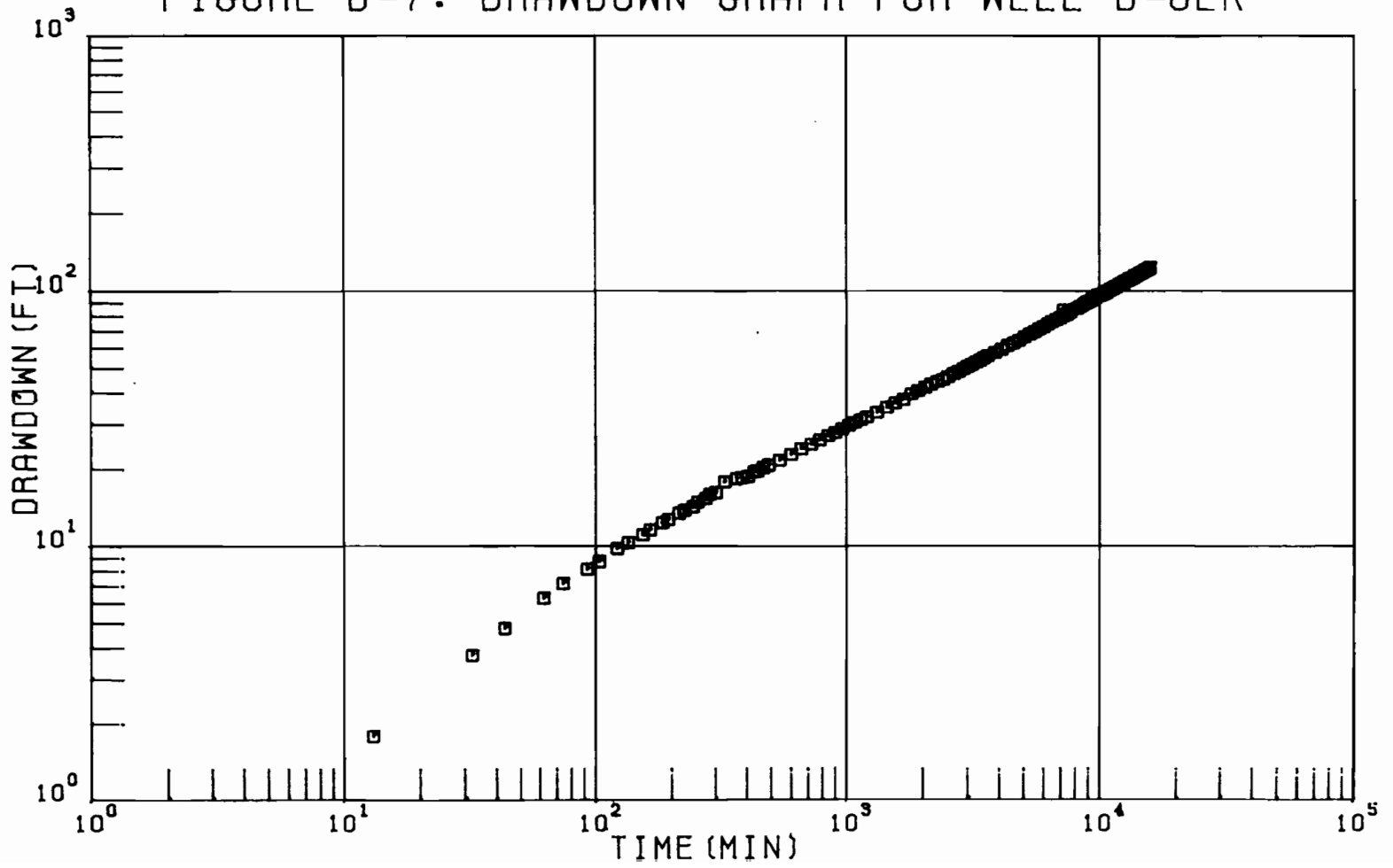



FIGURE B-8: DRAWDOWN GRAPH FOR WELL D-8LK

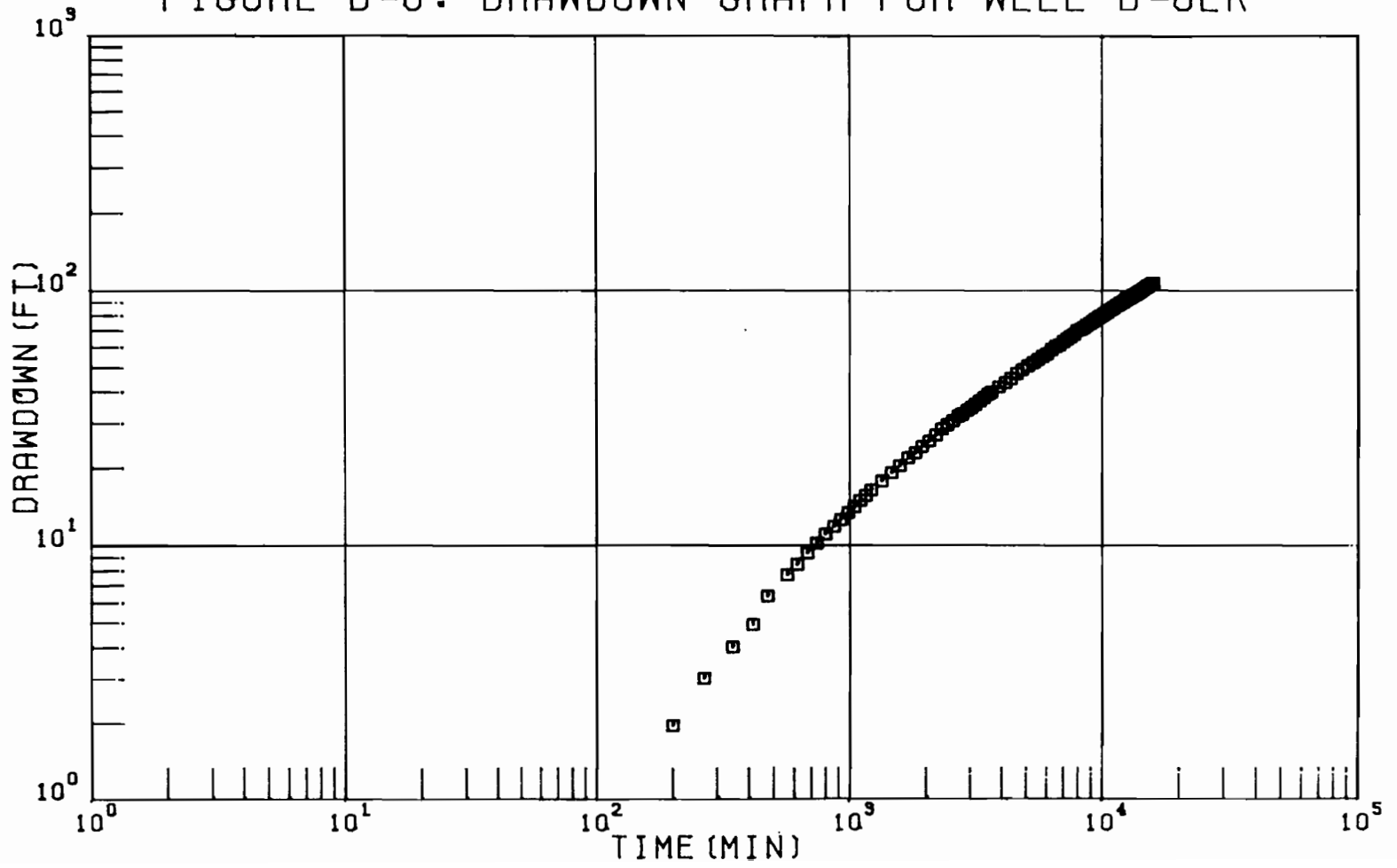
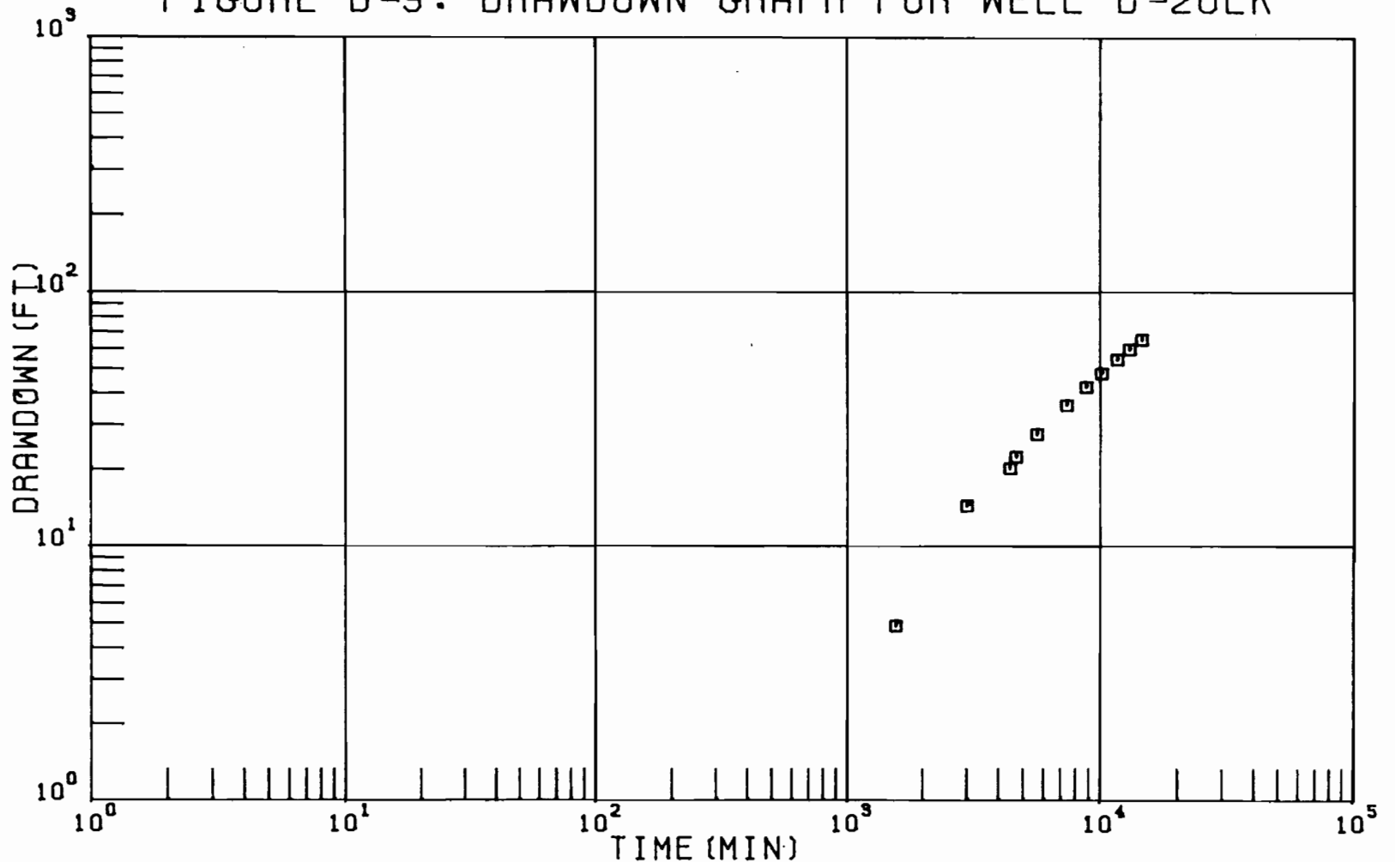

FIGURE B-9: DRAWDOWN GRAPH FOR WELL D-20LK



APPENDIX C

SEMILOGARITHMIC TIME-RESIDUAL DRAWDOWN GRAPHS

FIGURE C-1: RECOVERY GRAPH FOR WELL D-PW

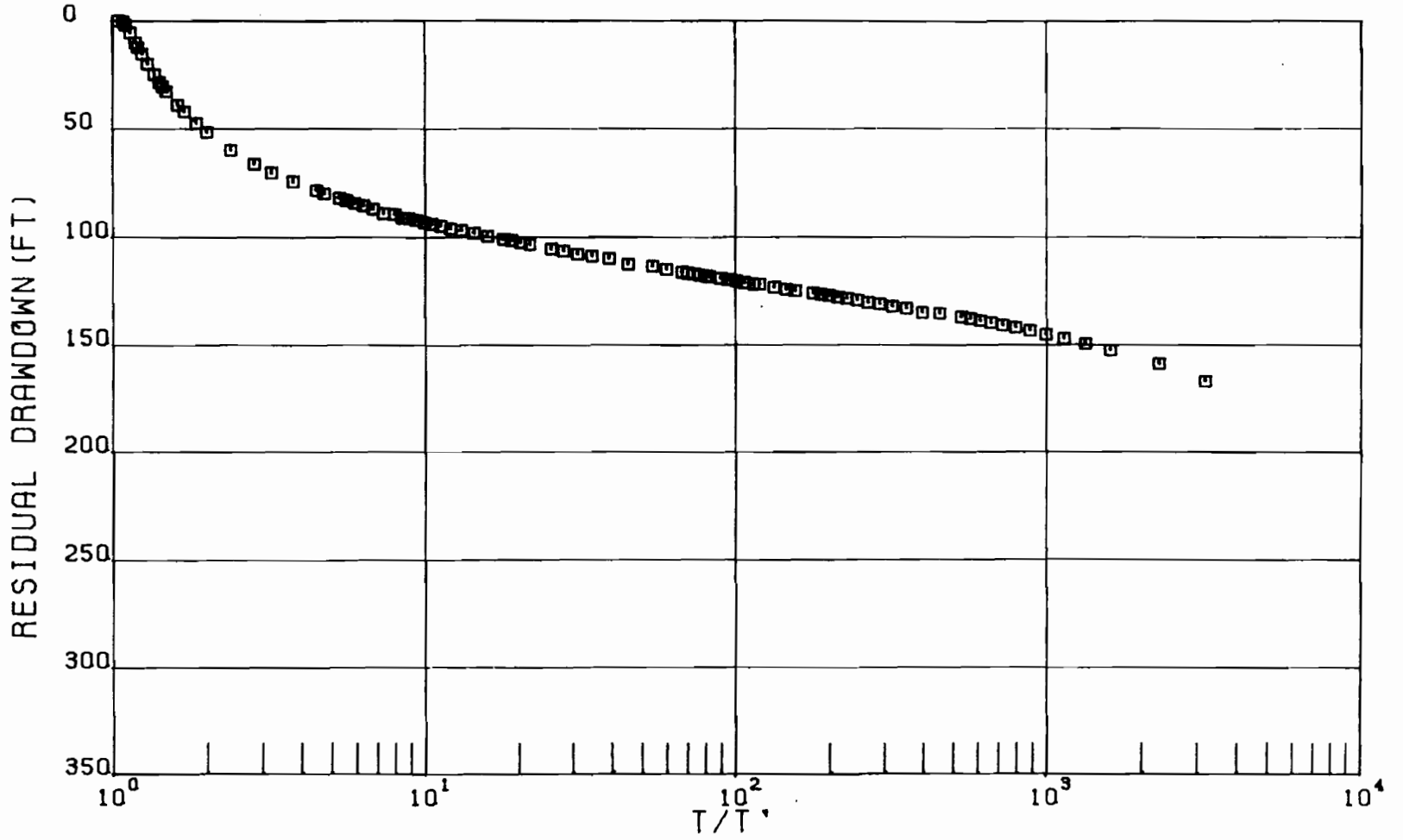

FIGURE C-2: RECOVERY GRAPH FOR D-1 WELL GROUP

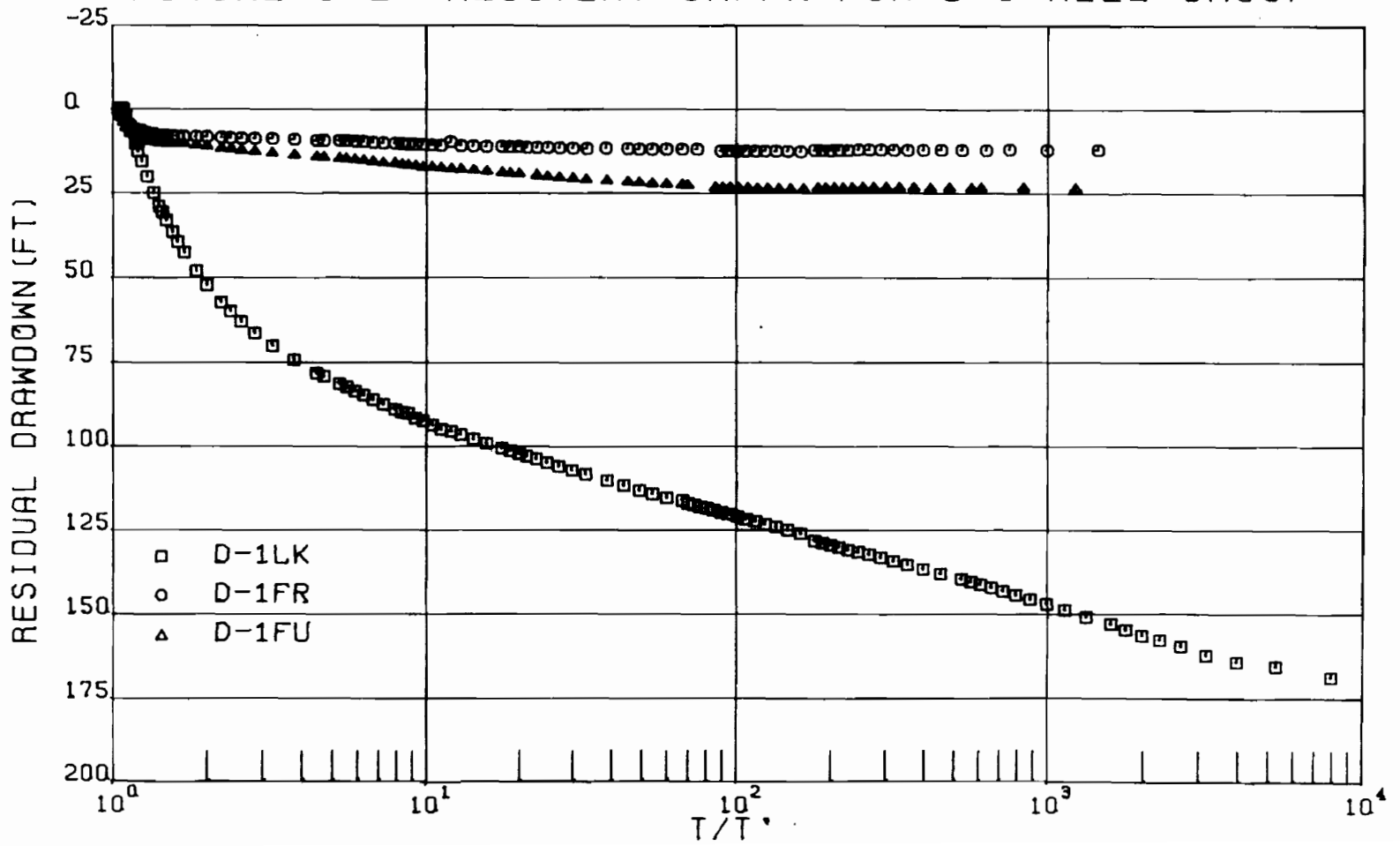

FIGURE C-3: RECOVERY GRAPH FOR WELL D-2LK

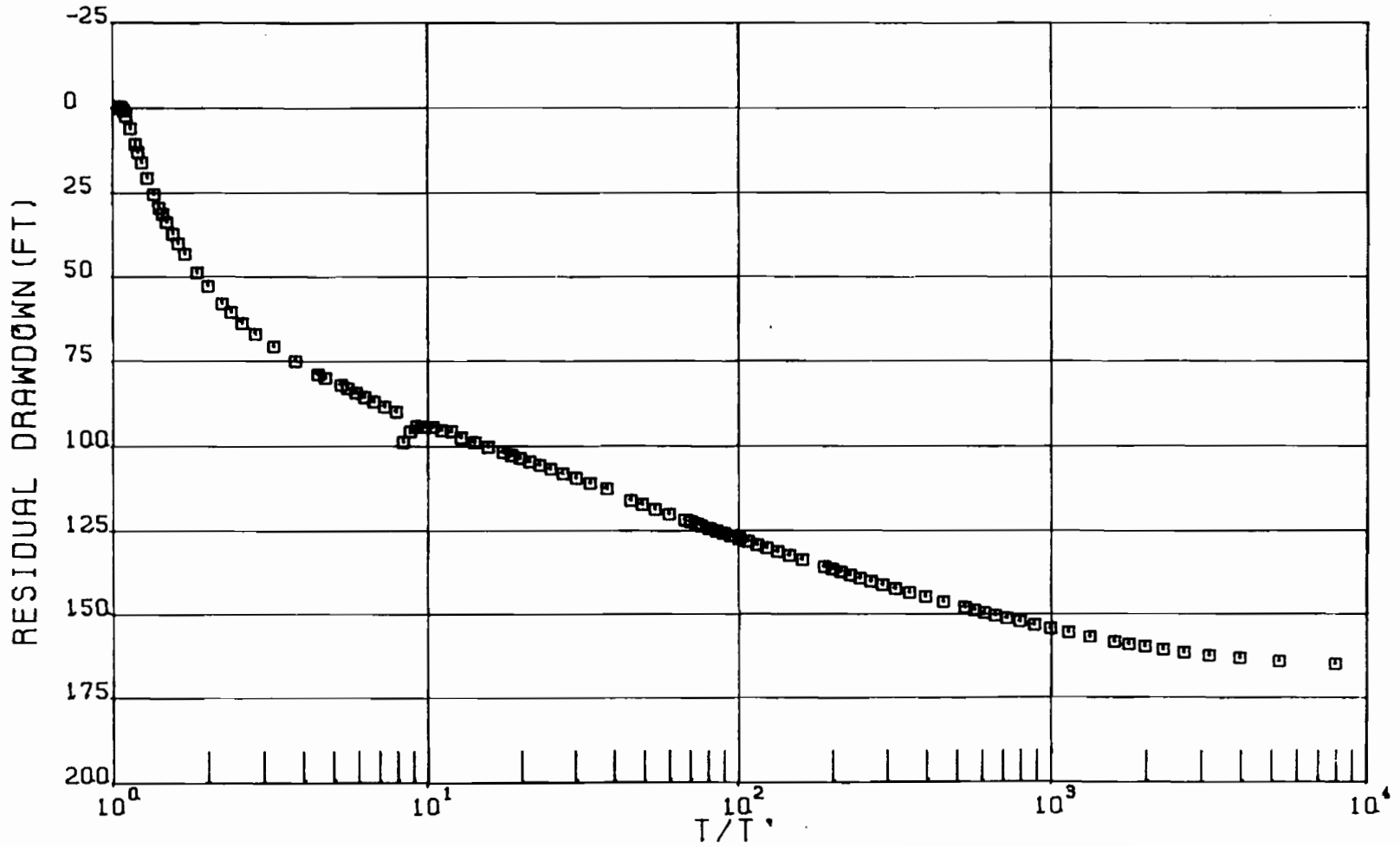

FIGURE C-4: RECOVERY GRAPH FOR D-3 WELL GROUP

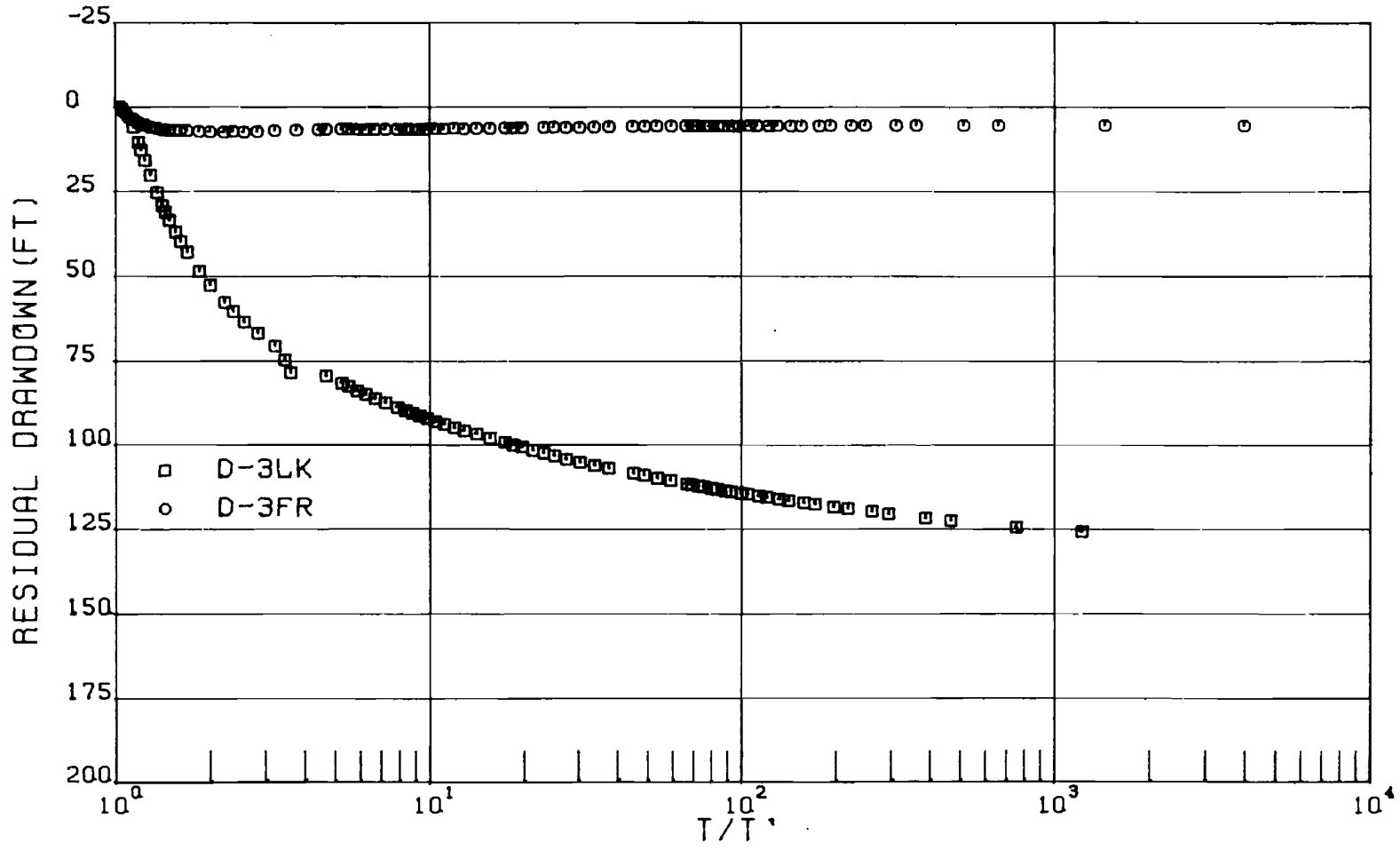

FIGURE C-5: RECOVERY GRAPH FOR D-4 WELL GROUP

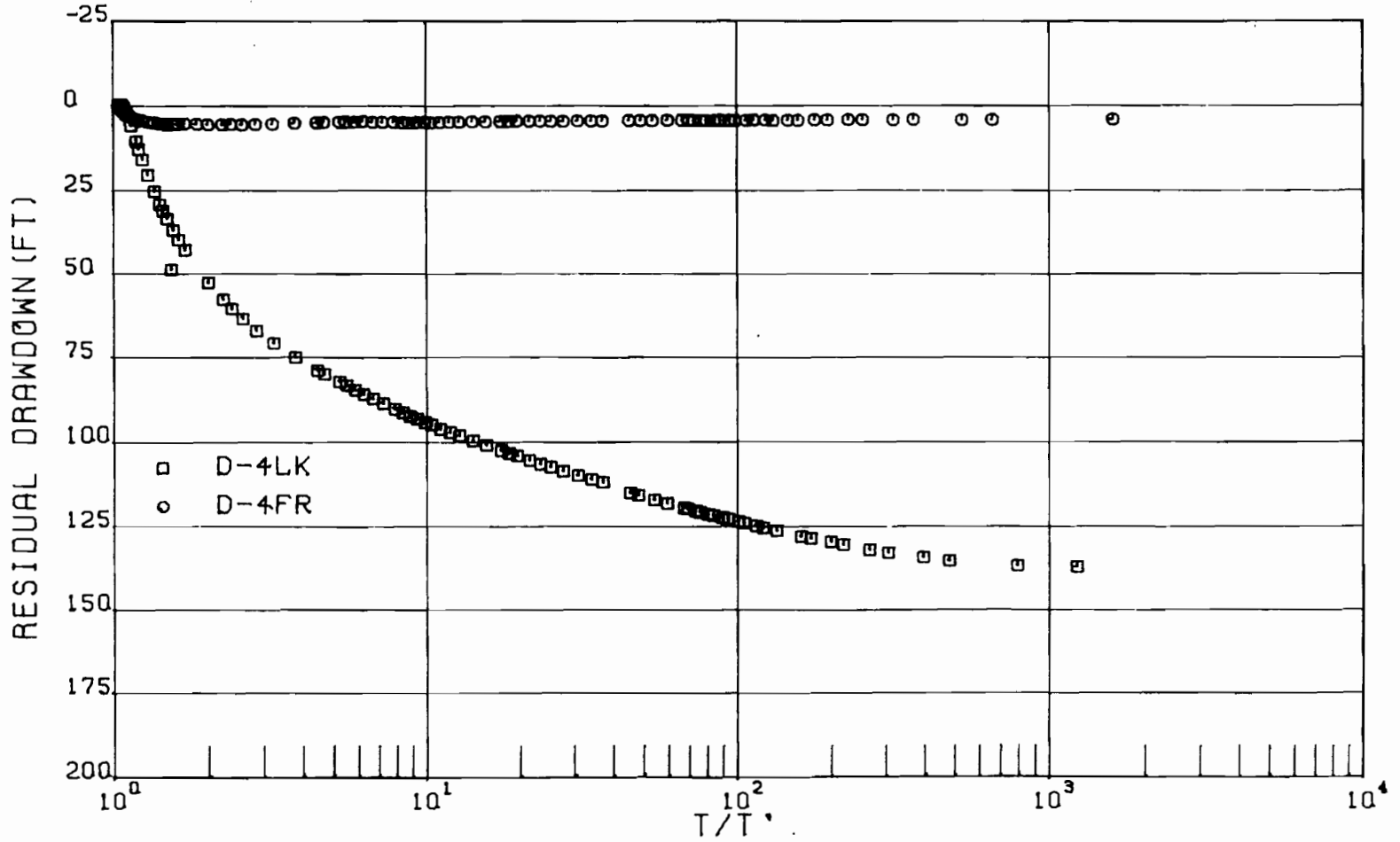



FIGURE C-6: RECOVERY GRAPH FOR WELL D-5LK

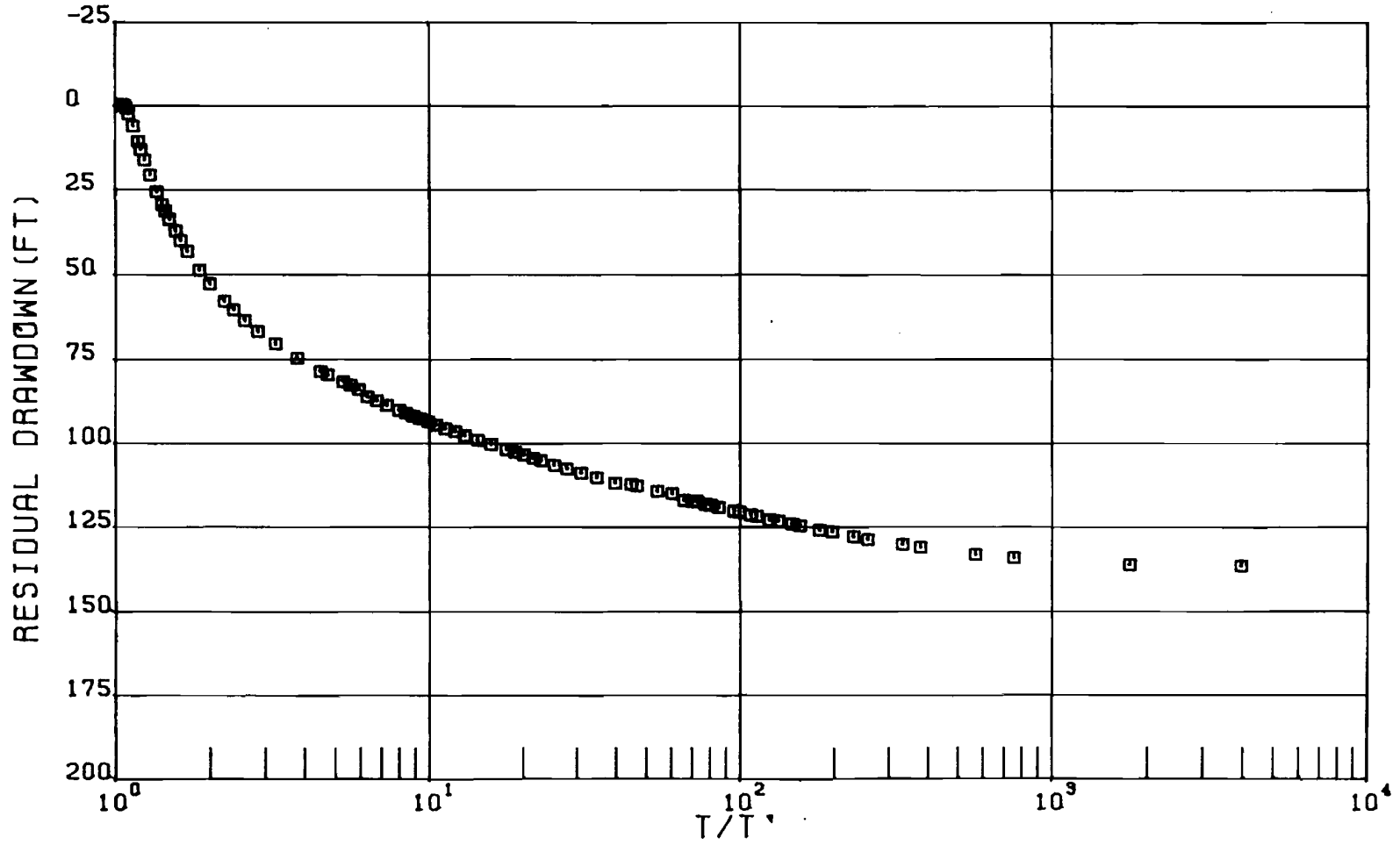

FIGURE C-7: RECOVERY GRAPH FOR WELL D-6LK

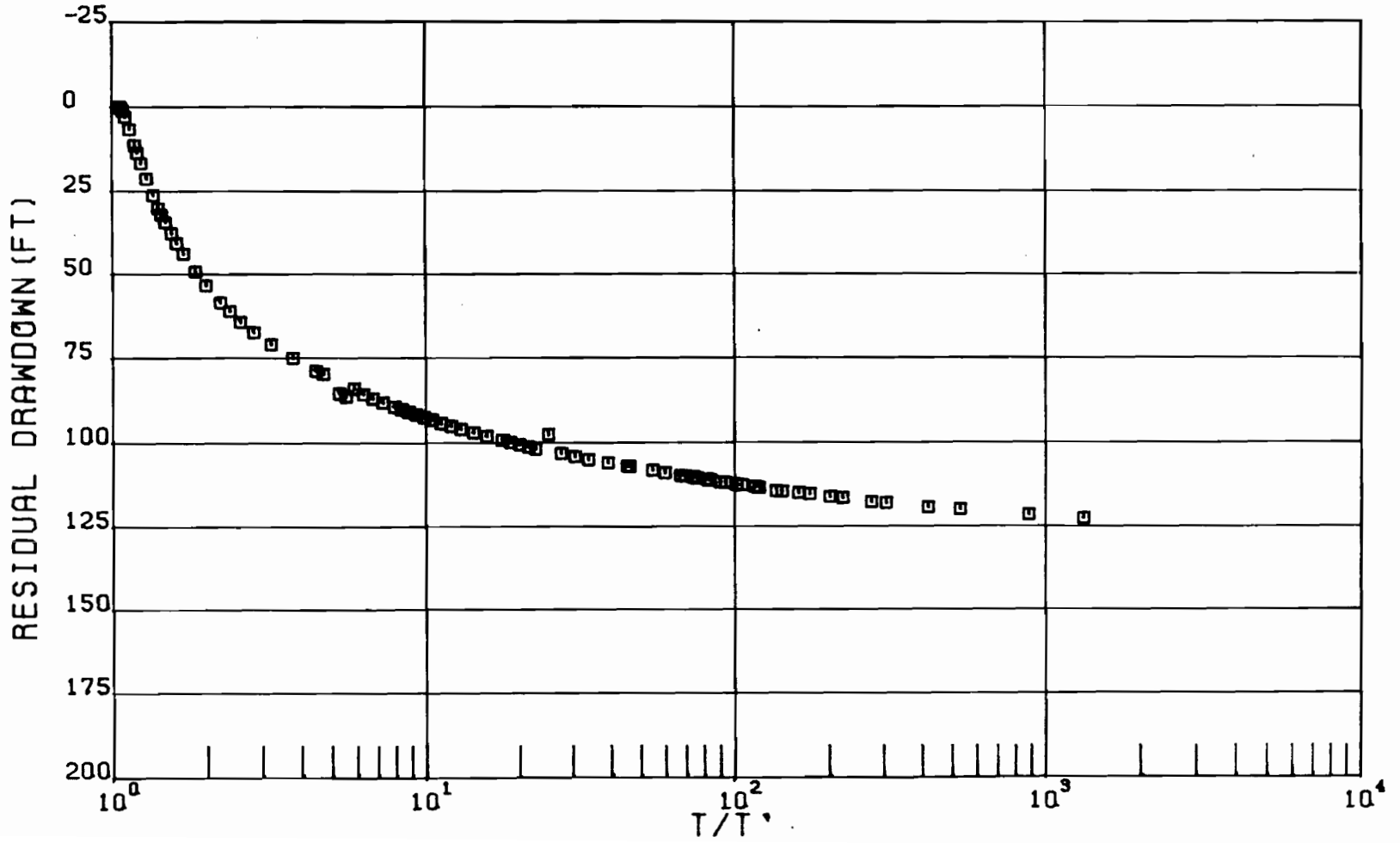

FIGURE C-9: RECOVERY GRAPH FOR WELL D-20LK

