



United States  
Environmental Protection  
Agency

GRI-94/0257.22  
EPA - 600/R-96-080e  
June 1996



# Research and Development

METHANE EMISSIONS FROM THE  
NATURAL GAS INDUSTRY  
Volume 5: Activity Factors

Prepared for

Energy Information Administration (U. S. DOE)

Prepared by

National Risk Management  
Research Laboratory  
Research Triangle Park, NC 27711

## FOREWORD

The U.S. Environmental Protection Agency is charged by Congress with protecting the Nation's land, air, and water resources. Under a mandate of national environmental laws, the Agency strives to formulate and implement actions leading to a compatible balance between human activities and the ability of natural systems to support and nurture life. To meet this mandate, EPA's research program is providing data and technical support for solving environmental problems today and building a science knowledge base necessary to manage our ecological resources wisely, understand how pollutants affect our health, and prevent or reduce environmental risks in the future.

The National Risk Management Research Laboratory is the Agency's center for investigation of technological and management approaches for reducing risks from threats to human health and the environment. The focus of the Laboratory's research program is on methods for the prevention and control of pollution to air, land, water, and subsurface resources; protection of water quality in public water systems; remediation of contaminated sites and groundwater; and prevention and control of indoor air pollution. The goal of this research effort is to catalyze development and implementation of innovative, cost-effective environmental technologies; develop scientific and engineering information needed by EPA to support regulatory and policy decisions; and provide technical support and information transfer to ensure effective implementation of environmental regulations and strategies.

This publication has been produced as part of the Laboratory's strategic long-term research plan. It is published and made available by EPA's Office of Research and Development to assist the user community and to link researchers with their clients.

E. Timothy Oppelt, Director  
National Risk Management Research Laboratory

## EPA REVIEW NOTICE

This report has been peer and administratively reviewed by the U.S. Environmental Protection Agency, and approved for publication. Mention of trade names or commercial products does not constitute endorsement or recommendation for use.

This document is available to the public through the National Technical Information Service, Springfield, Virginia 22161.

GRI-94/0257.22

EPA-600/R-96-080e

June 1996

**METHANE EMISSIONS FROM  
THE NATURAL GAS INDUSTRY,  
VOLUME 5: ACTIVITY FACTORS**

**FINAL REPORT**

Prepared by:

Blake E. Stapper

Radian International LLC  
8501 N. Mopac Blvd.  
P.O. Box 201088  
Austin, TX 78720-1088

DCN: 95-263-081-14

For

GRI Project Manager: Robert A. Lott  
GAS RESEARCH INSTITUTE  
Contract No. 5091-251-2171  
8600 West Bryn Mawr Ave.  
Chicago, IL 60631

and

EPA Project Manager: David A. Kirchgessner  
U.S. ENVIRONMENTAL PROTECTION AGENCY  
Contract No. 68-D1-0031  
National Risk Management Research Laboratory  
Research Triangle Park, NC 27711

## DISCLAIMER

**LEGAL NOTICE:** This report was prepared by Radian International LLC as an account of work sponsored by Gas Research Institute (GRI) and the U.S. Environmental Protection Agency (EPA). Neither EPA, GRI, members of GRI, nor any person acting on behalf of either:

- a. Makes any warranty or representation, express or implied, with respect to the accuracy, completeness, or usefulness of the information contained in this report, or that the use of any apparatus, method, or process disclosed in this report may not infringe privately owned rights; or
- b. Assumes any liability with respect to the use of, or for damages resulting from the use of, any information, apparatus, method, or process disclosed in this report.

**NOTE:** EPA's Office of Research and Development quality assurance/quality control (QA/QC) requirements are applicable to some of the count data generated by this project. Emission data and additional count data are from industry or literature sources, and are not subject to EPA/ORD's QA/QC policies. In all cases, data and results were reviewed by the panel of experts listed in Appendix D of Volume 2.

## RESEARCH SUMMARY

Title	Methane Emissions from the Natural Gas Industry, Volume 5: Activity Factors Final Report
Contractor	Radian International LLC  GRI Contract Number 5091-251-2171 EPA Contract Number 68-D1-0031
Principal Investigator	Blake E. Stapper
Report Period	March 1991 - June 1996 Final Report
Objective	This report describes a study to quantify the national activity factors for the methane emission source types in the gas industry.
Technical Perspective	<p>The increased use of natural gas has been suggested as a strategy for reducing the potential for global warming. During combustion, natural gas generates less carbon dioxide (CO<sub>2</sub>) per unit of energy produced than either coal or oil. On the basis of the amount of CO<sub>2</sub> emitted, the potential for global warming could be reduced by substituting natural gas for coal or oil. However, since natural gas is primarily methane, a potent greenhouse gas, losses of natural gas during production, processing, transmission, and distribution could reduce the inherent advantage of its lower CO<sub>2</sub> emissions.</p> <p>To investigate this, Gas Research Institute (GRI) and the U.S. Environmental Protection Agency's Office of Research and Development (EPA/ORD) cofunded a major study to quantify methane emissions from U.S. natural gas operations for the 1992 base year. The results of this study can be used to construct global methane budgets and to determine the relative impact on global warming of natural gas versus coal and oil.</p>
Results	Activity factors are documented for use in determining the total emissions from the natural gas industry. Since there are very few published activity factors for the gas industry, many activity factors were developed specifically for this study. Confidence intervals were calculated for the activity factors so that the overall accuracy could be determined. Precautions were also taken to ensure that the activity factors are statistically representative of the industry.

The program reached its accuracy goal and provides an accurate estimate of methane emissions that can be used to construct U.S. methane inventories and analyze fuel switching strategies.

Technical  
Approach

Since it is impractical to sample emissions from every source in the natural gas industry, it is necessary to develop a method of scaling up the sampled emissions from a representative set of sources within the industry. The activity factor extrapolation method was developed for this purpose.

This method is used to scale-up the average annual emissions from a source (determined by a limited sampling effort) to represent the entire emissions from the national population of similar sources in the gas industry. The typical activity factor extrapolation approach uses emission factors (EF) and activity factors (AF) to do this. An emission factor for a source category is defined as the average annual emissions per source. Activity factors are the number of sources in the entire target population or source category. Thus, the product of the EF and the AF equals the annual national emissions from a specific source in the natural gas industry. Since there are very few published activity factors for the gas industry, many were developed specifically for this study.

The accuracy of the activity factors is dependent upon precision and bias. The precision of the activity factors was determined by calculating the 90% confidence limits. Potential bias in the activity factors were eliminated by three methods: peer review by experienced sources, analysis of the data, and extrapolation by different parameters.

Project  
Implications

For the 1992 base year the annual methane emissions for the U.S. natural gas industry are 314 Bscf  $\pm$  106 Bscf ( $\pm$  34%). This is equivalent to 1.4%  $\pm$  0.5% of 1992 gross natural gas production. Results from this program were used to compare greenhouse gas emissions from the fuel cycle for natural gas, oil, and coal using the global warming potentials (GWPs) recently published by the Intergovernmental Panel on Climate Change (IPCC). The analysis showed that natural gas contributes less to potential global warming than coal or oil, which supports the fuel switching strategy suggested by IPCC and others.

In addition, results from this study are being used by the natural gas industry to reduce operating costs while reducing emissions. Some companies are also participating in the Natural Gas-Star program, a voluntary program sponsored by EPA's Office of Air and Radiation in cooperation with the American Gas Association to implement cost-effective emission reductions and to report reductions to EPA. Since this program was begun after the 1992 baseline year, any reductions in

methane emissions from this program are not reflected in this study's total emissions.

Robert A. Lott  
Senior Project Manager, Environment and Safety

## TABLE OF CONTENTS

	Page
1.0 SUMMARY .....	1
2.0 INTRODUCTION .....	2
3.0 GAS INDUSTRY CHARACTERIZATION .....	4
3.1 Natural Gas Industry Definition .....	4
3.2 Production Segment Definition .....	6
3.3 Gas Processing Segment Definition .....	9
3.4 Transmission and Storage Segment Definition .....	10
3.5 Distribution Segment Definition .....	13
4.0 DEVELOPMENT OF ACTIVITY FACTORS .....	15
4.1 Definition of Activity and Emission Factors .....	15
4.2 Effect of Sampling Approach on Activity Factors .....	15
4.3 Activity Factor Sources .....	16
4.4 Extrapolation of Site Activity Factor Data .....	17
4.4.1 Selection of Site-Weighted (Ratio) Extrapolation Technique .....	19
4.4.2 Extrapolation Parameter Selection .....	20
4.5 Activity Factor Accuracy .....	21
4.5.1 Precision .....	23
4.5.2 Propagation of Error .....	24
4.5.3 Screening for Bias .....	26
5.0 PRODUCTION SEGMENT .....	28
5.1 Development of a Regional Approach .....	28
5.2 Gas Well Count and Production (Onshore and Offshore) .....	34
5.3 Oil Well Count and Production (Onshore and Offshore) .....	34
5.4 Oil Wells Marketing Gas .....	35
5.5 Offshore Platforms .....	36
5.6 Specific Equipment .....	39
5.7 Vessels and Pressure Relief Valves .....	40
5.8 Gathering Pipeline Miles .....	46
5.9 Maintenance Activities .....	48
5.10 Compressors and Dehydrators .....	50



**TABLE OF CONTENTS**  
(Continued)

	Page
6.0 GAS PROCESSING SEGMENT .....	51
6.1 Gas Plant Count .....	51
6.2 Acid Gas Recovery (AGR) Units .....	52
6.3 Compressors and Dehydrators .....	52
7.0 TRANSMISSION SEGMENT .....	53
7.1 Compressor Station Count .....	53
7.2 Storage Station Count .....	56
7.3 Storage Well Count .....	57
7.4 M&R Station Count .....	57
7.5 Miles of Pipeline .....	60
7.6 Compressors and Dehydrators .....	60
7.7 Pneumatics .....	60
8.0 CROSS-SEGMENT ACTIVITY FACTORS .....	61
8.1 Compressors .....	61
8.1.1 Compressor Horsepower-Hours .....	61
8.1.2 Compressor Counts .....	67
8.2 Dehydrators .....	70
8.2.1 Dehydrator Count .....	70
8.2.2 Dehydrator Throughput .....	72
8.2.3 Dehydrator Flash Drums .....	75
8.2.4 Dehydrator Gas Pumps .....	75
8.2.5 Dehydrator Stripping Gas Use .....	75
8.2.6 Dehydrator Vapor Recovery Use .....	76
9.0 DISTRIBUTION SEGMENT .....	78
9.1 Distribution Annual Equivalent Leaks .....	78
9.2 Distribution Metering and Pressure Regulating Stations .....	85
9.3 Customer Meters .....	87
9.4 Distribution Mains and Services .....	89
10.0 RESULTS .....	90
11.0 REFERENCES .....	93
APPENDIX A - Site Data .....	A-1
APPENDIX B - Methods for Estimating Activity Factors .....	B-1
APPENDIX C - Conversion Table .....	C-1

## LIST OF FIGURES

	<b>Page</b>
3-1 Gas Industry Flow Chart .....	5
3-2 Industry Boundaries .....	7
3-3 Gas Processing Plant .....	11
3-4 Transmission and Storage Stations .....	12
3-5 Distribution Segment Equipment .....	14
5-1 Major Producing States .....	29
5-2 Selected Production Regions .....	30
B-1 Conceptual Comparison of Normal and Lognormal Distributions .....	B-4
B-2 Comparison of 90% Confidence Limits .....	B-7
B-3 Distribution of Separators per Well .....	B-8
B-4 Ratio of Separators per Unit of Production .....	B-9

## LIST OF TABLES

	Page
4-1 Nationally-Tracked Activity Factors .....	17
4-2 Production Extrapolation Parameter Selection .....	22
4-3 Error Propagation for a Sum .....	25
4-4 Error Propagation for a Product .....	25
5-1 Regional Differences in Production Rates and Well Counts .....	31
5-2 Sample Set Comparison to Actual Regional Data .....	33
5-3 National Gas Industry Wells .....	37
5-4 Platform Counts .....	39
5-5 Specific Equipment Activity Factors .....	40
5-6 Separators in Production .....	41
5-7 In-Line Heaters in Production .....	42
5-8 Pneumatic Devices in Production .....	43
5-9 Chemical Injection Pumps in Production .....	44
5-10 Compressors (Non-Gas Lift) in Production .....	45
5-11 Pressure Relief Valves .....	46
5-12 Production Gathering Pipeline Mileage - Gas Wells .....	48
6-1 Divisions of Gas Processing Plants by Type .....	51
7-1 Transmission Compressor Station Counts .....	54
7-2 Transmission M&R Station Populations .....	59
8-1 Compressor Activity Factors for Each Industry Segment .....	62
8-2 Compressor Counts in the Gas Industry .....	68

**LIST OF TABLES**  
**(Continued)**

	<b>Page</b>
8-3 U.S. Gas Industry Dehydrator Counts .....	71
8-4 Industry Segment Glycol Dehydrator Throughput .....	73
8-5 U.S. Gas Industry Dehydrator Flash Drums .....	76
8-6 Site Survey Gas Pump Data .....	76
8-7 Site Survey Stripping Gas and Vapor Recovery Data .....	77
9-1 National Leak Repairs Allocated by Pipe Material Category .....	80
9-2 Summary of Leak Record Data from Participating Companies .....	83
9-3 Summary of Activity Factors for Distribution Underground Pipelines .....	84
9-4 Activity Data Provided by Individual Companies .....	86
9-5 Summary of Activity Factors for Distribution Metering/ Pressure Regulating Stations .....	88
10-1 Well-Defined Activity Factors .....	90
10-2 Examples of Developed Activity Factors .....	91
A-1 Production Sites (Summary) .....	A-2
A-2 Production Sites (Offshore Data) .....	A-3
A-3 Production Sites (Gulf Coast Onshore Data) .....	A-4
A-4 Production Sites (Central Plains Data) .....	A-5
A-5 Production Sites (Pacific/Mountain Onshore Data) .....	A-6
A-6 Production Sites (Atlantic & Great Lakes Data) .....	A-7
A-7 Gas Processing Plants .....	A-9

**LIST OF TABLES**  
**(Continued)**

	<b>Page</b>
A-8 Transmission Compressor Stations .....	A-10
A-9 Storage Compressor Stations .....	A-12



## 1.0

## SUMMARY

This document is one of several volumes that provide background information supporting the Gas Research Institute and U.S. Environmental Protection Agency Office of Research and Development (GRI-EPA/ORD) methane emissions project. The objective of this comprehensive program is to quantify the methane emissions from the gas industry for the 1992 base year to within  $\pm 0.5\%$  of natural gas production starting at the wellhead and ending immediately downstream of the customer's meter. Activity factors are needed to estimate the national emissions from the natural gas industry and are based on estimated populations of equipment and equipment characteristics. This report presents a definition for activity factors, methods of calculation, and this project's calculated values for industry activity factors.

## INTRODUCTION

If emissions could be sampled from *every* source in the natural gas industry, then the total national emissions for the industry could be determined by summing the emissions from each source. Unfortunately, because of the size of the industry, measuring emissions from each source is impractical. Therefore, a method of scaling up (i.e., extrapolating) the sampled emissions from a representative set of sources within the industry is necessary. The activity factor extrapolation method was developed for this purpose.

This method is used to scale-up the average annual emissions from a source (determined by a limited sampling effort) to represent the entire emissions from the national population of similar sources in the gas industry. The typical activity factor extrapolation approach uses emission factors (EF) and activity factors (AF) to do this. An emission factor for a source category is defined as the average annual emission per source. Activity factors are the number of sources in the entire target population or source category. An activity factor is usually presented as an equipment count, but a few exceptions exist, such as: 1) horsepower hours for compressors, 2) average equivalent leaks for underground pipe, and 3) events/year for maintenance activities. They can be used to estimate the nationwide emissions from the natural gas industry since emission rates are often measured on a per equipment or per activity basis. Thus, the emission factor and activity factor are defined such that their product equals the annual national emissions from a specific source in the natural gas industry.

$$EF \times AF = \text{National Emission Rate} \quad (1)$$

Since there are very few published activity factors for the gas industry, many were developed specifically for this study, especially in the production segment of the industry. This report discusses precautions taken to ensure that the data used to determine activity factors were statistically representative of the industry.



This report explains in detail how the activity factors for the GRI/EPA methane emissions project were determined for the 1992 base year. The following sections summarize the methods used to calculate gas industry activity factors. Section 3 provides the general industry characterization used to identify the equipment populations. Section 4 defines the techniques used to develop the activity factors. Sections 5 through 9 provide the specific activity factor development for equipment within each segment of the gas industry. Summary results are presented in Section 10. This report is one of several volumes under the GRI/EPA methane emissions project.

### 3.0

## GAS INDUSTRY CHARACTERIZATION

Most activity factors define equipment populations. Therefore, to determine activity factors, it is important to first define and describe the major divisions in the industry that affect the selection of specific equipment. This section of the report characterizes the industry by outlining the segments of the industry as well as the types of equipment found within each segment.

While this section draws a general picture of the industry developed by the GRI/EPA methane emissions project, it is not intended to represent a definitive picture of the industry regarding all typical operational parameters. Many details of the operation are unnecessary for development of an accurate methane emissions inventory. Other details are given in specific reports where the details were needed to estimate specific emission factors.

### 3.1

#### Natural Gas Industry Definition

The natural gas industry produces and delivers natural gas to various residential, commercial, and industrial customers. The industry uses wells to produce natural gas existing in underground formations, then processes and compresses the gas, and transports it to the customer. Transportation to the customer involves intra and interstate pipeline transportation, storage, and finally distribution of the gas by local distribution pipeline networks to the customer.

The generally accepted segments of the natural gas industry are 1) production, 2) gas processing, 3) transportation, 4) storage, and 5) distribution. Each of these segments is shown in the overall flow chart for the industry in Figure 3-1. Each segment is described in more detail in the following subsections.

This project has set specific boundaries on each segment of the industry that specify what equipment is included or excluded from the study. These boundaries were set

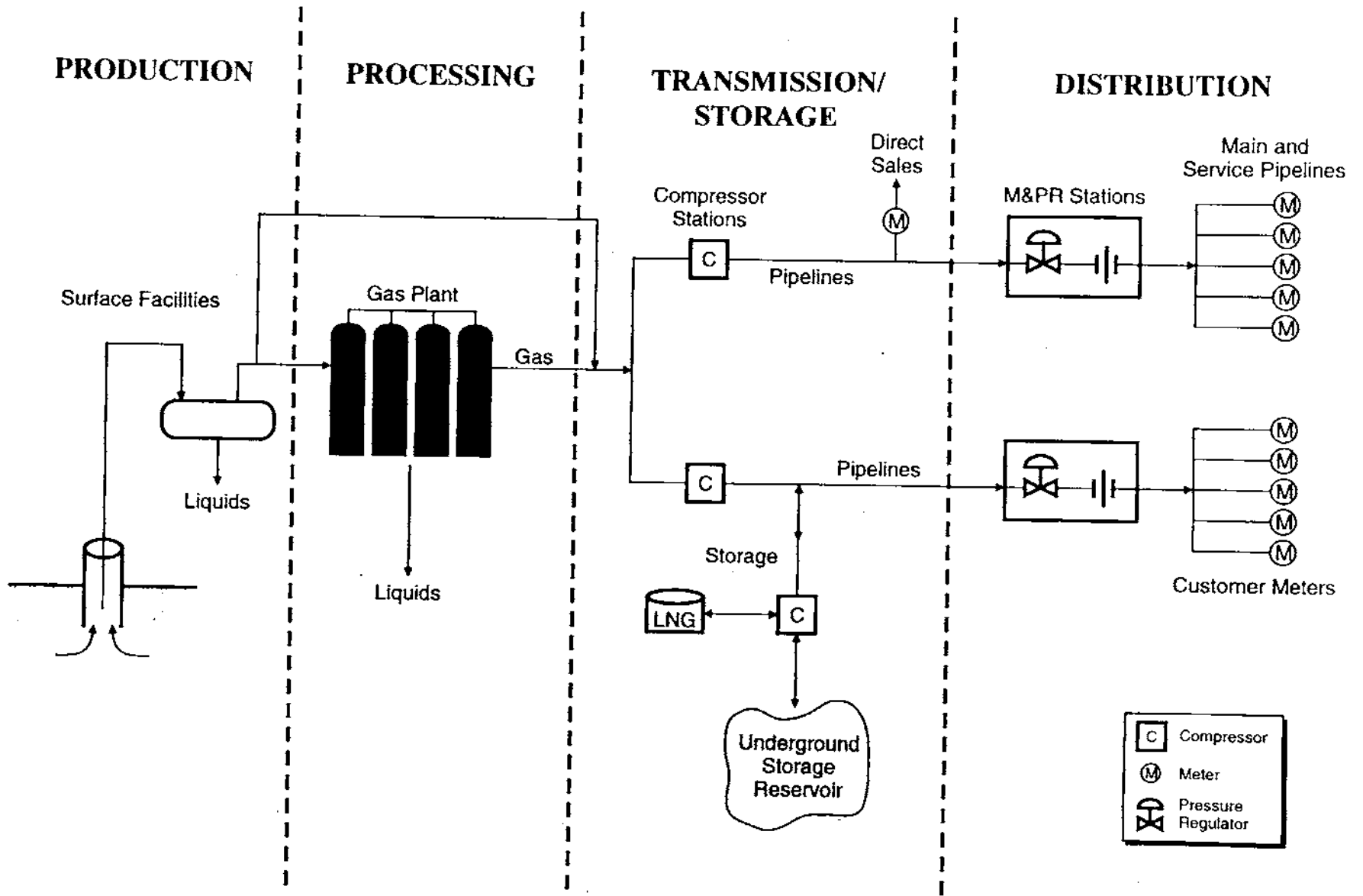

Figure 3-1. Gas Industry Flow Chart

using input from industry experts. The guideline used for setting the boundaries was to exclude equipment in each segment not required for the marketing of natural gas. For example, certain oil production equipment is excluded from the production segment since it exists to produce oil and is not needed for gas production (see Figure 3-2). Similarly, in gas processing, equipment associated with the fractionation of propane, butane, and natural gas liquids is excluded. In distribution, all equipment up to and including the customer's meter are included. End user piping, combustion, and vented emissions are not included.

### 3.2 Production Segment Definition

Emissions of methane that result from oil production, or that occur naturally (non-anthropogenic) from formations are excluded. Unmarketed natural gas, such as that produced by oil wells that vent some gas, are not considered part of the gas industry.

The production segment is composed of gas wells, oil wells, and surface equipment. The well includes the holes drilled through subsurface rock that reach the producing formation, and the subsurface equipment such as casing and tubing pipe. Gas and oil surface equipment can include separators, heaters, heater-treaters, tanks, dehydrators, compressors, pumps, and pipelines.

However, the segment definition for gas industry production equipment excludes certain equipment mainly associated with oil production. Figure 3-2 shows the general equipment found in the oil and gas production segment as well as the selected boundaries for gas industry equipment used by this study. Equipment outside the boundaries were not included in this study's activity factor estimates.

As shown in Figure 3-2, the gas industry production segment includes all equipment at gas well sites, except emissions from liquid hydrocarbon condensate or oil tanks at the site. These emissions are considered to be a result of marketing the liquid products from the well. The gas industry production segment excludes equipment that

Oil Wells

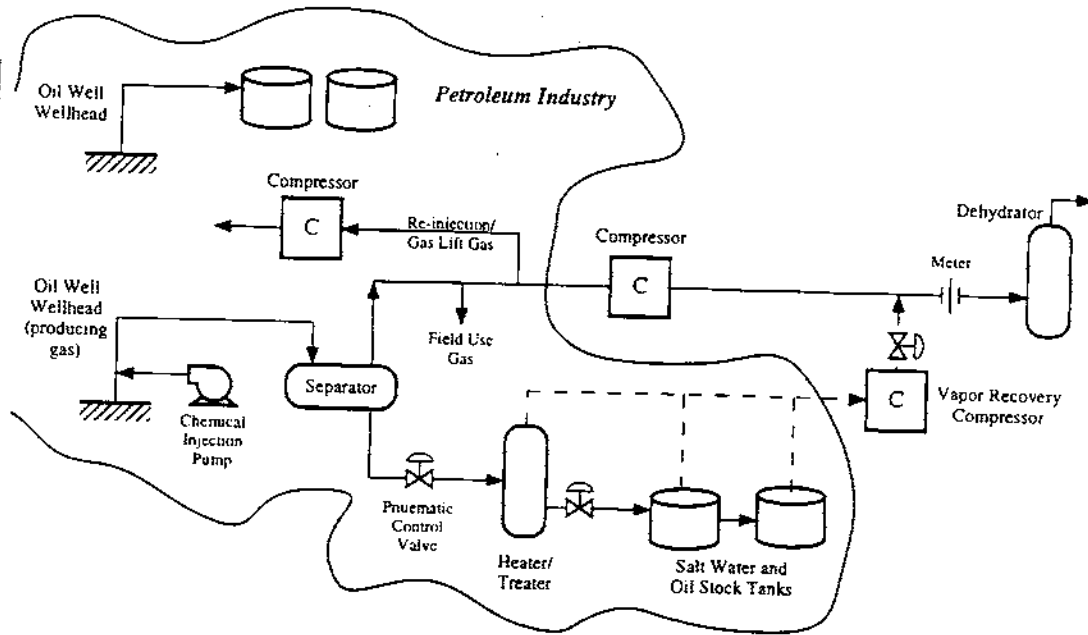

Gas Wells

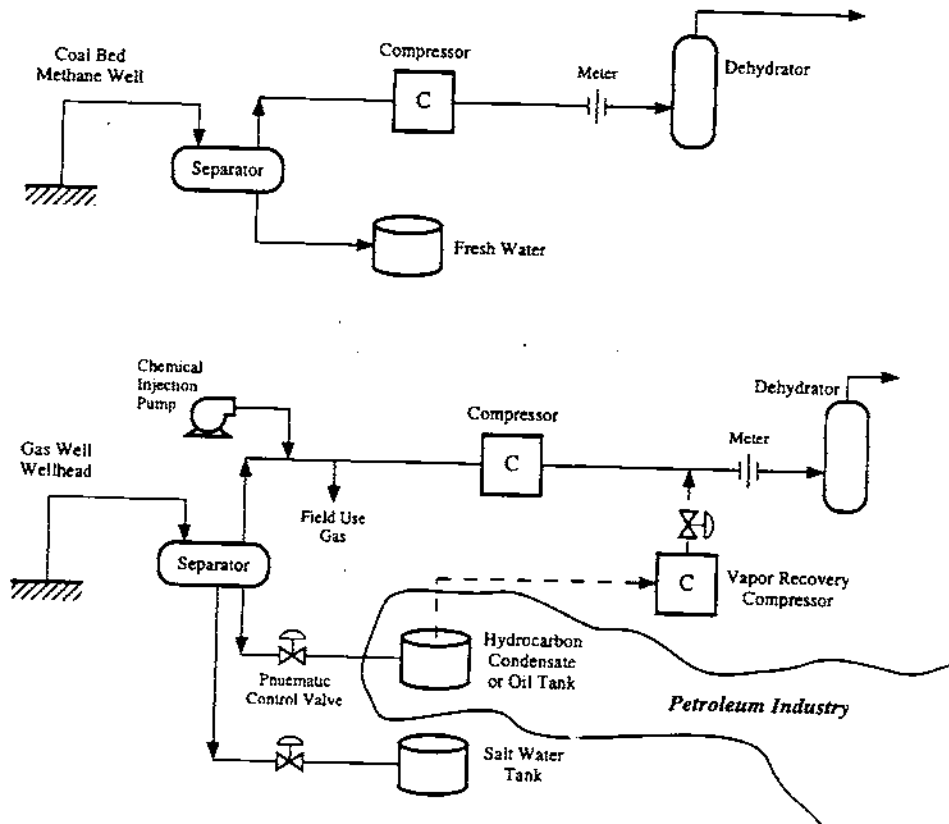

Figure 3-2. Industry Boundaries

exists primarily for the production of oil, since it would exist even if the gas were not marketed. Therefore, the definition excludes all oil tanks, and excludes equipment at all oil wells that do not market gas. In addition, it excludes much of the equipment at oil wells that do market gas. At oil wells that market gas production, the gas production is secondary and usually generates lower revenue; the well exists primarily because it produces oil. Therefore the wellhead, the separator, the pneumatic control valves, the well's chemical injection pumps, any field use gas lines, and all of the liquid piping are considered part of the oil industry and are excluded from the GRI/EPA gas industry study. The gas industry equipment begins only on the gas line downstream of the separator, at the first piece of gas line equipment, such as the sales meter, compressor, or dehydrator.

In general, an oil or oil and gas field may have centralized surface treatment facilities, or each well site may have its own independent surface facilities. In centralized facilities, all of the separators, dehydrators, and compressors may be in one location, with gas flowing in from gathering pipelines connected to many wellheads. Decentralized facilities have all the necessary surface equipment (separators, compressor, dehydrator, etc.) at each individual well site. Centralized facilities can have lower equipment counts per well than decentralized facilities. Sometimes the facilities may be primarily decentralized, but have a few centralized components. For example, separators may be at each well (decentralized), while compression and dehydration may be centralized.

Whatever the field configuration, all gas wells have a wellhead and most have a gas meter. Also independent of the field configuration, gas wells may or may not have separator(s), a dehydrator, or a compressor. The use of the equipment depends upon the free liquid production, the absorbed moisture content, and the well pressure. For example, some sweet, dry gas wells can produce directly to a pipeline. However, most wells require separation for free-liquid products (salt water, hydrocarbon condensate, and oil), and some dehydration.

Oil wells that market gas (the only oil wells included in this study) may also have centralized or individual well site facilities. They will always have a separator and a meter. As with gas wells, they may or may not have a dehydrator or a compressor, depending upon the absorbed moisture content and the pressure.

Oil wells that market gas may be either free-flowing or artificial-lift wells. Free-flowing wells often also have absorbed or co-produced gas that is marketed. Therefore, some of the equipment at these free-flowing oil wells is considered part of the gas industry if it exists to market the gas. Artificial-lift oil wells are most often not part of the gas industry, but a few do produce gas, and those few therefore are included in the gas industry definition.

Artificial-lift oil wells that have downhole pumps or surface pump jacks usually do not produce or market any gas and therefore are not part of the gas industry. Artificial-gas lift oil wells push compressed gas downhole and inject the gas into the tubing, thus using the gas to aerate the oil in the tubing string. This brings the oil back to the surface. Only the gas-lift wells that produce and market gas in excess of the amount injected are considered part of the natural gas industry. For gas-lift oil wells that market gas, the compressors associated with the gas-lift circulation are not considered to be part of the gas industry.

### **3.3 Gas Processing Segment Definition**

Natural gas processing plants exist primarily to recover high value liquid products from the gas stream and to maintain the quality (content and heating value) of the gas stream. The liquid products include natural gasoline, butane, and propane (ethane is sometimes recovered as well). The products are removed by compression and cooling or by absorption. Absorption processes use a fluid, such as lean oil, to absorb the liquid components from the gas stream in a tower; the rich oil is then heated to release the

recovered products. A compression and cooling process uses a turboexpander or a refrigeration process to supercool the natural gas so that the products will condense.

A gas plant may have fractionation towers and stabilization towers to further purify the individual components of the product stream. The back end of the gas plant, such as the fractionation train, is excluded from the gas industry definition since it exists to purify and market liquid products. The back end of the gas plant has negligible methane emissions since the liquids handled contain only trace amounts of methane.

The front end of the gas plant often contains dehydration facilities, wet gas compression, and the absorption or compression and cooling process. All gas plants are considered part of the natural gas industry. Therefore, all methane emissions from natural gas processing plants are included in this study. Figure 3-3 shows a schematic diagram of a gas plant.

#### 3.4 Transmission and Storage Segment Definition

The transmission segment moves the natural gas from the gas plant or directly from the field production to the local distribution companies. Gas is often moved across many states, such as from the Gulf Coast to the Eastern seaboard of the United States. The segment consists of large diameter pipeline, compressor stations, and metering facilities. All of these facilities and all of the equipment they contain are considered part of the natural gas industry.

Transmission compressor stations usually consist of piping manifolds, reciprocating or gas turbine (centrifugal) compressors, and generators. Dehydrators may be included but are not usually present because of upstream drying. The station may also include metering facilities. Figure 3-4 shows a schematic diagram of transmission and storage stations.



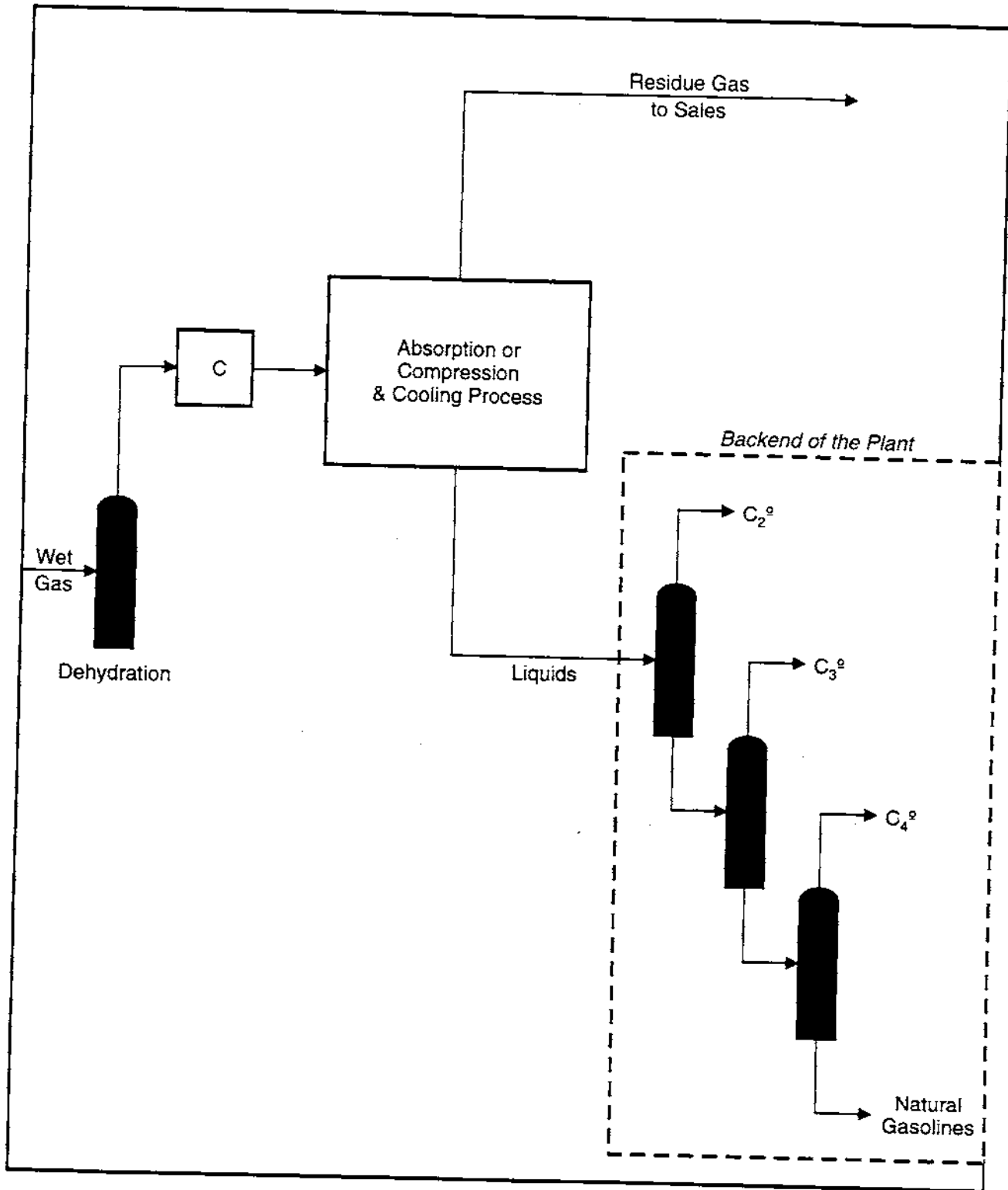

Figure 3-3. Gas Processing Plant

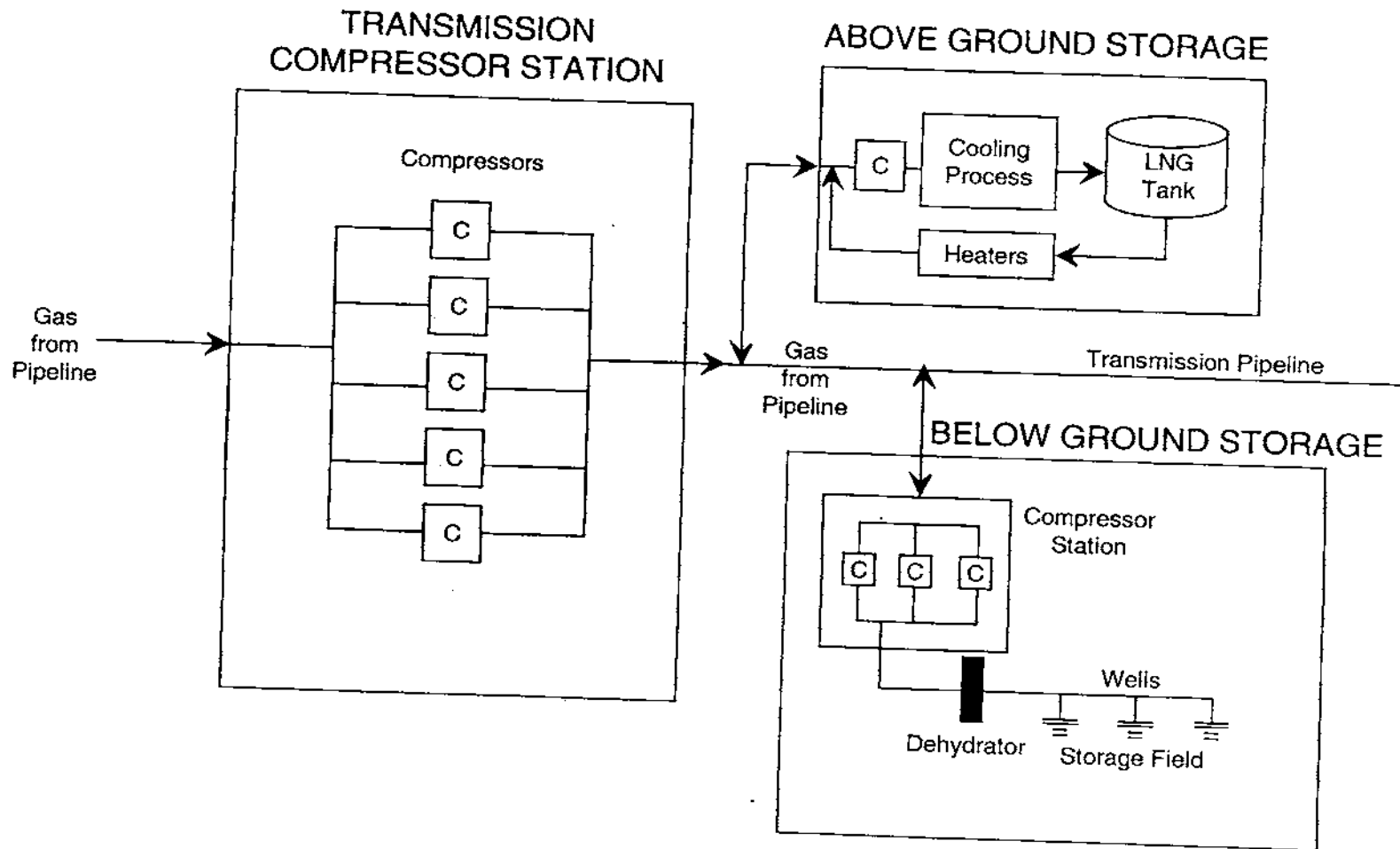

Figure 3-4. Transmission and Storage Stations

Transmission companies also have metering and regulating stations where they exchange gas with other transmission companies, or where they deliver gas to the local distribution companies (LDCs). Storage facilities exist to store natural gas produced during off-peak times (summer) so that the gas can be produced and delivered during periods of peak demand in the winter. Storage facilities are often located close to consumption centers so that the cross-country transmission pipeline does not have to be sized for peak winter demand. Storage facilities can be below ground or above ground. Above-ground facilities are liquified natural gas (LNG) facilities that liquify the gas by supercooling and then store the liquid-phase methane in above ground, heavily insulated storage tanks. Below-ground facilities compress and store the gas (in vapor phase) in one of several formations: 1) spent gas production fields, 2) aquifers, or 3) salt caverns. Below-ground storage is the predominant means of gas storage.

Most storage stations consist of a compressor station that is very similar to a transmission compression station (see Figure 3-4). Underground storage facilities also have storage field wells, and often have dehydrators to remove the water absorbed by the gas while underground. Except for emissions from underground leaks in storage formations, all storage equipment is included in the boundaries for the gas industry defined by this project.

### **3.5 Distribution Segment Definition**

The distribution segment receives high-pressure gas from the transmission pipelines, reduces the pressure, and delivers the gas to all of the residential, commercial, and industrial consumers. The segment includes pipeline (mains and services), meter and regulating stations (city gates), and customer meters. All of these facilities are considered to be an integral part of the gas industry.

Figure 3-5 shows a schematic of the distribution segment and associated equipment.

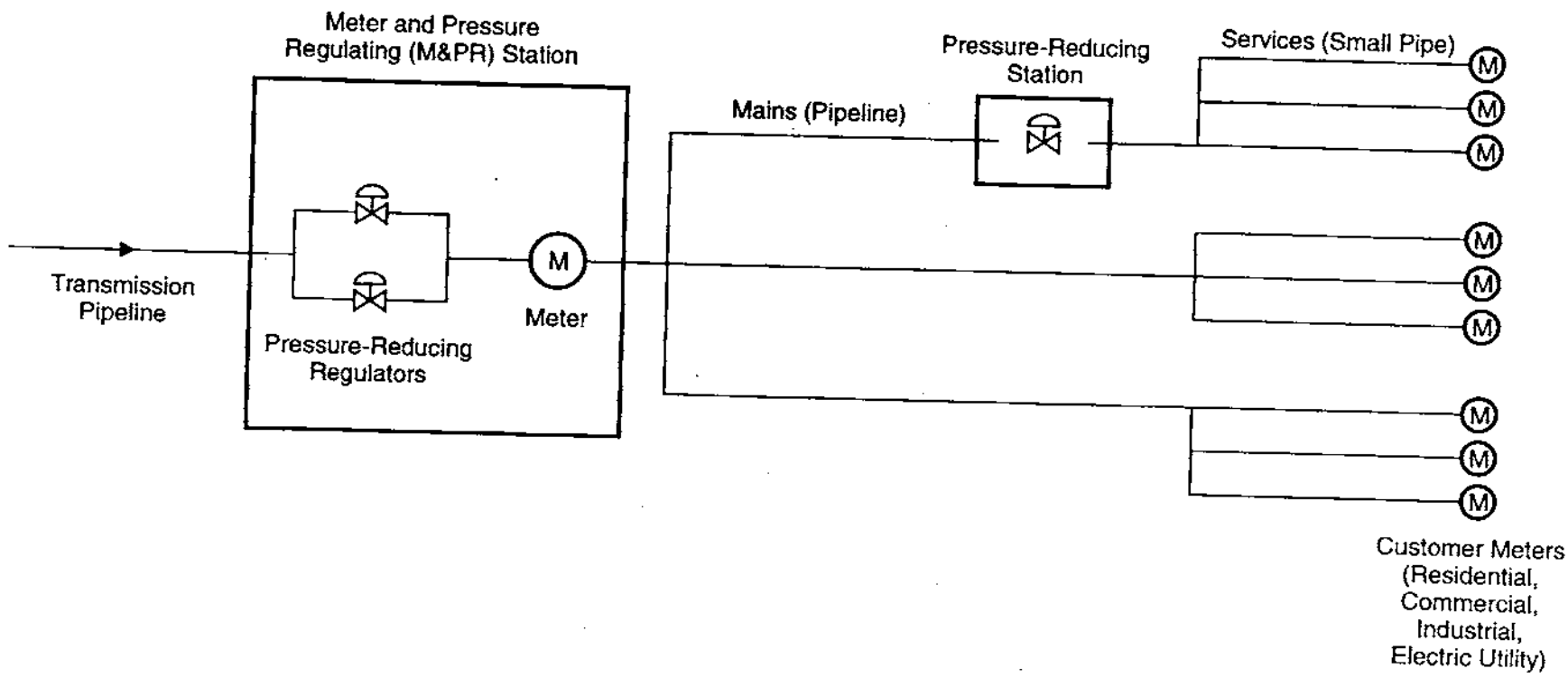

Figure 3-5. Distribution Segment Equipment

## 4.0 DEVELOPMENT OF ACTIVITY FACTORS

This section discusses the sampling approach, sources of equipment counts, and methods used to develop activity factors.

### 4.1 Definition of Activity and Emission Factors

The *activity factor* is typically defined as a count of the total population of sources in a particular category, and the *emission factor* is defined as the average annual emissions per source. Where a source category is emissions from an equipment type, the activity factor is the national population of that equipment type. Exceptions to the general definitions for the factors are those sources that have an emission rate that can be more accurately represented by a parameter that directly influences the rate of operation. (For example, the emission factor for internal combustion (IC) engines is given in terms of annual emissions per horsepower.) For such exceptions, the activity factor is defined as the parameter that influences the emissions from the source (e.g., the activity factor is annual horsepower-hours from the IC engine).

### 4.2 Effect of Sampling Approach on Activity Factors

As discussed in Volume 3 on general methodology,<sup>1</sup> the methods used to measure and collect samples directly impact the generation of activity factors. Improper sampling can easily bias the results. For this reason, particular attention was paid to the sampling methods used for this project. However, an absolutely random sample of the natural gas industry could not be ensured because participation in this program was voluntary.

In addition to ensuring as random of a sample as possible, the project team attempted to identify and compensate for any biases in the data from the sampling. For example, if regional differences in equipment configurations were known to exist, then data

were gathered and evaluated regionally to generate regional activity factors. These regional activity factors were then combined to determine a national total activity factor for a particular source type.

The project team attempted to compensate for each of the biases identified by adjusting the sampling method used. For the example of regional bias, the United States was divided into six regions to account for the regional differences in most of the activity factors, and samples were taken in each of those regions (see Section 5 for more details). No significant regional differences were observed in the major activity factors in the gas processing, transmission, or distribution segments; in these categories all samples were treated equally and averaged to produce a national figure.

#### **4.3 Activity Factor Sources**

Activity factors were determined from publications such as the American Gas Association (A.G.A.) *Gas Facts*,<sup>2</sup> company data, or through site visits.

Organizations such as A.G.A. track national statistics such as gas wells, miles of transmission and distribution pipelines, and total national production in the natural gas industry. Table 4-1 shows some of the published and well-defined activity factors. However, in many cases, the total population of a source type within the gas industry is unknown.

For sources that are not tracked nationally, data from individual companies (for the entire company) or regional surveys (surveys by state agencies or trade organizations) are sometimes available. Metering/pressure regulating stations, glycol dehydrators, and compressor engines/gas turbines are tracked on a company-wide basis or by regional organizations. For regional- or company-tracked activity factors, sufficient company/regional data had to be gathered to comprise a representative sample to extrapolate to a national population.

**TABLE 4-1. NATIONALLY-TRACKED ACTIVITY FACTORS**

<b>Segment</b>	<b>Activity Factor Name</b>	<b>Number</b>
Total Industry	1992 Gross Gas Production (Tscf)	22.13
	1992 Marketed Gas Production (Tscf)	18.71
Production	No. of Gas Wells	276,000
	No. of Oil Wells	602,200
Processing	No. of Gas Plants	726
Transmission and Storage	Miles of Trans Pipeline	284,500
	No. of Storage Facilities	475
	No. of Storage Wells	18,000
Distribution	Miles of Mains	836,760
	No. of Services	51,520,000

For sources that have an unknown population, a number of site visits were conducted to determine the number of sources at each location. The average values from multiple sites were then scaled-up to represent the total population. Site visits to collect activity factor data were typically done in conjunction with the data collection efforts for the emission factors. For the activity factors determined from site visit data, a method was needed for extrapolating the site count to a national value. The following section explains how the activity factors were determined from site visit data.

#### **4.4 Extrapolation of Site Activity Factor Data**

In the GRI/EPA study, some activity factors were determined based on extrapolative site data. For example, no data were available on the nationwide population of

production separators. The number of separators at a site, gathered as part of site visits, was divided by the number of wells at each site. Then, the average ratio of separators to wells from all site visit data was used to extrapolate nationally by multiplying by the national well count. This method of scaling-up the site visit data uses *extrapolation parameters* (EP), a well-defined, published factor that can relate the activity between the site and the national or regional level. The EPs are usually one of the nationally-tracked activity factors presented in Table 4-1.

Equipment activity factors from one individual site's data ( $AF_S$ ) can be extrapolated to regional or national activity factors ( $AF_R$  or  $AF_N$ , respectively) by using EP. Examples of extrapolation parameters are the number of wells for production and storage, the number of plants for processing, and gas throughput for all segments of the industry.

To scale-up a site activity factor to the regional or national level, the site activity factor must be divided by the extrapolation parameter for that site and multiplied by the regional or national value for the extrapolation parameter. In effect, the site activity factor ( $AF_S$ ) is being multiplied by the ratio of two known factors: one on the site basis ( $EP_S$ ) and the other at the regional ( $EP_R$ ) level. This is illustrated in the following equation:

$$\left(\frac{AF}{EP}\right)_S EP_R = AF_R \quad (2)$$

Determining the ratio of the site activity factor to the site extrapolation parameter for multiple sites within a region can be done using one of two equations: a site-weighted method or an approach using an average count per site (not site-weighted). The first uses a ratio of the summation of activity factors for all sites to the summation of extrapolation parameters for all sites:



$$(AF/EP)_s = \frac{\sum_{i=1}^n AF_i}{\sum_{i=1}^n EP_i} \quad \begin{array}{l} \text{Method 1: (3)} \\ \text{(Site-weighted)} \end{array}$$

where  $n$  = number of sites. The second is an average of individual site ratios. This equation determines the ratio to be used for scale-up,  $(AF/EP)_s$ , by summing the ratio of the site activity factor to the extrapolation factor,  $(AF/EP)_i$ , calculated independently for each site.

$$(AF/EP)_s = \frac{\sum_{i=1}^n (AF/EP)_i}{n} \quad \begin{array}{l} \text{Method 2: (4)} \\ \text{(Not site-weighted)} \end{array}$$

#### 4.4.1 Selection of Site-Weighted (Ratio) Extrapolation Technique

The site-weighted method (Equation 3) was selected for the extrapolation technique for all production activity factors. In project review meetings, this technique was accepted by production industry representatives and their company statisticians as the best approach. The site-weighted approach is based on the assumption that the sites are randomly sampled, so that a large site is proportionately representative of a large section of the population. The site-weighted method, which will hereafter be referred to as the ratio method is discussed in greater detail in Appendix B.

The non-weighted approach was initially used in earlier drafts of this report as the extrapolation method. It was based upon an assumption that the "representativeness" of any site could not be determined. It assumed that a small sampled site (15 wells) may actually be part of a heterogeneous large field (10,000 wells), while a large site (100 wells) might be the full sample of a small field. However, industry reviewers found that this assumption was not the best representation for the production segment, and therefore the ratio method was used. The ratio method was also used in the gas processing, transmission, and storage segments.

#### 4.4.2 Extrapolation Parameter Selection

Some equipment activity factors can be scaled up by any of several available extrapolation parameters (EP). These parameters must be known for each site as well as for the national or regional total. For example, in the production segment there are only three extrapolation parameters: 1) gas well count, 2) gas production rate, and 3) total "gas industry" well count. Gas wells are simply the total count of gas wells at the site, and gas production rate is the rate of gas marketed from the site. Both of these values are well known for the nation and for the region. "Gas industry" wells are the sum of gas wells plus the oil wells that market gas (oil-only wells are not counted). This last extrapolation parameter is not known exactly, since the regional or national number of oil wells marketing gas is not known. Nevertheless, the number of oil wells marketing gas was determined to a reasonable degree of accuracy (see Section 5.5).

If there was a physical or technical relation between the equipment and one of the three candidates for the extrapolation parameters (EP), then that parameter was selected. This was the case, for example, for in-line heaters and chemical injection pumps, which are related to well count based on engineering design reasons. However, where the relation between the source population and various extrapolation parameters is not definitive from a technical perspective, a single EP cannot be selected. Therefore some alternate approaches for combining the various EP's can be used, such as: 1) averaging the results from both methods of EP extrapolation, or 2) statistically analyzing the data to determine the best approach.

For example, statistical analysis was used in selecting the activity factor determination for meter stations in distribution. It was not clear from a technical perspective whether to scale-up the number of metering/pressure regulating stations by miles of main pipeline or by system throughput, which were the only known population statistics. The station counts from individual companies were examined both on a per mile of main and per

system throughput basis. A linear regression analysis showed that extrapolating the data using a per mile main basis produced less variability in the national extrapolation.

In the production segment, Radian examined the technical relationship between equipment and the three extrapolation parameters (gas well counts, total well counts, or production rate). The EP selected was based upon Radian's and the industry reviewer's knowledge of production operations. If the equipment was most strongly related to one parameter, and not related or very weakly related to the other parameters, then the first parameter was selected. If there was a rationale for a strong technical relation between both, then an average of the approaches was used.

In several cases, the total "gas industry well" count could be excluded as an EP if the boundaries selected (see Figure 3-2) excluded that equipment on associated oil wells. In many cases, there was a reason to expect that equipment counts were related to both well counts and production rate. This was true for pneumatics, separators, and compressors.

The rationale for relation to both parameters on this equipment is as follows. Surface facilities may be organized as central facilities or individual well site facilities. If surface facilities are sited on individual well sites, which occurs frequently, then a relation between equipment count and wells would be expected. If the equipment was sited at central facilities, then it might be specified and sized based purely upon production rate. Since both relations clearly existed, the average was selected. The production activity factors, extrapolation parameters, and the basis for the selection are listed in Table 4-2.

#### 4.5 Activity Factor Accuracy

Determining the accuracy of the activity factor is a key part of estimating the accuracy of the national emission rate. Accuracy is dependent on precision and bias, as discussed in Volume 3 on general methodology<sup>1</sup> and Volume 4 on statistical methodology.<sup>3</sup>

**TABLE 4-2. PRODUCTION EXTRAPOLATION PARAMETER SELECTION**

Activity Factor	Extrapolation Parameter(s) Selected	Basis
In-Line Heaters	Gas wells	In-line heaters exist only on gas wells and have a strong relation to well count. While some heaters (such as heater-treaters) do exist on oil wells, they are not within the boundaries of the gas industry (see Figure 3-2).
Separators	Mean of: 1) gas well and 2) production rate. Exception: offshore, where the relation is to production rate only.	Separators can be related to both production rate and well count. Separators can be at individual wells, or can be at central facilities, where production rate may play a factor. In the offshore area, the relation is stronger to production rate.
Compressors	Mean of: 1) total gas industry wells and 2) production rate	Compressors exist within the gas industry on the overhead lines from gas well separators and associated-oil well separators. Therefore there is a relation to total well count. There is also a relation to production rate since there are size limits for compressors.
Pneumatics	Mean of: 1) total gas industry wells and 2) production rate	Pneumatics exist on the overhead gas lines from associated oil wells and from gas wells. Gas lines from any gas producing well may have dehydrators and compressors with pneumatics. Therefore pneumatics are related to total gas industry well count. Pneumatics can also be related closely with production rate where central separation facilities exist. (The siting of equipment and pneumatics at central facilities can be largely dependent on production rates.)
Chemical Injection Pumps (CIPs)	Gas wells	CIPs were found mostly at individual well sites, even where central separation facilities existed. CIPs therefore have a strong relation to well count. While CIPs do exist on oil wells, oil well CIPs are not within the boundaries of the gas industry (see Figure 3-2). Therefore gas well count was used.

*Precision*, the random invariability in the measurement, is calculated by propagating error from each individual group of measurements. However, *bias*, a systematic error in the estimate, must be discovered and eliminated.

#### 4.5.1 Precision

If the activity factor estimate is assumed to be approximately normally distributed, then the 90% confidence limits for the activity factors determined by the site-weighting method can be estimated using Cochran's<sup>4</sup> equation 6.14. The equation for the 90% confidence interval (symmetric) for the site-weighted activity factor is:

$$\pm t_{(1-\alpha/2, n-1)} \sqrt{v} \quad (5)$$

The equation for the variance is:

$$v = \frac{N^2(1-f)}{n(n-1)} \sum_{i=1}^n (y_i - Rx_i)^2 \quad (6)$$

where

$y_i$  = the number of equipment at site  $i$  in the sample set;

$x_i$  = the number of wells or amount of production at site  $i$  in the sample set;

$n$  = number of sites sampled in the given region;

$N$  = the total number of sites in the region;

$f$  = sampling fraction =  $n/N$ ;

$R$  = activity factor ratio =  $(AF/EP)_{\text{sample}}$ ; and

$t_{(1-\alpha/2, n-1)}$  = the  $1-\alpha/2$  probability of the Student's  $t$  Distribution with  $n-1$  degrees of freedom.

The total number of sites (N) is not known for each region or nationally. Thus, it must be estimated by the following equation:

$$N = \frac{(\text{Production or Wells})_{\text{total,region}}}{(\text{Production or Wells})_{\text{total,sample}} / n} \quad (7)$$

Either production rate or wells can be used in the equation, depending on which extrapolation parameter is used.

#### 4.5.2 Propagation of Error

This section discusses the general techniques used to propagate the error bounds (for precision) that are calculated in Section 4.5.1. The error bounds of two numbers can be propagated to determine the error bound of their sum and/or of their product. These techniques are covered in more detail in Volume 4 on statistical methodology,<sup>3</sup> but are summarized here for the reader's convenience. Products are often used in this study since the basic extrapolation technique was to take the product of  $AF \times EF$  to obtain the source's emission rate (see Section 2). Sums are also used frequently since all of the individual source emission rates are summed to obtain the national annual emissions from the natural gas industry.

Section 4.5.1 discussed the calculation of 90% confidence half widths for a single term, such as an emission factor or activity factor. These confidence half widths can be plugged into the following equations to determine the confidence bounds for sums and products.

For uncorrelated values, the error bound (90% confidence half width) of a sum is the square root of the sum of the squares of the absolute errors of the values being summed. An illustrative example follows. Suppose the following values, A and B, are to be summed, and that the confidence bound of value "A" is expressed as "a" (in absolute terms). The bottom cell of Table 4-3 shows the resulting error calculation for the sum.

**TABLE 4-3. ERROR PROPAGATION FOR A SUM**

Values to be Summed	90% Confidence Half Widths	
	Absolute Value	Percent Value
A	a	$a\% = 100 \times a/A$
B	b	$b\% = 100 \times b/B$
Sum = (A + B)	absolute error of sum = square root of $(a^2 + b^2)$	

For correlated values, the equation for error becomes  $(a^2 + b^2 + 2rab)^{1/2}$ , where  $r$  = correlation coefficient between A and B. However,  $r$  was assumed to be zero for most categories since they were derived from different data and were unrelated.

The error bound (90% confidence half width) on a product is also calculated with the absolute errors of the terms being multiplied. Suppose that  $A \times B = C$ , and that the errors for A and B are expressed as  $a$  and  $b$ , respectively. The errors expressed as a fractional value would be  $fa$  and  $fb$ , respectively. The bottom cell of Table 4-4 shows the resulting error calculation for the product.

**TABLE 4-4. ERROR PROPAGATION FOR A PRODUCT**

Values to be Multiplied	90% Confidence Half Widths	
	Absolute Value	Fractional Value
A	a	$fa = a/A$
B	b	$fb = b/B$
Product = A × B	relative error of product = square root of $[fa^2 + fb^2 + (fa^2 \times fb^2)]$	

### 4.5.3 Screening for Bias

It is impossible to prove that there is no bias in any data set. While tests can be designed that are capable of revealing some bias, there are no tests nor group of tests that will reveal all possible biases. Assuming that a data set has no bias, even after extensive testing, is only a hypothesis. Such hypotheses can be disproved, but cannot be proven. However, the data collected during this project were carefully checked and rechecked to eliminate all identifiable biases. Three basic methods were used to screen for bias: peer review of the activity factors by experienced sources, analysis of the data, and extrapolation by different parameters (EPs).

Methods for gathering the data were tested repeatedly through extensive technical and industrial review. Numerous individual reviews and project advisor's meetings over a number of years were used to examine the project data with industry representatives and other experts so that systematic errors could be identified and eliminated. When possible biases in the activity factor sampling plan or extrapolation method were theorized; the project was altered to test for that bias and eliminate it if it existed. One example of this review process is the identification of regional differences in production practices. These differences were identified during the advisor meeting review process. The regional bias was then overcome by subdividing the production data into two offshore and four onshore regions, sampling within each region, and extrapolating by region.

Some of the production data that were collected and analyzed were also checked for bias by extrapolating the activity factors with multiple parameters (i.e., EPs). For a subset of data that is perfectly representative of the gas industry, equipment counts from the data set could be extrapolated to national totals by any variable in the data set. Any extrapolation from the perfect subset of data would deliver the correct answer, regardless of the parameter used. For an imperfect data set, which all data sets are, extrapolation by multiple variables allows for a cross check for bias. For example, in production, the equipment counts can be extrapolated by production rate or well count. These two methods



often produced different answers that were averaged to minimize the potential bias from a single method.

## 5.0 PRODUCTION SEGMENT

Some of the production segment activity factors were well-known, published figures, but most production activity factors had to be developed. Production activity factors were extrapolated from observed equipment counts at sampled sites based on the only three nationally known extrapolation parameters: total gas well count, gas industry well count, and gas production rate. Any scaled-up site data were extrapolated using the ratio of site wells to national wells or using the ratio of site production to national production.

### 5.1 Development of a Regional Approach

The extrapolations were performed on a regional basis since regional differences were known to exist and because each of the well-known activity factors (i.e., well count and production throughput) were also known on a regional basis. Six regions were selected based upon an analysis of the production and well population centers in the United States as well as upon known differences in practices in various regions. The regions are: Gulf Coast Onshore, Gulf Coast Offshore, Central Plains (onshore), Atlantic and Great Lakes (onshore), Pacific and Mountain (onshore), and Pacific Offshore. Figure 5-1 shows the major producing states and Figure 5-2 shows the regions selected and which states are included.

The differences in the regions justify their selection and can be seen in Table 5-1. Specifically, Table 5-1 shows the regional differences that exist in production versus well count. Each region has a unique oil well versus gas well split and has a unique production rate per well. Two offshore regions exist to account for the known differences in practices between onshore and offshore production operations. The well and production demographics also support this split since the offshore regions account for a small portion of the wells (1.5% of the gas wells and 1.2% of the oil wells) but produce 27.7% of the U.S. marketed gas production.

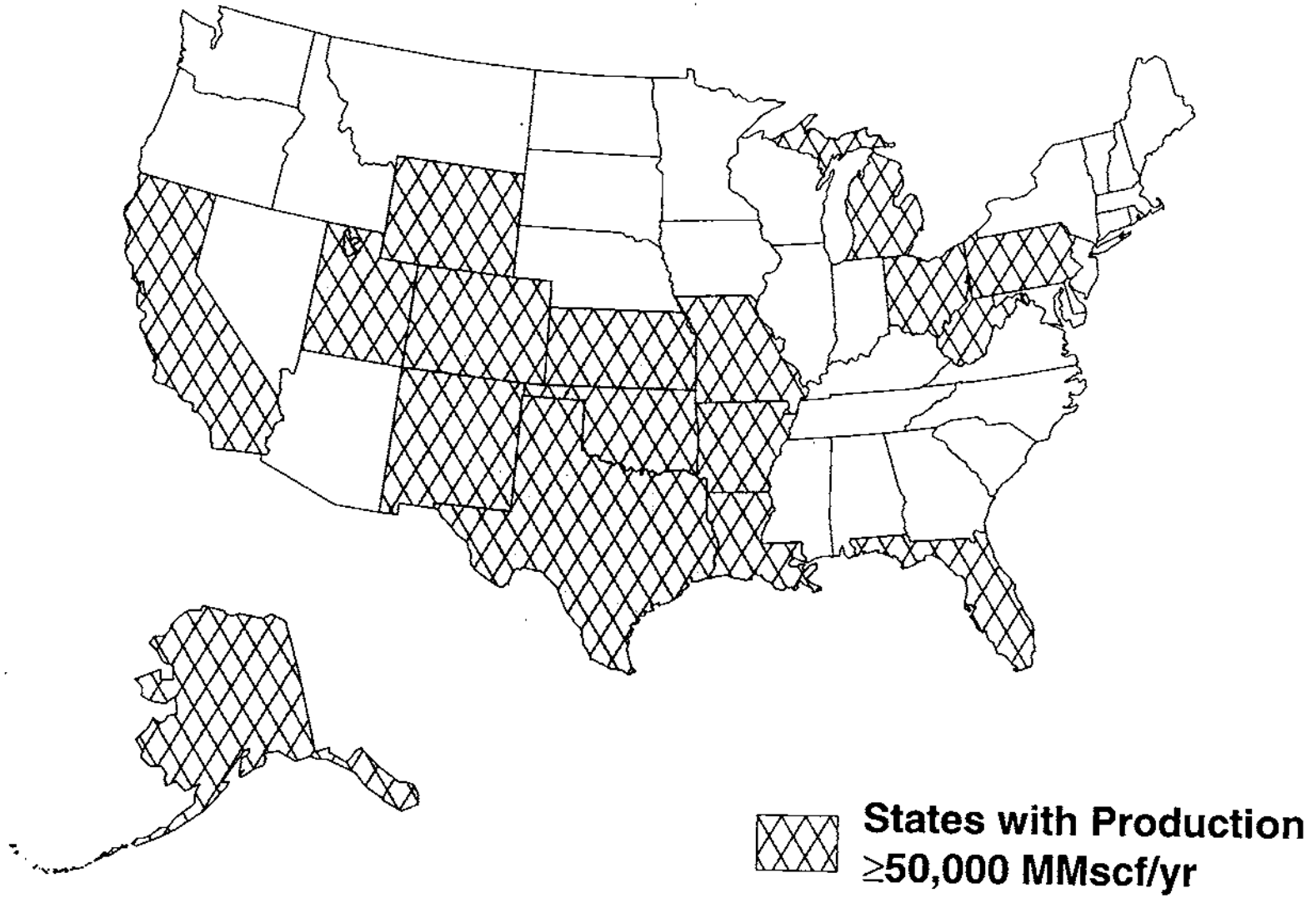

Figure 5-1. Major Producing States

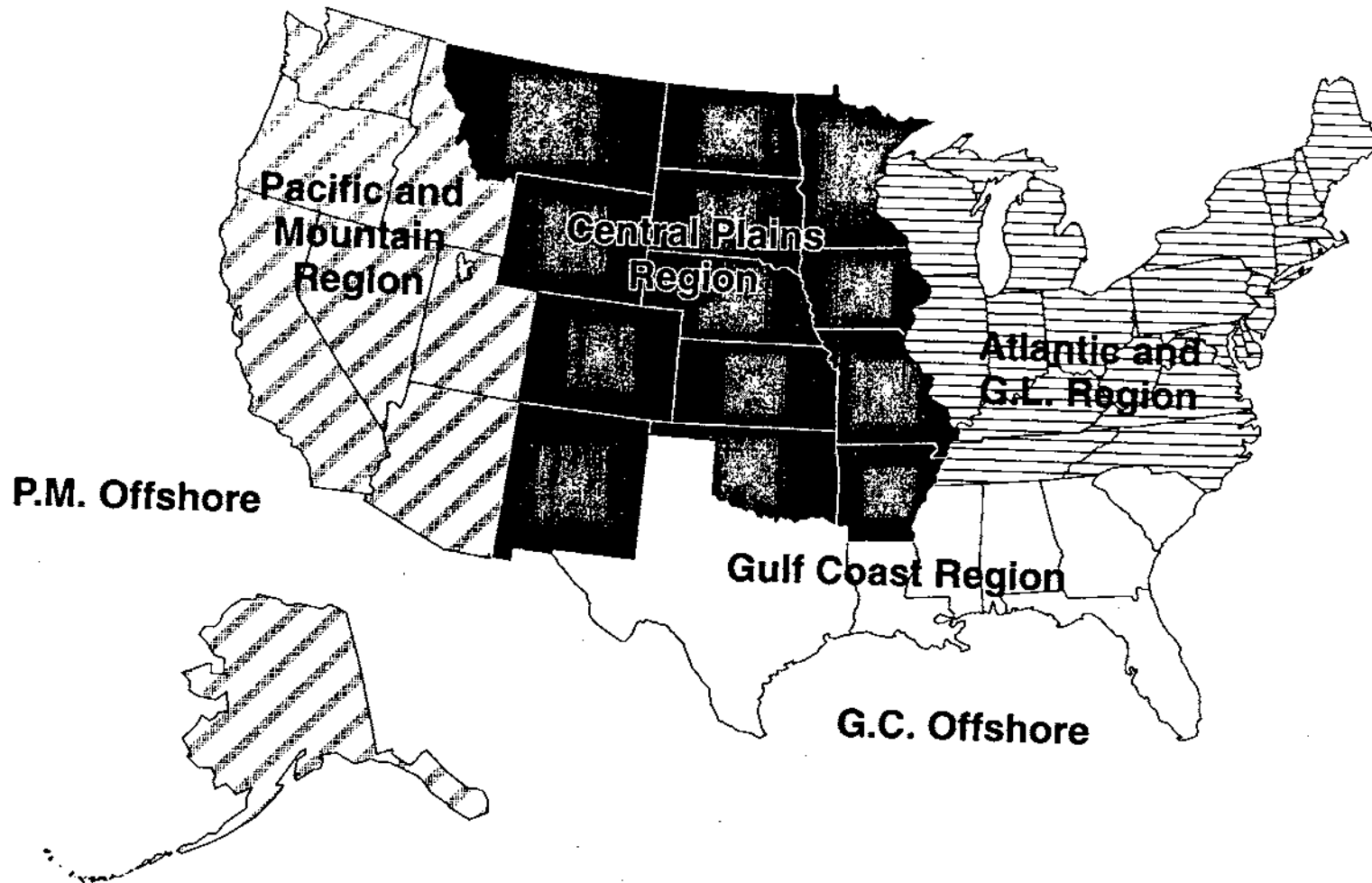

Figure 5-2. Selected Production Regions

**TABLE 5-1. REGIONAL DIFFERENCES IN PRODUCTION RATES AND WELL COUNTS**

Regional Groupings	States in Region that are > 50 Bscfy	1992 Producing Gas Wells <sup>a</sup>		1992 Producing Oil Wells <sup>a</sup>		1992 Marketed Production <sup>b</sup>		1992 Gross Production <sup>b</sup>	
		Count	Percent of Total	Count	Percent of Total	Bscfy	Percent of Marketed Total	Bscfy	Percent of Gross Total
Gulf Coast Region Total	TX,LA,FL	63667	23.1	217567	36.1	11514	61.5	12272	55.4
GC Offshore		4021	1.5	5140	0.9	5000	26.7	5045	22.8
GC Onshore		59646	21.6	212427	35.3	6514	34.8	7227	32.6
Central Plains (onshore)	OK,AR,CO,MO,NM, WY,KS	80924	29.3	199103	33.1	5424	29.0	5672	25.6
Pacific and Mountain Total	UT,CA,AK	2266	0.8	46722	7.8	984	5.3	3392	15.3
PM Offshore		65	0.0	2040	0.3	186	1.0	279	1.3
PM Onshore		2201	0.8	44682	7.4	798	4.3	3113	14.1
Atlantic and Great Lakes (onshore)	PA,MI,OH, WV	129157	46.8	138805	23.0	790	4.2	796	3.6
TOTAL U.S.		276014	100.0%	602197	100.0	18712	100.0%	22132	100.0%

<sup>a</sup> Table 3-17, *Gas Facts*<sup>2</sup>

<sup>b</sup> *Natural Gas Annual*<sup>5</sup>

In regard to the other regions, as shown in Table 5-1, the majority of natural gas production in the United States (61.5% of marketed production) is in the Gulf Coast Region. All other regions only account for 38.5% of the production, and the majority of that fraction of production occurs in the Central Plains region. However, the split on well count is completely different. The Atlantic & Great Lakes region, which accounts for only 4.2% of the marketed national gas production, has the largest portion of gas wells (46.8% of the national total) as well as a large fraction of oil wells (23%).

If wells or equipment associated only with wells (such as heaters and chemical injection pumps) are the sources being evaluated, then bias would potentially be introduced if sampling was performed only on wells in the Gulf Coast region, where most of the gas is produced. The bias is avoided if the sources are combined regionally, and the regional averages should then be added in the same proportion that they are distributed in the actual population.

Table 5-2 shows the relative representativeness of the sample data set for the region that it represents. The percentage of site samples (site visits and surveys) in the region can be compared with the actual percent of national well count and national production that the region represents. The sample set does not exactly match the actual regional averages for production per well. The sample sites have a higher production per well than the actual region, probably due to lower participation of sites with very low production rates. (Lower production rates may be tied to fewer resources and less ability to participate in surveys.)

However, this bias has not caused significant error in the data set since the extrapolation technique for activity factors does not use the production rate per well. Instead, the extrapolation technique uses both well count and production rate independently. Therefore, the high production rate per well should not introduce any error into the final estimates.

**TABLE 5-2. SAMPLE SET COMPARISON TO ACTUAL REGIONAL DATA**

Regional Groupings	Sample Data Set <sup>a</sup>				1992 Actual Regional Data <sup>b,c</sup>				
	Number of Site Samples	Percent of Total Site Samples from this Region	Production Rate per Gas Industry Well (MMcfd)		Percent of Total Oil Wells	Percent of Total Gas Wells	Percent of Marketed Gas Total	Production Rate per Gas Industry Well (MMcfd)	
			Marketed	Gross				Marketed	Gross
Gulf Coast Region Total	13	26.0			36.1	23.1	61.5		
GC Offshore	4	8.0	1.66	1.66	0.9	1.5	26.7	2.36	2.38
GC Onshore	9	18.0	0.54	0.54	35.3	21.6	34.8	0.13	0.15
Central Plains (onshore)	7	14.0	0.22	0.22	33.1	29.3	29.0	0.10	0.10
Pacific and Mountain Total	11	22.0			7.8	0.8	5.3		
PM Offshore	2	4.0	5.22	5.22	0.3	0.0	1.0	0.66	0.99
PM Onshore	9	18.0	0.12	0.32	7.4	0.8	4.3	0.12	0.48
Atlantic and Great Lakes (onshore)	19	38.0	0.018	0.019	23.0	46.8	4.2	0.012	0.012
TOTAL U.S.	50	100.0	0.14	0.16	100.0	100.0	100.0	0.106	0.125

<sup>a</sup> Includes Radian site visits (24), Radian phone surveys (15), and Star site visits (12)

<sup>b</sup> Table 3-10, *Gas Facts*<sup>2</sup>

<sup>c</sup> *Natural Gas Annual*<sup>5</sup>

## 5.2 Gas Well Count and Production (Onshore and Offshore)

Gas well counts for 1992 were available from several sources (*Gas Facts*, Table 3-17,<sup>2</sup> or from *World Oil*,<sup>6</sup> or from DOE EIA's *Natural Gas Annual*<sup>5</sup>). These sources give total U.S. gas wells for each year. The data are also sorted by state, which allowed regional groupings to be made, as was done in Table 5-1.

The split of counts into offshore and onshore wells has to be made for the states that have offshore production in state waters; these states are Alabama, California, Louisiana, Texas, and Alaska. *World Oil* (Feb 93) gives figures for offshore gas well counts for Alabama, California, and Louisiana. Texas and Alaska data were not split. Texas data were obtained from contacts with the Texas Railroad Commission (RRC).<sup>7</sup> The Alaska offshore count was provided by the Alaska Oil and Gas Conservation Commission.<sup>8</sup>

Gas well production data for 1992 were also available from several sources (*Gas Facts*, Table 3-17,<sup>2</sup> or from the U.S. Department of Energy (DOE) EIA's *Natural Gas Annual*<sup>5</sup>). These sources give total U.S. gas wells for each year. The data are also sorted by state which allowed regional groupings to be made, as was done in Table 5-1. Production was sorted into onshore and offshore production using DOE EIA's *Natural Gas Annual*, Table 4, "Offshore Gross Withdrawals of Natural Gas By State, 1992."

## 5.3 Oil Well Count and Production (Onshore and Offshore)

Oil well counts for 1992 were available from the *Oil and Gas Journal*<sup>9</sup> and from *World Oil* (Feb 1993).<sup>6</sup> Similar to gas wells, the onshore and offshore split of oil wells was made by *World Oil* for Alabama, Alaska, California, and Louisiana. Texas data were not split. Again, Texas offshore oil well data were obtained from contacts with the Texas Railroad Commission.<sup>7</sup>



Gas production from oil wells for 1992 was also available from DOE EIA's *Natural Gas Annual*<sup>5</sup>. These sources give total U.S. gas wells for each year. The data are also sorted by state, which allowed regional groupings to be made, as was done in Table 5-1. Production was sorted into onshore and offshore production using DOE EIA's *Natural Gas Annual*, Table 4, "Offshore Gross Withdrawals of Natural Gas By State, 1992."

#### 5.4 Oil Wells Marketing Gas

Oil wells that produce natural gas and sell the gas into the natural gas system have been considered a part of the natural gas industry for the purposes of this report. The wellhead is not considered part of the gas industry, but downstream gas production equipment associated with these wells is included. However, oil wells that do not produce gas, or that produce gas that is vented or consumed on site are not considered part of the gas industry. Methane emissions from this latter type of oil well are not included in our estimates.

There are no national statistics on the fraction of oil wells that market gas. Only the total oil well count is known. Even differentiation of gas wells from oil wells are based on a gas-to-oil ratio (GOR) and may vary state-to-state. The definition in Texas for an oil well is any well that has a GOR lower than 100,000 cubic feet (of gas) per barrel (of oil). A GOR greater than 100,000 qualifies the well as a gas well.

Since there are no national statistics on oil wells that market gas, the national statistics on total oil wells had to be manipulated to produce this number. To determine the number of oil wells that produce gas which is not marketed, detailed state data from Louisiana, Colorado, California, and Texas were examined for disposition designations that would indicate whether gas from the wells was marketed or internally consumed. Only Texas data allowed such a differentiation.

Texas RRC magnetic tapes for 1989's P-1 and P-2 disposition reports were purchased, downloaded, and analyzed with a database management program.<sup>10</sup> Oil wells are not tracked on an individual well basis but are tracked on a lease basis, so the data will be discussed on a lease basis. The analysis showed that oil well leases with some marketed gas account for only 34.7% of all oil well leases. This figure was obtained by taking the mean of the percentages for each month's worth of data. The minimum observed monthly value was 28.0% (March 1989), and the maximum was 46.7% (October 1989). The standard error, used in the calculation of statistical confidence limits, was 2.8 percentage points, or 7.8% of the mean value. The reader should note that this error demonstrates the variability of the Texas data and has been assumed to be equal to the variability of the national data.

Dwight's Energy Data, Inc. was asked to query their database to determine the fraction of oil leases that were producing gas for sale in Oklahoma.<sup>11</sup> They found that 52% of the oil leases in Oklahoma had sold gas. However, Dwight's was unable to confirm what GOR was used to differentiate between an oil lease and a gas lease. Thus, the 52% was not used in the calculation of associated gas wells, but was thought to confirm the magnitude of the 34.7% value that was obtained from the RRC tapes.

Total gas industry well counts were determined by multiplying known regional oil well counts by 0.347, and adding these oil wells to all of the gas wells. These calculations were performed on a regional basis, as shown in Table 5-3. The total gas industry well counts were used to extrapolate populations of chemical injection pumps, in-line heaters, separators, and compressors as detailed in Section 5.7.

## 5.5 Offshore Platforms

A separate method for determining offshore platform count was necessary because offshore production fugitive studies produced emission rates per platform, rather than per equipment. While published data are available on the number of active drilling rigs, no published data were found on the number of producing platforms. Two separate sources were contacted to obtain the required information.

**TABLE 5-3. NATIONAL GAS INDUSTRY WELLS**

Region	Gas Wells <sup>b</sup> (1992 data)	Oil Wells <sup>b</sup> (1992 data)	Oil Wells Marketing Gas <sup>a</sup> (1992 data)	± 90% Confidence Limits (absolute)	Total Gas Industry Wells (1992 data)	± 90% Confidence Limits (% of Mean)
Gulf Coast Offshore	4021	5140	1780	133	5800	2.3
Gulf Coast Onshore	59646	212427	73700	5479	133000	4.1
Central Plains (onshore)	80924	199103	69100	5135	15000	3.4
Pacific Offshore	65	2040	708	53	773	6.5
Pacific & Mountain Onshore	2201	44682	15500	1152	17700	6.5
Atlantic & Great Lakes (onshore)	129157	138805	48200	3580	177000	2.0
TOTAL U.S. (1992 data)	276014	602197	209000	15533	485000	3.2

<sup>a</sup> Based upon analysis of Texas RRC data that shows 34.7% of all oil wells market gas.<sup>7, 10</sup>

<sup>b</sup> Source on well counts: *Gas Facts*.<sup>2</sup>

The first source for platform count information was Offshore Data Services, Inc.,<sup>12</sup> which tracks statistical data on offshore production. They estimated that in 1993 there were 1607 producing platforms in the Gulf of Mexico, and 45 platforms in the rest of the United States. This includes platforms in state waters.

The second source for platform data was the Minerals Management Service MMS Outer Continental Shelf Activity Database (MOAD).<sup>13</sup> This database provided a count of 1,857 producing platforms in the Gulf of Mexico (excluding platforms located in state waters). However, since MOAD only has an 85% response rate from industry, the number was extrapolated to 2,185. MOAD does not account for platforms located in state waters in the Gulf.

The MOAD number could be overestimated since it counts some platforms with no production, and could be underestimated since platforms in state waters were not included. However, since the Offshore Data Services number was lower, the MOAD count was likely not underestimated. The MOAD data were used for the Gulf of Mexico platform count because they were conservatively high and could be examined more readily. The sum of the extrapolated MOAD Gulf of Mexico count and the Offshore Data Services count for the rest of the United States was used in the study.

The total platform count was split 50/50 between "oil" industry and "gas" industry platforms. No data were available to define the actual split, but industry reviewers approved this approach. The total counts for the two regions and the split of gas industry platforms are shown in Table 5-4.

The total offshore oil and gas well count is 11,300 (see Table 5-3). The result, when divided by the total platform count, is 5.1 wells per platform. Site visit data on platforms produced a ratio of 5 to 10 wells per platform. This ratio validates the relative magnitude of the platform counts provided by Offshore Data Services and the MOAD

**TABLE 5-4. PLATFORM COUNTS**

Region	Total Platform Count	Gas Industry Platform Count
Rest of U.S.	45	22
Gulf of Mexico	2,185	1,092
Total U.S. Offshore	2,230	1,114

database. Therefore, the 90% confidence interval was assigned to be  $\pm 10\%$  based on engineering judgement.

### 5.6 Specific Equipment

Nationally tracked data are not available for most equipment in the production segment. Therefore, this study estimated total equipment in the production segment from specific counts taken during the study's site visits. A total equipment count for a facility was estimated while on site. Then the site equipment counts were extrapolated to regional counts with an extrapolation parameter (something that is known both for the site and for the region). Section 4.4, Equation 3 discussed the method used for extrapolation.

For major equipment activity factors in the production segment, equipment counts could be extrapolated by either active wells or marketed production for each site. As explained in Section 4.4.2, the active wells extrapolation parameter can be either gas only wells or total "gas industry" wells. "Gas industry" wells include gas wells and oil wells that also market gas. These three extrapolation methods (gas wells, total wells, and production rate) can yield very different results. Therefore, technical relations were used to select the appropriate extrapolation parameter(s), as was explained in Section 4.4.2, Table 4-3.

The extrapolations were also performed on a regional basis in order to account for regional differences in the key parameters such as operating practices, gas quality, well

production rates, equipment design, and field ages. The site data were organized into regions, and regional ratios were then determined. The regional ratios were then multiplied by the regional count of active wells (gas and total wells) or by regional marketed production to obtain a total count of equipment in the region. Regions were added together to determine the national number. The final national equipment counts are summarized in Table 5-5.

**TABLE 5-5. SPECIFIC EQUIPMENT ACTIVITY FACTORS**

Activity Factor	Count and Confidence Limits
Separators	167,000 ± 28%
Heaters	51,000 ± 95%
Pneumatics	249,000 ± 48%
Chemical Pumps	17,000 ± 143%
Compressors	17,100 ± 52%

The results of the extrapolations for separators, in-line heaters, pneumatics, chemical injection pumps, and compressors are presented in Tables 5-6 through 5-10. The last column in Tables 5-6 through 5-10 presents the selected activity factor value. The site equipment count data used in developing the regional counts in Tables 5-6 through 5-10 are presented in Appendix A.

### 5.7 Vessels and Pressure Relief Valves

Specific equipment activity factors were combined and used to extrapolate emission rate estimates for vessel blowdowns and pressure relief valves (PRVs). The number of production "vessels" (used in estimating vessel blowdown emissions) was based on the sum of separators and in-line heater counts from Tables 5-6 and 5-7 and the number of dehydrators (discussed in Section 8), resulting in 256,000 vessels. Compressors were not included in the vessel activity factor since emission factors for compressor start-ups and blowdowns were treated separately. A confidence interval of ± 26% was determined by

**TABLE 5-6. SEPARATORS IN PRODUCTION**

Pneumatic Devices	Total Well Basis	Gas Well Basis			Marketed Gas Basis			r	Arith. Mean (Gas and Mkt.)		Final Extrapolated Count	
		Activity Factor Equip/Gas Well	Extrapolated Count	90% Conf	Activity Factor Equip/Mkt Gas	Extrapolated Count	90% Conf		Wt. Mean Equipment Count	90% Conf		
NATIONWIDE Basis (non-regional)	Not Applicable	0.727	200,566		4.182	214,399					167,172	
NATIONWIDE Sum by Region			200,312	26%		134,558	36%					
Gulf Coast Offshore Region		0.335	1,349	129%	0.060	825	42%					+/-
Gulf Coast Onshore Region		0.985	58,763	23%	0.931	16,614	48%	-0.310	37,689	17%		28%
Central Plains Region		0.486	39,335	119%	2.144	31,865	123%	0.868	35,600	117%		
Pacific/Mountain Offshore Region		0.083	5	300%	0.006	3	101%					
Pacific/Mountain Onshore Region		0.849	1,869	300%	0.412	902	268%	0.700	1,385	271%		
Atlantic/Great Lakes Region		0.766	98,991	17%	38.972	84,349	32%	0.859	91,670	23%		

**TABLE 5-7. IN-LINE HEATERS IN PRODUCTION**

In-Line Heaters	Total Well Basis	Gas Well Basis			Marketed Gas Basis			r	Final Extrapolated Count
		Activity Factor Equip/Gas Well	Extrapolated Count	90% Conf	Activity Factor Equip/Mkt Gas	Extrapolated Count	90% Conf		
NATIONWIDE Basis (non-regional)	Not Applicable	0.282	77,865		Not Applicable			Not Applicable	
NATIONWIDE Sum by Region			51,000	95%					51,000
Gulf Coast Offshore Region		0.000	0	0%					+/-
Gulf Coast Onshore Region		0.224	13,342	121%					95%
Central Plains Region		0.435	35,197	128%					
Pacific/Mountain Offshore Region		0.000	0	0%					
Pacific/Mountain Onshore Region		1.000	2,201	300%					
Atlantic/Great Lakes Region		0.002	260	196%					



**TABLE 5-8. PNEUMATIC DEVICES IN PRODUCTION**

Pneumatic Devices	Total Well Basis			Gas Well Basis	Marketed Gas Basis			r	Arith. Mean (Gas and Mkt.)		Final Extrapolated Count
	Activity Factor Equip/Gas Well	Extrapolated Count	90% Conf		Activity Factor Equip/Mkt Gas	Extrapolated Count	90% Conf		Wt. Mean Equipment Count	90% Conf	
NATIONWIDE Basis (non-regional)	0.517	250,958			3.458	177,253					
NATIONWIDE Sum by Region		353,356	56%			144,867	35%		249,111	48%	249,111
Gulf Coast Offshore Region	0.127	739	224%	Not	0.077	1,049	26%	-0.102	894	92%	+/-
Gulf Coast Onshore Region	0.575	76,649	64%	Applicable	1.060	18,917	69%	0.930	47,783	64%	48%
Central Plains Region	1.325	198,890	94%		4.947	73,509	42%	0.950	136,199	80%	
Pacific/Mountain Offshore Region	0.000	0	0%		0.000	0	0%	0.000	0	0%	
Pacific/Mountain Onshore Region	0.080	1,423	231%		0.666	1,455	249%	0.703	1,439	222%	
Atlantic/Great Lakes Region	0.427	75,654	54%		23.072	49,937	77%	0.950	62,796	62%	

**TABLE 5-9. CHEMICAL INJECTION PUMPS IN PRODUCTION**

Chemical Injection Pumps	Total Well Basis	Gas Well Basis			Marketed Gas Basis			r	Arith. Mean (Gas and Mkt.)		Final Extrapolated Count
		Activity Factor Equip/Gas Well	Extrapolated Count	90% Conf	Activity Factor Equip/Mkt Gas	Extrapolated Count	90% Conf		Wt. Mean Equipment Count	90% Conf	
NATIONWIDE Basis (non-regional)	Not Applicable	0.036	9,903		Not Applicable						
NATIONWIDE Sum by Region			16,971	143%						16,971	
Gulf Coast Offshore Region		0.000	0	0%						+/-	
Gulf Coast Onshore Region		0.033	1,962	142%						143%	
Central Plains Region		0.159	12,857	184%							
Pacific/Mountain Offshore Region		0.000	0	0%							
Pacific/Mountain Onshore Region		0.679	1,495	300%							
Atlantic/Great Lakes Region		0.005	657	48%							

**TABLE 5-10. COMPRESSORS (NON-GAS LIFT) IN PRODUCTION**

Compressors (excluding gas lift)	Total Well Basis			Gas Well Basis	Marketed Gas Basis			r	Arith. Mean (Gas and Mkt.)		Final Extrapolated Count
	Activity Factor Equip/Gas Well	Extrapolated Count	90% Conf		Activity Factor Equip/Mkt Gas	Extrapolated Count	90% Conf		Wt. Mean Equipment Count	90% Conf	
NATIONWIDE Basis (non-regional)	0.067	32,317			0.195	9,977					
NATIONWIDE Sum by Region		26,000	59%			8,223	41%		17,112	52%	17,112
Gulf Coast Offshore Region	0.000	0	0%	Not	0.000	0	0%	0.000	0	0%	+/-
Gulf Coast Onshore Region	0.067	8,991	129%	Applicable	0.124	2,219	119%	0.950	5,605	126%	52%
Central Plains Region	0.095	14,189	70%		0.347	5,157	38%	0.157	9,673	54%	
Pacific/Mountain Offshore Region	0.167	129	300%		0.013	6	300%	0.700	68	296%	
Pacific/Mountain Onshore Region	0.142	2,512	55%		0.348	761	121%	0.903	1,637	69%	
Atlantic/Great Lakes Region	0.001	179	37%		0.037	80	23%	0.950	129	33%	

combining the confidence intervals for each equipment type using the square root of the sum of the squares approach (discussed in Volume 4 on statistical methodology<sup>3</sup>).

An activity factor for the number of PRVs was based on an observed PRV count per equipment type as shown in Table 5-11.

**TABLE 5-11. PRESSURE RELIEF VALVES**

Equipment Type	PRV Count Per Equipment
Separators	2 ± 68%
Heaters	1 ± 89%
Compressors	4 ± 84%
Dehydrators	2 ± 53%

Details of these observations are provided in Volume 8 on equipment leaks.<sup>14</sup> Using the PRV ratios shown above and the equipment counts reported in Sections 5 and 8, results in an estimated 529,400 ± 53% PRVs in production.

### 5.8 Gathering Pipeline Miles

Total gathering pipeline mileage is not reported or tracked nationally and must be estimated. The gathering pipeline mileage was divided into three segments. The first of these was gas well gathering pipeline miles, and the second was miles for oil wells that market gas. The third segment consisted of gathering pipeline miles owned by transmission companies.

Total miles of gathering pipeline were estimated using site visit data from the thirteen production sites shown in Table 5-12. Seven of the thirteen sites provided estimates of their total miles of pipeline. The fifth site's mileage was estimated from a map of its pipelines.

Gas well gathering pipeline miles were determined using data from the thirteen sites. The gathering pipeline miles and the gas wells from the sites were each summed. The sum of the gathering pipeline miles (1,359) was divided by the sum of the gas wells (2,033) to determine an average number of pipeline miles per gas well (0.668). This value was extrapolated by the nationwide activity factor for gas wells (276,000) to give the nationwide activity factor of 184,000 gathering pipeline miles for gas wells.

Gathering pipeline mileage for oil wells that market gas was based on the gas well mileage data. It was assumed that one half of the gathering pipeline mileage at an oil well that markets gas was in the oil industry, and half was in the gas industry (see Figure 3-2). Therefore, the average number of pipeline miles per oil well marketing gas was divided by two to determine the average number of pipeline miles per associated gas well (0.334). This average was extrapolated by the nationwide activity factor for these wells (209,000) to give the nationwide activity factor of 70,000 gathering pipeline miles for oil wells that market gas.

The third segment, gathering pipeline miles owned by transmission companies, is reported by A.G.A. to be 86,200 miles (Table 5-1<sup>2</sup>). Utility-owned pipelines are assumed to be part of the total production gathering pipeline miles, and were not included in the mileage counts in the production site visit data.

The total production gathering pipeline miles from gas wells, from oil wells that market gas, and from transmission companies was summed. This sum gives a nationwide activity factor of 340,200 for production gathering pipeline miles. A rigorous determination of the 90% confidence interval gave an error less than  $\pm 4\%$ . This value was considered to be too low based on the quality of the data that were used to generate the activity factor. Thus, a 90% confidence interval of  $\pm 10\%$  was assumed based on engineering judgement.

**TABLE 5-12. PRODUCTION GATHERING PIPELINE MILEAGE - GAS WELLS**

Site	Gathering Miles	Number of Wells
Site 1	46.3	80
Site 2	8	26
Site 3	40	130
Site 4	15.4	12
Site 5	11	6
Site 6	5.2	193*
Site 7	600	1000
Site 8	441.3	425
Site 9	0.7	1
Site 10	27.7	24
Site 11	2.1	3
Site 12	7.1	7
Site 13	154.2	126
<b>TOTAL</b>	<b>1359.0</b>	<b>2033</b>

\* Includes 55 oil wells.

### **5.9 Maintenance Activities**

Emission rate estimates for well workovers and completion flaring were based on annual counts of a specific activity, as opposed to an equipment count. Completion flaring occurs immediately following the drilling process for a new well, where the gas is flared to determine the available pressure and flow rate. Most completion flaring is associated with exploratory wells to allow proper sizing of meters and surface equipment. (The production rates for new wells in existing fields can usually be determined before the well is completed.) The Energy Information Agency (EIA)<sup>15</sup> estimated 844 wells are

completed each year, based on 1987 data. A confidence interval of 10% was assigned to this value based on engineering judgement.

Well workovers are another type of maintenance activity. During a well workover, the tubing is pulled from the well to repair tubing corrosion/erosion or other downhole equipment problems. A study performed by Pipeline Systems Incorporated (PSI) reported the number of gas well workovers for two sites.<sup>16</sup> PSI data showed 1 workover/yr per 21 gas wells at Site 1, and 1 workover/yr per 50 gas wells at Site 2. The annual average for these two sites is  $0.0338 \pm 258\%$  workovers/gas well. (Workovers for oil wells are outside the natural gas industry boundaries defined for this report.) The confidence interval for this value was calculated using Equation 5. Multiplying this ratio by the total number of gas wells ( $276,014 \pm 5\%$  from Table 5-1) results in the number of well workovers per year:

$$276,014 \text{ gas wells} \times 0.0338 \text{ workovers/yr-well} = 9,329 \text{ workovers/yr}$$

A confidence interval of 258% was calculated based on propagating the confidence intervals for the terms in the equation above.

A third type of maintenance, venting or gas well unloading, requires an activity factor for the number of gas wells that require unloading. Gas wells operated under low pressures can accumulate water in the wellbore due to their low flow rate. This water chokes the flow of the well, reducing the gas production. To clear the water, the well is blown to a tank at atmospheric pressure, where the gas is vented. Data from 22 production site visits indicated that 41% ( $\pm 45\%$ ) of gas wells require this unloading practice to maintain production. Additional details on this particular activity factor can be found in the Volume 7 on blow and purge activities.<sup>17</sup> Multiplying the total number of gas wells nationally ( $276,014 \pm 5\%$ ) by this value results in  $114,139 \pm 45\%$  gas wells requiring unloading each year.

## 5.10

### Compressors and Dehydrators

Activity factors for compressors and dehydrators were calculated in a single extrapolation procedure for all segments of the natural gas industry. The details of this procedure are discussed in Section 8.



## 6.0 GAS PROCESSING SEGMENT

Activity factors in gas processing are significantly simpler than in gas production, since the segment consists of one type of facility: gas processing plants. Major activity factors were limited to the number of gas plants (of each type), dehydrators, acid gas recovery units (AGRs) and compressors. All of these activity factors were either published and well-defined or were developed through other studies such as the Wright Killen report<sup>18</sup> or Volume 11 on compressor driver exhaust.<sup>19</sup>

### 6.1 Gas Plant Count

Gas processing plants recover high-value hydrocarbon liquids from natural gas. The plants can be divided by process type based upon data from the *Oil & Gas Journal* annual plant survey<sup>9</sup> as shown in Table 6-1:

**TABLE 6-1. DIVISIONS OF GAS PROCESSING PLANTS BY TYPE**

Type	Count	% of Total
Cryogenic	302	42
Refrigerated absorption	117	16
Refrigeration	192	26
Other	115	16
<b>TOTAL PLANTS</b>	<b>726</b>	<b>100</b>

Since the sites visited sampled all of the major types, and since no emission factor data were correlated to plant type, only the total plant count was used for the plant activity factor. Based upon 1992 data from the *Oil and Gas Journal*, the total gas plant count is 726. A confidence limit for the gas plant count was set at  $\pm 2\%$  based upon engineering judgement.

## 6.2 Acid Gas Recovery (AGR) Units

Acid gas recovery (AGR) units are used to remove carbon dioxide (CO<sub>2</sub>) and hydrogen sulfide (H<sub>2</sub>S) from natural gas. Absorption of CO<sub>2</sub> and H<sub>2</sub>S in aqueous amine solutions (e.g., monoethanolamine, diethanolamine) is the most widely used process for AGRs. Some methane is absorbed along with the acid gas in the amine solution and may be emitted when the solution is regenerated by heating and decrease in pressure. Purvin & Gertz, Inc., estimated the total count of AGRs using an amine process to be 371, with a total capacity of 30,433 MMscfd.<sup>20</sup> Most AGRs have flares or sulfur recovery processes that prevent the release of methane. However, it is estimated that only 18% of AGRs vent regenerator offgas (including acid gas and methane) to the atmosphere.<sup>21</sup> Other AGR processes may result in methane emissions but are much more difficult to quantify because of the wide variety of processes available.

## 6.3 Compressors and Dehydrators

Activity factors for compressors and dehydrators were calculated in a single extrapolation procedure for all segments of the natural gas industry. The details of this procedure are outlined in Section 8.

## 7.0 TRANSMISSION SEGMENT

Activity factors for the transmission segment are easier to determine than production segment factors because the transmission segment is more homogeneous than the production segment. The transmission segment has only four basic components: pipeline, compressor stations, storage facilities, and meter and regulating (M&R) stations. Most transmission pipelines are one of two types: cross-country or regional network.

### 7.1 Compressor Station Count

The total number of compressor stations was calculated to be  $1700 \pm 10\%$ . The number was extrapolated from data submitted by major transmission companies to the Federal Energy Regulatory Commission (FERC).<sup>22</sup> Pages 508 and 514 of FERC Form 2 list the number of compressor stations and miles of pipeline for 46 transmission companies. The pipelines owned by these companies comprise 70% of the total transmission pipeline mileage, making the sample large but incomplete. The total number of transmission compression stations reported in the forms was extrapolated by pipeline mileage to determine the total number of compression stations in the transmission segment. A summary of the compression station data obtained from FERC Form 2 is presented in Table 7-1. The confidence interval of  $\pm 10\%$  was based on engineering judgement.

In a 1990 survey titled "Natural Gas Industry Environmental Organization Structure Survey," A.G.A. surveyed 14 gas transmission companies and found an average of 138 miles per station.<sup>23</sup> The number of miles per station corresponds to a higher count of 2062 compressor stations. However, the 1990 A.G.A. survey was less formal, and the stations used in the survey also included some gas processing plants; therefore, the 2062 value determined by the A.G.A. is an overestimate of transmission compressor stations. Its relative size does, however, lend credence to the selected activity factor of 1700 stations.

**TABLE 7-1. TRANSMISSION COMPRESSOR STATION COUNTS**

Company	Number of Stations	Miles of Pipeline
1	5	1,023
2	47	9,915
3	29	6,556
4	28	3,253
5	64	4,517
6	119	11,188
7	13	4,288
8	78	10,244
9	6	495
10	17	1,149
11	20	4,460
12	14	1,960
13	1	203
14	0	375
15	5	925
16	51	9,725
17	2	548
18	7	354
19	15	1,972
20	1	362
21	2	552
22	12	1,457
23	56	10,973
24	7	971
25	48	24,182
26	42	3,551
27	0	89
28	13	799
29	58	6,532
30	13	1,718
31	2	462
32	48	7,896
33	2	275

Continued

TABLE 7-1. (Continued)

Company	Number of Stations	Miles of Pipeline
34	69	14,666
35	69	9,386
36	28	5,819
37	0	436
38	43	10,670
39	20	4,194
40	19	4,218
41	0	30
42	29	7,272
43	8	549
44	45	6,093
45	30	3,224
46	1	269
Total	1186	199,795
Extrapolated No. of Stations	1,700	

## 7.2

Storage Station Count

There are two types of gas storage facilities: liquefied natural gas (LNG) storage and underground storage. LNG facilities condense the natural gas at high pressures for storage and transportation in refrigerated vessels. Underground gas storage areas typically operate to accept excess gas from major gas pipelines during surplus production flow periods. The stored surplus gas is reinjected into the pipeline when demand is higher. Typically, the net amount of gas to storage for any year is zero; if there is an actual long-term over-supply, the producing wells will simply be cut back.

Underground storage areas are unique. Unlike liquid storage facilities, expensive tanks are not used. Underground gas storage facilities are typically one of the following: old, spent gas fields; salt domes; or aquifers. The storage operator simply injects the surplus gas into the underground formation, which effectively "stores" the gas. Compression is sometimes necessary to inject the gas into the formation or to return the gas to the pipeline.

Underground (UG) station count data were available from *Gas Facts*, Table 4-5 "Amount of Pools, Wells, and Horsepower in Underground Storage Fields, By State, 1990-1992."<sup>2</sup> The number of LNG facilities was also available from *Gas Facts* Table 4-3, "LNG Storage Operations in the U.S. as of Dec. 31, 1987."<sup>24</sup> The total number of storage stations is the sum of the underground stations and LNG facilities as shown:

UG:	386	(storage stations)
LNG:	<u>+ 89</u>	(54 complete plants, 32 satellite plants, 3 import terminals)
TOTAL:	475	(storage stations)

This project assigned a  $\pm 5\%$  accuracy based upon engineering judgement.

### 7.3 Storage Well Count

Underground storage facilities have wellheads at the surface similar to wellheads at producing gas wells. These wellheads sit above the wellbore's connection to the underground reservoir. Each wellhead has components that can emit gas.

The number of active underground storage wells for 1992 is given in *Gas Facts*, Table 4-5, as 17,999.<sup>2</sup> This project assigned a  $\pm 5\%$  accuracy since this number is tracked annually by A.G.A.

### 7.4 M&R Station Count

Meter and regulating (M&R) stations are used to measure flow of gas at a custody transfer point, and/or to reduce and regulate the pressure and flow into a downstream pipeline system. Some metering facilities do exist within compressor stations, but these have already been counted in the compressor station emissions. In the transmission segment, separate M&R facilities are usually fenced, above ground facilities that contain valves, piping, and meter runs.

In the U.S. gas industry, most M&R stations exist in the distribution and production segments and have already been counted there. M&R facilities counted by the transmission companies are generally of the following type:

1. Receipt from production (meter only),
2. Delivery to distribution (M&R),
3. Pressure reduction to inter-company transmission lines with low maximum operating working pressure (MOWP),
4. Interconnects/custody transfer (bi-directional) to another transmission company, or

5. Direct sales (farm taps, direct industrial sales from transmission lines).

The first three types are already counted in other activity factors as follows:

- In the production segment, meter runs that transfer the gas to transmission companies were included in the well site fugitive component count data.
- Delivery to distribution has been counted in the distribution segment M&R stations (see Section 9 for more detail).
- Pressure reduction stations that reduce the pressure to a line that has a lower maximum operable working pressure (MOWP) also are already counted in the distribution M&R count (Section 9).

The two types of M&R stations that have not been included elsewhere are transmission company interconnects and direct sales. Most large transmission companies have interconnects with other transmission companies to allow for flexibility of supply. These shared stations can flow in either direction. The last category (direct sales) is comprised of two types: farm taps and direct industrial sales. Direct industrial sales from transmission lines are owned by local distribution companies (LDCs), even if they only own a few feet of line. Many farm taps are still owned by transmission companies, even though there is a trend to let LDCs handle the farm taps or to remove them entirely.

Transfers to other transmission companies and farm taps were calculated from survey data provided by the metering departments of three large (over 10,000 miles of pipeline) transmission companies, and from three companies with fewer than 10,000 miles of pipeline, as shown in Table 7-2.



**TABLE 7-2. TRANSMISSION M&R STATION POPULATIONS**

Company	Transfer to another Transmission Co.	Farm Taps	Direct Industrial Sales	Miles of Pipeline
1	323	23		Confidential
2	5	0		Confidential
3	60	0		Confidential
4	62	48		Confidential
5	40	3,800		Confidential
6	0	10,000		Confidential
<b>Total</b>	490	13,871	658	55,045 (19.3% of U.S. total)
Total U.S. Activity Factor Extrapolated by Miles	2,533 ± 776%	71,690 ± 787%	938 ± 100%	284,500

Only five of the six companies that responded to the survey reported having interconnects with other transmission companies. The activity factor was extrapolated based on pipeline miles and was calculated to be 2533 interconnects (transfers). The 90% confidence bound was determined to be ± 776%.

The count of farm taps appears to be extremely regional. Based on interviews, it seems that most companies have no farm taps, while others have thousands. The activity factor for farm taps was calculated to be 71,690 ± 787%. The calculated activity factor is believed to be conservatively high, since only a small percentage of all transmission companies have these M&R stations, yet two of the six companies in our data set reported a large number of farm taps.

The activity factor for direct industrial sales was developed from FERC Form No. 2, page 306.<sup>22</sup> Industrial sales greater than 50,000 Mcf are listed individually, while sales less than 50,000 Mcf are combined into a single item. In the latter case, the total amount of gas sold was divided by 25,000 to provide an estimate of the number of sales. The national activity factor was extrapolated from the FERC data to give a total count of 938 direct industrial sales. Due to the uncertainty that this approach introduced to the activity

factor and to the complexity of retrieving data from FERC, a confidence bound of  $\pm 100\%$  was assigned based on engineering judgement.

#### **7.5**            **Miles of Pipeline**

The total miles of transmission pipeline equals 284,500 miles for 1992<sup>2</sup> and is available from *Gas Facts*, Table 5-1. A confidence interval of  $\pm 5\%$  was assigned based on engineering judgement.

#### **7.6**            **Compressors and Dehydrators**

Activity factors for compressors and dehydrators were calculated in a single extrapolation procedure for all segments of the natural gas industry. The details of this procedure are outlined in Section 8.

#### **7.7**            **Pneumatics**

The number of natural gas operated pneumatic devices in the transmission and storage segment was calculated based on the average number of devices per station multiplied by the total number of transmission and storage stations nationally. Data for determining the average number of pneumatic devices per station are presented in Volume 12 on pneumatic devices.<sup>25</sup> The total number of transmission and storage stations is the sum of 1,700 transmission compressor stations, 386 underground storage facilities, and 89 liquid natural gas storage facilities (2,175).

## 8.0 CROSS-SEGMENT ACTIVITY FACTORS

Many equipment types are unique to a particular segment of the natural gas industry. The activity factors from these types of equipment, such as the count of distribution customer meters, were determined for each segment and are discussed in detail in the Sections 5, 6, 7, and 9. However, a few equipment types are common to all segments of the gas industry. Activity factors for these equipment types were determined in one step for the entire industry. This section of the report discusses two equipment types, compressors and dehydrators, that were determined on an industry-wide basis.

### 8.1 Compressors

Activity factors were developed for compressor horsepower-hours and for compressor counts on an industry-wide basis. Compressor horsepower was used as the basis for the compressor exhaust calculations, and compressor counts were used as the basis for the fugitive and unsteady emission calculations. Compressors exist in all segments of the industry except distribution.

#### 8.1.1 Compressor Horsepower-Hours

The two main types of compressor drivers in the industry are reciprocating gas engines and gas-fired turbines. Two pieces of information are needed to calculate the activity factors, expressed as horsepower-hours (hp-hr), for the two types of drivers in each segment of the industry except production. These data are the installed horsepower and the average annual operating hours. For the production segment, horsepower-hour data were available for the activity factor calculation. Table 8-1 presents the necessary parameters and the resulting activity factors for both engines and turbines by industry segment. This table also includes the 90% confidence limits for each factor.

**TABLE 8-1. COMPRESSOR ACTIVITY FACTORS FOR EACH INDUSTRY SEGMENT**

Industry Segment	Installed Engine MMhp <sup>a</sup>	Installed Turbine MMhp <sup>a</sup>	Annual Hours Engine	Annual Hours Turbine	Engine MMHp-hr	Turbine MMHp-hr
Production	NA	NA	NA	NA	27,460 ± 200%	NA
Processing	4.19 ± 132% <sup>b</sup>	5.19 ± 99% <sup>b</sup>	6626 ± 12%	6345 ± 48%	27,760 ± 133%	32,910 ± 121%
Transmission:						
Compressor Drivers	10.2 ± 10%	4.55 ± 10%	3964 ± 14%	2118 ± 31%	40,380 ± 17%	9635 ± 33%
Generator Drivers	1.45 ± 23%	0.045 ± 166%	1352 ± 38%	474 ± 620%	1962 ± 45%	21.2 ± 1215%
Storage						
Compressor Drivers	1.33 ± 14%	0.59 ± 14%	3707 ± 23%	2917 ± 620%	4922 ± 27%	1729 ± 626%
Generator Drivers	0.085 ± 126%	0.057 ± 184%	191 ± 377%	36 ± 620%	16.3 ± 621%	2.05 ± 1312%

<sup>a</sup> Does not include horsepower associated with gas lift for oil recovery or with electric drivers.

<sup>b</sup> Average of two estimation methods.

To determine the horsepower and operating hours for engines and turbines, four major sources of data are available: 1) the methane project site visits, 2) the A.G.A. / GRI/Southwest Research Institute (SwRI) compressor databases, 3) the Federal Energy Regulatory Commission (FERC) Form No. 2 Database, and 4) individual company databases. The site visits and company databases were used to determine horsepower and operating hours for the processing industry segment and for transmission and storage generators. The A.G.A./GRI/SwRI databases were used to determine horsepower for the transmission industry segment. Operating hours for the storage industry segment were based on data from site visits and company databases. Operating hours for the transmission industry segment were based on data from FERC.<sup>22</sup>

The horsepower-hours for the production industry segment were determined using data provided by a major natural gas production company. A brief discussion of the development of each of the activity factors follows. (For further details, refer to the report *Methane Emissions from the Natural Gas Industry, Volume 11: Compressor Driver Exhaust*.<sup>19</sup>)

**Production--**The production segment horsepower is based on horsepower-hour data from one company for 516 engine drivers. The database included drivers in the Gulf Coast (Onshore and Offshore) and Central Plains regions. The total horsepower-hours were divided by the company's total gas production before scaling to a national estimate. National horsepower-hours were calculated to be 27,460 MMhp•hr using the 1992 marketed gas production for the entire United States (*Natural Gas Annual, 1992*).<sup>5</sup> Confidence limits for the hp-hr/throughput ratio for the database were calculated to be  $\pm 576\%$ . However, this value was shown by engineering analysis to be unreasonably high.<sup>19</sup> Therefore, the confidence limits on the national estimate were set at  $\pm 200\%$  based on engineering judgement.

A few turbine compressor drivers do exist in the production segment; however, the total population is insignificant and was therefore not included in the summary

calculations. This emission source would be an insignificant source due to the small number of these drivers in this industry segment and the low methane emission factor for turbines.

**Processing**--The processing segment horsepower was determined by extrapolating site visit data for ten gas plants. The average of two extrapolation methods was used. The first method extrapolates the site data to a national number by multiplying the total U.S. gas plant throughput as of January 1, 1993 (46,510.7 MMcfd, *Oil & Gas Journal*<sup>9</sup>) by the site visit horsepower per throughput (47.8 hp/MMcfd for engines and 59.2 hp/MMcfd for turbines). This gives a total of 2.22 MMhp for engines and 2.75 MMhp for turbines.

The second method scales up the data by plant count, assuming the visited plants are perfectly representative. A national estimate is produced by multiplying the horsepower from the site visits by a ratio of 726/10 [the 726 gas plants in the United States (*Oil & Gas Journal*) to the 10 sites visited]. This second method, therefore, uses a scaling factor of approximately 73 for processing horsepower and assumes that all gas plants have approximately the same throughput, despite the variation found in the site data (40 MMcfd to 750 MMcfd). The activity factors based on the number of gas plants are 6.16 MMhp for engines and 7.62 MMhp for turbines.

To provide a more conservative estimate, the two methods were averaged when calculating the national estimate for processing horsepower. The resulting activity factors are 4.19 MMhp for engines and 5.18 MMhp for turbines.

The annual operating hours were based on the ten site visits and data provided from two companies (18 additional sites). For eight of the sites visited, typical operating hours for each of the compressors were not available. Therefore, all compressors that were running during these site visits were assigned annual operating hours of 8760 and all compressors that were idle were assigned annual operating hours of 0. An average of the average operating hours per site was calculated to get the processing segment operating hours

(203 engines and 9 turbines). Confidence limits were calculated for the horsepower and operating hours estimates from the variation of the data.

**Transmission--**Transmission losses from compressor exhaust have been divided into two subsections: compressor stations and storage fields. For each of these areas, activity factors were calculated for compressor drivers and for generator drivers.

Transmission Compressor Stations--The transmission segment horsepower for each compressor type was determined using the GRI TRANSDAT database.<sup>26</sup> GRI TRANSDAT has not been revised since the 1989 data were collected, and it is assumed that the data are valid for the 1992 base year. Installed horsepower was taken from the Industry Database module of GRI TRANSDAT (11.2 MMhp for engines and 5.0 MMhp for turbines). This horsepower number accounts for about 97% of the gas utility industry installed 16.7 MMhp reported by A.G.A. for 1989.<sup>23</sup>

The horsepower values in GRI TRANSDAT are a combination of transmission and storage compressor drivers. GRI TRANSDAT also reports that there were 1.5 MMhp in the storage segment in 1989. Since GRI TRANSDAT did not give separate values for engines and turbines in storage, the ratio of engines to turbines in the overall database (11.2:5.0) was used giving 1.0 MMhp for engines and 0.5 MMhp for turbines in storage. The overall GRI TRANSDAT horsepower numbers were then adjusted for the 1989 storage horsepower numbers to give 10.2 MMhp for engines and 4.5 MMhp for turbines in the transmission segments.

Confidence limits for horsepower could not be rigorously calculated from the GRI TRANSDAT database because the installed horsepower was given by installation, or site, and then summed to calculate a national estimate. Therefore, confidence limits were set based on engineering judgement.

The annual operating hours are based on data reported on FERC Form No. 2 for the year 1992.<sup>22</sup> The FERC database did not identify the type of driver (i.e., reciprocating engine or turbine). As a result, additional data from GRI TRANSDAT and one transmission company were used to split the FERC hours between the two driver types. Confidence limits were calculated for the operating hours estimate from the variation of the FERC data.

Transmission Storage Fields--The storage segment horsepower (1,920,441 hp) came from *Gas Facts* Table 4-5 for 1992.<sup>2</sup> The split between engines and turbines was assumed to be the same as the engine and turbine split found in GRI TRANSDAT (69.1% for engines and 30.9% for turbines). The horsepower data were gathered by A.G.A. through a survey of their member companies, whose production makes up approximately 96% of total gas industry sales. Confidence limits for horsepower data were calculated based on an assumed  $\pm 5\%$  uncertainty for the A.G.A. horsepower and an assumed  $\pm 10\%$  uncertainty for the GRI TRANSDAT horsepower splits.

The annual operating hours are based on site visit data and a company database for a total of eleven storage stations (50 engines and 6 turbines). Confidence limits were calculated for the operating hours estimates from the variation of the data.

Transmission Generators--Generators were found at both compressor stations and storage fields. The generator horsepower for compressor stations is based on the total installed horsepower at seven sites and data provided by one company for 34 compressor stations (35,006 hp for engines and 1080 hp for turbines). To extrapolate to a national estimate, the horsepower per station was multiplied by the total number of transmission compressor stations in the United States (1700, FERC Form No. 2).<sup>22</sup>

The generator horsepower for storage fields is based on the total installed horsepower for one company with nine storage fields (3 engines and 1 turbine). To



extrapolate to a national estimate, the horsepower per field was multiplied by the total number of storage fields in the U.S. (475; A.G.A. *Gas Facts*, Section 7.2).

Generator annual operating hours were also provided by the same sources providing horsepower data. An average of the average generator operating hours per site was calculated to determine generator operating hours for compressor stations (87 engines and 1 turbine) and storage fields (2 engines and 1 turbine). Confidence limits were calculated for the horsepower and operating hour estimates from the variation of the site/company data except for the case of generator turbines. Since there was only one data point for both compressor station generator turbines and storage field generator turbines, confidence limits were assumed to be equal to those calculated for turbine compressor drivers at storage fields.

The final activity factors (Table 8-1), in horsepower-hours, were calculated using the national estimates for compressor horsepower and the average operating hours for each industry segment except for the production segment. Production horsepower-hours were estimated as described above. Activity factor confidence limits were propagated from the confidence limits for the individual terms using a standard statistical approach.

### **8.1.2 Compressor Counts**

Compressor counts were developed using a variety of sources. National data from DOE and site visit data were used to make the estimates. Table 8-2 provides a summary of the results and the 90% confidence bounds.

**Production**--The compressor counts in the production segment were developed from the site data collection and a regional extrapolation that is explained in detail in Section 5.7. Confidence bounds were calculated for these estimates from the variation of the site data.

TABLE 8-2. COMPRESSOR COUNTS IN THE GAS INDUSTRY

Segment	Reciprocating Engines	Turbines	Total Compressors
Production	17,112 ± 52% <sup>b</sup>	0 <sup>a</sup>	32,327 ± 64%
Gas Plants	4,092 ± 47.7%	726 ± 76.6%	4,818 ± 44%
Transmission	6,785 ± 16.6%	681 ± 26.2%	7,466 ± 15%
Storage	930 ± 58.3%	136 ± 119%	1,066 ± 54%
Combined Transmission & Storage	7,715 ± 10%	817 ± 10%	8,532 ± 9.1%
Total Industry	44,134	1,543	45,677

<sup>a</sup> Only one production site (out of 27 with data on compressors) had any turbines. However, those "gathering compressors" actually were physically part of an attached gas plant, and were therefore added into the gas plant counts.

<sup>b</sup> Non-gas lift compressors

Along with the count of total compressors used in production, it was also necessary to determine an activity factor for compressors at large gathering compressor stations. Compressors in transmission and storage stations were found to have blowdown vent lines routed to the atmosphere through a separate stack. Because of the lack of a good seal on the blowdown valves, these blowdown lines were found to have extremely large continuous fugitive emission rates. These emission rates had not been considered or measured until the GRI/EPA campaign to measure fugitive emissions from transmission compressors that occurred in late 1994.

Originally, it was assumed that compressors used in production did not have these separate vent lines, or that the vent lines were small and located proximate to the compressors so that the API/EPA fugitive measurement efforts had included them. However, several companies reported that some large gathering compressor stations (that had a large number of engines) were similar to transmission stations, and did have these separate vent lines to a separate stack.

Therefore, for production, the FERC<sup>22</sup> data were analyzed for gathering stations. (Gathering was included in the production segment.) In FERC Form No. 2, the number of stages of compression operating on the peak demand day is reported. It was assumed that there are an average of 3.3 stages of compression per compressor, and that a

large station would contain at least five compressors. Therefore, a station with 16 or more stages of compression was counted as a large gathering compressor station. Based on this criteria, three large gathering compressor stations were identified in the FERC data. This number was then extrapolated from the 86,200 miles of gathering pipeline mileage owned by transmission companies, to the national activity factor of 340,000 gathering pipeline miles, for a total of twelve large compressor stations in production. The FERC data also showed that the large compressor stations averaged 26 stages of compression, or eight compressors per large station. This value was extrapolated in the same manner to provide a national activity factor of 96 compressors at large gathering compressor stations. A confidence interval of  $\pm 100\%$  was assigned to the activity factor for large stations and for compressors at large stations based on engineering judgement.

**Processing**--The compressor counts for the processing segment were determined from eleven gas plant site visits. The average ratio of compressors per plant was multiplied by the 742 plants (see section 6.1) to obtain the values in the table. Confidence bounds were calculated for these estimates from the variation of the site data.

**Transmission & Storage**--The GRI TRANSDAT industry database was used to estimate the total compressor counts.<sup>26</sup> The industry database of 16.2 MMHp had 7489 engines and 793 turbines. However, the database is not quite a complete sample of the transmission/storage sector since its horsepower is slightly lower than the total transmission/storage horsepower of 16.7 MMHp for the year 1992 (as shown in *Gas Facts*, Table 5-5, "Gas Utility Industry Installed Compressor Horsepower, 1968-1993"<sup>2</sup>). Therefore, the database totals were multiplied by the ratio of the two values (16.7/16.2) to determine the adjusted totals of 7715 engines and 817 turbines. Confidence bounds were not calculated but were estimated to be  $\pm 10\%$  based upon the large size of the TRANSDAT database and the tight confidence of the *Gas Facts* data.

The combined transmission/storage count of storage compressors was divided into separate categories (i.e., transmission and storage) based upon site visit data and *Gas*

*Facts* data. Site visits to eight storage sites produced ratios of 0.750 turbines per site ( $\pm 119\%$ ), 5.13 reciprocating engines per site ( $\pm 58.3\%$ ), and 13,033 HP/site. The site data are assumed to have come from larger than average stations since *Gas Facts* shows that the actual horsepower per underground storage site for 1992 was only 4975 HP/site (Table 4-5, "Amount of Pools, Wells, Stored Gas, and Horsepower in Underground Storage Fields, By State, 1990-1992"<sup>2</sup>). Therefore, the site ratios were adjusted to account for the higher than average horsepower by multiplying by 4975/13033. The adjusted ratios were then multiplied by the 475 storage compressor stations (see Section 7.2). Transmission compressor counts were then determined by subtracting the count of compressors in storage (1066) from those determined by the TRANSDAT database analysis.

## 8.2 Dehydrators

Multiple activity factors associated with dehydrators were determined for the entire gas industry. These factors are based on industry segment gas throughput, and the percentage of units with flash drums, gas pumps, and stripping gas. This study is only concerned with glycol-based dehydrators (as opposed to dry-bed) since only the glycol dehydrators emit methane.

### 8.2.1 Dehydrator Count

A national count of 41,700 dehydrators in the gas industry was recently determined by a 1994 GRI study performed by Wright Killen & Company.<sup>18</sup> The study, "Natural Gas Dehydration, Status and Trends," used several states' large survey databases [Wyoming, Texas Mid-continent Oil & Gas Association (TMOGA), and the Louisiana Department of Environmental Quality (LDEQ)] to determine the count of dehydrators in the natural gas industry. The Wright Killen study divided the dehydrators into segments of the natural gas industry based on data from the TMOGA and Gas Processors Association (GPA) survey.<sup>27</sup> The information in this survey allowed Wright Killen to estimate the counts of

dehydrators in the different industry segments. These values can be found in the first column of Table 8-3.

**TABLE 8-3. U.S. GAS INDUSTRY DEHYDRATOR COUNTS**

Segment	Wright-Killen Total Dehydrator Counts (All types)	Glycol Dehydrator Count Based on Adjusted Totals
Production	25270	37824
Gas Processing Plants	7923	498
Transmission	8507	201
Storage	NA	1092
Total Gas Industry	41700	39615

This GRI/EPA study used the Wright Killen report as the basis for the overall count of dehydrators because the report provides a reasonably accurate estimate of the industry. The Wright Killen report estimates that there are 7923 dehydrators at 742 plants, or 10.6 dehydrators per gas plant. However, in the Wright Killen study, the dehydrators were split into industry segments using data from a single regional survey; as a result, the gas plant dehydrator count is unrealistically high. This study adjusted the Wright Killen split based on GRI/EPA's information from 11 gas plants that shows only 1.41 dehydrators per plant. Starting with the *Oil & Gas Journal* annual gas processing plant list, an estimate of the count of glycol-based dehydrators (as opposed to dry-bed) was made. All refrigerated processes were assumed to use glycol dehydration, and all cryogenic processes were assumed to use dry-bed dehydration. Based on these assumptions, the percentage of glycol-based units in the industry is estimated as 48.6% (a total of 498 glycol dehydrators).

Similarly, the Wright Killen estimate produces 8507 dehydrators for 2190 transmission/storage compressor stations, or 3.9 dehydrators per compressor station. GRI/EPA's data show 2 dehydrators for 17 mainline transmission stations and 17 dehydrators for 6 storage stations. The Wright Killen split is probably in error since the TMOGA/GPA production segment survey has too few small dehydrators and too many large dehydrators to

represent the true national production totals. This assessment of the data is validated by the fact that Texas, where the study was performed, has a higher production rate per well than the national average. Therefore, the splits between industry segments may be biased if the national percentage of production dehydrators is larger than in Texas.

This GRI/EPA study also corrected the production total to 37,824 units to maintain the total national count estimated by Wright Killen. These corrected industry segment counts are listed in the second data column of Table 8-3.

By using the site visit ratios for 1700 mainline transmission stations, an estimate of 201 dehydrators in transmission service was determined. For the 386 underground storage stations, the site visit ratio produces an estimate of 1092 in storage service.

The Wright Killen study also found that on an industry-wide basis, 95% of the dehydrators were glycol-using (as opposed to molecular sieve adsorbers or other types of water removal). Based on the 95% value, the total number of glycol dehydrators in the production, transmission, and storage segments was calculated to be 39,615. These data have confidence limits of  $\pm 20\%$  based on Wright Killen's 90% confidence limits. All dehydrators in this survey are assumed to be active.

### **8.2.2 Dehydrator Throughput**

Emissions from dehydrators are proportional to the gas throughput of the dehydrator. Therefore, an activity factor for throughput for each industry segment was determined. There is a direct relationship between the estimated count of dehydrators and the average throughput per dehydrator. In fact, the Wright Killen study determined the production count by dividing known gas production rates by an estimated dehydrator throughput. Therefore, the GRI/EPA study used the Wright Killen report as the basis for the

dehydrator gas throughput used in this project. The throughput numbers selected for this project are shown in Table 8-4.

**TABLE 8-4. INDUSTRY SEGMENT GLYCOL DEHYDRATOR THROUGHPUT**

Segment	Average Throughput with 90% Confidence Intervals	Basis
Production	12.4 Tscf/yr $\pm$ 62%	WK&C (Adjusted Wyoming data) <sup>18</sup>
Gas Processing Plants	8.63 Tscf/yr $\pm$ 22%	<i>Oil and Gas Journal</i> <sup>9</sup>
Transmission	1.09 Tscf/yr $\pm$ 144%	TMOGA <sup>26</sup>
Storage	2.00 Tscf/yr $\pm$ 25%	A.G.A. <i>Gas Facts</i> <sup>2</sup>

**Production--**Wright Killen estimated that the average throughput per dehydrator in production is 2 MMscfd. This value has been validated by analysis of three data sources, as follows:

- The Wyoming dehydrator survey (as adjusted by Wright Killen), which is believed to be the most comprehensive survey, reports a value of 2 MMscfd per production segment dehydrator.
- The TMOGA survey produced an average throughput value in the 8.1 to 8.5 MMscfd range, but the study is believed to be biased toward the higher values in the production segment. This bias is caused by the higher production rate per well in the Texas region. Therefore, the median value (as opposed to the average value) of the Texas survey is likely to be more representative of a true national average, since the median value is not heavily weighted by a few large dehydrators. The median value of the Texas (TMOGA) survey is 2 MMscfd.
- The site visits produced an average of 12.5 MMscfd/dehydrator. However, many of the sites visited have higher production rate-to-number of wells ratios than the national average. If the two largest dehydrators, which are in the Gulf Coast, are excluded from the total, the resulting average is only 1.14 MMscfd/dehydrator.

The total production throughput was calculated by multiplying the average throughput per dehydrator by the number of dehydrators in the production segment and by a capacity utilization factor. Operators of several production sites studied for another GRI project indicated that the typical production dehydrator was using less than half its original capacity. The capacity utilization factor was determined to be  $0.45 \pm 33\%$ .

**Gas Processing--**Throughput for the gas processing industry segment was determined from the annual *Oil and Gas Journal* survey of processing plants.<sup>9</sup> It was assumed that plants using a refrigerated process have glycol dehydration and plants using a cryogenic process have some type of dry-bed dehydration with no methane emissions. For a total gas processing throughput of 17.44 Tscf/year, these assumptions lead to a flow of 8.63 Tscf/year that is dehydrated by glycol. No distinction was made between triethylene glycol (TEG) and ethylene glycol (EG), since the methane emissions for the two glycol processes are similar. [Note that benzene, toluene, ethyl benzene, and xylene (BTEX) emissions for EG may be several orders of magnitude lower than for TEG.]

**Transmission--**Transmission segment throughput was determined in much the same way as was production. The Wright Killen survey indicated an average transmission dehydrator throughput of 14.8 MMscfd and an adjusted count of 201 transmission dehydrators, for a total throughput of 1.09 Tscf/year.

**Storage--**Storage segment throughput was determined from data in *A.G.A. Gas Facts*, Table 4-3.<sup>2</sup> Withdrawals from storage in 1992 were 2.41 Tscf. It was assumed that most gas taken from storage is dehydrated, so storage dehydrator throughput was estimated to be 2.00 Tscf/year  $\pm 25\%$ .



### **8.2.3 Dehydrator Flash Drums**

One of the dehydrator equipment accessories that can have a large impact on emissions is the three-phase flash drum. Data on flash drum existence were available from the TMOGA survey<sup>27</sup> and from the site visits. The results are shown in Table 8-5.

As discussed previously, the production segment of the TMOGA database is believed to be biased toward larger dehydrators, since the Texas production per well ratio is higher than the national average. Since analysis of the TMOGA database does show a relation between dehydrator size and the existence of a flash drum (especially for sizes below 2 MMscfd), the number of large dehydrators in the TMOGA database may bias the average flash drum percentage high. The site visits may be biased toward smaller dehydrators but are not believed to have the same degree of bias as the TMOGA data set. The result was a 3.31% number for production dehydrators.

### **8.2.4 Dehydrator Gas Pumps**

Another important piece of glycol dehydrator equipment is the type of pump that circulates glycol. The activity factor for gas-driven glycol circulation pumps is calculated on the same basis as the dehydrator vented emissions (i.e., Tscf/year gas throughput for each industry segment). The total gas throughputs listed in Table 8-4 were multiplied by the fraction of dehydrators using gas-driven pumps to determine the gas-driven pump activity factor. This value is based on the average from Radian site surveys of the number of pumps per dehydrator. The results are displayed in the Table 8-6.

### **8.2.5 Dehydrator Stripping Gas Use**

The percent of dehydrators using stripping gas was determined from the site surveys. The site surveys showed that less than 0.5% of all production dehydrators use stripping gas. The use of stripping gas is more common in the other three industry segments, with 11.1% for gas processing, 7.4% for transmission, and 8.0% for storage.

**TABLE 8-5. U.S. GAS INDUSTRY DEHYDRATOR FLASH DRUMS**

Industry Segment	Percent of Dehydrators with Flash Drums* (with 90% confidence bounds)			
	Unadjusted TMOGA Survey Results	Site Visits	Selected Numbers	Basis
Production	42.4 ± 8.5%	3.31 ± 43.2%	26.5 ± 8.35%	TMOGA and site visits
Gas Processing Plants	66.7 ± 8.5%	66.7 ± 46.5%	66.7 ± 10.1%	TMOGA and site visits
Transmission	66.9 ± 9.7%	NA	66.9 ± 9.70%	TMOGA
Storage	NA	52.0 ± 33.6%	52.0 ± 33.6	Site visits

\* The number of dehydrators were divided by survey: Unadjusted TMOGA results (618 in production, 207 in processing, and 192 in transmission/storage) and site visits (408 in production, 11 in processing, 2 in transmission, and 25 in storage).

**TABLE 8-6. SITE SURVEY GAS PUMP DATA**

Segment	Active Gas Pumps per Dehydrator (with 90% confidence limits)	Total Industry Throughput Tscf/year	Gas-driven Pump Throughput Tscf/year
Production	0.891 ± 2.79%	12.4 ± 48.2%	11.1 ± 62.0%
Gas Processing Plants	0.111 ± 186%	8.63 ± 22.4%	0.958 ± 192%
Transmission	0	1.09 ± 130%	0
Storage	0	2.00 ± 25.0%	0
Total		24.1 ± 26.8%	12.1 ± 58.6%

### 8.2.6 Dehydrator Vapor Recovery Use

Due to regulations restricting benzene, toluene, ethylbenzene, and xylene (BTEX) emissions, many sites have begun to install vapor recovery systems on glycol dehydrator reboiler/regenerator vents. However, not all of these systems prevent the release of the methane since methane emissions are not regulated. Because of the lack of prevention against methane release, the only vapor recovery systems counted for this study were those that captured and burned the methane from the vent. The results are displayed in Table 8-7. The site visits did not identify any gas processing plants with vapor recovery systems that consume methane. However, there are likely to be some plants with methane vapor

recovery. For calculation purposes, the fraction of plants with methane emission controls was assumed to be  $0.10 \pm 90\%$ .

**TABLE 8-7. SITE SURVEY STRIPPING GAS AND VAPOR RECOVERY DATA**

Segment	Fraction of Dehydrators with Active Stripping Gas (with 90% confidence limits)	Fraction of Dehydrators With Vapor Recovery that Consumes Methane (with 90% confidence limits)
Production	0.0047 ± 116%	0.012 ± 73.1%
Gas Processing Plants	0.111 ± 186%	0.0 ± 0% <sup>a</sup>
Transmission	0.074 ± 118%	0.148 ± 80.3%
Storage	0.080 ± 118%	0.160 ± 80.0%

<sup>a</sup> No vapor recovery was found during the site visits but it is likely that some processing plants have flares. A value of  $0.10 \pm 90\%$  was used in the calculations.

## 9.0 DISTRIBUTION SEGMENT

Activity factors were developed for each of the sources of methane emissions from the distribution segment of the gas industry. The activity factors that were used in the distribution segment are the following: total leaks in underground distribution mains and services; metering and pressure regulating stations; customer meters; and total miles of mains and services used to determine losses from pipeline third-party damage (i.e., dig-ins) as well as pipeline blow and purge for maintenance/installation activities. A discussion of the methodology used to derive these activity factors is presented in this section.

### 9.1 Distribution Annual Equivalent Leaks

Since the emission factor for quantifying emissions from underground distribution mains and services was stratified by pipe use (mains versus services) and by pipe material (i.e., cast iron, cathodically protected steel, unprotected steel, plastic, and copper), the activity factor was also stratified to extrapolate emissions.

With the exception of cast iron main pipeline, the activity factor used to extrapolate the leakage estimate for underground distribution mains and services was the number of annual equivalent leaks. (For cast iron pipeline, the activity factor was the total mileage of cast iron mains in the United States, which is a nationally tracked statistic.<sup>28</sup>) Annual equivalent leaks are defined as the number of leaks that leak continuously year round. For example, if leaks that are repaired during the year are leaking for half the year, on average, then each repaired leak would be counted as half an annual equivalent leak.

The number of annual equivalent leaks was derived from the national database of leak repair records broken down by mains and services (U.S. Department of Transportation, Research and Special Programs Administration).<sup>28</sup> To allocate leak repairs into pipe material categories, data were collected from ten local distribution companies

representing different regions within North America. An estimate of the national leak repairs allocated by pipe material type is shown in Table 9-1.

To derive annual equivalent leaks from the national leak repair records, additional information was needed including the number of leaks found during the year (leak indications) and the unrepaired leaks at the beginning of the year (outstanding leaks). Since leak indications and outstanding leaks are not tracked nationally, this information was requested from individual companies.

Data were collected from the companies participating in the cooperative leak measurement program on the annual number of leak repairs, number of leak indications, and outstanding leaks at the beginning of the year (reference year in most cases was 1991). The data were requested to be disaggregated by mains versus services and by pipe material. Complete data were provided by only four companies, coupled with a breakdown of the total mileage of mains and number of services by pipe material. Two additional companies provided data without a breakdown by pipe material or use. (The leak data disaggregated by pipe use and material type are difficult to obtain from many companies, since leak records are often not maintained in this manner.)

An estimate of the total annual equivalent leaks for each of the six companies was developed for each pipe material category except cast iron, based on the following formula:

$$\text{TEL} = \text{OL} + \text{LI} + \text{UDL} + \text{URL} - (0.5 \times \text{RL})$$

where

TEL = Total annual equivalent leaks;

OL = Outstanding leaks at the beginning of the year;

TABLE 9-1. NATIONAL LEAK REPAIRS ALLOCATED BY PIPE MATERIAL CATEGORY

Pipe Use	Pipe Material	Average Leak Repairs/Mile <sup>a</sup>	National Miles/Services <sup>b</sup>	Extrapolated Leak Repairs	Percent Leak Repairs	Estimated Total Leak Repairs	Precision (Leak Repairs)
Mains	Cast Iron	1.38	55,288	76,353	34	69,750	39,957
	Protected Steel	0.08	451,466	34,943	16	31,922	14,006
	Unprotected Steel	1.09	82,109	89,417	40	81,685	50,645
	Plastic	0.08	299,421	25,151	11	22,976	22,862
	Subtotal			255,864	100	206,333 <sup>b</sup>	
Services	Protected Steel	0.006	20,352,983	126,188	42	181,752	206,405
	Unprotected Steel	0.027	5,446,393	148,686	50	214,156	190,569
	Plastic	0.001	17,681,238	22,986	8	33,107	26,238
	Copper	0.011	233,246	2,519	1	3,628	3,165
	Subtotal			300,379	100	432,643 <sup>b</sup>	

<sup>a</sup> Based on data provided by ten companies.

<sup>b</sup> Based on nationally tracked database, U.S. Department of Transportation, Research and Special Programs Administration.<sup>27</sup>

- LI = Leak indications recorded during the year, including call-ins;
- UDL = Undetected leaks which cannot be found using an industry standard survey procedure;
- URL = Unreported leaks that have developed in parts of the network not surveyed during the current year; and
- RL = Repaired leaks -- estimated to be leaking half the year, on average.

Undetected leaks that cannot be found using an industry standard survey procedure were quantified based on information provided by Southern Cross.<sup>29</sup> According to their experience in performing leak surveys and survey audits, Southern Cross predicts that a standard industry survey procedure using a flame ionization detector (FID) instrument finds 85% of the leaks. (Note: The standard industry survey procedure involves using either a walking or mobile survey, as appropriate for the area being surveyed, using an FID instrument. Any potential leak that is found with the FID instrument, registering any concentration above background, is investigated using bar holing procedures.) Therefore, the number of undetected leaks is estimated by:

$$UDL = [(1/0.85) - 1] \times LI$$

The total annual equivalent leaks are derived using the estimated leak duration for each type of leak, based on the following:

- Repaired leaks are assumed to be leaking half the year, on average.
- Outstanding leaks, leak indications, and undetected leaks are estimated to be leaking the entire year (i.e., 8760 hours per year).

The leak duration of unreported leaks is factored into the estimation methodology for these leaks. Unreported leaks are those leaks that occur in parts of the network not surveyed during the year (i.e., multi-year survey cycle). The number of unreported leaks is based on

the annual leak indications and the undetected leaks as well as the frequency of the leak survey. The number of unreported leaks in the system that is surveyed every  $n$  years is calculated based on the following:

- For the first year in the cycle --  $1/n \times (LI + UDL)$  leaks are leaking half the year;  $(n-1)/n \times (LI + UDL)$  leaks are not yet leaking.
- For the second year in the cycle --  $1/n \times (LI + UDL)$  leaks are leaking the entire year;  $1/n \times (LI + UDL)$  leaks are leaking half the year; and  $(n-2)/n \times (LI + UDL)$  leaks are not yet leaking.
- For the third year in the cycle --  $2/n \times (LI + UDL)$  leaks are leaking the entire year;  $1/n \times (LI + UDL)$  leaks are leaking half the year; and  $(n-3)/n \times (LI + UDL)$  leaks are not yet leaking.
- For the fourth year in the cycle --  $3/n \times (LI + UDL)$  leaks are leaking the entire year;  $1/n \times (LI + UDL)$  leaks are leaking half the year; and  $(n-4)/n \times (LI + UDL)$  leaks are not yet leaking.

Based on the methodology described above, the number of equivalent leaks was determined for each of the six companies providing detailed data. The ratio of equivalent leaks to leak repairs was then calculated for each of the companies. The average ratio of equivalent leaks to leak repairs was used to extrapolate the national database of leak repairs. Table 9-2 presents a summary of the leak record data provided by the six companies, the estimated equivalent leaks, and the corresponding ratio of equivalent leaks to leak repairs. As shown, the average ratio of equivalent leaks to leak repairs is 2.14.

The national number of annual equivalent leaks, broken down by pipe use and material type, is shown in Table 9-3. As shown, the activity factor for cast iron mains is miles of pipeline, to correspond to the emission factor in units of scf/mile-year. The estimate of annual equivalent leaks is highest for unprotected steel services, followed by protected steel services. For mains, unprotected steel is the category with the highest estimated annual equivalent leaks. The precision of the number is based on the variability in leak repair data allocated by material type from ten companies and the variability in the ratio of equivalent leaks per leak repair from six companies.



TABLE 9-2. SUMMARY OF LEAK RECORD DATA FROM PARTICIPATING COMPANIES

Company	Annual Leak Indications	Annual Leak Repairs	Annual Outstanding Leaks	Estimated Total Equivalent Leaks	Ratio of Equivalent Leaks to Leak Repairs
A	3,747 <sup>a</sup>	2,061 <sup>a</sup>	0	3,378	1.64
B	9,249	17,003	11,701	18,796	1.11
C	2,115	2,443	0	2,832	1.16
D	-- <sup>b</sup>	14,681	-- <sup>b</sup>	41,286	2.81
E	1,999	2,287	2,396	6,250	2.73
F	5,992	3,421	1,558	11,597	3.39
Average					2.14
Precision					0.79

<sup>a</sup> Mains only.

<sup>b</sup> Data not available.

**TABLE 9-3. SUMMARY OF ACTIVITY FACTORS FOR DISTRIBUTION UNDERGROUND PIPELINES**

Pipe Use	Material Category	Estimated Total Leak Repairs <sup>a</sup>	Average Activity Factor (equivalent leaks) <sup>b</sup>	Precision of Activity Factor (equivalent leaks)
Mains	Cast Iron	69,750	55,288 <sup>c</sup>	2,764 <sup>c</sup>
	Protected Steel	31,922	68,308	42,545
	Unprotected Steel	81,685	174,657	101,685
	Plastic	22,976	49,226	58,018
	Subtotal	206,333		
Services	Protected Steel	181,752	390,628	526,354
	Unprotected Steel	214,156	458,476	499,850
	Plastic	33,107	68,903	66,840
	Copper	3,628	7,720	8,521
	Subtotal	432,643		

<sup>a</sup> Based on national leak repair database<sup>27</sup> and data provided by six companies (see Tables 9-1 and 9-2).

<sup>b</sup> Based on ratio of annual equivalent leaks to leak repairs of 2.14 (see Table 9-2).

<sup>c</sup> Miles.

## 9.2

### Distribution Metering and Pressure Regulating Stations

Since the emission factor for predicting emissions from metering and pressure regulating stations was stratified into station type, inlet pressure range, and location categories, the activity factor was also stratified to produce an overall estimate of emissions from stations in each segment of the gas industry.

For distribution stations, a questionnaire was sent to distribution companies participating in the underground leak measurement program and the companies participating in the metering/pressure regulating station measurement program. A total of ten companies provided demographic information on the stations in their distribution network. The station counts provided by the companies were disaggregated by station type and inlet pressure range. Table 9-4 presents the demographic information provided by the respective companies.

To extrapolate the individual company data to a national number of stations, a known industry statistic was used. The individual company demographic data were combined with the miles of main and total gas throughput for each company to determine the number of stations in each category on a per mile of main and per unit of throughput basis. Linear regression analyses were performed on the number of stations versus both miles of mains and total gas throughput, respectively. It was concluded that the number of stations should be extrapolated by miles of mains since the variability within the sample set was lower for number of stations per mile than for number of stations per throughput.

The average number of stations per mile was calculated from the individual company data and multiplied by the total mileage of main pipeline in the United States.<sup>28</sup> The standard deviation of each number was calculated based on the variability in the individual company data.

**TABLE 9-4. ACTIVITY DATA PROVIDED BY INDIVIDUAL COMPANIES**

Station Type Inlet Pressure Range (psig)	Comp A	Comp B	Comp. C	Comp. D	Comp. E	Comp. F	Comp. G	Comp. H	Comp. I	Comp. J	Comp. K	Comp L*
M&R Stations												
> 300	14	6	18	19	--	25	1	0	--	29	128	15
100-300	8	15	0	0	--	600	0	0	--	286	431	2
40-100	1	2	0	0	--	0	0	0	--	170	252	0
<40	0	0	0	0	--	0	0	0	--	48	97	0
Regulating Stations												
> 300	720	0	0	0	0	30	2	1	34	29	87	0
100-300	1,187	0	258	94	25	210	0	0	44	286	835	273
40-100	207	1,257	0	325	44	400	11	8	136	170	2,122	120
<40	12	0	130	28	203	1,000	0	0	53	48	935	0
Miles Main	40,930	30,934	7,594	4,000	3,924	14,900	64	78	4,109	3,396	29,073	1,263

\* Not considered representative of national average.

Data were collected from three of the ten companies on the number of regulating stations in vaults versus above ground. Based on the data collected, about half of the regulating stations with an inlet pressure greater than 300 psig were observed to be located in vaults. For regulating stations with an inlet pressure between 40 and 300 psig, the majority of stations in urban areas were in vaults and the majority in rural areas were above ground. On average, it was estimated that 55% of the stations are located in vaults with an inlet pressure between 100 and 300 psig.

For regulating stations with an inlet pressure between 40 and 100 psig, about 70% of the stations are located in vaults. Based on the data collected, essentially all low-pressure (<40 psig) stations are located in vaults. Table 9-5 shows the number of stations disaggregated by station type, inlet pressure range, and location in a vault versus above ground.

### 9.3 Customer Meters

The total number of customer meters in the U.S. gas industry, 56,132,300, and the number of residential customer meters, 51,524,600, were based on *Gas Facts*, Table 8-1.<sup>2</sup> The number of residential customer meters located indoors versus outdoors was estimated based on a regional breakdown of total customers presented in *Gas Facts*. Based on data collected from 22 companies located in six regions within the United States, the majority of customer meters in urban, northern areas of the country are located indoors, while the majority of customer meters located in non-urban areas and in the southern areas are located outdoors. On average, approximately 22% of residential customer meters are located indoors. The leakage rates from customer meters located indoors was assumed to be negligible based on the increased probability that leaks on indoor meter sets are detected and repaired promptly. This assumption of negligible leakage from indoor meters is consistent with the findings from pressure regulating stations located in vaults.

**TABLE 9-5. SUMMARY OF ACTIVITY FACTORS FOR DISTRIBUTION METERING/PRESSURE REGULATING STATIONS**

Station Type	Inlet Pressure (psig)	Location (vault or above ground)	Stations per Mile	Average Activity Factor (stations)	Precision of Activity Factor (stations)
M&R	> 300	A-G	0.004	3,460	2,458
M&R	100-300	A-G	0.016	13,335	14,091
M&R	< 100	A-G	0.009	7,127	10,374
Reg.	> 300	A-G	0.005	3,995	2,702
Reg.	> 300	Vault	0.003	2,346	1,587
Reg.	100-300	A-G	0.015	12,273	7,461
Reg.	100-300	Vault	0.007	5,514	3,352
Reg.	40-100	A-G	0.043	36,328	23,375
Reg.	40-100	Vault	0.039	32,215	20,729
Reg.	< 40	*	0.018	15,377	9,922

\* The above-ground and in-vault categories were combined for the low pressure regulating station category.

Therefore, the number of outdoor residential customer meters, 40,049,300, was 78% of the total population of residential customer meters. The confidence interval around the mean activity factor,  $\pm 10\%$ , was estimated based on the variability in company supplied data.

The precision of the total commercial/industrial customer meters is assumed to be  $\pm 5\%$  of the estimated 4,608,000 meters.

#### **9.4 Distribution Mains and Services**

The total mileage of distribution mains and services was used as the activity factor to estimate the methane emissions from distribution third-party damage (e.g. dig-ins) and from blow and purge due to pipeline abandonment, installation, and repair. The total miles of main pipeline in the gas industry, 836,700 miles, was based on U.S. Department of Transportation (DOT) records.<sup>28</sup> The total miles of service, 460,809 miles, was reported by A.G.A.<sup>2</sup> Therefore, the total combined main and service mileage in the United States is 1,297,569 miles. The 90% confidence limit around the activity factor is assumed to be 5%, or 64,879 miles.

## 10.0 RESULTS

This section summarizes the major activity factors collected during this project. Some activity factors were already known on a national basis and were taken from published sources. Others were generated from company data or site visit data. Most equipment counts taken at site visits excluded equipment that was not in use. The following tables (10-1 and 10-2) summarize the activity factor data. Previous sections of this report explain the detailed basis for all of the activity factors.

**TABLE 10-1. WELL-DEFINED ACTIVITY FACTORS**

Segment	Activity Factor Name	Number
Total Industry	1992 Gross Gas Production (Tscf)	22.13
	1992 Marketed Gas Production (Tscf)	18.71
Production	No. of Gas Wells	276,000
	No. of Oil Wells	602,200
Processing	No. of Gas Plants	726
Transmission and Storage	Miles of Trans Pipeline	284,500
	No. of Storage Facilities	475
	No. of Storage Wells	18,000
Distribution	Miles of Service	460,800
	Miles of Mains	836,760
	Number of Residential Customer Meters	51,520,000



**TABLE 10-2. EXAMPLES OF DEVELOPED ACTIVITY FACTORS**

Segment	Activity Factor Name	Number
Total Industry	Recip Compressor Drivers	44,130
	Turbine Compressor Drivers	1,543
	Number of Glycol Dehydrators	39,620
Production	No. of Oil Wells Marketing Gas	209,000
	No. of Gas Wells Requiring Unloading	114,100
	Compressor Drivers	17,100 recipis
	Engine MMHp-hr	27,460
	Offshore Platforms	1,115
	Dehydrators (% of industry dehydrators)	37,820 (95%)
	Separators	167,200
	In-line Heaters	51,000
	Total Production Vessels	256,000
	Chemical Injection Pumps	16,970
	Pressure Relief Valves	529,400
	Gathering Pipeline Miles	340,200
	Well Workovers	9,329
	Pneumatic Devices	249,100
Processing	Compressor Drivers	4,092 recipis 726 turbines
	Annual Compressor Operation	27,780 MMhp-hr 32,910 MMhp-hr
	Dehydrators (% of industry dehydrators)	498 (1.3%)
	Acid Gas Recovery Units	371

Continued

TABLE 10-2. (Continued)

Segment	Activity Factor Name	Number
Transmission and Storage	Compressor Drivers	7,715 recip 817 turbines
	Annual Driver Operating Hours (average)	
	- Transmission Compressor Drivers	40,380 MMhp·hr
	- Storage Compressor Drivers	9,635 MMhp·hr
		4,922 MMhp·hr
		1,729 MMhp·hr
	Transmission Compressor Stations	1,700
	Dehydrators (% of industry dehydrators)	1,293 (3.3%)
Distribution	Pneumatic Devices	2,175
	M&R Stations	
	- Farm Taps	71,690
	- Interconnects	2,533
	- Direct Industrial Sales	938
	M&R stations	132,000
	Outdoor customer meters	40,049,000

## 11.0

## REFERENCES

1. Harrison, M.R., H.J. Williamson, and L.M. Campbell. *Methane Emissions from the Natural Gas Industry, Volume 3: General Methodology*, Final Report, GRI-94/0257.20 and EPA-600/R-96-080c. Gas Research Institute and U.S. Environmental Protection Agency, June 1996.
2. American Gas Association. *Gas Facts: 1993 Data*, Arlington, VA, 1994.
3. Williamson, H.J., M.B. Hall, and M.R. Harrison. *Methane Emissions from the Natural Gas Industry, Volume 4: Statistical Methodology*, Final Report, GRI-94/0257.21 and EPA-600/R-96-080d. Gas Research Institute and U.S. Environmental Protection Agency, June 1996.
4. Cochran, William G. *Sampling Techniques* Third Edition, John Wiley & Sons, New York, 1977.
5. U.S. Department of Energy/Energy Information Administration. *Natural Gas Annual, 1992*. DOE/EIA-0131 (89), Washington, DC, September 1993.
6. Gulf Coast Publishing Company, *World Oil, Annual Forecast/Review*, Vol. 214, No. 2, February 1993.
7. Texas Railroad Commission Information Services Dept., Paula Middleton, Personal Contact with K. Hummel, Radian Corporation, June 1994.
8. Alaska Oil & Gas Conservation Commission, Joan Miller, Phone Contact with Radian Corp., February 9, 1995.
9. *Oil & Gas Journal*. 1992 Worldwide Gas Processing Survey Database, 1993.
10. Texas Railroad Commission 1989, P-1, P-2 Tapes, Radian files.
11. Dwight's Energy Data, Inc., Mike Morgan, FAX contact with Radian Corp., December 29, 1995.
12. Offshore Data Services, David Sutherland, Phone Contact with Radian Corp., June 27, 1994.
13. Minerals Management Service. *User's Guide: MMS Outer Continental Shelf Activity Database (MOAD)*. OCS Study MMS 94-0018. U.S. Department of Interior, New Orleans, LA, June 1994.
14. Hummel, K.E., L.M. Campbell, and M.R. Harrison. *Methane Emissions from the Natural Gas Industry, Volume 8: Equipment Leaks*, Final Report, GRI-94/0257.25 and EPA-600/R-96-080h. Gas Research Institute and U.S. Environmental Protection Agency, June 1996.

15. U.S. Department of Energy/Energy Information Agency. *Natural Gas Production Responses to a Changing Market Environment, 1978-1988*. Table 6-3, Washington, D.C.
16. Pipeline Systems Incorporated. *Annual Methane Emission Estimate of the Natural Gas Systems in the United States, Phase 2*. Prepared for Radian Corporation, September 1990.
17. Shires, T.M. and M.R. Harrison. *Methane Emissions from the Natural Gas Industry, Volume 7: Blow and Purge Activities*, Final Report, GRI-94/0257.24 and EPA-600/R-96-080g. Gas Research Institute and U.S. Environmental Protection Agency, June 1996.
18. Wright Killen & Co. *Natural Gas Dehydration: Status and Trends*, Final Report, GRI-94/0099, Gas Research Institute, Chicago, IL, January 1994.
19. Stapper, C.J. *Methane Emissions from the Natural Gas Industry, Volume 11: Compressor Driver Exhaust*, Final Report, GRI-94/0257.28 and EPA-600/R-96-080k. Gas Research Institute and U.S. Environmental Protection Agency, June 1996.
20. Tannehill, C.C. and C. Galvin. *Business Characteristics of the Natural Gas Conditioning Industry*, Topical Report, GRI-93/0342, prepared by Purvin & Gertz, Inc, Gas Research Institute, May 1993.
21. Dalrymple, D.A., F.D. Skinner, and N.P. Meserole. *Investigation of U.S. Natural Gas Reserve Demographics and Gas Treatment Processes*, Topical Report, GRI-91/0019. Gas Research Institute, Chicago, IL, prepared by Radian Corporation, January 1991.
22. Federal Energy Regulatory Commission (FERC) Form No. 2: Annual Report of Major Natural Gas Companies, 1992 database.
23. American Gas Association. *Natural Gas Industry Environmental Organization Structure Survey*, Arlington, VA, 1990.
24. American Gas Association. *Gas Facts: 1991 Data*, Arlington, VA, 1992.
25. Shires, T.M. and M.R. Harrison. *Methane Emissions from the Natural Gas Industry, Volume 12: Pneumatic Devices*, Final Report, GRI-94/0257.29 and EPA-600/R-96-080l. Gas Research Institute and U.S. Environmental Protection Agency, June 1996.
26. Biederman, N. GRI TRANSDAT Database: Compressor Module. (prepared for Gas Research Institute) npb Associates with Tom Joyce and Associates, Chicago, IL, August 1991.

27. Texas Mid-Continent Oil and Gas Association (TMOGA) and Gas Processors Association (GPA), Dehydrator Survey Database, 1991.
28. U.S. Department of Transportation, Research and Special Programs Administration, 1991.
29. Southern Cross Corporation. "Comments on Docket PS-123 Notice 1, Leakage Surveys," *49 CFR Part 192*, Department of Transportation, Research and Special Programs Administration, Materials Transportation Bureau, Office of Pipeline Safety Regulations, December 19, 1991.



**APPENDIX A**

**Site Data**

TABLE A-1. PRODUCTION SITES (Summary)

Region*	Offshore	GC	CP	PM	AGL	Total US
Site	6	9	7	9	19	50 sites**
Companies	4	7	7	4	10	32 companies
Survey Type						
- Site Visit	1	9	3	9	2	24 site visits
- Phone Survey	5	0	4	0	5	14 phone surveys
- Star Site Visit**	0	0	0	0	12	12 star sites**

\*Region Key: GC = Gulf Coast; CP = Central Plains; PM = Pacific Mountain; AGL = Atlantic & Great Lakes.

\*\*This does not include all sites visited by Star or other fugitive emission contractors. Only the sites used for activity factor data collection are included.



TABLE A-2. PRODUCTION SITES (Offshore Data)

Region	GC-Off GC-Off GC-Off GC-Off PM-Off PM-Off						Total Offshore	Totals		Equipment/ Total Wells		Equipment/ Gas Wells		Equip./Mkt. Gas (1/MMcfd)		Equip.Prod. Gas (1/MMcfd)	
	1	2	3	4	5	6		GC	PM	GC	PM	GC	PM	GC	PM	GC	PM
Site	1	2	3	4	5	6	6 Sites 4 Companies										
Company	1	2	2	2	3	4											
Survey Type	V	P	P	P	P	P											
Gas Marketed (MMcfd)	0.365	12.5	440	4	17.5	160		456.9	177.5	1.66	5.22						
Gas Produced (MMcfd)	0.5	12.5	440	4	17.5	160		457.0	177.5	1.66	5.22						
Equipment Counts:																	
Gas Wells	2	0	80	0	0	12		82	12								
Oil Wells	3	150	0	40	22	0		193	22								
+ Oil wells that market gas	3	150	0	40	22	0		193	22								
Separators	4	0	24	0	0	1		28	1	0.10	0.03	0.34	0.08	0.06	0.01	0.06	0.01
In-line Heaters	0	0	0	0	2	0		0	2	0.00	0.06	0.00	0.00	0.00	0.01	0.00	0.01
Pneumatic Devices	3	0	32	0	0	0		35	0	0.13	0.00	0.43	0.00	0.08	0.00	0.08	0.00
Chem Inj Pumps	0	0	0	0	0	0				0.00	0.00	0.00	0.00	0.00	0.00	0.00	0.00
Compressors*	0	-	-	-	-	2		0	2	0.00	0.17	0.00	0.17	0.00	0.01	0.00	0.01
Dehydrators	1	0	8	1	2	3		10	5	0.04	0.15	0.11	0.25	0.02	0.03	0.02	0.03
+ Dehy with 3 ph Flash	1							1	0								
+ Dehy with Vent Control	0							0	0								
+ Dehy w/Kimray Pumps	1							0	0								
+ Dehy w/Stripping Gas	0							1	0								
Miles of Gathering Pipeline	-	-	-	-	-	-		0	0								
Fugitive Component count	Y	N	N	N	N	N											
Vented (Site Blow & Purge Data)	Y	Y	Y	Y	Y	Y											

- Notes: 1) Survey Type V = Site Visit (Radian); P = Phone Survey; S = Site Visit (Star).  
 2) \* = Gas lift compressors not included.  
 3) Y = Yes, N = No; "-" = No Data.  
 4) Region Key: GC = Gulf Coast; PM = Pacific Mountain.

TABLE A-3. PRODUCTION SITES (Gulf Coast Onshore Data)

Region	GC	GC	GC	GC	GC	GC	GC	GC	GC	Total GC					
Site	7	8	9	10	11	12	13	14	15						
Company	5	6	7	8	9	10	11	11	11						
Survey Type	V	V	V	V	V	V	V	V	V	9 Sites 7 Companies	Total	Equip./ Total Wells	Equip./ Gas Wells	Equip./ Mkt. Gas (1/MMcfd)	Equip./ Prod. Gas (1/MMcfd)
Gas Marketed (MMcfd)	23.1	25.5	124	54	28	250	1.9	7	130		643.4	0.54			
Gas Produced (MMcfd)	23.1	25.5	124	54	28	250	1.9	7	130		643.4	0.54			
Equipment Counts:															
Gas Wells	13	80	18	130	26	300	0	10	31						
Oil Wells	50	0	3	3	0	300	155	127	0	608					
+ Oil wells that market gas	50	0	3	3	0	300	155	68	0	638					
Separators	38	80	42	71	26	300	0	11	31	579					
In-line Heaters	2	56	17	23	26	0	0	12	0	599	0.50	0.99	0.93	0.93	
Pneumatic Devices	68	170	0	68	109	225	0	11	31	136	0.11	0.22	0.21	0.21	
Chem Inj Pumps	10	5	0	5	0	0	0	0	0	682	0.57	1.12	1.06	1.06	
Compressors*	12	4	2	37	0	0	0	15	10	20	0.02	0.03	0.03	0.03	
Dehydrators	7	2	2	12	26	2	0	4	26	80	0.07	0.13	0.12	0.12	
+ Dehy with 3 ph Flash	0	0	2	2	0	0	0	4	0	81	0.07	0.13	0.13	0.13	
+ Dehy with Vent Control	4	0	2	0	0	0	0	0	0	8					
+ Dehy w/Kimray Pumps	7	1	1	6	26	2	0	0	0	6					
+ Dehy w/Stripping Gas	0	0	0	0	0	0	0	0	26	69					
Miles of Gathering Pipeline	-	46.3	26.4	40	8	-	-	-	-	0					
Fugitive Component count	Y	Y	Y	Y	Y	Y	-	-	-						
Vented (Site Blow & Purge Data)	Y	Y	Y	Y	Y	Y	Y	Y	Y						

- Notes: 1) Survey Type V = Site Visit (Radian); P = Phone Survey; S = Site Visit (Star).  
 2) \* = Gas lift compressors not included.  
 3) Y = Yes, N = No; "-" = No Data.  
 4) Region Key: GC = Gulf Coast.

TABLE A-4. PRODUCTION SITES (Central Plains Data)

Region	CP	CP	CP	CP	CP	CP	CP	Total CP					
Site	16	17	18	19	20	21	22						
Company	12	13	14	15	16	17	18	7 Sites					
Survey Type	V	V	V	P	P	P	P	7 Companies	Total	Equip./ Total Wells	Equip./ Gas Wells	Equip./ Mkt. Gas (1/MMcfd)	Equip./ Prod. Gas (1/MMcfd)
Gas Marketed (MMcfd)	42.7	180	196	7	0.2	19.8	2		447.7	0.22			
Gas Produced (MMcfd)	42.7	180	196	7	0.2	20	2.1		448.0	0.22			
Equipment Counts:													
Gas Wells	138	321	1000	400	1	100	15		1975				
Oil Wells	55	11	0	0	0	0	4		70				
+Oil wells that market gas	55	11	0	0	0	0	4		70				
Separators	130	321	7	400	1	100	1		960	0.47	0.49	2.14	2.14
In-line Heaters	138	321	0	400	0	0	0		859	0.42	0.43	1.92	1.92
Pneumatic Devices	449	963	667			100	0		2179	1.33	1.38	4.95	4.94
Chem Inj Pumps	28	273	0	13	0	0	0		314	0.15	0.16	0.70	0.70
Compressors*	31	50	64				1		146	0.09	0.10	0.35	0.35
Dehydrators	16	220	0	400	0	25	1		662	0.32	0.34	1.48	1.48
+Dehy with 3 ph Flash	0	0	0			0	-		0				
+Dehy with Vent Control	0	0	0				-		0				
+Dehy w/Kimray Pumps	16	220	0				25		261				
+Dehy w/Stripping Gas	0	0	0				-		0				
Miles of Gathering Pipeline	5.2	-	600	-	-	-	-		0				
Fugitive Component count	Y	Y	Y	-	-	-	-						
Vented (Site Blow & Purge Data)	Y	Y	Y										

- Notes: 1) Survey Type V = Site Visit (Radian); P = Phone Survey; S = Site Visit (Star).  
 2) \* = Gas lift compressors not included.  
 3) Y = Yes, N = No; "-" = No Data.  
 4) Region Key: CP = Central Plains.

TABLE A-5. PRODUCTION SITES (Pacific/Mountain Onshore Data)

Region	PM	PM	PM	PM	PM	PM	PM	PM	PM	Total PM					
Site	23	24	25	26	27	28	29	30	31						
Company	19	20	21	21	21	21	22	21	21	9 Sites					
Survey Type	V	V	V	V	V	V	V	V	V	4 Companies	Total	Equip./ Total Wells	Equip./ Gas Wells	Equip./ Mkt. Gas (1/MMcfd)	Equip./ Prod. Gas (1/MMcfd)
Gas Marketed (MMcfd)	4	104	0.138	0.03	0.02	0.035	0.8	0.1	11.082		120.2	0.12			
Gas Produced (MMcfd)	4	307	0.138	0.03	0.02	0.035	0.8	0.1	11.082		323.2	0.32			
Equipment Counts:															
Gas Wells	53	0	0	0	0	0	0	0	0		53				
Oil Wells	0	913	18	8	10	15	20	7	728		1719				
+ Oil wells that market gas	0	137	18	8	10	15	20	7	728		943				
Separators	45	0	0	0	0	0	0	0	0		45	0.17	0.85	0.41	0.14
In-line Heaters	53	5	3	2	0	0	0	0	0		63	0.24	1.00	0.58	0.20
Pneumatic Devices	80	0	0	0	0	0	0	0	0		80	0.08	1.51	0.67	0.25
Chem Inj Pumps	36	0	0	0	0	0	0	0	0		36	0.04	0.68	0.30	0.11
Compressors*	17	19	0	0	0	0	1	1	0		38	0.14	0.32	0.35	0.12
Dehydrators	5	0	0	0	0	0	1	0	0		6	0.02	0.09	0.05	0.02
+ Dehy with 3 ph Flash	0	0					0				0				
+ Dehy with Vent Control	0	0					0				0				
+ Dehy w/Kimray Pumps	5	0					1				6				
+ Dehy w/Stripping Gas	0	0					0				0				
Miles of Gathering Pipeline	-	-	-	-	-	-	-	-	-		0				
Fugitive Component count	Y	Y	N	N	N	N	N	N	N						
Vented (Site Blow & Purge Data)	Y	Y	N	N	N	N	N	N	N						

- Notes: 1) Survey Type V = Site Visit (Radian); P = Phone Survey; S = Site Visit (Star).  
 2) \* = Gas lift compressors not included.  
 3) Y = Yes, N = No; "-" = No Data.  
 4) Region Key: PM = Pacific Mountain.

TABLE A-6. PRODUCTION SITES (Atlantic & Great Lakes Data)

Region	AGL	AGL	AGL	AGL	AGL	AGL	AGL	AGL	AGL
Site	32	33	34	35	36	37	38	39	40
Company	23	24	25	26	27	28	29	30	30
Survey Type	V	P	P	V	P	P	F	S	S
Gas Marketed (MMcfd)	24	6	15	17	12	16	81	0.18	0.18
Gas Throughput (MMcfd)	24	6	15	17	12	20	81	0.19	0.19
Oil Throughput (1000 B/D)	0								
Equipment Counts:									
Gas Wells	800	250	1000	520	450	1582	4034	11	11
Oil Wells	0	0	0	0	163	418	0	0	0
+Oil wells that market gas	0	0	0		163	418	0	0	0
Separators	151	250	500	520	450	1582	3227	-	2
In-line Heaters	0							-	0
Pneumatic Devices	76	0	10	520	450	1582	1294	-	-
Chem Inj Pumps	0	0	0	12	0	8	25	Y	0
Compressors*	1	-	-	-	-	-	-	-	0
Dehydrators	0	2	1	30	0	0	41	-	0
+Dehy with 3 ph Flash	0	0	0	0			5		-
+Dehy with Vent Control	0			3			2		-
+Dehy w/Kimray Pumps	0	2	1	30			8	0	-
+Dehy w/Stripping Gas	0						21	0	-
Miles of Gathering Pipeline	-	-	-	-	-	-	-	-	-
Fugitive Component count	Y	N	N	N	Y	Y	Y	-	Y
Vented (Site Blow & Purge Data)	-	-	Y	Y	-	-	-	-	-

- Notes: 1) Survey Type V = Site Visit (Radian); P = Phone Survey; S = Site Visit (Star).  
 2) \* = Gas lift compressors not included.  
 3) Y = Yes, N = No; "-" = No Data.  
 4) Region Key: AGL = Atlantic & Great Lakes.

(Continued)

TABLE A-6. (Continued)

Region	AGL	AGL	AGL	AGL	AGL	AGL	AGL	AGL	AGL	AGL	Total AGL					
Site	41	42	43	44	45	46	47	48	49	50						
Company	30	31	31	31	31	31	31	31	31	31						
Survey Type	S	S	S	S	S	S	S	S	S	S	19 Sites 10 Companies	Total (Sites 32-50)	Equip./ Total Wells	Equip./ Gas Wells	Equip./ Mkt. Gas (1/MMcfd)	Equip./ Prod. Gas (1/MMcfd)
Gas Marketed (MMcfd)	0.17	0.39	0.37	0.37	0.18	0.23	0.30	0.35	0.13	0.35		173.6				
Gas Throughput (MMcfd)	0.17	0.39	0.37	0.37	0.19	0.23	0.30	0.35	0.13	0.35		178.0				
Oil Throughput (1000 B/D)																
Equipment Counts:																
Gas Wells	10	23	22	22	11	14	18	21	8	21		8828				
Oil Wells	0	0	0	0	0	0	0	0	0	0		581				
+ Oil wells that market gas	0	0	0	0	0	0	0	0	0	0		581				
Separators	0	10	7	8	5	3	15	17	5	7		6766	0.72	0.77	38.97	38.01
In-line Heaters	0	0	0	0	1	1	0	0	0	0		2	0.00	0.00	0.07	0.07
Pneumatic Devices	-	-	-	-	-	-	-	-	-	-		3932	0.43	0.46	23.07	22.50
Chem Inj Pumps	0	0	0	0	0	0	0	0	0	0		45	0.00	0.01	0.26	0.25
Compressors*	0	0	0	0	0	0	0	0	0	0		1	0.00	0.00	0.04	0.04
Dehydrators	-	-	-	-	-	-	-	-	-	-		74	0.01	0.01	0.43	0.42
+ Dehy with 3 ph Flash												5				
+ Dehy with Vent Control												5				
+ Dehy w/Kimray Pumps												41				
+ Dehy w/Stripping Gas												21				
Miles of Gathering Pipeline	-	-	-	-	-	-	-	-	-	-						
Fugitive Component count	Y	Y	Y	Y	Y	Y	Y	Y	Y	Y						
Vented (Site Blow & Purge Data)	-	-	-	-	-	-	-	-	-	-						

- Notes: 1) Survey Type V = Site Visit (Radian); P = Phone Survey; S = Site Visit (Star).  
 2) \* = Gas lift compressors not included.  
 3) Y = Yes, N = No; "-" = No Data.  
 4) Region Key: AGL = Atlantic & Great Lakes.

TABLE A-7. GAS PROCESSING PLANTS

Site	1	2	3	4	5	6	7	8	9	10	11	Total 11 Sites
Companies	1	1	2	3	3	4	5	5	5	6	7	7 companies
Type	Cryo	Cryo	Cryo	Lean Oil Abs., Cryo	Cryo	Cryo	Lean Oil Abs.	Refrig.	Refrig.	Refrig./ Lean Oil Abs.		
Capacity (MMscfd)	100	75	70	850	900		40	130	130	140		
Current Throughput (MMscfd)	49	60	56	350	750	140	40	130	130	70		
Compr. Units	7	4	6**	9	1	0***	4.4**	1.4**	1.4**	20	19	72
- Turb. Eng	0	0	0	2	1	1	0	0	0	5	2	10
- Recip. Eng	7	4	6**	7	0	0	4.4**	1.4**	1.4**	15	17	62
- Total HP	11000	3700	6740**	43300	27000	20000	5925**	6267**	6267**	59600		189799
Dehys	0	1	2	3	0	0	1	1	1	1		10
Dehys w/Kimray Pumps		1	0	0			0	0	0			1
Pneum Ongas	2	3	0	25	25	17	0	0	0	0		72
Vented Data												
- Site	Y	Y	Y	Y	-	Y				Y	Y	
- Company	-	-	-	-	-	Y	-	-	-	-	-	
Fugitive CC	639	357	799	1458	-	-	6831	5902	5902	-	Y*	

\* Count only of compressor blowdown open-ended lines, site open-ended lines, and compressor pressure relief valves.

\*\* Gas lift compressors not counted in the totals for this site with gas lift for oil recovery.

\*\*\* 1 turbine drives 2 propane compressors. No natural gas compressors.

"Y" = Yes

TABLE A-8. TRANSMISSION COMPRESSOR STATIONS

Site Number	1	2	3	4	5	6	7	8	9	10	11
Company Number	1	1	1	2	2	2	3	3	4	4	4
Compr. Units	13	2	2	6	7	13	12	13	2	10	6
- Turb. Eng	0	2	2	0	0	0	2	1	2****	3	2
- Recip. Eng	13	0	0	6	7	13	10	12	0	7	4***
- Total HP	32650	6900	6900	16900	10400	24800	14560	17570	40000	-	-
Dehydrators	0	0	0	0	1	-	0	0	6	0	0
- Flash Tanks					1				6		
- Kimray Pumps					0				6		
- Stripping Gas					0				0		
- Vapor Recovery					0				0		
- Vent Flash Gas											
Pneum	48	12	-	8	-	20	75	40	68	83	50
Wells	Not Applicable										
Fugitive CC	741**	223**	165**	-	-	-	3038	3949	1730	1467	956
Site B/D Practices	Y	Y	-	Y	Y	-	-	-	Y	Y	Y
Co. B/D No's	-	-	-	Y	Y	Y	-	-	-	-	-

(Continued)



TABLE A-8. (Continued)

Site Number	12	13	14	15	16	17	18	19	20	21	21 Sites
Company Number	5	6	6	7	8	8	9	9	10	10	10 Co's
Compr. Units	18	2	2	26	5	3	7	13	7	2	171
- Turb. Eng	0	2	2	1	1	0	0	3	0	2	25
- Recip. Eng	18	0	0	25	4	3	6	10	7	0	145
- Total HP	21000	-	-	-	-	-	-	-	-	-	191,680
Dehydrators	1	0	0	0	0	0	0	0	-	-	8
- Flash Tanks	1										
- Kimray Pumps	0										
- Stripping Gas	0										
- Vapor Recovery	0										
- Vent Flash Gas											
Pneum	3						38		-	0	
Wells	Not Applicable										
Fugitive CC	1123	134	284	1706	345	12	508	792	-	-	
Site B.D Practices	Y	-	-	Y	-	-	Y	-	Y	Y	
Co. B/D No's	-	-	-	-	-	-	-	-	-	-	

A-11

Fug cc does not include connections or tubing

\* = Elec driven compressors

\*\* = Not including hydraulic valves

\*\*\* = Recip Engine w/Centrifugal Compressor

\*\*\*\* = Does not include third turbine that was permanently out-of-service

"-" means no data available, "Y" = Yes

TABLE A-9. STORAGE COMPRESSOR STATIONS

Site	1	2	3	4	5	6	7	8	Total 8 Sites
Companies	1	2	3	4	5	6	7	8	7 Co's
Type	UG	UG	UG	UG	LNG	UG	UG	UG	
Compr. Units	3	2	2	4	5*	18	9	9	52
- Turb. Eng	0	0	0	2*	0	4	0	0	6
- Recip. Eng	3	2	2	2	0	14	9	9	41
- Total HP	6250	2200	9400	7000	10300*	48510	9000	11600	104260
Dehydrators	4	1	1	8	0	1	-	-	
- Flash Tanks			1	8		1			
- Kimray Pumps			0	0		0			
- Stripping Gas			0	0		1			
- Vapor Recovery				0		0			
- Vent Flash Gas			1	0		0			
Pneumatics	18	-	68	127	4	-	-	-	217
Wells	?	50	22	83	0	64	-	-	219
Fugitive CC	1750	-	1113	8326	1679	887	-	-	13700
Vented Data:									
- Site	-	Y	Y	Y	Y	Y	Y	Y	
- Company	-	Y	-	Y	-	-	-	-	

Fug cc does not include connections or tubing

\* = Elec driven compressors

\*\* = Not including hydraulic valves

\*\*\* = Recip Engine w/Centrifugal Compressor

"-" means no data available, "Y" = Yes

UG = Underground Storage Station

LNG = Above ground, Liquefied Natural Gas Station

**APPENDIX B**

**Methods for Estimating Activity Factors**

## B.1 RATIO (SITE-WEIGHTED) METHOD FOR ESTIMATION OF AN ACTIVITY FACTOR

As discussed in Section 3.4, the ratio (site-weighted) method has been used to estimate activity factors on the basis of well counts or production. In that section, a numerical example is given which illustrates the ratio method for that purpose. This appendix provides a further description of the ratio method, including calculation of a confidence interval for an estimate obtained by this method. In Section B.1.1, estimation using the ratio method is described. In Section B.1.2, methods for computing a confidence interval for the estimate produced by the ratio method are discussed. Further discussion of the ratio method and methods for computing confidence intervals is provided by Cochran<sup>4</sup> (1977).

### B.1.1 Estimation Using the Ratio Method

Suppose

- $y_i$  = device count (e.g., number of separators) at the  $i^{\text{th}}$  sampled site;
- $x_i$  = value of the extrapolation parameter (number of wells or gas production) at the  $i^{\text{th}}$  site;
- $n$  = number of sites sampled;
- $X$  = the regional value of the extrapolation parameter, e.g. the total number of wells in the region; and
- $N$  = the total number of sites in the region.

For the purposes of illustration, this section discusses the estimation of the regional number of separators by using the well method. Then, by the ratio method, the following is the estimate of the number of separators per well:

$$\hat{R} = \frac{\bar{y}}{\bar{x}}$$

or

$$\hat{R} = \frac{\sum_{i=1}^n y_i}{\sum_{i=1}^n x_i}$$

This estimated number of separators per well and the regional number of wells is then used to estimate the number of separators in the region:

$$\hat{Y}_R = \hat{R} X$$

### **B.1.2 Confidence Interval for Estimate Produced by the Ratio Method**

Cochran presents two approaches for estimation on the basis of confidence intervals. One method for calculation of the confidence interval is based on the assumption that the ratio estimate,  $\hat{R}$ , is approximately normally distributed. In many applications, the normality assumption is satisfied only if the sample size (the number of sites visited in our application) is sufficiently large (at least 30) and the relative uncertainties (coefficients of variation) in both the average number of separators per site and the average number of wells per site are both sufficiently small (less than 10%). The suggested rules of thumb are given by Cochran. If the ratio is normally distributed, its confidence interval will be symmetric.

If the ratio itself is not approximately normally distributed, but the numerator and denominator are both normally distributed, the ratio will tend to have an asymmetric confidence interval in which the upper confidence limit is more separated from the mean than is the lower confidence limit (see Figure B-1). A second method handles this case. As is discussed below, the cause of the asymmetry in some applications is a fundamental consideration in the selection of a method.

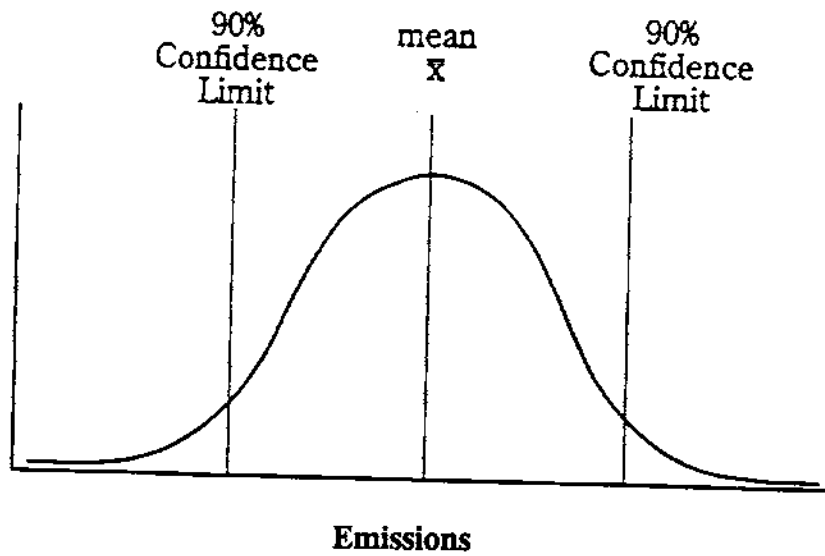

a) Normal Distribution

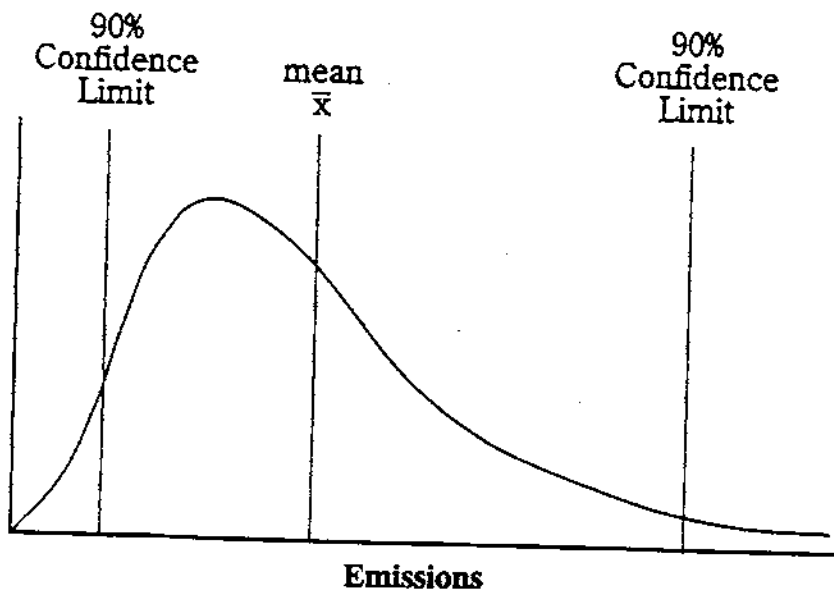

b) Lognormal Distribution

Figure B-1. Conceptual Comparison of Normal and Lognormal Distributions

For the ratio  $a/b$ , "a" and "b" are both subject to random variability but both are non-negative. Given that "b" is subject to random variability and bounded below only by zero, a value very close to zero could occur. The ratio has no upper bound as "b" approaches zero; thus the error in the ratio is unbounded above. But the ratio has an absolute lower bound of zero. The possibility of values extremely larger than the true value, without a corresponding possibility of values extremely lower than the true value, tends to cause the uncertainty in the ratio to be asymmetric.

The method based on the assumption that the ratio is approximately normally distributed will be called method 1. The method that produces asymmetric confidence intervals will be called method 2. Radian has performed calculations to compare these two methods. Tests revealed that method 2 is capable of producing an upper confidence level that is unreasonably large from an engineering point of view (see the discussion below pertaining to separators for the Central Plains Region). The confidence limits produced by method 1 under these circumstances are much more reasonable from this perspective.

Both engineering judgement and further statistical calculations have indicated that method 2 is preferable for this application. First, the asymmetric confidence interval is based on the general mathematical situation described above, in which the denominator can become arbitrarily close to zero. But in our application, the denominator is the sum of the production levels or of the numbers of wells for the sites visited in a region. From a practical perspective, it is not reasonable to expect that either of these sums can become arbitrarily close to zero, causing an extremely large ratio of separators per well or separators per unit of production.

The number of wells at a site of interest must be at least one. Thus, the sum of the numbers of wells has a lower bound equal to the number of sites visited. The production does not have a definable lower bound of this nature. The argument above still applies; however, it is not reasonable to expect an arbitrarily small production rate at all visited sites in a region, allowing an unbounded ratio of devices per unit of production on the basis of the data for all sites.

The argument above pertains to the possibility of an arbitrarily small denominator, which could cause extreme skewness; Figure B-2 depicts a hypothetical distribution that is skewed, or asymmetric. The relationship between the number of devices and the number of wells or amount of production is also relevant. Theoretically, positive skewness in a ratio could result from positive skewness in the numerator; this would be a special concern if the numerator could increase without bound, independently of the value of the denominator. In this application, however, it is not reasonable to expect that the number of separators attached to a given well is unbounded; similar comments apply for other device types. Further, it is not reasonable to expect that the number of separators at the visited sites in a region is independent of the total production at those sites and can become arbitrarily large, independently of the production level.

The intuitive arguments above indicate that certain mathematical causes of marked asymmetry do not exist in this application. However, these arguments do not prove that asymmetry cannot exist at all. A further investigation was performed on the basis of statistical calculations. For each of a selected set of regions and device types, the number of devices was divided by the extrapolation parameter (wells or production) for each site. This produced a ratio for each site visited for a given region and device type. In most cases, the number of sites is too small to allow a detailed characterization of the distribution. For separators for the Atlantic/Great Lakes region, however, there were 19 sites. The distribution of separators per well is displayed for this case in Figure B-3. The histogram is somewhat ragged, because of the sample size; even 19 is a small sample size to characterize a distribution. Nevertheless, there is no evidence of positive skewness. Despite the raggedness of this empirical distribution, a hypothesis test indicated that this distribution does not differ to a significant extent from a normal distribution.

Figure B-4 presents the histogram for the ratio of separators per unit of production for the same region. In this case, there is evidence of asymmetry in the distribution of the site-by-site ratios, and the hypothesis test indicated that this distribution differed significantly from a normal distribution. The primary reason for the visual



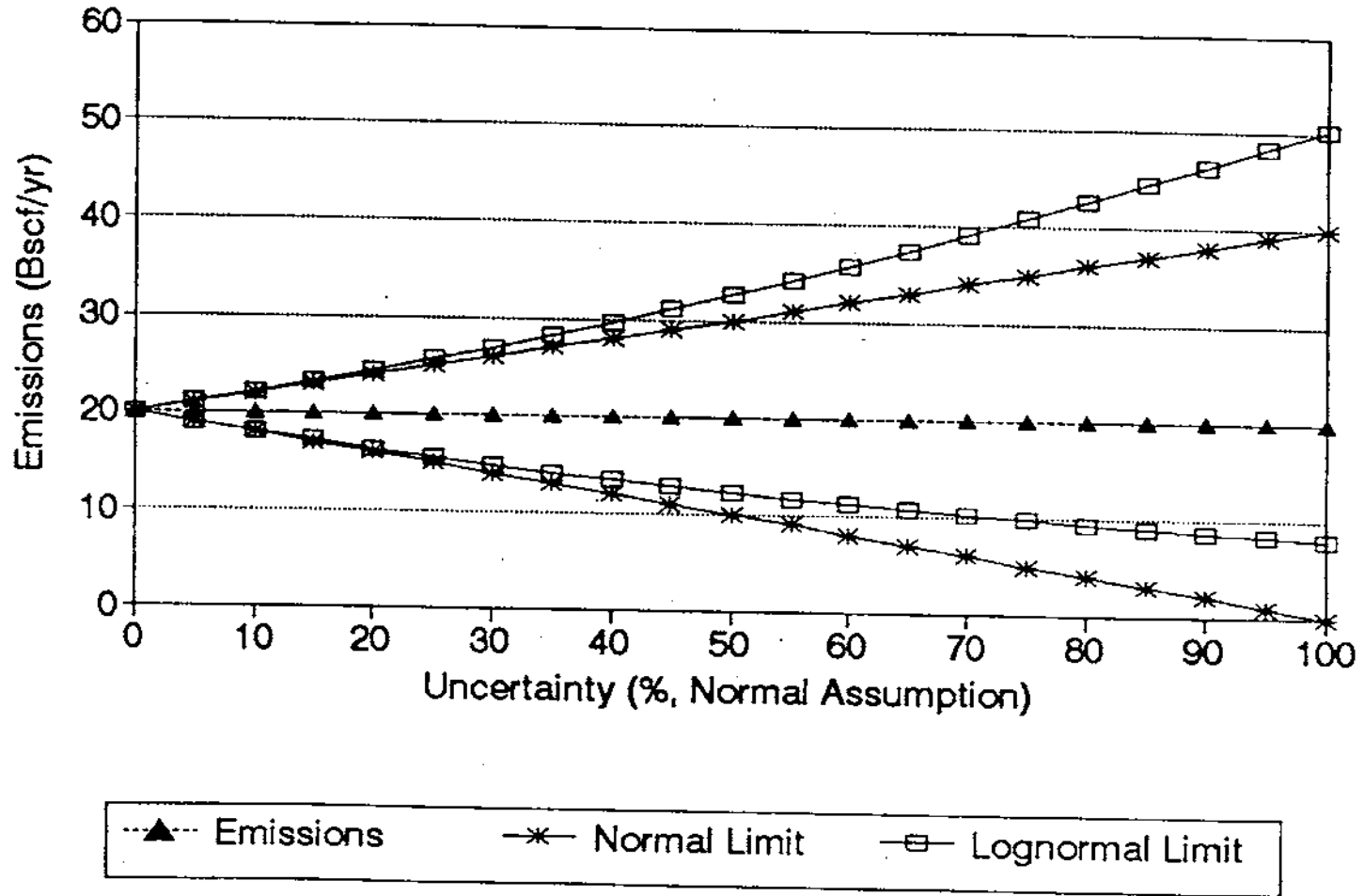
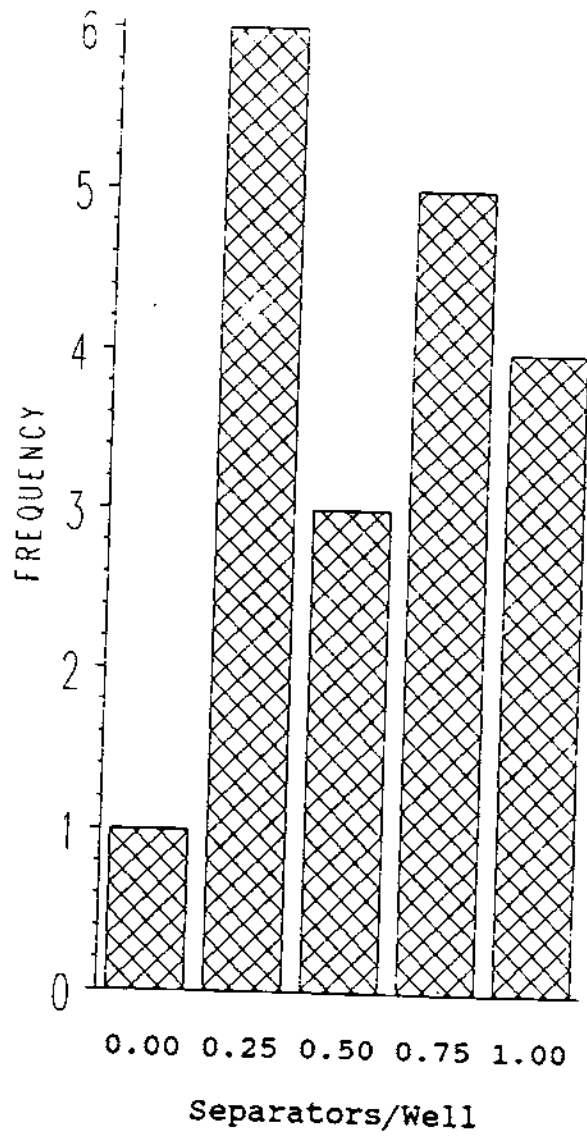
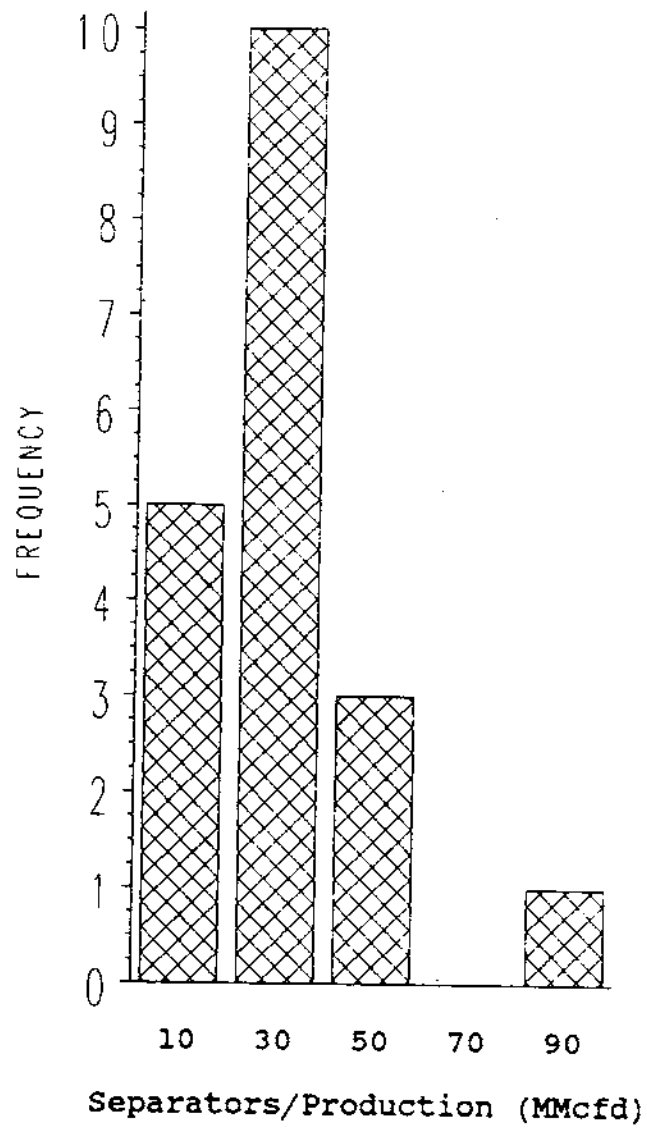

Figure B-2. Comparison of 90% Confidence Limits (Normal and Lognormal Assumptions)



**Figure B-3. Distribution of Separators per Well**



**Figure B-4. Ratio of Separators per Unit of Production**

impression of asymmetry is a single site with a ratio of 99.9 separators per MMcfd of production. Asymmetry in the site ratios, however, does not necessarily imply that the error in the ratio for the region is asymmetrically distributed. For the site with the large ratio, there are 1,582 separators and 16 MMcfd of production. Another site with a more moderate ratio has a much larger impact on the ratio for the region. This site has 3,227 separators and 81 MMcfd of production, so the ratio is 39.8 separators per MMcfd.

The site values of the number of separators per well for the Central Plains region revealed evidence of negative skewness. That is, instead of a long tail to the right, as in Figure B-4, there was some evidence of a long tail to the left. Since there were only seven sites, a histogram of this data set would not be meaningful and is not shown. In this case, method 2 produced an upper confidence limit for the ratio of separators per well that was unreasonably large in this case from an engineering or a statistical point of view. This upper limit was several times the largest site ratio of separators per well for the Central Plains region and exceeded almost all the separator-per-well site values for several regions. In this example, method 1 produced results that were considered to be much more reasonable. While negative skewness was the exception, this example provides another illustration of why method 1 was preferred over method 2.

Moreover, asymmetric uncertainties of individual parameters exist for other reasons. Confidence intervals with greater than 100% uncertainty exist for activity factors, emission factors, or emission rates for some source categories. One possible explanation is that the error in the estimated parameter is not normally distributed. The ultimate objective of the study, however, is to estimate the national emission rate. The sum of the emission rates for 82 source categories will tend toward normality, even if some of the individual values summed are nonnormal. Thus, even if some category parameters were not normal, this would not necessarily invalidate the confidence interval for the national emission rate. Moreover, an assessment has been made of the effect of a lognormal error in the industry emission rate. The upper confidence limits based on the normal and lognormal assumptions differ by a small amount, and the target precision is met on the basis of either assumption (Section A.4).

Based on a finite sample of size  $n$  (i.e.,  $n$  sampled sites), the following is an approximation of the variance of the error in  $\hat{Y}_R$ :

$$v(\hat{Y}_R) = \frac{N^2(1-f)}{n(n-1)} \sum_{i=1}^n (y_i - \hat{R}x_i)^2$$

The quantity  $N$ , the total number of sites in the region, is not known and, therefore, must be estimated. The total number of separators,  $X$ , in the region is known. The quantity  $X$  divided by the average number of separators per site is an approximation of the number of sites in the region. This method of estimating  $N$  was suggested to Radian by Jonathan Cohen of ICF Kaiser in a private communication.

Thus,  $N$  is an estimate rather than a known constant. The value  $N$  is used only in quantifying the uncertainty of  $\hat{Y}_R$ , however, and not in estimating  $\hat{Y}_R$ . The quantity  $f$  is the sampling fraction,  $n/N$ .

The equation given by Cochran for a symmetric confidence interval for  $\hat{Y}_R$  is as follows:

$$\hat{Y}_R \pm z \sqrt{v(\hat{Y}_R)}$$

where  $z$  is a tabulated value of the standard normal distribution selected according to the confidence level; for a 90% confidence interval, the  $z$  value is 1.645. The  $z$  value is appropriate when the quantity estimated ( $\hat{Y}_R$ ) has an uncertainty, but the uncertainty of the variance [ $v(\hat{Y}_R)$ ] can be neglected. The use of the  $z$  statistic is generally accepted if the sample size is greater than 30.

According to Cochran's rules of thumb, the sample size would be at least 30 when this expression for the confidence interval was used. In our case, however, the decision that the symmetric confidence interval was preferable to the asymmetric confidence interval even if the sample size was less than 30 was based on engineering

considerations and data analysis, as is discussed above. To account for the uncertainty in the variance as well as in the estimate, we have replaced  $z$  in the expression above by the appropriate  $t$  value. Even though the  $t$ -distribution does not apply exactly in this context, replacing  $z$  by  $t$  provides a degree of conservatism; that is, somewhat wider confidence intervals are produced, which tends to account for the uncertainty in  $v(\hat{Y}_R)$ . The resulting confidence interval is as follows:

$$\hat{Y}_R \pm t \sqrt{v(\hat{Y}_R)}$$

## B.2 COMBINATION OF ESTIMATES OF AN ACTIVITY FACTOR

The methods discussed in the preceding section were used to estimate the activity factor and its uncertainty on the basis of both well counts and production. The arithmetic average of the two estimates was computed to obtain the final estimate.

The two estimates are based on different extrapolation factors (values of the  $x_i$ ) but common device counts (values of the  $y_i$ ). The device counts vary by site and are subject to sampling error. Thus, this source of sampling error was common to the two estimates of the activity factor. It has been discussed elsewhere that separate measured quantities (e.g., emission rates from different types of devices) may have correlated sampling errors. The evidence here for correlation is much stronger, however, since common data are used in the two estimates. Thus, steps were taken to account explicitly for the correlation. To address this issue, we introduce the following notation:

- $x_{w,i}$  = number of wells at the  $i^{\text{th}}$  site;
- $x_{p,i}$  = production at this site;
- $\hat{R}_w$  = estimate of  $R$  on the basis of wells;

$\hat{R}_p$  = estimate of R on the basis of production;

$\hat{Y}_{R,w}$  = estimate of  $\hat{Y}_R$  on the basis of wells; and

$\hat{Y}_{R,p}$  = estimate of  $\hat{Y}_R$  on the basis of production.

By substituting  $x_{w,i}$  for  $x_i$  in the appropriate equations in the preceding section, for example, one obtains the estimate of the number of devices in the region on the basis of wells and the confidence interval for this estimate. The following is a sample estimate of the covariance between the errors in the two estimates:

$$\text{cov}(\hat{Y}_{R,w}, \hat{Y}_{R,p}) = \frac{N^2(1-f)}{n(n-1)} \sum_{i=1}^n (y_i - \hat{R}_w x_{w,i})(y_i - \hat{R}_p x_{p,i})$$

This expression satisfies important required properties of the covariance, such as the symmetry property:

$$\text{cov}(\hat{Y}_{R,w}, \hat{Y}_{R,p}) = \text{cov}(\hat{Y}_{R,p}, \hat{Y}_{R,w})$$

Additionally, the covariance between a quantity and itself equals the variance of that quantity. This can be confirmed simply by replacing all "w" subscripts with a "p" subscript, to obtain the variance of  $\hat{Y}_p$ .

In a textbook application of the ratio method, the quantity N would be known. As discussed earlier, N must be estimated in this application. In estimating the covariance above, the average of the two estimates of N was used, both where N appears explicitly in the covariance equation and in calculating f.

Now, the expression for the final estimate of the activity based on the arithmetic average approach is as follows:

The variance of this expression is:

$$\hat{Y}_{R,avg} = \frac{\hat{Y}_{R,w} + \hat{Y}_{R,p}}{2}$$

$$var(\hat{Y}_{R,avg}) = \frac{var(\hat{Y}_{R,p}) + 2cov(\hat{Y}_{R,p}, \hat{Y}_{R,w}) + var(\hat{Y}_{R,w})}{4}$$

The confidence interval for the final estimate is as follows:

$$\hat{Y}_{R,avg} \pm t \sqrt{var(\hat{Y}_{R,avg})}$$

In some instances, the number of sites for which data existed for both wells and production did not coincide exactly. In these cases, the covariance was computed on the basis of the sites for which common data did exist. This provided a somewhat conservative (large) estimate of the covariance. This calculation of the covariance represents the case in which the sites in common for the two extrapolation parameters are the only sites. But the fact that sites exist with data for wells but not production (or vice versa) introduces an element of independence between the estimates of  $\hat{Y}_R$  based on the two extrapolation parameters. The somewhat conservative covariance estimate produces a somewhat conservative confidence interval for the final estimate of  $\hat{Y}_R$ .

To account for this case, the correlation between the errors in the two estimates was computed as follows:

$$r = \frac{cov(\hat{Y}_{R,w}, \hat{Y}_{R,p})}{\sqrt{var(\hat{Y}_{R,w})var(\hat{Y}_{R,p})}}$$

Then the half-width of the confidence interval for  $\hat{Y}_R$  was computed as follows:

where  $t_p$  and  $t_w$  are the t-values appropriate for the sample sizes for the two extrapolation parameters. The expression involving the correlation coefficient was written in the manner



$$\frac{1}{2} \sqrt{t_p^2 \text{Var}(\hat{Y}_{R,p}) + 2t_p [t_p \sqrt{\text{var}(\hat{Y}_{R,p})}] [t_w \sqrt{\text{var}(\hat{Y}_{R,w})}] + t_w^2 \text{Var}(\hat{Y}_{R,w})}$$

shown to emphasize that this is approximately an error propagation using half-widths of confidence intervals. Each t-value is grouped with its respective standard error (the square root of an error variance is a standard error). The expression above can be simplified algebraically to the following:

$$\frac{1}{2} \sqrt{t_p^2 \text{var}(\hat{Y}_{R,p}) + 2t_p t_w \text{cov}(\hat{Y}_{R,w}, \hat{Y}_{R,p}) + t_w^2 \text{Var}(\hat{Y}_{R,w})}$$

This expression involving different sample sizes for the two estimates reduces to the simpler expression for the half-width of the confidence interval given earlier if the sites for which data exist for wells and production are the same.



**APPENDIX C**

**Conversion Table**

## Unit Conversion Table

### English to Metric Conversions

1 scf methane	=	19.23 g methane
1 Bscf methane	=	0.01923 Tg methane
1 Bscf methane	=	19,230 metric tonnes methane
1 Bscf	=	28.32 million standard cubic meters
1 short ton (ton)	=	907.2 kg
1 lb	=	0.4536 kg
1 ft <sup>3</sup>	=	0.02832 m <sup>3</sup>
1 ft <sup>3</sup>	=	28.32 liters
1 gallon	=	3.785 liters
1 barrel (bbl)	=	158.97 liters
1 inch	=	2.540 cm
1 ft	=	0.3048 m
1 mile	=	1.609 km
1 hp	=	0.7457 kW
1 hp-hr	=	0.7457 kW-hr
1 Btu	=	1055 joules
1 MMBtu	=	293 kW-hr
1 lb/MMBtu	=	430 g/GJ
T (°F)	=	1.8 T (°C) + 32
1 psi	=	51.71 mm Hg

### Global Warming Conversions

Calculating carbon equivalents of any gas:

$$\text{MMTCE} = (\text{MMT of gas}) \times \left( \frac{\text{MW, carbon}}{\text{MW, gas}} \right) \times (\text{GWP})$$

Calculating CO<sub>2</sub> equivalents for methane:

$$\text{MMT of CO}_2 \text{ equiv.} = (\text{MMT CH}_4) \times \left( \frac{\text{MW, CO}_2}{\text{MW, CH}_4} \right) \times (\text{GWP})$$

where MW (molecular weight) of CO<sub>2</sub> = 44, MW carbon = 12, and MW CH<sub>4</sub> = 16.

### Notes

scf	=	Standard cubic feet. Standard conditions are at 14.73 psia and 60°F.
Bscf	=	Billion standard cubic feet (10 <sup>9</sup> scf).
MMscf	=	Million standard cubic feet.
Mscf	=	Thousand standard cubic feet.
Tg	=	Teragram (10 <sup>12</sup> g).
Giga (G)	=	Same as billion (10 <sup>9</sup> ).
Metric tonnes	=	1000 kg.
psig	=	Gauge pressure.
psia	=	Absolute pressure (note psia = psig + atmospheric pressure).
GWP	=	Global Warming Potential of a particular greenhouse gas for a given time period.
MMT	=	Million metric tonnes of a gas.
MMTCE	=	Million metric tonnes, carbon equivalent.
MMT of CO <sub>2</sub> eq.	=	Million metric tonnes, carbon dioxide equivalent.

**TECHNICAL REPORT DATA**

*(Please read Instructions on the reverse before completing)*

1. REPORT NO. EPA-600/R-96-080e		2.	3. RECIPIENT'S ACCESSION NO.	
4. TITLE AND SUBTITLE Methane Emissions from the Natural Gas Industry, Volumes 1-15 (Volume 5: Activity Factors)		5. REPORT DATE June 1996		6. PERFORMING ORGANIZATION CODE
7. AUTHOR(S) L. Campbell, M. Campbell, M. Cowgill, D. Eperson, M. Hall, M. Harrison, K. Hummel, D. Myers, T. Shires, B. Stapper, C. Stapper, J. Wessels, and *		8. PERFORMING ORGANIZATION REPORT NO. DCN 96-263-081-17		
9. PERFORMING ORGANIZATION NAME AND ADDRESS Radian International LLC P. O. Box 201088 Austin, Texas 78720-1088		10. PROGRAM ELEMENT NO.		11. CONTRACT/GRANT NO. 5091-251-2171 (GRI) 68-DI-0031 (EPA)
12. SPONSORING AGENCY NAME AND ADDRESS EPA, Office of Research and Development Air Pollution Prevention and Control Division Research Triangle Park, NC 27711		13. TYPE OF REPORT AND PERIOD COVERED Final; 3/91-4/96		14. SPONSORING AGENCY CODE EPA/600/13
15. SUPPLEMENTARY NOTES EPA project officer is D. A. Kirchgessner, MD-63, 919/541-4021. Cosponsor GRI project officer is R. A. Lott, Gas Research Institute, 8600 West Bryn Mawr Ave., Chicago, IL 60631. (*)H. Williamson (Block 7).				
16. ABSTRACT The 15-volume report summarizes the results of a comprehensive program to quantify methane (CH <sub>4</sub> ) emissions from the U. S. natural gas industry for the base year. The objective was to determine CH <sub>4</sub> emissions from the wellhead and ending downstream at the customer's meter. The accuracy goal was to determine these emissions within +/-0.5% of natural gas production for a 90% confidence interval. For the 1992 base year, total CH <sub>4</sub> emissions for the U. S. natural gas industry was 314 +/- 105 Bscf (6.04 +/- 2.01 Tg). This is equivalent to 1.4 +/- 0.5% of gross natural gas production, and reflects neither emissions reductions (per the voluntary American Gas Association/EPA Star Program) nor incremental increases (due to increased gas usage) since 1992. Results from this program were used to compare greenhouse gas emissions from the fuel cycle for natural gas, oil, and coal using the global warming potentials (GWPs) recently published by the Intergovernmental Panel on Climate Change (IPCC). The analysis showed that natural gas contributes less to potential global warming than coal or oil, which supports the fuel switching strategy suggested by the IPCC and others. In addition, study results are being used by the natural gas industry to reduce operating costs while reducing emissions.				
17. KEY WORDS AND DOCUMENT ANALYSIS				
a. DESCRIPTORS		b. IDENTIFIERS/OPEN ENDED TERMS		c. COSATI Field/Group
Pollution Emission Greenhouse Effect Natural Gas Gas Pipelines Methane		Pollution Prevention Stationary Sources Global Warming		13B 14G 04A 21D 15E 07C
18. DISTRIBUTION STATEMENT Release to Public		19. SECURITY CLASS (This Report) Unclassified		21. NO. OF PAGES 137
		20. SECURITY CLASS (This page) Unclassified		22. PRICE

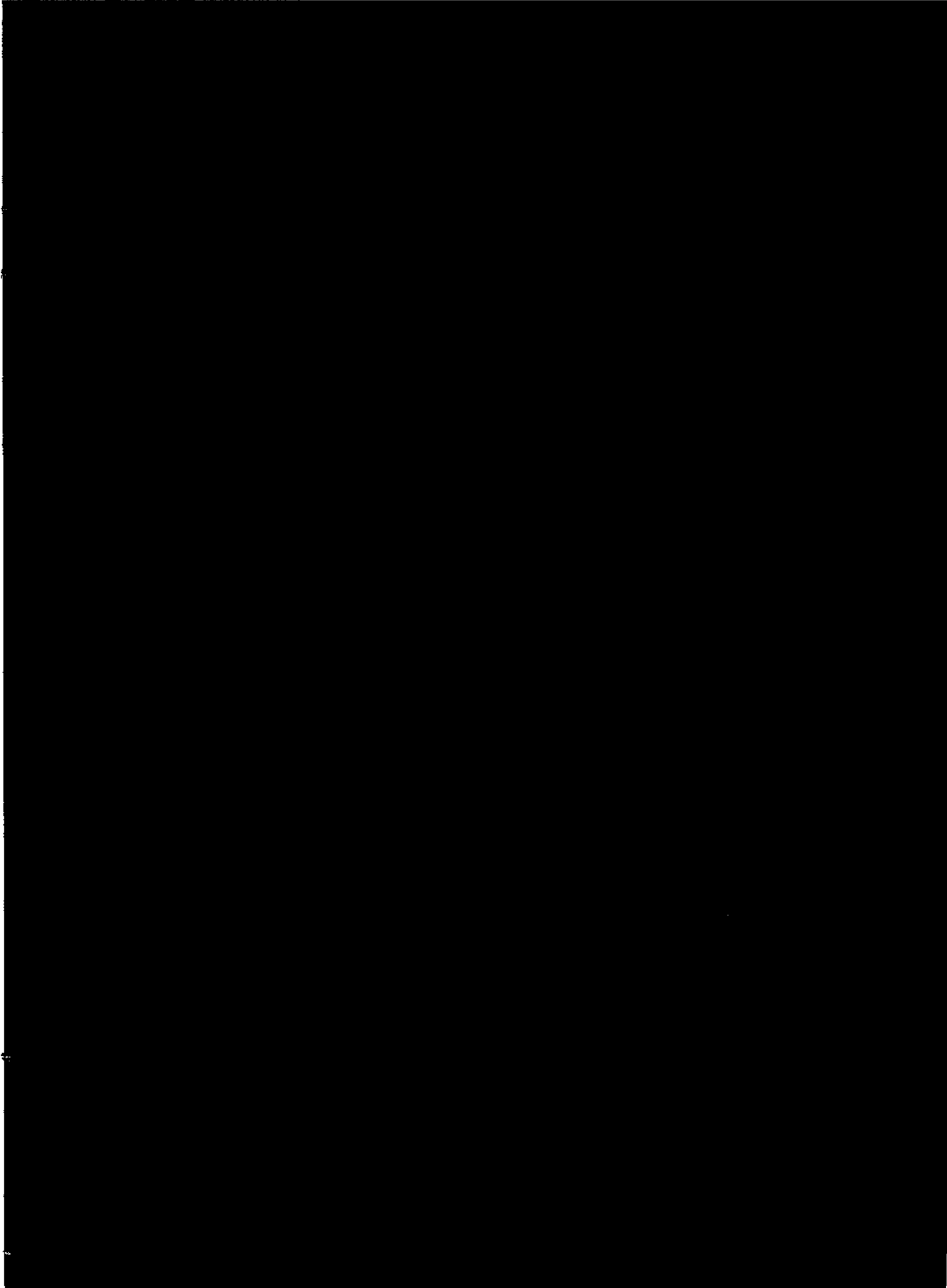

U.S. ENVIRONMENTAL PROTECTION AGENCY  
Office of Research and Development  
National Risk Management Research Laboratory  
Technology Transfer and Support Division  
Cincinnati, Ohio 45268

---

OFFICIAL BUSINESS  
PENALTY FOR PRIVATE USE, \$300  
AN EQUAL OPPORTUNITY EMPLOYER

*If your address is incorrect, please change on the above label  
tear off; and return to the above address.  
If you do not desire to continue receiving these technical  
reports, CHECK HERE ; tear off label, and return it to the  
above address.*

Publication No. EPA-600/R-96-080e