



United States
Environmental Protection
Agency

GRI-94 / 0257.20
EPA - 600/R-96-080c
June 1996

Research and Development

METHANE EMISSIONS FROM THE
NATURAL GAS INDUSTRY
Volume 3: General Methodology

Prepared for

Energy Information Administration (U. S. DOE)

Prepared by

National Risk Management
Research Laboratory
Research Triangle Park, NC 27711

FOREWORD

The U.S. Environmental Protection Agency is charged by Congress with protecting the Nation's land, air, and water resources. Under a mandate of national environmental laws, the Agency strives to formulate and implement actions leading to a compatible balance between human activities and the ability of natural systems to support and nurture life. To meet this mandate, EPA's research program is providing data and technical support for solving environmental problems today and building a science knowledge base necessary to manage our ecological resources wisely, understand how pollutants affect our health, and prevent or reduce environmental risks in the future.

The National Risk Management Research Laboratory is the Agency's center for investigation of technological and management approaches for reducing risks from threats to human health and the environment. The focus of the Laboratory's research program is on methods for the prevention and control of pollution to air, land, water, and subsurface resources; protection of water quality in public water systems; remediation of contaminated sites and groundwater; and prevention and control of indoor air pollution. The goal of this research effort is to catalyze development and implementation of innovative, cost-effective environmental technologies; develop scientific and engineering information needed by EPA to support regulatory and policy decisions; and provide technical support and information transfer to ensure effective implementation of environmental regulations and strategies.

This publication has been produced as part of the Laboratory's strategic long-term research plan. It is published and made available by EPA's Office of Research and Development to assist the user community and to link researchers with their clients.

E. Timothy Oppelt, Director
National Risk Management Research Laboratory

EPA REVIEW NOTICE

This report has been peer and administratively reviewed by the U.S. Environmental Protection Agency, and approved for publication. Mention of trade names or commercial products does not constitute endorsement or recommendation for use.

This document is available to the public through the National Technical Information Service, Springfield, Virginia 22161.

GRI-94/0257.20

EPA-600/R-96-080c

June 1996

**METHANE EMISSIONS FROM
THE NATURAL GAS INDUSTRY,
VOLUME 3: GENERAL METHODOLOGY**

FINAL REPORT

Prepared by:

Matthew R. Harrison
Hugh J. Williamson
Lisa M. Campbell

Radian Corporation
8501 N. Mopac Blvd.
P.O. Box 201088
Austin, TX 78720-1088

DCN: 95-263-081-13

For

GRI Project Manager: Robert A. Lott
GAS RESEARCH INSTITUTE
Contract No. 5091-251-2171
8600 West Bryn Mawr Ave.
Chicago, IL 60631

and

EPA Project Manager: David A. Kirchgessner
U.S. ENVIRONMENTAL PROTECTION AGENCY
Contract No. 68-D1-0031
National Risk Management Research Laboratory
Research Triangle Park, NC 27711

DISCLAIMER

LEGAL NOTICE: This report was prepared by Radian International LLC as an account of work sponsored by Gas Research Institute (GRI) and the U.S. Environmental Protection Agency (EPA). Neither EPA, GRI, members of GRI, nor any person acting on behalf of either:

- a. Makes any warranty or representation, express or implied, with respect to the accuracy, completeness, or usefulness of the information contained in this report, or that the use of any apparatus, method, or process disclosed in this report may not infringe privately owned rights; or
- b. Assumes any liability with respect to the use of, or for damages resulting from the use of, any information, apparatus, method, or process disclosed in this report.

NOTE: EPA's Office of Research and Development quality assurance/quality control (QA/QC) requirements are applicable to some of the count data generated by this project. Emission data and additional count data are from industry or literature sources, and are not subject to EPA/ORD's QA/QC policies. In all cases, data and results were reviewed by the panel of experts listed in Appendix D of Volume 2.

RESEARCH SUMMARY

Title	Methane Emissions from the Natural Gas Industry, Volume 3: General Methodology Final Report
Contractor	Radian International LLC GRI Contract Number 5091-251-2171 EPA Contract Number 68-D1-0031
Principal Investigator	Matthew R. Harrison
Report Period	March 1991 - June 1996 Final Report
Objective	This report describes the methods used to quantify the annual methane emissions from the natural gas industry. The methods include the general methods used for emission factor measurement, activity factor quantification, and extrapolation.
Technical Perspective	<p>The increased use of natural gas has been suggested as a strategy for reducing the potential for global warming. During combustion, natural gas generates less carbon dioxide (CO₂) per unit of energy produced than either coal or oil. On the basis of the amount of CO₂ emitted, the potential for global warming could be reduced by substituting natural gas for coal or oil. However, since natural gas is primarily methane, a potent greenhouse gas, losses of natural gas during production, processing, transmission, and distribution could reduce the inherent advantage of its lower CO₂ emissions.</p> <p>To investigate this, Gas Research Institute (GRI) and the U.S. Environmental Protection Agency's Office of Research and Development (EPA/ORD) cofunded a major study to quantify methane emissions from U.S. natural gas operations for the 1992 base year. The results of this study can be used to construct global methane budgets and to determine the relative impact of natural gas on global warming versus coal and oil.</p> <p>This report is Volume 3 of a multi-volume set of reports that fully describe the project. While general methodology is covered in this report, specific statistical methodology is covered in Volume 4, and detailed activity factor methodology is covered in Volume 5.</p>

Results

This report provides a brief summary of the methods used by the GRI/EPA project to estimate emissions from the natural gas industry. The methods have been extensively reviewed by industry experts and by project advisors throughout the duration of this multi-year project. The following is included: methods used to characterize the industry and to identify each emission source, the measurement techniques used to measure emissions, the procedures used for calculating emissions from sources that couldn't be measured, methods used to extrapolate per-device emissions to national totals, and the sampling techniques and statistical methods used to determine the accuracy of the emissions estimate.

The national emissions for the base year are 314 ± 105 Bscf ($\pm 33\%$), which is equivalent to $1.4 \pm 0.5\%$ of gross natural gas production. The program reached its accuracy goal and provides an accurate estimate of methane emissions that can be used to construct U.S. methane inventories and analyze fuel switching strategies.

Technical Approach

The techniques used to determine methane emissions were developed to be Representative of annual emissions from the natural gas industry. However, it is impractical to measure every source continuously for a year. Therefore, emission rates for various sources were determined by developing annual emission factors for sources in each industry segment and extrapolating these data based on activity factors to develop a national estimate, where the national emissions estimate is the product of the emission factor and activity factor. This report documents this overall technical approach.

The development of specific emission factors and activity factors for each source category are presented in separate reports (Volumes 6 through 15).

Project Implications

For the 1992 base year the annual methane emissions estimate for the U.S. natural gas industry is $314 \text{ Bscf} \pm 105 \text{ Bscf}$ ($\pm 33\%$). This is equivalent to $1.4\% \pm 0.5\%$ of gross natural gas production. Results from this program were used to compare greenhouse gas emissions from the fuel cycle for natural gas, oil, and coal using the global warming potentials (GWPs) recently published by the Intergovernmental Panel on Climate Change (IPCC). The analysis showed that natural gas contributes less to global warming than coal or oil, which supports the fuel switching strategy suggested by IPCC and others.

In addition, results from this study are being used by the natural gas industry to reduce operating costs while reducing emissions. Some companies are also participating in the Natural Gas-Star program, a

voluntary program sponsored by EPA's Office of Air and Radiation in cooperation with the American Gas Association to implement cost-effective emission reductions and to report reductions to EPA. Since this program was begun after the 1992 baseline year, any reductions in methane emissions from this program are not reflected in this study's total emissions.

Robert A. Lott
Senior Project Manager, Environment and Safety

TABLE OF CONTENTS

	Page
1.0 SUMMARY	1
2.0 INTRODUCTION	2
3.0 METHOD USED TO CHARACTERIZE THE NATURAL GAS INDUSTRY ...	4
3.1 Natural Gas Industry Definition	4
3.2 Production Segment Definition	6
3.3 Gas Processing Segment Definition	9
3.4 Transmission and Storage Segment Definition	10
3.5 Distribution Segment Definition	13
4.0 EMISSION ESTIMATION TECHNIQUES	15
4.1 Measurement Techniques for Steady Emissions	15
4.2 Calculation Approach for Unsteady Emissions	17
5.0 GENERAL EXTRAPOLATION METHODOLOGY	19
5.1 Emission Factors	20
5.2 Activity Factors	21
6.0 SAMPLING AND STATISTICAL ACCURACY	45
6.1 Sampling Approach	47
6.2 Screening for Bias in Activity Factors	53
6.3 Screening for Bias in Emission Factors	54
6.4 Accuracy Target	57
6.5 Overall Statistical Accuracy	61
7.0 REFERENCES	63
APPENDIX A - Production Source Sheets	A-1
APPENDIX B - Gas Processing Source Sheets	B-1
APPENDIX C - Transmission/Storage Source Sheets	C-1
APPENDIX D - Distribution Source Sheets	D-1
APPENDIX E - Conversion Table	E-1

LIST OF FIGURES

	Page
3-1 Gas Industry Flow Chart	5
3-2 Industry Boundaries	7
3-3 Gas Processing Plant	11
3-4 Transmission and Storage Stations	12
3-5 Distribution Segment Equipment	14
5-1 Selected Production Regions	29
6-1 Illustration of Random and Bias Errors	46

LIST OF TABLES

	Page
5-1 Well-Defined Activity Factors	23
5-2 Examples of Developed Activity Factors	24
5-3 Example Data Compilation of Sites in Region X	27
5-4 Regional Differences in Production Rates and Well Counts	30
5-5 Production Sites Summary	32
5-6 Data for Offshore Production Sites	33
5-7 Data for Gulf Coast Onshore Production Sites	34
5-8 Data for Central Plains Production Sites	35
5-9 Data for Pacific/Mountain Production Sites	36
5-10 Data for Atlantic and Great Lakes Production Sites	37
5-11 Gas Processing Plants	40
5-12 Transmission Compressor Stations	41
5-13 Storage Compressor Stations	43
6-1 Estimated Methane Emissions from Distribution Metering and Pressure Regulating Stations	56
6-2 Percentage of Error in Total Emissions	59

1.0 SUMMARY

Fuel switching has been suggested by the International Panel on Climate Change (IPCC), U.S. Environmental Protection Agency (EPA), and others as a strategy for reducing global warming. During the combustion process, natural gas generates less carbon dioxide (CO₂) per unit of energy generated than either coal or oil. On the basis of the amount of CO₂ generated, global warming could be reduced by substituting natural gas for coal. However, since natural gas is primarily methane, a potent greenhouse gas, losses of natural gas during the production, transmission, and distribution of natural gas could reduce or even eliminate the inherent advantage of its lower carbon dioxide emissions during combustion. For this reason, Gas Research Institute (GRI) and the U.S. Environmental Protection Agency Office of Research and Development (EPA-ORD) developed a jointly funded and managed program to better define methane emissions from the U.S. natural gas industry. The objective of this comprehensive program is to quantify methane emissions from the gas industry, beginning at the wellhead and ending immediately downstream of the customer's meter, with an overall accuracy goal of 0.5% of natural gas production (± 111 Bscf) based on a 90% confidence level.

This report provides a brief summary of the methods used by the GRI/EPA project to estimate emissions from the natural gas industry. The methods have been extensively reviewed by industry experts and by project advisors throughout the duration of this multi-year project. The methods include the following: the industry characterization that was used to identify each emission source, the measurement techniques used to directly measure emissions, the calculation approach used to estimate unmeasured emissions, the activity factor approach used to extrapolate per-device emissions to national totals, and the sampling techniques and statistical methods used to determine the accuracy of the emission estimate. These methods are more completely described in other volumes prepared as part of this project.

2.0 INTRODUCTION

The GRI/EPA project was conducted in three phases: scoping, methods development, and implementation. During the scoping study, methane emissions from each source in the gas industry were estimated on the basis of available data and engineering judgement. These initial estimates were used to set priorities for data collection according to the relative contribution to emissions or the uncertainty in emissions.

In the second phase of the program, methods were developed to measure and/or calculate emissions from all sources of methane emissions in the gas industry. These methods were validated through tests designed to quantify the accuracy in the measurement approach (i.e., proof of concept tests), and through industry review for the calculation approaches. However, emissions could not be measured or calculated from each individual source (e.g., glycol dehydrator, compressor engine) in the natural gas industry because of the vast number of sources. Therefore, part of the second phase was to develop defensible techniques for extrapolating limited data collected for sources in a specific source category to similar sources nationwide.

The third phase of the program focused on collecting data needed to define emissions from all sources and extrapolating these data to develop a national estimate. Data collection in this phase concentrated on high priority sources. An Advisory Committee consisting of industry representatives, project sponsors, and other interested parties from both the government and private sectors provided guidance and peer review for all phases of the program. In addition, an Industry Review Panel provided more detailed technical review of the project.

This report briefly describes the methods used in all phases of the GRI/EPA methane emissions study. Section 3 presents the methods for characterizing the industry and identifying sources of emissions (part of Phase I of the program). Section 4 presents the measurement and calculation methods used to determine emissions from each source

type or category. Section 5 presents the methods used to extrapolate emissions from individual sources to a national total. Section 6 provides a brief summary of the sampling and statistical methods used to determine the accuracy of each emissions estimate. The appendices (A, B, C, D) present some of the data collected as part of the program and the worksheets for determining emissions and extrapolating national annual emissions for each source of methane emissions in the natural gas industry.

3.0 **METHOD USED TO CHARACTERIZE THE NATURAL GAS INDUSTRY**

The first step for estimating methane emissions from the U.S. natural gas industry is to identify and characterize each emission source so that all significant sources are included. This section of the report characterizes the industry by outlining the segments of the industry as well as the types of equipment found within each segment. (This section is identical to Section 3 of Volume 5 on activity factors.¹)

While this section draws a general picture of the industry developed by the GRI/EPA methane emissions project, it is not intended to present a definitive picture of the industry regarding all typical operational parameters but only those that are necessary to identify all sources and causes of methane emissions.

3.1 **Natural Gas Industry Definition**

The natural gas industry produces and delivers natural gas to various residential, commercial, and industrial customers. The industry uses wells to produce natural gas existing in underground formations, then processes and compresses the gas and transports it to the customer. Transportation to the customer involves intra- and interstate pipeline transportation, storage, and finally distribution of the gas to the customer through local distribution pipeline networks.

The generally accepted segments of the natural gas industry are 1) production, 2) gas processing, 3) transportation, 4) storage, and 5) distribution. Each of these segments is shown in the overall flow chart for the industry in Figure 3-1. Each segment is described in more detail in the following subsections.

Boundaries for the study were defined to specify what equipment is included or excluded from the study. These boundaries were set using input from industry experts.

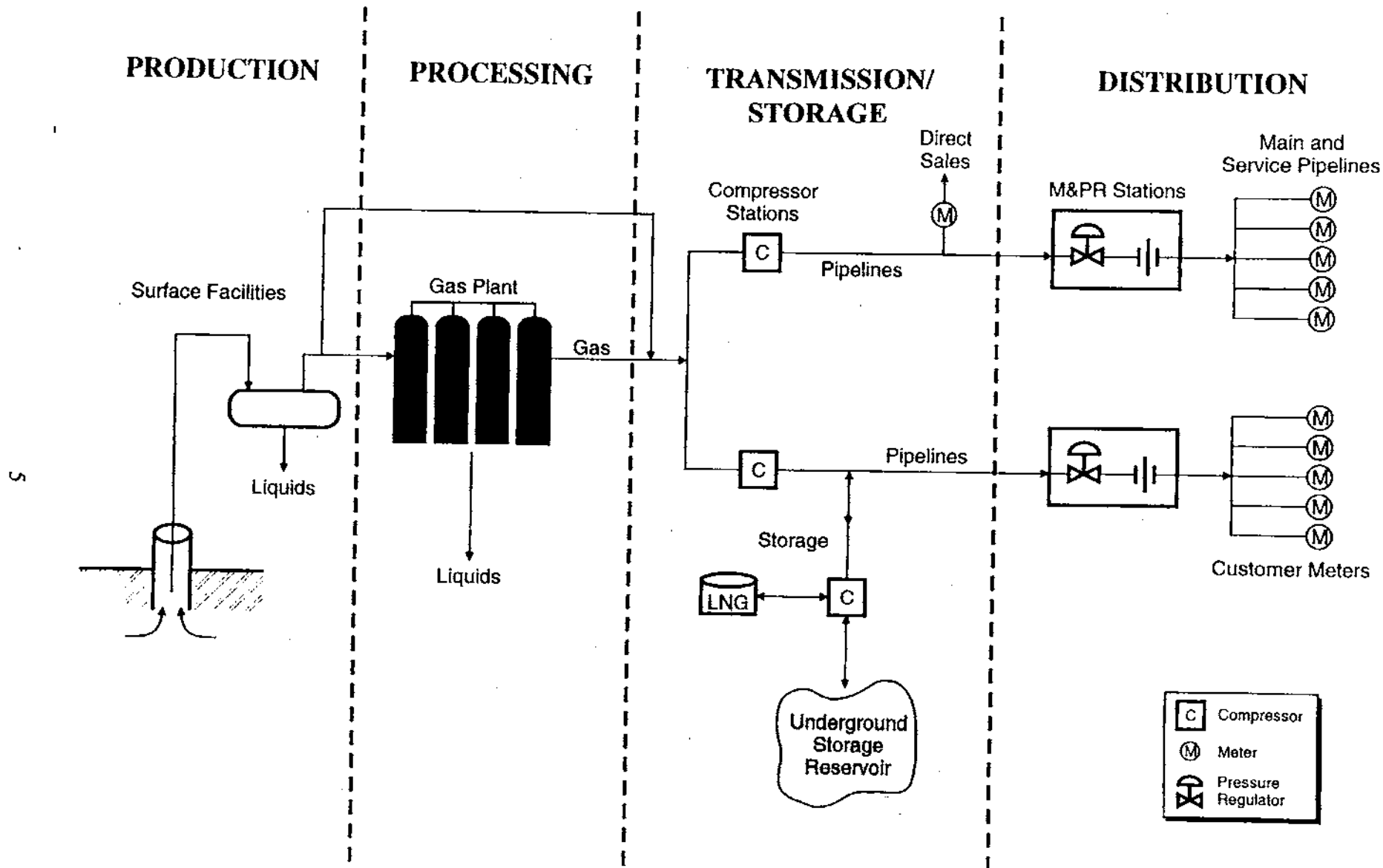

Figure 3-1. Gas Industry Flow Chart

The guideline used for setting the boundaries was to exclude equipment in each segment not required for the marketing of natural gas. For example, certain oil production equipment is excluded from the production segment since it exists to produce oil and is not needed for gas production (see Figure 3-2). Similarly, in gas processing, equipment associated with the fractionation of propane, butane, and natural gas liquids is excluded. In distribution, all equipment up to and including the customer's meter are included. End user piping, combustion, and vented emissions are not included.

3.2 Production Segment Definition

Emissions of methane that result from oil production, or that occur naturally (non-anthropogenic) from formations, are excluded. Unmarketed natural gas, such as that produced by oil wells that vent some gas, are not considered part of the gas industry.

The production segment is composed of gas wells, oil wells, and surface equipment. The well includes the holes drilled through subsurface rock that reach the producing formation and the subsurface equipment such as casing and tubing pipe. Gas and oil surface equipment can include separators, heaters, heater-treaters, tanks, dehydrators, compressors, pumps, and pipelines.

However, the segment definition for gas industry production equipment excludes equipment associated with oil production. Figure 3-2 shows the general equipment found in the oil and gas production segment as well as the selected boundaries for gas industry equipment used by this study. Equipment outside the boundaries were not included in the activity factor estimates developed in this study.

The rationale for defining the boundaries is that all equipment at a gas well site, except equipment used to collect and handle liquids that are marketed (oil or condensate), is part of the gas industry, but that all equipment at an oil well site is excluded unless it is used to collect, process or transport marketed natural gas (Figure 3-2).

Oil Wells

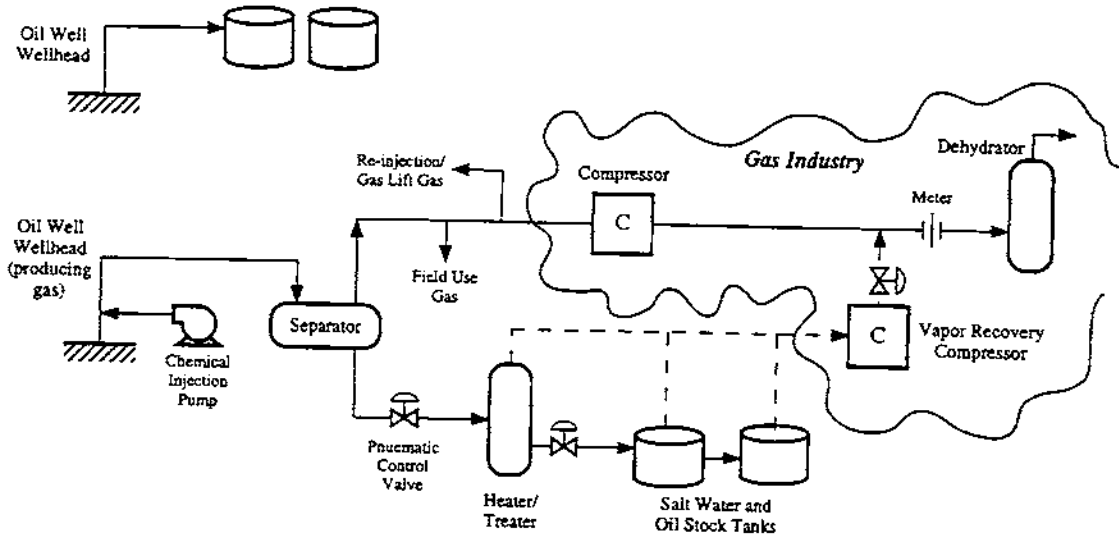

Gas Wells

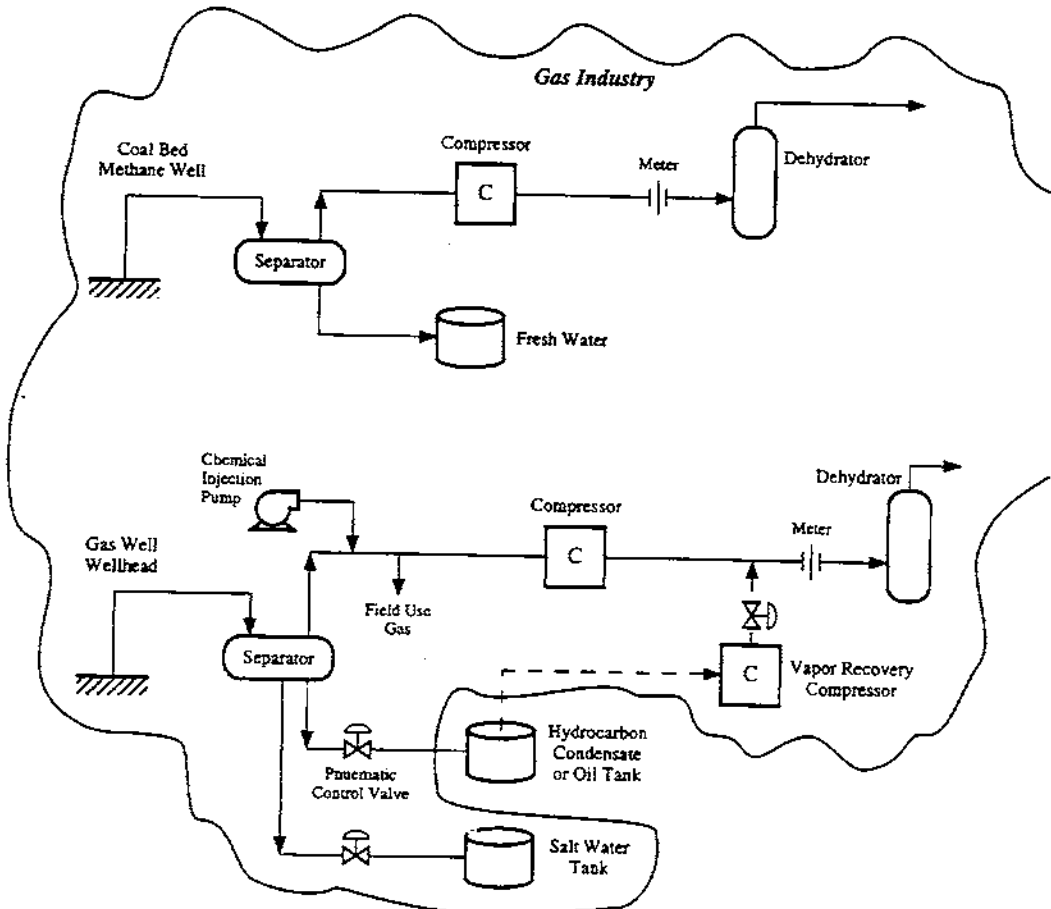

Figure 3-2. Industry Boundaries

Therefore, the definition excludes all oil tanks and equipment at all oil wells that do not market gas. In addition, it excludes much of the equipment at oil wells that do market gas. At oil wells that market gas, the gas production is secondary and usually generates lower revenue; the well exists primarily because it produces oil. Therefore, the wellhead, the separator, the pneumatic control valves, the well's chemical injection pumps, any field use gas lines, and all of the liquid piping are considered part of the oil industry and are excluded from the GRI/EPA gas industry study. The gas industry equipment begins only on the gas line downstream of the separator, at the first piece of gas line equipment, such as the sales meter, compressor, or dehydrator.

In general, an oil or oil and gas field may have centralized surface treatment facilities or each well site may have its own independent surface facilities. In centralized facilities, all of the separators, dehydrators, and compressors may be in one location, with gas flowing in from gathering pipelines connected to many wellheads. Decentralized facilities have all the necessary surface equipment (separators, compressor, dehydrator, etc.) at each individual well site. Centralized facilities can have lower equipment counts per well than decentralized facilities. Sometimes the facilities may be primarily decentralized but have a few centralized components. For example, separators may be at each well (decentralized), while compressors and dehydrators may be centralized.

Whatever the field configuration, all gas wells have a wellhead and most have a gas meter. Also independent of the field configuration, gas wells may or may not have a separator(s), dehydrator, or compressor. The use of the equipment depends upon the free liquid production, absorbed moisture content, and well pressure. For example, some sweet, dry gas wells can produce directly to a pipeline. However, most wells require separation for free-liquid products (salt water, hydrocarbon condensate, and oil) and some dehydration.

Oil wells that market gas (the only oil wells included in this study) may also have centralized or individual well site facilities. They will always have a separator and a

meter. As with gas wells, they may or may not have a dehydrator or a compressor, depending upon the absorbed moisture content and the pressure.

Oil wells that market gas may be either free-flowing or artificial-lift wells. Free-flowing wells often have absorbed or co-produced gas that is marketed. Therefore, some of the equipment at these free-flowing oil wells is considered part of the gas industry if it exists to market the gas. Artificial-lift oil wells are most often not part of the gas industry, but a few do produce gas and therefore are included in the gas industry definition.

Artificial-lift oil wells that have downhole pumps or surface pump jacks usually do not produce or market any gas and therefore are not part of the gas industry. Artificial-gas lift oil wells push compressed gas downhole and inject the gas into the tubing, thus using the gas to aerate the oil in the tubing string. This brings the oil back to the surface. Only the gas-lift wells that produce and market gas in excess of the amount injected are considered part of the natural gas industry. For gas-lift oil wells that market gas, the compressors associated with the gas-lift circulation are not considered to be part of the gas industry.

3.3 Gas Processing Segment Definition

Natural gas processing plants exist primarily to recover high value liquid products from the gas stream and to maintain the quality (content and heating value) of the gas stream. The liquid products include natural gasoline, butane, and propane. (Ethane is sometimes recovered as well.) The products are removed by compression and cooling or by absorption. Absorption processes use a fluid, such as lean oil, to absorb the liquid components from the gas stream in a tower; the rich oil is then heated to release the recovered products. A compression and cooling process uses a turboexpander or a refrigeration process to supercool the natural gas so that the products will condense.

A gas plant may have fractionation towers and stabilization towers to further purify the individual components of the product stream. The back end of the gas plant, such as the fractionation train, is excluded from the gas industry definition since it exists to purify and market liquid products. The back end of the gas plant has negligible methane emissions since the liquids handled contain only trace amounts of methane.

The front end of the gas plant often contains dehydration facilities, wet gas compression, and the absorption or compression and cooling process. All gas plants are considered part of the natural gas industry. Therefore, all methane emissions from natural gas processing plants are included in this study. Figure 3-3 shows a schematic diagram of a gas plant.

3.4 Transmission and Storage Segment Definition

The transmission segment moves the natural gas from the gas plant or directly from the field production to the local distribution companies (LDCs). Gas is often moved across many states, such as from the Gulf Coast to the eastern seaboard of the United States. The segment consists of large diameter pipelines, compressor stations, and metering facilities. All of these facilities and all of the equipment they contain are considered part of the natural gas industry.

Transmission compressor stations usually consist of piping manifolds, reciprocating or gas turbine (centrifugal) compressors, and generators. Dehydrators may be included but are not usually present because of upstream drying. The station may also include metering facilities. Figure 3-4 shows a schematic diagram of transmission and storage stations.

Transmission companies also have metering and regulating stations where they exchange gas with other transmission companies or where they deliver gas to the LDCs. Storage facilities exist to store natural gas produced during off-peak times (summer) so that the gas can be produced and delivered during periods of peak demand in the winter.

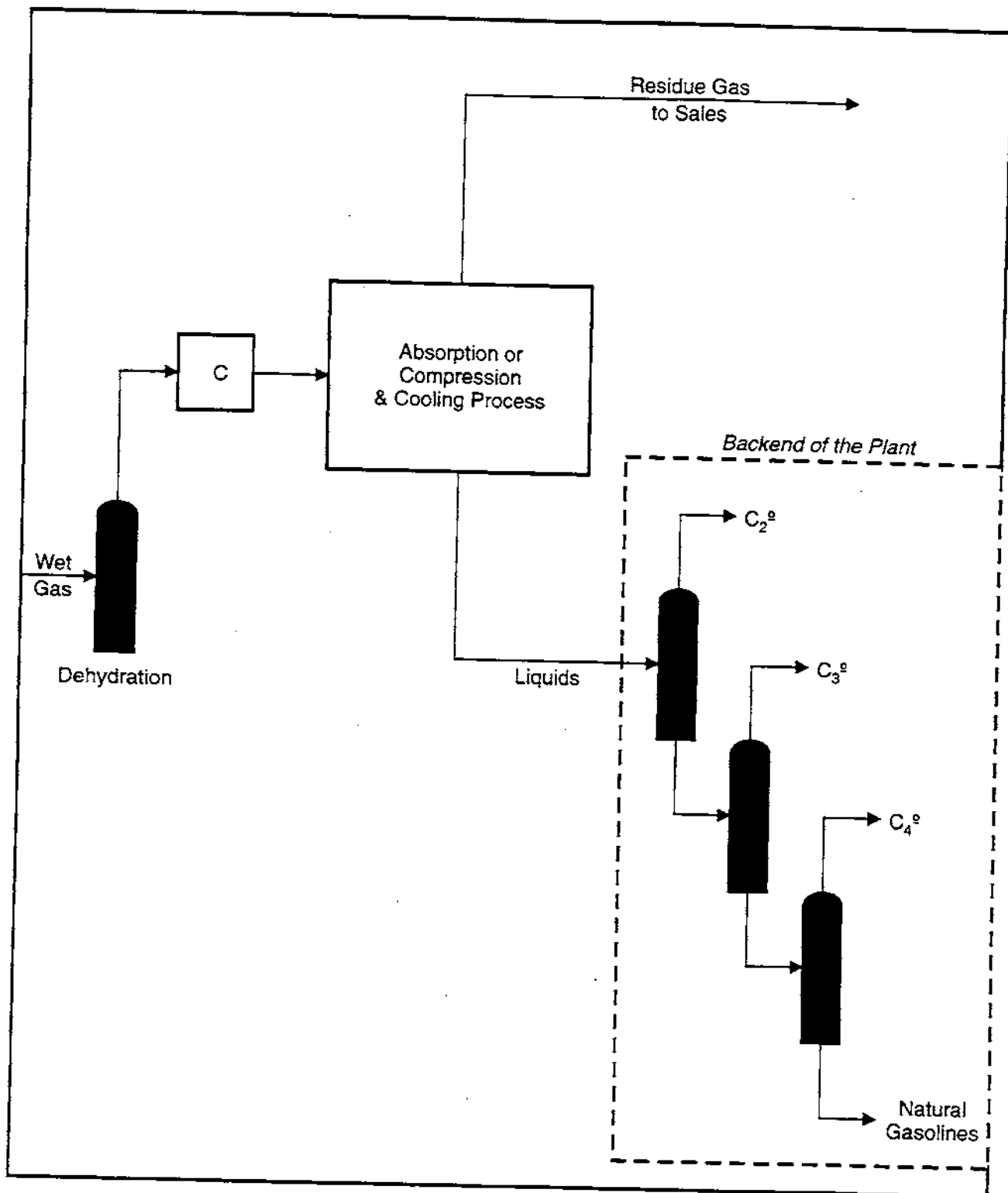

Figure 3-3. Gas Processing Plant

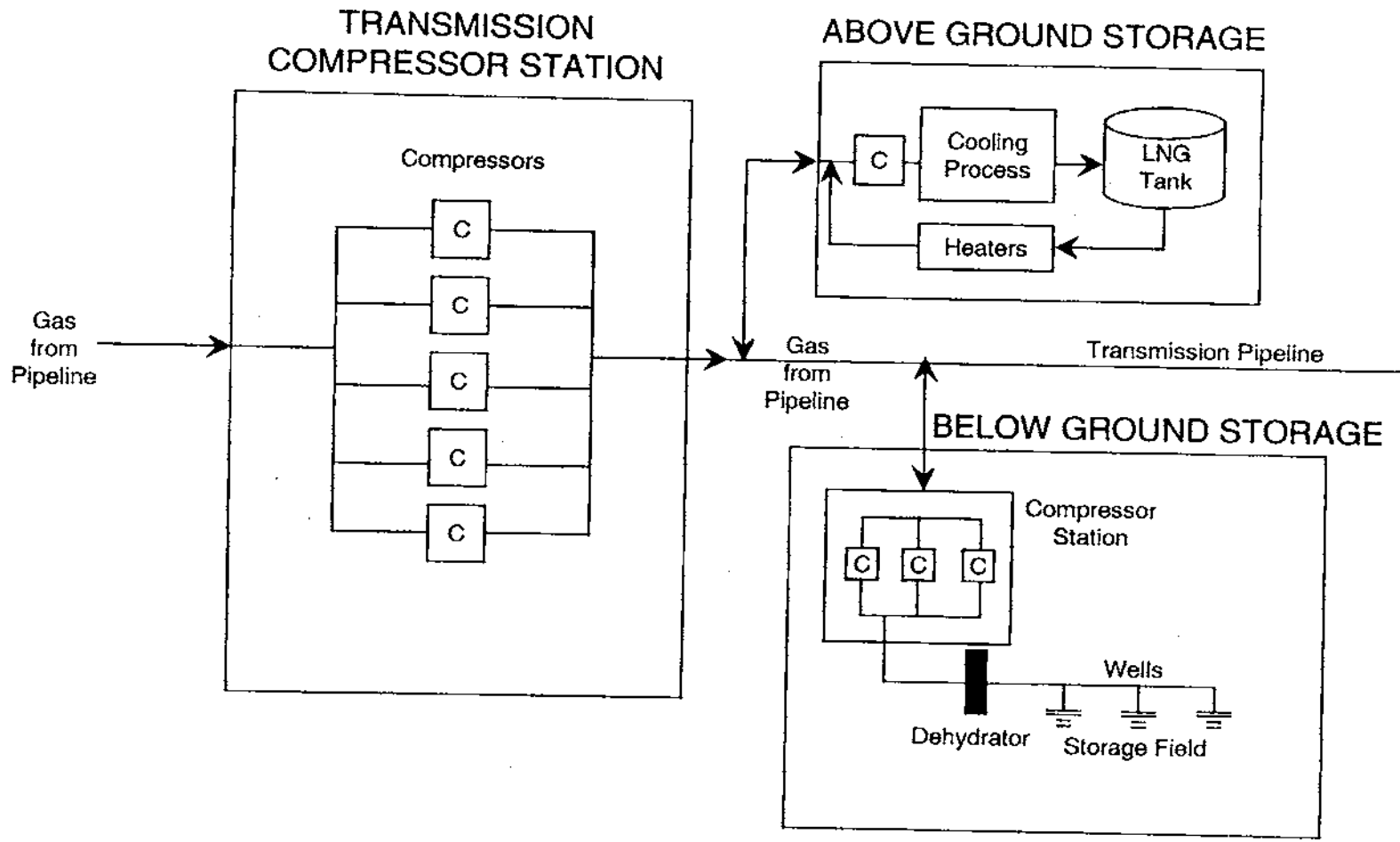

Figure 3-4. Transmission and Storage Stations

Storage facilities are often located close to consumption centers so that a cross-country transmission pipeline does not have to be sized for peak winter demand. Storage facilities can be below or above ground. Above-ground facilities are liquefied natural gas (LNG) facilities that liquefy the gas by supercooling and then store the liquid-phase methane in above-ground, heavily insulated storage tanks. Below-ground facilities compress and store the gas (in vapor phase) in one of several formations: 1) spent gas production fields, 2) aquifers, or 3) salt caverns. Below-ground storage is the predominant means of gas storage.

Most storage stations consist of a compressor station that is very similar to a transmission compression station (see Figure 3-4). Underground storage facilities also have storage field wells and often have dehydrators to remove the water absorbed by the gas while underground. Except for emissions from underground leaks in storage formations, all storage equipment is included in the boundaries for the gas industry as defined by this project.

3.5 Distribution Segment Definition

The distribution segment receives high-pressure gas from the transmission pipelines, reduces the pressure, and delivers the gas to all of the residential, commercial, and industrial consumers. The segment includes pipeline (mains and services), meter and regulation stations (city gates), and customer meters. All of these facilities are considered to be an integral part of the gas industry. Figure 3-5 shows a schematic of the distribution segment and associated equipment.

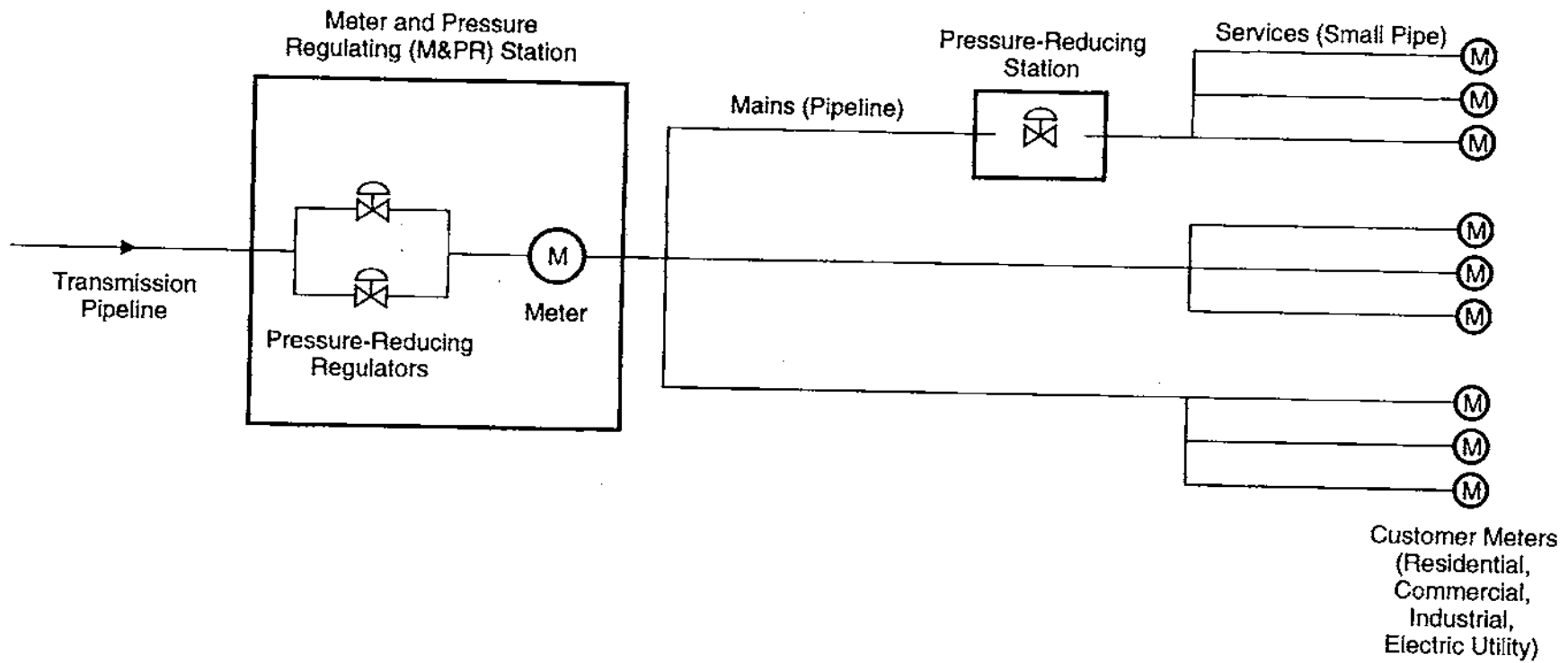

Figure 3-5. Distribution Segment Equipment

4.0 EMISSION ESTIMATION TECHNIQUES

After all potential sources of methane emissions in the industry were identified and characterized, the emissions were quantified. The method selected to quantify the emissions from a source depended on the variability of emissions with time. The sources were divided into two categories: steady emitters and unsteady emitters. Emission sources with continuous bleed rates, or with reasonably steady bleed rates over a typical measurement time, are considered "steady" sources and can be more easily measured. Fugitive emissions are generally considered steady. Unsteady emitters are defined as sources with highly variable emissions, such as a pneumatic device on an isolation valve or a maintenance activity that requires blowdown. These emissions sources vary from company to company and site to site because of different maintenance practices and operating conditions. "Steady" is a relative term and is defined by the time period of data needed for the study. For this study, the annual value of methane emissions is needed. Because it would be impractical to measure emissions all year for every source, it is important that a single measurement is representative of the annual emissions.

This section describes the measurement techniques used for steady emissions and the calculation approach used to estimate unsteady emissions.

4.1 Measurement Techniques for Steady Emissions

The techniques used in the study for measuring steady emissions is briefly described below.

Fugitives Measurement Methods

Emission factors for estimating fugitive emissions were determined based upon measurements of emissions from individual sealed surfaces (components) associated with the equipment, such as valve packing, flange gaskets, screwed fittings, and compressor/pump

seals. Emissions from a large number of components were measured and an average emission rate per component determined for each component type. Emissions from an equipment source, such as a compressor, or a facility, such as a compressor station, were then calculated by multiplying the number of components associated with that equipment or facility with the average emission rate per component.²

Emissions from individual components were measured using one of several methods:

- A high flow organic vapor analyzer captures the entire leak and measures the methane concentration and flow rate. The emissions rate is determined from the product of the concentration and flow rate.
- A total enclosure technique called bagging. Uncontaminated air is blown through a plastic bag enclosing the component. The flow rate and outlet concentration is measured by an organic vapor analyzer, and the leak rate is determined from the product of the concentration and flow rate.
- A screening technique where the methane concentration is measured at the point of the leak using a standard organic vapor analyzer. The concentration is related to an emission rate by a correlation equation that was developed in other studies and that related bagged emissions to the concentration measured during the screening test.

Tracer Gas Method

The tracer gas method of measuring methane emissions consists of releasing tracer gas (at a known constant rate) near the emission source and measuring the downwind concentrations of the tracer gas and methane. Assuming complete mixing of the methane and tracer gas and identical dispersion, the ratio of the downwind concentrations is equal to the ratio of the release rates. Based upon the downwind concentrations of methane and tracer gas and the known release rate of the tracer, the emission rate of methane can then be determined. This method was used primarily to measure emissions from meter and pressure regulating stations.³

Leak Statistics Method

The leak statistics method is used to quantify methane emissions from underground mains and services in distribution systems. Emission rates are measured for a large number of leaks to accurately determine the average emission rate per leak as a function of pipe material, age, pressure, and soil characteristics. The leak statistics program was conducted as a cooperative program between EPA/GRI and industry. The industry participants used specially designed equipment to measure leakage rates from underground distribution mains and services. To perform the measurement, a pipe segment containing the leak is isolated, the isolated segment repressurized, and the volumetric flow required to maintain normal operating pressure in the isolated segment is measured. The leak statistics method combines the measured leakage rate per leak with the historical leak records of the companies and national leak repair data to determine the number of leaks per mile for different pipe material. The emissions are determined by multiplying the leak rate per leak by the leaks per mile and number of miles of pipe.⁴

Direct Flow Measurement

The direct flow method was used to measure emissions from some pneumatic devices and leaks in some open ended lines. Since the gas consumption of certain pneumatic devices is emitted to the atmosphere, a flow measurement of the supply gas to the pneumatic device can be used to characterize the device emissions. Measurements used by this study involved a direct flow turbine meter that was installed in the supply gas lines.⁵ Leaks from some open ended lines were measured by directly connecting a gas meter to the line.

4.2 Calculation Approach for Unsteady Emissions

Emissions that are intermittent or unsteady have highly variable emission rates during a year. Because it would not be practical to collect data continuously for a year for each source, emissions from these sources were often calculated rather than measured.

For some sources, such as maintenance emissions, detailed company calculations are available for multiple years.⁶ However, most sources of emissions are not tracked by companies and therefore must be calculated.

Each unsteady source of emissions requires data gathering and a unique set of equations to quantify the average annual emissions. In general, all unsteady sources of emissions require the following information to quantify annual emissions:

- A detailed technical characterization of the source, identifying the important parameters affecting emissions. (This information was documented for individual source types in other Tier 3 reports on each major emission type.^{1,7,8,9})
- Data gathered (from multiple sites) that would be needed to calculate emissions per event.
- Sufficient data to define the frequency of events.

An example of emissions calculated for an unsteady source is the estimate of emissions from a vessel blowdown for routine maintenance. In this case, the volume, pressure, and temperature of gas contained in the vessel before blowdown is "calculated" to quantify the losses from the blowdown event. Additionally, an average frequency of these vessel blowdown events is necessary to determine the annual losses from this source of methane emissions.

In some cases, measurement from other studies were used to establish the emissions per event. Therefore, these emissions data were combined with site data collected in this study to quantify the number of events per year in order to calculate the annual emissions from these sources. Examples of sources where data from other studies were used are: emissions from compressor exhaust, gas-operated pneumatic devices, glycol dehydrator regenerator overhead vents, and gas-operated chemical injection pumps by measuring the emissions per event.

5.0

GENERAL EXTRAPOLATION METHODOLOGY

By necessity, data were collected on a relatively small percentage of sources within each source category. These data were extrapolated to obtain nationwide estimates for similar sources throughout the industry. The extrapolation techniques for creating nationwide emission estimates were developed so that the emissions for each source category could be estimated to meet a specified level of precision and negligible bias.

The extrapolation approach is a method to scale-up the average emissions from a source, determined by a limited sampling effort, to represent the entire population of similar sources in the gas industry. The extrapolation approach uses the concept of emission and activity factors to estimate emissions based on the limited number of samples. These factors are defined in such a way that their product equals the total emissions from a source category.

$$EF \times AF = \text{National Emissions} \quad (1)$$

Typically, the emission factor is the average measured or calculated emissions from a large number of randomly selected sources in a source category and the activity factor is the total number of sources in the entire target population or source category. However, in applying this simplified approach to developing emission and activity factors it is important to ensure that there is no bias in the data.

The extrapolation methodology involves more than just the scale-up of emissions data; it also includes the sampling approach which is fundamental to the accuracy of the emissions data.

This section describes the two components for the extrapolation equation—emission factors and activity factors.

5.1 Emission Factors

The emission factor is generally defined as the annual emissions per source. In many cases, the emission factor was calculated by simply summing the emissions data from each source and dividing by the number of sources sampled. The emissions data would be measurements or estimates for each source. In some cases, the variability of the emissions data from source to source is very large. For source types of this nature, it is often possible to reduce variability by redefining the emission factor or by stratification. Reducing the variability is important because it reduces the number of data points needed to achieve the accuracy target.

Redefining the Emission Factor

For a few types of sources, emissions can be more accurately estimated with fewer data points when the emission factor is defined not as a simple average for the source but in relation to key parameters that influence the emissions from the source. This is essentially the same as subdividing the source category into subsets. Since the variability is significantly reduced, fewer total data points are required to achieve an acceptable level of accuracy.

For example, the internal combustion engines that drive compressors in the gas industry vary in size (i.e., horsepower rating). If data were collected on individual engines in the industry and an average emission rate per engine was established, the variability from engine to engine would be very large because of size differences. However, if the emission factor for the engines is defined by horsepower of the engine (i.e., annual emissions per horsepower), then the variability from engine to engine and therefore the number of samples required to reach an acceptable accuracy are both significantly reduced.

The number of data points required may also be reduced by stratifying on the basis of parameters that affect emissions. An example is quantification of the methane

emissions from underground distribution mains and services. Based on limited data, the variability in emission measurements for underground distribution lines was determined to be very large. By defining parameters that influence the emission rate from distribution lines and stratifying the emission factor and activity factor for this source by these parameters, the variability of emissions from source to source may be reduced. Data collection resources can be allocated to the parameters that contribute the most to the overall uncertainty of the estimate. Therefore, by subdividing a source into categories with differing emission characteristics and allocating data collection resources to the parameters that influence emissions the most, the overall number of samples required to meet the accuracy target can be reduced.

5.2 Activity Factors

This section on activity factors is an abbreviated version of the text presented in Volume 5.¹ The reader is referred to the activity factors report for specific details on particular activity factors that cannot be found in Section 5.2 or in the appendices to this report.

In general, the activity factor is the total population of the source when the emission factor is defined as the annual emissions per source. Exceptions to this general definition of an activity factor would only include sources that have an emission factor that can be more accurately represented by a parameter(s) that influences emissions (e.g., the emission factor for internal combustion engines is in terms of emissions per horsepower-hour). For these exceptions, the activity factor would be the parameter that influences emissions (e.g., horsepower-hours/year).

In some cases, existing programs track the total nationwide population of a source type, such as gas wells, miles of transmission and distribution pipelines, and total national production, within the natural gas industry, as shown in Table 5-1. However, in many cases, the total population of a source type within the gas industry is unknown.

Table 5-2 presents some of the activity factors that are not tracked nationally, but that were generated by this project.

For sources that have an unknown population, site visits were conducted to determine the number of sources at each site and to scale-up the site data to represent the total population. These site visits to collect activity factor data are typically conducted in conjunction with the data collection efforts for the emission factor. The number of sites visited, gas produced or marketed, and equipment counts are presented in Section 6.1, Sampling Approach. These site count data are scaled by using population data that is known and is related to the source. For example, in the GRI/EPA study, no data were available on the nationwide population of production separators. To calculate this value, the number of production separators at a site, gathered as part of site visits, were divided by the number of wells at each site. Then, the average ratio of separators to wells from all site visit data were used to extrapolate nationally by multiplying by the national well count. However, when scaling the site visit data to represent the entire population, a check for bias is made. (Refer to Section 6.2, Screening for Bias in Activity Factors.)

For sources that are not tracked nationally, individual company data or regional surveys (surveys by state agencies or trade organizations) were sometimes available. Metering/pressure regulating stations, glycol dehydrators, and compressor engines/gas turbines are tracked on a company wide basis or through regional surveys. For regional or company tracked activity factors, sufficient company/regional data had to be gathered to comprise a representative sample to extrapolate to a national population. In most cases, entire companies or regions could be represented by the data collected from one sample; therefore, few samples were required, in general, to represent the national population accurately.

The extrapolation of equipment activity factors from individual site data within a stratum is usually handled by selecting an "extrapolation parameter" (EP) that is known for the site as well as regionally or nationally. Examples of extrapolation parameters are the

TABLE 5-1. WELL-DEFINED ACTIVITY FACTORS

Segment	Activity Factor Name	Number
Total Industry	Gross Gas Production (Tscf)	22.13
Production	No. of gas wells	276,000
	No. of oil wells	602,000
Processing	No. of gas plants	726
	No. of AGR units	371
Transmission and Storage	Miles of transmission pipeline	284,500
	No. of storage facilities	475
	No. of wells	18,000
Distribution	Miles of mains	888,000
	No. of services	43,714,000

(Continued)

TABLE 5-2. EXAMPLES OF DEVELOPED ACTIVITY FACTORS

Segment	Activity Factor Name	Number
Total Industry	Reciprocating compressor drivers	44,130
	Turbine compressor drivers	1,543
	Number of glycol dehydrators	39,620
Production	No. of oil wells marketing gas	209,000
	No. of gas wells requiring unloading	114,100
	Compressor drivers	17,100 recips
	Engineer MMHp-hr	27,460
	Offshore platforms	1,114
	Glycol dehydrators	37,820
	Glycol dehydrator throughput (MMscfy)	12,400,000
	Separators	167,200
	In-line heaters	51,000
	Total production vessels	256,000
	Chemical injection pumps	16,970
	Pressure relief valves	529,400
	Gathering pipeline miles	340,000
Pneumatic devices	249,100	
Processing	Compressor drivers and installed HP	4,092 recips (4.19 MMHP) 726 turbines (5.19 MMHP)
	Annual compressor operating hours (average)	6,626 (recips) 6,345 (turbines)
	Glycol dehydrator throughput (MMscfy)	8,630,000
	Acid gas recovery units	371

(Continued)

TABLE 5-2. EXAMPLES OF DEVELOPED ACTIVITY FACTORS (Continued)

Segment	Activity Factor Name	Number
Transmission and Storage	Compressor drivers and installed HP	7,715 recips (13.4 MMHP) 817 turbines (5.1 MMHP)
	Annual driver operating hours (average)	
	- Transmission compressor drivers	3,964 (recips)
	- Transmission generating drivers	2,118 (turbines)
	- Storage compressor drivers	1,352 (recips)
	- Storage generating drivers	474 (turbines)
	Transmission compressor stations	3,707 (recips)
	Glycol dehydrator (throughput (MMscfy))	2,917 (turbines)
	M&R stations	191 (recips)
	- Farm taps	36 (turbines)
Distribution	Transmission compressor stations	1,700
	Glycol dehydrator (throughput (MMscfy))	3,086,000
	M&R stations	
	- Farm taps	71,690
	- Interconnects	2,533
	- Direct industrial sales	938
	M&R stations	132,000
	Outdoor customer meters	40,049,000
	Leak frequency	Various

number of wells for production, number of plants for processing, and number of compressor stations for transmission. Populations of other equipment, such as the count of separators at the site, are then divided by that term, allowing the resulting ratio to be easily extrapolated to a regional or national total.

However, the regional ratio of

$$\frac{AF_1}{EP} \quad (2)$$

where: AF_1 = activity factor (population) of equipment type 1
 EP = extrapolation parameter,

can be determined from 1) regional sums, or 2) by averaging the ratio from each site. The extrapolation plan must select one of these two methods based upon technical merit. These two methods can be described as: 1) weighting the site counts by the extrapolation activity factor, or 2) using an average count per site (not weighting).

For example, to determine the number of separators in a region, the production site count of separators and wells at a site could be extrapolated to the regional total by two methods: 1) summing the separators and dividing by the total well count (each site data is weighted by the total well counts), or 2) by averaging all of the site ratios of separators/well (thus treating each site as an equally representative sample). The decision on which method to use depended upon a technical analysis of whether that method would introduce bias. The method selected might vary from segment to segment, but was generally constant across most calculations within a segment. The first method, summing equipment from all sites and dividing by the sum of the extrapolation parameter, was used almost exclusively by this project. This is discussed in detail in Volume 4 on statistical methodology.¹⁰

The following hypothetical example illustrates the two options for extrapolating activity factors. The following table (Table 5-3) and calculations give an example of the two methods for determining the number of separators in a region in the natural gas production segment.

TABLE 5-3. EXAMPLE DATA COMPILATION OF SITES IN REGION X

Site	Site Count of Separators	Site Count of Gas Wells	Site Ratio (separators/well)
1	140	138	1.01
2	324	321	1.01
3	100	100	1.00
4	5	15	0.33
5	10	1000	0.01
TOTAL	579	1574	

On a basis weighted by the total wells at a site, the regional ratio is 579/1574, which equals 0.37 separators/well. This number is heavily weighted by one of five sites that had a low separator per well count but a high number of wells (about ten times as many as any other site). If the second method is used, each site is treated as an equally representative sample and the average of the site ratios is used; the result is 0.67 separators/well.

The first method was selected for all production activity factor extrapolations since there is a reason to believe that a randomly selected site that has many wells is representative of a larger portion of the population than a randomly selected site with only a few wells. Weighting by well count assumes that a larger number of wells at a site means that the site is representative of a larger population than a site with a smaller well count. Volume 5 on activity factors¹ provides additional details on this method.

In addition, some equipment activity factors sources could be scaled up by several possible EPs. If a known physical/technical relationship existed between the source

population and one EP, then that parameter was selected. However, where the relationship between the source population and the other parameters is not obvious from a technical perspective, many approaches having technical merit were used, and either a) the average of the methods was used, or b) the resulting data from individual companies statistically analyzed to determine the appropriate extrapolation approach.

For example, it was not clear from a technical perspective whether to scale-up the number of metering/pressure regulating stations by miles of main pipeline or system throughput, which were the only known population statistics. The station counts from individual companies were examined both from a per mile main and per system throughput basis. A linear regression analysis showed that if the data were preferentially extrapolated using a per mile main basis, the resulting national extrapolation would have lower variability. In production, the number of separators appears to be technically related to both well count and throughput. Therefore, separator count was extrapolated by both methods, and the average of the two national estimates was used.

Activity Factors Developed for Production Sources

Most production activity factors were extrapolated by ratio to known EPs. The extrapolations were done on a regional basis, since regional biases were known to exist and each of the well-known EPs (i.e., well count and production throughput) were also known on a regional basis. Six regions were selected based upon an analysis of the production and well population centers in the United States., as well as based upon known differences in practices in various regions. The regions are: 1) Gulf Coast Onshore, 2) Gulf Coast Offshore, 3) Central Plains (onshore), 4) Atlantic & Great Lakes (onshore), 5) Pacific and Mountain (onshore), and 6) Pacific Offshore. Figure 5-1 shows the regions selected and which states are included.

The differences in the regions justify their selection and can be seen in Table 5-4. Specifically, Table 5-4 shows the regional biases that exist in production versus well

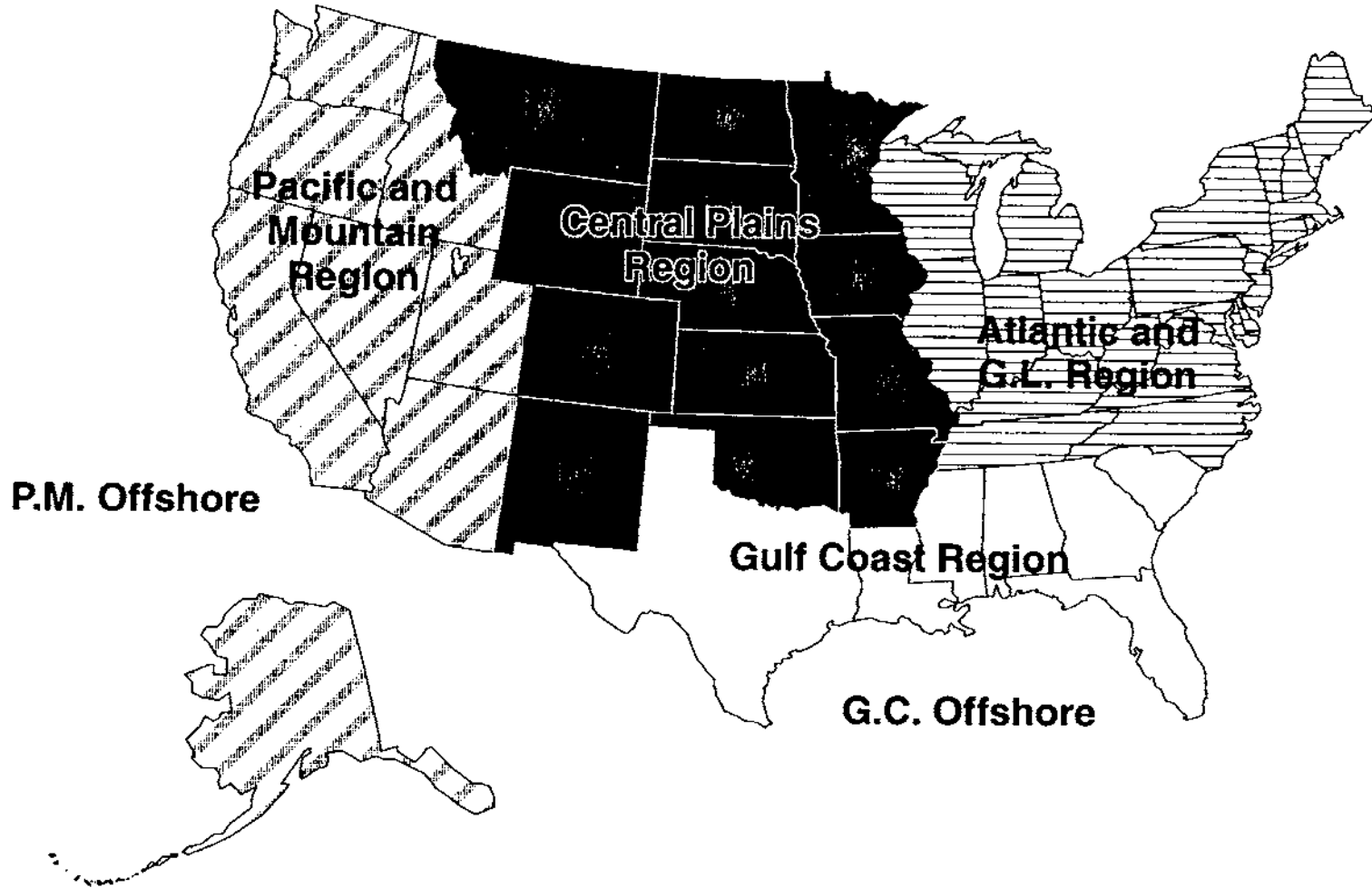

Figure 5-1. Selected Production Regions

TABLE 5-4. REGIONAL DIFFERENCES IN PRODUCTION RATES AND WELL COUNTS

Regional Groupings	States in Region that are > 50 Bsc/yr	1992 Producing Gas Wells ^a		1992 Producing Oil Wells ^a		1992 Marketed Production ^b		1992 Gross Production ^b	
		Count	Percent of Total	Count	Percent of Total	Bscfy	Percent of Marketed Total	Bscfy	Percent of Gross Total
Gulf Coast Region Total	TX,LA,FL	63667	23.1	217567	36.1	11514	61.5	12272	55.4
GC Offshore ^c		4021	1.5	5140	0.9	5000	26.7	5045	22.8
GC Onshore		59646	21.6	212427	35.3	6514	34.8	7227	32.6
Central Plains (onshore)	OK,AR,CO,MO,NM,WY,KS	80924	29.3	199103	33.1	5424	29.0	5672	25.6
Pacific and Mountain Total	UT,CA,AK	2266	0.8	46722	7.8	984	5.3	3392	15.3
PM Offshore ^c		65	0.0	2040	0.3	186	1.0	279	1.3
PM Onshore		2201	0.8	44682	7.4	798	4.3	3113	14.1
Atlantic and Great Lakes (onshore)	PA,MI,OH,WV	129157	46.8	138805	23.0	790	4.2	796	3.6
TOTAL U.S.		276014	100.0%	602197	100.0	18712	100.0%	622132	100.0%

^a Table 3-17, *Gas Facts* ¹¹

^b *Natural Gas Annual* ¹²

^c Table 3-10, *Gas Facts* ¹¹

count. Each region has a unique oil well versus gas well split and a unique production rate per well. Two offshore regions exist to account for the known differences in practices between onshore and offshore production operations. The well and production demographics also support this split, since the offshore regions account for a small portion of the wells (1.5% of the gas wells, 1.2 % of the oil wells), but produce 26.1 % of the U.S. marketed gas production.

As shown in Table 5-4, the majority of natural gas produced in the United States (more than 64% of total production) occurs in the Gulf Coast region. Other regions only account for 36% of the production, and the majority of that occurs in the Central Plains region. However, the split on well count is completely different. The Atlantic and Great Lakes region, which accounts for only 3.8% of the gross national gas production, has the largest portion of gas wells (46% of the national total) as well as a large fraction of oil wells (24%).

If the source being evaluated is wells or equipment associated with wells (such as separators and chemical injection pumps), then bias would potentially be introduced if only wells in the Gulf Coast region were sampled, where most of the gas is produced. The sources should be combined regionally, and the regional averages then added in the same proportion that they are distributed in the actual population.

The site data used to develop production activity factors are presented in Tables 5-5 through 5-10.

Activity Factors Developed for Processing Sources

Activity factors in gas processing are significantly simpler than in gas production, since the segment consists of one type of facility: gas processing plants. Major activity factors were limited to the count of gas plants (and gas plant type), the count of dehydrators, the count of acid gas recovery units (AGRs), and compressor data. All of these

TABLE 5-5. PRODUCTION SITE SUMMARY

Region	Offshore	GC	CP	PM	AGL	Total US
Site	6	9	7	9	19	50 sites*
Companies	4	7	7	4	10	32 companies
Survey Type						
- Site Visit	1	9	3	9	2	24 site visits
- Phone Survey	5	0	4	0	5	14 phone
- Star Site Visit*	0	0	0	0	12	surveys 12 star sites*

*This does not include all sites visited by Star or other fugitive emissions contractors. Only the sites used for activity factor data collection are included.

TABLE 5-6. DATA FOR OFFSHORE DATA PRODUCTION SITES

Region	GC-Off GC-Off GC-Off GC-Off PM-Off PM-Off						Total Offshore	Totals		Equipment/ Total Wells		Equipment/ Gas Wells		Equip./Mkt. Gas (1/MMcfd)		Equip.Prod. Gas (1/MMcfd)	
	1	2	3	4	5	6		GC	PM	GC	PM	GC	PM	GC	PM	GC	PM
Site	1	2	3	4	5	6	6 Sites 4 Companies										
Company	1	2	2	2	3	4											
Survey Type	V	P	P	P	P	P											
Gas Marketed (MMcfd)	0.365	12.5	440	4	17.5	160		456.9	177.5	1.66	5.22						
Gas Produced (MMcfd)	0.5	12.5	440	4	17.5	160		457.0	177.5	1.66	5.22						
Equipment Counts:																	
Gas Wells	2	0	80	0	0	12		82	12								
Oil Wells	3	150	0	40	22	0		193	22								
+ Oil wells that market gas	3	150	0	40	22	0		193	22								
Separators	4	0	24	0	0	1		28	1	0.10	0.03	0.34	0.08	0.06	0.01	0.06	0.01
In-line Heaters	0	0	0	0	2	0		0	2	0.00	0.06	0.00	0.00	0.00	0.01	0.00	0.01
Pneumatic Devices	3	0	32	0	0	0		35	0	0.13	0.00	0.43	0.00	0.08	0.00	0.08	0.00
Chem Inj Pumps	0	0	0	0	0	0				0.00	0.00	0.00	0.00	0.00	0.00	0.00	0.00
Compressors*	0	-	-	-	-	2		0	2	0.00	0.17	0.00	0.17	0.00	0.01	0.00	0.01
Dehydrators	1	0	8	1	2	3		10	5	0.04	0.15	0.11	0.25	0.02	0.03	0.02	0.03
+ Dehy with 3 pH Flash	1							1	0								
+ Dehy with Vent Control	0							0	0								
+ Dehy w/Kimray Pumps	1							0	0								
+ Dehy w/Stripping Gas	0							1	0								
Miles of Gathering Pipeline	-	-	-	-	-	-		0	0								
Fugitive Component count	Y	N	N	N	N	N											
Vented (Site Blow & Purge Data)	Y	Y	Y	Y	Y	Y											

- Notes: 1) Survey Type V = Site Visit (Radian); P = Phone Survey; S = Site Visit (Star)
 2) * = Gas lift compressors not included.
 3) Y = Yes, N = No; "-" = No Data;
 4) Region Key: GC = Gulf Coast, PM = Pacific Mountain; CP = Central Plains; A = Atlantic & Great Lakes

TABLE 5-7. DATA FOR GULF COAST ONSHORE PRODUCTION SITES

Region	GC	GC	GC	GC	GC	GC	GC	GC	GC	Total GC					
Site	7	8	9	10	11	12	13	14	15						
Company	5	6	7	8	9	10	11	11	11	9 Sites					
Survey Type	V	V	V	V	V	V	V	V	V	7 Companies	Total	Equip./ Total Wells	Equip./ Gas Wells	Equip./ Mkt. Gas (1/MMcfd)	Equip./ Prod. Gas (1/MMcfd)
Gas Marketed (MMcfd)	23.1	25.5	124	54	28	250	1.9	7	130		643.4	0.54			
Gas Produced (MMcfd)	23.1	25.5	124	54	28	250	1.9	7	130		643.4	0.54			
Equipment Counts:															
Gas Wells	13	80	18	130	26	300	0	10	31		608				
Oil Wells	50	0	3	3	0	300	155	127	0		638				
+ Oil wells that market gas	50	0	3	3	0	300	155	68	0		579				
Separators	38	80	42	71	26	300	0	11	31		599	0.50	0.99	0.93	0.93
In-line Heaters	2	56	17	23	26	0	0	12	0		136	0.11	0.22	0.21	0.21
Pneumatic Devices	68	170	0	68	109	225	0	11	31		682	0.57	1.12	1.06	1.06
Chem Inj Pumps	10	5	0	5	0	0	0	0	0		20	0.02	0.03	0.03	0.03
Compressors*	12	4	2	37	0	0	0	15	10		80	0.07	0.13	0.12	0.12
Dehydrators	7	2	2	12	26	2	0	4	26		81	0.07	0.13	0.13	0.13
+ Dehy with 3 pH Flash	0	0	2	2	0	0	0	4	0		8				
+ Dehy with Vent Control	4	0	2	0	0	0	0	0	0		6				
+ Dehy w/Kimray Pumps	7	1	1	6	26	2	0	0	26		69				
+ Dehy w/Stripping Gas	0	0	0	0	0	0	0	0	0		0				
Miles of Gathering Pipeline	-	46.3	26.4	40	8	-	-	-	-						
Fugitive Component count	Y	Y	Y	Y	Y	Y	-	-	-						
Vented (Site Blow & Purge Data)	Y	Y	Y	Y	Y	Y	Y	Y	Y						

- Notes: 1) Survey Type V = Site Visit (Radial); P = Phone Survey; S = Site Visit (Star)
 2) * = Gas lift compressors not included.
 3) Y = Yes, N = No; "-" = No Data;
 4) Region Key: GC = Gulf Coast, PM = Pacific Mountain; CP = Central Plains; A = Atlantic & Great Lakes

TABLE 5-8. DATA FOR CENTRAL PLAINS PRODUCTION SITES

Region	CP	CP	CP	CP	CP	CP	CP	Total CP					
Site	16	17	18	19	20	21	22						
Company	12	13	14	15	16	17	18	7 Sites					
Survey Type	V	V	V	P	P	P	P	7 Companies	Total	Equip./ Total Wells	Equip./ Gas Wells	Equip./ Mkt. Gas (1/MMcfd)	Equip./ Prod. Gas (1/MMcfd)
Gas Marketed (MMcfd)	42.7	180	196	7	0.2	19.8	2		447.7	0.22			
Gas Produced (MMcfd)	42.7	180	196	7	0.2	20	2.1		448.0	0.22			
Equipment Counts:													
Gas Wells	138	321	1000	400	1	100	15		1975				
Oil Wells	55	11	0	0	0	0	4		70				
+Oil wells that market gas	55	11	0	0	0	0	4		70				
Separators	130	321	7	400	1	100	1		960	0.47	0.49	2.14	2.14
In-line Heaters	138	321	0	400	0	0	0		859	0.42	0.43	1.92	1.92
Pneumatic Devices	449	963	667			100	0		2179	1.33	1.38	4.95	4.94
Chem Inj Pumps	28	273	0	13	0	0	0		314	0.15	0.16	0.70	0.70
Compressors*	31	50	64				1		146	0.09	0.10	0.35	0.35
Dehydrators	16	220	0	400	0	25	1		662	0.32	0.34	1.48	1.48
+Dehy with 3 pH Flash	0	0	0			0	-		0				
+Dehy with Vent Control	0	0	0			-	-		0				
+Dehy w/Kimray Pumps	16	220	0			25	0		261				
+Dehy w/Stripping Gas	0	0	0			-	-		0				
Miles of Gathering Pipeline	5.2	-	600	-	-	-	-		0				
Fugitive Component count	Y	Y	Y	-	-	-	-						
Vented (Site Blow & Purge Data)	Y	Y	Y										

- Notes: 1) Survey Type V = Site Visit (Radian); P = Phone Survey; S = Site Visit (Star)
 2) * = Gas lift compressors not included.
 3) Y = Yes, N = No; "-" = No Data;
 4) Region Key: GC = Gulf Coast, PM = Pacific Mountain; CP = Central Plains; A = Atlantic & Great Lakes

TABLE 5-9. DATA FOR PACIFIC/MOUNTAIN PRODUCTION SITES

Region	PM	PM	PM	PM	PM	PM	PM	PM	PM	Total PM					
Site	23	24	25	26	27	28	29	30	31						
Company	19	20	21	21	21	21	22	21	21	9 Sites					
Survey Type	V	V	V	V	V	V	V	V	V	4 Companies	Total	Equip./ Total Wells	Equip./ Gas Wells	Equip./ Mkt. Gas (1/MMcfd)	Equip./ Prod. Gas (1/MMcfd)
Gas Marketed (MMcfd)	4	104	0.138	0.03	0.02	0.035	0.8	0.1	11.082		120.2	0.12			
Gas Produced (MMcfd)	4	307	0.138	0.03	0.02	0.035	0.8	0.1	11.082		323.2	0.32			
Equipment Counts:															
Gas Wells	53	0	0	0	0	0	0	0	0		53				
Oil Wells	0	913	18	8	10	15	20	7	728		1719				
+Oil wells that market gas	0	137	18	8	10	15	20	7	728		943				
Separators	45	0	0	0	0	0	0	0	0		45	0.17	0.85	0.41	0.14
In-line Heaters	53	5	3	2	0	0	0	0	0		63	0.24	1.00	0.58	0.20
Pneumatic Devices	80	0	0	0	0	0	0	0	0		80	0.08	1.51	0.67	0.25
Chem Inj Pumps	36	0	0	0	0	0	0	0	0		36	0.04	0.68	0.30	0.11
Compressors*	17	19	0	0	0	0	1	1	1		38	0.14	0.32	0.35	0.12
Dehydrators	5	0	0	0	0	0	1	0	0		6	0.02	0.09	0.05	0.02
+Dehy with 3 pH Flash	0	0									0				
+Dehy with Vent Control	0	0									0				
+Dehy w/Kimray Pumps	5	0					1				6				
+Dehy w/Stripping Gas	0	0					0				0				
Miles of Gathering Pipeline	-	-	-	-	-	-	-	-	-		0				
Fugitive Component count	Y	Y	N	N	N	N	N	N	N						
Vented (Site Blow & Purge Data)	Y	Y	N	N	N	N	N	N	N						

- Notes: 1) Survey Type V = Site Visit (Radian); P = Phone Survey; S = Site Visit (Star)
 2) * = Gas lift compressors not included.
 3) Y = Yes, N = No; "-" = No Data;
 4) Region Key: GC = Gulf Coast, PM = Pacific Mountain; CP = Central Plains; A = Atlantic & Great Lakes

TABLE 5-10. DATA FOR ATLANTIC & GREAT LAKES PRODUCTION SITES

Region	AGL	AGL	AGL	AGL	AGL	AGL	AGL	AGL	AGL
Site	32	33	34	35	36	37	38	39	40
Company	23	24	25	26	27	28	29	30	30
Survey Type	V	P	P	V	P	P	P	S	S
Gas Marketed (MMcfd)	24	6	15	17	12	16	81	0.18	0.18
Gas Throughput (MMcfd)	24	6	15	17	12	20	81	0.19	0.19
Oil Throughput (1000 B/D)	0								
Equipment Counts:									
Gas Wells	800	250	1000	520	450	1582	4034	11	11
Oil Wells	0	0	0	0	163	418	0	0	0
+Oil wells that market gas	0	0	0		163	418	0	0	0
Separators	151	250	500	520	450	1582	3227	-	2
In-line Heaters	0								0
Pneumatic Devices	76	0	10	520	450	1582	1294	-	-
Chem Inj Pumps	0	0	0	12	0	8	25	Y	0
Compressors*	1	-	-	-	-	-	-	-	0
Dehydrators	0	2	1	30	0	0	41	-	-
+Dehy with 3 pH Flash	0	0	0	0			5		
+Dehy with Vent Control	0			3			2		
+Dehy w/Kimray Pumps	0	2	1	30			8	0	
+Dehy w/Stripping Gas	0						21	0	
Miles of Gathering Pipeline	-	-	-	-	-	-	-	-	-
Fugitive Component count	Y	N	N	N	Y	Y	Y	-	-
Vented (Site Blow & Purge Data)	-	-	Y	Y	-	-	-	-	Y

- Notes: 1) Survey Type V = Site Visit (Radian); P = Phone Survey; S = Site Visit (Star)
 2) * = Gas lift compressors not included.
 3) Y = Yes, N = No; "-" = No Data;
 4) Region Key: GC = Gulf Coast, PM = Pacific Mountain; CP = Central Plains; A = Atlantic & Great Lakes

(Continued)

TABLE 5-10. (Continued)

Region	AGL	AGL	AGL	AGL	AGL	AGL	AGL	AGL	AGL	AGL	Total AGL					
Site	41	42	43	44	45	46	47	48	49	50						
Company	30	31	31	31	31	31	31	31	31	31	19 Sites	Total	Equip./	Equip./	Equip./	Equip./
Survey Type	S	S	S	S	S	S	S	S	S	S	10 Companies	(Sites 32-50)	Total Wells	Gas Wells	Mkt. Gas	Prod. Gas
															(1/MMcfd)	(1/MMcfd)
Gas Marketed (MMcfd)	0.17	0.39	0.37	0.37	0.18	0.23	0.30	0.35	0.13	0.35		173.6				
Gas Throughput (MMcfd)	0.17	0.39	0.37	0.37	0.19	0.23	0.30	0.35	0.13	0.35		178.0				
Oil Throughput (1000 B/D)																
Equipment Counts:																
Gas Wells	10	23	22	22	11	14	18	21	8	21		8828				
Oil Wells	0	0	0	0	0	0	0	0	0	0		581				
+ Oil wells that market gas	0	0	0	0	0	0	0	0	0	0		581				
Separators	0	10	7	8	5	3	15	17	5	7		6766	0.72	0.77	38.97	38.01
In-line Heaters	0	0	0	0	1	1	0	0	0	0		2	0.00	0.00	0.07	0.07
Pneumatic Devices	-	-	-	-	-	-	-	-	-	-		3932	0.43	0.46	23.07	22.50
Chem Inj Pumps	0	0	0	0	0	0	0	0	0	0		45	0.00	0.01	0.26	0.25
Compressors*	0	0	0	0	0	0	0	0	0	0		1	0.00	0.00	0.04	0.04
Dehydrators	-	-	-	-	-	-	-	-	-	-		74	0.01	0.01	0.43	0.42
+ Dehy with 3 pH Flash												5				
+ Dehy with Vent Control												5				
+ Dehy w/Kimray Pumps												41				
+ Dehy w/Stripping Gas												21				
Miles of Gathering Pipeline	-	-	-	-	-	-	-	-	-	-						
Fugitive Component count	Y	Y	Y	Y	Y	Y	Y	Y	Y	Y						
Vented (Site Blow & Purge Data)	-	-	-	-	-	-	-	-	-	-						

- Notes: 1) Survey Type V = Site Visit (Radian); P = Phone Survey; S = Site Visit (Star)
 2) * = Gas lift compressors not included.
 3) Y = Yes, N = No; *- = No Data;
 4) Region Key: GC = Gulf Coast, PM = Pacific Mountain; CP = Central Plains; A = Atlantic & Great Lakes

activity factors were either published and well-defined or were developed through other studies such as the report by Wright Killen & Co.¹³ or Volume 11 on compressor driver exhaust.¹⁴ The site data used to developed processing activity factors are presented in Table 5-11.

Activity Factors Developed for Transmission Sources

Activity factors for the transmission segment were simpler than production segment factors. The transmission segment is definitely more homogeneous than the production segment. Transmission facilities are either surface compressor stations, surface metering and regulating stations, buried pipelines, or underground storage. Most transmission pipelines are one of two types: interstate (cross-country) or intrastate (strictly regional). Therefore, transmission company data can be extrapolated by using pipeline miles, station count, or storage facility count.

The total number of compressor stations was extrapolated from data on major transmission companies listed in *Gas Facts*.¹¹ The total miles of transmission pipeline and the number of storage facilities and storage wells is also published. Counts of transmission metering stations by type were produced by extrapolating data from Radian's company surveys of several transmission companies. Other transmission activity factors were developed from Radian site visits to transmission facilities. The site data used to develop the transmission activity factors is presented in Tables 5-12 and 5-13.

Activity Factors Developed for Distribution Sources

In the distribution segment, activity factors were developed for total number of leaks in underground mains and services. These activity factors were desegregated by pipe service (i.e., mains versus services) and pipe material (i.e., cast iron, cathodically protected steel, unprotected steel, plastic, and copper). The estimates of total leaks for each company

TABLE 5-11. GAS PROCESSING PLANTS

Site	1	2	3	4	5	6	7	8	9	10	11	Total 11 Sites
Companies	1	1	2	3	3	4	5	5	5	6	7	7 companies
Type	Cryo	Cryo	Cryo	Lean Oil Abs., Cryo	Cryo	Cryo	Lean Oil Abs.	Refrig.	Refrig.	Refrig./ Lean Oil Abs.		
Capacity (MMscfd)	100	75	70	850	900		40	130	130	140		
Current Throughput (MMscfd)	49	60	56	350	750	140	40	130	130	70		
Compr. Units	7	4	6**	9	1	0***	4.4**	1.4**	1.4**	20	19	72
- Turb. Eng	0	0	0	2	1	1	0	0	0	5	2	10
- Recip. Eng	7	4	6**	7	0	0	4.4**	1.4**	1.4**	15	17	62
- Total HP	11000	3700	6740**	43300	27000	20000	5925**	6267**	6267**	59600		189799
Dehys	0	1	2	3	0	0	1	1	1	1		10
Dehys w/Kimray Pumps		1	0	0			0	0	0			1
Pneum Ongas	2	3	0	25	25	17	0	0	0	0		72
Vented Data												
- Site	Y	Y	Y	Y	-	Y				Y	Y	
- Company	-	-	-	-	-	Y	-	-	-	-	-	
Fugitive CC	639	357	799	1458	-	-	6831	5902	5902	-	Y*	

* Count only of compressor BD OELs, site OELs, and Compressor PRVs.

** Gas lift compressors not counted in the totals for this site with gas lift for oil recovery.

*** 1 turbine drives 2 propane compressors. No NG compressors.

"Y" = Yes

TABLE 5-12. TRANSMISSION COMPRESSOR STATIONS

Site Number	1	2	3	4	5	6	7	8	9	10	11
Company Number	1	1	1	2	2	2	3	3	4	4	4
Compr. Units	13	2	2	6	7	13	12	13	2	10	6
- Turb. Eng	0	2	2	0	0	0	2	1	2****	3	2
- Recip. Eng	13	0	0	6	7	13	10	12	0	7	4***
- Total HP	32650	6900	6900	16900	10400	24800	14560	17570	40000	-	-
Dehydrators	0	0	0	0	1	-	0	0	6	0	0
- Flash Tanks					1				6		
- Kimray Pumps					0				6		
- Stripping Gas					0				0		
- Vapor Recovery					0				0		
- Vent Flash Gas											
Pneum	48	12	-	8	-	20	75	40	68	83	50
Wells	Not Applicable										
Fugitive CC	741**	223**	165**	-	-	-	3038	3949	1730	1467	956
Site B/D Practices	Y	Y	-	Y	Y	-	-	-	Y	Y	Y
Co. B/D No's	-	-	-	Y	Y	Y	-	-	-	-	-

(Continued)

TABLE 5-12. (Continued)

Site Number	12	13	14	15	16	17	18	19	20	21	21 Sites
Company Number	5	6	6	7	8	8	9	9	10	10	10 Co's
Compr. Units	18	2	2	26	5	3	7	13	7	2	171
- Turb. Eng	0	2	2	1	1	0	0	3	0	2	25
- Recip. Eng	18	0	0	25	4	3	6	10	7	0	145
- Total HP	21000	-	-	-	-	-	-	-	-	-	191,680
Dehydrators	1	0	0	0	0	0	0	0	-	-	8
- Flash Tanks	1										
- Kimray Pumps	0										
- Stripping Gas	0										
- Vapor Recovery	0										
- Vent Flash Gas											
Pneum	3						38			0	
Wells	Not Applicable										
Fugitive CC	1123	134	284	1706	345	12	508	792	-	-	
Site B.D Practices	Y	-	-	Y	-	-	Y	-	Y	Y	
Co. B/D No's	-	-	-	-	-	-	-	-	-	-	

Fug cc does not include connections or tubing

* = Elec driven compressors

** = Not including hydraulic valves

*** = Recip Engine w/Centrifugal Compressor

**** = Does not include third turbine that was permanently out-of-service

"_" means no data available, "Y" = Yes

TABLE 5-13. STORAGE COMPRESSOR STATIONS

Site	1	2	3	4	5	6	7	8	Total 8 Sites
Companies	1	2	3	4	5	6	7	7	7 Co's
Type	UG	UG	UG	UG	LNG	UG	UG	UG	
Compr. Units	3	2	2	4	5*	18	9	9	52
- Turb. Eng	0	0	0	2*	0	4	0	0	6
- Recip. Eng	3	2	2	2	0	14	9	9	41
- Total HP	6250	2200	9400	7000	10300*	48510	9000	11600	104260
Dehydrators	4	1	1	8	0	1	-	-	
- Flash Tanks			1	8		1			
- Kimray Pumps			0	0		0			
- Stripping Gas			0	0		1			
- Vapor Recovery				0		0			
- Vent Flash Gas			1	0		0			
Pneumatics	18	-	68	127	4	-	-	-	217
Wells	?	50	22	83	0	64	-	-	219
Fugitive CC	1750	-	1113	8326	1679	887	-	-	13700
Vented Data:									
- Site	-	Y	Y	Y	Y	Y	Y	Y	
- Company	-	Y	-	Y	-	-	-	-	

Fug cc does not include connections or tubing

* = Elec driven compressors

** = Not including hydraulic valves

*** = Recip Engine w/Centrifugal Compressor

"-" means no data available, "Y" = Yes

UG = Underground Storage Station

LNG = Above ground, Liquefied Natural Gas Station

were based on historical leak records and the average leak per mile (or per service) extrapolated by the total national mileage (or number of services).

For metering/pressure regulating stations, the number of stations was collected from each company and extrapolated by the total miles of distribution mains. Other activity factors used in the distribution segment were based on well-defined activity data, such as total mileage of mains/services and throughput.

6.0

SAMPLING AND STATISTICAL ACCURACY

A key part of this project was the estimation of the accuracy of the overall emission rate. This section explains the techniques used during sampling to maximize precision and eliminate bias. The general approach used for statistical accuracy calculations is also discussed.

Accuracy is made up of precision and bias. Precision can be calculated from a set of replicate measurements. Bias cannot be calculated, and must be discovered and eliminated where possible. Figure 6-1 illustrates the role of random and bias errors in the estimation process. In each of the four illustrations in this figure, the center of the concentric circles represents the correct answer. In the upper left, there is a significant amount of random scatter in the points. The term "precision" refers to random variability alone; in this case, the precision is poor. Additionally, the points are predominantly below and to the right of the target. The *systematic* difference between the points and correct answer is a bias. The term "accuracy" refers to the total error, including random and bias errors. Because of the large bias and the poor precision, the accuracy is also poor.

In the upper right of Figure 6-1, the points are randomly scattered about the correct answer; there is little or no bias in this case, but the precision and accuracy are both poor. In the lower left, there is good precision, but there is again a large bias; thus, the accuracy is poor. In the lower right, the bias is small and the precision is also good. Thus, the accuracy is good in this case.

The following subsections discuss the approaches used in sampling to handle precision, bias, accuracy targets, and overall accuracy calculations.

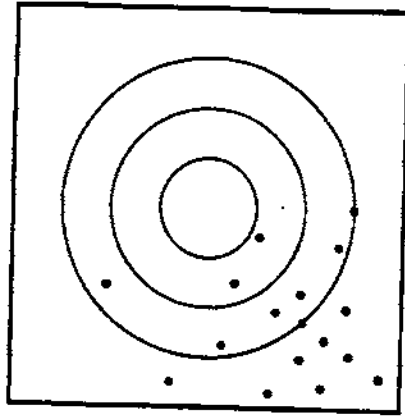

High Bias + Low Precision
= Low Accuracy

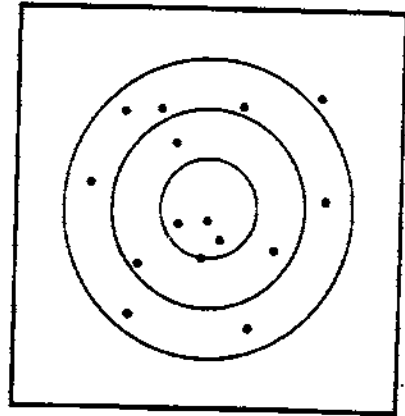

Low Bias + Low Precision
= Low Accuracy

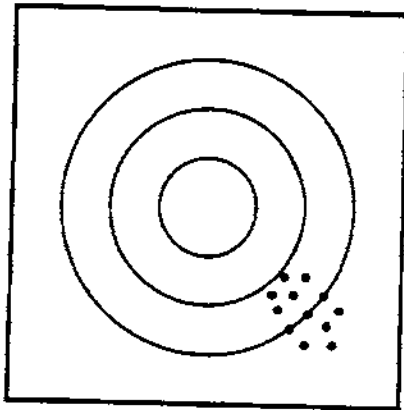

High Bias + High Precision
= Low Accuracy

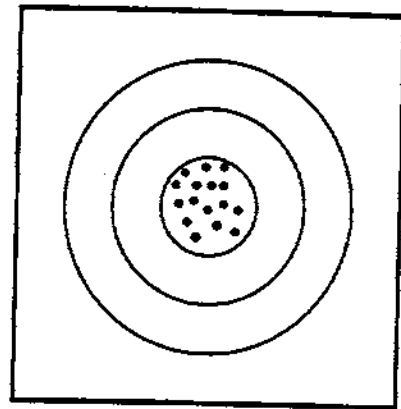

Low Bias + High Precision
= High Accuracy

Figure 6-1. Illustration of Random and Bias Errors

6.1 Sampling Approach

In general, a sampling program should gather enough replicate samples to meet the precision target. If the sample-to-sample variability is high, then more samples may need to be taken to reach the desired precision target. Even if the overall precision of an estimate is acceptable because the variability in the data is relatively low, the overall accuracy may still be poor if the data are biased.

Sampling bias occurs if the methodology is flawed in a manner that leads to a systematic under-representation of parts of the population and a systematic over-representation of other parts. Bias, in a statistical sense, can be explained as follows. Suppose it was possible to repeat the sampling and measurement process infinite times, and that each time the process was repeated, an independent estimate of a given emission factor was obtained. If the average of the entire infinite set of emission factor estimates equalled the true value, then bias would not exist. If the average of these estimates differed from the true value, then the process would be wrong in a systematic sense, and bias would be said to exist. The point here is that averaging an infinite set of independent estimates of the emission factor would remove random error altogether, leaving only bias error, if any. While it is clearly impossible to obtain an infinite set of estimates of an emission factor, the example given serves to illustrate the meaning of bias.

Even if there was no bias, the actual estimate of an emission factor would be expected to differ from the true value. First, the estimate is based on less than the total number of sources. Random differences between the set of sampled sources and the population of sources introduce a sampling error. Second, physical measurements have uncertainties. As is indicated above, the term "accuracy" refers to the closeness of an estimate of a quantity to the true value. Accuracy is a measure of random error plus bias error. The term "precision" refers to random error alone.

An estimate is precise if it has a small random error, regardless of the bias. Suppose, for example, that sources had been selected only from the Gulf Coast, but that a very large number of sources had been sampled. The averaging of a large number of emission measurements would lead to an emission factor estimate that had a small random error. Unless Gulf Coast sources were representative of the source type for the entire nation, however, the estimate could have a large bias because the sample of sources did not represent the general population. Bias in this example is avoided by sampling in a variety of regions of the country. More subtle potential sources of sampling bias and methods for avoiding them are discussed in this subsection.

Several sampling approaches can be applied to avoid bias.

Random Sampling

In random sampling, each source in the population has an equal probability of being selected. A random sample is expected to "match" the industry population because no biases are introduced in selecting the sample sites. The number of data points required in a random sample depends on the target accuracy of the final emissions estimate, the confidence with which this accuracy is to be met, and the underlying variability among the emissions rates of the complete set of sources.

Random sampling is not a guarantee of accurate results. It is possible, for example, that by pure chance random sampling would produce a disproportionately large number of sources from the Gulf Coast and an under-representation of sources from the West Coast. While such an outcome is unlikely if the sample size is sufficiently large, this particular problem can be avoided altogether by selecting an acceptable number of sources from each of a set of regions. (See the discussion of stratified random sampling below.)

There are two major reasons why truly random sampling was not possible in the GRI/EPA program. First, a complete list of sources did not exist and still does not

exist. It was possible, for example, to list all compressor stations whose owners were GRI members. While this might account for 90% of the compressor stations, the list was not complete. Another example is the production segment, where it was not possible to produce a list of all the individual well owners for random selection. The second point is that the owners of the randomly selected sources could not be required to participate in the study. For this reason, there is no guarantee that a truly random sample of the available list could be tested.

Stratified Random Sampling

In stratified random sampling, the population of interest is divided into subsets, or strata. Then random samples are drawn from each stratum. For example, the sources of interest in this program could be stratified by geographical region, and random sampling could be applied within each region.

Stratified random sampling can be performed proportionately or disproportionately. In proportionate stratified random sampling, the number of sources sampled in a stratum is in proportion to the total number of sources in that stratum. For example, if Region A had twice as many sources as Region B, then the sample would include twice as many sources from Region A as from Region B. From an intuitive point of view, then, a proportionate stratified random sample "matches" the population, at least with respect to the criteria used to specify the stratification.

Proportionate stratified random sampling can be used to address the issue of regional differences, but only if applied properly. In the paragraph above, it is suggested that sources could be sampled in proportion to the total number of sources by region. Alternatively, proportionality could be achieved on the basis of gas production, rather than on the basis of the number of sources. The variable or variables used to achieve proportionality must be closely related to emissions or proportionate random sampling could lead to biased results.

It is common in practice, however, to sample in such a way that the sample size for a stratum is not in proportion to the total number of sources in the stratum (and the throughput of the sampled sources is not proportional to total throughput in the stratum). This type of sample is called a "disproportionate stratified random sample." This type of sample does not "match" the population in the sense described above. As long as the disproportionality is accounted for in computing the final statistics (e.g., mean emission rate by source or total emissions), disproportionate sampling will not cause bias in the final results.

Stratified sampling can lead to increased accuracy for the total sample size if there is less variability within any given stratum than there is in the total population. Similarly, a smaller sample size might suffice to meet the target accuracy if stratified random sampling were used rather than random sampling.

Neither type of stratified random sampling was feasible in this study. The obstacles to random sampling, discussed earlier in this section, were also obstacles to random sampling within strata.

Further, at the outset of the program, it was not known which variables were related to emissions; thus, it was not known which variables should be used as a basis for stratification. If stratification had been performed on the basis of all variables that could possibly have an influence on emissions, the number of strata (determined by the number of variables and the number of categories for each variable) could have become unreasonably large. For example, for leakage from underground distribution mains and services, a number of parameters were identified that potentially influence emissions: pipe material, age, operating pressure, diameter, soil type, and parameters characterizing the leak detection and repair practices of the company. The required sample size can become large because of the total number of strata, especially if proportional stratified random sampling is used. One company has embarked upon an independent program to quantify leakage from underground mains and services using a proportional sampling approach. Even within this

single company, hundreds of samples were required to produce a proportionate stratified random sample for underground pipelines.

Additionally, stratified sampling is of no use unless there are activity factors that can be used to estimate the emission rate for the population. Complete information for all variables of potential interest does not exist. For example, the age of a dehydrator, in most cases, is not even known by the owner of the equipment. It would be pointless to stratify dehydrator emission factors with respect to age if the necessary activity factors cannot be obtained.

Sampling Approach Selected for This Program

Thus, because of various practical limitations, neither random sampling nor stratified random sampling was perfectly feasible in this study. For this reason, an alternate approach was used. While this approach is not a textbook sampling method, it is believed to be very effective for the specific needs of this project. This approach is very similar to disproportionate stratified random sampling, with certain differences.

Initially, some data were collected to determine if a given source was a major contributor to methane emissions. For each source category, an initial estimate of the number of sources to be sampled was calculated based on an estimate of the accuracy target and the estimated standard deviation for the source category. The accuracy targets are based on the need ultimately to estimate the national emission rate to within 0.5% of the national production rate based on a 90% confidence limit. Sites were selected in a random fashion from known lists of facilities, such as GRI or American Gas Association (A.G.A.) member companies. However, the companies contacted were not required to participate, and a complete list of all sources in the United States was generally not available. Therefore, the final set of companies selected for sampling was not truly random. Each company that agreed to participate in the program was asked to select representative sites for sampling, rather than one-of-a-kind facilities.

After a limited set of data was collected, the data were screened for bias by evaluating the relationship between emission rate and parameters that may affect emissions. The topic of screening for bias is discussed further in Sections 6.2 and 6.3. If a relationship between emissions and a parameter was found, then the population, or the number of sources in the industry, was stratified by that parameter. For example, station type was found to influence the emission rates from metering and pressure regulating stations, so the number of stations under each station type in the nation was determined. To stratify the population of sources by a parameter, data were collected from companies on the distribution of sources in each stratum and an average over all companies sampled was determined.

It is important to realize that just because a parameter or set of strata is identified that has a large effect on the emissions from a given source category, it does not mean that there is bias in the data. A second condition is necessary. The condition is that the sampling procedure would have to produce a disproportionate number of samples in the strata. To determine whether this has occurred, information is needed on the ratio of the number of sources in a given stratum to the total number of sources for both the data set and at the national level. If this known national ratio is different from the ratio for the sample data set, then there may be bias. But this bias can be eliminated by applying the correct emission factors and activity factors for the different strata.

Once the strata were identified, the precision of the emission rate extrapolated to a national basis was evaluated and compared to the accuracy target. (Note: The accuracy target is a function of the magnitude of the emissions from the source.) Where necessary, additional data were collected in various strata to improve the precision of the national estimate of emissions from the source. The number of additional data points needed to meet the newly calculated accuracy target is computed based on the standard deviation and a 90% confidence interval.

Screening For Bias in Activity Factors

It is impossible to technically prove that there is no bias in any dataset. While tests can be designed that are capable of revealing some bias, there are no tests nor group of tests that would reveal all possible biases. Assuming that any dataset has no bias, even after extensive testing, is only a theory. Such theories can be disproved, but not proved. The following examples in this section show some of the many bias tests used in this project.

The sample sets were tested for bias by continuous technical and industry review. Numerous individual reviews and project advisor's meetings were used to review the project data with knowledgeable industry experts, so that systematic errors could be discovered and eliminated. When possible biases in the activity factor sampling plan or extrapolation method were theorized, the project was altered to test for that bias and eliminate it if it existed. All provable biases were corrected.

One example of the success of this bias review process includes the identification of regional differences in production practices. These differences were brought up by the advisor's meeting review process. The differences were then accounted for by stratifying the production data into two offshore and four onshore regions, sampling within each region, and extrapolating by region.

Another example of activity factor screening bias includes extrapolation by two methods that validate each other. If both methods are technically sound and independent, and if they deliver the same result for national totals, then this indicates that there is no bias in the data set related to either variable. If a data set existed that was the perfect microcosm of the gas industry, one could extrapolate equipment counts from the data set to national totals by any variable in the data set. Any extrapolation from the perfect microcosm would deliver the right answer, even technically unrelated data such as extrapolating separator count by number of employees at the site.

Therefore, for an imperfect data set, which all data sets are, extrapolation by two variables allows for a cross check. For example, production activity factors could be extrapolated by two nationally known extrapolation parameters: well count and production rate. It was possible that the extrapolated variable is actually technically related to one variable more than the other, or that the sample set had some bias related to one or both variables. Nevertheless, if the extrapolation by well count produces the same value as the extrapolation by production rate, then the methods tend to validate one another. This also indicates that there is no bias made in selecting the extrapolation technique, nor between the relations of the two extrapolation variables in the data set.

If the two methods produced results which differed widely, that might indicate that one or the other method has a bias. In fact, as mentioned in Volume 5 on activity factors,¹ there was a tendency for the well method to be high-biased and for the production method to be low-biased. Therefore, the average of the two techniques should minimize the bias.

6.3 Screening for Bias in Emissions Factors

Screening for bias can be accomplished by identifying design, operational, and regional parameters that may cause differences in emissions across a source type and then analyzing the data to determine whether there is an established relationship between those parameters and the emission rate. Usually, these parameters are chosen on the basis of industry expertise and/or engineering judgement. If these parameters are determined to exhibit statistically different emission characteristics, then the population of sources is stratified into distinct categories by these design, operational, or regional parameters. Emission factors and activity factors are determined for each category within the source type to uniquely characterize emissions.

Metering/pressure regulating stations provide an example where the process of screening for bias was beneficial. Table 6-1 shows the average measured emission factor

for metering/pressure regulating stations, in units of scf/station-hour, based on 86 measurements which were performed in 19 cities in the United States. The activity factor was also derived from data provided by the distribution companies participating in the study, which was scaled to a national estimate of metering/pressure regulating stations. Assuming that the sample selection was random or representative, the extrapolated emissions are 104.1 Bscf, based on the average of all measurements to estimate the emission factor. However, if the data is subdivided, or stratified, by station type (i.e., metering/pressure regulating versus pressure regulating), then the estimated emissions from this source type decrease to 73.7 Bscf. Furthermore, if this source type is further subdivided into discrete operating pressure ranges and by enclosure status, the emissions decrease to 27.3 Bscf. As illustrated, the bias, which was caused by testing a disproportionate number of high pressure stations, can be minimized by stratifying the emission and activity factors.

The previous example also illustrates that it is equally as important to accurately stratify the activity factor samples as the emission factor samples. In some cases, the activity factor can only be stratified to the necessary level of disaggregation by gathering data from industry.

Even if a process does not produce a bias in the statistical sense described above, it is possible for a given segment of the population to be seriously under represented and another segment to be over represented by random chance (i.e., by an anomaly in the random selection of sources). The error that results is a larger than expected random error; an error from a correct sampling and measurement process is not a bias.

TABLE 6-1. ESTIMATED METHANE EMISSIONS FROM DISTRIBUTION METERING AND PRESSURE REGULATING STATIONS

Category	Location (vault or above-ground)	Emission Factor (scf/station-hr)	Activity Factor (number of stations)	Emissions (Bscf)
All Stations	--	90.2	131,799	104.1
M&R Stations	--	154.1	23,922	32.3
Reg. Stations	--	43.7	108,048	41.4
Total	--		131,970	73.7
<u>M&R Stations</u>				
>300 psig	A-G	179.8	3,460	5.45
100-300 psig	A-G	95.6	13,335	11.2
40-100 psig	A-G	4.31	7,127	0.269
<40 psig	A-G	--	0	0
<u>Reg. Stations</u>				
>300 psig	A-G	161.9	3,995	5.67
>300 psig	Vault	1.30	2,346	0.0266
100-300 psig	A-G	40.5	12,273	4.35
100-300 psig	Vault	0.180	5,514	0.0087
40-100 psig	A-G	1.04	36,328	0.332
40-100 psig	Vault	0.0865	32,215	0.0244
<40 psig	Vault	0.133	15,377	0.0179
Total			131,970	27.3

The screening process serves to identify variables that are related to emission characteristics. Then it is possible to determine whether sources are disproportionately sampled in the different strata of these variables. Such a disproportionality need not lead to a bias in the final estimate of emissions, if this condition is identified and accounted for

properly. Moreover, the screening process has been carried out during the course of the study. Thus, additional sampling to correct a disproportionality, if present, is possible.

Note that the screening process would identify unrepresentativeness in the sample, whether the problem resulted from an inadvertent bias in the sampling process or a purely random effect. The protection against both bias and anomalies in the random selection of sources is considered to be a significant benefit of the method used in this study.

6.4 Accuracy Target

The target uncertainty in the emission estimate is 0.5% of the national methane emissions, on the basis of a 90% confidence limit for the emissions estimate. Practical considerations allow sampling only a small percentage of the large number (tens of thousands) of sources that exist nationwide. Moreover, there is typically a large amount of variability among the sources in a given category. In view of these considerations, meeting the accuracy target may seem insurmountable. Despite these facts, the target precision for the industry emission rate was achieved. The purpose of this section is to illustrate, through hypothetical calculations, how large errors in emissions estimates for individual source strata can combine to allow this to occur.

As is discussed in the preceding sections, bias is minimized by randomly selecting sites (although from a limited list), analyzing the data, and creating strata in a systematic way. The estimate of total emissions is the sum of the emissions for all the strata. An essential point is that the uncertainties are not additive; the uncertainty of a sum is related to the sum of squares of the individual uncertainties. If the errors in a sum vary independently, then they tend to "average out"; as a result, the relative uncertainty in a sum of terms (with equal means and variances) is smaller than the relative uncertainty in the individual terms. (Several statistical points made in this paragraph are discussed in further detail later in this subsection.)

The steady emission sources have been split into five major segments. Each segment has two to seven significant source categories, and each source category is divided into 10 to 40 strata. In total, steady sources have been divided into nearly 100 strata. Unsteady or vented sources have been divided into approximately 40 strata. Thus, in all there are approximately 140 strata.

Hypothetical calculations are presented that illustrate the effect of summing the errors in the different strata. For the purposes of the hypothetical calculations, it has been assumed that there are "n" strata with equal emissions and equal uncertainties based on random errors. While it is recognized that both the emission rate and the variability change from stratum to stratum, in actuality, the simplifying assumptions facilitate a calculation that illustrates the effect of summing the emission estimates from a large number of strata.

Also, it has been assumed that undiscovered bias, if any, varies "independently" from stratum to stratum. This type of error would exist if the sources within a stratum were sampled in an unrepresentative manner, resulting in a bias error. Clearly, a systematic bias that was common to a large number of strata would have a more serious effect on the final result. The processes described earlier for screening for bias provide a protection against this (or any type of) bias error. Additionally, given the large number and diversity of strata, it is reasonable to believe that any undetected bias will exhibit a high degree of "independence" among the strata.

Table 6-2 presents the results of the calculations. The random error was chosen to be as large as plus or minus 100% of the emissions for each stratum, based on a 90% confidence interval. This is equivalent to assuming a coefficient of variation of approximately 0.6.

TABLE 6-2. PERCENTAGE OF ERROR IN TOTAL EMISSIONS

Bias (Percent of Emissions)	Number of Strata		
	20 Strata	40 Strata	100 Strata
0%	0.40	0.29	0.18
15%	0.41	0.29	0.18
30%	0.43	0.31	0.19

(Percent random error in a given stratum based upon a 90% confidence interval = 130%)

The bias error is represented as the stratum-to-stratum standard deviation of the biases in the emission estimates; this quantity is presented as a percent of the emissions for a stratum. In the calculations, three values have been considered for the bias: 0%, 15%, and 30%. In view of the methods used for screening for bias, 30% is considered to be a high estimate.

As previously mentioned, the total number of strata is approximately 140. It has been assumed that there are approximately 100 strata with nearly equal emissions that represent the major part of the industry emissions. Some of the strata (such as distribution pipe type) have been aggregated in the final summary table that is presented in Volume 4 on statistical methodology.¹⁰ The summary table includes 86 source categories.

Further calculations were performed assuming 40 and 20 strata, in addition to the case with 100 strata. Given that the parameters discussed above of the random and bias errors are fixed, the relative uncertainty in the final result decreases as the number of strata increases. This is because the "error averaging effect" is greater if a larger number of independent estimated quantities are summed. This does not mean that artificially increasing the number of strata would improve the accuracy. There would be fewer data points per stratum, and the uncertainty of the emission estimate for each stratum would increase.

Table 6-2 presents the percentage of uncertainty in the fugitive emissions as a fraction of the national production rate. The uncertainty is expressed in terms of a 90% confidence interval. Since bias errors were considered as well as random errors, the numbers in Table 6-2 represent accuracy, not just precision.

The accuracy target is met if the percentage error is no greater than 0.5%. Under all scenarios modelled, the uncertainty is less than 0.5%. This is true even in the case in which there are only 20 strata with approximately equal emissions, and the bias is 30%. These calculations, while hypothetical, illustrate the way in which errors combine in a sum and show that meeting the accuracy target is feasible, even in the presence of large percentage random errors in the individual strata and an assumed large undetectable bias error.

It must be remembered that the random and bias errors were expressed as a fraction of the emissions in the strata. For these test calculations, the national emissions were assumed to be approximately 307 Bscf. The accuracy target is expressed as a percentage (0.5%) of the national gas production per year, which is 22,132 Bscf.

It is stated earlier in this subsection that the uncertainty of a sum is related to the sum of squares of the individual uncertainties. The uncertainty of the industry annual emissions have been calculated as the square root of the sum of the squares of the uncertainties of the emission rates by category. This method is strictly valid if the errors in the different terms are uncorrelated. Two terms would have uncorrelated errors if there were no common source of error. The method would still be valid if the correlations were negligible.

A method recommended in the *Quality Control Handbook*¹⁵ by Juran, Gryna, and Bingham was used for quantifying the uncertainty of a sum (on the basis of assumed uncorrelated errors). The different terms being summed do not have to have the same statistical distribution. In fact, Juran, et al., illustrate the method with an example in which

three terms are summed, no two of which have estimated values that are the same within uncertainty. Also, no two of the terms have the same uncertainty. This method is based on a theorem that is proved by Mood, Graybill, and Boes in *Introduction to the Theory of Statistics*¹⁶ (p. 178). The methods used for analyzing error propagation, as well as alternative schemes, are discussed in much further detail in a separate project report documenting the statistical methods¹⁰ used in this study.

It has been pointed out that there may be correlations between the errors in the emission rates for different source categories. For example, in some instances, the same activity factor applies to more than one category. Also, there are instances in which data for more than one source category were collected from the same field. If inspection and maintenance practices at that field were better than the industry average, for example, this fact could have a common effect on the data for all categories sampled at that field. An assessment of the effect of correlated errors among categories has been performed. The results are discussed in Volume 4 on statistical methodology.¹⁰

6.5 Overall Statistical Accuracy

The precision is computed by rigorously calculating errors for average values produced from replicate measurements, and then by propagating error from each individual group of measurements into the national numbers. This section provides a brief discussion of the statistical methods used for the overall methane emissions project. Volume 5 on activity factors¹ summarizes the general statistical propagation techniques used, and Volume 4¹⁰ provides the full details of the various statistical techniques, tests, and considerations involved with this project.

During 1992, this project used a statistical analysis to apportion resources to refine the categories with the highest emission rates and/or the poorest accuracies. This method allowed for additional measurements or calculations that quickly refined and tightened the precision of the estimate. The 1992 plan also set an absolute accuracy target

of $\pm 0.5\%$ of gross production for the 90% upper confidence bound of the annual national emission rate. This is equivalent to an absolute accuracy target of approximately ± 111 Bscf. For the estimate of 307 Bscf, this means that the annual national estimate must have an upper confidence interval (at 90% confidence) that all possible answers will fall within $\pm 35\%$ ($106/307$) of the actual estimate. Any one source category within the sum of all sources may have a much larger confidence interval than $\pm 35\%$, since error bands are not additive directly, but are added as the square-root of a sum of squares. Consequently, it is possible for a sum to have a smaller relative uncertainty than do the individual terms (although the absolute uncertainty of the sum is larger than that of any individual term).

The project progress was tested in 1993 after significant data had been collected. The test showed that the precision target had already been reached, so additional tests were not needed to improve the precision. However, accuracy is made of precision and bias, and data collection continued throughout 1993 and early 1994 in order to reduce and eliminate bias. Precision can be calculated and improved by additional measurements, but bias must be eliminated through proper testing design, proper extrapolation, bias tests, and detailed data analysis and review. Testing design is a key factor in eliminating bias since sources cannot really be randomly selected for a number of practical reasons. Another potential source of bias can be eliminated by subdividing the data on an appropriate basis (such as grouping metering and regulating stations into various pressure categories), and reanalyzing the data. Stratifying, or subdividing, the data is beneficial if there are differences in the means and variances within these strata.

7.0

REFERENCES

1. Stapper, B.E. *Methane Emissions from the Natural Gas Industry, Volume 5: Activity Factors*, Final Report, GRI-94/0257.22 and EPA-600/R-96-080e. Gas Research Institute and U.S. Environmental Protection Agency, June 1996.
2. Hummel, K.E., L.M. Campbell, and M.R. Harrison. *Methane Emissions from the Natural Gas Industry, Volume 8: Equipment Leaks*, Final Report, GRI-94/0257.25 and EPA-600/R-96-080h. Gas Research Institute and U.S. Environmental Protection Agency, June 1996.
3. Campbell, L.M. and B.E. Stapper. *Methane Emissions from the Natural Gas Industry, Volume 10: Metering and Pressure Regulating Stations in Natural Gas Transmission and Distribution*, Final Report, GRI-94/0257.27 and EPA-600/R-96-080j. Gas Research Institute and U.S. Environmental Protection Agency, June 1996.
4. Campbell, L.M., M.V. Campbell, and D.L. Epperson . *Methane Emissions from the Natural Gas Industry, Volume 9: Underground Pipelines*, Final Report, GRI-94/0257.26 and EPA-600/R-96-080i. Gas Research Institute and U.S. Environmental Protection Agency, June 1996.
5. Shires, T.M. and M.R. Harrison. *Methane Emissions from the Natural Gas Industry, Volume 12: Pneumatic Devices*, Final Report, GRI-94/0257.29 and EPA-600/R-96-080l. Gas Research Institute and U.S. Environmental Protection Agency, June 1996.
6. Shires, T.M. and M.R. Harrison. *Methane Emissions from the Natural Gas Industry, Volume 7: Blow and Purge Activities*, Final Report, GRI-94/0257.24 and EPA-600/R-96-080g. Gas Research Institute and U.S. Environmental Protection Agency, June 1996.
7. Shires, T.M. *Methane Emissions from the Natural Gas Industry, Volume 13: Chemical Injection Pumps*, Final Report, GRI-94/0257.30 and EPA-600/R-96-080m. Gas Research Institute and U.S. Environmental Protection Agency, June 1996.
8. Myers, D.B. and M.R. Harrison. *Methane Emissions from the Natural Gas Industry, Volume 15: Gas-Assisted Glycol Pumps*, Final Report, GRI-94/0257.33 and EPA-600/R-96-080o. Gas Research Institute and U.S. Environmental Protection Agency, June 1996.

9. Myers, D.B. *Methane Emissions from the Natural Gas Industry, Volume 14: Glycol Dehydrators*, Final Report, GRI-94/0257.31 and EPA-600/R-96-080n. Gas Research Institute and U.S. Environmental Protection Agency, June 1996.
10. Williamson, H.J., M.B. Hall, and M.R. Harrison. *Methane Emissions from the Natural Gas Industry, Volume 4: Statistical Methodology*, Final Report, GRI-94/0257.21 and EPA-600/R-96-080d. Gas Research Institute and U.S. Environmental Protection Agency, June 1996.
11. American Gas Association. *Gas Facts*, 1992 Data, Arlington, VA, 1993.
12. U.S. Department of Energy/Energy Information Administration. *Natural Gas Annual*, 1992. DOE/EIA-0131(92), Washington, DC, Sept. 1992.
13. Wright Killen & Co. *Natural Gas Dehydration: Status and Trends*, Final Report. GRI-94/0099, Gas Research Institute, Chicago, IL, January 1994.
14. Stapper, C.J. *Methane Emissions from the Natural Gas Industry, Volume 11: Compressor Driver Exhaust*, Final Report, GRI-94/0257.28 and EPA-600/R-96-080k. Gas Research Institute and U.S. Environmental Protection Agency, June 1996.
15. Juran, J.M., F.M. Gryna, Jr., and R.S. Bingham, Jr. *Quality Control Handbook*, Third edition, McGraw-Hill Book Company, New York, NY, 1974, p. 178.
16. Mood, A.M., F.A. Graybill, and D.C. Boes. *Introduction to the Theory of Statistics*, Third edition, McGraw-Hill Book Company, New York, NY, 1974.

APPENDIX A
Production Source Sheets

SOURCE SPECIFIC EMISSION ESTIMATES

This appendix presents the source specific emission estimates derived from emission factors and activity factors for the sources of emissions within the natural gas industry. Each significant source of emissions has a "source sheet" that gives a synopsis of the basis of the estimate. These estimates are presented in a format which documents the approach for extrapolation of data to a national estimate. The emission factor and activity factor presented represent the final estimates from the program.

Each source sheet is divided into two sections, each one describing the basis for the emission factor and activity factor, respectively. The approach used to determine the accuracy of the emission and activity factor was discussed in Section 6.0, unless otherwise stated.

APPENDIX A

Production Source Sheets

	<u>Page</u>
P-1 - Compressor Exhaust	A-5
P-2 - Fugitive Emissions	A-10
P-3 - Gathering Pipeline Leaks	A-17
P-4 - Pneumatic Devices	A-22
P-5 - Chemical Injection Pumps	A-25
P-6 - Glycol Dehydrator Vents	A-28
P-7 - Glycol Pumps	A-32
P-8 - Maintenance Venting	A-35
P-9 - Upsets	A-38
P-10 - Pipeline Dig-ins	A-41
P-11 - Well Completion and Workovers	A-42

PRODUCTION SOURCE SHEETS

This section contains the specific source sheets for the production segment of the natural gas industry. The following table serves as a guide for finding sheets in this section. The cells in the table give the sheet number (P-1, P-2, etc.) of the source sheet. The rows define the equipment covered, while the columns define the operating mode and emission type. A category with no sheet number means that the emissions from that area were determined to be negligibly small. The label for each source sheet is shown at the top of the cover page for that sheet.

TABLE OF CONTENTS	OPERATING MODE, EMISSION TYPE (Fugitive, Vented, or Combusted)									
	Start Up		Normal Operations			Maintenance		Upsets		Mishaps
	V	C	F	V	C	V	C	V	C	V
Wellheads			P-2	P-4, P-5		P-8, P-11		P-9		
Heaters			P-2	P-4		P-8		P-9		
Separators			P-2	P-4		P-8		P-9		
Dehydrators			P-2	P-4, P-6, P-7		P-8		P-9		
Compressors			P-2	P-4	P-1	P-8		P-9		
Metering			P-2			P-8		P-9		
Pipelines			P-3			P-8		P-9		P-10

P-1
ALL-SEGMENT SOURCE SHEET

SOURCES: Compressors, Generators
 OPERATING MODE: Normal Operation
 EMISSION TYPE: Unsteady, Combusted (Compressor Driver Exhaust)
 ANNUAL EMISSIONS: 24.4 Bscf ± 64%

BACKGROUND:

Compressors are used to move gas through the system. They are located in production fields, processing plants, gas storage fields, and along transmission lines. Methane emissions are found in compressor driver exhaust (reciprocating engines and gas turbines) because of the incomplete combustion of the natural gas burned as fuel.

EMISSION FACTOR: (0.240 ± 5% scf/hp-hr, engines and 0.0057 ± 30% scf/hp-hr, turbines)

An average emission rate was calculated for each model of compressor engine and turbine in the GRI TRANSDAT Emissions Database (1), which is based on compressor tests conducted by Southwest Research Institute (SwRI). The emission rates were calculated from the reported methane emissions per unit of fuel and the reported fuel use rate (FUR) for each compressor model, as follows:

$$\overline{ER}_{(m)} = \overline{EP}_{(m)} \times \overline{FUR}_{(m)} \quad (1)$$

where: $\overline{ER}_{(m)}$ = average emission rate for model, m (scf/hr)

$\overline{EP}_{(m)}$ = average emission parameter for model, m (scf CH₄/scf fuel)

$\overline{FUR}_{(m)}$ = average fuel use rate for model, m (scf fuel/hr)

The following equation was used to determine the total emissions for the 86 turbines and 775 reciprocating engines in the Emissions Database.

$$TE = \sum_{m=1}^K \left[\sum_{i=1}^M (\overline{ER}_{(m)} \times HR_i) \right] \quad (2)$$

where: TE = total emissions for database, (scf)

HR_i = annual operating hours for compressor i, (hr/yr)

K = number of unique compressor models

M = number of compressors of model, m

The emission factors, for engines and turbines, were then calculated using the following equation.

$$\text{Emission Factor} = \text{TE} / \left[\sum_{i=1}^N \overline{\text{HP}}_i \times \left(\sum_{i=1}^N \overline{\text{HR}}_i / N \right) \right] \quad (3)$$

where: $\overline{\text{HP}}$ = average operating horsepower during HR, (hp)

HR = annual operating hours, (hr/yr)

N = number of compressors

This equation considers that some models could be operated at a higher percentage of the time because they are base loaded compressors. The average emission factors for the compressor drivers in the Emissions Database are 0.240 scf/hp-hr for reciprocating engines and 0.0057 scf/hp-hr for turbines.

EF DATA SOURCES:

1. "National Estimate of Methane Emissions from Compressors in the U.S. Natural Gas Industry" (2).

EF ACCURACY: $\pm 5\%$, engines and $\pm 30\%$, turbines

Basis:

The accuracy for the EF is estimated based on propagation of error from the spread of samples in the database. However, engineering judgement was used to assign accuracy for two of the individual terms in the equation, as follows:

1. Hydrocarbon analysis was estimated to be $\pm 10\%$, based on the generally accepted accuracy of gas chromatographs (flame ionization detector).
2. Likewise, fuel flow measurements were estimated to be $\pm 2.5\%$.

ACTIVITY FACTORS: (horsepower-hour)

Horsepower-hour data were available for the production industry segment activity factor calculation. Two pieces of information are needed to calculate the activity factor, which is expressed as horsepower-hours (hp-hr) for each type of driver in each of the remaining industry segments. These are the installed horsepower and the average operating hours. The following table presents these parameters and the resulting activity factors for both engines and turbines in each segment of the industry. The sources and methods for calculating all the values presented in the table below are given in the next section: AF Data Sources.

It is estimated that about 94% of the emissions in compressor and generator driver exhaust are from reciprocating engines used in production, processing, and transmission, with about 5% attributable to reciprocating engines used in storage. All other categories are negligible in comparison. Therefore, it is more important to accurately determine the activity factors for reciprocating engines in production, processing, and transmission.

COMPRESSOR DRIVER ACTIVITY FACTORS FOR EACH INDUSTRY SEGMENT

Industry Segment	Installed Engine MMhp ^a	Installed Turbine MMhp ^a	Annual Hours Engine	Annual Hours Turbine	Engine MMHp · hr	Turbine MMHp · hr
Production	NA	NA	NA	NA	27,460 ± 200%	0
Processing	4.19 ± 132% ^b	5.19 ± 99.4% ^b	6626 ± 11.5%	6345 ± 48.4%	27,760 ± 133%	32,910 ± 121%
Transmission						
Compressor Drivers	10.2 ± 10.0%	4.55 ± 10.0%	3964 ± 13.8%	2118 ± 31.3%	40,380 ± 17.1%	9635 ± 33.0%
Generator Drivers	1.45 ± 23.3%	0.045 ± 166%	1352 ± 38.0%	474 ± 620%	1962 ± 45.4%	21.2 ± 1215%
Storage						
Compressor Drivers	1.33 ± 13.5%	0.59 ± 13.5%	3707 ± 23.1%	2917 ± 620%	4922 ± 26.9%	1729 ± 626%
Generator Drivers	0.085 ± 126%	0.057 ± 184%	191 ± 377%	36 ± 620%	16.3 ± 621%	2.05 ± 1312%

^a Does not include horsepower associated with gas lift for oil recovery or with electric drivers.

^b Average of two estimation methods.

AF DATA SOURCES:

1. The production segment horsepower is based on the total installed horsepower-hours for data provided by one company for 516 compressor drivers (all reciprocating engines). The horsepower-hours for the company was divided by their production before scaling to a national estimate. National horsepower-hour was calculated using the 1992 marketed production for the U.S. [*Natural Gas Annual 1992*, (3)].
2. The processing segment horsepower was determined by taking the average of two methods. Each of the methods uses site data for the 10 gas plants visited. The first method scales to a national estimate by multiplying the total U.S. gas plant throughput as of January 1, 1993 [46,510.7 MMcfd, *Oil & Gas Journal* (4)] by the total site visit horsepower per throughput (47.8 hp/MMcfd, engines and 59.2 hp/MMcfd, turbines). The second method scales to a national estimate by multiplying the total number of gas plants in the U.S. [726, *Oil & Gas Journal* (4)] by the total site visit horsepower per number of gas plants visited (10), which is a scale-up ratio of about 73. The annual operating hours are based on the 10 sites plus data from two companies for an additional 18 gas plants. An average of the average operating hours per site was calculated to get the processing segment operating hours (203 engines and 9 turbines).
3. The transmission segment compressor station horsepower for each compressor driver type is based on the GRI TRANSDAT database. Installed horsepower was taken from the Industry Database module of GRI TRANSDAT. The annual operating hours are based on information reported on FERC Form No. 2. FERC data does not distinguish between driver type. The FERC data were split between engines and turbines based on data in GRI TRANSDAT and data provided by one transmission company (524 engines and 89 turbines).
4. The storage segment horsepower came from *Gas Facts* (5) data for 1992 (1,920,441 hp). The split between engines and turbines was assumed to be the same as the engine and turbine splits found in GRI TRANSDAT (69.1%, engines and 30.9%, turbines). The annual operating hours are based on 11 storage stations (50 engines and 6 turbines). An average of the average operating hours per station was calculated to get the storage segment operating hours.

5. The generator driver horsepower (compressor stations) is based on the total installed horsepower for 7 of the transmission sites visited and company data for 34 transmission compressor stations. To scale to a national estimate, the total horsepower per station was multiplied by the total number of transmission compressor stations [1700, FERC Form No. 2 (6)] in the U.S. The annual operating hours are also based on data from the site visits and company data. An average of the average generator operating hours per station was calculated to get generator operating hours (87 engines and 1 turbine).
6. The generator driver horsepower (storage fields) is based on the total installed horsepower for 9 storage fields (one company). To scale to a national estimate, the total horsepower per field was multiplied by the total number of storage fields [475, *Gas Facts* (5)] in the United States. The annual operating hours are also based on the company data. An average of the average generator operating hours per field was calculated to get generator operating hours (3 engines and 1 turbine).

AF ACCURACY:

Basis:

Errors were propagated from each of the following terms:

1. Production Hp·hr: The production Hp·hr accuracy is based upon an engineering analysis and set at $\pm 200\%$.
2. Transmission Hp·hr: The transmission Hp·hr accuracy is based upon an assigned estimated error of $\pm 10\%$ for the horsepower data in the GRI TRANSDAT database and error propagation from the FERC operating hours.
3. Other segment Hp·hr: The accuracy of the site visit data for horsepower and operating hours was also propagated using the spread of the data, but from much smaller data sets. The accuracy of the horsepower-hour activity factors for each industry segment are calculated statistically using the individual terms for horsepower and operating hours.

ANNUAL METHANE EMISSIONS: (24.57 \pm 65.1% Bscf, engines + 0.256 \pm 97.8% Bscf, turbines)

The annual emissions were determined by multiplying an emission factor by the horsepower-hour activity factor for reciprocating engines and turbines and summing these values for each segment. The following table shows the resulting emissions for each industry segment and the overall national estimate.

ANNUAL COMPRESSOR EMISSIONS FOR THE NATURAL GAS INDUSTRY BY SEGMENT

Compressor	Production	Processing	Transmission	Storage	Generators	TOTAL
Engines, Bscf	6.58 \pm 200%	6.65 \pm 133%	9.68 \pm 17.9%	1.18 \pm 26.9%	0.474 \pm 45.6%	24.57 \pm 65.1%
Turbines, Bscf	0.00	0.186 \pm 129%	0.0546 \pm 45.7%	0.00979 \pm 654%	0.000132 \pm 1163%	0.256 \pm 97.8%

REFERENCES

1. Biederman, N. GRI TRANSDAT Database: Compressor Module. (prepared for Gas Research Institute) npb Associates with Tom Joyce and Associates, Chicago, IL, August 1991.
2. Jones, D.L., L.M. Campbell, C.E. Burklin, M. Gundappa, and R.A. Lott, "National Estimate of Methane Emissions from Compressors in the U.S. Natural Gas Industry." Radian Corporation and Gas Research Institute, Air & Waste Management Association Conference Proceedings, Paper # 92-142.02, Kansas City, MO, 1992.

3. U.S. Department of Energy/Energy Information Administration. *Natural Gas Annual*, 1992. DOE/EIA-0131 (92), Washington, DC, September 1992.
4. *Oil & Gas Journal*. 1992 Worldwide Gas Processing Survey Database, 1993.
5. American Gas Association, *Gas Facts: 1992 Data*, Arlington, VA, 1993.
6. Federal Energy Regulatory Commission (FERC) Form No. 2: Annual Report of Major Natural Gas Companies, 1992 database.

P-2
PRODUCTION SOURCE SHEET

SOURCES:	All Production Equipment (See Below)
OPERATING MODE:	Normal Operation
EMISSION TYPE:	Steady, Fugitive
ANNUAL EMISSIONS:	17.4 Bscf ± 41%

BACKGROUND:

Equipment leaks are typically low-level, unintentional losses of process fluid (gas or liquid) from the sealed surfaces of above-ground process equipment. Equipment components that tend to leak include valves, flanges and other connectors, pump seals, compressor seals, pressure relief valves, open-ended lines, and sampling connections. These components represent mechanical joints, seals, and rotating surfaces, which in time tend to wear and develop leaks.

EMISSION FACTOR: (scf/equipment-yr, see below)

In the component method for estimating emissions from equipment leaks, an average emission factor is determined for each of the basic components, such as valves, flanges, seals, and other connectors that comprise a facility. The average emission factor for each type of component is determined by measuring the emission rate from a large number of randomly selected components from similar types of facilities throughout the country. An average estimate of the emissions per equipment or facility are determined as the product of the average emission factor per component type (i.e., the component emission factor) and the average number of components associated with the major equipment or facility:

$$EF = [(N_{vfv} \times EF_{vfv}) + (N_{cn} \times EF_{cn}) + (N_{oel} \times EF_{oel}) + (N_{oth} \times EF_{oth})]$$

where:

N_x = average count of components of type x per plant, and
 EF_x = average methane emission rate per component of type x.

Component emission factors for fugitive equipment leaks in gas production were estimated separately for onshore and offshore production due to differences in operational characteristics. Regional differences were found to exist between onshore production in the Eastern U.S. (i.e., Atlantic and Great Lakes region) and the Western U.S. (i.e., rest of the country, excluding the Atlantic and Great Lakes region) and between offshore production in the Gulf of Mexico and the Pacific Outer Continental Shelf (OCS). Separate measurement programs were conducted to account for these regional differences.

Onshore Production in the Eastern U.S. Region. Gas production in the Eastern U.S. accounts for only 4.2% of gross national gas production, but includes 47% of the total gas wells in the country. Component emission factors for onshore production in the Eastern U.S. were based on a measurement program conducted by GRI/Star Environmental (1) of 192 individual well sites at 12 eastern gas production facilities. Component counts for gas wellheads, separators, meters and the associated above-ground piping, and gathering compressors were based on information collected as part of the Eastern U.S. production measurement program. Site visits and phone surveys of 7 additional sites provided data used for determining the number of heaters and dehydrators in the Eastern U.S. region. Component counts for heaters and dehydrators were assumed to be identical to those derived from data collected in the Western U.S. The following table presents the component emission factors, average component counts, and average equipment emissions for onshore gas production in the Eastern U.S. region.

Average Equipment Emissions for Onshore Production in the Eastern U.S.

Equipment Type	Component Type	Component Emission Factor, Mscf/component-yr	Average Component Count	Average Equipment Emissions, ^a scf/equipment-yr
Gas Wellheads	Valve	0.184	8	2,595 (27%)
	Connection	0.024	38	
	Open-Ended Line	0.42	0.5	
Separators	Valve	0.184	1	328 (27%)
	Connection	0.024	6	
Heaters	Valve	0.184	14	5,188 (43%)
	Connection	0.024	65	
	Open-Ended Line	0.42	2	
	Pressure Relief Valve	0.279	1	
Glycol Dehydrators	Valve	0.184	24	7,938 (35%)
	Connection	0.024	90	
	Open-Ended Line	0.42	2	
	Pressure Relief Valve	0.279	2	
Meters/Piping	Valve	0.184	12	3,289 (30%)
	Connection	0.024	45	
Gathering Compressors	Valve	0.184	12	4,417 (27%)
	Connection	0.024	57	
	Open-Ended Line	0.42	2	

^a Values in parentheses represent the 90% confidence interval.

Onshore Production in the Western U.S. Region. Component emission factors for onshore production in the Western U.S. were based on a comprehensive fugitive emissions measurement program conducted by API/GRI (2) at 12 oil and gas production sites. In this program, measurement data were collected from 83 gas wells at 4 gas production sites in the Pacific, Mountain, Central, and Gulf regions. The average component counts for each piece of major process equipment associated with gas production in the Western U.S. were based on data collected during the API/GRI study and additional data collected for GRI during 13 site visits to gas production fields. The following table presents the component emission factors, average component counts, and average equipment emissions for onshore gas production in the Western U.S. region.

Average Equipment Emissions for Onshore Production in the Western U.S.

Equipment Type	Component Type	Component Emission Factor, Mscf/component-yr	Average Component Count	Average Equipment Emissions, ^a scf/equipment-yr
Gas Wellheads	Valve	0.835	11	13,302 (24%)
	Connection	0.114	36	
	OEL	0.215	1	
Separators	Valve	0.835	34	44,536 (33%)
	Connection	0.114	106	
	OEL	0.215	6	
	PRV	1.332	2	
Heaters	Valve	0.835	14	21,066 (40%)
	Connection	0.114	65	
	OEL	0.215	2	
	PRV	1.332	1	
Glycol Dehydrators	Valve	0.835	24	33,262 (25%)
	Connection	0.114	90	
	OEL	0.215	2	
	PRV	1.332	2	
Meters/Piping	Valve	0.835	14	19,310 (30%)
	Connection	0.114	51	
	OEL	0.215	1	
	PRV	1.332	1	
Gathering Compressors	Valve	0.835	73	97,729 (68%)
	Connection	0.114	179	
	OEL	0.215	3	
	PRV	1.332	4	
	Compressor Seal	2.37	4	
Large Compressor Stations	b	b	b	3.01 x 10 ⁶ (102%)
Station Components	b	b	b	
Compressor-Related Components	b	b	b	5.55 x 10 ⁶ (65%)

^a Values in parentheses represent the 90% confidence interval.

^b Refer to T-1 source sheet for a discussion of the basis for estimated emissions from large compressor stations.

Offshore Gas Production. Emissions from equipment leaks from offshore production sites in the U.S. were based on two separate measurement programs:

- The API/GRI oil and natural gas production operations study, which included 4 offshore production sites in the Gulf of Mexico; and
- The Minerals Management Service study of 7 offshore production sites in the Pacific Outer Continental Shelf.

The component emission factors and component counts were taken directly from the field test reports from these studies. The following table presents the component emission factors, component counts, and average facility emissions for offshore production in the Gulf of Mexico and Pacific OCS.

Average Facility Emissions for Offshore Production

Equipment Type	Component Type	Component Emission Factor, Mscf/component-yr	Average Component Count	Average Facility Emissions, ^a Mscf/yr
Gulf of Mexico Platform	Valve	0.187	2,207	1,064 (27%)
	Connection	0.046	8,822	
	Open-Ended Line	0.368	326	
	Other	2.517	67	
Pacific OCS Platform	Valve	0.048	1,833	430 (36%)
	Connection	0.021	13,612	
	Open-Ended Line	0.092	313	
	Other	0.091	307	

^a Values in parentheses represent the 90% confidence interval.

EF DATA SOURCES:

1. Emission Factors for Eastern Gas Production based upon data from the GRI/Star program (1) for the component EF's at 12 gas production sites.
2. Fraction of methane (78.8 mol%) based on data from *Methane Emissions from the Natural Gas Industry, Volume 6: Vented and Combusted Source Summary* (3). Conversion of emission factors from (pounds THC per day) to (methane Mscf/yr) also required estimation of gas average molecular weight. Based on data from *Perry's Chemical Engineer Handbook* (5th Edition) (4), Table 9-15, selected most similar gas composition speciation from C₁ through C₆₊ and performed linear extrapolation from average of 3 lowest data (87 mol% methane) to 78.8 mol% methane. Resultant weight percent of 69.6 wt% methane used to speciate methane emissions.
3. Component counts in Eastern gas production were based on average counts per equipment from the GRI/Star program at 12 gas production sites. Component counts for heaters and dehydrator in the Eastern region were based on data collected in the Western region. Component counts for onshore production in the Western U.S. were based on the averages

- from the GRI/Star program at 4 gas production sites and GRI/Radian data from 13 site visits to gas production fields.
4. Offshore data from API/GRI/Star 20-site program for Gulf of Mexico platforms (4 platforms, site numbers 17 through 20), and Minerals Management Service/ABB Pacific OCS fugitive study (7 platforms). See respective test reports (Gulf of Mexico Offshore: API/Star 20-site study (5); Pacific OCS Offshore: MMS report 92-0043 November 30, 1992) (6).
 5. Large gathering compressors and large gathering compressor station emission factors are taken from Transmission segment (see Sheet T-1).

EF PRECISION:

Gas Wells - Eastern	± 27%
Separators - Eastern	± 27%
Heaters - Eastern	± 43%
Dehydrators - Eastern	± 35%
Meters/piping - Eastern	± 30%
Gathering compressors - Eastern	± 27%
Gas Wells - Western	± 24%
Separators - Western	± 33%
Heaters - Western	± 40%
Dehydrators - Western	± 25%
Meters/piping - Western	± 30%
Gathering compressors - Western	± 68%
Large Gathering Compressors	± 65%
Large Gathering Stations	± 102%
Offshore (Gulf)	± 27%
Offshore (Pacific)	± 36%

Basis:

The accuracy is rigorously propagated through the EF calculation from the range of individual measurements. Ninety percent confidence intervals were calculated for the sites using the t-statistic method. Computed 90% confidence intervals for site average component counts were combined with 90% confidence intervals for component emission factors to obtain pooled uncertainty in aggregate emission factor.

ACTIVITY FACTOR: (129157 Gas Wells - Eastern)	± 5%
(91670 Separators - Eastern)	± 23%
(260 Heaters - Eastern)	± 196%
(1047 Dehydrators - Eastern)	± 20%
(76262 Meters - Eastern)	± 100%
(129 Gathering Compressors - Eastern)	± 33%
(142771 Gas Wells - Western)	± 5%
(74674 Separators - Western)	± 57%
(50740 Heaters - Western)	± 95%
(36777 Dehydrators - Western)	± 20%
(301180 Meters - Western)	± 100%
(16915 Gathering Compressors - Western)	± 52%
(96 Large Gathering Compressors)	± 100%
(12 Large Gathering Stations)	± 100%
(1092 Gulf of Mexico platforms)	± 10%
(22 Western offshore)	± 10%

AF DATA SOURCES:

1. The gas well count is from A.G.A.'s *Gas Facts* 1992 data (7).
2. Eastern gas wells and equipment AFs were regionalized using site visit data. Eastern meter AF based on 0.43 meter per gas industry well (per Star Environmental). Western U.S. meter AF based on industry advisor information of 1:1 meter per gas industry well.
3. Dehydrator counts are based on 37,824 glycol dehydrators in production (see Sheet P-6 for details). Adjustment to activity factor for Eastern gas production: subtract 1,047 dehydrators (included in Eastern gas production component counts).
4. Offshore platform counts provided by Offshore Data Services, Inc., Houston, Texas, and Minerals Management Service MOAD database for producing platforms. Assumed 50/50 split between "oil" industry and "gas" industry.
5. Large gathering compressors and compressor station counts were estimated from FERC Form 2 database. Large gathering compressor stations were those with at least 16 stages of compression (5 compressors per station and an average of 3.3 stages per compressor). The result was extrapolated to the national total by ratioing on gathering miles covered in FERC to total gathering mileage.
6. The other equipment counts were produced from equipment count data taken during the site visits by Radian and Star. As explained in the activity factor section of the text of this report, extrapolation to national counts was done on a regional basis to account for regional equipment configuration differences.

AF PRECISION:

Basis:

1. The precision for the active wells is assigned by engineering judgement, based upon the fact that the number of active wells is tracked nationally and known accurately by A.G.A./DOE, etc.
2. The accuracy for the other equipment types is based upon rigorous propagation of error from the range in averages from the 9 production sites visited.

REFERENCES:

1. Star Environmental. *Fugitive Hydrocarbon Emissions: Eastern Gas Wells*, Final Report, GRI-95/0117, Gas Research Institute, Chicago, IL, July 1995.
2. Star Environmental. *Fugitive Hydrocarbon Emissions from Oil and Gas Production Operations*, (API Publication No. 4589). American Petroleum Institute, December 1993.
3. Shires, T.M. and M.R. Harrison. *Methane Emissions from the Natural Gas Industry, Volume 6: Vented and Combustion Source Summary*, Final Report, GRI-94/0257.23 and EPA-600/R-96-080g. Gas Research Institute and U.S. Environmental Protection Agency, June 1996.
4. Perry, R.H. et al. (ed.). *Perry's Chemical Engineers' Handbook*. Sixth Edition, McGraw-Hill Book Co., New York, NY, 1984.
5. Star Environmental. *Emission Factors for Oil and Gas Production Operations*. (API Publication No. 4615). American Petroleum Institute, January 1995.
6. R. Countess, et al. *Fugitive Hydrocarbon Emissions from Pacific OCS Facilities*. Volume 1, Final Report. MMS 92-0043, Minerals Management Service, Washington, DC, 1992.
7. American Gas Association. *Gas Facts*, 1992 Data, Arlington, VA, 1993.

ANNUAL EMISSIONS:

(17.4 Bscf/yr ± 7.1 Bscf/yr)

The annual emissions were determined by multiplying the average equipment emissions by the population of equipment in the segment.

Category	Emission Factor	Activity Factor	Emission Rate	Uncertainty
Gas Wellhead (Eastern U.S.)	2595 scf/yr methane	129157 gas wells (Eastern U.S.)	0.34 Bscf/yr methane	27%
Separators (Eastern U.S.)	328 scf/yr methane	91670 separators (Eastern U.S.)	0.03 Bscf/yr methane	36%
Heaters (Eastern U.S.)	5187 scf/yr methane	260 heaters (Eastern U.S.)	0.001 Bscf/yr methane	218%
Dehydrators (Eastern U.S.)	7939 scf/yr methane	1047 dehydrators (Eastern U.S.)	0.008 Bscf/yr methane	41%
Meters/Piping (Eastern U.S.)	3289 scf/yr methane	76262 meters (Eastern U.S.)	0.25 Bscf/yr methane	109%
Gathering Compressors (Eastern U.S.)	4417 scf/yr methane	129 gathering compressors (Eastern U.S.)	0.0006 Bscf/yr methane	44%
Gas Wellheads (Western U.S.)	13302 scf/yr methane	142771 gas wells (Western U.S.)	1.9 Bscf/yr methane	25%
Separators (Western U.S.)	44536 scf/yr methane	74674 separators (Western U.S.)	3.33 Bscf/yr methane	69%
Heaters (Western U.S.)	21066 scf/yr methane	50740 in-line heaters (Western U.S.)	1.07 Bscf/yr methane	110%
Dehydrators (Western U.S.)	33262 scf/yr methane	36777 dehydrators (Western U.S.)	1.22 Bscf/yr methane	32%
Meters (Western U.S.)	19310 scf/yr methane	301180 meters (Western U.S.)	5.82 Bscf/yr methane	109%
Small Gathering Compressors (Western U.S.)	97729 scf/yr methane	16915 compressors (Western U.S.)	1.65 Bscf/yr methane	93%
Large Gathering Compressors (Western U.S.)	5.55 MMscf/yr methane	96 large compressors	0.53 Bscf/yr methane	136%
Large Gathering Compressor Stations (Western U.S.)	3.01 MMscf/yr methane	12 large gathering compressor stations	0.04 Bscf/yr methane	176%
Offshore Oil/Gas (Gulf)	1064 Mscf/yr methane	1092 Gulf of Mexico platforms	1.16 Bscf/yr methane	29%
Offshore Oil/Gas (Pacific)	430.0 Mscf/yr methane	22 platforms (Pacific)	0.01 Bscf/yr methane	38%
TOTAL			17.4 Bscf/yr methane	41%

P-3
PRODUCTION SEGMENT SOURCE SHEET

SOURCES: Gathering Pipelines
OPERATING MODE: Normal Operations
EMISSION TYPE: Steady, Fugitives (Pipeline Leaks)
ANNUAL EMISSIONS: 6.6 Bscf ± 108%

BACKGROUND:

Gathering field pipelines transport the gas from the production well to gas conditioning or processing facilities. Leakage from gathering pipelines occurs from corrosion, joint and fitting failures, pipe wall fractures, and external damage.

EMISSION FACTOR: (scf/leak-year)

The emission factors for leakage from gathering pipelines are based on the arithmetic average leakage rates for main pipelines from the cooperative underground distribution leakage measurement program. A mean value of the estimated leak rate per leak was calculated using the test data for all pipe materials except cast iron. For cast iron mains, a segment test approach was used which quantifies the leakage rate for a long isolated segment of pipe; therefore, the mean leakage rate for cast iron is in terms of leakage per unit length of pipe. The natural gas leak rate is adjusted for methane by multiplying by the volume percent of methane for production (78.8 vol. %), and is adjusted for the soil oxidation of methane. The value of the emission factor and standard deviation for each pipe material category is given below:

Pipe Material	Number of Samples	Average Emission Factor	Units of Emission Factor	90% Confidence Interval of Emission Factor
Protected Steel	17	17,102	scf/leak-yr	14,548
Unprotected Steel	20	43,705	scf/leak-yr	40,675
Plastic	6	84,237	scf/leak-yr	139,729
Cast Iron	21	201,418	scf/mile-yr	128,290

EMISSION FACTOR DATA SOURCES:

1. Leakage rate data on a rate per leak basis for cathodically protected steel mains, unprotected steel mains, and plastic mains from the cooperative leak measurement program.
2. Leakage rate data on a rate per unit length basis for cast iron mains from the cooperative leak measurement program for distribution mains.
3. Assumes that the leak rates from gathering lines are identical to leak rates from distribution mains.

ACTIVITY FACTOR:

The estimated number of leaks in field gathering pipelines is based on a leak repair frequency for gathering lines owned and operated by transmission companies reported in the 1991 DOT RSPA database (1). This database reports an estimated 8,153 repaired leaks and 270 outstanding leaks in 31,918 miles of gathering pipeline. The leak frequency is derived by compensating for leaks that are repaired during the year and, therefore, not contributing to leakage year round. On average, the repaired leaks are assumed to be leaking for half the year, and each leak repair is counted as half an equivalent leak. Outstanding and unreported leaks are assumed to be leaking the entire year.

Most production lines owned and operated by production companies are not regulated by DOT and many are not monitored for leaks in the rigorous fashion employed by distribution and transmission companies. Therefore, unreported leaks are accounted for based on the effectiveness of the survey method performed, which is estimated to find 35% and 85% of the total leaks for a vegetation and walking survey, respectively, based on one contract company specializing in distribution surveys. It is estimated that production company owned gathering lines are only surveyed using a vegetation method. However, transmission company owned gathering lines are estimated to be surveyed annually using a walking method, based on conversations with several transmission companies.

Based on this analysis of equivalent leaks, the leak frequency is 0.18 leaks per mile for a walking survey and 0.63 leaks per mile for a vegetation survey. This leak frequency was used to ratio the number of leaks to the total estimated population of gathering pipeline.

Total gathering pipeline mileage is not reported or tracked nationally and must be estimated. The "gathering pipeline" designation includes three categories of pipeline: 1) production company owned gathering pipeline for gas wells not associated with oil production (i.e., non-associated gas wells); 2) production company owned gathering pipeline for oil wells that produce marketed gas (i.e., associated gas wells); and 3) transmission company owned gathering pipeline. The third category of utility-owned pipelines are assumed to be in addition to the production pipeline miles associated with wells. This is consistent with the site visit data since gathering lines owned by transmission companies were intentionally excluded from the site mileage totals. (The production companies did not report pipeline miles beyond their custody transfer meters.)

Total miles of gathering pipeline for non-associated gas wells were estimated using site visit data from the thirteen production sites shown in the following table. Seven of the thirteen sites provided estimates of their total miles of pipeline. The fifth site's mileage was estimated from a map of its pipelines.

Site	Gathering Miles	Number of Wells	Miles per Total Wells
Site 1	46.3	80	
Site 2	8	26	
Site 3	40	130	
Site 4	15.4	12	
Site 5	11	6	
Site 6	5.2	193*	
Site 7	600	1000	
Site 8	441.3	425	
Site 9	0.7	1	
Site 10	27.7	24	
Site 11	2.1	3	
Site 12	7.1	7	
Site 13	154.2	126	
TOTAL	1359.0	2033	0.67 +/- 28%

*Includes 55 oil wells.

The estimate of total gathering miles per non-associated gas well was derived as the weighted average total miles divided by total wells (0.67 ± 28%). The average mile per well ratio was extrapolated by the nationally tracked number of non-associated gas wells (276,000). The resulting estimate of national gathering pipeline miles associated with gas wells is 184,000.

For the gathering pipeline mileage associated with oil wells that market gas, the same ratio of gathering miles per well was applied. However, it was assumed that only half of the gathering pipeline mileage was attributed to the gas industry; the other half was attributed to the oil industry. Therefore, the average ratio of pipeline miles to oil wells marketing gas was estimated to be 0.33. This average ratio was extrapolated by the estimated number of oil wells marketing gas in the U.S. (209,000). The resulting estimate of gathering pipeline mileage associated with oil wells that market gas is 70,000.

The third category of gathering pipeline owned by transmission companies is reported by the American Gas Association (A.G.A.) (2) to be 86,200 miles. Utility-owned pipelines were assumed to be included in the total production owned gathering pipeline miles and are not included in the transmission company owned gathering line mileage.

The resulting total national gathering pipeline mileage from gas wells, oil wells marketing gas, and transmission companies was estimated to be 340,200 miles. A rigorous determination of the 90% confidence interval gave an error less than 4%, which was considered low based on the quality of the data used to generate the activity factor. Thus, a 90% confidence interval of ± 10% was assumed based on engineering judgement.

Based on the analysis resulting in a leak frequency of 0.18 leaks per mile for transmission-owned gathering lines employing a walking survey, and 0.63 leaks per mile for production-owned gathering lines employing a vegetation survey, the activity factor can be calculated as follows:

$$[(86,200 \times 0.18)] + [(340,200 - 86,200) \times 0.63] = 174,779 \text{ equivalent leaks/year}$$

The breakdown of total equivalent leaks by pipe material category is based on the breakdown of pipe mileage reported in the 1991 DOT RSPA database (1) for transmission-owned gathering lines. It was estimated that production-owned gathering line mileage is equivalent to the transmission-owned pipelines, with the exception of cast iron. It was assumed that no additional cast iron gathering lines are in service. (That is, the cast iron gathering line mileage reported in the RSPA database accounts for the total in the United States.)

The total number of estimated gathering line leaks was allocated on a pipeline material category basis in the same proportion (adjusted for the fraction of mileage in each material category) as in the distribution sector. The precision of the estimated total leaks was calculated based on the estimated 90% confidence interval associated with each parameter in the activity factor equation:

- repaired leaks; outstanding leaks: $\pm 100\%$
- leak duration: $\pm 25\%$
- leak survey effectiveness: $\pm 15\%$

A statistical software program [(@ RISK (3))] was used to determine the overall 90% confidence interval of the activity factor: $\pm 76\%$.

For cast iron gathering lines, the mileage is based on the 1991 DOT RSPA database for transmission and gathering lines. The precision of the cast iron mileage estimate is assumed to be $\pm 10\%$. The following table summarizes the estimated average activity factor and the precision:

Pipe Material	Total Miles	Average Activity Factor	Units of Activity Factor	90% Confidence Interval of Activity Factor
Protected Steel	268,082	53,657	equivalent leaks	40,779
Unprotected Steel	41,400	114,655	equivalent leaks	87,138
Plastic	29,862	6,467	equivalent leaks	4,915
Cast Iron	856	856	miles	86

ACTIVITY FACTOR DATA SOURCES:

1. Leak repair frequency from [(DOT RSPA (1))] gathering line data.
2. Leak survey effectiveness provided by Southern Cross Company (4).
3. The gathering miles for gas and oil wells marketing gas was estimated using Phase 3 site visit data for seven production companies. The number of gas and oil wells for these companies was also used to extrapolate out to the national estimate.
4. The number of producing gas wells in the United States was taken from A.G.A. *Gas Facts* (2) for 1992.
5. The number of oil wells producing marketed gas in the United States was estimated by Radian (5). See activity factor section and sheet P-2.

6. The field and gathering miles owned by transmission companies was taken from A.G.A. Gas Facts (2) for 1992.

ANNUAL EMISSIONS: (6.6 Bscf \pm 108%)

The activity factor was multiplied by the emission factor to derive this total leakage rate. The 90% confidence intervals were propagated through this multiplication.

Pipe Material	Average Emission Factor (scf/leak-yr)	Average Activity Factor (equivalent leaks)	Annual Emissions Estimate, (Bscf)	90% Confidence Interval of Leakage Estimate (Bscf)
Protected Steel	17,102	53,657	0.9	1.2
Unprotected Steel	43,705	114,655	5.0	7.0
Plastic	84,237	6,467	0.6	1.2
Cast Iron	201,418 ^a	856 ^b	0.2	0.1
Total			6.6	7.2

^ascf/mile-yr.

^bmiles.

REFERENCES

1. U.S. Department of Transportation, Research and Special Programs Administration. 1991.
2. American Gas Association, *Gas Facts*, Arlington, VA, 1992.
3. Palisade Corporation. *@ Risk, Risk Analysis and Simulation Add-In for Lotus 1-2-3, Version 1.5*, March 1989.
4. Southern Cross Corporation. *Comments on Docket PS-123, Notice 1, Leakage Surveys*, 49 CFR Part 192, Department of Transportation, Research and Special Programs Administration, Materials Transportation Bureau, Office of Pipeline Safety Regulations, December 19, 1991.
5. Stapper, B.E. *Methane Emissions from the Natural Gas Industry, Volume 5, Activity Factors*, Final Report, GRI-94/0257.22 and EPA-600/R-96-080e. Gas Research Institute and U.S.Environmental Protection Agency, June 1996.

P-4
PRODUCTION SOURCE SHEET

SOURCES: Various Equipment
 (wells, heaters, separators, dehydrators, compressors)
COMPONENTS: Pneumatic Devices
OPERATING MODE: Normal Operation
EMISSION TYPE: Unsteady, Vented
ANNUAL EMISSIONS: 31.4 Bscf ± 65%

BACKGROUND:

Most of the pneumatic devices in the industry are valve actuators and controllers that use natural gas pressure as the force for valve movement. There is a large population of pneumatic devices throughout the gas industry. Gas from the valve actuator is vented to the atmosphere during every valve stroke, and gas may be continuously bled from the valve controller pilot as well.

EMISSION FACTOR: 125,925 scf per average device ± 40%

(This was adjusted for the production methane fraction of natural gas at 78.8 mol%.)

Pneumatic devices (valve controllers) linked to control valves are the largest source of pneumatic emissions in the production segment. There are two types of devices with distinct bleed modes: intermittent and continuous. Intermittent bleed devices emit methane to the atmosphere only when the control valve actuates; when the device is not moving the bleed rate is zero. Continuous bleed devices emit methane both when the valve actuates and when the device is not moving. An emission rate for a generic pneumatic device combines the bleed rates of the two types of devices, weighted by the population of the device types as follows:

$$EF_{\text{avg. pneum. device}} = \left(\text{Fraction}_{\text{intermittent}} \times EF_{\text{intermittent}} + \text{Fraction}_{\text{continuous}} \times EF_{\text{continuous}} \right) \times \% \text{ methane}$$

where:

$$\begin{aligned} \text{Fraction}_{\text{intermittent}} &= 0.65 \pm 43\% \\ \text{Fraction}_{\text{continuous}} &= 0.35 \pm 43\% \\ \% \text{ Methane} &= 78.8 \text{ mol } \% \pm 5\% \end{aligned}$$

Emissions for intermittent and continuous bleed devices were based on measured data provided by a Canadian study and U.S. field measurements from a separate contractor's program. The average measured emissions for intermittent and continuous bleed devices are 323 ± 34% and 654 ± 31% scfd/device, respectively. The fraction of each type of device was determined from site visits.

Therefore the average annual emission factor for a generic pneumatic device is:

$$EF_{\text{avg. pneumatic device}} = 125,925 \pm 40\% \text{ scf/device}$$

EF DATA SOURCES:

1. *Methane Emissions from the Natural Gas Industry, Volume 12: Pneumatic Devices* (1) establishes the important emission-affecting characteristics.
2. Site visit device counts establish the fraction of continuous bleed versus intermittent bleed

- devices for multiple sites.
3. The Canadian Producers Association (CPA) determined an average emission factor per device based on 19 measurements.
 4. An independent contractor provided 18 measurements of pneumatic devices in onshore and offshore production services.

EF PRECISION:

Basis:

EF accuracy is based on rigorous error propagation from the spread of site device counts and measured emission rates.

ACTIVITY FACTOR: 249,111 pneumatic controllers \pm 48 %

The average count of devices per equipment type was determined from multiple site visits. The ratios for the number of devices per gas well and the number of devices per marketed gas production were compiled by region. The regional values were summed to give national device counts based on well counts and marketed gas production. These values were averaged to give the final national device count of 249,111.

AF DATA SOURCES:

1. *Methane Emissions from the Natural Gas Industry, Volume 5: Activity Factors (2)* establishes the methodology for extrapolating the site data to a national count.
2. Site visit device counts, well counts, and production rates establish the number of devices per well and the number of devices per gas production.
3. Total regional gas well counts and 1992 marketed gas production rates are from A.G.A. *Gas Facts (3)*.
4. The oil wells that market gas were calculated by this report and *World Oil (4)*. Total oil wells for 1992 are reported as 602,197 by the *Oil & Gas Journal (5)*. The active oil wells that market gas are determined by multiplying the total national active wells by the fraction that market gas. The fraction is determined from a Texas Railroad Commission database (6) on oil leases and gas disposition from those leases; an analysis that shows the percent of oil leases that market the associated gas in Texas is 34.7%.

AF PRECISION:

Basis:

1. The accuracy for the devices per well and devices per gas production rate are calculated from the spread of site data collected for each region (a total of 36 sites).
2. The accuracy for wells that market gas are based on the spread of data from the Texas Railroad Commission database.

ANNUAL METHANE EMISSIONS: 31.4 Bscf \pm 65 %

The national annual emissions were determined by multiplying an emission factor for an average pneumatic device by the population of devices in the production segment.

$$125,925 \text{ scf} \times 249,111 \text{ devices} = 31 \text{ Bscf}$$

REFERENCES

1. Shires, T.M. and M.R. Harrison. *Methane Emissions from the Natural Gas Industry, Volume 12: Pneumatic Devices*. Final Report, GRI-94/0257.29 and EPA-600/R-96-0801, Gas Research Institute and U.S. Environmental Protection Agency, June 1996.
2. Stapper, B.E. *Methane Emissions from the Natural Gas Industry, Volume 5: Activity Factors*. Final Report, GRI-94/0257.22 and EPA-600/R-96-080e, Gas Research Institute and U.S. Environmental Protection Agency, June 1996.
3. American Gas Association. *Gas Facts: 1993 Data*, Arlington, VA, 1994.
4. Gulf Coast Publishing Company, *World Oil*, Annual Forecast/Review, Vol. 214, No. 2, February 1993.
5. *Oil and Gas Journal*. 1992 Worldwide Gas Processing Survey Database, 1993.
6. Texas Railroad Commission, P-1, P-2 Tapes, Radian files, Austin, TX, 1989.

P-5
PRODUCTION SOURCE SHEET

SOURCES: Wells, Gathering Facilities
COMPONENTS: Chemical Injection Pumps
OPERATING MODE: Normal Operation
EMISSION TYPE: Unsteady, Vented
ANNUAL EMISSIONS: 1.5 Bscf ± 203%

BACKGROUND:

Gas-driven chemical injection pumps use gas pressure acting on a piston to pump a chemical on the opposite side of the piston. The gas is then vented directly to the atmosphere. The pumps are used to add chemicals such as corrosion inhibitors, scale inhibitors, biocide, demulsifier, clarifier, and hydrate inhibitors to operating equipment. Two types of pumps were observed: 1) piston pumps, and 2) diaphragm pumps. Some of the pumps observed were inactive at the time or had seasonal operation.

EMISSION FACTOR: 248 scfd/average pump ± 83 %

(This was adjusted for the production methane content in natural gas at 78.8 mol%.)

This average emission factor is based upon the following equation:

$$EF_{\text{avg. pump}} = F_{\text{piston}} \times EF_{\text{piston}} + F_{\text{diaphragm}} \times EF_{\text{diaphragm}}$$

where:

F_{piston} = fraction of the pump population that is the piston type = 49.8% ± 38%
 EF_{piston} = emission factor of an average piston pump = 48.9 scfd/pump ± 106%
 $F_{\text{diaphragm}}$ = fraction of the pump population that is the diaphragm type = 50.2% ± 38%
 $EF_{\text{diaphragm}}$ = emission factor of an average diaphragm pump = 446 scfd/pump ± 77%

The average device emission factor was determined by an aggregation of device emissions calculated for multiple U.S. sites. For piston pumps, the emission factor was determined by the following equation:

$$EF_{\text{piston}} = \text{Gas usage (acf/stroke)} \times \text{Density (scf/acf)} \times \text{Frequency (strokes/day)} \times \text{Operating time} \times \% \text{ methane}$$

where:

Gas usage = calculated gas usage based on piston diameter and stroke length (in actual ft³);
 Density = scf/acf at supply gas pressure (average 30 psig) (combined average value of volume and density is 0.0037 ± 65% scf/stroke);
 Frequency = strokes per day of the average pump (37,901 ± 29% strokes/day);
 Operating time = portion of time that the pump is operating (0.446 ± 62%); and
 % methane = 78.8 mol% ± 5% for the production segment.

Based on site and manufacturer data, the resulting national piston pump emission factor is 48.9 scfd/pump ± 106%.

For diaphragm chemical injection pumps, the emission factor was determined by the following equation:

$$EF_{\text{diaphragm}} = \frac{\text{Gas usage (scf/gal)} \times \text{Volume (gal/stroke)} \times \text{Frequency (strokes/day)} \times \text{\% methane}}{\text{Operating time}}$$

where:

- Gas usage = volume of gas (in standard ft³) required to pump one gallon of liquid chemical (provided by the manufacturer);
- Volume = liquid displaced per stroke based on the plunger diameter and stroke length (combined average value of gas consumption and volume is 0.0719 ± 10% scf/stroke);
- Frequency = strokes per day of the average pump (19,642 ± 49% strokes/day);
- Operating time = portion of time that the pump is operating (0.40 ± 52%); and
- % methane = 78.8 mol% ± 5% for the production segment.

Using the site, manufacturer, and measured data to calculate the emission factor equation terms, the total diaphragm pump emission factor was determined to be 446 scfd/pump ± 77%.

Stroke volume was calculated from pump manufacturers' data and site observations of manufacturer and model number. Density was calculated based upon observed site supply gas pressure, and frequency was based upon timed stroke intervals observed while on site. Operating time was estimated by site personnel (if seasonal), or was based upon the percent of pumps at the site that were operating during the visit. The emission factors shown above (in scfd/pump) have been corrected for the natural gas composition in the production segment of 78.8 mol % methane.

EF DATA SOURCES:

1. The report entitled *Methane Emissions from the Natural Gas Industry, Volume 13: Chemical Injection Pumps* (1) establishes the important emission-affecting characteristics.
2. Site visit data and reference material established the density from supply gas pressure at 30 psig.
3. For the piston pumps, the stroke volume was estimated from manufacturers' data of pumps found at each site.
4. Manufacturers' data for the diaphragm pumps provided scf of gas required to pump one gallon of chemical. This information was used with the calculated liquid displaced for a range of pumps to give an average gas volume.
5. The frequency of actuations per day was determined from 40 timing measurements taken at 12 sites. The operating time was determined from data at 13 sites.
6. Measurements of 5 diaphragm chemical injection pumps were provided from an emissions estimate program by the Canadian Petroleum Association.

EF ACCURACY:

Basis:

1. Operating time confidence bounds (at 90% confidence) were calculated by analysis of the spread of 7 sites for piston pumps and 10 sites for diaphragm pumps.
2. Actuation confidence bounds (at 90% confidence) were based on measurements from 7 sites for the piston pumps and 5 sites for the diaphragm pumps.
3. It was assumed that the manufacturers' data are completely accurate. Data for the piston pumps were based on information from 4 manufacturers. Diaphragm pump data were provided by 2 manufacturers.
4. 90% confidence bounds for each value were carried through error propagation to result in the final 90% confidence bound.

ACTIVITY FACTOR: 16,971 pumps in the production segment \pm 143 %

The number of gas actuated pumps used in the production segment was determined by establishing the ratio of the number of pumps to active wells (oil or gas) that market gas. Site data were organized into regions and regional values were determined. The regional ratios were then multiplied by the regional count of active wells that market gas in that region to produce the total count of chemical injection pumps in the region. Finally, regions were added together to determine the national number. The activity factor is then:

$$(1) \quad \text{National AF} = \sum_{i=1}^n (\text{Regional AF}) \quad \text{where } n = \text{total number of regions}$$

$$(2) \quad \text{Regional AF} = (R_j\text{'s}) \times (W)$$

where R_j = ratio of total pumps to total wells in Region j
where W = number of wells in the region

AF DATA SOURCES:

1. The active oil and gas wells are from A.G.A. *Gas Facts* (2). The active oil wells that market gas are determined by multiplying the total national active oil wells times the fraction that market gas. The fraction is determined from a Texas Railroad Commission lease study that shows the percent of oil leases that market the associated gas in Texas (3).
2. The pump counts were obtained during the site visits. Inactive, electrically driven, or air driven pumps were not counted.
3. Regional extrapolation by gas well count was used.

AF ACCURACY:

Basis:

1. The accuracy for the active gas wells is assigned by engineering judgement, based upon the fact that the number of active wells is tracked nationally and known accurately by A.G.A./DOE, etc.
2. The accuracy for the national AF is based upon error propagation from the production sites visited.

ANNUAL METHANE EMISSIONS: 1.5 Bscf \pm 203 %

The national annual emissions were determined by multiplying an emission factor for a typical pump by the population of chemical injection pumps in the production segment.

REFERENCES

1. Shires, T.M. *Methane Emissions from the Natural Gas Industry, Volume 13: Chemical Injection Pumps*, Final Report, GRI-94/0257.30 and EPA-600/R-96-080m, Gas Research Institute and U.S. Environmental Protection Agency, June 1996.
2. American Gas Association. *Gas Facts: 1993 Data*, Arlington, VA, 1994.
3. Texas Railroad Commission, P-1, P-2 Tapes, Radian files, Austin, TX, 1989.

P-6
PRODUCTION SOURCE SHEET

SOURCES:	Glycol Dehydrators
COMPONENTS:	N/A
OPERATING MODE:	Normal Operation
EMISSION TYPE:	Vented
ANNUAL EMISSIONS:	3.42 Bscf ± 192%

BACKGROUND:

Glycol dehydrators remove water from a gas stream by contacting the gas with glycol and then driving the water from the glycol by heating in the glycol reboiler and into the atmosphere. The glycol also absorbs a small amount of methane, and some methane can be driven off to the atmosphere through the reboiler vent.

EMISSION FACTOR: (275.57 scf/MMscf gas processed ± 154.48%)

A thermodynamic computer simulation was used to determine the most important emission-affecting variables for dehydrators. The variables are: gas throughput, existence of a flash tank, existence of stripping gas, existence of a gas driven pump, and existence of vent controls routed to a burner. Throughput, since its effect is linear, is handled by establishing an emission rate per unit of gas throughput. Emission rates per unit of throughput are then established for the other important emission affecting characteristics. Gas driven pumps are ignored here and handled in a separate source analysis (see *Methane Emissions from the Natural Gas Industry, Volume 15: Gas-Assisted Glycol Pumps*) (1). The emission factor is then:

$$\begin{aligned}
 EF &= [(F_{FT} \times EF_{FT}) + (F_{NT} \times EF_{NT}) + (F_{SG} \times EF_{SG})] \times F_{NVC} \times OC \\
 &= [(0.265 \times 3.57) + (0.735 \times 175.10) + (0.00473 \times 670)] \times 0.9882 \times 2.1 \\
 F_{FT} &= 0.265 \pm 8.35\% && \text{Fraction of the population WITH flash tanks} \\
 F_{NT} &= 0.735 \pm 2.99\% && \text{Fraction of the population WITHOUT flash tanks} \\
 F_{SG} &= 0.00473 \pm 115.78\% && \text{Fraction of the population WITH stripping gas} \\
 F_{NVC} &= 0.9882 \pm 0.87\% && \text{Fraction of the population WITHOUT combustion vent controls} \\
 EF_{FT} &= 3.57 \pm 102\%/-58\% && \text{Total methane emission rate scf per 1 MMscf throughput with a flash tank} \\
 EF_{NT} &= 175.10 \pm 101\%/-50\% && \text{Total methane emission rate scf per 1 MMscf throughput WITHOUT a flash tank} \\
 EF_{SG} &= 670 \pm 40\%/-60\% && \text{Incremental methane emission rate per 1 MMscf throughput per dehydrator that has stripping gas} \\
 OC &= 2.1 \pm 41\% && \text{Overcirculation factor for glycol--number of times the industry rule-of-thumb of 3 gallons glycol/lb water}
 \end{aligned}$$

EF DATA SOURCES:

1. *Methane Emissions from the Natural Gas Industry, Volume 14: Glycol Dehydrators* (2) establishes emission affecting characteristics of dehydrators.
2. GRI/EPA site visit data establishes the F_{SG} and F_{NVC} for multiple sites (19 PROD sites).
3. An analysis of a combined database including TMOGA's 1019 dehydrators and GRI/EPA site visits 444 dehydrators established F_{FD} and F_{ND} for production dehydrators.
4. ASPEN computer simulations were used in combination with measured data to determine EF_{FD} and EF_{ND} from the dehydrator vent.
5. Sampling data from the GRI Glycol Sampling and Analytical Program for one dehydrator was used to determine EF_{SG} (*Glycol Dehydrator Emissions: Sampling and Analytical Methods and Estimation Techniques*) (3). The upper bound was calculated by assuming that all of the measured noncondensable vent gas was due to stripping gas that was 100% methane. The lower bound was calculated as the rule-of-thumb stripping gas rate recommended by a glycol dehydrator manufacturer.
6. Circulation factor determined using data from the GRI Glycol Sampling and Analytical Program data for ten dehydrators.

EF PRECISION: 275.57 scf/MMscf gas processed \pm 154.48%

Basis:

The accuracy is propagated through the EF calculation from each term's accuracy:

1. ASPEN has been demonstrated to match actual dehydrators within $\pm 20\%$ within the calculated confidence intervals obtained from site data.
2. Individual EF confidence intervals were calculated from the data used in the calculation.
3. Data from site visits has been assigned confidence intervals based upon the spread of the 444 dehydrators from GRI/EPA site data.

ACTIVITY FACTOR: (12.4 Tscf/year gas throughput in the production segment)

The amount of gas processed by glycol dehydrators in the production segment was calculated from the estimated number of glycol dehydrators in production and the average throughput capacity for production dehydrators (Wright Killen and Co., 1994). A capacity utilization factor was estimated based on observations at several sites in the GRI Glycol Dehydrator Sampling and Analytical Program.

AF DATA SOURCES:

The report: *Natural Gas Dehydration: Status and Trends* (4) by Wright Killen for the Gas Research Institute, provides data and describes the methodology used to develop an estimate of the gas dehydrator count for the U.S. The count also estimated the number in several industry segments: production, transmission, and gas processing.

Basis:

1. A GRI study by Wright Killen & Co. found 41700 dehydrators in the U.S. gas industry for 1993. Wright Killen & Co. also used a TMOGA/GPA database on dehydrators to split the population into the following industry segments:

Production:	25270
Processing:	7923
Transmission:	8507
TOTAL:	41700

The study also found that 95.0 % of the dehydrators were glycol for a total of 39,615 (versus molecular sieve or other types).

2. Site visit data on 24 transmission compressor stations shows: 2/17 = 0.118 per transmission compressor station, and 17/6 = 2.83 per storage compressor station. The site visit numbers would lead to an estimate of 1293 total transmission and storage dehydrators. Site visit data on 11 gas plants show 1.41 dehydrators per plant, or 1,024 in gas plants.

Subtracting processing, transmission, and storage glycol dehydrators from the total of 39,615 yields 37824 glycol dehydrators in production.

3. Average capacity of production dehydrators was reported to be 2 MMscfd by Wright Killen & Co.

Information on actual dehydrator throughput as compared to design capacity is, in general, difficult to obtain especially for production field units. Data from several sites in the GRI Glycol Dehydrator Sampling and Analytical Program and other anecdotal information from various site visits indicate that capacity utilization may be less than 50%, so a value of 45% was chosen for the AF calculations.

AF PRECISION: 12.4 Tscf/year \pm 61.87%

Basis:

The 90% confidence limits for total glycol dehydrators were established in the Wright Killen & Co. report. The confidence limits for the segments other than production were based on site visit data. Confidence limits for the capacity utilization was based on engineering judgement.

ANNUAL METHANE EMISSIONS: (3.4171 Bscf/yr \pm 191.90%)

The annual methane emissions were determined by multiplying the dehydrator emission factor by the activity factor.

REFERENCES

1. Myers, D.B. and M.R. Harrison. *Methane Emissions from the Natural Gas Industry, Volume 15: Gas-Assisted Glycol Pumps*, Final Report, GRI-94/0257.43 and EPA-600/R-96-080o. Gas Research Institute and U.S. Environmental Protection Agency, June 1996.
2. Myers, D. *Methane Emissions from the Natural Gas Industry, Volume 14: Glycol Dehydrators*, Final Report, GRI-94/0257.31 and EPA-600/R-96-080n. Gas Research Institute and U.S. Environmental Protection Agency, June 1996.

3. Radian Corporation. *Glycol Dehydrator Emissions: Sampling and Analytical Methods and Estimation Techniques*. GRI-94/0324, Gas Research Institute, Chicago, IL, March 1995.
4. Wright Killen & Company. *Natural Gas Dehydration: Status and Trends*, Final Report. GRI-94/0099, Gas Research Institute, Chicago, IL, October 1993.

P-7
PRODUCTION SOURCE SHEET

SOURCES:	Dehydrators
COMPONENTS:	Gas Driven Kimray Pumps
OPERATING MODE:	Normal Operation
EMISSION TYPE:	Unsteady, Vented
ANNUAL EMISSIONS:	10.96 Bscf ± 110.0%

BACKGROUND:

Gas driven Kimray glycol circulation pumps use a mixed phase of wet glycol liquid and absorber gas to drive pistons that pump dry (lean) glycol circulation. Unlike chemical injection pumps which vent the driving gas directly to the atmosphere, Kimray pumps pass the driving gas along with the wet glycol to the reboiler. In the reboiler the methane is driven off into the vent line. Depending on dehydrator vent gas dispositions, the methane may be vented to the atmosphere or controlled and burned.

EMISSION FACTOR: (992.0 scf CH₄/MMscf gas processed)

The average glycol pump gas emission factor was determined by an equation describing the gas generation and disposition of gas from the pump. The disposition of gas generated by the pump depends upon the existence of a flash tank and vent controls. Measured and estimated parameters were input into the equation.

In general, the emission factor for a gas-assisted pump was determined by the following equation:

$$EF_{\text{pump}} = \text{PGU} \times \text{CR} \times \text{WR} \times \text{OC} \times F_{\text{NT}} \times F_{\text{NVC}}$$

EF DATA SOURCES:

1. Equation 1, i.e. the effects of operating variables on emissions, was defined by the report on *Methane Emissions from the Natural Gas Industry, Volume 15, Gas-Assisted Glycol Pumps*.(1)
2. CR = glycol circulation ratio = 3.0 gal glycol/lb water ± 33.3%.
3. WR = water removed from gas
 = 53 lb/MMscf ± 20% for high pressure
 = 127 lb/MMscf ± 20% for low pressure
4. OC = factor to account for overcirculation of glycol = 2.1 ± 71.4%.
5. F_{NT} = fraction of dehydrators without flash tanks = 0.735 ± 2.99%.
6. F_{NVC} = fraction of the dehydrators without combustion vent controls = 0.9882 ± 0.87%.
7. PGU = pump gas usage (assume 83% methane)
 = 3.73 scf CH₄/gal glycol ± 30% for high pressure

$$= 2.31 \text{ scf CH}_4/\text{gal glycol} \pm 30\% \text{ for low pressure}$$

CALCULATION METHOD:

It is estimated that 80% of the production dehydrators would be high pressure (R. Garrett memo). The overall production emission factor is then calculated as a weighted average of the high and low pressure emission factors.

$$\begin{aligned} \text{EF (high pressure)} &= (3.73 \text{ scf/gal}) \times (3.0 \text{ gal/lb H}_2\text{O}) \times (53 \text{ lb H}_2\text{O/MMscf}) \\ &\quad \times (2.1) \times (0.735) \times (0.9882) \\ &= 904.45 \text{ scf/MMscf} \pm 95.04\% \end{aligned}$$

$$\begin{aligned} \text{EF (low pressure)} &= (2.31 \text{ scf/gal}) \times (3.0 \text{ gal/lb H}_2\text{O}) \times (127 \text{ lb H}_2\text{O/MMscf}) \\ &\quad \times (2.1) \times (0.735) \times (0.9882) \\ &= 1342.18 \text{ scf/MMscf} \pm 95.04\% \end{aligned}$$

$$\begin{aligned} \text{EF (Production)} &= (0.80 \pm 12.5\%) (904.45 \text{ scf/MMscf} \pm 95.04\%) + \\ &\quad (0.20 \pm 50\%) (1342.18 \text{ scf/MMscf} \pm 95.04\%) \\ &= 992.00 \text{ scf CH}_4/\text{MMscf} \pm 77.29\% \end{aligned}$$

EF ACCURACY: ($\pm 77.29\%$)

Basis:

1. Assumption: The manufacturer's data and ranges are relatively accurate ($\pm 30\%$).
2. Dehydrator characteristics based on site visit observations and TMOGA survey.

ACTIVITY FACTOR: (11.05 Tscf/year in the production segment with gas-assisted pumps)

The volume of gas processed through dehydrators using gas-assisted pumps was calculated from the total throughput for production dehydrators and the fraction of dehydrators using gas-assisted pumps determined from site visits. The activity factor is then:

$$\begin{aligned} \text{AF} &= (\text{fraction of dehydrators with gas-assisted pumps}) \times (\text{throughput for production dehydrators}) \\ &= (0.8913 \pm 2.79\%) \times (12.4 \text{ Tscf/year} \pm 48.21\%) \\ &= 11.05 \text{ Tscf/year} \pm 61.96\% \end{aligned}$$

AF DATA SOURCES:

1. See *Methane Emissions from the Natural Gas Industry, Volume 14: Glycol Dehydrators* (2) for an explanation of production dehydrator throughput. See the *Methane Emissions from the Natural Gas Industry, Volume 5: Activity Factors* (3) for more details.
2. Fraction of dehydrators using gas-assisted pumps came from data from site visits.

AF ACCURACY: ($\pm 61.96\%$)

Basis:

Calculated from confidence limits of gas throughput and fraction of dehydrators by standard error propagation analysis.

ANNUAL METHANE EMISSIONS: (10.962 Bscf ± 110.03%)

The annual methane emissions were determined by multiplying an emission factor (scf CH₄/MMscf) by the total throughput for production dehydrators using gas-assisted pumps.

$$(992.00 \text{ scf/MMscf}) \times (11.05 \text{ Tscf}) = 10.962 \text{ Bscf } (\pm 110.03\%)$$

REFERENCES

1. Myers, D.B. and M.R. Harrison. *Methane Emissions from the Natural Gas Industry, Volume 15: Gas-Assisted Glycol Pumps*. Final Report, GRI-94/0257.33 and EPA-600/R-96-080o. Gas Research Institute and U.S. Environmental Protection Agency, June 1996.
2. Myers, D. *Methane Emissions from the Natural Gas Industry, Volume 14: Glycol Dehydrators*. Final Report, GRI-94/0257.31 and EPA-600/R-96-080n. Gas Research Institute and U.S. Environmental Protection Agency, June 1996.
3. Stapper, B.E. *Methane Emissions from the Natural Gas Industry, Volume 5: Activity Factors*. Final Report, GRI-94/0257.22 and EPA-600/R-96-080e. Gas Research Institute and U.S. Environmental Protection Agency, June 1996.

P-8
PRODUCTION SOURCE SHEET

SOURCES: Various Production Equipment
(wells, vessels, compressors, pipelines)
OPERATING MODE: Maintenance
EMISSION TYPE: Unsteady, Vented
ANNUAL EMISSIONS: 6.0 Bscf \pm 359%

BACKGROUND:

Maintenance activities can emit gas to the atmosphere through blowdown or through purge. Blowdown is the direct, intentional venting to the atmosphere of gas contained inside operating equipment. The gas is released to provide a safer working environment for maintenance activities around or inside the equipment. After the equipment is serviced, the oxygen inside the equipment is often cleared to the atmosphere by purging natural gas through the equipment.

Another type of maintenance venting is associated with low pressure gas wells that sometimes accumulate water in the wellbore due to their low flow rate. This water chokes the flow of the well, reducing gas production. To clear the water, the well is blown to a tank at atmospheric pressure where the gas is vented.

EMISSION FACTORS: Gas Well Unloading 49,570 \pm 344% scf/unloading gas well
Compressor Blowdown 3,774 \pm 147% scf/compressor
Compressor Starts 8,443 \pm 157% scf/compressor
Pipeline Blowdown 309 \pm 32% scf/mile
Vessel Blowdown 78 \pm 266% scf/vessel
(Emission factors were adjusted for the production methane fraction of natural gas of 78.8 mol%)

Blowdown volumes and frequencies were averaged from calculations for each GRI/EPA site visit. The volume times the frequency results in the annual emissions. The volumes were calculated at each site using equations of state, observed vessel dimensions, and pre-blowdown pressures. Frequencies were gathered at each site from operator interview. The annual emission factor (scf/unit) for each category was calculated as follows:

$$EF = \text{Volume} \times \text{Frequency} \times \% \text{ Methane}$$

where:

Volume = Gas released to the atmosphere during an event (scf/event/unit);
Frequency = Number of events annually;
% Methane = 78.8 mol % \pm 5% for the production segment.

More details are available in the *Methane Emissions from the Natural Gas Industry, Volume 7: Blow and Purge Activities* (1).

EF DATA SOURCES:

1. The blow and purge report establishes emission affecting characteristics of blowdown practices.

2. Volume and frequency data were available from the following number of sites:
 - LP Gas Well Unloading (12 sites)
 - Compressor Blowdown (17 sites)
 - Compressor Starts (12 sites)
 - Vessel BD (12 sites)
 - Pipeline BD (18 sites)
3. The count of equipment at each site was gathered during the site visits by observation, record search, or interview.

EF PRECISION: $\pm 32\%$ to 344%

Basis:

The accuracy was calculated from the variance of the site data. A 90% confidence interval is calculated for the sites using the method outlined in the *Methane Emissions from the Natural Gas Industry, Volume 4: Statistical Methodology* (2).

ACTIVITY FACTORS:

114,139 $\pm 45\%$ gas wells requiring unloading
 17,112 $\pm 52\%$ compressors
 340,000 $\pm 10\%$ miles of pipeline
 255,996 $\pm 26\%$ production vessels

The activity factors for equipment in the production segment were compiled from GRI/EPA site visit averages as well as published statistics on the gas industry (see activity factor sections in previous sheets). The number of production vessels was assumed to be the sum of separators, heaters, and dehydrators.

AF DATA SOURCES:

1. The well, compressor, and vessel counts came from the activity factor extrapolation based on GRI/EPA site visits or surveys (previously discussed in the production fugitives sheet). The count of "vessels" is from the addition of dehydrator, separator, and in-line heater counts.
2. The miles of production gathering pipelines were determined from a site extrapolation of seven sites and data from *Gas Facts* Table 5-3 (3). This extrapolation was previously discussed in the production gathering pipeline fugitive leaks sheet, P-3.
3. The number of gas wells requiring unloading is based on the ratio of gas wells requiring unloading to all active gas wells from 25 GRI/EPA sites ($41.4\% \pm 162\%$).

AF PRECISION: Range $\pm 10\%$ to 52%

Basis:

The accuracy for all equipment types is based on error propagation from the spread of available production site data.

ANNUAL METHANE EMISSIONS: 6.0 Bscf $\pm 359\%$

The annual methane emissions were determined by multiplying an emission factor (rate per average unit) for each category by the activity factor (population) of the category.

REFERENCES

1. Shires, T.M. and M.R. Harrison. *Methane Emissions from the Natural Gas Industry, Volume 7: Blow and Purge Activities*, Final Report, GRI-94/0257.24 and EPA-600/R-96-080g, Gas Research Institute and U.S. Environmental Protection Agency, June 1996.
2. Williamson, H.J., M.B. Hall, and M.R. Harrison. *Methane Emissions from the Natural Gas Industry, Volume 4: Statistical Methodology*, Final Report, GRI-94/0257.21 and EPA-600/R-96-080d, Gas Research Institute and U.S. Environmental Protection Agency, June 1996.
3. American Gas Association. *Gas Facts, 1992 Data* (Table 5-3), Arlington, VA, 1993.

P-9
PRODUCTION SOURCE SHEET

SOURCES: Various Production Equipment (vessels)
OPERATING MODE: Upsets
EMISSION TYPE: Unsteady, Vented
ANNUAL EMISSIONS: 0.3 Bscf ± 190%

BACKGROUND:

Upsets in process conditions can cause pressure rises that exceed the maximum design pressure for equipment. To prevent equipment overpressure and damage, pressure relief valves (PRVs) open and vent the excess gas to the atmosphere. These PRVs are spring loaded or pilot actuated valves that are designed to handle the upset conditions. A few offshore production facilities (but no onshore facilities) have Emergency Shutdown Systems (ESDs) that depressure the entire facility to a vent or a flare.

EMISSION FACTORS: PRV Discharge Blowdown $34 \pm 252\%$ scf/PRV
ESD Blowdown $257 \pm 200\%$ Mscf/platform
(Corrected for the production methane composition of 78.8 mol%)

Emergency blowdown volumes and frequencies were estimated at each site visited. The average volume of gas released at lift pressure was calculated for a typical PRV size and duration, and corrected for the fraction of PRVs that release gas to the atmosphere. ESD blowdown volumes were based on the platform volume and corrected for the fraction of platforms with ESDs and the fraction that vent gas to the atmosphere. The annual emission factor (scf/unit) for each category was calculated as follows:

$$EF = \text{Volume} \times \text{Frequency} \times \% \text{ Methane}$$

where:

Volume = Gas released to the atmosphere during an event (scf/event/unit);
Frequency = Number of events per year;
% Methane = 78.8 mol % ± 5% for the production segment.

EF DATA SOURCES:

1. The GRI/EPA *Methane Emissions from the Natural Gas Industry, Volume 7: Blow and Purge Activities* (1) establishes emission affecting characteristics of blowdown practices.
2. Volumes (duration, release rate, % to atmosphere) and frequencies were calculated from each site visit based on data collection, observation, and interview. Data were available from the following number of sites:
 - PRV discharge (11 sites)
 - ESD activation (5 platforms)
3. The count of equipment at each site was gathered during the site visits by observation, record search, or interview.

EF PRECISION:

Basis:

The accuracy was propagated from the spread of the site data. A 90% confidence interval is calculated using the method presented in the *Methane Emissions from the Natural Gas Industry, Volume 4: Statistical Methodology* (2).

ACTIVITY FACTORS: 529,440 ± 53% Production PRVs
1,115 ± 10% Platforms

The activity factors for equipment types in the segment were compiled from GRI/EPA site visit data as well as published statistics on the gas industry.

AF DATA SOURCES:

1. The count of platforms is from Offshore Data Services and the Minerals Management System Outer Continental Activity Database as reported in *Methane Emissions from the Natural Gas Industry, Volume 5: Activity Factors* (3).
2. The number of production PRVs is based on counts of PRVs per equipment type from site visit data:

Equipment Type	PRV Count	Number of Sites
Separators	2 ± 68%	20
Heaters	1 ± 89%	11
Dehydrators	2 ± 53%	10
Compressors	4 ± 84%	13

Details are provided in the *Methane Emissions from the Natural Gas Industry, Volume 8: Equipment Leaks* report (4).

AF PRECISION: Range ± 10% to 53%

Basis:

1. Confidence intervals for the platform count were assumed and assigned based upon an excellent recorded source of data [see *Methane Emissions from the Natural Gas Industry, Volume 5: Activity Factors* (3)].
2. Ninety percent confidence limits for production vessels with PRVs were calculated from the confidence intervals of each type of equipment. See *Methane Emissions from the Natural Gas Industry, Volume 5: Activity Factors* (3) for details of equipment count determination.

ANNUAL METHANE EMISSIONS: 0.30 Bscf ± 190%

The annual methane emissions were determined by multiplying an emission factor (rate per avg unit) by the activity factor (population) of the category. Each emission factor was adjusted for the average methane content in the production segment of 78.8 mol%.

REFERENCES

1. Shires, T.M. and M.R. Harrison. *Methane Emissions from the Natural Gas Industry, Volume 7: Blow and Purge Activities*, Final Report, GRI-94/0257.24 and EPA-600/R-96-080g, Gas Research Institute and U.S. Environmental Protection Agency, June 1996.
2. Williamson, H.J., M.B. Hall, and M.R. Harrison. *Methane Emissions from the Natural Gas Industry, Volume 4: Statistical Methodology*, Final Report, GRI-94/0257.21 and EPA-600/R-96-080d, Gas Research Institute and U.S. Environmental Protection Agency, June 1996.

3. Stapper, B.E. *Methane Emissions from the Natural Gas Industry, Volume 5: Activity Factors*, Final Report, GRI-94/0257.22 and EPA-600/R-96-080e, Gas Research Institute and U.S. Environmental Protection Agency, June 1996.
4. Hummel, K.E., L.M. Campbell, and M.R. Harrison. *Methane Emissions from the Natural Gas Industry, Volume 8: Equipment Leaks*, Final Report, GRI-94/0257.25 and EPA-600/R-96-080h, Gas Research Institute and U.S. Environmental Protection Agency, June 1996.

P-10
PRODUCTION SOURCE SHEET

SOURCES: Pipeline
OPERATING MODE: Mishaps (Dig-ins)
EMISSION TYPE: Unsteady, Fugitive
ANNUAL EMISSIONS: 0.2 Bscf \pm 1,934%

BACKGROUND:

Dig-ins are gathering pipeline ruptures caused by unintentional (sometimes third-party) damage. Production companies do NOT estimate and record the quantity of gas lost during a dig-in event; therefore, distribution data has been used.

EMISSION FACTOR: 669 \pm 1,925% scf/mile
(Corrected for the production methane composition of 78.8 mol%)

The emission factor was derived from four distribution company estimates of the losses from dig-ins: the Pacific Gas and Electric unaccounted-for (UAF) gas study (1) results showed that losses from dig-ins were estimated at 91,178 Mscf for 58,024 miles of distribution mains and services; the Southern California Gas Company estimate (2) of losses from dig-ins was 170,457 Mscf for 82,337 miles of distribution mains and services; a third company estimate of losses from dig-ins was 19,581 Mscf for 24,916 miles of distribution mains and services; and a fourth company reported dig-in losses of 10,453 Mscf for 18,713 miles of distribution mains. The ratio of the total dig-in emissions to the total pipeline miles from these companies was used to estimate the annual national methane emission factor, resulting in 2.06 Mscf/mile.

This value was halved (and adjusted for the different methane compositions of the two industry segments) based upon an engineering assumption that production dig-ins occur much less frequently than distribution dig-ins, and so account for approximately one-half of the distribution emission rate per mile. This is supported by the fact that most production sites are remotely located, while distribution sites are by definition located in population centers where third-party dig-ins are more likely.

ACTIVITY FACTOR: 340,000 \pm 10% miles of production gathering pipeline

The annual number of miles of gathering pipeline in the U.S. gas industry was derived from site data. See P-3 and *Methane Emissions from the Natural Gas Industry, Volume 5: Activity Factors* (3) for more details.

ANNUAL METHANE EMISSIONS: 0.23 Bscf \pm 1,934%

REFERENCES

1. Pacific Gas & Electric Company and Gas Research Institute. *Unaccounted-For Gas Project*. Volume 1, Final Report, San Ramon, CA, June 1990.
2. Southern California Gas Company and Gas Research Institute. *A Study of the 1991 Unaccounted-For Gas Volume at the Southern California Gas Company*, Final Report, Los Angeles, CA, April 1993.
3. Stapper, B.E. *Methane Emissions from the Natural Gas Industry, Volume 5: Activity Factors*, Final Report, GRI-94/0257.22 and EPA-600/R-96-080e, Gas Research Institute and U.S. Environmental Protection Agency, June 1996.

P-11
PRODUCTION SOURCE SHEET

SOURCES: Gas Wells
 OPERATING MODE: Maintenance
 EMISSION TYPE: Venting and Flaring
 ANNUAL EMISSIONS: 0.02 Bscf ± 1,263%

BACKGROUND:

Two minor sources of maintenance releases are completion flaring and well workover. Completion flaring occurs at a new well's open ended pipe flare immediately following the drilling process. During completion testing, the gas is flared to determine the available pressure and flow rates at the surface. This allows proper sizing of meters and surface equipment. Most completion flaring occurs at exploratory wells, since the production rates and needed facilities for in-fill wells (also called development wells) are often available or can be determined before the well is completed.

Well workovers are another type of maintenance venting. During a well workover, the tubing is pulled from the well to repair tubing corrosion/erosion or other downhole equipment problems. The well is "killed" by replacing the gas in the column with water or mud, thus stopping all production flow. The well can then be opened to the atmosphere.

EMISSION FACTORS: Completion Flaring 733 ± 200% scf/completion well
 Well Workovers 2,454 ± 459% scf/well workover
 (Emission factors were adjusted for the production methane fraction of natural gas of 78.8 mol%.)

The flow rate of gas at completion is the highest that the well will produce. For emission estimate purposes, the maximum gas flow rate was not available. Instead, the completion flaring emission factor was calculated based on the average annual natural gas production per well and an assumed flaring efficiency as shown:

where: $EF_{\text{completion flaring}} = \text{Average Annual Volume} \times \text{Duration} \times \% \text{ Methane} \times \text{Flaring Efficiency}$

Average Annual Volume	=	16.97 MMscf for natural gas
Duration	=	Flaring duration is one day/completion well
% Methane	=	78.8 mol% for production
Flaring Efficiency	=	98% efficient (2% methane not burned)

This results in an emission factor of 733 ± 200% scf/completion well for completion flaring.

The emission factor for well workovers was determined from two gas production fields. Data from these fields are shown in the following table:

	Site 1	Site 2
Total number of wells	21	400
Number of workovers/year	1	8
Methane emissions/workover, scf/workover	670	4,238
Average scf methane/workover	2,454 ± 459%	

EF DATA SOURCES:

1. One operator provided data on the typical duration of completion flaring and which types of completions were flared. Average is one day/exploratory completion well.
2. Average gas production per well from *Gas Facts* (1).
3. Multiple reports on methane flare combustion efficiency support 98% combustion.
4. Pipeline Systems Incorporated (PSI) reported gas well workover emissions from two sites (2).

EF PRECISION: $\pm 200\%$ to 459%

1. Engineering judgement was used to establish the upper confidence limit for the completion flaring emission factor.
2. Confidence bound for well workover emission factor is based on the average of data from two sites.

ANNUAL ACTIVITY FACTORS:

844 $\pm 10\%$ completed gas wells

9,329 $\pm 258\%$ well workovers

AF DATA SOURCES:

1. Number of exploratory wells completed per year based on data from the Energy Information Administration (EIA) Drilling and Production under Title I of the Natural Gas Policy Act (3). This data excludes Alaska.
2. PSI data showed 1 workover/yr per 21 wells at Site 1 and 1 workover/yr per 50 wells at Site 2.
3. The Activity Factors Report (4) provides details on the total number of gas producing wells (276,014 $\pm 5\%$).

AF PRECISION: Range $\pm 10\%$ to 258%

1. 10% upper confidence bound for completion wells is assigned based on good precision from national statistics of 1987 data.
2. Well workover confidence interval is based on the average of data from two sites combined with the confidence bound for the total number of gas producing wells.

ANNUAL METHANE EMISSIONS:

Completion Wells: 619 $\pm 201\%$ Mscf

Well Workovers: 22.9 $\pm 1296\%$ MMscf

The annual methane emissions were determined by multiplying an emission factor (methane emissions per event) for each category by the activity factor (events/year) of the category.

REFERENCES

1. American Gas Association. *Gas Facts: 1992 Data* (Table 3-3), Arlington, VA, 1993.
2. Pipeline Systems Incorporated. *Annual Methane Emission Estimate of the Natural Gas Systems in the United States, Phase 2*. For Radian Corporation, September 1990.
3. Energy Information Administration. *Annual Energy Review 1994*, Table 4.5 "Oil and Gas Exploratory Wells, 1949-1994." EIA, Office of Oil and Gas, U.S. Department of Energy, DOE/EIA-0384(94), Washington, DC, July 1995.
4. Stapper, B.E. *Methane Emissions from the Natural Gas Industry, Volume 5: Activity Factors*, Final Report, GRI-94/0257.22 and EPA-600/R-96-080e, Gas Research Institute and U.S. Environmental Protection Agency, June 1996.

APPENDIX B
Gas Processing Source Sheets

APPENDIX B

Gas Processing Source Sheets

	<u>Page</u>
GP-1 - Fugitive Emissions	B-4
GP-2 - Glycol Dehydrator Vents	B-9
GP-3 - Acid Gas Removal (AGR) Vents	B-11
GP-4 - Maintenance Venting	B-13
GP-5 - Glycol Pumps	B-15
GP-6 - Pneumatic Devices	B-18

PROCESSING SOURCE SHEETS

This section contains the specific source sheets for the processing (gas plant) segment of the natural gas industry. The following table serves as a guide for finding sheets in this section. The cells in the table give the sheet number (GP-1, GP-2, etc.) of the source sheet. The rows define the equipment covered, while the columns define the emission type. A category with no sheet number means that the emissions from that area were determined to be zero or negligibly small. The label for each source sheet is shown at the top of the cover page for that sheet.

TABLE OF CONTENTS	OPERATING MODE, EMISSION TYPE (Fugitive, Vented, or Combusted)									
	Start Up		Normal Operations			Maintenance		Upsets		Mishaps
	V	C	F	V	C	V	C	V	C	V
Entire Plants			GP-1	GP-6		GP-4		GP-4		
Vessels			GP-1	GP-6		GP-4		GP-4		
Acid Gas Removal (AGR) Units			GP-1	GP-3 GP-6		GP-4		GP-4		
Dehydrators			GP-1	GP-2 GP-5 GP-6		GP-4		GP-4		
Compressors			GP-1	GP-6	P-1	GP-4		GP-4		
Metering			GP-1			GP-4		GP-4		

**GP-1
PROCESSING SOURCE SHEET**

SOURCES:	All Equipment at Gas Processing Plants
OPERATING MODE:	Normal Operation
EMISSION TYPE:	Steady and Unsteady, Fugitive
ANNUAL EMISSIONS:	24.45 Bscf ± 68%

BACKGROUND:

Equipment leaks are typically low-level, unintentional losses of process fluid (gas or liquid) from the sealed surfaces of above-ground process equipment. Equipment components that tend to leak include valves, flanges and other connectors, pump seals, compressor seals, pressure relief valves, open-ended lines, and sampling connections. These components represent mechanical joints, seals, and rotating surfaces, which in time tend to wear and develop leaks.

EMISSION FACTOR:

- a. Plant = 2.89 MMscf/yr methane per plant
- b. Reciprocating Compressor = 4.09 MMscf/yr methane per recip
- c. Centrifugal Compressor = 7.75 MMscf/yr methane per turbine

The average fugitive emission rate for gas processing plants was determined to be composed of two parts: a) plant component counts (excluding compressor components), and b) compressor-related components. Fugitives from the compressor-related components have much higher emission factors than components in the rest of the facility. Part of this is due to the high vibration that compressors generate, but most of the larger emissions are due to unique compressor components, as explained below.

a. The contribution from non-compressor components was determined by multiplying the average component count by the component emission factor. The number of components was subdivided into valves, connections/flanges, small open-ended lines, site blowdown (B/D) OELs, control valves, and other components (such as pressure relief valves). (Tubing components were determined to be insignificant.) All of these components are typical fugitive components [as described in the EPA Fugitive Emissions Protocol (1)] with the exception of control valves and site B/D OELs. Control valves emit at a higher rate than manual isolation valves since their packing is stressed more often as they are activated much more frequently. Site B/D OELs are the large diameter emergency station blowdown valves that are designed to depressure the entire site to the atmosphere when the valve is opened.

The component emission factors for gas plant components (i.e., non-compressor related) were based on an API/GRI measurement program conducted at 8 gas plants. The average facility emissions are then calculated as follows:

$$EF = [(N_{vlv} \times EF_{vlv}) + (N_{cn} \times EF_{cn}) + (N_{oel} \times EF_{oel}) + (N_{prv} \times EF_{prv}) + (N_{site\ B/D} \times EF_{site\ B/D})]$$

where:

N_x = average count of components of type x per plant, and

EF_x = average methane emission rate per component of type x.

b. The contribution from compressor-related components was obtained by multiplying the average number of fugitive components per compressor engine by component emission factors. The component emission factors were based on the GRI/Indaco measurement program conducted at 15 compressor stations. Some compressor

components are unique, while others have higher leak rates than identical components elsewhere in the plant due to vibration. Compressors have the following types of components:

- 1) Comp. B/D OEL A blowdown (B/D) valve to the atmosphere that can depressure the compressor when idle. The B/D valve or the large unit block valves (depending on the operating status of the compressor) can act as an open-ended line that leaks at an extraordinarily high rate through the valve seat. The leak rate is dependent upon whether the compressor is pressurized (in operation or idle, pressurized) or depressurized (idle, depressurized).
- 2) Comp. PRV The pressure relief valve (PRV) is usually installed on a compressor discharge line, and leaks at a higher than average rate due to vibration.
- 3) Comp. Starter OEL Most compressors have a gas starter motor that turns the compressor shaft to start the engine. Some use natural gas as the motive force to spin the starter's turbine blades, and vent the discharge gas to the atmosphere. The inlet valve to the starter can leak and is therefore an OEL unique to compressors.
- 4) Comp. Seal All compressors have a mechanical or fluid seal to minimize the flow of pressurized natural gas that leaks from the location where the shaft penetrates the compression chamber. These seals are vented to the atmosphere. Reciprocating compressors have sliding shaft seals while centrifugal compressors have rotating shaft seals.
- 5) Miscellaneous There are many components on each compressor, such as valve covers on reciprocating compressor cylinders and fuel valves.

Each compressor has one B/D OEL, one PRV, and one starter OEL. Reciprocating compressors have one compressor seal per compression cylinder (which averaged 2.5 per engine), while centrifugal compressors have 1.5 seals per gas turbine. For the miscellaneous component category, there are many components per compressor engine, but the emission rates were minor and so were added into one lump emission factor per compressor for miscellaneous components.

All of the compressor emission factors take several correction factors into account. First, the various phases of compressor operations [such as the amount of time that compressors are a) idle and depressured, b) idle and pressured up, or c) running]. This is actually a complex adjustment that takes into account valve position practices. [See Methane Emissions from the Natural Gas Industry, Volume 8: Equipment Leaks (2) for details.] Correction factors were also added for fraction of starter gas turbines using air instead of gas (75% for recip, 33% for turbines in gas processing), and for sites with flares handling PRV or compressor B/D discharge (approximately 11% of the compressor blowdown OELs were routed to a plant flare).

EF DATA SOURCES:

1. Component emission factors based on screening results from API/GRI/Star program for the component EF's for eight gas processing plants and EPA's current default zero factors, correlation equations, and pegged source factors. Confidence limits derived from analysis of screening data by Radian in April 1995.
2. OEL (site B/D) emission factor based on results from GRI/Indaco program for compressor stations (June 1994).
3. Plant component counts were based on average of 8 API/Star sites, 6 EPA/Radian sites in 1982, and 7 sites visited under this project in 1992.
4. Compressor emission factors based on results from GRI/Indaco program for 15 compressor stations (June 1994). Compressor operating hours (% running) based on data from 3 gas processing company databases.

Average Facility Emissions for Gas Processing

Equipment Type	Component Type	Component Emission Factor, Mscf/component-yr	Average Component Count	Average Equipment Emissions, ^a MMscf/yr
Gas Plant (non-compressor related components)	Valve	1.305	1,392	2.89 (48%)
	Connection	0.117	4,392	
	Open-Ended Line	0.346	134	
	Pressure Relief Valve	0.859	29	
	Site Blowdown Open-Ended Line	230	2	
Reciprocating Compressor	Compressor Blowdown Open-Ended Line	2,036 ^{b,c}	1	4.09 (74%)
	Pressure Relief Valve	349 ^{b,c}	1	
	Miscellaneous	189 ^c	1	
	Starter Open-Ended Line	1,341	0.25 ^e	
	Compressor Seal	450 ^c	2.5	
Centrifugal Compressor	Compressor Blowdown Open-Ended Line	6,447 ^{b,d}	1	7.75 (39%)
	Miscellaneous	31 ^d	1	
	Starter Open-Ended Line	1,341	0.667 ^f	
	Compressor Seal	228 ^d	1.5	

^a Values in parentheses represent 90% confidence interval.

^b Adjusted for 11.1% of compressors which have sources routed to flare.

^c Adjusted for 89.7% of time reciprocating compressors in processing are pressurized.

^d Adjusted for 43.6% of time centrifugal compressors in processing are pressurized.

^e Only 25% of starters for reciprocating compressors in processing use natural gas.

^f Only 66.7% of starters for centrifugal compressors in processing use natural gas.

- EF ACCURACY:
- a. Plant Emission Factor = $\pm 48\%$
 - b. Recip. Compressor = $\pm 74\%$
 - c. Turbine Compressor = $\pm 39\%$

Basis:

1. The accuracy was propagated through the EF calculation from each terms accuracy. 90% confidence intervals were calculated for the sites using the t-statistic method. The 90% confidence intervals accounted for variability in component count from the range in site averages and estimates were also provided for the component emission factors from the API/Star and GRI/Indaco program.

- ACTIVITY FACTOR
- a. Plant Activity Factor = 726 plants
 - b. Compressor Activity Factor = 4092 recip engines, 726 turbines

The number of gas processing plants was determined from the *Oil and Gas Journal* (3) (July 1993). The number and type of gas processing compressor engines were determined from eleven gas plant site visits. The average ratio of compressors per plant was multiplied by the total number of plants, 726, to obtain these estimates. [See Methane Emissions from the Natural Gas Industry, Volume 5: Activity Factors (4) for details.]

AF DATA SOURCES: *Oil and Gas Journal* (July 1993) (3)

- AF ACCURACY:
- a. Plant Activity Factor: $\pm 2\%$
 - b. Compressor Activity Factor: Recip engines = $\pm 48\%$; Turbines = $\pm 77\%$

Basis:

1. An accurate count of gas plants by the *Oil and Gas Journal* (3) is very likely since counting such large, discreet facilities should be straightforward. The $\pm 2\%$ was assigned by engineering judgement.
2. The compressor count accuracy was determined by statistical analysis of the "compressor per site" averages for 11 gas plant sites.
3. A check was performed to estimate whether gas plant sites visited for compressor counts were representative of industry average. Based on *Oil and Gas Journal* (3), the average plant capacity was 88.3 MMscfd and throughput was 51.2 MMscf/d. Site visit data averaged 271 MMscfd and throughput was 182 MMscf/d, suggesting that plants visited were larger than average. However, further investigation revealed that there is no correlation between plant capacity/throughput and number of compressors (The plant visited with the most compressors had 20 engines with 20,000 HP and a low throughput of 56 MMscfd, while the plant with the highest current operating rate of 750 MMscfd had only one compressor at 17,500 HP.)

ANNUAL EMISSIONS: (24.45 Bscf/yr \pm 16.7 Bscf/yr)

The annual emissions were determined by multiplying the average equipment/facility emissions by the population of equipment in the segment.

Category	Emission Factor	Activity Factor	Emission Rate	Uncertainty
Gas processing plants	2.89 MMscf/yr methane	726 plants	2.1 Bscf/yr methane	48%
Recip Comp	4.09 MMscf/yr methane	4092 recip	16.7 Bscf/yr methane	95%
Turbine Comp	7.75 MMscf/yr methane	726 turbine	5.6 Bscf/yr methane	91%
TOTAL			24.4 Bscf/yr methane	68%

REFERENCES

1. Hausle, K.J., *Protocol for Fugitive Leak Emission Estimates*, Final Report, EPA-453/R-93-026, U.S. Environmental Protection Agency, June 1993. *
2. Hummel, K.E., L.M. Campbell, and M.R. Harrison. *Methane Emissions from the Natural Gas Industry, Volume 8: Equipment Leaks*, Final Report, GRI-94/0257.25 and EPA-600/R-96-080h, Gas Research Institute and U.S. Environmental Protection Agency, June 1996.
3. *Oil and Gas Journal*. 1992 Worldwide Gas Processing Survey Database, 1993.
4. Stapper, B.E. *Methane Emissions from the Natural Gas Industry, Volume 5: Activity Factors*, Final Report, GRI-94/0257.22 and EPA-600/R-96-080e, Gas Research Institute and U.S. Environmental Protection Agency, June 1996.

(*) NTIS PB93-229219.

**GP-2
PROCESSING SOURCE SHEET**

SOURCES:	Glycol Dehydrators
COMPONENTS:	Reboiler Vent
OPERATING MODE:	Normal Operation
EMISSION TYPE:	Unsteady, Vented
ANNUAL EMISSIONS:	1.05 Bscf ± 208%

BACKGROUND:

Glycol dehydrators remove water from a gas stream by contacting the gas with glycol and then driving the water from the glycol and into the atmosphere. The glycol also absorbs a small amount of methane, and some methane can be driven off to the atmosphere through the reboiler vent.

EMISSION FACTOR: (121.55 scf/MMscf ± 201.96%)

A thermodynamic computer simulation was used to determine the most important emission-affecting variables for dehydrators. The variables are: (gas throughput, existence of a flash tank, existence of stripping gas, existence of a gas-assisted pump, existence of vent controls routed to a burner). Throughput, since its effect is linear, is handled by establishing an emission rate per gas throughput. Emission rates per throughput are then established for the other important emission affecting characteristics. Gas driven pumps are ignored here and handled in a separate source analysis. The emission factor is then:

$$EF = [(F_{FT} \times EF_{FT}) + (F_{NT} \times EF_{NT}) + (F_{SG} \times EF_{SG})] \times F_{NVC} \times OC$$

$$EF = [(0.667 \times 3.57) + (0.333 \times 175.10) + (0.111 \times 670)] \times 0.900 \times 1.0$$

F_{FT}	Fraction of the population WITH flash tanks 0.667 ± 10.13%
F_{NT}	Fraction of the population WITHOUT flash tanks = 1- F_{FT} 0.333 ± 20.12%
F_{SG}	Fraction of the population WITH stripping gas 0.111 ± 186%
F_{NVC}	Fraction of the population WITHOUT combusted vent controls 0.90 ± 10%
EF_{FT}	Total CH ₄ emission rate per 1 MMscf throughput for dehydrator that has a flash tank 3.57 (+102% / -58%)
EF_{NT}	Total CH ₄ emission rate per 1 MMscf throughput for dehydrator that does NOT have a flash tank 175.10 (+101% / -50%)
EF_{SG}	Incremental emission rate per 1 MMscfd throughput for dehydrator that has stripping gas 670 (+40% / -60%)
OC	Overcirculation factor for glycol--number of times the industry rule-of-thumb of 3 gallons glycol/lb water 1.0 ± 0%

EF DATA SOURCES:

1. *Methane Emissions from the Natural Gas Industry, Volume 14: Glycol Dehydrators* (1) establishes emission affecting characteristics of dehydrators.
2. Site visit data establish the F_{SG} and F_{NVC} for multiple sites (7 PROC sites with dehydrators).
3. TMOGA/GPA survey of 207 gas plant dehydrators established F_{3P} and F_{ND} and TP for dehydrators for the processing segment.
4. ASPEN computer simulations were used to determine EF_{3P} and EF_{ND} from the dehydrator vent.
5. Sampling data from the GRI Glycol Dehydrator Sampling and Analytical Program for one dehydrator was used to determine EF_{SG} (*Glycol Dehydrator Emissions: Sampling and Analytical Methods and Estimation Techniques*) (2). The upper bound was calculated by assuming that all of the measured noncondensable vent gas was due to stripping gas that was 100% methane. The lower bound was calculated as the rule-of-thumb stripping gas rate recommended by a glycol dehydrator manufacturer.

EF ACCURACY 121.55 scf/MMscf \pm 201.96%

Basis:

The accuracy is rigorously propagated through the EF calculation from each term's accuracy:

1. ASPEN has been demonstrated to match actual dehydrators within \pm 20% within the calculated confidence intervals obtained from site data.
2. Individual EF confidence intervals were calculated from the other data based upon the spread of the 11 site averages.

ACTIVITY FACTOR: (8.63 Tscf/year gas throughput in the gas processing segment)

The glycol dehydrator throughput is estimated from the fraction of gas processed by refrigerated processes (as opposed to dry bed dehydration for cryogenic processes). The estimate was obtained from the *Oil & Gas Journal* (3) annual Gas Processing Survey. Of a total of 17.44 Tscf, 8.63 Tscf were determined to be dehydrated by glycol.

AF ACCURACY: 8.63 Tscf/year \pm 22.45%

Basis:

1. Uncertainty based on estimate of confidence limits for *Oil and Gas Journal* survey.

AF DATA SOURCES:

1. *Oil & Gas Journal* (3) annual Gas Processing Survey.

ANNUAL METHANE EMISSIONS: (1.0490 Bscf \pm 208.20%)

The annual methane emissions were determined by multiplying the dehydrator emission factor by the activity factor.

REFERENCES

1. Myers, D.B. *Methane Emissions from the Natural Gas Industry, Volume 14: Glycol Dehydrators*, Final Report, GRI-94/0257.31 and EPA-600/R-96-080n. Gas Research Institute and U.S. Environmental Protection Agency, June 1996.
2. Radian Corporation. *Glycol Dehydrator Emissions: Sampling and Analytical Methods and Estimation Techniques*. GRI-94/0324, Gas Research Institute, Chicago, IL, March 1995.
3. *Oil & Gas Journal*. 1992 Worldwide Gas Processing Survey Database, 1993.

**GP-3
PROCESSING SOURCE SHEET**

SOURCES: Acid Gas Removal (AGR) Units
OPERATING MODE: Normal Operation
EMISSION TYPE: Unsteady, Vented
ANNUAL EMISSIONS: 0.82 Bscf \pm 109%

BACKGROUND:

AGR units remove acid gas (H₂S and CO₂) from a natural gas stream by contacting the gas with material (usually amines) and then driving the absorbed components from the solvent. The amines can also absorb a small amount of methane, and some methane can be driven off to the atmosphere through the reboiler vent to the atmosphere.

EMISSION FACTOR: (6083 scfd/avg AGR)

AGRs were assumed to have an absorption of methane similar to water, since the typical AGR solution contains over 50% water. The methane emissions were calculated using an ASPEN PLUS process simulation based on an actual DEA unit (1). AGRs were assumed to have no three-phase flash tanks nor stripping gas. The average AGR throughput (MMscfd) was determined from a 1982 API study, and multiplied times the emission rate (CH₄/MMscfd). The emission factor is then:

$$EF = EF_{NT} \times F_{NVC} \times TP$$

F_{NVC} = Fraction of the AGRs that do vent the waste stream
0.18 \pm 10%

TP = Average throughput for AGRs (MMscfd)
35.02 \pm 20%

EF_{NT} = Total "CH₄ scfd emission rate per 1 MMscfd throughput" for an AGR
965 \pm 100%

EF DATA SOURCES:

1. ASPEN PLUS process simulations based on an actual DEA unit were used to determine EF_{NT} from the reboiler vent. It was assumed that AGRs have an absorption of methane similar to water.
2. 1982 API Survey, quoted in Investigation of US Natural Gas Reserve Demographics and Gas Treatment Processes, shows 287 AGR units, with a cumulative throughput of 10052 MMscfd (2). The survey also shows split of AGR vent dispositions: 50% burned, 32% to sulfur recover, and 18% vented.

EF ACCURACY: 6083 \pm 104.92%

Basis:

1. The accuracy is based upon engineering judgement that the methane solubility in AGR solutions is similar to the solubility in water.

ACTIVITY FACTOR: (371 active AGR units in the U.S.)

The number of AGR units in the U.S. have all been assumed to be in the processing segment. The activity factor was extracted from the Purvin & Gertz survey.

AF DATA SOURCES:

1. Purvin & Gertz, *Business Characteristics of the Natural Gas Conditioning Industry* (3), 1993.

AF ACCURACY: 371 ± 20%

Basis:

1. The accuracy is based upon engineering judgement. The survey should have excellent accuracy (± 5%), but the upper bound at 90% confidence was revised upward to 20% to be conservative.

ANNUAL METHANE EMISSIONS: (0.8237 Bscf ± 108.85%)

The annual methane emissions were determined by multiplying an emission factor for an average dehydrator by the population of AGRs in the segment.

REFERENCES

1. Myers, D. *Methane Emissions from the Natural Gas Industry, Volume 14: Glycol Dehydrators*. Final Report, GRI-94/0257.31 and EPA-600/R-96-080n. Gas Research Institute and U.S. Environmental Protection Agency, June 1996.
2. Radian Corporation. *Investigation of U.S. Natural Gas Reserve Demographics and Gas Treatment Processes*, Topical Report, Gas Research Institute, January 1991.
3. Tannehill, C.C. and C. Galvin. *Business Characteristics of the Natural Gas Conditioning Industry*, Topical Report. GRI Contract 5088-221-1753, Gas Research Institute, May 1993.

**GP-4
PROCESSING SOURCE SHEET**

SOURCES: All Equipment (vessels, compressors, pig traps, manifolds)
OPERATING MODE: Maintenance
EMISSION TYPE: Unsteady, Vented
ANNUAL EMISSIONS: 3.0 Bscf \pm 262%

BACKGROUND:

Blowdown is the direct, intentional venting to the atmosphere of gas contained inside operating equipment. The gas is released to provide a safer working environment for maintenance activities around or inside the equipment.

EMISSION FACTOR: 4,060 \pm 262% Mscf/gas plant
(Corrected for the gas processing methane composition of 87 mol%)

Blowdowns at gas plants consist primarily of the following types of events: compressor blowdown, compressor starts, pipeline pig receiver blowdown, and miscellaneous vessel blowdown. Due to the similarities in station blowdown practices between the gas processing and transmission segments, transmission station company tracked data were applied to gas plants. Blowdown volumes per station were provided based on company tracked data from 9 transmission companies.

EF DATA SOURCES:

1. The *Methane Emissions from the Natural Gas Industry, Volume 7: Blow and Purge Activities* (1) establishes emission affecting characteristics of blowdown practices.
2. Company tracked data were provided from 9 transmission companies representing a total of 328 stations.

EF ACCURACY: \pm 262%

Basis:

The accuracy was calculated from the spread of the company tracked data. A 90% confidence interval is calculated for the data using the method presented in *Methane Emissions from the Natural Gas Industry, Volume 4: Statistical Methodology* (2).

ACTIVITY FACTOR 726 \pm 2% gas plants

AF DATA SOURCES:

1. The number of gas processing plants for 1992 is repeated in the *Oil and Gas Journal* (3).

AF ACCURACY:

Basis:

An accurate count of gas plants by the *Oil and Gas Journal* is very likely since counting such large, discrete facilities should be straightforward. The \pm 2% was assigned by engineering judgement.

ANNUAL METHANE EMISSIONS: 2.95 ± 262 Bscf

The annual methane emissions were determined by multiplying an emission factor by the activity factor (population). Each emission factor was adjusted for the average methane content in the gas processing segment of 87 mol%.

REFERENCES

1. Shires, T.M. and M.R. Harrison. *Methane Emissions from the Natural Gas Industry, Volume 7: Blow and Purge Activities*, Final Report, GRI-94/0257.24 and EPA-600/R-96-080g, Gas Research Institute and U.S. Environmental Protection Agency, June 1996.
2. Williamson, H.J., M.B. Hall, and M.R. Harrison. *Methane Emissions from the Natural Gas Industry, Volume 4: Statistical Methodology*, Final Report, GRI-94/0257.21 and EPA-600/R-96-080d, Gas Research Institute and U.S. Environmental Protection Agency, June 1996.
3. Bell, L. "Worldwide Gas Processing," *Oil and Gas Journal*, July 12, 1993, p. 55.

**GP-5
PROCESSING SOURCE SHEET**

SOURCES:	Glycol Dehydrators
COMPONENTS:	Gas Assisted Kimray Pumps
OPERATING MODE:	Normal Operation
EMISSION TYPE:	Unsteady, Vented
ANNUAL EMISSIONS:	0.170 scf ± 228%

BACKGROUND:

Most glycol circulation pumps in gas plants are electric. However, some gas driven pumps do exist. Gas-assisted Kimray glycol circulation pumps use a mixed phase of wet glycol liquid and absorber gas to drive pistons that pump dry (lean) glycol circulation. Unlike chemical injection pumps which vent the driving gas directly to the atmosphere, Kimray pumps pass the driving gas along with the wet glycol to the reboiler. In the reboiler the methane is driven off into the vent line. Depending on dehydrator vent gas dispositions, the methane may be vented to the atmosphere or controlled and burned.

EMISSION FACTOR: (177.75 scf CH₄/MMscf gas processed)

The average glycol pump gas emission factor was determined by an equation describing the gas generation and disposition of gas from the pump. The disposition of gas generated by the pump depends upon the existence of a flash tank and vent controls. Measured and estimated parameters were input into the equation.

In general, the emission factor for a gas-assisted pump was determined by the following equation:

$$\begin{aligned}
 EF_{\text{pump}} &= PGU \times CR \times WR \times OC \times F_{NT} \times F_{NVC} \\
 &= (3.73 \text{ scf/gal}) \times (3.0 \text{ gal/lb H}_2\text{O}) \times (53 \text{ lb H}_2\text{O/MMscf}) \times (1.0) \times (0.333) \times (0.900) \\
 &= 177.75 \text{ scf CH}_4\text{/MMscf gas} \pm 56.85\%
 \end{aligned}$$

EF DATA SOURCES:

1. Equation 1, i.e. the effects of operating variables on emissions, was defined in *Methane Emissions from the Natural Gas Industry, Volume 15: Gas-Assisted Glycol Pumps* (1).
2. CR = glycol circulation ratio = 3.0 gal glycol/lb water ± 33.3%.
3. WR = water removed from wet gas = 53 lb water/MMscf gas ± 20%. For inlet gas stream of 95°F and 800 psig dried to 7 lb water/MMscf gas.
4. OC = factor to account for overcirculation of glycol = 1.0 ± 0%.
5. F_{NT} = fraction of dehydrators without flash tanks = 0.333 ± 20.12%.
6. F_{NVC} = fraction of the dehydrators without combustion vent controls = 0.900 ± 10%.
7. PGU = pump gas usage = 3.73 scf CH₄/gal glycol ± 30%. Determined by multiplying the volume of gas used by high-pressure pump models by a typical fraction of methane in the natural gas (83 mole%).

$$\begin{aligned} \text{PGU} &= 4.49 \text{ scf/gallon} \times 83\% \\ &= 3.73 \text{ scf/gallon} \pm 30\% \end{aligned}$$

EF ACCURACY: ($\pm 56.85\%$)

Basis:

1. Assumption: The manufacturer's data and ranges are relatively accurate ($\pm 30\%$).
2. Dehydrator characteristics based on site visit observations and TMOGA survey.⁸

ACTIVITY FACTOR: (0.9579 Tscf/year in the processing segment with gas-assisted pumps)

The volume of gas processed through dehydrators using gas-assisted pumps was calculated from the total throughput for gas processing dehydrators and the fraction of dehydrators using gas-assisted pumps determined from site visits. The activity factor is then:

$$\begin{aligned} \text{AF} &= (\text{fraction of dehydrators with gas-assisted pumps}) \times (\text{throughput for gas processing dehydrators}) \\ &= (0.111 \pm 186\%) \times (8.63 \text{ Tscf/year} \pm 22.4\%) \\ &= 0.9579 \text{ Tscf/year} \pm 191.95\% \end{aligned}$$

AF DATA SOURCES:

1. See *Methane Emissions from the Natural Gas Industry, Volume 14: Glycol Dehydrators* (2) for an explanation of processing dehydrator throughput (8.63 Tscf/year). See the *Methane Emissions from the Natural Gas Industry, Volume 5: Activity Factors* (3) for more details.
2. Fraction of dehydrators using gas-assisted pumps came from data from site visits.

AF ACCURACY: ($\pm 192\%$)

Basis:

Calculated from confidence limits of gas throughput and fraction of dehydrators by standard error propagation analysis.

ANNUAL METHANE EMISSIONS: (0.1703 Bscf $\pm 228\%$)

The annual methane emissions were determined by multiplying an emission factor (scf CH₄/MMscf) by the total throughput for processing dehydrators using gas-assisted pumps.

$$(177.75 \text{ scf/MMscf}) \times (0.9579 \text{ Tscf}) = 0.1703 \text{ Bscf} (\pm 228.00\%)$$

REFERENCES

1. Myers, D.B. and M.R. Harrison. *Methane Emissions from the Natural Gas Industry, Volume 15: Gas-Assisted Glycol Pumps*. Final Report, GRI-94/0257.33 and EPA-600/R-96-080o. Gas Research Institute and U.S. Environmental Protection Agency, June 1996.
2. Myers, D.B. *Methane Emissions from the Natural Gas Industry, Volume 14: Glycol Dehydrators*. Final Report, GRI-94/0257.32 and EPA-600/R-96-080n. Gas Research Institute and U.S. Environmental Protection Agency, June 1996.

3. Stapper, B.E. *Methane Emissions from the Natural Gas Industry, Volume 5: Activity Factors*. Final Report, GRI-94/0257.22 and EPA-600/R-96-080e. Gas Research Institute and U.S. Environmental Protection Agency, June 1996.

**GP-6
GAS PROCESSING SOURCE SHEET**

SOURCES:	Various Equipment (vessels, compressors, piping)
COMPONENTS:	Pneumatic Devices
OPERATING MODE:	Normal Operation
EMISSION TYPE:	Unsteady, Vented
ANNUAL EMISSIONS:	0.1 Bscf ± 133%

BACKGROUND:

The gas processing segment uses compressed air to power the majority of the pneumatic devices within the plant, although some devices may be powered by natural gas. Many plants use gas driven pneumatic controllers on isolation valves for emergency shut-down or maintenance work.

The same type of devices used in the transmission segment are also commonly used in the gas processing segment — continuous bleed throttling/regulating valves, displacement operators, and turbine operators.

EMISSION FACTOR: 165 Mscf per average plant ± 133%

(This was adjusted for the gas processing methane fraction of natural gas at 87 mol%.)

The average device gas emission factor was determined from a combination of vendor information on device emission rates and device counts from several sites. The average emission factor was calculated using the following equation:

$$EF_{\text{avg. pneum. device}} = K \times \frac{\sum_{i=1}^n (\text{Annual Site Emissions, scf Natural Gas})}{n} \times \% \text{ Methane}$$

K = fraction of sites that use natural gas rather than air (0.56 ± 59%)
n = number of sites operating with natural gas

Each term in this equation was determined from site specific information. The summation of the site specific data was then adjusted based on the number of sites with gas operated devices versus the total number of sites surveyed. The site results are shown in the following table.

Site	Device Type	Number of Devices	Operations/Year	Annual Displacement/Device, scf	Displacement/Site, scf
1	Throttling (Fisher)	2	Continuous	497,584	995,168 ± 29%
2	Isolation (Fisher)	3	12	214,675	644,025 ± 29%
3	Air	--	--	--	--
4	Isolation (Turbine)	25	1	780	19,500 ± 112%
5	Isolation (Rotary Vane)	7	12	48	1,206 ± 49%
		18	1		
6	Isolation (Turbine & Rotary Vane)	1	1	3,376	44,115 ± 68 %
		16	12		
7	Air	--	--	--	--
8	Air	--	--	--	--
9	Air	--	--	--	--
TOTAL					1,704 Mscf ± 21%
Average (for gas sites)					341 Mscf ± 103%

EF DATA SOURCES:

1. *Methane Emissions from the Natural Gas Industry, Volume 12: Pneumatic Devices* (1) establishes the important emission-affecting characteristics.
2. Site visit device counts establish the number of continuous bleed devices, turbine operators, and displacement operators for each site.
3. The emission factor for continuous bleed devices was estimated using data provided by one site and measurements for transmission pneumatic devices.
4. Gas usages for the displacement operators were provided by Pantex Valve Actuators and Systems and Shafer Valve Operating Systems. The number of devices, supply gas pressure, and operating frequency were based on site information.
5. Gas usages for the turbine operators were provided by Limitorque Corp. Operating duration, frequency, and supply gas pressure were based on site information.

EF ACCURACY:

Basis:

1. EF accuracy is based on error propagation from the spread of data for the nine sites visited.
2. It was assumed that the manufacturers' data are completely accurate.

ACTIVITY FACTOR: 726 gas processing plants ± 2%

The activity factor for the gas processing segment was taken from *Oil and Gas Journal* (2) published information from the year 1992.

AF DATA SOURCES:

1. The number of gas processing plants was taken from the *Oil and Gas Journal* (2).

AF PRECISION:

Basis:

1. AF accuracy is based on engineering judgement.

ANNUAL METHANE EMISSIONS: 0.12 Bscf ± 133%

The annual emissions were determined by multiplying an average site emission factor (adjusted for the methane composition) by the total number of gas processing sites.

$$165 \text{ Mscf/site} \times 726 \text{ sites} = 0.12 \text{ Bscf}$$

REFERENCES

1. Shires, T.M. and M.R. Harrison. *Methane Emissions from the Natural Gas Industry, Volume 12: Pneumatic Devices*. Final Report, GRI-94/0257.29 and EPA-600/R-96-0801, Gas Research Institute and U.S. Environmental Protection Agency, June 1996.
2. Bell, L. "Worldwide Gas Processing," *Oil and Gas Journal*, July 12, 1993, p. 55.

APPENDIX C

Transmission/Storage Source Sheets

APPENDIX C

Transmission/Storage Source Sheets

		<u>Page</u>
T-1 -	Fugitive Emissions (Transmission)	C-4
T-2 -	Meter and Regulating Station Emissions	C-9
T-3 -	Pipeline Leaks	C-13
T-4 -	Pneumatic Devices	C-16
T-5 -	Maintenance Venting	C-19
T-6 -	Glycol Dehydrator Vents	C-22
S-1 -	Fugitive Emissions (Storage Facilities)	C-24
S-2 -	Glycol Dehydrators (Storage Facilities)	C-29

TRANSMISSION/STORAGE SOURCE SHEETS

This section contains the specific source sheets for the transmission and storage segment of the natural gas industry. The following table serves as a guide for finding sheets in this section. The cells in the table give the sheet number (T-1, T-2, etc.) of the source sheet. The rows define the equipment covered, while the columns define the emission type. A category with no sheet number means that the emissions from that area were determined to be zero or negligibly small. The label for each source sheet is shown at the top of the cover page for that sheet.

TABLE OF CONTENTS	OPERATING MODE, EMISSION TYPE (Fugitive, Vented, or Combusted)									
	Start Up		Normal Operations			Maintenance		Upsets		Mis-haps
	V	C	F	V	C	V	C	V	C	V
EQUIPMENT:										
Entire Transmission Compressor Stations			T-1	T-4		T-5		T-5		
Trans. Comp. Station Dehydrators			T-1	T-4, T-6		T-5		T-5		
Trans. Comp. Station Vessels			T-1	T-4		T-5		T-5		
Trans. Comp. Station Compressors			T-1	T-4	P-1	T-5		T-5		
Transmission Pipelines			T-3	T-4		T-5		T-5		
Trans. M&R Stations			T-2	T-2		T-5		T-5		
Entire Storage Stations			S-1	T-4		T-5		T-5		
Stor. Sta. Wells			S-1	T-4		T-5		T-5		
Stor. Sta. Compressors			S-1	T-4	P-1	T-5		T-5		
Stor. Sta. Vessels			S-1	T-4		T-5		T-5		
Stor. Sta. Dehydrators			S-1	T-4, S-2		T-5		T-5		

T-1
TRANSMISSION SOURCE SHEET

SOURCES: Compressor Stations
OPERATING MODE: Normal Operation
EMISSION TYPE: Steady and Unsteady, Fugitive
ANNUAL EMISSIONS: 50.7 Bscf ± 52%

BACKGROUND:

Equipment leaks are typically low-level, unintentional losses of process fluid (gas or liquid) from the sealed surfaces of above-ground process equipment. Equipment components that tend to leak include valves, flanges and other connectors, pump seals, compressor seals, pressure relief valves, open-ended lines, and sampling connections. These components represent mechanical joints, seals, and rotating surfaces, which in time tend to wear and develop leaks.

- EMISSION FACTOR:** a. Station = 3.2 MMscf/yr methane per plant
 b. Recip. Compressor = 5.55 MMscf/yr methane per recip
 c. Turbine Compressor = 11.1 MMscf/yr methane per turbine

The average fugitive emission rate for transmission compressor stations was determined to be composed of two parts: a) station components (excluding compressor-related components); and b) compressor-related components. Fugitives from the compressor-related components have much higher emission factors than components in the rest of the facility. This is due in part to the high vibration that compressors generate, but most of the larger emissions are due to unique compressor components, as explained below.

a. The contribution from non-compressor components was determined by multiplying the average component count by the component emission factor. The number of components was subdivided into valves, connections/flanges, small open-ended lines, site blowdown (B/D) OELs, control valves, and other components (such as pressure relief valves). (Tubing components were determined to be insignificant.) All of these components are typical fugitive components (as described in the EPA Fugitive Emissions Protocol) with the exception of control valves and site B/D OELs. Control valves emit at a higher rate than manual isolation valves since their packing is stressed more often as they are activated much more frequently. Site B/D OELs are the large diameter emergency station blowdown valves that are designed to depressure the entire site to the atmosphere when the valve is opened.

The component emission factors for station components were based on a GRI/Indaco measurement program conducted at 6 compressor stations. The average facility emissions are then calculated as follows:

$$EF = [(N_{vlv} \times EF_{vlv}) + (N_{C-vlv} \times EF_{C-vlv}) + (N_{ca} \times EF_{ca}) + (N_{oel} \times EF_{oel}) + (N_{prv} \times EF_{prv}) + (N_{site\ B/D} \times EF_{site\ B/D})]$$

where:

N_x = average count of components of type x per plant, and

EF_x = average methane emission rate per component of type x.

b. The contribution from compressor-related components was obtained by multiplying the average number of fugitive components per compressor engine by the component emission factors. The component emission factors were based on the GRI/Indaco measurement program conducted at 15 compressor stations. Some compressor components are unique, while others have higher leak rates than identical components elsewhere in the plant due to vibration. Compressors have the following types of components:

- 1) Comp. B/D OEL A blowdown (B/D) valve to the atmosphere that can depressure the compressor when idle. The B/D valve or the large unit block valves (depending on the operating status of the compressor) can act as an open-ended line that leaks at an extraordinarily high rate through the valve seat. The leak rate is dependent upon whether the compressor is pressurized (in operation or idle, pressurized) or depressurized (idle, depressurized).
- 2) Comp. PRV The pressure relief valve (PRV) is usually installed on a compressor discharge line and leaks at a higher than average rate due to vibration.
- 3) Comp. Starter OEL Most compressors have a gas starter motor that turns the compressor shaft to start the engine. Some use natural gas as the motive force to spin the starter's turbine blades and vent the discharge gas to the atmosphere. The inlet valve to the starter can leak and is therefore an OEL unique to compressors.
- 4) Comp. Seal All compressors have a mechanical or fluid seal to minimize the flow of pressurized natural gas that leaks from the location where the shaft penetrates the compression chamber. These seals are vented to the atmosphere. Reciprocating compressors have sliding shaft seals while centrifugal compressors have rotating shaft seals.
- 5) Miscellaneous There are many components on each compressor, such as valve covers on reciprocating compressor cylinders and fuel valves.

Each compressor has one B/D OEL, one PRV, and one starter OEL. Reciprocating compressors have one compressor seal per compression cylinder (which averaged 3.3 per engine), while centrifugal compressors have 1.5 seals per gas turbine. For the miscellaneous component category, there are many components per compressor engine, but the emission rates were minor and so were added into one lump emission factor per compressor for miscellaneous components.

All of the compressor emission factors take several correction factors into account. First, the various phases of compressor operations (such as the amount of time that compressors are a) idle and depressured, b) idle and pressured up, or c) running). This is actually a complex adjustment that takes into account valve position practices. [See *Methane Emissions from the Natural Gas Industry, Volume 8: Equipment Leaks* (1) for more details.] Correction factors were also added for fraction of starter gas turbines using air instead of gas (100% for recip, 0% for turbines in Transmission).

EF DATA SOURCES:

1. Component emission factors based on results from GRI/Indaco program for the component EF's for 6 transmission compressor stations (June 1994). Adjustment of station EF is to account for data obtained from one interstate transmission pipeline company that was found to have higher emissions than average.
2. Plant component counts were based on an average of 8 Indaco sites in 1994 and 9 sites visited under this project in 1993, plus 7 industry sites.
3. Compressor emission factors based on results from GRI/Indaco program for 15 compressor stations (June 1994). Compressor operating hours (% running) based on data from FERC database, GRI TRANSDAT (2) database, and data supplied by one large interstate transmission pipeline company.
4. Fraction of methane (93.4 mol%) based on data from GRI TRANSDAT database.

Average Facility Emissions for Gas Transmission

Equipment Type	Component Type	Component Emission Factor, Mscf/component-yr	Average Component Count	Average Equipment Emissions, ^a MMscf/yr
Compressor Station (non-compressor related components)	Valve	0.867	673	3.01 (102%) (Note: 3.2 MMscf/yr used in national emission estimate) ^b
	Control Valve	8.0	31	
	Connection	0.147	3,068	
	OEL	11.2	51	
	PRV	6.2	14	
	Site B/D OEL	264	4	
Reciprocating Compressor	Compressor B/D OEL	3,683	1	5.55 (65%)
	PRV	372 ^c	1	
	Miscellaneous	180 ^c	1	
	Compressor Starter OEL	^d	^d	
	Compressor Seal	396 ^c	3.3	
Centrifugal Compressor	Compressor B/D OEL	9,352	1	11.1 (34%)
	Miscellaneous	18 ^c	1	
	Compressor Starter OEL	1,440	1	
	Compressor Seal	165 ^c	1.5	

^a Values in parentheses represent 90% confidence interval.

^b Adjusted for data received from one company that was not considered representative of national average.

^c Adjusted for the fraction of time the compressor is pressurized (79.1% and 24.2% for reciprocating and centrifugal compressors, respectively).

^d Reciprocating compressor starters were assumed to use compressed air or electricity instead of natural gas.

- EF ACCURACY: a. Station = 102%
 b. Recip. Compressor = 65%
 c. Turbine Compressor = 34%

Basis:

Rigorous propagation of error from the spread of thousands of individual measurements taken by Indaco.

- ACTIVITY FACTOR: a. Station Activity Factor = 1700 stations
 b. Compressor Activity Factor = 6799 recip engines, 681 turbines

AF DATA SOURCES:

1. 1992 FERC Form 2 responses accounted for 70% of national transmission pipeline mileage. Total station count extrapolated using national total transmission mileage of 276,900 miles from A.G.A. *Gas Facts* (3).
2. Compressor engine count based on GRI TRANSDAT "industry database" with adjustments for total industry horsepower. Transmission compressor station counts were split from storage based upon storage station site visit data and *Gas Facts* (3) data on storage stations. Added 0.2% to recip count account for electric motor drivers.

- AF ACCURACY: a. Station Activity Factor: $\pm 10\%$
 b. Compressor Activity Factor: Recip engines = $\pm 17\%$; Turbines = $\pm 26\%$

Basis:

1. FERC Form 2 data have a high percentage (70%) of all transmission companies. Therefore a national extrapolation should not add much error. This 10% figure was assigned based on engineering judgement.
2. The compressor count accuracy was assigned based upon the propagation from: a) rigorous error propagation for the 8 storage station "compressor/station" averages; and b) engineering judgement assignment of $\pm 10\%$ error to the large GRI TRANSDAT database.

ANNUAL METHANE EMISSIONS: (50.73 Bscf/yr \pm 26.3 Bscf/yr)

The annual emissions were determined by multiplying the average facility/equipment emissions by the population of equipment in the segment.

Category	Emission Factor	Activity Factor	Emission Rate	Uncertainty
Station	3.2 MMscf/yr CH4	1700 stations	5.4 Bscf/yr CH4	103%
Recip Comp	5.55 MMscf/yr CH4	6799 recip	37.8 Bscf/yr CH4	68%
Turbine Comp	11.1 MMscf/yr CH4	681 turbine	7.5 Bscf/yr CH4	44%
TOTAL			50.7 Bscf/yr CH4	52%

REFERENCES

1. Hummel, K.E., L.M. Campbell, and M.R. Harrison. *Methane Emissions from the Natural Gas Industry, Volume 8: Equipment Leaks*, Final Report, GRI-94/0257.25 and EPA-600/R-96-080h, Gas Research Institute and U.S. Environmental Protection Agency, June 1996.
2. Biederman, N. GRI TRANSDAT Database: Compressor Module. (prepared for Gas Research Institute) npb Associates with Tom Joycxe and Associates, Chicago, IL, August 1991.
3. American Gas Association, *Gas Facts*. Arlington, VA, 1992.

T-2
TRANSMISSION SOURCE SHEET

SOURCES: Meter and Regulating Stations
OPERATING MODE: Normal Operation
EMISSION TYPE: Steady, Fugitive, and Vented
ANNUAL EMISSIONS: 4.5 Bscf ± 835%

BACKGROUND:

Metering/pressure regulating (M&PR) stations are located throughout the transmission network to meter gas where a custody transfer occurs. Emissions from M&PR include continuous fugitive losses and also may include intermittent emissions from pneumatic devices such as pressure regulators, if they exist at the station. Fugitive emissions are relatively low-level emissions of process fluid (gas or liquid) from process equipment. Specific source types include various fittings such as valves, flanges, or compressor seals. These components represent mechanical joints, seals, and rotating surfaces, which in time tend to wear and develop leaks.

The transmission segment contains many "metering and regulation stations" (M&R stations) where flow is measured for custody transfer or system control. The table below shows the types of M&R stations that transmission companies count in their system. Most of the meter station types associated with the transmission system have already been counted in other segment calculations (receipt stations in production and delivery stations in distribution).

Only three types remain to be accounted for under the transmission system M&PR stations: 1) farm taps, 2) direct industrial sales from the transmission pipeline, and 3) transmission company-to-transmission company transfer stations.

Transmission Meter and Regulation Station Types

GENERAL STATION SERVICE	SPECIFIC TYPE	STATION TECHNICAL DESCRIPTION	ACCOUNTED FOR IN OTHER SEGMENT SOURCE SHEETS?
RECEIPT TO THE SYSTEM:	1. Gathering meters at production sites	Meter Only	Yes, P-2
INTER-SYSTEM:	2. Meters at compressor stations	Meter Only	Yes, T-1
DELIVERY TO CUSTOMERS:	3. City Gate M&R stations	Meter and Regulation (Pressure regulation)	Yes, D-1
	4. Industrial sales directly off of transmission pipelines	Meter and Regulation (Pressure regulation)	Some in D-1, but those owned by transmission companies in this sheet (T-2)
	5. Farm sales off gathering and transmission pipelines	Meter and Regulation (Pressure regulation)	No, so accounted for in this sheet (T-2)
	6. Sales to Other Transmission Companies (Inter-connects)	Most often Meter only, but can have some flow regulation	No, so accounted for in this sheet (T-2)

Although direct customer connections (sales) on the transmission pipeline are rare, where they exist they are often owned by distribution companies, even if they only own a few feet of line. Many farm taps are still owned by transmission companies, even though there is a trend to let LDCs handle the farm taps or to remove them entirely. Therefore, many direct sales from the transmission pipeline are already accounted for in the distribution M&PR calculations. Only the direct sales from the transmission pipeline that are owned completely by the transmission companies are counted under this source sheet.

Most large transmission companies have interconnects with other transmission companies to allow for flexibility of supply. These shared stations can flow in either direction.

EMISSION FACTOR: (see below)

The average fugitive emission rate for transmission M&R stations was determined by analysis of the GRI tracer measurement tests for gas industry M&R stations. Transmission farm taps and industrial meters are both direct-connects to high pressure pipelines, and will have one pressure regulator (and not 3 to 22 regulators, as some city gates had) in addition to a meter. The pressure regulator is a self contained device, and so does not have significant pneumatic emissions. Therefore the tracer data set was sorted and adjusted as follows:

- 1) include only stations with one regulator,
- 2) include only stations in vaults (which were known to have no-bleed regulators similar to farm taps),
- 3) delete regulator only stations in the low pressure range (0 to 100 psig inlet pressure), and
- 4) delete meter only stations.

The average of the 14 samples in the new transmission direct sales (farm tap & industrial meters) data set is used for the emission factor.

The transmission company inter-connect meter stations were taken by sorting the tracer data set for M&R stations with inlet pressures above 100 psig. Thirty-seven samples met this criterion.

Summary of Component Counts and Overall Emission Factors (scf/day)

METER STATION TYPE	SAMPLES (Number of Tracer Measurements Fitting this Type)	EMISSION FACTOR (Methane SCFD)
Trans-Trans Co. Interconnect points	37	3984 ± 80%
Farm Taps and direct industrial sales	14	31.2 ± 80%

EF DATA SOURCES:

1. Tracers result based on downwind tracer measurements performed by Aerodyne/WSU (1) at over 100 gas industry meter/regulation stations.
2. Analysis of tracer results was based upon technical descriptions of meter station types given by several transmission company measurement experts.
3. Definition of transmission segment boundaries and other measurement programs shows that several meter types have already been accounted for. See sheet D-1 for sales to distribution M&R stations, see sheet T-1 and S-1 for compressor station meter fugitive emissions and see sheet P-2 for production receipt meters which have already been accounted for at gas production sites.

EF PRECISION:

Basis:

The transmission meter/pressure regulation station (M&PR) upper bounds are based upon rigorous propagation of error from the standard deviation of the multiple tracer measurements.

ACTIVITY FACTOR:

Trans-to-trans company interconnects $2533 \pm 776\%$
 Farm taps and Direct Industrial Sales $72630 \pm 780\%$

As discussed above, types 1, 2, and 3 of transmission M&R stations are actually already accounted for in other activity factors. In the production segment meter runs were counted in the well site data. Delivery to distribution has been counted in the distribution segment M&R stations (i.e. city gates). There is also a trend to let LDCs handle the farm taps, or to remove them entirely; however, many farm taps are still owned by transmission companies.

Transfers to other transmission companies and farm taps were calculated from survey data provided by the metering departments of three large (over 10,000 miles of pipeline) transmission companies, and from three companies with fewer than 10,000 miles of pipeline, as shown in the following table.

Transmission M&R Station Populations

Company	Transfer to another Transmission Co.	Farm Taps	Direct Industrial Sales	Miles of Pipeline
1	323	23		Confidential
2	5	0		Confidential
3	60	0		Confidential
4	62	48		Confidential
5	40	3,800		Confidential
6	0	10,000		Confidential
Total	490	13,871	658	55,045 (19.3% of U.S. total)
Total U.S. Activity Factor Extrapolated by Miles	$2,533 \pm 776\%$	$71,690 \pm 787\%$	$937 \pm 100\%$	284,500

Only five of the six companies that responded to the survey reported having interconnects with other transmission companies. The activity factor was extrapolated based on pipeline miles and was calculated to be 2533 interconnects (transfers). The 90% confidence bound was determined to be $\pm 776\%$.

The count of farm taps appears to be extremely regional. Based on interviews, it seems that most companies have no farm taps, while others have thousands. The activity factor for farm taps was calculated to be $71,690 \pm 787\%$.

The calculated activity factor is believed to be conservatively high, since only a small percentage of all transmission companies have these M&R stations, yet two of the six companies in our data set reported a large number of farm taps.

The activity factor for direct industrial sales was developed from FERC Form No. 2, page 306 (2). Industrial sales greater than 50,000 Mcf are listed individually, while sales less than 25,000 Mcf are combined into a single item. In the latter case, the total amount of gas sold was divided by 50,000 to provide an estimate of the number of sales. Due to the uncertainty that this approach introduced to the activity factor and to the complexity of retrieving data from FERC, a confidence bound of $\pm 100\%$ was assigned based on engineering judgement.

The activity factor for the direct industrial sales was combined with that for farm taps based upon similar construction of the two station types.

AF DATA SOURCES:

1. For interconnects and farm taps, six transmission companies responded to the GRI/EPA survey to determine average ratios of meter types per mile of transmission line. Averages from the survey were extrapolated to national interconnect M&R number by multiplying the ratio by the known miles of U.S. transmission line.
2. Miles of transmission line were from *Gas Facts* (3).
3. Direct industrial sales were determined from gas sales reported to FERC (2).

AF PRECISION:

Basis:

1. For interconnects and farm taps, rigorous propagation of error based upon the standard deviation of the ratio data from individual transmission companies.
2. For direct industrial sales: An engineering estimate based upon interview data.

ANNUAL METHANE EMISSIONS: (4.5 Bscf \pm 835%)

The annual emissions were determined by multiplying an emission factor for an each equipment type by the population of equipment in the segment.

REFERENCES

1. Aerodyne Research, Inc., Washington State University and University of New Hampshire. *Results of Tracer Measurements of Methane Emissions from Natural Gas System Facilities*, Final Report, GRI-94/0257.43, Gas Research Institute, Chicago, IL, March 1995.
2. Federal Energy Regulatory Commission (FERC) Form No. 2, page 306: Annual Report of Major Natural Gas Companies, 1992 database.
3. American Gas Association. *Gas Facts: 1992 Data*, Arlington, VA, 1993.

T-3
TRANSMISSION SOURCE SHEET

SOURCES: Transmission Pipelines
OPERATING MODE: Normal Operations
EMISSION TYPE: Unsteady, Fugitives (Pipeline Leaks)
ANNUAL EMISSIONS: 0.16 Bscf +/- 89%

BACKGROUND:

Transmission pipelines are the inter- and intrastate high pressure underground pipelines that transport natural gas from the production/processing operations to the end user or distribution network. Leakage from underground transmission lines occurs from corrosion pits, joint and fitting failures, pipe wall fractures, and external damage.

EMISSION FACTOR: (scf/leak-year)

Leak survey practices for transmission lines are generally more stringent than for distribution mains. Transmission lines are required to be surveyed annually, and more frequently in populated areas. In addition, many transmission companies perform additional routine aerial surveys to monitor the transmission lines for leakage. Based on conversations with several transmission companies, any leaks found in the pipewall are extremely small and are repaired immediately for safety reasons. Based on the rigorous leak survey and repair practices of transmission companies (i.e., leaks are discovered and repaired earlier in transmission lines), the average leak rate from a transmission leak is believed to be of the same order of magnitude as a leak found in a distribution main, even though there may be a substantial difference in the operating pressure of the pipelines.

Therefore, the emission factors for leakage from transmission pipelines are based on the arithmetic average leakage rates for main pipelines from the cooperative underground distribution leakage measurement program. A mean value of the estimated leak rate per leak was calculated using the test data, for all pipe materials except cast iron. For cast iron mains, a segment test approach was used which quantifies the leakage rate for a long isolated segment of pipe; therefore, the mean leakage rate for cast iron is in terms of leakage per unit length of pipe. The natural gas leak rate is adjusted for methane by multiplying by the volume percent of methane for transmission (93.4 vol. %), and is adjusted for the soil oxidation of methane. The value of the emission factor and standard deviation for each pipe material category is given below:

Pipe Material	Number of Samples	Average Emission Factor	Units of Emission Factor	90% Confidence Interval of Emission Factor
Protected Steel	17	20,270	scf/leak-yr	17,243
Unprotected Steel	19	51,802	scf/leak-yr	48,212
Plastic	6	99,845	scf/leak-yr	165,617
Cast Iron	21	238,736	scf/mile-yr	152,059

Preliminary data from the underground distribution program indicate that the leakage rate is not a function of the pipeline pressure. Therefore, the leakage rates for transmission pipelines have not been adjusted based on the difference in average operating pressure of the transmission lines versus distribution lines.

EMISSION FACTOR DATA SOURCES:

1. Leakage rate data on a rate per leak basis for cathodically protected steel mains, unprotected steel mains, and plastic mains from the cooperative leak measurement program.
2. Leakage rate data on a rate per unit length basis for cast iron mains from the cooperative leak measurement program for distribution mains.
3. Assumes that the leak rates from transmission pipelines are identical to leak rates from distribution mains, based on the more rigorous leak survey and repair practices of transmission companies.
4. Assumes that the leak rates from underground pipelines are independent of pressure and pipe diameter, based on preliminary results from the underground distribution leak measurement program.

ACTIVITY FACTOR: (equivalent leaks)

The mean activity factor and precision for each pipe material category is given below:

Pipe Material	Total Miles	Average Activity Factor	Units of Activity Factor	90% Confidence Interval of Activity Factor
Protected Steel	287,155	5,077	equivalent leaks	3,859
Unprotected Steel	5,233	659	equivalent leaks	501
Plastic	2,621	14	equivalent leaks	11
Cast Iron	96	96	miles	10

The number of total leaks (excluding pipeline incidents) in transmission pipelines is based on the 1991 DOT RSPA database (1) for transmission pipelines, including both repaired leaks (6,120 leaks) and outstanding leaks (1,369 leaks). Because transmission lines are surveyed at least once per year using a walking survey method, the number of unreported leaks is estimated based on the effectiveness of the walking survey. According to one contract company specializing in distribution surveys, roughly 85 percent of the leaks are found using a walking survey. This estimated survey efficiency was applied to transmission surveys, resulting in roughly 1,320 unreported leaks.

The leak duration for outstanding leaks and unreported leaks is estimated to be 8,760 hours per year, and the leak duration for repaired leaks is half a year (4,380 hours/year), on average. The resulting estimate of equivalent leaks represents the number of leaks with a year round leak duration. (That is, each leak repair is counted as half an equivalent leak to compensate for the leak duration.) Therefore, the equation used to estimate equivalent leaks is:

$$0.5 \times (\text{repaired leaks}) + \{[(\text{repaired leaks} + \text{outstanding leaks})/0.85] - \text{repaired leaks}\}$$

The total number of estimated transmission pipeline leaks, 5,750, was allocated on a pipeline material category basis in the same proportion (adjusted for the fraction of mileage in each material category) as in the distribution sector. (That is, the ratio of percent leaks to percent miles in the transmission segment is the same as the ratio in the distribution segment.) The precision of the estimated total leaks was calculated based on the estimated 90% confidence interval associated with each parameter in the activity factor equation:

- repaired leaks; outstanding leaks: $\pm 100\%$
- leak duration: $\pm 25\%$
- leak survey effectiveness: $\pm 15\%$

A statistical software program [(@RISK (2))] was used to determine the overall 90% confidence interval of the activity factor: $\pm 76\%$.

For cast iron transmission lines, the mileage is based on the 1991 DOT RSPA database for transmission and gathering lines. The precision of the estimate is assumed to be $\pm 10\%$.

ACTIVITY FACTOR DATA SOURCES:

1. 1991 DOT RSPA database (1) for transmission and gathering pipelines.
2. Total number of leaks is assumed equal to the total number of leak repairs plus the outstanding (unrepaired leaks) and unreported leaks.
3. Leak survey effectiveness estimation provided by Southern Cross Company (3).
4. The allocation of estimated leaks per pipe material category is based on the leak frequency for underground distribution main pipelines, adjusted for the fraction of total mileage per pipe material category.
5. @RISK statistical software program (2) used to estimate the 90% confidence interval.

ANNUAL METHANE EMISSIONS: (0.16 Bscf \pm 89%)

Pipe Material	Average Emission Factor (scf/leak-yr)	Average Activity Factor (equivalent leaks)	Annual Emissions Estimate, (Bscf)	90% Confidence Interval of Emissions Estimate, (Bscf)
Protected Steel	20,270	5,077	0.10	0.14
Unprotected Steel	51,802	659	0.03	0.05
Plastic	99,845	14	0.001	0.003
Cast Iron	238,736 ^a	96 ^b	0.02	0.02
Total			0.16	0.14

^ascf/mile-yr
^bmiles

The total leakage was determined by multiplying an emission factor for each type of pipeline material by the estimated number of leaks in each respective pipe material category.

REFERENCES

1. U.S. Department of Transportation. Research and Special Programs Administration. 1991.
2. Palisade Corporation. *@ Risk, Risk Analysis and Simulation Add-in for Lotus 1-2-3, Version 1.5*, March 1989.
3. Southern Cross Corporation. *Comments on Docket PS-123 Notice 1, Leakage Surveys*, 49 CFR Part 192, Department of Transportation, Research and Special Programs Administration, Materials Transportation Bureau, Office of Pipeline Safety Regulations, December 19, 1991.

T-4
TRANSMISSION AND STORAGE SOURCE SHEET

SOURCES: Various Equipment (vessels, compressors, piping)
 OPERATING MODE: Normal Operation
 EMISSION TYPE: Unsteady, Vented
 COMPONENTS: Pneumatic Devices
 ANNUAL EMISSIONS: 14.1 Bscf ± 60%

BACKGROUND:

The transmission segment is comprised of compressor stations, pipelines, and storage stations. There are essentially no pneumatic devices associated with the pipelines. Within the storage and compressor stations, most of the pneumatics are gas-actuated isolation valves, and there are a few continuous bleed controllers.

Meter-only stations do not have venting pneumatics. Meter and regulation (M&R) stations do have regulating pneumatic controllers (the pressure regulator valves), but all of the M&R station pneumatic emissions are counted in the fugitive calculation for M&R stations and so are not included in this sheet.

The continuous bleed controllers in transmission compressor stations are used for liquid level control in filter-separators and pressure reduction. The higher pressures and large pipe diameters associated with transmission operations require larger actuators and valves than typically found in production, resulting in larger emissions than similar devices in production.

Within the storage and mainline compressor stations, most of the pneumatic devices are gas-actuated isolation valves. These valves block the flow to or from a pipeline and can isolate the facility for maintenance work or in the case of an emergency. Therefore, the isolation valves are actuated infrequently and their emissions are intermittent.

EMISSION FACTOR: 162,197 scf/device ± 44%

(This was adjusted for the transmission methane fraction of natural gas at 93.4 mol%.)

The average pneumatic device emission factor was determined from a compilation of information from several sites. Counts of devices per site were taken during Radian site visits. The devices were classified into three categories: continuous bleed valves, isolation valves with turbine operators, and isolation valves with displacement operators. The emission factor was determined based on the following equation:

$$EF_{\text{pneumatic devices}} = (EF_{\text{cont. bleed valves}} \times \text{Fraction}_{\text{cont. bleed valves}} + EF_{\text{turbine operators}} \times \text{Fraction}_{\text{turbine operators}} + EF_{\text{displacement operators}} \times \text{Fraction}_{\text{displacement operators}}) \times \% \text{ methane}$$

Listed below are the average fraction of devices for each of the three valve categories:

Fraction_{cont. bleed valves} = 0.32 ± 69%
 Fraction_{turbine operators} = 0.16 ± 94%
 Fraction_{displacement operators} = 0.52 ± 48%

Emissions from continuous bleed pneumatics in the transmission segment were measured by an independent contractor. The average emission factor, based on 23 measurements, is 1,363 scfd/device ± 29% (497,584 scf/device).

For the isolation valves with turbine operators, the emission factor depends on the gas usage for a given supply gas pressure, the time required to complete one movement of the valve, and the number of operations per year. The annual emission factor is then:

$$EF_{\text{turbine operators}} = \text{Gas Usage (scf/min)} \times \text{Operating Duration (min/operation)} \times 2 \\ (\text{operations/cycle}) \times \text{Frequency (cycles/year)}$$

$$EF_{\text{turbine operators}} = 67,599 \pm 276\% \text{ scf/device}$$

The equation for isolation valves with displacement operators is similar:

$$EF_{\text{displacement operators}} = \text{Gas Usage (scf/psia)} \times \text{Supply Pressure (psia)} \times 2 \\ (\text{operations/cycle}) \times \text{Frequency (cycles/year)}$$

$$EF_{\text{displacement operators}} = 5,627 \pm 112\% \text{ scf/device}$$

EF DATA SOURCES:

1. *Methane Emissions from the Natural Gas Industry, Volume 12: Pneumatic Devices* (1) establishes the important emission-affecting characteristics of transmission pneumatic devices.
2. Device counts from 16 compressor and storage stations establish the fraction of turbine valve operators, and displacement valve operators. Counts from a total of 54 stations were used to establish the fraction of continuous bleed devices.
3. The emission factor for the continuous bleed valves was based on 23 field measurements.
4. Gas usages for the turbine valve operators were provided by Limitorque. Operating duration and frequency were estimated based on information from two transmission stations.
5. Gas usages for the displacement valve operators were provided by Shafer Valve Operating Systems. Supply pressure and frequency of operation were estimated based on information from four transmission stations.

EF ACCURACY:

Basis:

1. EF accuracy is based on error propagation from the combination of site information and measured data.
2. It was assumed that the manufacturers' data are completely accurate.

ACTIVITY FACTORS: 87,206 pneumatic devices \pm 38%

The number of gas operated pneumatic devices in the transmission and storage segment was calculated based on the average number of devices per station and multiplied by the total number of transmission and storage stations nationally. The average number of devices per site was determined to be $40 \pm 37\%$. The total count of transmission compression facilities is 2,175, based on 1,700 compressor stations, 386 UG storage stations, and 89 LNG storage stations.

AF DATA SOURCES:

1. The number of transmission compressor stations was compiled from 1992 Fossil Energy Commission Form No. 2: Annual Report of Major Natural Gas Companies (2).
2. The number of underground storage facilities is taken directly from A.G.A. *Gas Facts*: "Number of Pools, Wells, Compressor Stations, and Horsepower in Underground Storage Fields." Data from base year 1992 were used (3).
3. The number of liquefied natural gas storage facilities was summed from A.G.A. *Gas Facts*,

- "Liquefied Natural Gas Storage Operations in the U.S. as of December 31, 1987 (4)." The table lists 54 complete plants, 32 satellite plants, and 3 import terminals for a total of 89 facilities.
4. The number of devices per site is based on the total number of devices observed during site visits.

AF ACCURACY: 38%

Basis:

1. Extremely tight confidence limits are expected due to the well documented and reviewed numbers published in A.G.A. *Gas Facts* and FERC forms. A 10% confidence bound was assigned to the number of compressor stations and a 5% confidence bound was assigned to the number of storage stations.
2. The confidence bound on the number of devices per station was determined based on the spread of site data.

ANNUAL METHANE EMISSIONS: 14.1 Bscf \pm 60 %

The annual emissions were determined by multiplying an emission factor per device (corrected for the methane composition) by the population of pneumatic devices in the transmission segment.

$$162,197 \text{ scf/device} \times 87,206 \text{ devices} = 14.1 \text{ Bscf}$$

REFERENCES

1. Shires, T.M. and M.R. Harrison. *Methane Emissions from the Natural Gas Industry, Volume 12: Pneumatic Devices*. Final Report, GRI-94/0257.29 and EPA-600/R-96-0801, Gas Research Institute and U.S. Environmental Protection Agency, June 1996.
2. Department of Energy. *FERC Form No. 2: Annual Report of Major Natural Gas Companies*. OMB No. 1902-0028, Department of Energy Federal Energy Regulatory Commission, Washington, DC, December 1994.
3. American Gas Association. *Gas Facts*: 1993 Data, Arlington, VA, 1994.
4. American Gas Association. *Gas Facts*: 1991 Data, Arlington, VA, 1992.

T-5
TRANSMISSION AND STORAGE SOURCE SHEET

SOURCES: Various Equipment
OPERATING MODE: Maintenance/Upsets
EMISSION TYPE: Unsteady, Vented
ANNUAL EMISSIONS: 18.5 Bscf \pm 177%

BACKGROUND:

Maintenance activities can release gas to the atmosphere through blowdown or through purge. Blowdown is the direct, intentional venting to the atmosphere of gas contained inside operating equipment. The gas is released to provide a safer working environment for maintenance activities around or inside the equipment. After the equipment is serviced, the oxygen inside the equipment is often cleared to the atmosphere by purging natural gas through the equipment.

Upsets can also emit gas directly to the atmosphere. Upsets in process conditions can cause pressure rises that exceed the maximum design pressure for equipment. To prevent equipment overpressure and damage, pressure relief valves (PRVs) or remotely actuated valves open and vent the excess gas to the atmosphere. PRVs are spring loaded or pilot actuated valves that are designed to handle the upset conditions. Remotely actuated valves are usually designed to vent entire compressor stations or areas (such as compressor piping) in the event of a station emergency such as a fire or a large gas release.

EMISSION FACTORS: Station Blowdowns 4,359 \pm 262% Mscf/station
Pipeline Blowdowns 31.6 \pm 236% Mscf/mile
(Corrected for the transmission methane composition of 93.4 mol%)

Company tracked data were available from either company gas use estimates reported to accounting departments from each site (accounted-for), or from special "unaccounted-for" studies that searched for unmetered company gas use. Most of the company data could be separated into two event types: station blowdowns (includes compressor blowdowns, compressor starts, PRV lifts, ESD activation, and other venting sources) and pipeline blowdowns. These data are summarized in the following table.

EF DATA SOURCES:

1. GRI/EPA *Methane Emissions from the Natural Gas Industry, Volume 7: Blow and Purge Activities* (1) establishes emission affecting characteristics of blowdown practices.
2. Company tracked data were available from 8 companies.

EF ACCURACY: Range \pm 236% to 262%

Basis:

The accuracy was calculated from the spread of the company data. A 90% confidence interval is calculated for the 8 companies using the method presented in the *Methane Emissions from the Natural Gas Industry, Volume 4: Statistical Methodology* (2).

Company	Annual Station Blowdown Emissions, Mscf	Annual Pipeline Blowdowns, Mscf	Total Annual Blowdowns, Mscf	Total Number of Stations	Total Number of Pipeline Miles
1	120,757	189,044	309,801	11	3,857
2	272,589	11,358	283,947	15	4,000
3	33,731	138,988	172,719	27	5,886
4	--	--	172,776	(19)*	(5,450)
5	325,418	Unknown	Unknown	47	(4,725)
6	Unknown	161,628	Unknown	(48)	7,896
7	60,956	750,000	810,956	69	14,666
8	194,541	315,058	509,599	47	9,915
TOTALS	1,007,992	1,566,076		216	46,220
ANNUAL AVERAGE, Mscf natural gas/station					4,667 ± 262%
ANNUAL AVERAGE, Mscf natural gas/mile					33.9 ± 236%

*Parentheses indicate that the value was not included in the total because a station or pipeline emission rate was not available.

ACTIVITY FACTORS: 2,175 ± 8% compression facilities
284,500 ± 5% transmission pipeline miles

The activity factors for the segment were compiled from published statistics on the gas industry. The total count for transmission compressor stations was 1700; the total underground and liquefied natural gas storage station count was 475. The number of transmission pipeline miles comes from A.G.A. *Gas Facts* (3) which shows 284,500 miles of pipeline in the United States for 1992.

AF DATA SOURCES:

1. The number of transmission compressor stations was compiled from FERC Form No. 2: Annual Report of Major Natural Gas Companies (4).
2. The number of underground storage facilities is taken directly from A.G.A. *Gas Facts*, Table 4-5, "Number of Pools, Wells, Compressor Stations, and Horsepower in Underground Storage Fields" (3).
3. The number of liquefied natural gas storage facilities was summed from A.G.A. *Gas Facts*, Table 4-3, "Liquefied Natural Gas Storage Operations in the U.S. as of December 31, 1987" (3). The table lists 54 complete plants, 32 satellite plants, and 3 import terminals for a total of 89 facilities.
4. The number of transmission pipeline miles comes from A.G.A. *Gas Facts* which shows 284,500 miles of pipeline in the U.S. for 1992 (3).

AF ACCURACY: Range ± 5% to 8%

Basis:

Extremely tight confidence limits are expected due to the well documented and reviewed DOE numbers published in A.G.A. *Gas Facts* (3).

ANNUAL METHANE EMISSIONS: 18.5 Bscf \pm 177%

The annual methane emissions were determined by multiplying an emission factor (rate per avg unit) for each category by the activity factor (population) of the category. Each emission factor was adjusted for the average methane content in the transmission segment of 93.4 mol%.

REFERENCES

1. Shires, T.M. and M.R. Harrison. *Methane Emissions from the Natural Gas Industry, Volume 7: Blow and Purge Activities*, Final Report, GRI-94/0257.24 and EPA-600/R-96-080g, Gas Research Institute and U.S. Environmental Protection Agency, June 1996.
2. Williamson, H.J., M.B. Hall, and M.R. Harrison. *Methane Emissions from the Natural Gas Industry, Volume 4: Statistical Methodology*, Final Report, GRI-94/0257.21 and EPA-600/R-96-080d, Gas Research Institute and U.S. Environmental Protection Agency, June 1996.
3. American Gas Association. *Gas Facts: 1992 Data*, Arlington, VA, 1993.
4. Department of Energy. FERC Form No. 2: Annual Report of Major Natural Gas Companies. OMB No. 1902-0028, Department of Energy, Federal Energy Regulatory Commission, Washington, DC, December 1994.

T-6
TRANSMISSION SOURCE SHEET

SOURCES: Glycol Dehydrators
 OPERATING MODE: Normal Operation
 EMISSION TYPE: Unsteady, Vented
 COMPONENTS: Reboiler Vents
 ANNUAL EMISSIONS: 0.10 Bscf ± 392%

BACKGROUND:

Glycol dehydrators remove water from a gas stream by contacting the gas with glycol and then driving the water from the glycol and into the atmosphere. The glycol also absorbs a small amount of methane, and some methane can be driven off to the atmosphere through the reboiler vent.

EMISSION FACTOR: (93.72 scf/MMscf gas processed ± 207.99%)

A thermodynamic computer simulation was used to determine the most important emission-affecting variables for dehydrators. The variables are: gas throughput, existence of a flash tank, existence of stripping gas, existence of a gas driven pump, existence of vent controls routed to a burner. Throughput, since its effect is linear, is handled by establishing an emission rate per gas throughput. Emission rates per throughput are then established for the other important emission affecting characteristics. The emission factor is then:

$$EF = [(F_{FT} \times EF_{FT}) + (F_{NT} \times EF_{NT}) + (F_{SG} \times EF_{SG})] \times F_{NVC} \times OC$$

$$EF = [(0.669 \times 3.57) + (0.331 \times 175.10) + (0.0741 \times 670)] \times 0.852 \times 1.0$$

- F_{FT} = Fraction of the population WITH flash tanks
0.669 ± 9.70%
- F_{NT} = Fraction of the population WITHOUT flash tanks
0.331 ± 19.6%
- F_{SG} = Fraction of the population WITH stripping gas
0.0741 ± 118.26%
- F_{NVC} = Fraction of the population WITHOUT combusted vent controls
0.852 ± 14.0%
- EF_{FT} = Total CH₄ emission rate per 1 MMscf throughput for dehydrator that has a flash tank
3.57 scf/MMscf (+102% / -58%)
- EF_{NT} = Total CH₄ emission rate per 1 MMscf throughput for dehydrator that does NOT have a flash tank
175.1 scf/MMscf (+101% / -50%)
- EF_{SG} = Incremental emission rate per 1 MMscf throughput for dehydrator that has stripping gas
670 scf/MMscf (+40% / -60%)
- OC = Overcirculation factor for glycol--number of times the industry rule-of-thumb of 3 gallons glycol/lb water
1.0 ± 0%

EF DATA SOURCES:

1. *Methane Emissions from the Natural Gas Industry, Volume 14: Glycol Dehydrators* (1) establishes emission affecting characteristics of dehydrators.
2. Site visit data establishes the F_{SG} and F_{NVC} for multiple sites. Wyoming ADQ data also verifies F_{NVC} , though it implies a higher F , and thus a higher overall EF.
3. TMOGA/GPA survey of 1019 dehydrators established F_{FD} and F_{ND} and TP for dehydrators.
4. ASPEN computer simulations were used to determine EF_{FD} and EF_{ND} from the dehydrator vent.
5. Sampling data from the GRI Glycol Dehydrator Sampling and Analytical Program for one dehydrator was used to determine EF_{SG} (1). The upper bound was calculated by assuming that all of the measured noncondensable vent gas was due to stripping gas that was 100% methane. The lower bound was calculated as the rule-of-thumb stripping gas rate recommended by a glycol dehydrator manufacturer.

EF ACCURACY: 93.72 scf/MMscf \pm 207.99%

Basis:

The accuracy is propagated through the EF calculation from each term's accuracy:

1. ASPEN has been demonstrated to match actual dehydrators within $\pm 20\%$ within the calculated confidence intervals obtained from site data.
2. Individual EF confidence intervals were calculated based upon the spread of the site averages.

ACTIVITY FACTOR: (1.086 Tscf/year gas throughput in the transmission segment)

The amount of gas processed by glycol dehydrators in the transmission segment was calculated from the estimated number of glycol dehydrators in transmission service and the average throughput capacity for transmission dehydrators (Wright Killen & Co., 1994). See Source Sheet P-6 for a detailed discussion of the breakdown of glycol dehydrators into industry segments. The capacity utilization factor for transmission was assumed to be 1.

AF ACCURACY: 1.086 Tscf/year \pm 143.85%

Basis:

1. Uncertainty based on confidence limits from the site visit data.

ANNUAL METHANE EMISSIONS: (0.1018 Bscf/yr \pm 391.75%)

The annual methane emissions were determined by multiplying the dehydrator emission factor by the activity factor.

REFERENCES

1. Myers, D. *Methane Emissions from the Natural Gas Industry, Volume 14: Glycol Dehydrators*, Final Report, GRI-94/0257.31 and EPA-600/R-96-080n. Gas Research Institute and U.S. Environmental Protection Agency, June 1996.
2. Wright Killen & Co. *Natural Gas Dehydration: Status and Trends*, Final Report, Gas Research Institute, GRI-94/0099, January 1994.

S-1
STORAGE SOURCE SHEET

SOURCES:	Storage Facilities (Compressor Stations and Wells)
OPERATING MODE:	Normal Operation
EMISSION TYPE:	Steady and Unsteady, Fugitive
ANNUAL EMISSIONS:	16.76 Bscf ± 57%

BACKGROUND:

Equipment leaks are typically low-level, unintentional losses of process fluid (gas or liquid) from the sealed surfaces of above-ground process equipment. Equipment components that tend to leak include valves, flanges and other connectors, pump seals, compressor seals, pressure relief valves, open-ended lines, and sampling connections. These components represent mechanical joints, seals, and rotating surfaces, which in time tend to wear and develop leaks.

- EMISSION FACTOR:**
- a. Station = 7.85 MMscf/yr methane per station
 - b. Wellhead = 41.8 Mscf/yr methane per wellhead
 - c. Recip. Compressor = 7.71 MMscf/yr methane per recip
 - d. Turbine Compressor = 11.16 MMscf/yr methane per turbine

The average fugitive emission rate for storage facilities was determined to be composed of three parts: a) storage compressor station components (excluding compressor-related components), b) injection/withdrawal wellhead components, and c) compressor-related components. Fugitives from the compressor-related components have much higher emission factors than components in the rest of the facility. This is due in part to the high vibration that compressors generate, but most of the larger emissions are due to unique compressor components as explained below.

a) The contribution from non-compressor components was determined by multiplying the average number of fugitive components by the component emission factor. The number of components was subdivided into valves, connections/flanges, small open-ended lines, and other components (such as pressure relief valves); tubing components were determined to be insignificant. All of these components are typical fugitive components (as described in the EPA Fugitive Emissions Protocol) with the exception of site blowdown (B/D) open-ended lines (OELs). Site B/D OELs are the large diameter emergency station blowdown valves that are designed to depressure the entire site to the atmosphere when the valve is opened. Emission factors for storage station components were based on the GRI/Indaco program at 6 transmission compressor station sites.

b) The contribution from storage injection/withdrawal wells was determined in the same manner as storage compressor stations (see below). Emission factors for storage injection/withdrawal wells were based on the updated API/GRI/Star 20-site study (4 gas production sites). Physical and operational characteristics of injection/withdrawal wells were compared to gas production wells, and were found to be similar but typically larger (more components). This was taken into account in the component count data.

The number of components was subdivided into types, such as valves, connections/flanges, open-ended lines, and other components (such as pressure relief valves). The average facility/equipment emissions are calculated as follows:

$$EF = [(N_{vfv} \times EF_{vfv}) + (N_{cn} \times EF_{cn}) + (N_{oel} \times EF_{oel}) + (N_{oth} \times EF_{oth}) + (N_{prv} \times EF_{prv}) + (N_{site\ B/D} \times EF_{site\ B/D})]$$

where:

N_x = average count of components of type x per plant, and

EF_x = average methane emission rate per component of type x.

c) The contribution from compressor-related components was obtained by multiplying the average number of fugitive components per compressor engine by the component emission factors. The component emission factors were based on the GRI/Indaco measurement program conducted at 15 compressor stations. Some compressor components are unique, while others have higher leak rates than identical components elsewhere in the plant due to vibration. Compressors have the following types of components:

- 1) Comp. B/D OEL A blowdown (B/D) valve to the atmosphere that can depressure the compressor when idle. The B/D valve or the large unit block valves (depending on the operating status of the compressor) can act as an open-ended line that leaks at an extraordinarily high rate through the valve seat. The leak rate is dependent upon whether the compressor is pressurized (in operation or idle, pressurized) or depressurized (idle, depressurized).
- 2) Comp. PRV The pressure relief valve (PRV) is usually installed on a compressor discharge line and leaks at a higher than average rate due to vibration.
- 3) Comp. Starter OEL Most compressors have a gas starter motor that turns the compressor shaft to start the engine. Some use natural gas as the motive force to spin the starter's turbine blades and vent the discharge gas to the atmosphere. The inlet valve to the starter can leak and is therefore an OEL unique to compressors.
- 4) Comp. Seal All compressors have a mechanical or fluid seal to minimize the flow of pressurized natural gas that leaks from the location where the shaft penetrates the compression chamber. These seals are vented to the atmosphere. Reciprocating compressors have sliding shaft seals while centrifugal compressors have rotating shaft seals.
- 5) Miscellaneous There are many components on each compressor, such as valve covers on reciprocating compressor cylinders and fuel valves.

Each compressor has one B/D OEL, one PRV, and one starter OEL. Reciprocating compressors have one compressor seal per compression cylinder (which averaged 4.5 per engine), while centrifugal compressors have 1.5 seals per gas turbine. For the miscellaneous component category, there are many components per compressor engine, but the emission rates were minor and so were added into one lump emission factor per compressor for miscellaneous components.

All of the compressor emission factors take several correction factors into account. First, the various phases of compressor operations (such as the amount of time that compressors are a) idle and depressured, b) idle and pressured up, or c) running). This is actually a complex adjustment that takes into account valve position practices. [See *Methane Emissions from Natural Gas Industry, Volume 8: Equipment Leaks* (1) for more details.] Correction factors were also added for fraction of starter gas turbines using air instead of gas (40% for recip, 50% for turbines in storage).

EF DATA SOURCES:

1. Emission Factors for storage compressor stations are based upon GRI/Indaco transmission compressor station fugitive leak measurement surveys at 6 compressor stations. Compressor operating hours (% running) based on data from 5 national gas storage companies.
2. Component counts for storage compressor stations and injection/withdrawal wellheads are based on Radian site visits to 5 storage facilities.
3. Component emission factors for compressor-related components based on GRI/Indaco transmission compressor station fugitive leak measurement program at 15 compressor stations.
4. Wellhead emission factors based on simple average of GRI/Star data for gas production wellheads (Atlantic/Eastern region and Rest of U.S.).
5. Fraction of methane (93.4 mol%) based on data from GRI TRANSDAT database.

Average Facility Emissions for Gas Storage

Equipment Type	Component Type	Component Emission Factor, Mscf/component-yr	Average Component Count	Average Equipment Emissions, ^a MMscf/yr
Storage Facility (non-compressor related components)	Valve	0.867	1,868	7.85 (100%)
	Connection	0.147	5,571	
	OEL	11.2	353	
	PRV	6.2	66	
	Site B/D OEL	264	4	
Injection/Withdrawal Wellhead	Valve	0.918	30	0.042 (76%)
	Connection	0.125	89	
	OEL	0.237	7	
	PRV	1.464	1	
Reciprocating Compressors	Compressor B/D OEL	5,024 ^b	1	7.71 (48%)
	PRV	317 ^b	1	
	Miscellaneous	153 ^b	1	
	Compressor Starter OEL	1,440	0.6 ^c	
	Compressor Seal	300 ^b	4.5	
Centrifugal Compressors	Compressor B/D OEL	10,233 ^b	1	11.16 (34%)
	Miscellaneous	17 ^b	1	
	Compressor Starter OEL	1,440	0.5 ^c	
	Compressor Seal	126 ^b	1.5	

^a Values in parentheses represent 90% confidence interval.

^b Adjusted for the fraction of time the compressor is pressurized (67.5% and 22.4% for reciprocating and centrifugal compressors, respectively).

^c Adjusted for the fraction of compressor starters using natural gas (60% and 50% for reciprocating and centrifugal compressors, respectively).

- EF ACCURACY:
- a. Station = $\pm 100\%$
 - b. Wellhead = $\pm 76\%$
 - b. Recip. Compressor = $\pm 48\%$
 - c. Turbine Compressor = $\pm 34\%$

Basis:

Rigorously propagation of error from the spread of thousands of individual measurements taken by Indaco and Star.

- ACTIVITY FACTOR
- a. Station Activity Factor = 475 stations
 - b. Wellhead Activity Factor = 17999 wellheads
 - b. Compressor Activity Factor = 1396 recip compressors, 136 turbines

The activity factors for the segment were compiled from published statistics in *Gas Facts* (2). The total count for Underground storage stations was 386, and the total LNG storage count was 89.

AF DATA SOURCES:

1. The number of underground storage facilities was taken directly from A.G.A. *Gas Facts*, (2), Table 4-5: Number of Pools, Wells, Compressor Stations, and Horsepower in Underground Storage Fields. Data from base year 1992 were used.
2. The number of Liquefied Natural Gas Storage Facilities was summed from A.G.A. *Gas Facts* (2), Table 4-3, "Liquefied Natural Gas Storage Operations in the U.S. as of December 31, 1987." The table lists 54 complete plants, 32 satellite plants, and 3 import terminals for a total of 89 facilities.
3. Compressor engine count based on GRI TRANSDAT "industry database" with adjustments for total industry horsepower. Storage site visits to 8 storage sites provided number of reciprocating engines and turbines per site [see Activity Factor Report (3)]. Also, the number of reciprocating compressors in storage was increased by 31% to account for electric motor drivers.

- AF ACCURACY:
- a. Station Activity Factor: $\pm 5\%$
 - b. Wellhead Activity Factor: $\pm 5\%$
 - b. Compressor Activity Factor: Recip engines = $\pm 58\%$; Turbines = $\pm 119\%$

Basis:

1. A.G.A. *Gas Facts* (2) has a high percentage of all storage facilities represented in Tables 4-5 and 4-3. Therefore a national extrapolation should not add much error. This 5% figure was assigned based on engineering judgement.
2. The compressor count accuracy was assigned based upon the propagation from: a. Rigorous error propagation for the 8 storage station "compressor/station" averages; and b. Engineering judgement assignment of $\pm 10\%$ error to the large GRI TRANSDAT database.

ANNUAL METHANE EMISSIONS: (16.76 Bscf/yr \pm 9.6 Bscf/yr)

The annual emissions were determined by multiplying an emission factor for an average equipment type by the population of equipment in the segment.

Category	Emission Factor	Activity Factor	Emission Rate	Uncertainty
Station	7.85 MMscf/yr CH ₄	475 stations	3.73 Bscf/yr CH ₄	100%
Inj/With Wellheads	41.8 Mscf/yr CH ₄	17999 wellheads	0.752 Bscf/yr CH ₄	76%
Recip Comp	7.71 MMscf/yr CH ₄	1396 recip	10.76 Bscf/yr CH ₄	80%
Turbine Comp	11.16 MMscf/yr CH ₄	136 turbine	1.52 Bscf/yr CH ₄	129%
TOTAL			16.76 Bscf/yr CH ₄	57%

REFERENCES

1. Hummel, K.E., L.M. Campbell, and M.R. Harrison. *Methane Emissions from the Natural Gas Industry, Volume 8: Equipment Leaks*, Final Report, GRI-94/0257.25 and EPA-600/R-96-080h, Gas Research Institute and U.S. Environmental Protection Agency, June 1996.
2. American Gas Association. *Gas Facts*, Arlington, VA. 1992.
3. Stapper, B.E. *Methane Emissions from the Natural Gas Industry, Volume 5: Activity Factors*, Final Report, GRI-94/0257.22 and EPA-600/R-96-080e, Gas Research Institute and U.S. Environmental Protection Agency, June 1996.

S-2
STORAGE SOURCE SHEET

SOURCES: Glycol Dehydrators
 OPERATING MODE: Normal Operation
 EMISSION TYPE: Unsteady, Vented
 COMPONENTS: Reboiler Vents
 ANNUAL EMISSIONS: 0.23 Bscf ± 167%

BACKGROUND:

Glycol dehydrators remove water from a gas stream by contacting the gas with glycol and then driving the water from the glycol and into the atmosphere. The glycol also absorbs a small amount of methane, and some methane can be driven off to the atmosphere through the reboiler vent.

EMISSION FACTOR: (117.18 scf/MMscf ± 159.76%)

A thermodynamic computer simulation was used to determine the most important emission-affecting variables for dehydrators. The variables are: gas throughput, existence of a flash tank, existence of stripping gas, existence of a gas-assisted pump, existence of vent controls routed to a burner. Throughput, since its effect is linear, is handled by establishing an emission rate per gas throughput. Emission rates per throughput are then established for the other important emission affecting characteristics. The emission factor is then:

$$EF = [(F_{FT} \times EF_{FT}) + (F_{NT} \times EF_{NT}) + (F_{SG} \times EF_{SG})] \times F_{NVC} \times OC$$

$$EF = [(0.520 \times 3.57) + (0.480 \times 175.10) + (0.080 \times 670)] \times 0.840 \times 1.0$$

- F_{FT} = Fraction of the population WITH flash tanks
0.520 ± 33.56%
- F_{ND} = Fraction of the population WITHOUT flash tanks
0.480 ± 36.25%
- F_{SG} = Fraction of the population WITH stripping gas
0.080 ± 118.44%
- F_{NVC} = Fraction of the population WITHOUT combusted vent controls
0.840 ± 15.24%
- EF_{FT} = Total CH₄ emission rate per 1 MMscf throughput for dehydrator that has a flash tank
3.57 (+102% / -58%)
- EF_{NT} = Total CH₄ emission rate per 1 MMscf throughput for dehydrator that does NOT have a flash tank
175.10 (+101% / -50%)
- EF_{SG} = Incremental emission rate per 1 MMscfd throughput for dehydrator that has stripping gas
670 (+40% / -60%)
- OC = Overcirculation factor for glycol--number of times the industry rule-of-thumb of 3 gallons glycol/lb water
1.0 ± 0%

EF DATA SOURCES:

1. *Methane Emissions from the Natural Gas Industry, Volume 14: Glycol Dehydrators* (1) establishes emission affecting characteristics of dehydrators.
2. Site visit data establishes the F_{SG} and F_{NVC} for multiple sites. Wyoming ADQ data also verifies F_{NVC} , though it implies a higher F, and thus a higher overall EF.
3. TMOGA/GPA survey of 1019 dehydrators established F_{3P} and F_{ND} and TP for dehydrators.
4. ASPEN computer simulations were used to determine EF_{3P} and EF_{ND} from the dehydrator vent.
5. Sampling data from the GRI Glycol Dehydrator Sampling and Analytical Program for one dehydrator was used to determine EF_{SG} (1). The upper bound was calculated by assuming that all of the measured noncondensable vent gas was due to stripping gas that was 100% methane. The lower bound was calculated as the rule-of-thumb stripping gas rate recommended by a glycol dehydrator manufacturer.

EF ACCURACY: $117.18 \pm 159.76\%$

Basis:

The accuracy is propagated through the EF calculation from each term's accuracy:

1. ASPEN has been demonstrated to match actual dehydrators within $\pm 20\%$ within the calculated confidence intervals obtained from site data.
2. Individual EF confidence intervals were calculated based upon the spread of the site averages.

ACTIVITY FACTOR: (2.00 Tscf/year gas throughput in the storage segment)

The amount of gas processed by glycol dehydrators in the storage segment was calculated from the estimated amount of gas withdrawn from underground storage. A total of 2.4 Tscf was withdrawn in 1992, and it is assumed that most stored gas is dehydrated.

AF ACCURACY: $2.00 \text{ Tscf/year} \pm 25\%$

Basis:

1. Uncertainty based on estimate of confidence limits.

ANNUAL METHANE EMISSIONS: (0.2344 Bscf \pm 166.56%)

The annual methane emissions were determined by multiplying the dehydrator emission factor by the activity factor.

REFERENCES

1. Myers, D. *Methane Emissions from the Natural Gas Industry, Volume 14: Glycol Dehydrators*, Final Report, GRI-94/0257.31 and EPA-600/R-96-080n. Gas Research Institute and U.S. Environmental Protection Agency, June 1996.

APPENDIX D
Distribution Source Sheets

APPENDIX D

Distribution Source Sheets

	<u>Page</u>
D-1 - Meter and Pressure Regulating Stations	D-4
D-2 - Pipeline Leaks	D-7
D-3 - Maintenance/Upsets (PRV)	D-11
D-4 - Pipeline Dig-ins	D-12
D-5 - Customer Meters	D-14
D-6 - Pipeline Blowdown	D-17

DISTRIBUTION SOURCE SHEETS

This section contains the specific source sheets for the distribution segment of the natural gas industry. The following table serves as a guide for finding sheets in this section. The cells in the table give the sheet number (D-1, D-2, etc.) of the source sheet. The rows define the equipment covered, while the columns define the emission type. A category with no sheet number means that the emissions from that area were determined to be zero or negligibly small. The label for each source sheet is shown at the top of the cover page for that sheet.

TABLE OF CONTENTS	OPERATING MODE, EMISSION TYPE (Fugitive, Vented, or Combusted)									
	Start Up		Normal Operations			Maintenance		Upsets		Mishaps
	V	C	F	V	C	V	C	V	C	V
EQUIPMENT:										
Meter/Pressure Regulating Stations			D-1	D-1		D-3		D-3		
Main and Service Pipelines			D-2			D-6				D-4
Customer Meters			D-5							

D-1
DISTRIBUTION SEGMENT SOURCE SHEET

SOURCES: Meter/Pressure Regulating Stations
OPERATING MODE: Normal Operations
EMISSION TYPE: Steady, Fugitive
ANNUAL EMISSIONS: 27.3 +/- 23.3 Bscf

BACKGROUND:

Metering/pressure regulating stations are located throughout the distribution network to meter gas where a custody transfer occurs and/or to reduce and regulate the pressure in the downstream main pipeline. Emissions from fugitive losses and normal operations at meter and pressure regulating stations include both continuous and intermittent emissions from equipment components, such as pneumatic devices, valves, flanges, flow meters, and pressure regulators.

EMISSION FACTOR: (scf/station-hour)

The emission factor and standard deviation are given below for facilities located in vaults and above ground for different inlet pressure ranges:

Station Type	Inlet Pressure (psig)	Location in Vault?	Number of Samples	Average Emission Factor (scf/sta.-hr)	Standard Deviation of Emission Factor (scf/sta.-hr)	Precision of Emission Factor (scf/sta.-hr)
M&R	>300	N	31	179.8	236.1	69.8
M&R	100-300	N	6	95.6	130.6	107.4
M&R	<100	N	3	4.3	5.8	9.8
Regulating	>300	N	13	161.9	188.8	93.3
Regulating	>300	Y	4	1.3	2.0	2.4
Regulating	100-300	N	7	40.5	36.4	26.7
Regulating	100-300	Y	10	0.2	0.3	0.2
Regulating	40-100	N	7	1.0	1.1	0.8
Regulating	40-100	Y	8	0.1	0.1	0.1
Regulating	<40	Y	6	0.1	0.2	0.2

The emission factors were derived from data collected using a tracer gas measurement method. Downwind tracer measurements were performed by Aerodyne/Washington State University at 2 West Coast companies, 3 northeastern companies, 4 midwestern towns, and 3 southern plains towns. In total, 95 measurements were performed on metering/regulating stations in distribution and transmission systems.

The test data were analyzed to evaluate the differences in emissions from stations with different configurations (i.e., metering/regulating versus regulating only), inlet pressure ranges, and locations (i.e., in vaults versus above-ground). The test data were disaggregated into four distinct inlet pressure categories (>300 psig, 100-300 psig, 40-100 psig, and <40 psig), two station types (meter/pressure regulating facilities and pressure regulating facilities), and into stations in vaults versus above-ground, resulting in a total of 10 categories. These categories were selected for disaggregation of the data based on knowledge of the gas industry, and were confirmed to be statistically significant based on the data analyses.

ACTIVITY FACTOR: (number of stations)

The mean activity factor and standard deviation for each station type/inlet pressure/location category is given below:

Station Type	Inlet Pressure (psig)	Location in Vault?	Stations per Mile	Average Activity Factor (stations)	Standard Deviation of Activity Factor (stations)	Precision of Activity Factor (stations)
M&R	>300	N	0.004	3,460	3,965	2,458
M&R	100-300	N	0.016	13,335	22,728	14,091
M&R	<100	N	0.009	7,127	13,550	8,401
Regulating	>300	N	0.005	3,995	4,946	2,702
Regulating	>300	Y	0.003	2,346	2,905	1,587
Regulating	100-300	N	0.015	12,273	13,656	7,461
Regulating	100-300	Y	0.007	5,514	6,136	3,352
Regulating	40-100	N	0.043	36,328	42,785	23,375
Regulating	40-100	Y	0.039	32,215	37,942	20,729
Regulating	<40	Y	0.018	15,377	18,161	9,922

The number of stations in each inlet pressure/station type category were provided by twelve distribution companies. The data were extrapolated based on the total mileage of distribution main pipeline in the respective companies. The mean number of stations in each category per mile of main was estimated as the average of the values from eleven of the twelve companies supplying data. Based on conversations with one of the companies supplying data, the average number of stations per mile for the one company were not considered representative of typical industry practices. Therefore, this company was not included in the overall average, but rather was treated separately. The standard deviation represents the variation in the estimated number of stations per mile of main pipeline for each company. The precision represents the 90% confidence interval around the estimated mean activity factor.

The extrapolation from stations per mile to total stations in the U.S. was implemented by multiplying the stations per mile for each category by the total U.S. mileage of main pipeline: 836,760 miles.

Data were collected from five companies representing urban, rural, and suburban areas on the number of regulating stations in vaults versus above-ground in the U.S. On average, 37% of the regulating stations with

an inlet pressure greater than 300 psig are located in vaults. For regulating stations with an inlet pressure between 40 and 300 psig, it was found that the majority of stations in urban areas were in vaults and in rural areas were above-ground. On average, it was estimated that 31% of the stations are located in vaults with an inlet pressure between 100 and 300 psig. For regulating stations with an inlet pressure between 40 and 100 psig, 47% of the stations are located in vaults. Based on the data collected, the majority of the low pressure (<40 psig inlet pressure) stations are located in vaults.

ANNUAL EMISSIONS ESTIMATE: (27.3 +/- 23.3 Bscf)

Station Type	Inlet Pressure (psig)	Location in Vault?	Average Activity Factor (stations)	Average Emission Factor (scf/sta.-hr)	Annual Emissions Estimate (Bscf)	90% Confidence Interval of Emissions Estimate (Bscf)
M&R	>300	N	3,460	179.8	5.5	4.7
M&R	100-300	N	13,335	95.6	11.2	21.7
M&R	<100	N	7,127	4.3	0.3	1.2
Regulating	>300	N	3,995	161.9	5.7	5.5
Regulating	>300	Y	2,346	1.3	0.03	0.06
Regulating	100-300	N	12,273	40.5	4.4	4.3
Regulating	100-300	Y	5,514	0.2	0.01	0.01
Regulating	40-100	N	36,328	1.0	0.3	0.4
Regulating	40-100	Y	32,215	0.1	0.02	0.02
Regulating	<40	Y	15,377	0.1	0.02	0.03
Total			131,970		27.3	23.3

The emissions estimate for each category of station was derived by multiplying the respective emission factor (scf/station-hr) by the activity factor (number of stations), and converted to an annualized estimate by assuming continuous fugitive leakage (i.e., 8760 hour per year leakage). The precision represents the 90% confidence interval around the estimated mean emissions for each category.

D-2
DISTRIBUTION SEGMENT SOURCE SHEET

SOURCES: Main and Service Pipeline
OPERATING MODE: Normal Operations
EMISSION TYPE: Steady, Fugitives (Leakage)
ANNUAL EMISSIONS: 41.6 Bscf +/- 65%

BACKGROUND:

Distribution mains are the pipelines that serve as a common source of natural gas supply for more than one customer. Services are the branch connection lines from the mains to the customer meters. Leakage from the underground distribution network occurs from corrosion pits, joint and fitting failures, and pipe wall fractures. Gas distribution operators use leak detection procedures to locate and classify leaks. The leak is classified and prioritized for repair based on the concentration of gas detected and the proximity of the leak to existing structures.

EMISSION FACTOR: (scf/leak-year)

The value of the emission factor and standard deviation for each pipe material category is given below:

Material Category	Pipe Use	Number of Samples	Average Emission Factor ^a	Units of Emission Factor	90% Confidence Interval of Emission Factor
Cast Iron	Main	21	238,736	scf/mi-yr	152,059
Unprotected Steel	Main	20	51,802	scf/lk-yr	48,212
Protected Steel	Main	17	20,270	scf/lk-yr	17,243
Plastic	Main	6	99,845	scf/lk-yr	165,617
Unprotected Steel	Service	13	20,204	scf/lk-yr	21,129
Protected Steel	Service	24	9,196	scf/lk-yr	5,581
Plastic	Service	4	2,386	scf/lk-yr	3,412
Cooper	Service	5	7,684	scf/lk-yr	5,559

^a Adjusted for the soil oxidation of methane.

A cooperative leak measurement program has been developed to measure a representative sample of underground leaks to estimate the average leak intensity, which is combined with company leak records to estimate leak frequency. Leak measurements were performed at five U.S. companies and two Canadian distribution companies in accordance with the testing protocol developed as part of the program. The test data were disaggregated by material type and mains versus services, based on a combination of statistical analyses and engineering judgement. A mean value of the estimated leak rate per leak was calculated using

the test data, for all pipe materials except cast iron. In these tests, an individual leak was randomly selected for testing based on criteria outlined in the program plan. For cast iron, long segments of pipe were tested to measure the leak rate per mile rather than the leak rate per leak. Cast iron was tested in long segments since it tends to have a very high frequency of leaks (due to the joint spacing of 10 to 16 feet) and the relatively high occurrence of undetectable leaks in cast iron. The measured natural gas leak rates were adjusted for the average volume percent of methane in pipeline-quality gas (93.4 vol. %), and the soil oxidation rates of methane.

ACTIVITY FACTOR:

The mean activity factor and standard deviation for each pipe material category is given below:

Material Category	Pipe Use	Estimated Total Leak Repairs	Average Activity Factor (Equivalent Leaks)	Units of Activity Factor	90% Confidence Interval of Activity Factor
Cast Iron	Main	69,776	55,288	miles	2,764
Unprotected Steel	Main	81,627	174,657	equivalent leaks	101,685
Protected Steel	Main	31,924	68,308	equivalent leaks	42,545
Plastic	Main	23,006	49,226	equivalent leaks	58,018
Unprotected Steel	Service	214,271	458,476	equivalent leaks	499,850
Protected Steel	Service	182,562	390,628	equivalent leaks	526,354
Plastic	Service	32,202	68,903	equivalent leaks	66,840
Copper	Service	3,608	7,720	equivalent leaks	8,521

The national database of leak repairs was used to extrapolate data provided by individual companies. Data were requested from each company participating in the underground leak test program, based on their historical leak records. To allocate leak repairs into pipe material categories, data were collected from ten local distribution companies representing different regions within North America.

Data on the total number of annual leak repairs, leak indications, and outstanding leaks within the distribution system were provided by six companies. An estimate of the number of annual equivalent leaks for each of the six companies was developed based on the following methodology:

$$\text{Total Equivalent Leaks} = \text{Outstanding Leaks} + \text{New Leaks} - \text{Leak Repairs}$$

The total number of annual equivalent leaks represents the equivalent leaks which are leaking all year. (That is, for leaks with a leak duration of half year, these leaks are counted as half an equivalent annual leak.)

The total number of leaks in the system are quantified by incorporating the leak duration into the estimated equivalent leaks. For example, if a leak is only leaking half the year, it is counted as 0.5 equivalent leaks. The assumptions made in deriving the estimated number of equivalent leaks for each company include:

- Approximately 85 percent of leaks are found during a leak survey when an organic vapor analyzer (OVA) instrument is used along with bar holing.
- Leaks that are repaired during the year are leaking half of the year, on average.
- Outstanding leaks are leaking at the beginning of the year.
- The number of new leaks in the system is estimated based on the annual leak indications and the frequency of the leak survey.

The number of new leaks in a system that is surveyed every n years is calculated based on the following:

- For the first year in the cycle -- $1/n$ leaks are leaking half the year; $(n-1)/n$ leaks are not yet leaking.
- For the second year in the cycle -- $1/n$ leaks are leaking the entire year; $1/n$ leaks are leaking half the year; and $(n-2)/n$ leaks are not yet leaking.
- For the third year in the cycle -- $2/n$ leaks are leaking the entire year; $1/n$ leaks are leaking half the year; and $(n-3)/n$ leaks are not yet leaking.
- For the fourth year in the cycle -- $3/n$ leaks are leaking the entire year; $1/n$ leaks are leaking half the year; and $(n-4)/n$ leaks are not yet leaking.

Based on the data provided by each of the six companies, a ratio of the annual equivalent leaks to leak repairs was calculated. The average ratio (2.14) was multiplied by the estimated number of leak repairs in each pipe material category to extrapolate the national database of leak repairs to represent annual equivalent leaks. The precision of the estimate is based on the variability in the leak repair disaggregation provided by ten companies and the variability in the calculated ratio of annual equivalent leaks to leak repairs provided by six companies.

The activity factor for cast iron mains is the total estimated mileage of cast iron mains in the U.S., as reported by the U.S.DOT RSPA (1). The standard deviation was assumed to be 5% of the estimated mileage, based on engineering judgement.

EMISSIONS ESTIMATE: (41.6 +/- 65 %)

The emissions estimate for each category of pipe material/use was derived multiplying the respective emission factor (scf/leak-yr or scf/mile-yr) by the activity factor (total number of leaks or miles).

Material Category	Pipe Use	Average Emission Factor (scf/lk-yr)	Average Activity Factor (equivalent leaks)	Annual Emissions Estimate (Bscf)	90% Confidence Interval of Emission Estimate (Bscf)
Cast Iron	Main	238,736 ^a	55,288 ^b	13.2	8.4
Unprotected Steel	Main	51,802	174,657	9.1	11.1
Protected Steel	Main	20,270	68,308	1.4	1.6
Plastic	Main	99,845	49,226	4.9	13.9
Unprotected Steel	Service	20,204	458,476	9.3	17.5
Protected Steel	Service	9,196	390,628	3.6	6.1
Plastic	Service	2,386	68,903	0.2	0.4
Copper	Service	7,684	7,720	0.1	0.1
Total				41.6	27.1

^ascf/mile-yr

^bmiles

REFERENCES

1. U.S. Department of Transportation. Research and Special Programs Administration. 1991.

D-3
DISTRIBUTION SEGMENT SOURCE SHEET

SOURCES:	Pressure Relief Valves
OPERATING MODE:	Maintenance/Upsets
EMISSION TYPE:	Unsteady, Vented
ANNUAL EMISSIONS:	0.04 Bscf \pm 3,919%

BACKGROUND:

Pressure relief valves (PRVs) are often used in the distribution network to prevent the over-pressure of distribution main pipelines. Typically, PRVs are used in conjunction with pressure regulators as a secondary protection mechanism in the event of regulator failure. Gas is released during any emergency actuation of the PRVs.

EMISSION FACTOR: 0.050 \pm 3,914% Mscf/mile
(Adjusted for the distribution methane fraction of natural gas of 93.4 mol%)

The estimated emission factor was based on two separate distribution company studies which quantified losses from PRVs as part of unaccounted-for (UAF) gas studies. The studies calculated PRV releases per mile of pipeline mains. The GRI/EPA emission factor was estimated as the ratio of emissions per mile of main from the two companies, and corrected for the methane composition in distribution.

EF PRECISION: \pm 3,914%

Basis:

The precision was calculated using the method outlined in the *Statistics Report* (1).

ACTIVITY FACTOR: 836,760 \pm 5% miles of main

The activity factor is based on the total miles of distribution main pipeline in the U.S.

AF PRECISION: \pm 5%

Basis:

The accuracy was assigned based on engineering judgement.

ANNUAL METHANE EMISSIONS: 0.042 \pm 3,919% Bscf

The annual methane emissions were determined by multiplying an emission factor (annual methane emissions per mile of main) by the activity factor (miles of distribution main pipeline nationally).

REFERENCES

1. Williamson, H.J., M.B. Hall, and M.R. Harrison. *Methane Emissions from the Natural Gas Industry, Volume 4: Statistical Methodology*, Final Report, GRI-94/0257.21 and EPA-600/R-96-080d, Gas Research Institute and U.S. Environmental Protection Agency, June 1996.

D-4
DISTRIBUTION SEGMENT SOURCE SHEET

SOURCES: Pipeline
OPERATING MODE: Mishaps (Dig-ins)
EMISSION TYPE: Unsteady, Fugitive
ANNUAL EMISSIONS: 2.1 Bscf \pm 1,925%

BACKGROUND:

Dig-ins are distribution main or service pipeline ruptures caused by unintentional third-party damage. Some distribution companies estimate and record the quantity of gas lost during a dig-in event; therefore, they keep records of estimated annual losses due to dig-ins. From these annual records, a national emission rate for dig-ins was determined.

ANNUAL EMISSION FACTOR: 1.59 \pm 1,922% Mscf/mile
(Adjusted for the distribution methane fraction of natural gas of 93.4 mol%)

The emission factor was derived from four distribution company estimates of the losses from dig-ins: the Pacific Gas and Electric unaccounted-for (UAF) gas study (1) results showed that losses from dig-ins were estimated at 91,178 Mscf for 58,024 miles of distribution mains and services; the Southern California Gas Company estimate (2) of losses from dig-ins was 170,457 Mscf for 82,337 miles of distribution mains and services; a third company estimate of losses from dig-ins was 19,581 Mscf for 24,916 miles of distribution mains and services; and a fourth company reported dig-in losses of 10,453 Mscf for 18,713 miles of distribution mains. The ratio of the total dig-in emissions to the total pipeline miles from these companies was used to estimate the national methane emission factor, resulting in 2.06 Mscf/mile.

EF PRECISION: \pm 1,922%

Basis:

The precision was calculated from the spread of the company data using the method presented in the *Methane Emissions from the Natural Gas Industry, Volume 4: Statistical Methodology* (3).

ACTIVITY FACTOR: 1,297,569 \pm 5% miles of mains and services

The total number of miles of main pipeline in the U.S. gas industry was based on U.S. Department of Transportation, Research and Special Projects Administration (4). The total miles of service pipeline was reported in A.G.A.'s *Gas Facts*, 1990 (5).

AF PRECISION: \pm 5%

Basis:

A 5% confidence bound was assigned on the basis of good precision from national statistics of 1990 data.

ANNUAL METHANE EMISSIONS: 2.06 \pm 1,925% Bscf

The annual methane emissions were determined by multiplying an emission factor (annual methane emissions per mile of pipeline) by the activity factor (number of miles).

REFERENCES

1. Pacific Gas & Electric Company and Gas Research Institute. *Unaccounted-For Gas Project*. Volume 1, Final Report, San Ramon, CA, June 7, 1990.
2. Southern California Gas Company and Gas Research Institute. *A Study of the 1991 Unaccounted-For Gas Volume at the Southern California Gas Company*, Final Report, Los Angeles, CA, April 1993.
3. Williamson, H.J., M.B. Hall, and M.R. Harrison. *Methane Emissions from the Natural Gas Industry, Volume 4: Statistical Methodology*, Final Report, GRI-94/0257.21 and EPA-600/R-96-080d, Gas Research Institute and U.S. Environmental Protection Agency, June 1996.
4. U.S. Department of Transportation, Research and Special Projects Administration, Washington, DC, 1991.
5. American Gas Association. *Gas Facts, 1992 Data*, Arlington, VA, 1993.

D-5
DISTRIBUTION SEGMENT SOURCE SHEET

SOURCES: Customer Meters
 OPERATING MODE: Normal Operations
 EMISSION TYPE: Steady, Fugitive
 ANNUAL EMISSIONS: 5.8 ± 1.1 bscfy

BACKGROUND:

Losses from customer meters are caused by fugitive leakage from the connections and other fittings surrounding the meter set.

EMISSION FACTOR: (outdoor residential meters: 138.5 ± 23.1 scf/meter-yr
 commercial/industrial meters: 47.9 ± 16.7 scf/meter-yr)

The estimate of leakage from customer meters is based on screening and bagging studies conducted at ten sites throughout the United States. The initial study was conducted by Indaco to measure customer meters in the west coast [Indaco Air Quality Services, Inc., *Methane Emissions from Natural Gas Customer Meters: Screening and Enclosure Studies*, draft report, August 15, 1992 (1)]. Data were also collected at nine additional sites across the United States, including three east coast sites, a mid-western site, a rocky mountain site, and five western U.S. sites. A summary of the average emissions from residential customer meters from each of the ten sites is shown in the following table:

Site	Number of Meters Screened	Number of Meters Leaking	Average Leak Rate * (lb methane/day)	Standard Deviation* (lb methane/day)
Site 1 -- West Coast	134	37	0.0098	0.0239
Site 2 -- East Coast	40	29	0.0002	0.0004
Site 3 -- East Coast	158	37	0.0789	0.1753
Site 4 -- Mid-West	156	8	0.0057	0.0061
Site 5 -- Rocky Mountain	188	28	0.0035	0.0082
Site 6 -- West Coast	194	5	0.0002	0.0001
Site 7 -- South East	201	56	0.0146	0.0328
Site 8 -- North West	101	31	0.0101	0.0199
Site 9 -- South West	150	50	0.0222	0.0404
Site 10 -- North West	150	40	0.0125	0.0230

*Average value for all meters (i.e., leaking and non-leaking) screened at the site.

The average emission factor for residential customer meters was derived by averaging the emission rates for the ten sites. The emission factor was converted to units of scf/meter-yr by assuming that the losses from the leaking meters were continuous throughout the year.

The precision represents the 90 % confidence interval and was calculated by averaging the standard deviations for the ten sites.

The emission factor for commercial/industrial customer meters was derived from screening data collected at a total of four sites. A summary of the average emissions from each of the four sites is shown in the following table:

Site	Number of Meters Screened	Number of Leaking Meters	Average Leak Rate* (lb methane/day)	Standard Deviation* (lb methane/day)
Site 3 -- East Coast	45	12	0.0112	0.0251
Site 4 -- Mid-West	61	0	--	--
Site 5 -- Rocky Mountain	21	6	0.0088	0.0076
Site 6 -- West Coast	22	1	0.0018	--

*Average value for all meters (i.e., leaking and non-leaking) screened at the site.

The average emission factor for commercial/industrial customer meters was derived by averaging the emission rates for the four sites. The emission factor was converted to units of scf/meter-yr by assuming that the losses from the leaking meters was continuous throughout the year.

ACTIVITY FACTOR: (outdoor residential meters: 40,049,306 ± 4,200,135
commercial/industrial meters: 4,608,000 ± 230,400)

The total number of customer meters in the U.S. gas industry, 56,132,300, and the number of residential customer meters, 51,524,600, were based on *Gas Facts*, American Gas Association, 1992 (2). The number of residential customer meters located indoors versus outdoors was estimated based on a regional breakdown of total customers presented in *Gas Facts* (2) combined with data obtained from 22 individual gas companies within different regions of the country. (Note: The number of customers in each region was used to estimate the number of indoor meters because data on number of customer meters segregated by region were not available.)

Following is the average percentage of customer meters located indoors in each region:

Region	Total Residential Customers	Average Percent Indoor Meters	Sample Size	Estimated Indoor Meters	Precision
New England	1,886,500	52	1	980,980	471,625*
Middle Atlantic	8,403,400	61	7	5,126,074	1,905,371
East North Central	11,633,500	17	7	1,977,695	1,461,663
West North Central	4,684,100	40	1	1,873,640	1,873,640*
South Atlantic	4,987,700	21	4	1,030,680 ^b	1,030,680*
East South Central	2,465,200	0	--	0	123,260 ^c
West South Central	5,666,600	0	--	0	283,330 ^c
Mountain	3,318,700	0	--	0	331,870 ^c
Pacific	9,724,500	5	2	486,225	486,225*
TOTAL	52,770,200		22	11,475,294	3,317,254

*Estimated based on engineering judgement.

^bEstimated for each state separately in region.

^cEstimated based on industry comments suggesting that customer meters in southern regions are essentially all located outdoors.

The estimated number of indoor meters, 11,475,294, was subtracted from the total number of reported meters, 51,524,600, to derive an estimated 40,049,306 outdoor residential customer meters in the United States. The precision was estimated from the data provided by the companies, engineering judgement for some regions, and an estimated 5% error in the nationally reported number of residential customer meters.

The leakage rates from customer meters located indoors was assumed to be negligible based on the increased probability that leaks on indoor meter sets are detected and repaired promptly. This assumption of negligible leakage from indoor meters is consistent with the findings from pressure regulating stations located in vaults.

The precision of the total estimated commercial/industrial customer meters is assumed to be $\pm 5\%$ of the estimated 4,608,000 meters.

ANNUAL METHANE EMISSIONS: $(5.8 \pm 1.1 \text{ Bscf/yr})$

REFERENCES

1. Indaco Air Quality Services, Inc. *Methane Emissions from Natural Gas Customer Meters: Screening and Enclosure Studies*, Draft Report, August 15, 1992.
2. American Gas Association. *Gas Facts*. Arlington, VA. 1992.

D-6
DISTRIBUTION SEGMENT SOURCE SHEET

SOURCES: Pipeline
 OPERATING MODE: Maintenance
 EMISSION TYPE: Unsteady, Vented
 ANNUAL EMISSIONS: 0.13 Bscf \pm 2,524%

BACKGROUND:

Gas is blown to the atmosphere as a result of pipeline abandonment, installation, and repair.

ANNUAL EMISSION FACTOR: 0.102 \pm 2,521% Mscf/mile
 (Adjusted for the distribution methane fraction of natural gas of 93.4 mol%)

The emission factors for pipeline blowdown are based on estimates from four companies: the Pacific Gas & Electric Unaccounted-for Gas (UAF) Project, 1987 (1); the Southern California Gas Company (SoCal) project (2); and two additional company estimates. The estimated total gas losses were adjusted for 93.4 volume percent methane. The annual methane emissions per mile of mains and services for each of the four companies was calculated based on the ratio of emissions to miles of distribution mains and services. The following table summarizes the individual company estimates and the national emission factor. The precision of the estimate is based on the 90 percent confidence level for the four companies providing data.

Company	Annual Blowdown Methane Emissions, Mscf	Pipeline Miles	Annual Blowdown Methane Emission Factor, scf/mile
1	8,972	58,024	0.155
2	5,688	82,337	0.069
3	2,360	24,916	0.095
4	1,695	18,713	0.091
TOTALS	18,715	183,990	
ANNUAL BLOWDOWN EF, Mscf methane/mile			0.102 \pm 2,521%

ACTIVITY FACTOR: (1,297,569 \pm 5% miles mains and services)

The total number of miles main pipeline in the U.S. gas industry was based on U.S. Department of Transportation, Research and Special Projects Administration (3). The total miles of service was reported in *Gas Facts* (4). The precision, or 90 percent confidence level, was estimated to be \pm 5%, based on engineering judgement.

ANNUAL METHANE EMISSIONS: 0.13 \pm 2,524% Bscf

The annual methane emissions were determined by multiplying an emission factor (annual methane emissions per mile of pipeline) by the activity factor (number of miles).

REFERENCES

1. Pacific Gas & Electric Company and Gas Research Institute. *Unaccounted-For Gas Project*. Volume 1, Final Report, San Ramon, CA, June 7, 1990.
2. Southern California Gas Company and Gas Research Institute. *A Study of the 1991 Unaccounted-For Gas Volume at the Southern California Gas Company*. Final Report, Los Angeles, CA, April 1993.
3. U.S. Department of Transportation, Research and Special Projects Administration, Washington, DC, 1991.
4. American Gas Association. *Gas Facts, 1992 Data*, Arlington, VA, 1993.

APPENDIX E
Conversion Table

Unit Conversion Table

English to Metric Conversions

1 scf methane	=	19.23 g methane
1 Bscf methane	=	0.01923 Tg methane
1 Bscf methane	=	19,230 metric tonnes methane
1 Bscf	=	28.32 million standard cubic meters
1 short ton (ton)	=	907.2 kg
1 lb	=	0.4536 kg
1 ft ³	=	0.02832 m ³
1 ft ³	=	28.32 liters
1 gallon	=	3.785 liters
1 barrel (bbl)	=	158.97 liters
1 inch	=	2.540 cm
1 ft	=	0.3048 m
1 mile	=	1.609 km
1 hp	=	0.7457 kW
1 hp-hr	=	0.7457 kW-hr
1 Btu	=	1055 joules
1 MMBtu	=	293 kW-hr
1 lb/MMBtu	=	430 g/GJ
T (°F)	=	1.8 T (°C) + 32
1 psi	=	51.71 mm Hg

Global Warming Conversions

Calculating carbon equivalents of any gas:

$$\text{MMTCE} = (\text{MMT of gas}) \times \left(\frac{\text{MW, carbon}}{\text{MW, gas}} \right) \times (\text{GWP})$$

Calculating CO₂ equivalents for methane:

$$\text{MMT of CO}_2 \text{ equiv.} = (\text{MMT CH}_4) \times \left(\frac{\text{MW, CO}_2}{\text{MW, CH}_4} \right) \times (\text{GWP})$$

where MW (molecular weight) of CO₂ = 44, MW carbon = 12, and MW CH₄ = 16.

Notes

scf	=	Standard cubic feet. This is the cubic feet that the gas would occupy if it were at the standard conditions of 14.73 psi, absolute, and 60°F. For a fixed gas composition, a scf defines a mass.
Bscf	=	Billion standard cubic feet (10 ⁹ scf).
Tscf	=	Trillion standard cubic feet (10 ¹² scf).
MMscf	=	Million standard cubic feet.
Mscf	=	Thousand standard cubic feet.
Tg	=	Teragram (10 ¹² g).
Giga (G)	=	Same as billion (10 ⁹).
Metric tonnes	=	1000 kg.
psig	=	Gauge pressure.
psia	=	Absolute pressure (note psia = psig + atmospheric pressure).
scfd,scfy	=	Standard cubic feet per day, standard cubic feet per year.
mol%	=	Percent of molecules in a stream that are of one type.
vol%	=	Percent of the volume of a stream that is of one species. For an ideal gas, vol% is equal to mol%.

wt%	=	Percent of the mass (weight) of a stream that is of one species.
Prod	=	Production
Proc	=	Gas Processing
Trans		Transmission
Dist		Distribution
GWP	=	Global Warming Potential of a particular greenhouse gas for a given time period.
MMT	=	Million metric tonnes of a gas.
MMTCE	=	Million metric tonnes, carbon equivalent.
MMT of CO ₂ eq.	=	Million metric tonnes, carbon dioxide equivalent.

TECHNICAL REPORT DATA
(Please read instructions on the reverse before completing)

1. REPORT NO. EPA-600/R-96-080c		2.	3. RECIPIENT'S ACCESSION NO.	
4. TITLE AND SUBTITLE Methane Emissions from the Natural Gas Industry, Volumes 1-15 (Volume 3: General Methodology)			5. REPORT DATE June 1996	
			6. PERFORMING ORGANIZATION CODE	
7. AUTHOR(S) L. Campbell, M. Campbell, M. Cowgill, D. Epperson, M. Hall, M. Harrison, K. Hummel, D. Myers, T. Shires, B. Stapper, C. Stapper, J. Wessels, and *			8. PERFORMING ORGANIZATION REPORT NO. DCN 96-263-081-17	
9. PERFORMING ORGANIZATION NAME AND ADDRESS Radian International LLC P. O. Box 201088 Austin, Texas 78720-1088			10. PROGRAM ELEMENT NO.	
			11. CONTRACT/GRANT NO. 5091-251-2171 (GRI) 68-D1-0031 (EPA)	
12. SPONSORING AGENCY NAME AND ADDRESS EPA, Office of Research and Development Air Pollution Prevention and Control Division Research Triangle Park, NC 27711			13. TYPE OF REPORT AND PERIOD COVERED Final; 3/91-4/96	
			14. SPONSORING AGENCY CODE EPA/600/13	
15. SUPPLEMENTARY NOTES EPA project officer is D. A. Kirchgessner, MD-63, 919/541-4021. Cosponsor GRI project officer is R. A. Lott, Gas Research Institute, 8600 West Bryn Mawr Ave., Chicago, IL 60631. (*)H. Williamson (Block 7).				
16. ABSTRACT The 15-volume report summarizes the results of a comprehensive program to quantify methane (CH ₄) emissions from the U.S. natural gas industry for the base year. The objective was to determine CH ₄ emissions from the wellhead and ending downstream at the customer's meter. The accuracy goal was to determine these emissions within +/-0.5% of natural gas production for a 90% confidence interval. For the 1992 base year, total CH ₄ emissions for the U.S. natural gas industry was 314 +/- 105 Bscf (6.04 +/- 2.01 Tg). This is equivalent to 1.4 +/- 0.5% of gross natural gas production, and reflects neither emissions reductions (per the voluntary AmeriGas Association/EPA Star Program) nor incremental increases (due to increased gas usage) since 1992. Results from this program were used to compare greenhouse gas emissions from the fuel cycle for natural gas, oil, and coal using the global warming potentials (GWPs) recently published by the Intergovernmental Panel on Climate Change (IPCC). The analysis showed that natural gas contributes less to potential global warming than coal or oil, which supports the fuel switching strategy suggested by the IPCC and others. In addition, study results are being used by the natural gas industry to reduce operating costs while reducing emissions.				
17. KEY WORDS AND DOCUMENT ANALYSIS				
a. DESCRIPTORS		b. IDENTIFIERS/OPEN ENDED TERMS		c. COSATI Field/Group
Pollution Emission Greenhouse Effect Natural Gas Gas Pipelines Methane		Pollution Prevention Stationary Sources Global Warming		13B 14G 04A 21D 15E 07C
18. DISTRIBUTION STATEMENT Release to Public		19. SECURITY CLASS (This Report) Unclassified		21. NO. OF PAGES 188
		20. SECURITY CLASS (This page) Unclassified		22. PRICE

U.S. ENVIRONMENTAL PROTECTION AGENCY

Office of Research and Development
National Risk Management Research Laboratory
Technology Transfer and Support Division
Cincinnati, Ohio 45268

OFFICIAL BUSINESS

**PENALTY FOR PRIVATE USE, \$300
AN EQUAL OPPORTUNITY EMPLOYER**

*If your address is incorrect, please change on the above label
tear off; and return to the above address.*

*If you do not desire to continue receiving these technical
reports, CHECK HERE ; tear off label, and return it to the
above address.*

Publication No. EPA-600/R-96-080c