



Development Document for Effluent Limitations Guidelines and Standards for the Electrical and Electronic Components

Final

Point Source Category

Phase II



DEVELOPMENT DOCUMENT

for

EFFLUENT LIMITATIONS GUIDELINES

for the

ELECTRICAL AND ELECTRONIC COMPONENTS
POINT SOURCE CATEGORY
PHASE 2

William D. Ruckelshaus
Administrator

Steven Schatzow
Director
Office of Water Regulations and Standards

Jeffery Denit, Director
Effluent Guidelines Division

G. Edward Stigall, Chief
Inorganic Chemicals Branch

John Newbrough
Project Officer

December 1983

U.S. Environmental Protection Agency
Office of Water
Office of Water Regulations and Standards
Effluent Guidelines Division
Washington, D.C. 20460

TABLE OF CONTENTS

<u>SECTION</u>	<u>TITLE</u>	<u>PAGE</u>
EXECUTIVE SUMMARY		1
CONCLUSIONS		1
EFFLUENT LIMITATIONS AND STANDARDS		1
1.0	INTRODUCTION	1-1
1.1	ORGANIZATION AND CONTENT OF THIS DOCUMENT	1-1
1.2	SOURCES OF INDUSTRY DATA	1-1
2.0	LEGAL BACKGROUND	2-1
2.1	PURPOSE AND AUTHORITY	2-1
2.2	GENERAL CRITERIA FOR EFFLUENT LIMITATIONS	2-2
2.2.1	BPT Effluent Limitations	2-2
2.2.2	BAT Effluent Limitations	2-3
2.2.3	BCT Effluent Limitations	2-4
2.2.4	New Source Performance Standards	2-4
2.2.5	Pretreatment Standards for Existing Sources	2-4
2.2.6	Pretreatment Standards for New Sources	2-5
3.0	INDUSTRY SUBCATEGORIZATION	3-1
3.1	RATIONALE FOR SUBCATEGORIZATION	3-1
3.2	SUBCATEGORIZATION REVIEW	3-1
3.3	CONCLUSIONS	3-1
4.0	DESCRIPTION OF THE INDUSTRY	4-1
4.1	CATHODE RAY TUBES	4-1
4.1.1	Number of Plants and Production Capacity	4-1
4.1.2	Product Description	4-1
4.1.3	Manufacturing Processes and Materials	4-4
4.2	RECEIVING AND TRANSMITTING TUBES	4-8
4.2.1	Number of Plants and Production Capacity	4-8
4.2.2	Product Description	4-8
4.2.3	Manufacturing Processes and Materials	4-10

TABLE OF CONTENTS (Continued)

<u>SECTION</u>	<u>TITLE</u>	<u>PAGE</u>
4.3	LUMINESCENT MATERIALS	4-15
4.3.1	Number of Plants	4-15
4.3.2	Product Description	4-15
4.3.3	Manufacturing Processes and Materials	4-16
5.0	WASTEWATER CHARACTERISTICS	5-1
5.1	SAMPLING AND ANALYTICAL PROGRAM	5-1
5.1.1	Pollutants Analyzed	5-1
5.1.2	Sampling Methodology	5-4
5.1.3	Analytical Methods	5-4
5.2	CATHODE RAY TUBES	5-5
5.2.1	Wastewater Flow	5-5
5.2.2	Wastewater Sources	5-5
5.2.3	Pollutants Found and the Sources of These Pollutants	5-5
5.3	LUMINESCENT MATERIALS	5-24
5.3.1	Wastewater Flow	5-24
5.3.2	Wastewater Sources	5-24
5.3.3	Pollutants Found and the Sources of These Pollutants	5-24
5.4	RECEIVING AND TRANSMITTING TUBES	5-34
6.0	SUBCATEGORIES AND POLLUTANTS TO BE REGULATED EXCLUDED OR DEFERRED	6-1
6.1	SUBCATEGORIES TO BE REGULATED	6-1
6.1.1	Pollutants to be Regulated	6-1
6.2	TOXIC POLLUTANTS AND SUBCATEGORIES NOT REGULATED	6-4
6.2.1	Exclusion of Pollutants	6-5
6.2.2	Exclusion of Subcategories	6-7
6.3	CONVENTIONAL POLLUTANTS NOT REGULATED	6-8
7.0	CONTROL AND TREATMENT TECHNOLOGY	7-1
7.1	CURRENT TREATMENT AND CONTROL PRACTICES	7-1
7.1.1	Cathode Ray Tube Subcategory	7-1
7.1.2	Luminescent Materials Subcategory	7-2
7.2	APPLICABLE TREATMENT TECHNOLOGIES	7-2
7.2.1	pH Control	7-2
7.2.2	Toxic Metals Treatment	7-2

TABLE OF CONTENTS (Continued)

<u>SECTION</u>	<u>TITLE</u>	<u>PAGE</u>
7.2.3	Fluoride Treatment	7-6
7.2.4	Filtration	7-7
7.2.5	Chemical Chromium Reduction	7-7
7.2.6	Total Toxic Organics Control	7-8
7.3	RECOMMENDED TREATMENT AND CONTROL SYSTEMS	7-10
7.4	ANALYSIS OF INDUSTRY PERFORMANCE DATA	7-12
7.4.1	Cathode Ray Tube Subcategory	7-12
7.4.2	Luminescent Materials Subcategory	7-17
7.4.3	Statistical Methodology	7-17
8.0	SELECTION OF APPROPRIATE CONTROL AND TREATMENT TECHNOLOGIES AND BASES FOR LIMITATIONS	8-1
8.1	CATHODE RAY TUBE SUBCATEGORY	8-1
8.1.1	Pretreatment Standards for Existing Sources (PSES)	8-1
8.1.2	New Source Performance Standards (NSPS)	8-3
8.1.3	Pretreatment Standards for New Sources (PSNS)	8-4
8.2	LUMINESCENT MATERIALS SUBCATEGORY	8-5
8.2.1	New Source Performance Standards (NSPS)	8-5
8.2.2	Pretreatment Standards for New Sources (PSNS)	8-6
9.0	COST OF WASTEWATER TREATMENT AND CONTROL	9-1
9.1	COST ESTIMATING METHODOLOGY	9-1
9.1.1	Direct Investment Costs for Land and Facilities	9-2
9.1.2	Annual Costs	9-4
9.1.3	Items Not Included in Cost Estimate	9-6
9.2	COST ESTIMATES FOR TREATMENT AND CONTROL OPTIONS	9-6
9.3	ENERGY AND NON-WATER QUALITY ASPECTS	9-17
10.0	ACKNOWLEDGMENTS	10-1
11.0	BIBLIOGRAPHY	11-1
12.0	GLOSSARY	12-1
APPENDIX 1 - PLANT 99797 RAW WASTES SELF-MONITORING DATA		
APPENDIX 2 - PLANT 30172 SELF-MONITORING EFFLUENT DATA FOR FLUORIDE		

TABLE OF CONTENTS (Continued)

<u>SECTION</u>	<u>TITLE</u>	<u>PAGE</u>
APPENDIX 3	- PLANT 30172 TTO MONITORING DATA	
APPENDIX 4	- PLANT 99798 EFFLUENT MONITORING DATA	
APPENDIX A	- CALCULATION OF LIMITATIONS FOR THE ELECTRICAL AND ELECTRONIC COMPONENTS - PHASE II CATEGORY	
APPENDIX B	- A LISTING OF THE DATA FROM PLANT 99796	
APPENDIX C	- A LISTING OF THE FLUORIDE DATA FROM PLANT 30172	
APPENDIX D	- A LISTING OF THE POLLUTANT CONCENTRATION DATA FROM PLANT 99798	
APPENDIX E	- DETAILS OF THE NOTATION AND FORMULAE USED TO ESTIMATE AVERAGES, VARIABILITY FACTORS, AND LIMITATIONS	

LIST OF FIGURES

<u>NUMBER</u>	<u>TITLE</u>	<u>PAGE</u>
4-1	Color Television Picture Tube	4-3
4-2	Television Picture Tube Manufacture	4-5
4-3	CRT Manufacture	4-7
4-4	Receiving Tube	4-9
4-5	Transmitting Tube	4-11
4-6	Receiving Tube Manufacture	4-12
4-7	Transmitting Tube Manufacture	4-14
4-8	Lamp Phosphor Process	4-17
4-9	Blue Phosphor Process	4-19
5-1	Plant 30172 Sampling Locations	5-8
5-2	Plant 11114 Sampling Locations	5-9
5-3	Plant 99796 Sampling Locations	5-10
5-4	Plant 101 Sampling Locations	5-26
7-1	Theoretical Solubilities of Toxic Metal Hydroxides/Oxides as a Function of pH	7-4
7-2	Recommended Treatment--Cathode Ray Tube Subcategory	7-13
7-3	Recommended Treatment--Luminescent Materials Subcategory	7-14
9-1	Annual Cost vs. Flow for Option 2 Technology - Cathode Ray Tubes	9-11
9-2	Annual Cost vs. Flow for Option 2 Technology - Luminescent Materials	9-12
9-3	Annual Cost vs. Flow for Option 3 Technology - Cathode Ray Tubes	9-15

LIST OF TABLES

<u>NUMBER</u>	<u>TITLE</u>	<u>PAGE</u>
1	PSES Regulations for Cathode Ray Tubes	2
2	NSPS Regulations for Cathode Ray Tubes	2
3	PSNS Regulations for Cathode Ray Tubes	2
4	NSPS Regulations for Luminescent Materials	3
5	PSNS Regulations for Luminescent Materials	3
5-1	Toxic Pollutants	5-2
5-2	Cathode Ray Tubes Summary of Raw Waste Data	5-7
5-3	Wastewater Sampling Data Plant 30172	5-11
5-4	Wastewater Sampling Data Plant 11114	5-14
5-5	Wastewater Sampling Data Plant 99796	5-22
5-6	Luminescent Materials Summary of Raw Waste Data	5-25
5-7	Wastewater Sampling Data Plant 101	5-27
5-8	Wastewater Sampling Data Plant 102	5-32
5-9	Wastewater Sampling Data Plant 103	5-33
6-1	Pollutants Comprising Total Toxic Organics	6-2
6-2	Toxic Pollutants Not Detected	6-5
7-1	Treatability of Toxic Organics Using Activated Carbon	7-11
7-2	Performance of In-Place Treatment - Cathode Ray Tube Subcategory	7-15
7-3	Summary Statistics of Plants Used for Limitation Development in the Cathode Ray Tube Subcategory	7-18
7-4	Performance of In-Place Treatment - Luminescent Materials Subcategory	7-19
9-1	Option 2 Treatment Costs - Cathode Ray Tubes	9-7

LIST OF TABLES (Continued)

<u>NUMBER</u>	<u>TITLE</u>	<u>PAGE</u>
9-2	Option 2 Treatment Costs - Luminescent Materials	9-9
9-3	Option 3 Treatment Costs - Cathode Ray Tubes	9-13
9-4	Plant Monitoring Costs for Organics	9-16

EXECUTIVE SUMMARY

CONCLUSIONS

A study of the Electrical and Electronic Components Industrial Point Source Category Phase II was undertaken to establish discharge limitations guidelines and standards. The industry was subcategorized into segments based on product type. Of the three subcategories, one has been excluded under Paragraph 8 of the NRDC Consent Decree, and for two subcategories, regulations are being promulgated. The two subcategories are Cathode Ray Tubes and Luminescent Materials. The Agency is not regulating existing direct dischargers for the reasons described in Section VI of this document. Therefore, BPT, BAT, and BCT effluent limitations are not being promulgated.

In the Cathode Ray Tube Subcategory the pollutants of concern include cadmium, chromium, lead, zinc, toxic organics, fluoride, and total suspended solids. Cadmium and Zinc are the major toxic metals found in phosphors in cathode ray tubes. Sources of these metals are manufacture, salvage, and phosphor recovery operations. Chromium occurs as dichromate in photosensitive materials and is found in wastewater from manufacture and salvage operations. Lead is found in the wastewater from the tube salvage operation where the lead frit is dissolved in nitric acid. Toxic organics occur from the use of solvents in cleaning and degreasing operations. The major source of fluoride is the use of hydrofluoric acid for cleaning and conditioning glass surfaces. Finally, total suspended solids result primarily from the use of graphite emulsions used to coat the tubes.

For the Luminescent Materials Subcategory the pollutants of concern include cadmium, antimony, zinc, fluoride, and total suspended solids. Cadmium and zinc are major constituents of blue and green phosphors, and are found in the wastewater from washing and filtering operations. Antimony is used as an activator and found in the wastewater from lamp phosphor manufacture. Fluoride results from the manufacture of an intermediate lamp phosphor, calcium fluoride. Total suspended solids occur in wastes from washing and filtration operations.

Several treatment control technologies applicable to the reduction of pollutants generated by the manufacture of cathode ray tubes and luminescent materials were evaluated, and the costs of these technologies were estimated. Pollutant concentrations achievable through the implementation of these technologies were based on industry data. These concentrations are presented below as standards for the Cathode Ray Tubes and Luminescent Materials Subcategories.

EFFLUENT LIMITATIONS AND STANDARDS

Tables 1 through 5 present regulations for New Source Performance Standards (NSPS), and Pretreatment Standards for New and Existing Sources (PSNS and PSES). All standards are expressed as milligrams per liter.

TABLE 1: PSES REGULATIONS FOR CATHODE RAY TUBES

Pollutant	Daily Maximum (mg/l)	Monthly Average (mg/l)
Cadmium	0.06	0.03
Chromium	0.65	0.30
Lead	1.12	0.41
Zinc	1.38	0.56
TTO	1.58	
Fluoride	35.0	18.0

TABLE 2: NSPS REGULATIONS FOR CATHODE RAY TUBES

Pollutant	Daily Maximum (mg/l)	Monthly Average (mg/l)	pH Range
Cadmium	0.06	0.03	
Chromium	0.56	0.26	
Lead	0.72	0.27	
Zinc	0.80	0.33	
TTO	1.58		
Fluoride	35.0	18.0	
TSS	46.0	24.0	
pH			6-9

TABLE 3: PSNS REGULATIONS FOR CATHODE RAY TUBES

Pollutant	Daily Maximum (mg/l)	Monthly Average (mg/l)
Cadmium	0.06	0.03
Chromium	0.36	0.26
Lead	0.72	0.27
Zinc	0.80	0.33
TTO	1.58	
Fluoride	35.0	18.0

TABLE 4: NSPS REGULATIONS FOR LUMINESCENT MATERIALS

Pollutant	Daily Maximum (mg/l)	Monthly Average (mg/l)	pH Range
Cadmium	0.55	0.26	
Antimony	0.10	0.04	
Zinc	1.64	0.67	
Fluoride	35.0	18.0	
TSS	60.0	31.0	
pH			6-9

TABLE 5: PSNS REGULATIONS FOR LUMINESCENT MATERIALS

Pollutant	Daily Maximum (mg/l)	Monthly Average (mg/l)
Cadmium	0.55	0.26
Antimony	0.10	0.04
Zinc	1.64	0.67
Fluoride	35.0	18.0

SECTION 1

INTRODUCTION

The purpose of this document is to present the findings of the EPA Phase 2 study of the Electrical and Electronic Components (E&EC) Point Source Category. The Phase 2 study examines the Electron Tubes and Luminescent Materials (Phosphorescent Coatings) subcategories of E&EC, the two subcategories which were previously deferred from regulatory analysis. (EPA 440/1-82/075b July 1982.)¹ The document (1) explains subcategories and pollutants are regulated and which are not; (2) discusses the reasons; and (3) explains how the actual limitations were developed. Section 1 describes the organization of the document and reviews the sources of industry data that were used to provide technical background for the limitations.

1.1 ORGANIZATION AND CONTENT OF THIS DOCUMENT

Data provided by industry are used throughout this report in support of regulating subcategories or excluding subcategories from regulation under Paragraph 8 of the NRDC Consent Decree. Telephone contacts, the literature, and plant visits provided the information used to subcategorize the industry in Section 3. These data were also considered in characterizing the industry in Section 4, Description of the Industry.

Water use and wastewater characteristics in each subcategory are described in Section 5 in terms of flow and pollutant concentration. Subcategories to be regulated or excluded are found in Section 6. The discussion in that section identifies and describes the pollutants to be regulated and presents the rationale for subcategory and pollutant exclusion. Section 7 describes the appropriate treatment and control technologies available. The regulatory limits and the bases for these limitations are presented in Section 8. Section 9 estimates the capital and operating costs for the treatment technologies used as the bases for limitations.

1.2 SOURCES OF INDUSTRY DATA

Data on the two subcategories were gathered from literature studies, contacts with EPA regional offices, from plant surveys

¹For reasons outlined in section 3.2, EPA has determined that the Electron Tube subcategory should be divided into Cathode Ray Tubes (CRT), and Receiving and Transmitting Tubes (RTT) subcategories. RTT operations do not discharge wastewaters, thus this document describes effluent limits only for CRT and Luminescent Materials subcategories.

and evaluations, and through contacting waste treatment equipment manufacturers. These data sources are discussed below.

Published literature in the form of books, reports, papers, periodicals, promotional materials, Dunn and Bradstreet surveys, and Department of Commerce Statistics was examined. The researched material included product descriptions and uses, manufacturing processes, raw materials consumed, waste treatment technology, and the general characteristics of plants in the two subcategories including number of plants, employment levels, and production levels when available.

All 10 EPA regional offices were telephoned for assistance in identifying plants in their respective regions.

Three types of data collection were used to supplement available information pertaining to facilities in the E&EC category. First, more than 150 plants were contacted by phone or letter to obtain basic information regarding products, manufacturing processes, wastewater generation, and waste treatment. Second, based on this information, eleven plants were visited to view their operations and discuss their products, manufacturing processes, water use, and wastewater treatment. Third, six plants were selected for sampling visits to determine the pollutant characteristics of their wastewater.

The sampling program at each plant consisted of up to three days of sampling. Prior to any sampling visit, all available data, such as layouts and diagrams of the selected plant's production processes and waste treatment facilities, were reviewed. In most cases, a visit to the plant was made prior to the actual sampling visit to finalize the sampling approach.

Representative sample points were then selected. Finally, before the visit was conducted, a detailed sampling plan showing the selected sample points and all pertinent sample data to be obtained was presented and reviewed.

Various manufacturers of wastewater treatment equipment were contacted by phone or were visited to obtain cost and performance data on specific technologies. Information collected was based both on manufacturers' research and on actual operation.

SECTION 2

LEGAL BACKGROUND

2.1 PURPOSE AND AUTHORITY

The Federal Water Pollution Control Act Amendments of 1972 established a comprehensive program to "restore and maintain the chemical, physical, and biological integrity of the Nation's waters," Section 101(a). Section 301(b)(1)(A) set a deadline of July 1, 1977, for existing industrial dischargers to achieve "effluent limitations requiring the application of the best practicable control technology currently available" (BPT). Section 301(b)(2)(A) set a deadline of July 1, 1983, for these dischargers to achieve "effluent limitations requiring the application of the best available technology economically achievable (BAT), which will result in reasonable further progress toward the national goal of eliminating the discharge of all pollutants."

Section 306 required that new industrial direct dischargers comply with new source performance standards (NSPS), based on best available demonstrated technology. Sections 307(b) and (c) of the Act required pretreatment standards for new and existing dischargers to publicly owned treatment works (POTW). While the requirements for direct dischargers were to be incorporated into National Pollutants Discharge Elimination System (NPDES) permits issued under Section 402, the Act made pretreatment standards enforceable directly against dischargers to POTWs (indirect dischargers).

Section 402(a)(1) of the 1972 Act does allow requirements to be set case-by-case. However, Congress intended control requirements to be based, for the most part, on regulations promulgated by the Administrator of EPA. Section 304(b) required regulations for NSPS. Sections 304(f), 307(b), and 307(c) required regulations for pretreatment standards. In addition to these regulations for designated industry categories, Section 307(a) required the Administrator to promulgate effluent standards applicable to all dischargers of toxic pollutants.

Finally, Section 501(a) authorized the Administrator to prescribe any additional regulations "necessary to carry out his functions" under the Act.

The EPA was unable to promulgate many of these regulations by the deadlines contained in the Act, and as a result, in 1976, EPA was sued by several environmental groups. In settling this lawsuit, EPA and the plaintiffs executed a "Settlement Agreement" which was approved by the Court. This agreement required EPA to develop a program and meet a schedule for controlling 65 "priority" pollutants and classes of pollutants. In carrying out

this program, EPA must promulgate BAT effluent limitations guidelines, pretreatment standards, and new source performance standards for 21 major industries. (See Natural Resources Defense Council, Inc. v. Train, 8 ERC 2120 (D.D.C. 1976), modified, 12 ERC 1833 (D.D.C. 1979)).

Several of the basic elements of the Settlement Agreement program were incorporated into the Clean Water Act of 1977. This law made several important changes in the Federal Water pollution control program. Sections 301(b)(2)(A) and 301(b)(2)(C) of the Act now set July 1, 1984, as the deadline for industries to achieve effluent limitations requiring application of BAT for "toxic" pollutants. "Toxic" pollutants here included the 65 "priority" pollutants and classes of pollutants that Congress declared "toxic" under Section 307(a) of the Act.

EPA's programs for new source performance standards and pretreatment standards are now aimed principally at controlling toxic pollutants. To strengthen the toxics control program, Section 304(e) of the Act authorizes the Administrator to prescribe "best management practices" (BMPs). These BMPs are to prevent the release of toxic and hazardous pollutants from: (1) plant site runoff, (2) spillage or leaks, (3) sludge or waste disposal, and (4) drainage from raw material storage if any of these events are associated with, or ancillary to, the manufacturing or treatment process.

In keeping with its emphasis on toxic pollutants, the Clean Water Act of 1977 also revises the control program for non-toxic pollutants. For "conventional" pollutants identified under Section 304(a)(4) (including biochemical oxygen demand, suspended solids, fecal coliform, and pH), the new Section 301(b)(2)(E) requires "effluent limitations requiring the application of the best conventional pollutant control technology" (BCT)--instead of BAT--to be achieved by July 1, 1984. The factors considered in assessing BCT for an industry include the relationship between the cost of attaining a reduction in effluents and the effluent reduction benefits attained, and a comparison of the cost and level of reduction of such pollutants by publicly owned treatment works and industrial sources. For those pollutants that are neither "toxic" pollutants nor "conventional" pollutants, Sections 301(b)(2)(A) and (b)(2)(F) require achievement of BAT effluent limitations within three years after their establishment or July 1, 1984, whichever is later, but not later than July 1, 1987.

The purpose of this regulation is to establish NSPS, PSES, and PSNS for the final two subcategories of the Electrical and Electronic Components Point Source Category.

2.2 GENERAL CRITERIA FOR EFFLUENT LIMITATIONS

2.2.1 BPT Effluent Limitations

The factors considered in defining best practicable control technology currently available (BPT) include: (1) the total cost of applying the technology relative to the effluent reductions that result, (2) the age of equipment and facilities involved, (3) the processes used, (4) engineering aspects of the control technology, (5) process changes, (6) non-water quality environmental impacts (including energy requirements), (7) and other factors as the Administrator considers appropriate. In general, the BPT level represents the average of the best existing performances of plants within the industry of various ages, sizes, processes, or other common characteristics. When existing performance is uniformly inadequate, BPT may be transferred from a different subcategory or category. BPT focuses on end-of-process treatment rather than process changes or internal controls, except when these technologies are common industry practice.

The cost/benefit inquiry for BPT is a limited balancing, committed to EPA's discretion, which does not require the Agency to quantify benefits in monetary terms. See, e.g., American Iron and Steel Institute v. EPA, 526 F.2d 1027 (3rd Cir. 1975). In balancing costs against the benefits of effluent reduction, EPA considers the volume and nature of existing discharges, the volume and nature of discharges expected after application of BPT, the general environmental effects of the pollutants, and the cost and economic impacts of the required level of pollution control. The Act does not require or permit consideration of water quality problems attributable to particular point sources or water quality improvements in particular bodies of water. Therefore, EPA has not considered these factors. See Weyerhaeuser Company v. Costle, 590 F.2d 1011 (D.C. Cir. 1978); Appalachian Power Company et al. v. U.S.E.P.A. (D.C. Cir., Feb. 8, 1972).

2.2.2 BAT Effluent Limitations

The factors considered in defining best available technology economically achievable (BAT) include the age of equipment and facilities involved, the processes used, process changes, and engineering aspects of the technology process changes, non-water quality environmental impacts (including energy requirements) and the costs of applying such technology (Section 304(b)(2)(B)). At a minimum, the BAT level represents the best economically achievable performance of plants of various ages, sizes, processes, or other shared characteristics. As with BPT, uniformly inadequate performance within a category or subcategory may require transfer of BAT from a different subcategory or category. Unlike BPT, however, BAT may include process changes or internal controls, even when these technologies are not common industry practice.

The statutory assessment of BAT "considers" costs, but does not require a balancing of costs against effluent reduction benefits

(see Weyerhaeuser v. Costle, supra). In developing the proposed BAT, however, EPA has given substantial weight to the reasonableness of costs. The Agency has considered the volume and nature of discharges, the volume and nature of discharges expected after application of BAT, the general environmental effects of the pollutants, and the costs and economic impacts of the required pollution control levels. Despite this expanded consideration of costs, the primary factor for determining BAT is the effluent reduction capability of the control technology. The Clean Water Act of 1977 establishes the achievement of BAT as the principal national means of controlling toxic water pollution from direct discharging plants.

2.2.3 BCT Effluent Limitations

The 1977 Amendments added Section 301(b)(2)(E) to the Act establishing "best conventional pollutant control technology" (BCT) for discharges of conventional pollutants from existing industrial point sources. Conventional pollutants are those defined in Section 304(a)(4) [biological oxygen demanding pollutants (BOD), total suspended solids (TSS), fecal coliform, and pH], and any additional pollutants defined by the Administrator as "conventional" oil and grease, 44 FR 44501, July 30, 1979.

BCT is not an additional limitation but replaces BAT for the control of conventional pollutants. In addition to other factors specified in Section 304(b)(4)(B), the Act requires that BCT limitations be assessed in light of a two-part "cost reasonableness" test (American Paper Institute v. EPA, 660 F.2d 954 (4th Cir. 1981)). The first test compares the costs for private industry to reduce its conventional pollutants with the costs to publicly owned treatment works for similar levels of reduction in their discharge of these pollutants. The second test examines the cost-effectiveness of additional industrial treatment beyond BPT. EPA must find that limitations are "reasonable" under both tests before establishing them as BCT. In no case may BCT be less stringent than BPT.

2.2.4 New Source Performance Standards

The basis for new source performance standards (NSPS) under Section 306 of the Act is the best available demonstrated technology. New plants have the opportunity to design the best and most efficient processes and wastewater treatment technologies. Therefore, Congress directed EPA to consider the best demonstrated process changes, in-plant controls, and end-of-process treatment technologies that reduce pollution to the maximum extent feasible.

2.2.5 Pretreatment Standards for Existing Sources

Section 307(b) of the Act requires EPA to promulgate pretreatment standards for existing sources (PSES) which industry must achieve within three years of promulgation. PSES are designed to prevent the discharge of pollutants that pass through, interfere with, or are otherwise incompatible with the operation of POTWs.

The legislative history of the 1977 Act indicates that pretreatment standards are to be technology-based, analogous to the best available technology for removal of toxic pollutants. Thus this document assesses BAT equivalent PSES. The General Pretreatment Regulations which serve as the framework for the proposed pretreatment standards are in 40 CFR Part 403, 46 FR 9404 (January 28, 1981).

EPA has generally determined that there is pass-through of pollutants if the percent of pollutants removed by a well-operated POTW achieving secondary treatment is less than the percent removal by the best available technology (BAT) model treatment system.

A study of 40 well-operated POTWs with biological treatment and meeting the secondary treatment criteria showed that the toxic metals regulated by this regulation (cadmium, chromium, antimony, lead, and zinc) are typically removed at rates varying from 20 to 70 percent. POTWs with only primary treatment have even lower rates of removal. In contrast to POTWs, BAT level treatment by sources in this industrial category can remove these metals at rates of approximately 96 percent or more. Accordingly, these metals "pass-through" POTWs.

The same POTW study indicates that one-fourth of well-operated POTWs with secondary treatment achieved removals of less than 40 percent for chloroform, less than 85 percent for 1,1,1-trichloroethane, less than 29 percent for methylene chloride, less than 34 percent for bis(2-ethylhexyl) pthalate, less than 88 percent for toluene, and less than 87 percent for trichloroethylene. By comparison, sound solvent management practices achieve a TTO reduction of greater than 99 percent. Accordingly, pass-through of toxic organic pollutants does occur.

There is no significant removal of fluoride by typical POTW treatment systems, while BAT level treatment consisting of precipitation/clarification has been shown to remove as much as 95 percent from these waste streams. Thus, pass-through of fluoride does occur.

2.2.6 Pretreatment Standards for New Sources

Section 307(c) of the Act requires EPA to promulgate pretreatment standards for new sources (PSNS) at the same time that it promulgates NSPS. These standards are intended to prevent the discharge of pollutants which pass through, interfere with, or are otherwise incompatible with a POTW. New indirect

dischargers, like new direct dischargers, have the opportunity to incorporate the best available demonstrated technologies--including process changes, in-plant controls, and end-of-process treatment technologies--and to select plant sites that ensure the treatment system will be adequately installed. Therefore, the Agency sets PSNS after considering the same criteria considered for NSPS.

SECTION 3

INDUSTRY SUBCATEGORIZATION

3.1 RATIONALE FOR SUBCATEGORIZATION

The primary purpose of industrial categorization is to provide groupings within an industry so that each group has a uniform set of discharge limitations. After the Agency has obtained wastewater data and process information from facilities within an industry or industrial segment, a number of factors are considered to determine if subcategorization is appropriate. These factors include raw materials, final products, manufacturing processes, geographical location, plant size and age, wastewater characteristics, non-water quality environmental impacts, treatment costs, energy costs, and solid waste generation.

3.2 SUBCATEGORIZATION REVIEW

A preliminary review of each of these factors revealed that product type is the principal factor affecting the wastewater characteristics in the Electrical and Electronic Components industrial category. This is demonstrated by a comparison of pollutants found in plant effluent with the products made at those plants. Luminescent Materials (Phosphorescent Coatings) and Electron Tubes were identified as two of the twenty-one (21) subcategories comprising the E&EC category.

Under this study, further review of the same factors revealed that the Electron Tube Subcategory was comprised of two distinct product types employing different raw materials and manufacturing processes. The products included in the Electron Tube Subcategory are (1) cathode ray tubes, and (2) receiving tubes and transmitting tubes. The production of receiving and transmitting tubes uses similar raw materials and manufacturing processes. Cathode ray tube manufacture, however, employs unique raw materials and process operations which generate wastes greatly different from those encountered in the manufacture of receiving and transmitting tubes.

3.3 CONCLUSIONS

Based on the review of subcategorization factors, the following subcategories were established under this study and are addressed as such in this document.

Cathode Ray Tubes

Receiving and Transmitting Tubes (dry process)

Luminescent Materials

SECTION 4

DESCRIPTION OF THE INDUSTRY

This section provides a general description of the subcategories presented in the previous section. It includes a discussion of the number of plants and production capacity, product lines, and manufacturing processes including raw materials used.

4.1 CATHODE RAY TUBES

The Cathode Ray Tube Subcategory includes plants which discharge wastewater from the production of electronic devices in which high velocity electrons are focused through a vacuum to generate an image on a luminescent (or phosphorescent) surface. Products are classified under the Standard Industrial Classification (SIC) 3671. The Cathode Ray Tube (CRT) Subcategory's products are comprised of two CRT types:

- o Aperture Mask Tubes which are cathode ray tubes that contain multiple color phosphors and use an aperture (shadow) mask. This type of tube will be referred to as a color television picture tube.
- o Cathode ray tubes that contain a single phosphor and no aperture mask. This type of tube will be referred to as a single phosphor tube.

4.1.1 Number of Plants and Production Capacity

Results of an extensive telephone survey to companies classified under SIC Code 3671 indicated that an estimated 24 plants are involved in the manufacturing of cathode ray tubes.

Seven plants produce color television picture tubes with a total production of approximately 12.5 million tubes per year and an average plant production of 1.78 million tubes per year. It is estimated that 12,000 production employees are engaged in color television picture tube manufacturing. Only one of the seven manufacturers is a direct discharger. In addition, several rebuilders of color television picture tubes exist, but because there is no phosphor removal or reapplication, the rebuilding process is of little concern under this study.

Fifteen plants manufacture single phosphor tubes with an estimated 3,000 employees engaged in production. No single phosphor tube manufacturers are known to be direct dischargers.

4.1.2 Product Description

Cathode ray tubes are devices in which electrons are conducted between electrodes through a vacuum within a gas tight glass

envelope. Cathode ray tubes depend upon three basic phenomena for their operation. The first is the emission of electrons by certain elements and compounds when the energy of the surface atoms is raised. The second phenomenon is the control of the movement of these electrons by the force exerted upon them by electrostatic and electrodynamic forces. The third is the luminescent properties of the phosphors when excited by electrons. The two types of cathode ray tubes which are to be discussed in this section are described below:

- o Color television picture tubes function by the horizontal scanning of high velocity electrons striking a luminescent surface. The number of electrons in the stream at any instant of time is varied by electrical impulses corresponding to the transmitted signal. A typical color television picture tube is shown in Figure 4-1.

The tube is a large glass envelope. A special composition of glass is used to minimize optical defects and to provide electrical insulation for high voltages. The structural design of the glass bulb is made to withstand 3 to 6 times the force of atmospheric pressure. The light-emitting screen is made up of small elemental areas, each capable of emitting light in one of the three primary colors (red, green, blue). An electron gun for each color produces a stream of high velocity electrons which is aimed and focused by static and dynamic convergence mechanisms and an electro-magnetic deflection yoke. An aperture mask behind the face of the screen allows phosphor excitation according to incident beam direction. Commercially available color television tubes are manufactured in a number of sizes. These tubes are used in color television sets, arcade games, and computer display terminals.

- o Single phosphor tubes are similar to color television picture tubes in most respects. They generate images by focusing electrons onto a luminescent screen in a pattern controlled by the electrostatic and electrodynamic forces applied to the tube. The major difference is that the light emitting screen is composed of a single phosphor, and a single beam electron gun is used for phosphor excitation. In addition, the tube does not contain an aperture mask for electron beam control.

Single phosphor tubes are manufactured in a variety of sizes but are generally smaller in size than color television picture tubes. They usually range from 2 to 12 inches in diameter. Single phosphor tubes are manufactured for usage in display systems such as word

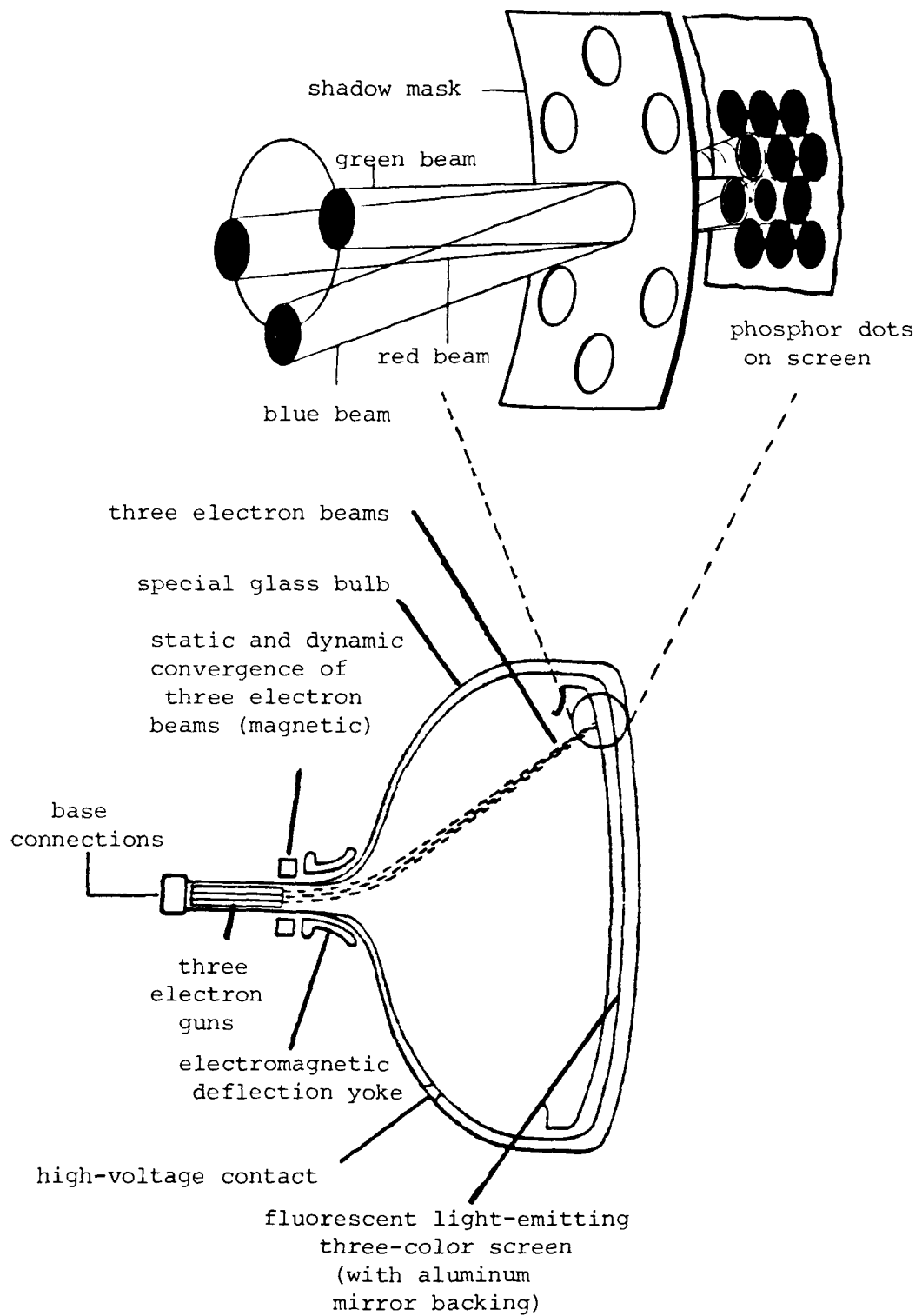

FIGURE 4-1
 COLOR TELEVISION PICTURE TUBE

processors, computer systems, arcade video games, specialized military units, medical and other electronic testing and monitoring equipment such as oscilloscopes.

4.1.3 Manufacturing Processes and Materials

The manufacturing processes and materials used for cathode ray tube production are described in the following paragraphs. Each type of cathode ray tube with its associated manufacturing operations is discussed separately because production processes differ.

Color Television Picture Tubes -- The manufacture of a color television picture tube is a highly complex, often automated process as depicted in Figure 4-2. The tubes are composed of four major components: the glass panel, steel aperture mask, glass funnel, and the electron gun mount assembly. The glass panel is the front of the picture tube through which the picture is viewed. The steel aperture (shadow) mask is used to selectively shadow the phosphor from the electron beam as the beam horizontally scans the phosphor-coated glass panel. The glass funnel is the casing which extends back from the glass panel and is the largest component of the picture tube. The mount assembly is attached to the funnel and contains the electron gun and the electrical base connections.

Manufacture of a color television picture tube begins with an aperture mask degrease. The aperture masks, often produced at other facilities, are received by the color television picture tube manufacturer, formed to size, degreased, and oxidized. Common degreasing agents used are methylene chloride, trichloroethylene, methanol, acetone, isopropanol, and alkaline cleaning. The aperture masks are inserted within the glass panel which is commonly then referred to as a panel-mask "mate". The panel-mask mate is annealed and the mask is removed.

The glass panels proceed to panel wash. Panel wash includes several hydrofluoric-sulfuric acid glass washes and subsequent water rinses. The panels are then sent to photoresist application. The photoresist commonly contains dichromate, an alcohol, and other materials considered proprietary. The glass panels are coated with a photoresist and the masks are mated to the panel. The panel is then exposed to light through the mask. The mask is removed and the panel is developed, graphite-coated, re-developed and cleaned with a hydrofluoric-sulfuric acid solution. The panel at this point has a multitude of clear dots onto which the phosphors will be deposited. Presently, several manufacturers are using vertical lines as an alternative to dots. The panels then proceed to phosphor application.

Many proprietary processes have been observed in applying the phosphors. Generally, the panels first undergo another

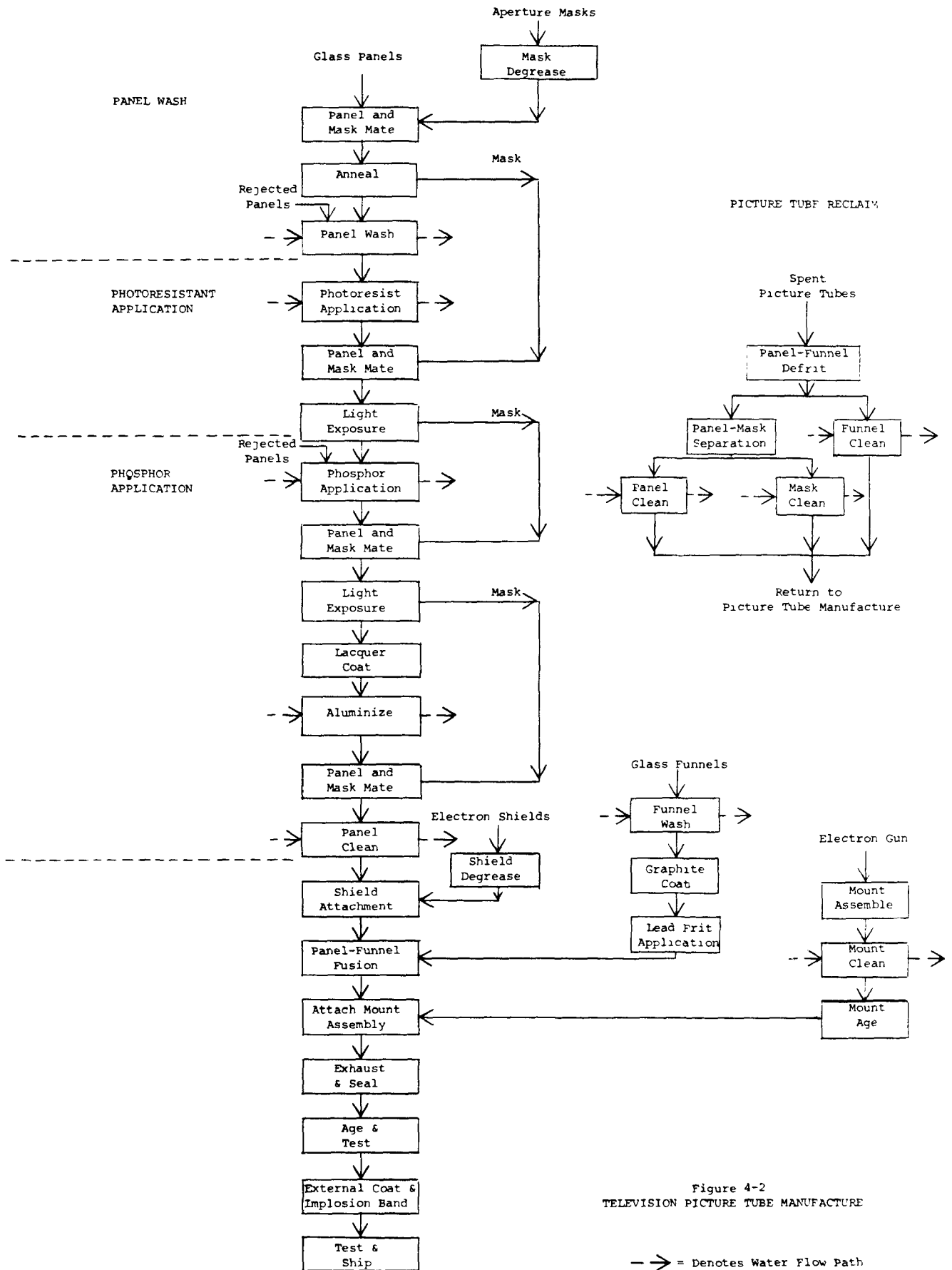

Figure 4-2
TELEVISION PICTURE TUBE MANUFACTURE

photoresist application. Each of the three color phosphors is then applied similarly. The phosphor is applied to the panel as a slurry or as a powder, the mask is attached, the phosphor is exposed to light through the mask, the mask is removed and the unexposed phosphor is washed away. After application of the three phosphors, toluene-based lacquer and silicate coatings may be applied to seal the phosphors, aluminum is vacuum-deposited to enhance reflection, the mask is mated with the panel, and the panel is cleaned.

Glass funnels are cleaned and coated with graphite to prevent reflection within the tube. Electron shields are degreased and attached to the panel. Panel-mask assemblies and glass funnels are then joined together using a heat-fused lead frit, followed by annealing. The electron gun mount is cleaned, aged, and heat sealed to the base of the funnel. At this stage the assembled panel, funnel, and mount are termed a "bulb." The bulb is exhausted, sealed, and aged by applying current to the cathode. The tube is tested, an external graphite coating is applied, and an implosion band is secured to the tube. The tube is retested before shipment to facilities that assemble television sets.

Panels may be rejected upon inspection at many points along the manufacturing process. If rejected, panels may be sent back to the panel wash at the beginning of the manufacturing sequence.

In addition, there is a picture tube salvage operation to reclaim spent or rejected picture tubes. Salvage operation processes include a panel-funnel acid defrit, acid cleaning of panels and funnels, and cleaning of aperture masks. These reclaimed components are returned to the process for reuse. Electron guns are usually discarded.

Wastewater producing operations for manufacture of television picture tubes are unique and sizeable. Process wastewater sources include both bath dumps and subsequent rinsing associated with: glass panel wash, aperture mask degrease, photoresist application, phosphor application, glass funnel and mount cleaning, and tube salvage.

Single Phosphor Tubes -- Single phosphor tubes have several manufacturing processes that differ from color television picture tube manufacturing (Figure 4-3). The tube is usually composed of a single glass bulb; only a small percentage of the tubes manufactured have a separate panel and funnel connected by a heat fused lead frit.

The one piece tube manufacturing requires no mask and no photoresist application. The single phosphor is contained within an aqueous settling solution that is poured into the glass bulb and allowed to settle onto the face of the bulb. After a sufficient time the remaining settling solution is decanted off and a toluene-based lacquer is applied to seal the phosphor.

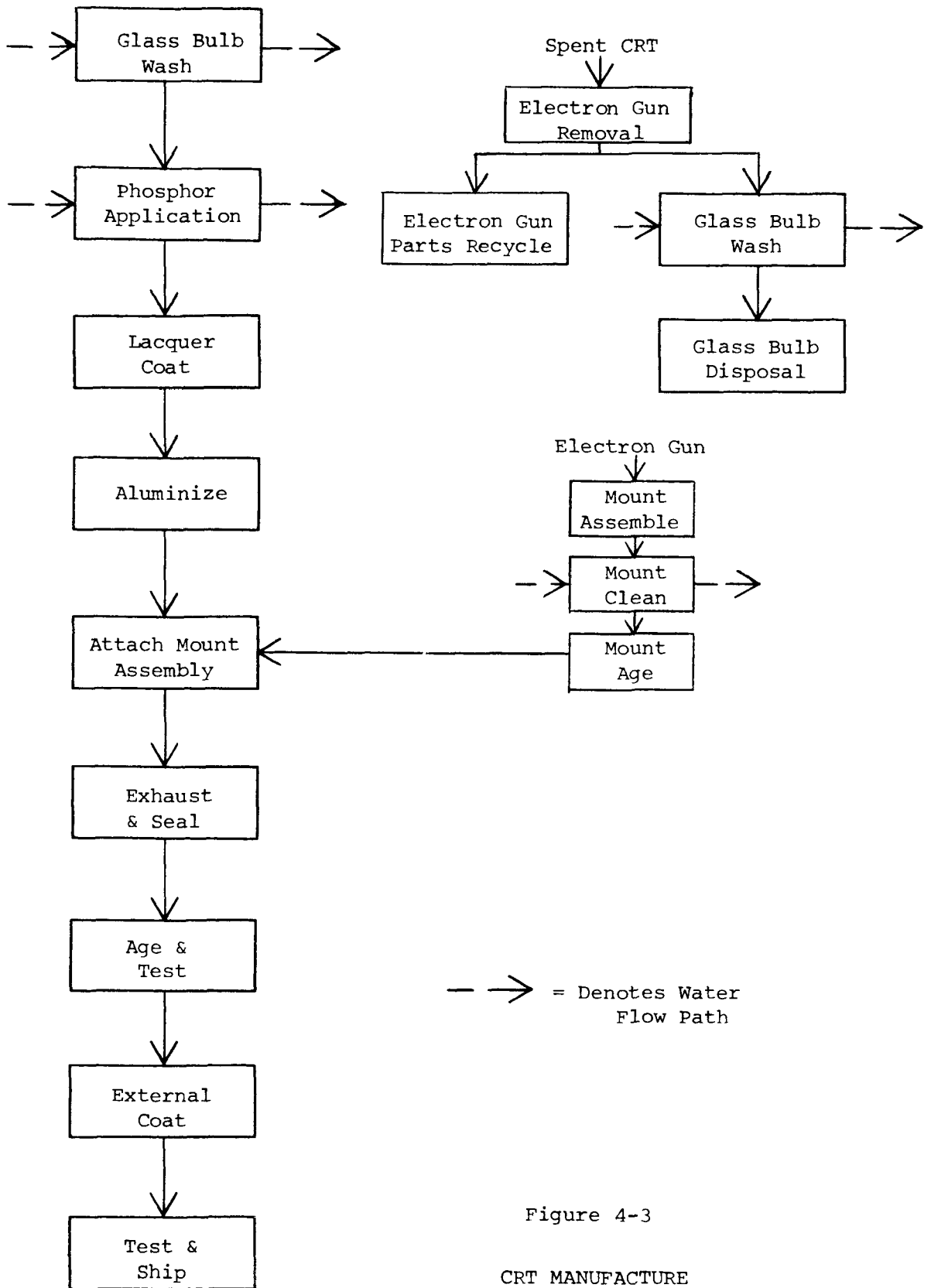

Figure 4-3
CRT MANUFACTURE

In some cases where the bulb face needs a special application, such as reference lines for an oscilloscope, a separate panel and funnel are used. A photoresist and mask are used for applying the reference lines on the panel and then the single phosphor is applied in the same method as a one piece bulb using a settling solution that contains potassium silicate and usually an electrolyte.

In addition, there may or may not be a cathode ray tube salvage operation. The tube salvage is usually comprised of the removal of the electron gun by cutting the tube at the gun mount and recycling parts of the gun. The remaining glass tube is then discarded. At some facilities the tube is washed to remove the phosphor before disposal.

The decant from the settling solution and the wash from phosphor removal are usually the main sources of wastewater in single phosphor tube manufacturing.

4.2 RECEIVING AND TRANSMITTING TUBES

The Receiving and Transmitting Tube Subcategory includes electronic devices in which conduction of electrons takes place through a vacuum or a gaseous medium within a sealed glass, quartz, metal or ceramic casing. Products are classified under the Standard Industrial Classifications (SIC) 3671, 3673.

4.2.1 Number of Plants and Production Capacity

Results of an extensive telephone survey to companies classified under the above SIC Codes indicated that an estimated 23 major plants are involved in the manufacturing of receiving and transmitting tubes with an estimated 10,000 employees engaged in production. Several small receiving and transmitting tube manufacturers probably exist.

4.2.2 Product Description

Receiving and transmitting tubes conduct electrons or ions between electrodes through a vacuum or ionized gas such as neon, argon or krypton, which is within a gas-tight casing of glass, quartz, ceramic, or metal. Their operation is based on the emission of electrons by certain elements and compounds when the energy of the surface atoms is raised by the addition of heat, light photons, kinetic energy of bombarding particles, or potential energy. The operation also depends on the control of the movement of these electrons by the force exerted upon them by electric and magnetic fields.

- o Receiving tubes are multiterminal devices that conduct electricity more easily in one direction than in the other and are noted for their low voltage and low power applications (Figure 4-4). They are used to control or

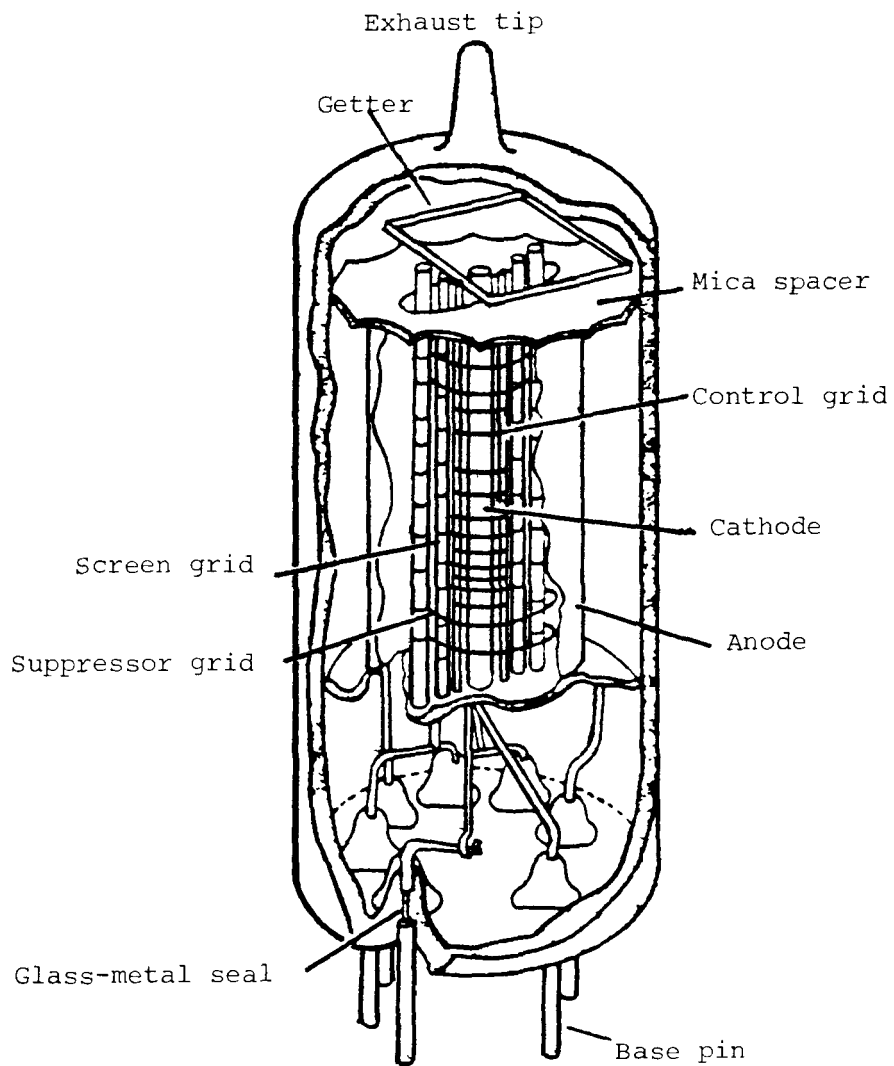

FIGURE 4-4
RECEIVING TUBE

amplify electrical signals in radio and television receivers, computers, and sensitive control and measuring equipment.

Structurally, electron tubes are classified according to the number of electrodes they contain. The electrodes are usually made of nickel mounted on a base penetrated by electrical connections and are encapsulated in a glass or metal envelope which is normally evacuated.

Voltage is impressed on the tube normally between the plate (anode) and the cathode. Because large plate currents are not required for electron emission, oxide-coated cathodes are used extensively. A separate filament heats the cathode which usually consists of a nickel sleeve coated with oxides such as strontium oxide or barium oxide. There is no electrical connection between the cathode and filament causing the cathode to be heated indirectly.

- o Transmitting type electron tubes are characterized by the use of electrostatic and electromagnetic fields applied externally to a stream of electrons to amplify a radio frequency signal. There are several different types of transmitting tubes such as klystrons, magnetrons and traveling wave tubes. They generally are high powered devices operating over a wide frequency range. They are larger and structurally more rugged than receiving tubes, and are completely evacuated. Figure 4-5 is a diagram of a klystron tube, which is typical of a transmitting type tube. In a klystron tube, a stream of electrons from a concave thermionic cathode is focused into a small cylindrical beam by the converging electrostatic fields between the anode, cathode, and focusing electrode. The beam passes through a hole in the anode and enters a magnetic field parallel to the beam axis. The magnetic field holds the beam together, overcoming the electro-static repulsion between electrons. The electron beam goes through the cavities of the klystron, emerges from the magnetic field, spreads out and is stopped in a hollow collector where the remaining kinetic energy of the electrons is dissipated as heat.

4.2.3 Manufacturing Processes and Materials

The manufacture of a receiving tube is similar to that of a transmitting tube and is depicted schematically in Figure 4-6. Raw materials required for receiving tube manufacture include glass envelopes, kovar and other specialty metals, tungsten wire, and copper wire. The metal parts are punched and formed,

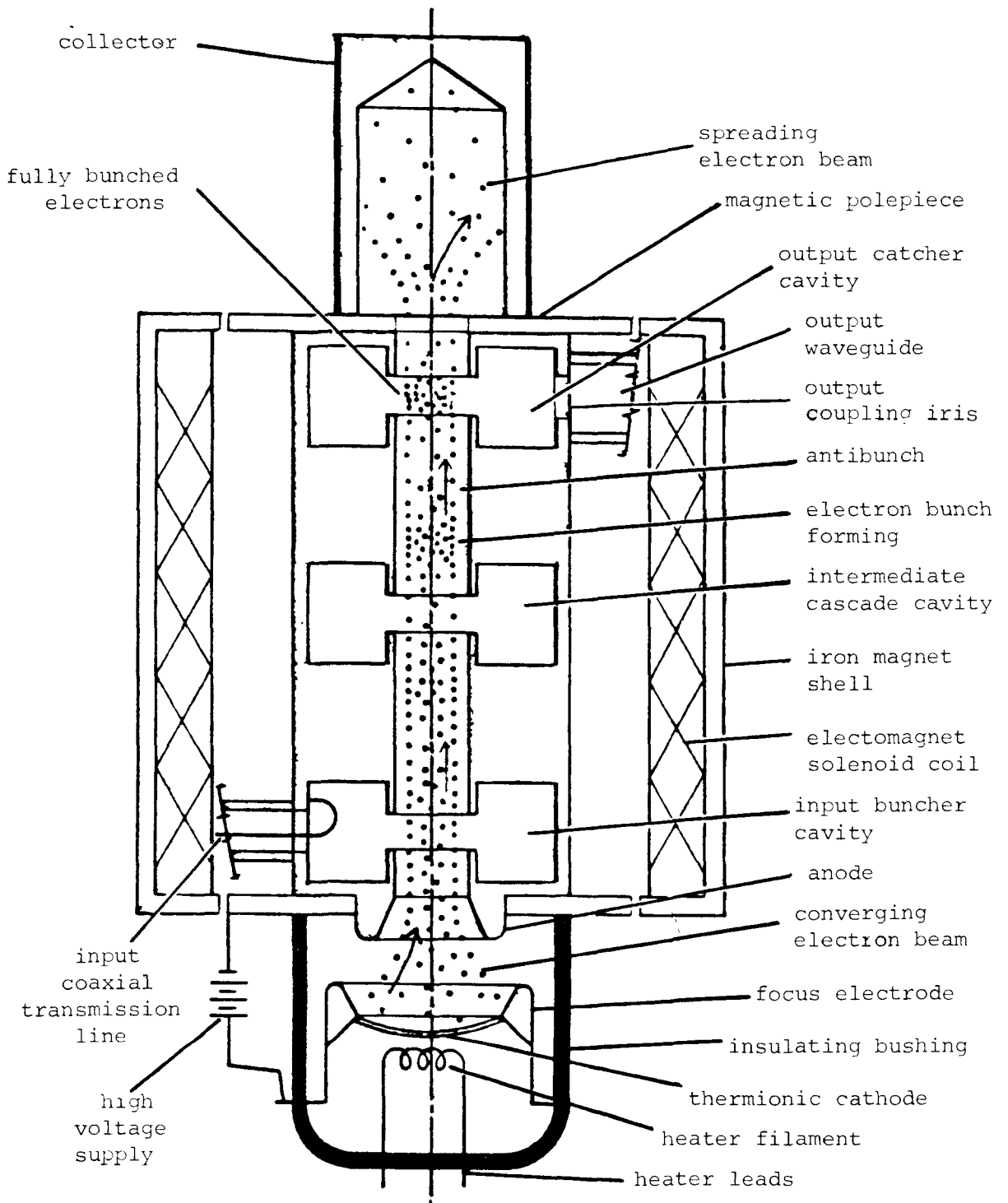

FIGURE 4-5

TRANSMITTING TUBE

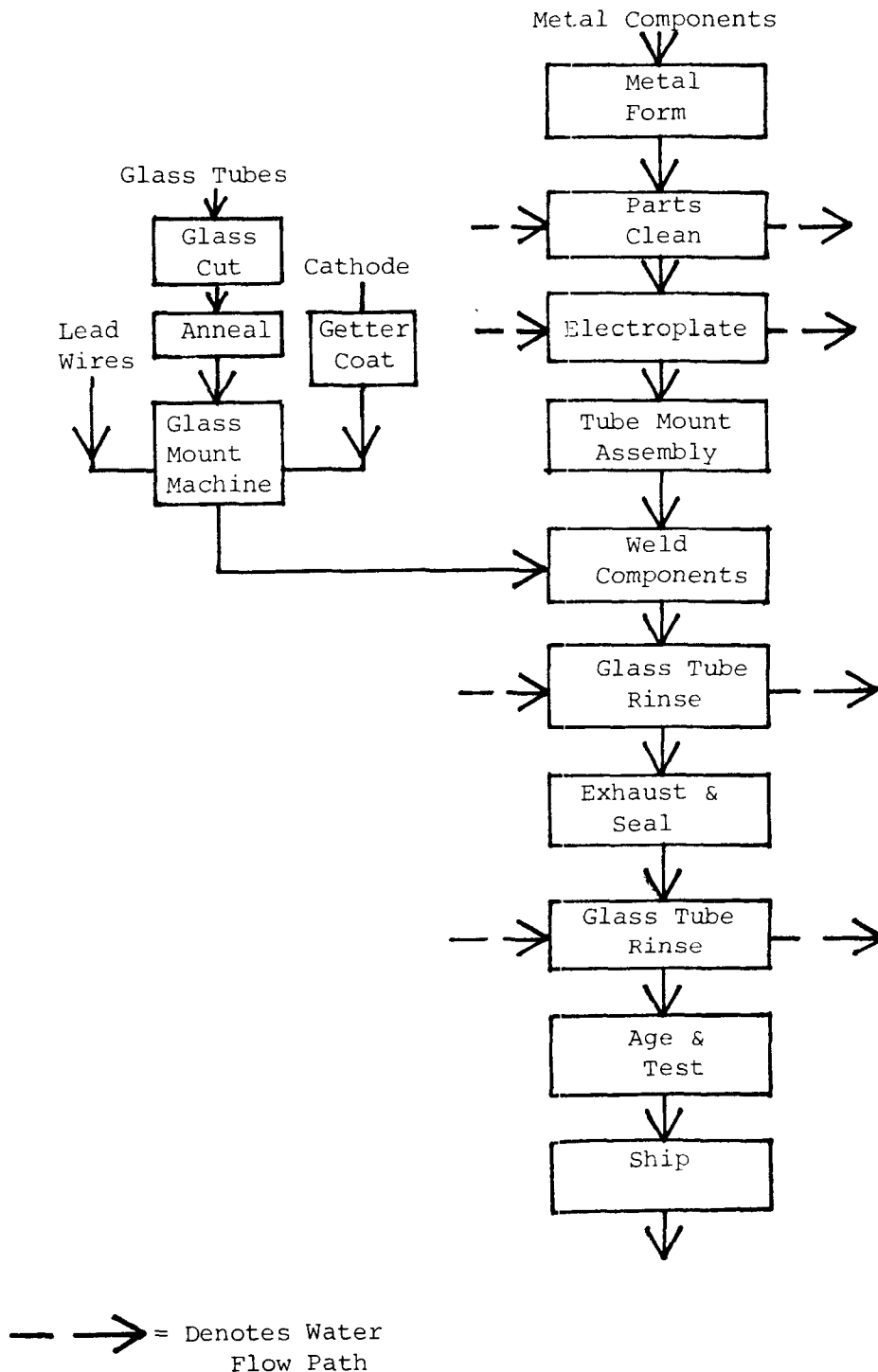

FIGURE 4-6

RECEIVING TUBE MANUFACTURE

chemically cleaned, and electroplated with copper, nickel, chromium, gold, or silver. The iron or nickel cathode is coated with a getter solution which will be used to absorb gases. The metal parts are hand assembled into a tube mount assembly. Glass parts for the tube base are cut and heat treated. Copper connector pins are sealed in the "glass mount" machine. The glass mount piece is then heat treated by baking in an oven. The metal tube mount assembly is then hand welded to the glass mount piece. The upper glass bulb is rinsed. On a "sealex" machine, the bulb is evacuated to 10^{-3} mm of mercury, sealed, and the glass extensions are cut off. A getter material (usually magnesium, calcium, sodium, or phosphorus) previously introduced in the evacuated envelope is flashed. Flashing occurs by applying an electric current to the electrodes of the tube for several seconds or by indirect infrared radiation. The getter material condenses on the inside surface and absorbs (reacts with) any gas molecules. The result is that the vacuum within the tube becomes progressively stronger until an equilibrium value of 10^{-6} mm is reached. The glass exterior is rinsed and the completed tube is aged, tested, and packaged.

The manufacture of a typical transmitting tube is presented schematically in Figure 4-7. Intricately shaped and machined copper, steel, and ceramic parts are cleaned and rinsed. Some of these parts are then electroplated using materials such as copper, gold, and silver. Assembly of the electron tube is generally a manual operation. The electron tube components consist of the above-described parts, a tungsten filament, a glass window, and a glass tube. The components undergo a number of soldering, brazing, welding, heat treating, and polishing operations. A significant energy user is the heat treating area with associated non-contact cooling water. The assembled electron tube undergoes an extensive series of electrical and mechanical testing procedures and an aging process before final shipment. There are specialized types of transmitting type electron tubes, such as image intensifiers, that are produced in a manner similar to that described above. However, there are two wet processes utilized in addition to those depicted in Figure 4-7. These additional wet processes include alkaline cleaning/rinsing and alcohol dipping/rinsing of ceramic or glass envelopes brazed to metal; and acid cleaning of glass tube bodies. Because these processes are known to exist at only one facility, they are not included in Figure 4-7 as processes common to most transmitting type electron tube manufacture.

Process water is used in solutions and rinses associated with electroplating of anodes, cathodes, and grids. Water is also used to wash glass and ceramic tube bodies both before and after seating to the base, or at the conclusion of the manufacturing process.

Receiving and transmitting electron tube manufacturing processes produce wastewater discharges primarily through metal finishing

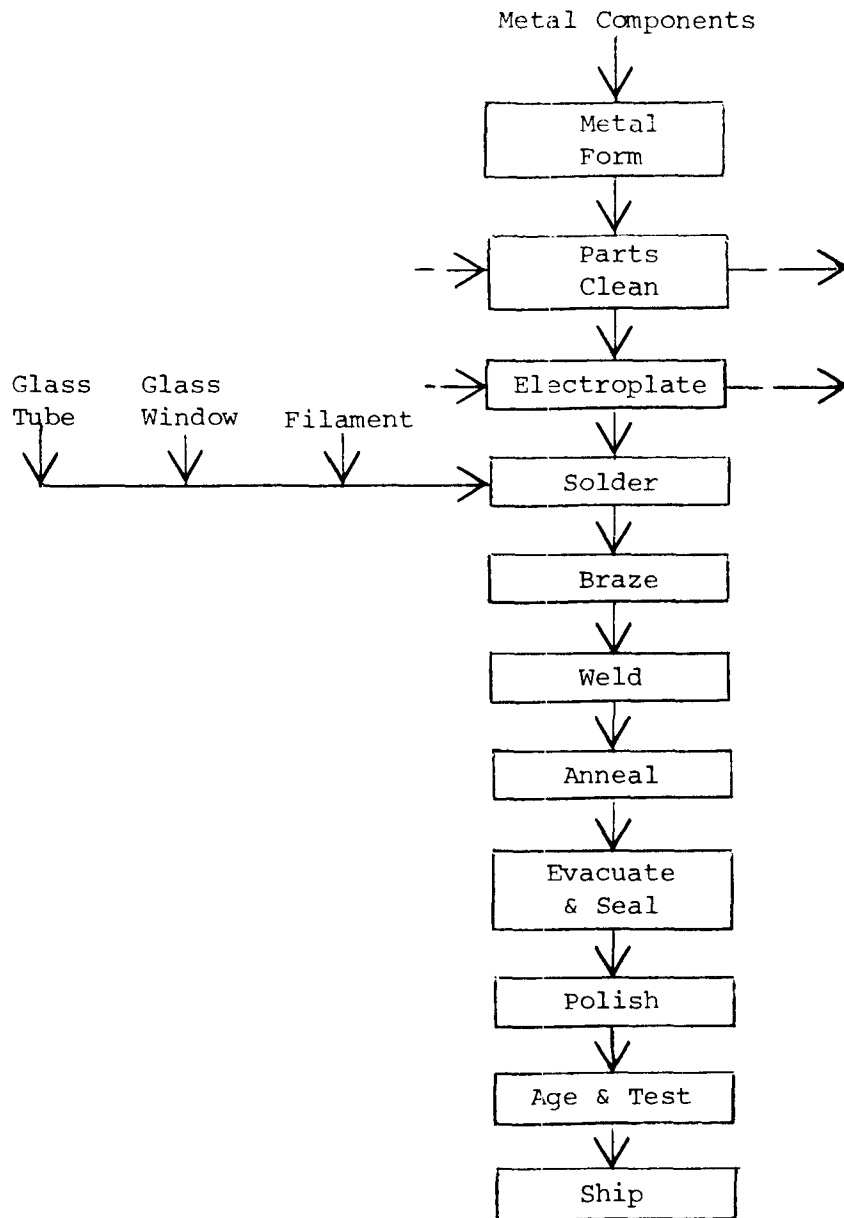

— → = Denotes Water Flow Path

Figure 4-7

TRANSMITTING TUBE MANUFACTURE

operations which are covered under the Metal Finishing Category. A number of ancillary operations such as deionized water backwash, cooling tower blowdown, and boiler blowdown contribute sizeable wastewater discharges compared to metal finishing operations.

In addition, there are some isolated instances of plants manufacturing specialized transmitting type electron tubes such as image intensifiers and photomultipliers that require process water. Alkaline cleaning and acid etching of glass-metal and ceramic tube components discharge process wastewater as a result of alkaline and acid bath dumps and their associated water rinses. These wet processes are similar to several found in color television picture tube manufacture. There is also a glass tube rinse (or rinses) which concludes the manufacture of receiving tubes. Such rinses are intended to remove surface particulates and dust deposited on the tube body during the manufacturing process.

4.3 LUMINESCENT MATERIALS

Luminescent materials (phosphors) are those that emit electromagnetic radiation (light) upon excitation by such energy sources as photons, electrons, applied voltage, chemical reactions, or mechanical energy. These luminescent materials are used for a variety of applications, including fluorescent lamps, high-pressure mercury vapor lamps, color television picture tubes and single phosphor tubes, lasers, instrument panels, postage stamps, laundry whiteners, and specialty paints.

This study is restricted to those materials which are applicable to the E&EC category, specifically to those used as coatings in fluorescent lamps and color television picture tubes and single phosphor tubes.

4.3.1 Number of Plants

A telephone survey of the industry determined that only five facilities manufacture luminescent materials, and according to industry personnel, two of these facilities are the major producers.

Of the five luminescent materials manufacturers, one manufactures TV phosphors only; three manufacture both lamp and TV phosphors; and one manufacture only lamp phosphors. At three facilities wastewater flow from the phosphor operations amount to less than twenty percent of the total plant flow. Of the five facilities, one has no discharge, two discharge to a POTW and the remaining two discharge to surface water.

4.3.2 Product Description

The most important fluorescent lamp phosphor is calcium halophosphate. There are at least 50 types of phosphors used for cathode ray tubes (television and other video displays). However, all are similar to or mixes of the three major color television powders: red, blue, and green. The red phosphor is yttrium oxide activated with europium; the blue phosphor is zinc sulfide activated with silver, and the green phosphor is zinc-cadmium sulfide activated with copper. The major process steps in producing luminescent materials are reacting, milling, and firing the raw material; recrystallizing raw materials, if necessary; and washing, filtering, and drying and intermediate and final products. The products are then sold and shipped as powders.

4.3.3 Manufacturing Processes and Materials

Lamp phosphors and TV phosphors with their associated manufacturing operations are discussed separately because production processes and raw materials differ. The processes and materials described were taken from a typical plant; however, some variations occur between manufacturers. Proprietary compounds used in process operations are not identified.

Lamp Phosphors -- Preparation of calcium halophosphate, $\text{Ca}_5(\text{F},\text{Cl})(\text{PO}_4)_3$ involves the production of two intermediate powders and the firing of the combined intermediate powders (Figure 4-8).

Calcium phosphate intermediate powder is produced by reacting calcium salts with anions. These raw materials are first purified and filter pressed separately. The two streams are then combined to precipitate the soluble calcium. This resultant material, $\text{CaCO}_3 \cdot \text{CaH}_2\text{P}_4$, is subsequently filtered and recrystallized in heated deionized water for particle size assurance. The material is then filtered and dried. Liquid waste originates from washing, filtration (precipitation), wet scrubber blowdown, and filtration of the recrystallized process stream.

Calcium fluoride (CaF_2) intermediate powder is produced by reacting calcium hydroxide with nitric acid to make calcium nitrate solution. This is mixed with ammonium bifluoride crystals dissolved in water, to precipitate calcium fluoride. Calcium fluoride is washed by decantation, filtered and dried. Liquid wastes originate from washing, filtering and scrubber blowdown.

The intermediate powders are milled together, blended, fired, washed, filtered and dried to produce calcium halophosphate phosphor.

TV Phosphors -- There are three primary TV phosphors currently being manufactured: red, blue and green. The manufacturing of

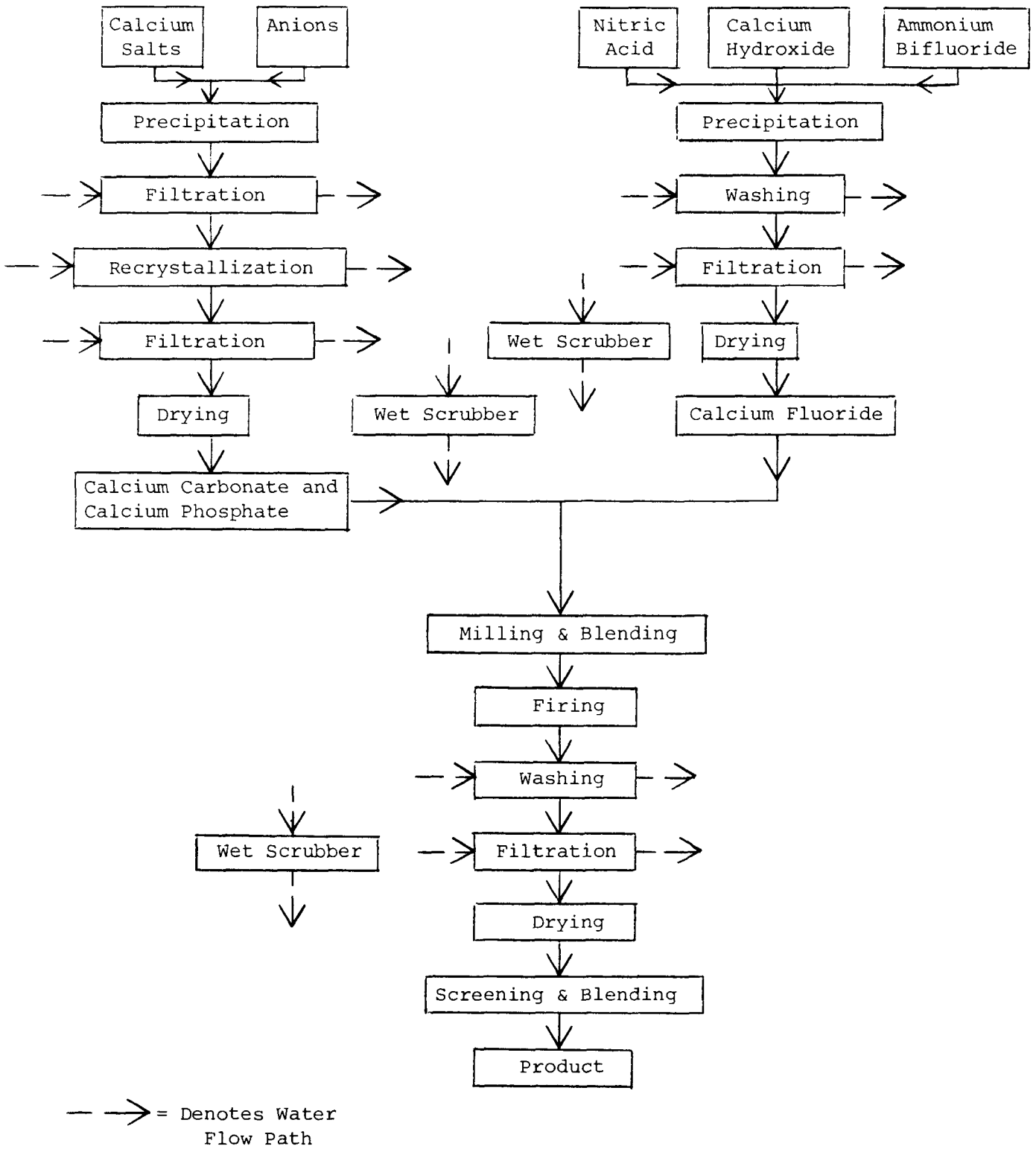

FIGURE 4-8

LAMP PHOSPHOR PROCESS

both blue and green phosphors requires a two-stage process that involves the production of an intermediate material and then its activation and firing. The manufacturing of red phosphor is a solid state reaction.

Figure 4-9 is a process flow diagram for the production of blue phosphor, which is primarily a zinc sulfide phosphor activated with silver (ZnS:Ag). The intermediate material is produced by dissolving zinc oxide in sulfuric acid. The zinc sulfate solution is reacted with hydrogen sulfide gas to precipitate zinc sulfide out of solution. The product is washed, vacuum filtered and dried. The intermediate powder is blended with the activator (usually silver), fired, washed, filtered and dried. Liquid wastes originate from precipitation, washing, filtration, and scrubber blowdown.

The green phosphor is produced from zinc-cadmium sulfide that is activated with copper (Zn(Cd)S:Cu). The intermediate material is produced by dissolving cadmium oxide in sulfuric acid and deionized water to produce a cadmium sulfate solution. Sulfide gas and zinc sulfide that was produced in the same method as described in the blue phosphor, are introduced to the solution. The precipitate is washed several times and then dried to produce the cadmium-zinc sulfide intermediate powder. The intermediate powder is mixed with the activator copper, and fired. The material is washed, vacuum filtered, and dried to produce the final product zinc-cadmium phosphor. Liquid wastes originate from precipitation, washing, filtration, and scrubber blowdown.

The red phosphor is a rare earth phosphor manufactured from yttrium oxide that is activated with europium ($Y_2O_3:Eu(III)$). The production is a solid state reaction in which yttrium oxide, europium oxide and certain salts are blended, fired, washed, and dried to produce the final red phosphor. Liquid waste originates from washing and scrubber blowdown.

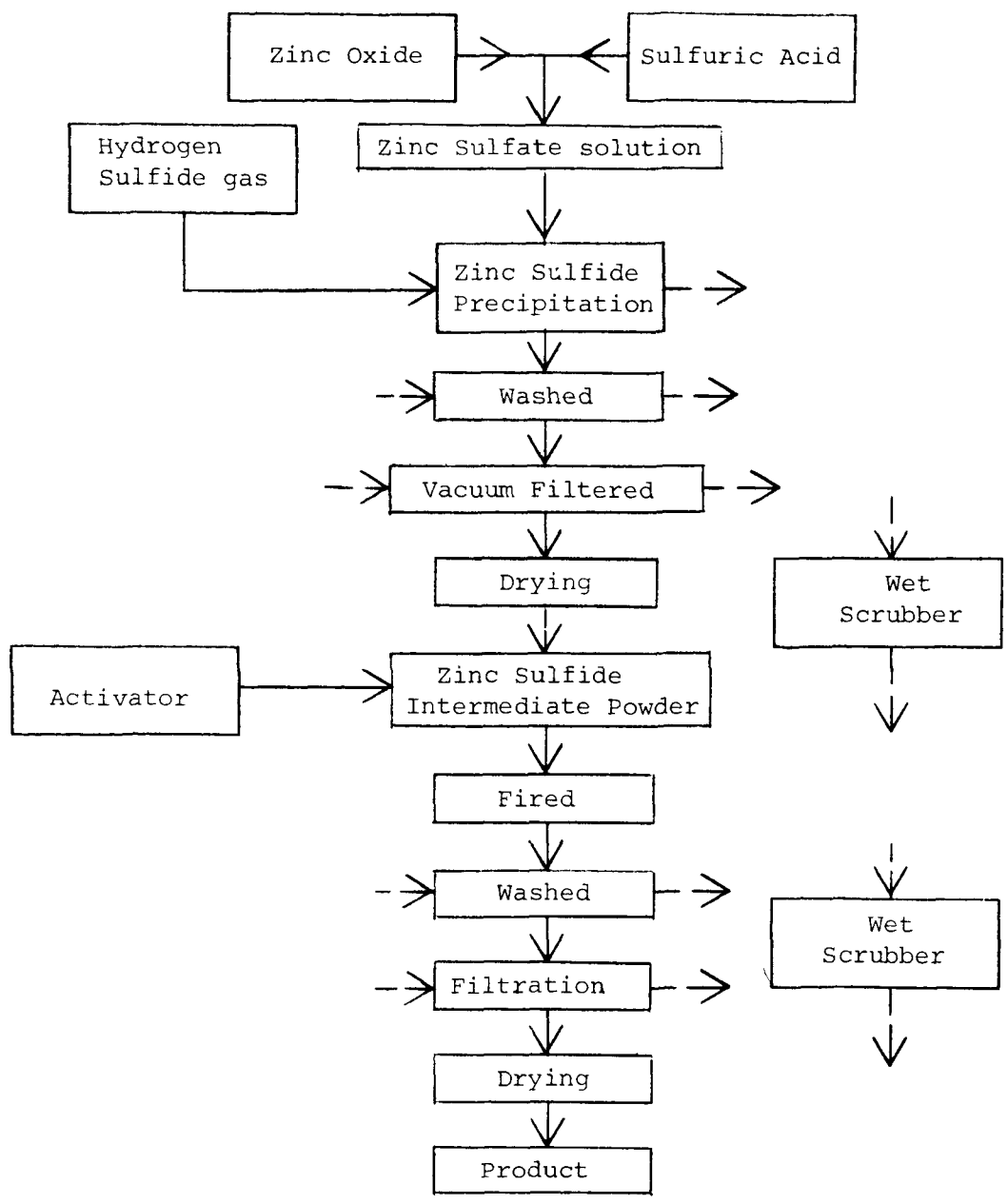

- -> = Denotes Water Flow Path.

FIGURE 4-9

BLUE PHOSPHOR PROCESS

SECTION 5

WASTEWATER CHARACTERISTICS

This section presents information related to wastewater flows, wastewater sources, pollutants found, and the sources of these pollutants for Cathode Ray Tube, Receiving and Transmitting Tube, and Luminescent Materials Subcategories. A general discussion of sampling techniques and wastewater analysis is also provided.

5.1 SAMPLING AND ANALYTICAL PROGRAM

Fifty-two plants were contacted to obtain information on the three subcategories. Thirteen of these plants were visited for an on-site study of their manufacturing processes, water used and wastewater treatment. In addition, wastewater samples were collected at six of the plants visited in order to quantify the level of pollutants in raw process wastewater and treatment effluent.

5.1.1 Pollutants Analyzed

The chemical pollutants sought in analytical procedures fall into three groups: conventional, non-conventional, and toxics. The latter group comprises the 129 chemicals found in the toxic pollutant list shown in Table 5-1.

Conventional pollutants are those generally treatable by secondary municipal wastewater treatment. The conventional pollutants examined for this study are:

- pH
- Biochemical Oxygen Demand (BOD)
- Oil and Grease (O&G)
- Total Suspended Solids (TSS)

Non-conventional pollutants are simply those which are neither conventional nor on the list of toxic pollutants. The non-conventional pollutants listed below were examined during this study.

Fluoride	Manganese
Total Organic Carbon	Vanadium
Total Phenols	Boron
Yttrium	Barium
Calcium	Molybdenum
Magnesium	Tin
Aluminum	Cobalt
Sodium	Iron
Titanium	Platinum
Palladium	Gold
Tellurium	.

TABLE 5-1
TOXIC POLLUTANTS

TOXIC POLLUTANT ORGANICS

1. Acenaphthene	47. Bromoform (Tribromomethane)
2. Acrolein	48. Dichlorobromoethane
3. Acrylonitrile	
4. Benzene	
5. Benzidine	51. Chlorodibromomethane
6. Carbon Tetrachloride (Tetrachloromethane)	52. Hexachlorobutadiene
7. Chlorobenzene	53. Hexachlorocyclopentadiene
8. 1,2,4-Trichlorobenzene	54. Isophorone
9. Hexachlorobenzene	55. Naphthalene
10. 1,2-Dichloroethane	56. Nitrobenzene
11. 1,1,1-Trichloroethane	57. 2-Nitrophenol
12. Hexachloroethane	58. 4-Nitrophenol
13. 1,1-Dichloroethane	59. 2,4-Dinitrophenol
14. 1,1,2-Trichloroethane	60. 4,6-Dinitro-O-Cresol
15. 1,1,2,2-Tetrachloroethane	61. N-Nitrosodimethylamine
16. Chloroethane	62. N-Nitrosodiphenylamine
	63. N-Nitrosodi-N-Propylamine
18. Bis(2-Chloroethyl) Ether	64. Pentachlorophenol
19. 2-Chloroethyl Vinyl Ether (Mixed)	65. Phenol
20. 2-Chloronaphthalene	66. Bis(2-ethylhexyl) Phthalate
21. 2,4,6-Trichlorophenol	67. Butyl Benzyl Phthalate
22. Parachlorometa Cresol	68. Di-N-Butyl Phthalate
23. Chloroform (Trichloromethane)	69. Di-N-Octyl Phthalate
24. 2-Chlorophenol	70. Diethyl Phthalate
25. 1,2-Dichlorobenzene	71. Dimethyl Phthalate
26. 1,3-Dichlorobenzene	72. 1,2-Benzanthracene (Benzo(A) Anthracene)
27. 1,4-Dichlorobenzene	73. Benzo (A) Pyrene (3,4-Benzo-Pyrene)
28. 3,3'-Dichlorobenzidine	74. 3,4-Benzofluoranthene (Benzo(B) (Fluoranthene)
29. 1,1-Dichloroethylene	75. 11,12-Benzofluoranthene (Benzo(K) Fluoranthene)
30. 1,2-Trans-Dichloroethylene	76. Chrysene
31. 2,4-Dichlorophenol	77. Acenaphthylene
32. 1,2-Dichloropropane	78. Anthracene
33. 1,2-Dichloropropylene (1,3-Dichloropropene)	79. 1,12-Benzoperylene (Benzo(GHI)-Perylene)
34. 2,4-Dimethylphenol	80. Fluorene
35. 2,4-Dinitrotoluene	81. Phenanthrene
36. 2,6-Dinitrotoluene	82. 1,2,5,6-Dibenzathracene (Dibenzo(A,H) Anthracene)
37. 1,2-Diphenylhydrazine	83. Ideno(1,2,3-CD) Pyrene (2,3-0-Phenylene Pyrene)
38. Ethylbenzene	84. Pyrene
39. Fluoranthene	85. Tetrachloroethylene
40. 4-Chlorophenyl Phenyl Ether	86. Toluene
41. 4-Bromophenyl Phenyl Ether	87. Trichloroethylene
42. Bis(2-Chloroisopropyl) Ether	88. Vinyl Chloride (Chloroethylene)
43. Bis(2-Chloroethoxy)Methane	89. Aldrin
44. Methylene Chloride	90. Dieldrin
45. Methyl Chloride (Chloromethane)	
46. Methyl Bromide (Bromomethane)	

TABLE 5-1- continued

91. Chlordane (Technical Mixture and Metabolites)
92. 4,4'-DDT
93. 4,4'-DDE (P,P'-DDX)
94. 4,4'-DDD (P,P-TDE)
95. Alpha-Endosulfan
96. Beta-Endosulfan
97. Endosulfan Sulfate
98. Endrin
99. Endrin Aldehyde
100. Heptachlor
101. Heptachlor Epoxide (BHC-Hexachlorocyclohexane)
102. Alpha-BHC
103. Beta-BHC
104. Gamma-BHC
105. Delta-BHC
106. PCB-1242 (Arochlor 1242)
107. PCB-1254 (Arochlor 1254)
108. PCB-1221 (Arochlor 1221)
109. PCB-1232 (Arochlor 1232)
110. PCB-1248 (Arochlor 1248)
111. PCB-1260 (Arochlor 1260)
112. PCB-1016 (Arochlor 1016)
113. Toxaphene
114. Antimony
115. Arsenic
116. Asbestos
117. Beryllium
118. Cadmium
119. Chromium
120. Copper
121. Cyanide
122. Lead
123. Mercury
124. Nickel
125. Selenium
126. Silver
127. Thallium
128. Zinc
129. 2,3,4,8-Tetrachlorodibenzo-P-Dioxin (TCDD)

5.1.2 Sampling Methodology

During the initial visit to a facility, a selection was made of sampling points so as to best characterize process wastes and evaluate the efficiency of any wastewater treatment. The nature of the wastewater flow at each selected sampling point then determined the method of sampling, i.e., automatic composite or grab composite. The sampling points were of individual raw waste streams, or treated effluent.

Each sample was collected whenever possible by an automatic time series compositor over a single 24-hour sampling period. When automatic compositing was not possible, grab samples were taken at intervals over the same period, and were composited manually. When a sample was taken for analysis of toxic organics, a blank was also taken to determine the level of contamination inherent to the sampling and transportation procedures.

Each sample was divided into several portions and preserved, when necessary, in accordance with established procedures for the measurement of toxic and classical pollutants. Samples were shipped in ice-cooled containers by the best available route to EPA-contracted laboratories for analysis. Chain of custody for the samples was maintained through the EPA Sample Control Center tracking forms.

5.1.3 Analytical Methods

The analytical techniques for the identification and quantitation of toxic pollutants were those described in Sampling and Analysis Procedures for Screening of Industrial Effluents for Priority Pollutants, revised in April 1977.

In the laboratory, samples for organic pollutant analysis were separated by specific extraction procedures into acid (A), base/neutral (B/N), and pesticide (P) fractions. Volatile organic samples (V) were taken separately as a series of grab samples at four-hour intervals and composited in the laboratory. The analysis of these fractions incorporated the application of strict quality control techniques including the use of standards, blanks, and spikes. Gas chromatography and gas chromatography/mass spectrometry were the analytical procedures used for the organic pollutants. Two other analytical methods were used for the measurement of toxic metals: flameless atomic absorption and inductively coupled argon plasma spectrometric analysis (ICAP). The metals determined by each method were:

Flameless AA

Antimony
Arsenic
Selenium
Silver

ICAP

Beryllium
Cadmium
Chromium
Copper

Thallium

Lead
Nickel
Zinc

Mercury was analyzed by a special manual cold-vapor atomic absorption technique.

For the analysis of conventional and non-conventional pollutants, procedures described by EPA were followed. The following conventions were used in quantifying the levels determined by analysis:

- o Pollutants detected at levels below the quantitation limit are reported as "less than" the quantitation limit. All other pollutants are reported as the measured value.
- o The tables show data for total toxic organics, toxic and non-toxic metals, and other pollutants. Total toxic organics is the sum of all toxic organics found at concentrations greater than 0.01 mg/l.
- o Blank Entries - Entries were left blank when the parameter was not detected.

5.2 CATHODE RAY TUBES

5.2.1 Wastewater Flow

Presented below is a summary of the quantities of wastewater generated by the manufacturers of color television picture tubes and other single phosphor tubes.

<u>Number of Plants</u>	<u>Wastewater Discharge (gpd)</u>		
	<u>Min.</u>	<u>Mean</u>	<u>Max.</u>
24	<50	132,500	500,000

5.2.2 Wastewater Sources

Process wastewater sources from the manufacture of cathode ray tubes are sizeable and include wash and rinse operations associated with: glass panel wash, mask degrease, photoresist application, phosphor application, glass funnel and mount cleaning, and tube salvage.

5.2.3 Pollutants Found and the Sources of These Pollutants

The major pollutants of concern from the Cathode Ray Tube Subcategory are:

pH Chromium

TSS	Lead
Fluoride	Zinc
Cadmium	Toxic Organics

The process steps associated with the sources of these pollutants are described in Section 4. Table 5-2 summarizes the occurrence and levels at which these pollutants are found based on the Agency's sampling and analysis of wastewater from three television picture tube manufacturing facilities and raw waste monitoring data provided by plant 99797. Concentrations represent total raw wastes after flow-proportioning individual plant streams. Figures 5-1, 5-2, and 5-3 identify sampling locations, and Tables 5-3, 5-4, and 5-5 summarize analytical data and wastewater flows obtained from each of the plants sampled. Raw waste monitoring data from plant 99797 is presented in Appendix 1.

pH -- may be very high or very low. High pH results from caustic cleaning operations. Low pH results from the use of acids for etching and cleaning operations.

Total Suspended Solids -- are common in cathode ray tube manufacture wastewater and result primarily from graphite emulsions (DAG) used to coat the inner and outer surfaces of glass panels and funnels. Sources include both manufacture and salvage cleaning operations.

Fluoride -- has as its source the use of hydrofluoric acid for cleaning and conditioning glass surfaces. Sources of fluoride in wastewater include both manufacture and salvage operations.

Cadmium and Zinc -- are the primary toxic metals found in phosphors used in cathode ray tubes. Sources of these metals in wastewater include manufacture, salvage, and phosphor recovery operations.

Chromium -- occurs as dichromate in photosensitive materials used to prepare glass surfaces for phosphor application. Sources of chromium in wastewater include both manufacture and salvage operations.

Lead -- is present in high concentration in the solder or frit used to fuse glass panels and funnels together. The major source of lead in wastewater occurs in tube salvage operations when acids are used to dissolve the frit and to clean the panels and funnels.

Toxic Organics -- result from the use of solvents such as methylene chloride and trichloroethylene for cleaning and degreasing operations and from toluene-based lacquer coatings applied as a sealant over phosphor coatings. Only limited sampling has been conducted for toxic organics in this subcategory.

TABLE 5-2

CATHODE RAY TUBE
SUMMARY OF RAW WASTE DATA

PARAMETER	CONCENTRATION, mg/l		
	MINIMUM	MAXIMUM	MEAN
TOXIC METALS			
114 Antimony	0.036	0.196	0.097
115 Arsenic	0.149	0.284	0.207
117 Beryllium	<0.001	0.005	0.003
118 Cadmium*	0.041	0.626	0.314
119 Chromium*	0.800	2.149	1.350
120 Copper*	0.012	0.715	0.207
122 Lead*	4.04	70.8	24.8
123 Mercury	0.001	0.003	0.002
124 Nickel*	0.020	0.203	0.084
125 Selenium	0.001	0.007	0.004
126 Silver*	0.001	0.059	0.019
127 Thallium	0.001	0.001	0.001
128 Zinc*	2.610	19.72	9.76
Total Toxic Organics**	0.030	0.150	0.085
Oil and Grease	2.158	16.0	7.72
Biochemical Oxygen Demand	0.107	17	7.38
Total Suspended Solids*	21.01	600	289
Fluoride*	31.7	970.8	318

*Includes raw waste monitoring data provided by Plant 99797
 **3 days of sampling at one plant

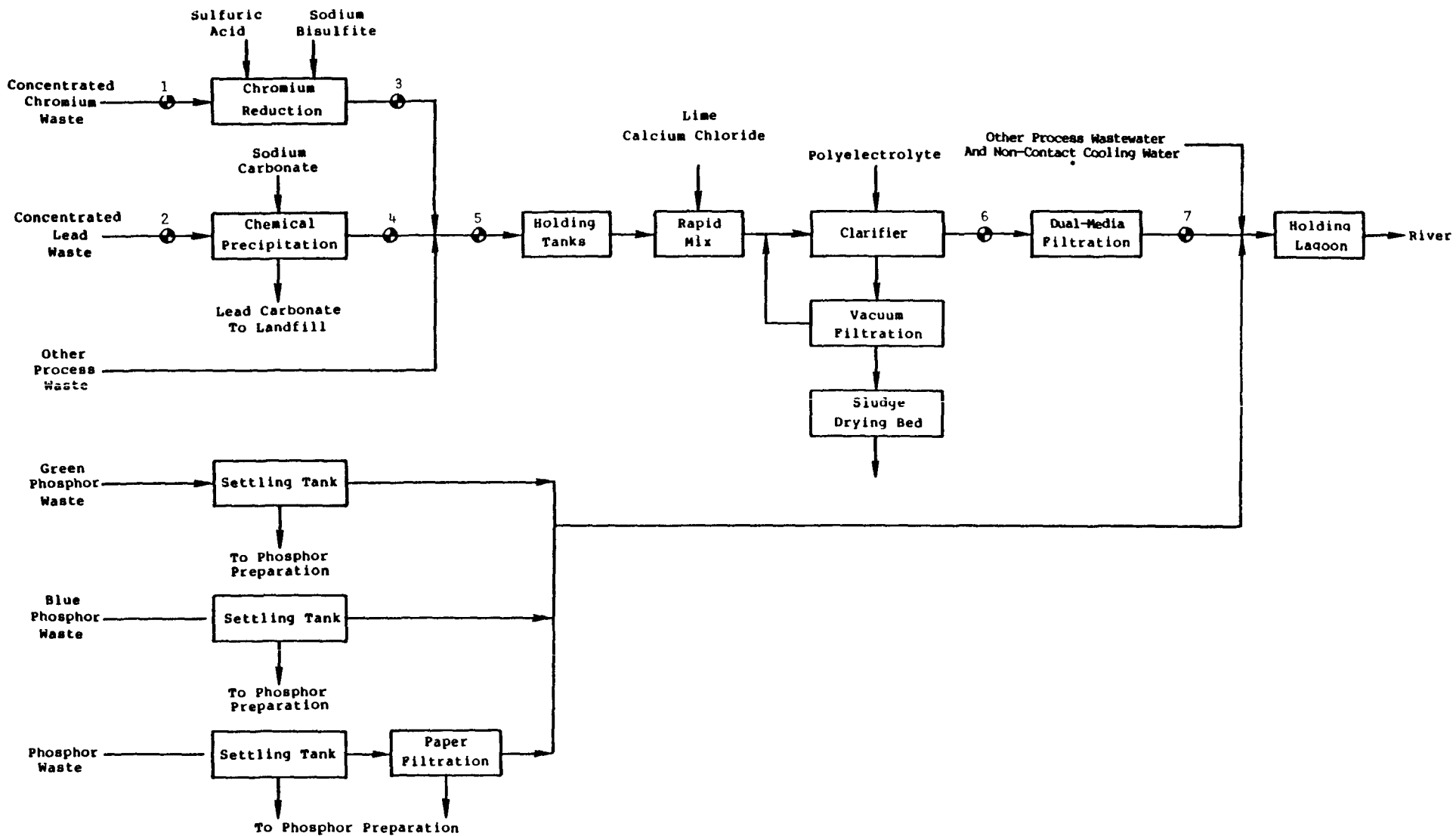

Figure 5-1

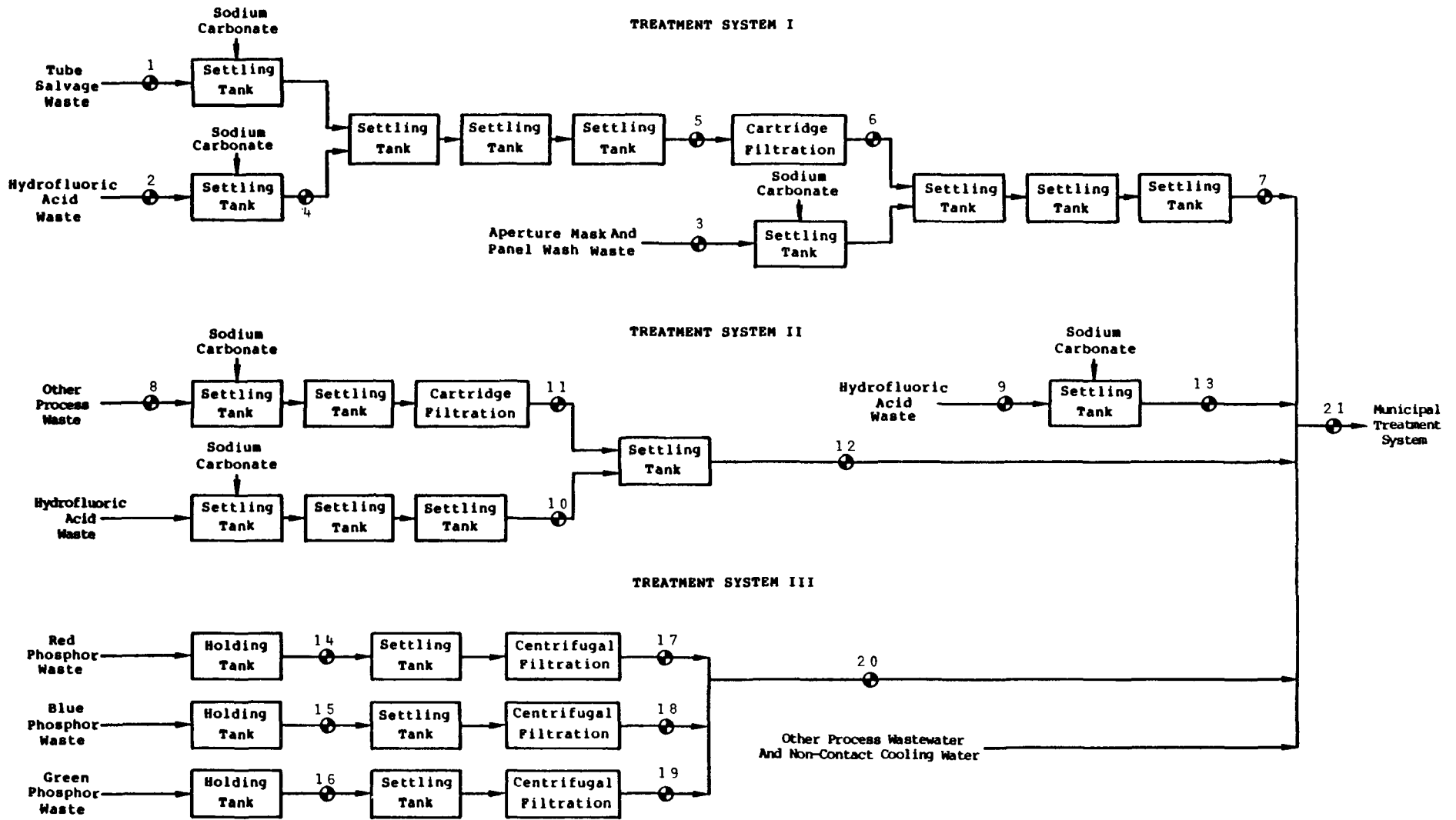

Figure 5-2

PLANT 11114 SAMPLING LOCATIONS

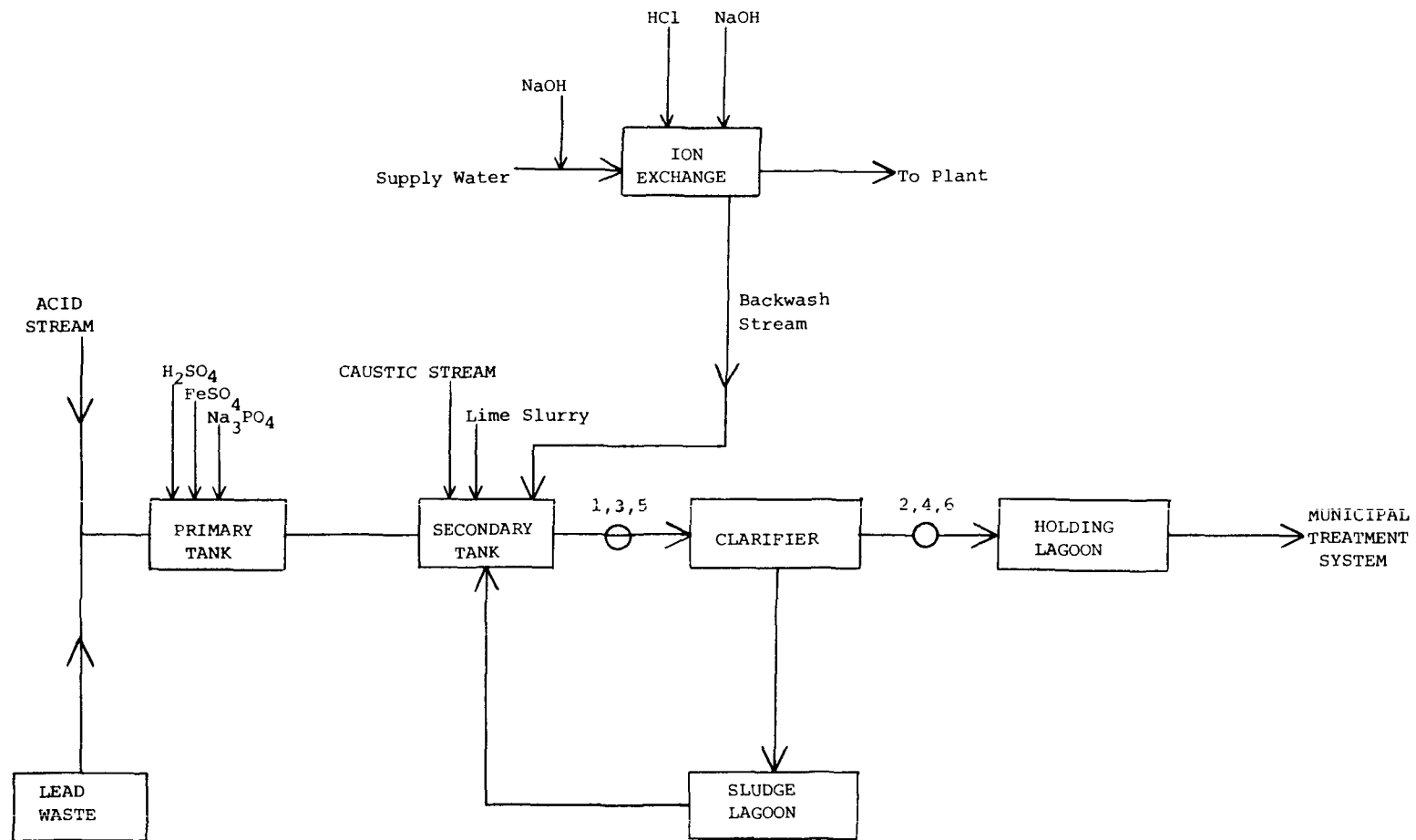

FIGURE 5-3

PLANT 99796 SAMPLING LOCATIONS

TABLE 5-3
 PICTURE TUBE PROCESS WASTES
 Plant 30172

Stream Identification	Chromium Reduction Influent	Lead Treatment Influent	Chromium Reduction Effluent
Sample Number	1*	2	3*
Flow Rate Liters/Hr-Gallon/day	440/2790	45/285	440/2794
Duration Hours/Day	24	24	24
	mg/l	mg/l	mg/l
<u>TOXIC ORGANICS</u>			
		Not Analyzed	Not Analyzed
4 Benzene	<0.010		
11 1,1,1-Trichloroethane	0.058		
39 Fluoranthene	<0.010		
44 Methylene chloride	0.490		
55 Napthalene	<0.010		
66 Bis(2-ethylhexyl)phthalate	0.460		
67 Butyl benzyl phthalate	0.010		
78 Anthracene	<0.010		
81 Phenanthrene	<0.010		
84 Pyrene	<0.010		
86 Toluene	0.029		
87 Trichloroethylene	0.010		
Total Toxic Organics	1.037		
121 Cyanide	<0.005	<0.005	<0.005
<u>TOXIC INORGANICS</u>			
114 Antimony	0.003	0.092	0.004
115 Arsenic	0.005	0.250	0.017
117 Beryllium	0.001	0.004	<0.001
118 Cadmium	<0.002	1.070	<0.002
119 Chromium	89.07	4.670	73.33
120 Copper	0.019	<0.05	0.016
122 Lead	0.125	891.	0.062
123 Mercury	<0.001	0.001	<0.001
124 Nickel	0.006	18.5	<0.005
125 Selenium	0.004	<0.020	0.011
126 Silver	0.001	0.060	<0.001
127 Thallium	0.017	0.002	<0.001
128 Zinc	<0.013	1510.	0.02
*Average of three samples.			
<u>NON-CONVENTIONAL POLLUTANTS</u>			
Calcium	2.82	87.7	5.820
Magnesium	0.70	30.9	1.327
Sodium	8.14	640	79.8
Aluminum	0.037	12	0.073
Manganese	0.006	5.860	0.031
Vanadium	0.014	0.161	0.006
Boron	0.122	346	0.144
Barium	0.03	205	0.039
Molybdenum	0.132	1.60	0.125
Tin	0.101	3.010	0.091
Yttrium	0.042	16.8	0.022
Cobalt	0.058	2.650	0.050
Iron	0.105	1940	3.870
Titanium	0.005	0.314	<0.002
Phenols	0.013	0.01	0.013
Total Organic Carbon	706.7	<1.0	773.3
Fluoride	1.17	160	0.433
<u>CONVENTIONAL POLLUTANTS</u>			
pH	5.13	<2.0	3.1
Oil & Grease	33	11	121
Biochemical Oxygen Demand	8	<1.0	23.7
Total Suspended Solids	1.27	190	1.2

TABLE 5-3
 PICTURE TUBE PROCESS WASTES
 Plant 30172 - continued

Stream Identification	Lead Treatment Effluent	Primary Treatment Influent
Sample Number	4**	5*
Flow Rate Liters/Hr-Gallon/day	127/268	12905/81820
Duration Hours/Day	8	24
	mg/l	mg/l
<u>TOXIC ORGANICS</u>		
	Not Analyzed	Not Analyzed
121 Cyanide	<0.005	0.005
<u>TOXIC INORGANICS</u>		
114 Antimony	0.069	0.153
115 Arsenic	0.009	0.121
117 Beryllium	<0.001	<0.001
118 Cadmium	<0.005	0.171
119 Chromium	0.022	2.87
120 Copper	0.042	0.066
122 Lead	1.190	14.17
123 Mercury	<0.001	<0.001
124 Nickel	0.911	0.074
125 Selenium	0.006	<0.004
126 Silver	0.002	0.0013
127 Thallium	<0.006	<0.001
128 Zinc	18.7	6.08
*Average of three samples.		
**Average of two samples.		
<u>NON-CONVENTIONAL POLLUTANTS</u>		
Calcium	29.6	82.93
Magnesium	17.3	8.32
Sodium	11950	145.33
Aluminum	0.628	3.83
Manganese	0.59	0.044
Vanadium	0.017	0.006
Boron	322.5	8.59
Barium	10.27	0.771
Molybdenum	0.214	0.064
Tin	0.249	0.056
Yttrium	<0.01	1.683
Cobalt	0.308	<0.05
Iron	0.229	8.56
Titanium	0.032	0.075
Phenols	0.045	<0.01
Total Organic Carbon	89.5	49.3
Fluoride	78.5	340
<u>CONVENTIONAL POLLUTANTS</u>		
pH	6.85	2.17
Oil & Grease	11	12.3
Biochemical Oxygen Demand	<1	<1
Total Suspended Solids	11	89.3

TABLE 5-3
 PICTURE TUBE PROCESS WASTES
 Plant 30172 - continued

Stream Identification	Primary Treatment Effluent	Filter Effluent
Sample Number	6**	7*
Flow Rate Liters/Hr-Gallon/day	12500/79252	12905/81820
Duration Hours/Day	24	24
	mg/l	mg/l
<u>TOXIC ORGANICS</u>	Not Analyzed	Not Analyzed
121 Cyanide	<0.005	<0.01
<u>TOXIC INORGANICS</u>		
114 Antimony	0.117	0.120
115 Arsenic	0.009	0.009
117 Beryllium	<0.001	<0.001
118 Cadmium	<0.002	<0.002
119 Chromium	0.244	0.208
120 Copper	0.015	0.014
122 Lead	0.253	0.163
123 Mercury	<0.001	<0.001
124 Nickel	0.013	0.015
125 Selenium	<0.005	<0.004
126 Silver	<0.001	<0.001
127 Thallium	<0.001	<0.001
128 Zinc	0.131	0.075
*Average of three samples.		
**Average of two samples.		
<u>NON-CONVENTIONAL POLLUTANTS</u>		
Calcium	322.5	306.3
Magnesium	7.05	7.81
Sodium	132.5	145
Aluminum	0.397	0.301
Manganese	0.007	0.007
Vanadium	0.002	<0.001
Boron	1.97	2.293
Barium	0.166	0.144
Molybdenum	0.039	<0.035
Tin	<0.025	0.07
Yttrium	0.006	<0.003
Cobalt	<0.05	<0.05
Iron	0.230	0.115
Titanium	<0.002	<0.002
Phenols	0.020	0.023
Total Organic Carbon	35.5	39.67
Fluoride	7.1	11.07
<u>CONVENTIONAL POLLUTANTS</u>		
pH	7.9	7.73
Oil & Grease	297.33	20.67
Biochemical Oxygen Demand	3.0	5.33
Total Suspended Solids	3.0	3.13

TABLE 5-4
 PICTURE TUBE PROCESS WASTES
 PLANT 11114
 Treatment System I

Stream Identification	Tube Salvage Waste Influent	HF - HNO ₃ Tube Salvage Waste Influent	Mask Panel Waste Influent
Sample Number	1	2	3
Flow Rate Liters/Hr-Gallon/day	10674/67700	426/2700	11128/70600
Duration Hours/Day	24	Batch	24
	mg/l	mg/l	mg/l
<u>TOXIC ORGANICS</u>	Not Analyzed	Not Analyzed	
4 Benzene			<0.010
23 Chloroform			<0.010
44 Methylene Chloride			<0.010
55 Nephthalene			<0.010
66 Bis(2-ethylhexyl)phthalate			0.020
67 Butyl benzyl phthalate			<0.010
68 Di-N-butyl phthalate			<0.010
86 Toluene			<0.010
87 Trichloroethylene			<0.010
95 Alpha-Endosulfan			<0.005
Total Toxic Organics			0.020
121 Cyanide	0.018	0.250	0.009
<u>TOXIC INORGANICS</u>			
114 Antimony	0.058	0.520	0.046
115 Arsenic	0.244	1.420	0.052
117 Beryllium	<0.005	<0.005	<0.005
118 Cadmium	0.127	13.400	0.094
119 Chromium	0.041	3.200	0.735
120 Copper	0.016	0.950	0.198
122 Lead	35.500	749.	0.516
123 Mercury	<0.001	<0.001	<0.001
124 Nickel	0.042	3.240	0.020
125 Selenium	<0.010	<0.050	<0.002
126 Silver	0.003	0.100	<0.001
127 Thallium	<0.001	0.002	<0.001
128 Zinc	9.080	1430.	1.170
<u>NON-CONVENTIONAL POLLUTANTS</u>			
Calcium	30.70	116.	19.60
Magnesium	12.10	46.7	4.850
Sodium	495.	3040.	35.70
Aluminum	9.920	62.3	9.150
Manganese	0.006	0.863	0.012
Vanadium	<0.001	0.074	0.005
Boron	11.70	280.	11.50
Barium	0.524	54.0	0.397
Molybdenum	<0.035	0.173	<0.035
Tin	<0.025	0.329	<0.025
Yttrium	1.030	23.7	0.590
Cobalt	<0.050	0.491	<0.050
Iron	1.880	264.	1.280
Titanium	0.046	0.567	0.127
Phenols	0.005	0	0.027
Total Organic Carbon	35	94	139
Fluoride	780	2700	1925
<u>CONVENTIONAL POLLUTANTS</u>			
pH	5.6		2.7
Oil & Grease	38	20	1
Biochemical Oxygen Demand	0	0	0
Total Suspended Solids	127	68	185

TABLE 5-4
 PICTURE TUBE PROCESS WASTES
 PLANT 1114
 Treatment System I - continued

Stream Identification	HF - HNO ₃ Tube Salvage Post Settle	Pre-Filtration
Sample Number	4	5
Flow Rate Liters/Hr-Gallon/day	473/3000	11147/70700
Duration Hours/Day	Batch	24
	mg/l	mg/l
<u>TOXIC ORGANICS</u>		Not Analyzed
4 Benzene	<0.010	
23 Chloroform	<0.010	
44 Methylene Chloride	0.010	
55 Nephthalene	<0.010	
66 Bis(2-ethylhexyl)phthalate	0.130	
67 Butyl benzyl phthalate	0.010	
68 Di-N-butyl phthalate	<0.010	
86 Toluene	<0.010	
87 Trichloroethylene	<0.010	
Total Toxic Organics	0.130	
121 Cyanide	0.185	0.011
<u>TOXIC INORGANICS</u>		
114 Antimony	0.335	0.055
115 Arsenic	0.088	0.078
117 Beryllium	<0.005	<0.005
118 Cadmium	1.150	0.206
119 Chromium	0.024	0.035
120 Copper	0.066	0.030
122 Lead	2.010	12.000
123 Mercury	0.001	<0.001
124 Nickel	0.858	0.076
125 Selenium	<0.010	<0.010
126 Silver	0.004	0.001
127 Thallium	<0.010	<0.001
128 Zinc	47.800	18.800
<u>NON-CONVENTIONAL POLLUTANTS</u>		
Calcium	0.792	8.260
Magnesium	2.310	8.300
Sodium	13100.	1170.
Aluminum	17.3	7.070
Manganese	0.248	0.023
Vanadium	0.018	<0.002
Boron	155.	21.20
Barium	1.90	0.289
Molybdenum	0.092	<0.036
Tin	0.071	<0.026
Yttrium	0.043	0.358
Cobalt	0.602	<0.051
Iron	0.923	1.600
Titanium	0.139	0.037
Phenols	0.026	0
Total Organic Carbon	187	7
Fluoride	6950	910
<u>CONVENTIONAL POLLUTANTS</u>		
pH		6.2
Oil & Grease	25	20
Biochemical Oxygen Demand	0	12
Total Suspended Solids	75	39

TABLE 5-4
 PICTURE TUBE PROCESS WASTES
 PLANT 11114
 Treatment System I - continued

Stream Identification	Post Filtration	Final Effluent
Sample Number	6	7
Flow Rate Liters/Hr-Gallon/day	11147/70700	22275/141000
Duration Hours/Day	24	24
	mg/l	mg/l
<u>TOXIC ORGANICS</u>		
	Not Analyzed	Not Analyzed
121 Cyanide	0.185	0.525
<u>TOXIC INORGANICS</u>		
114 Antimony	0.046	0.061
115 Arsenic	0.156	0.064
116 Beryllium	<0.005	<0.005
118 Cadmium	0.201	0.370
119 Chromium	0.027	0.305
120 Copper	0.015	0.030
122 Lead	6.640	13.800
123 Mercury	<0.001	<0.001
124 Nickel	0.074	0.111
125 Selenium	0.010	<0.002
126 Silver	<0.001	0.002
127 Thallium	<0.001	<0.001
128 Zinc	18.100	32.800
<u>NON-CONVENTIONAL POLLUTANTS</u>		
Calcium	4.420	8.310
Magnesium	6.800	7.730
Sodium	1180.	1200.
Aluminum	6.790	7.610
Manganese	0.024	0.048
Vanadium	<0.001	<0.001
Boron	18.00	19.40
Barium	0.163	0.503
Molybdenum	<0.035	<0.035
Tin	<0.025	<0.025
Yttrium	0.053	0.049
Cobalt	<0.050	<0.050
Iron	1.120	2.040
Titanium	0.032	0.122
Phenols	0	0.034
Total Organic Carbon	4	89
Fluoride	1070	1140
<u>CONVENTIONAL POLLUTANTS</u>		
pH	6.0	6.1
Oil & Grease	20	51
Biochemical Oxygen Demand	22	0
Total Suspended Solids	22	80

TABLE 5-4
 PICTURE TUBE PROCESS WASTES
 PLANT 11114
 Treatment System II

Stream Identification	Other Process Waste Influent	HF - Dump	HF Etch Settle Effluent
Sample Number	8	9	10
Flow Rate Liters/Hr-Gallon/day	17033/108000	142/900	20439/86400
Duration Hours/Day	24	Batch	16
	mg/l	mg/l	mg/l
<u>TOXIC ORGANICS</u>		Not Analyzed	Not Analyzed
4 Benzene	<0.010		
29 1,1-Dichloroethylene	<0.010		
38 Ethylbenzene	<0.010		
44 Methylene chloride	0.020		
66 Bis(2-ethylhexyl)phthalate	0.010		
68 Di-N-butyl phthalate	<0.010		
86 Toluene	<0.010		
87 Trichloroethylene	0.030		
Total Toxic Organics	0.050		
121 Cyanide	Not Analyzed	0.011	
<u>TOXIC INORGANICS</u>			
114 Antimony	0.440	27.000	0.003
115 Arsenic	0.266	9.000	0.005
117 Beryllium	<0.005	<0.010	<0.005
118 Cadmium	0.076	0.975	<0.005
119 Chromium	0.025	1.500	5.580
120 Copper	0.013	0.074	0.127
122 Lead	2.570	6.820	<0.050
123 Mercury	<0.001	0.002	<0.001
124 Nickel	0.014	0.420	0.144
125 Selenium	<0.002	<0.300	<0.010
126 Silver	<0.001	0.001	0.001
126 Thallium	<0.001	<0.025	<0.001
128 Zinc	2.130	10.300	0.194
<u>NON-CONVENTIONAL POLLUTANTS</u>			
Calcium	26.20	6.220	19.70
Magnesium	8.270	2.920	7.080
Sodium	637.	5250.	786.
Aluminum	9.830	311.	0.121
Manganese	0.007	0.540	0.296
Vanadium	0.002	0.326	<0.001
Boron	17.700	862.	0.770
Barium	1.900	5.110	0.034
Molybdenum	0.074	1.840	<0.035
Tin	<0.025	0.311	<0.025
Yttrium	0.681	0.047	0.042
Cobalt	<0.050	<0.100	<0.050
Iron	1.220	22.20	80
Titanium	0.453	15.20	<0.002
Phenols	0	0.008	0
Total Organic Carbon	8	24	5
Fluoride	1800	8400	15
<u>CONVENTIONAL POLLUTANTS</u>			
pH	2.3		7.7
Oil & Grease	14	17	18
Biochemical Oxygen Demand	0	0	16
Total Suspended Solids	137	3350	178

TABLE 5-4
 PICTURE TUBE PROCESS WASTES
 PLANT 1114
 Treatment System II - continued

Stream Identification	Post Filtration	System II Final Effluent	HF - Dump Effluent
Sample Number	11	12	13
Flow Rate Liters/Hr-Gallon/day	17033/10800	30659/194000	170/1080
Duration Hours/Day	24 mg/l	24 mg/l	Batch mg/l
<u>TOXIC ORGANICS</u>	Not Analyzed	Not Analyzed	
4 Benzene			<0.010
44 Methylene chloride			<0.010
66 Bis(2-ethylhexyl)phthalate			<0.010
86 Toluene			<0.010
87 Trichloroethylene			<0.010
Total Toxic Organics			<0.010
121 Cyanide		0.520	
<u>TOXIC INORGANICS</u>			
114 Antimony	0.440	0.079	3.200
115 Arsenic	0.191	0.062	1.570
117 Beryllium	<0.005	<0.005	<0.005
118 Cadmium	0.018	0.006	0.031
119 Chromium	0.015	3.750	0.020
120 Copper	0.016	0.100	0.020
122 Lead	0.883	0.315	3.190
123 Mercury	<0.001	<0.001	<0.001
124 Nickel	<0.013	0.097	<0.013
125 Selenium	0.004	<0.010	<0.025
126 Silver	0.002	<0.001	0.004
127 Thallium	<0.001	<0.001	<0.010
128 Zinc	0.605	0.318	1.080
<u>NON-CONVENTIONAL POLLUTANTS</u>			
Calcium	6.090	15.10	3.310
Magnesium	3.340	5.700	1.190
Sodium	1810.	1050.	10800.
Aluminum	9.410	5.060	62.600
Manganese	0.003	0.196	<0.001
Vanadium	0.003	0.002	0.045
Boron	17.800	11.00	193.
Barium	0.616	0.229	1.630
Molybdenum	<0.036	0.037	0.087
Tin	<0.025	<0.025	0.089
Yttrium	0.152	0.081	0.025
Cobalt	<0.051	<0.050	0.548
Iron	0.636	56.70	1.050
Titanium	0.313	0.112	0.412
Phenols	0	0	0.008
Total Organic Carbon	10	8	472
Fluoride	4000	700	4500
<u>CONVENTIONAL POLLUTANTS</u>			
pH	6.6	7.5	
Oil & Grease	18	10	17
Biochemical Oxygen Demand	11	0	0
Total Suspended Solids	16	135	38

TABLE 5-4
 PICTURE TUBE PROCESS WASTES
 PLANT 11114
 Treatment System III

Stream Identification	Red Phosphor Waste Influent	Blue Phosphor Waste Influent	Green Phosphor Influent
Sample Number	14	15	16
Flow Rate Liters/Hr-Gallon/day	1703/10800	1703/10800	1703/10800
Duration Hours/Day	24	24	24
	mg/l	mg/l	mg/l
<u>TOXIC ORGANICS</u>	Not Analyzed	Not Analyzed	Not Analyzed
<u>TOXIC INORGANICS</u>			
114 Antimony	<0.001	0.001	<0.001
115 Arsenic	0.008	0.002	0.006
117 Beryllium	<0.005	<0.005	<0.005
118 Cadmium	0.120	0.756	184.
119 Chromium	3.710	4.480	4.970
120 Copper	<0.013	<0.013	0.240
122 Lead	<0.050	<0.050	<0.050
123 Mercury	<0.001	<0.001	<0.001
124 Nickel	<0.013	<0.013	<0.013
125 Selenium	<0.010	<0.010	<0.010
126 Silver	0.004	0.360	0.005
127 Thallium	<0.001	<0.001	<0.001
128 Zinc	2.860	1910	1540.
<u>NON-CONVENTIONAL POLLUTANTS</u>			
Calcium	0.271	5.120	0.481
Magnesium	0.496	0.794	<0.049
Sodium	149.	1280.	787.
Aluminum	0.188	1.010	0.426
Manganese	<0.001	<0.001	<0.001
Vanadium	0.172	<0.001	<0.003
Boron	0.721	<0.002	2.390
Barium	0.012	0.151	0.825
Molybdenum	0.133	<0.035	<0.069
Tin	0.591	0.111	0.123
Yttrium	1300.	8.160	0.411
Cobalt	4.730	<0.050	0.293
Iron	<0.001	0.024	0.093
Titanium	0.038	<0.002	<0.004
<u>CONVENTIONAL POLLUTANTS</u>			
pH	5.0	4.0	4.9
Total Suspended Solids	1840	2560	2450

TABLE 5-4
 PICTURE TUBE PROCESS WASTES
 PLANT 11114
 Treatment System III - continued

Stream Identification	Red Phosphor Effluent	Blue Phosphor Effluent	Green Phosphor Effluent
Sample Number	17	18	19
Flow Rate Liters/Hr-Gallon/day	1703/10800	1703/10800	1703/10800
Duration Hours/Day	24	24	24
	mc/l	mg/l	mg/l
<u>TOXIC ORGANICS</u>	Not Analyzed	Not Analyzed	Not Analyzed
Cyanide		28	28
<u>TOXIC INORGANICS</u>			
114 Antimony	<0.001	<0.001	<0.004
115 Arsenic	<0.002	<0.002	<0.002
117 Beryllium	<0.005	<0.005	<0.005
118 Cadmium	0.065	0.020	11.600
119 Chromium	2.620	3.750	2.380
120 Copper	<0.013	<0.013	<0.013
122 Lead	<0.050	<0.050	<0.050
123 Mercury	<0.001	<0.001	<0.001
124 Nickel	<0.013	<0.013	<0.013
125 Selenium	0.020	<0.002	<0.002
126 Silver	<0.001	0.008	0.001
127 Thallium	<0.001	<0.001	<0.001
128 Zinc	0.718	31.500	19.100
<u>NON-CONVENTIONAL POLLUTANTS</u>			
Calcium	0.157	1.110	0.257
Magnesium	<0.025	0.187	<0.025
Sodium	9.930	20.200	18.300
Aluminum	2.400	0.158	0.021
Manganese	<0.001	<0.001	<0.001
Vanadium	<0.001	<0.001	<0.001
Boron	0.383	0.137	0.094
Barium	0.005	0.552	0.538
Molybdenum	<0.035	<0.035	<0.035
Tin	<0.025	<0.025	<0.025
Yttrium	2.460	0.142	0.037
Cobalt	0.186	0.193	0.212
Iron	0.031	0.009	0.004
Titanium	0.007	<0.002	<0.002
<u>CONVENTIONAL POLLUTANTS</u>			
pH	5.0		
Total Suspended Solids	8	36	35

TABLE 5-4
 PICTURE TUBE PROCESS WASTES
 PLANT 11114
 Treatment System III - continued

Stream Identification	Total Phosphor Effluent	Total Plant Effluent
Sample Number	20	21
Flow Rate Liters/Hr-Gallon/day	5110/32400	283875/1800000
Duration Hours/Day	24	24
	mg/l	mg/l

TOXIC ORGANICS

4 Benzene	<0.010	<0.010
11 1,1,1-Trichloroethane	<0.010	0.050
13 1,1-Dichloroethane		<0.010
23 Chloroform	<0.010	
29 1,1-Dichloroethylene	<0.010	<0.010
30 1,2-trans-dichloroethylene		<0.010
38 Ethylbenzene	<0.010	<0.010
44 Methylene chloride	0.020	0.060
48 Dichlorobromomethane		<0.010
51 Chlorodibromomethane		<0.010
66 Bis(2-ethylhexyl)phthalate	<0.010	
68 Di-N-butyl phthalate	<0.010	
85 Tetrachloroethylene		<0.010
86 Toluene	0.030	0.090
87 Trichloroethylene	<0.010	0.030
102 Alpha-BHC		<0.005
105 Delta-BHC		<0.005
Total Toxic Organics	0.050	0.230
Cyanide	<0.005	0.002

TOXIC INORGANICS

114 Antimony		0.052
115 Arsenic		0.037
117 Beryllium		<0.005
118 Cadmium		1.310
119 Chromium		1.230
120 Copper	Not	0.045
122 Lead	Analyzed	1.960
123 Mercury		<0.001
124 Nickel		0.047
125 Selenium		0.002
126 Silver		<0.001
127 Thallium		<0.001
128 Zinc		7.310

NON-CONVENTIONAL POLLUTANTS

Calcium		23.200
Magnesium		8.380
Sodium		454.
Aluminum		4.100
Manganese		0.037
Vanadium		0.002
Boron		9.420
Barium	Not	0.186
Molybdenum	Analyzed	<0.035
Tin		<0.025
Yttrium		0.237
Cobalt		<0.050
Iron		9.930
Titanium		0.045
Phenols	0	0.046
Total Organic Carbon	130	101
Fluoride	45	480

CONVENTIONAL POLLUTANTS

pH		7.2
Oil & Grease	505	49
Biochemical Oxygen Demand	48	71
Total Suspended Solids	1080	63

TABLE 5-5
 PICTURE TUBE PROCESS WASTES
 PLANT 99796

Stream Identification	Clarifier Influent	Clarifier Effluent	Clarifier Influent
Sample Number	1	2	3
Flow Rate Liters/Hr/Gallon/day	85626/542880	85626/542880	74950/475200
Duration/Hours/Day	24	24	24
	mg/l	mg/l	mg/l
<u>TOXIC ORGANICS</u>			
23 Chloroform	0.050	0.035	0.030
87 Trichloroethylene	0.025	0.021	
Total Toxic Organics	0.075	0.056	0.030
121 Cyanide	<0.01	0.02	<0.01
<u>TOXIC INORGANICS</u>			
114 Antimony	0.040	0.060	0.040
115 Arsenic	0.030	<0.010	0.030
117 Beryllium	<0.001	<0.001	<0.001
118 Cadmium	0.637	0.021	0.434
119 Chromium	0.776	0.150	0.900
120 Copper	0.016	<0.004	0.012
122 Lead	20.100	0.400	5.300
123 Mercury	<0.0002	0.0002	0.0004
124 Nickel	<0.015	<0.015	<0.015
125 Selenium	<0.010	<0.010	<0.010
126 Silver	<0.012	<0.003	<0.015
127 Thallium	<0.010	<0.010	<0.010
128 Zinc	31.600	0.944	8.72
<u>NON-CONVENTIONAL POLLUTANTS</u>			
Phenols	<0.02	<0.02	<0.02
Flouride	34	32	26
<u>CONVENTIONAL POLLUTANTS</u>			
Oil & Grease	5	5	5
Biochemical Oxygen Demand	17	10	16
Total Suspended Solids	410	15	320

TABLE 5-5
Picture Tube Process Wastes
Plant 99796 - continued

Stream Identification	Clarifier Effluent	Clarifier Influent	Clarifier Effluent
Sample Number	4	5	6
Flow Rate Liters/Hr/Gallon/day	74950/475200	84500/535680	84500/535680
Duration/Hours/Day	24	24	24
	mg/l	mg/l	mg/l
<u>TOXIC ORGANICS</u>			
23 Chloroform	0.054	0.124	0.024
44 Methylene Chloride	0.008	0.026	0.021
87 Trichloroethylene	0.008		
Total Toxic Organics	0.054	0.150	0.045
121 Cyanide	<0.01	<0.01	0.01
<u>TOXIC INORGANICS</u>			
114 Antimony	0.040	0.100	0.060
115 Arsenic	<0.010	0.050	<0.010
117 Beryllium	<0.001	<0.001	<0.001
118 Cadmium	0.021	0.807	0.014
119 Chromium	0.176	1.300	0.164
120 Copper	<0.004	0.008	<0.004
122 Lead	0.200	13.600	0.300
123 Mercury	0.0004	0.0002	0.0002
124 Nickel	<0.015	0.030	<0.015
125 Selenium	<0.010	<0.010	<0.010
126 Silver	<0.006	<0.015	<0.003
127 Thallium	<0.010	<0.010	<0.010
128 Zinc	0.345	18.800	0.360
<u>NON-CONVENTIONAL POLLUTANTS</u>			
Phenols	<0.02	0.02	0.02
Fluoride	26	35	32
<u>CONVENTIONAL POLLUTANTS</u>			
Oil & Grease	<5	5	5
Biochemical Oxygen Demand	15	18	15
Total Suspended Solids	20	410	10

5.3 LUMINESCENT MATERIALS

5.3.1 Wastewater Flow

Presented below is a summary of the quantities of wastewater generated by the manufacturers of luminescent materials.

<u>Number of Plants</u>	<u>Wastewater Discharge (gpd)</u>		
	<u>Min.</u>	<u>Mean</u>	<u>Max.</u>
5	10,000	104,000	247,000

5.3.2 Wastewater Sources

Process wastewater sources from the manufacture of luminescent materials include the various crystallization, washing, and filtration steps in the production of intermediate and final product powders. Additional sources are wet scrubbers used in conjunction with firing and drying operations.

5.3.3 Pollutants Found and the Sources of These Pollutants

The major pollutants of concern from the Luminescent Materials Subcategory are:

pH
TSS
Antimony
Cadmium
Zinc

The process steps associated with the sources of these pollutants are described in Section 4. Table 5-6 summarizes the occurrence and levels of these pollutants based on sampling and analysis data. Concentrations represent total raw wastes after flow-proportioning individual plant waste streams. Figure 5-4 identifies the sampling location at one facility. Tables 5-7 through 5-9 present the analytical data for three sampled plants in the luminescent materials subcategory.

pH -- may be very low or very high in specific waste streams as a result of acids used for dissolving raw materials and caustics used in wet scrubbers.

Total Suspended Solids -- occur in wastes from washing and filtration operations and in wet scrubber wastes. The solids primarily consist of precipitated product materials and raw material impurities.

Fluoride -- occurs in wastewaters from lamp phosphor manufacture. Calcium fluoride, as an intermediate powder product, appears in wastes from washing and filtration operations.

TABLE 5-6

LUMINESCENT MATERIALS
SUMMARY OF RAW WASTE DATA

PARAMETER	CONCENTRATION, mg/l		
	MINIMUM	MAXIMUM	MEAN
TOXIC METALS			
114 Antimony	0.021	6.62	2.69
115 Arsenic	0.005	0.020	0.013
117 Beryllium	0.003	0.008	0.005
118 Cadmium	0.216	9.35	4.06
119 Chromium	0.025	0.067	0.050
120 Copper	0.005	0.101	0.051
122 Lead	0.009	0.155	0.064
123 Mercury	0.001	0.005	0.003
124 Nickel	0.025	0.745	0.322
125 Selenium	0.005	0.005	0.005
126 Silver	0.015	0.044	0.025
127 Thallium	0.027	0.065	0.041
128 Zinc	2.864	350.6	120.6
Total Toxic Organics	0.060	1.292	0.590
Oil and Grease	2.64	6.40	3.01
Biochemical Oxygen Demand	2	8	5
Total Suspended Solids	91	4008	1440
Fluoride	11.05	702	356.5

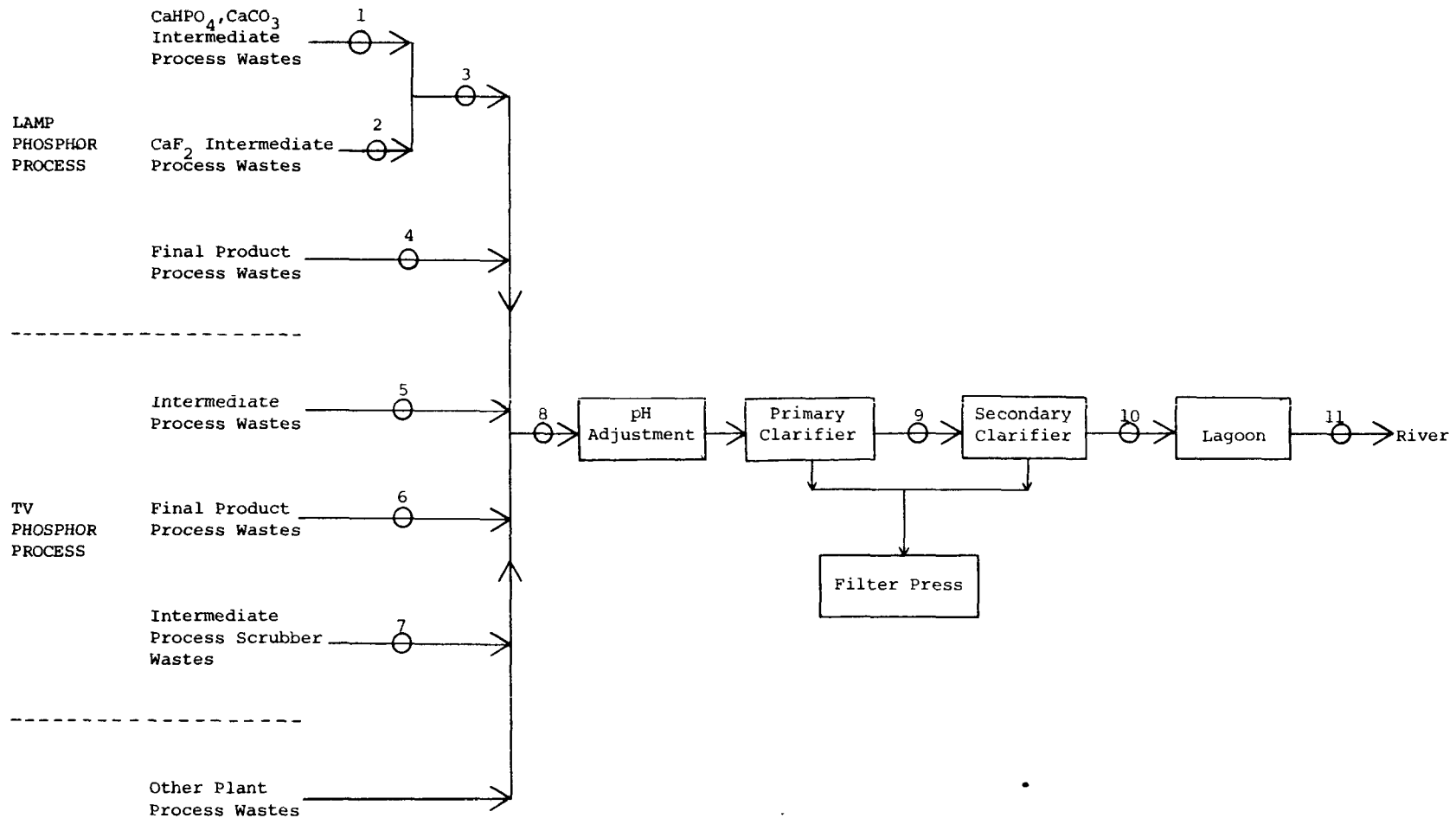

FIGURE 5- 4

PLANT 101 SAMPLING LOCATIONS

TABLE 5-7
LAMP PHOSPHOR WASTES
PLANT 101

Stream Identification	Calcium Intermediate Powder Wastes	Fluoride Intermediate Powder Wastes
Sample Number	1	2
Flow Rate Liters/Hr-Gallon/day	26810/170000 mg/l	946/6000 mg/l
<u>TOXIC ORGANICS</u>	Not Analyzed	Not Analyzed
<u>TOXIC INORGANICS</u>		
114 Antimony	0.016	0.013
115 Arsenic	0.003	0.024
117 Beryllium	<0.003	<0.003
118 Cadmium	0.076	<0.030
119 Chromium	0.070	0.020
120 Copper	0.050	0.020
122 Lead	<0.020	<0.020
123 Mercury	0.005	0.004
124 Nickel	0.220	0.090
125 Selenium	<0.005	<0.005
126 Silver	0.05	0.010
126 Thallium	<0.030	<0.030
128 Zinc	0.005	0.289
<u>NON-CONVENTIONAL POLLUTANTS</u>		
Magnesium	2.704	
Sodium	211.345	
Aluminum	2.598	
Manganese	0.029	0.030
Vanadium	0.252	
Boron	0.633	
Barium	0.402	
Molybdenum	8.378	
Tin	0.230	
Yttrium	0.418	
Cobalt	0.100	
Iron	0.208	
Titanium	0.127	
Fluoride		100
<u>CONVENTIONAL POLLUTANTS</u>		
Biochemical Oxygen Demand	<3	
Total Suspended Solids	840	1100

TABLE 5-7
LAMP PHOSPHOR WASTES
PLANT 101

Stream Identification Sample Number Flow Rate Liters/Hr-Gallon/day	Composites 1 & 2 3 mg/l	Fired Lamp Powder Wastes 4 3785/24000 mg/l
<u>TOXIC ORGANICS</u>		
11 1,1,1-Trichloroethane		<0.010
23 Chloroform	<0.010	<0.010
44 Methylene Chloride	0.012	0.011
66 Bis(2-ethylhexyl)phthalate	0.470	1.200
67 Butyl benzyl phthalate	0.960	<0.010
68 Di-N-butyl phthalate	0.015	<0.010
70 Diethyl Phthalate	<0.010	
Total Toxic Organics	1.457	1.211
121 Cyanide	<0.004	<0.004
<u>TOXIC INORGANICS</u>		
	Not Analyzed	
114 Antimony		14.669
115 Arsenic		0.116
117 Beryllium		<0.003
118 Cadmium		26.210
119 Chromium		0.050
120 Copper		0.040
122 Lead		0.080
123 Mercury		0.003
124 Nickel		0.290
125 Selenium		<0.005
126 Silver		0.020
127 Thallium		<0.030
128 Zinc		0.071
<u>NON-CONVENTIONAL POLLUTANTS</u>		
Magnesium		0.680
Sodium		2.288
Aluminum		1.189
Manganese		32.250
Vanadium		0.050
Boron		1.721
Barium		0.040
Molybdenum		0.052
Tin		0.028
Yttrium		0.037
Cobalt		0.005
Phenols	<0.002	<0.002
Total Organic Carbon	8.0	170
Fluoride		7200
Ammonia		3.4
<u>CONVENTIONAL POLLUTANTS</u>		
Total Suspended Solids		3200

TABLE 5-7
TV PHOSPHOR WASTES
PLANT 101

Stream Identification	Intermediate Powder Wastes	Phosphor Wastes	Scrubber Wastes
Sample Number	5	6	7
Flow Rate Liters/Hr-Gallon/day	4732/30000 mg/l	1577/10000 mg/l	1104/7000 mg/l
<u>TOXIC ORGANICS</u>			Not Analyzed
11 1,1,1-Trichloroethane	<0.01	<0.01	
44 Methylene Chloride	0.018	0.014	
66 Bis(2-ethylhexyl)phthalate	1.100	1.200	
67 Butyl benzyl phthalate	<0.01	<0.01	
68 Di-N-butyl phthalate	<0.01	<0.01	
70 Diethyl Phthalate	<0.01		
Total Toxic Organics	1.118	1.214	
121 Cyanide	<0.004	<0.004	
<u>TOXIC INORGANICS</u>			
114 Antimony	0.021	0.011	0.049
115 Arsenic	<0.001	<0.001	0.040
117 Beryllium	<0.003	<0.003	<0.003
118 Cadmium	0.077	<0.030	0.058
119 Chromium	0.005	<0.005	0.080
120 Copper	0.020	0.010	0.150
122 Lead	0.050	<0.020	<0.020
123 Mercury	0.006	0.002	0.007
124 Nickel	0.040	<0.020	1.290
125 Selenium	<0.005	<0.005	0.005
126 Silver	0.010	<0.003	0.230
127 Thallium	<0.030	<0.030	<0.030
128 Zinc	2,590	888.5	0.194
<u>NON-CONVENTIONAL POLLUTANTS</u>			
Calcium	1.311	2.219	2.819
Magnesium	0.083	13.670	0.035
Sodium	1.036	2.696	
Aluminum	0.015	0.771	2.821
Manganese	0.008	0.026	0.017
Vanadium	<0.001	0.114	0.201
Boron	0.021	0.038	6.043
Barium	0.007	0.004	0.033
Molybdenum	2.826	1.006	1.903
Tin	0.224	0.053	0.407
Yttrium	<0.001	0.037	0.699
Cobalt	0.043	0.080	0.068
Iron	0.417	0.142	0.308
Titanium	0.020	0.007	0.048
Phenols	<0.002	<0.002	
Total Organic Carbon	20	4.0	
<u>CONVENTIONAL POLLUTANTS</u>			
Total Suspended Solids	24,700	1500	1100

TABLE 5-7
TREATMENT SYSTEMS
PLANT 101

Stream Identification	Treatment Influent	Primary Clarifier Effluent
Sample Number	8	9
Flow Rate Liters/Hr-Gallon/day	189270/1200000	189270/1200000
	mg/l	mg/l
<u>TOXIC ORGANICS</u>	Not Analyzed	Not Analyzed
<u>TOXIC INORGANICS</u>		
114 Antimony	0.029	0.058
115 Arsenic	0.078	<0.001
117 Beryllium	<0.030	<0.003
118 Cadmium	0.337	0.091
119 Chromium	1.730	0.120
120 Copper	0.150	0.090
122 Lead	<0.020	<0.020
123 Mercury	0.003	0.005
124 Nickel	0.260	0.330
125 Selenium	<0.005	<0.005
126 Silver	0.040	0.010
126 Thallium	<0.030	<0.030
128 Zinc	5.517	0.419
<u>NON-CONVENTIONAL POLLUTANTS</u>		
Calcium	302.707	513.207
Magnesium	88.120	129.602
Aluminum	3.052	2.399
Manganese	0.783	0.260
Vanadium	0.804	0.872
Boron	1.500	0.948
Barium	0.319	0.099
Molybdenum	0.958	0.568
Tin	0.285	0.257
Europium	<0.05	<0.01
Yttrium	<2	0.364
Cobalt	1.153	0.373
Iron	133.988	3.560
Titanium	0.095	0.077
<u>CONVENTIONAL POLLUTANTS</u>		
Total Suspended Solids	210	110

TABLE 5-7
TREATMENT SYSTEMS
PLANT 101 - continued

Stream Identification	Secondary Clarifier Effluent	Final Effluent
Sample Number	10	11
Flow Rate Liters/Hr/Gallon/day	189270/1200000 mg/l	189270/1200000 mg/l
<u>TOXIC ORGANICS</u>	Not Analyzed	Not Analyzed
<u>TOXIC INORGANICS</u>		
114 Antimony	0.146	0.031
115 Arsenic	0.156	0.008
117 Beryllium	<0.003	<0.003
118 Cadmium	0.512	0.020
119 Chromium	4.750	0.050
120 Copper	0.220	0.030
122 Lead	<0.020	<0.020
123 Mercury	0.003	0.004
124 Nickel	0.450	0.130
125 Selenium	<0.005	<0.005
126 Silver	0.060	0.020
127 Thallium	<0.030	<0.030
128 Zinc	11.409	0.289
<u>NON-CONVENTIONAL POLLUTANTS</u>		
Calcium	595.207	240.200
Magnesium	201.602	52.730
Aluminum	3.777	0.090
Manganese	1.847	0.107
Vanadium	1.240	0.368
Boron	0.357	0.361
Barium	0.293	0.091
Molybdenum	1.096	0.128
Tin	0.332	0.023
Europium	<0.1	<0.05
Yttrium	0.511	0.005
Cobalt	1.497	0.096
Iron	191.288	4.237
Titanium	0.127	0.005
<u>CONVENTIONAL POLLUTANTS</u>		
Total Suspended Solids	730	45

TABLE 5-8
TV PHOSPHOR WASTES
PLANT 102

Stream Identification	Luminescent Material Waste	Final Plant Effluent
Sample Number	1	2
Flow Rate Liters/Hr/Gallon/day	4360/9000 mg/l	39430/250000 mg/l
<u>TOXIC ORGANICS</u>		
23 Chloroform	0.005	
66 Bis(2-ethylhexyl)phthalate	0.060	0.260
68 Di-N-butyl phthalate	0.006	
86 Toluene		0.010
87 Trichloroethylene		0.060
Total Toxic Organics	0.060	0.33
121 Cyanide	<0.002	0.004
<u>TOXIC INORGANICS</u>		
114 Antimony	0.021	0.008
115 Arsenic	<0.005	<0.005
117 Beryllium	<0.005	<0.005
118 Cadmium	0.216	0.200
119 Chromium	<0.025	0.200
120 Copper	0.005	0.325
122 Lead	0.009	0.004
123 Mercury	<0.001	<0.001
124 Nickel	<0.025	0.190
125 Selenium	<0.005	<0.005
126 Silver	<0.015	0.015
126 Thallium	0.027	0.038
128 Zinc	8.450	0.468
<u>NON-CONVENTIONAL POLLUTANTS</u>		
Phenols	0.012	
Total Organic Carbon	31	6.8
<u>CONVENTIONAL POLLUTANTS</u>		
pH @ 23°C	11.1	6.8
Oil & Grease	6.4	8.0
Biochemical Oxygen Demand	1,160	8
Total Suspended Solids	91	12

TABLE 5-9
LAMP PHOSPHOR WASTES
PLANT 103

Stream Identification	Special Phosphors Wastes	Lamp Phosphor Wastes
Sample Number	1	2
Flow Rate Liters/Hr-Gallon/day	79/500	790/5000
	mg/l	mg/l

TOXIC ORGANICS

1 Acenaphene	<0.010	
4 Benzene	<0.010	<0.010
23 Chloroform	<0.010	<0.010
39 Fluoranthene	<0.010	
44 Methylene Chloride	0.160	0.150
66 Bis(2-ethylhexyl)phthalate	<0.010	<0.010
67 Butyl Benzyl phthalate	<0.160	<0.010
68 Di-N-butyl phthalate	<0.010	0.011
70 Diethyl phthalate	0.036	0.260
78 Anthracene	<0.010	0.010
81 Phenanthrene	<0.010	<0.010
84 Pyrene	<0.010	
86 Toluene		0.018
106 PCB-1242	0.008	
Total Total Organics	0.196	0.439
Cyanide	0	0

TOXIC INORGANICS

114 Antimony	0.009	7.278
115 Arsenic	0.006	0.021
117 Beryllium	0.075	<0.001
118 Cadmium	0.091	10.270
119 Chromium	0.266	0.047
120 Copper	0.419	0.069
122 Lead	1.070	0.063
123 Mercury	0.003	0.004
124 Nickel	3.272	0.536
125 Selenium	<0.005	<0.005
126 Silver	0.070	0.010
127 Thallium	<0.030	<0.030
128 Zinc	7.011	2.449

NON-CONVENTIONAL POLLUTANTS

Calcium	8.672	432.007
Magnesium	3.016	2.070
Sodium		4.771
Aluminum	3.854	0.115
Manganese	0.428	14.060
Vanadium	14.812	0.034
Boron	49.802	0.053
Barium	0.230	0.283
Molybdenum	0.462	0.030
Tin	0.286	0.012
Yttrium	10.605	0.019
Cobalt	0.117	0.010
Iron	1.399	0.516
Titanium	0.079	0.010
Total Organic Carbon	98	43
Fluoride	1.5	12

CONVENTIONAL POLLUTANTS

Oil & Grease	29	0
Total Suspended Solids	270	215

Antimony -- used as an activator in the manufacture of lamp phosphors was detected at a high concentration in one raw waste stream.

Cadmium and Zinc -- as the major metals found in blue (Zn) and green (Zn, Cd) TV phosphors, occur as sulfides in the intermediate and final products. Therefore they appear in wastewaters from all washing and filtering operations in the production of blue and green phosphors.

Other toxic metals which are used in very small amounts as activators (arsenic in lamp phosphors and silver and copper in TV phosphors) were detected in very low concentrations.

Toxic Organics -- in the form of phthalate esters, were found in significant concentrations in several process wastes. According to industry personnel, phthalates are not used in the manufacturing process. The presence of these organics may be due to sample contamination, since they also occurred in significant concentrations in sample blanks, or they may result from the use of plastic storage containers.

5.4 RECEIVING AND TRANSMITTING TUBES

No plants were sampled in the Receiving and Transmitting Tube Subcategory. Information obtained from plant surveys and industry contacts indicated that wastewater generated by the Receiving and Transmitting Tube subcategory results primarily from processes associated with metal finishing operations.

SECTION 6

SUBCATEGORIES AND POLLUTANTS TO BE REGULATED, EXCLUDED OR DEFERRED

This section cites the E&EC subcategories which are being (1) regulated or (2) excluded from regulation. In addition, this section explains, for those subcategories being regulated, which pollutants are being regulated and which pollutants are being excluded from regulation.

6.1 SUBCATEGORIES TO BE REGULATED

Based on wastewater characteristics presented in Section 5, discharge effluent regulations are being proposed for the Cathode Ray Tube and Luminescent Materials subcategories.

6.1.1 Pollutants to be Regulated

The specific pollutants selected for regulation in these subcategories are: Cathode Ray Tubes - cadmium, chromium, lead, zinc, fluoride, TSS, pH and TTO; and Luminescent Materials - cadmium, zinc, antimony, fluoride, TSS and pH. The rationale for regulating these pollutants is presented below.

(pH) Acidity or Alkalinity

During cathode ray tube and luminescent materials manufacture, both high and low pH levels may occur. High pH results from caustic cleaning operations or caustics used in wet scrubbers while low pH results from the use of acids for etching and cleaning operations.

Although not a specific pollutant, pH is a measure of acidity or alkalinity of a wastewater stream. The term pH is used to describe the hydronium ion balance in water. Technically, pH is the negative logarithm of the hydrogen ion concentration. A pH of 7 indicates neutrality, a balance between free hydrogen and free hydroxyl ions. A pH above 7 indicates that the solution is alkaline, while a pH below 7 indicates that the solution is acidic.

Waters with a pH below 6.0 are corrosive to water works structures, distribution lines, and household plumbing fixtures; this corrosion can add constituents to drinking water such as iron, copper, zinc, cadmium, and lead. Low pH waters not only tend to dissolve metals from structures and fixtures, but also tend to redissolve or leach metals from sludges and bottom sediments. Waters with a pH above approximately 9.0 can induce corrosion of certain metals, are detrimental to most natural organic materials, and are toxic to some living organisms.

Total Suspended Solids (TSS)

Total suspended solids found in cathode ray tube manufacture wastewater result primarily from graphite emulsions (DAG) used to coat the inner and outer surfaces of glass panels and funnels. Sources include both manufacture and salvage cleaning operations. The average concentration of TSS in CRT wastewaters is 185 mg/l. TSS concentrations in the wastewater from the manufacture of luminescent materials average 1,440 mg/l. These solids consist primarily of precipitated product materials and raw material impurities. Major sources are washing and filtration operations and wet scrubber wastes.

Suspended solids increase the turbidity of water, reduce light penetration, and impair the photosynthetic activity of aquatic plants. Solids, when transformed to sludge deposit, may blanket the stream or lake bed and destroy the living spaces for those benthic organisms that would otherwise occupy the habitat.

Total Toxic Organics (TTO)

Total toxic organics (TTO) are found in the wastewaters from cathode ray tube facilities. TTO is considered the sum of the concentrations of toxic organics listed in Table 6-1 which are found at concentrations greater than 0.01 milligrams per liter. These organics result from the use of solvents (e.g., methylene chloride, trichloroethylene) for cleaning and degreasing operations and from toluene-based lacquer coatings applied as a sealant over phosphor coatings. Maximum TTO concentrations of 1.54 milligrams per liter were found in the process wastes from cathode ray tube facilities.

Table 6-1
Pollutants Comprising Total Toxic Organics

Toxic Pollutant No.

11	1,1,1-trichloroethane	66	bis(2-ethylhexyl)phthalate
23	chloroform	86	toluene
44	methylene chloride	87	trichloroethylene

Antimony

Antimony is being regulated only in the Luminescent Materials Subcategory. It is used in small amounts as an activator in the manufacture of lamp phosphors and was detected at a high concentration in a sampled raw waste stream. The mean concentration of antimony for luminescent materials facilities was 2.69 milligrams per liter.

Antimony compounds are poisonous to humans and are classed as acutely moderate or chronically severe. Antimony can be

concentrated by certain forms of aquatic life to over 300 times the background concentrations. In tests on various fish and aquatic life, the salts of antimony give mixed results on toxicity dependent on the salt, temperature, hardness of the water, and dissolved oxygen present.

Cadmium

Cadmium is found in the wastewater from both cathode ray tube and luminescent materials facilities at mean concentrations of 0.374 milligrams per liter and 4.06 milligrams per liter, respectively. Cadmium is one of the major metals found in blue and green TV phosphors and appears in wastewaters from all washing and filtering operations in the production of these phosphors. In the CRT industry, cadmium results from manufacture, salvage and phosphor recovery operations.

Cadmium is a cumulative toxicant, causing progressive chronic poisoning in mammals, fish and other animals. It is known to have marked acute and chronic effects on aquatic organisms. The compound is highly concentrated by marine organisms, primarily molluscs. The eggs and larvae of fish are apparently more sensitive than adult fish to poisoning by cadmium, and crustaceans appear to be even more sensitive than fish eggs and larvae. Cadmium in drinking water supplies is extremely hazardous to humans, and conventional treatment does not remove it. It also acts synergistically with other metals; copper and zinc substantially increase its toxicity.

Chromium

Chromium is found in the wastewaters from the Cathode Ray Tube Subcategory. It occurs as dichromate in photosensitive materials used to prepare glass surfaces for phosphor application. The mean concentration of chromium in wastewater from manufacture and salvage operations was 1.31 milligrams per liter.

Chromium is considered hazardous to man, producing lung tumors when inhaled and inducing skin sensitizations. The toxicity of chromium salts to fish, and other aquatic life varies widely with the species, temperature, pH, valence of chromium and synergistic or antagonistic effects. It appears that fish food organisms and other lower forms of aquatic life are extremely sensitive to chromium, which also appears to inhibit algal growth.

Lead

Lead is being regulated in the Cathode Ray Tube Subcategory. It is present in the solder or frit used to fuse glass panels and funnels together. The major sources of lead in CRT wastewaters are tube salvage operations where acids are used to dissolve the frit and to clean the panels and funnels. The mean concentration of lead for CRT facilities was 9.41 milligrams per liter.

Lead levels are cumulative in the human body over long periods of time with chronic ingestion of low levels causing poisoning over a period of years. Fish have been shown to have adverse effects from lead and lead salts in the environment. Small concentrations of lead may cause a film of coagulated mucus to form over the fish, leading to suffocation.

Zinc

Zinc is being regulated in both the Cathode Ray Tube and Luminescent Materials Subcategories. As with cadmium, zinc is one of the major toxic metals found in phosphors. Sources of zinc are therefore the same as discussed above for cadmium. Mean zinc concentrations for the two industries are 11.79 milligrams per liter (cathode ray tube) and 120.6 milligrams per liter (luminescent materials).

Zinc can have an adverse effect on man and animals at high concentrations while lower zinc levels in public water supply sources can cause an undesirable taste which persists through conventional treatment. The toxicity of zinc to fish has been shown to vary with fish species, age and condition, as well as with the physical and chemical characteristics of the water.

Fluoride

Fluoride is found in the wastewaters of cathode ray tube and luminescent materials facilities. The source of fluoride from CRT manufacture is the use of hydrofluoric acid for cleaning and conditioning glass surfaces. The mean concentration in CRT process wastes was 360.6. The source of fluoride from luminescent materials manufacture is an intermediate powder in lamp phosphor production. The mean concentration of fluoride at luminescent materials facilities was 356.5 milligrams per liter.

Although fluoride is not listed as a toxic pollutant, it can be toxic to livestock and plants, and can cause tooth mottling in humans. The National Academy of Sciences recommends: (1) two milligrams per liter as an upper limit for drinking water and watering livestock and, (2) one milligram per liter for continuous use as irrigation water on acid soils to prevent plant toxicity and reduced crop yield. Although some fluoride in drinking water helps to prevent tooth decay, EPA's National Interim Primary Drinking Water Regulations set limits of 1.4 to 2.4 milligrams per liter in drinking water to protect against tooth mottling.

6.2 TOXIC POLLUTANTS AND SUBCATEGORIES NOT REGULATED

The Settlement Agreement, explained in Section 2, contained provisions authorizing the exclusion from regulation, in certain circumstances, of toxic pollutants and industry categories and subcategories. These provisions have been rewritten in a Revised

Settlement Agreement which was approved by the District Court for the District of Columbia on March 9, 1979, NRDC v. Costle, 12 ERC 1833.

6.2.1 Exclusion of Pollutants

Nine (9) pollutants are being excluded from further regulation for both the Cathode Ray Tube and Luminescent Materials subcategories under Paragraph 8(a)(iii) because they are present in amounts too small to be effectively reduced by technologies known to the Administrator: arsenic, beryllium, copper, mercury, nickel, selenium, silver, thallium, and cyanide.

Table 6-2 presents one hundred and six pollutants which are being excluded from further regulation for both subcategories under Paragraph 8(a)(iii) because they were not detected in the effluent.

Table 6-2

1. Acenaphthene
2. Acrolein
3. Acrylonitrile
4. Benzene
5. Benzidine
6. Carbon Tetrachloride
7. Chlorobenzene
8. 1,2,4 Trichlorobenzene
9. Hexachlorobenzene
10. 1,2-Dichloroethane
11. Hexachloroethane
12. 1,1-Dichloroethane
13. 1,1,2-Trichloroethane
14. 1,1,2,2-Tetrachloroethane
15. Chloroethane
16. Bis(2-Chloroethyl)Ether
17. 2-Chloroethyl Vinyl Ether (Mixed)
18. 2-Chloronaphthalene
19. 2,4,6 Trichlorophenol
20. Parachlorometa Cresol
21. 2-Chlorophenol
22. 1,2-Dichlorobenzene
23. 1,3-Dichlorobenzene
24. 1,4-Dichlorobenzene
25. 3,3'-dichlorobenzidine
26. 1,1-Dichloroethylene
27. 1,2-Trans-Dichloroethylene
28. 2,4-Dichlorophenol
29. 1,2-Dichloropropane
30. 1,2-Dichloropropylene
31. 2,4-Dimethylphenol
32. 2,4-Dinitrotoluene

33. 2,6-Dinitrotoluene
34. 1,2-diphenylhydrazine
35. Ethylbenzene
36. Fluorathene
37. 4-Chlorophenyl Phenyl Ether
38. 4-Bromophenyl Phenyl Ether
39. Bis(2-chloroisopropyl) Ether
40. Bis-(2-chloroethoxy) Methane
41. Methyl Chloride
42. Methyl Bromide
43. Bromoform
44. Dichlorobromomethane
45. Chlorodibromomethane
46. Hexachlorobutadiene
47. Hexachlorocyclopentadiene
48. Isophorone
49. Naphthalene
50. Nitrobenzene
51. 2-Nitrophenol
52. 4-Nitrophenol
53. 2,4-dinitrophenol
54. 2,6-dinitro-o-cresol
55. N-nitrosodimethylamine
56. N-nitrosodiphenylamine
57. N-nitrosodi-n-propylamine
58. Pentachlorophenol
59. Phenol
60. Butyl Benzyl phthalate
61. Di-n-butyl phthalate
62. Di-n-octyl phthalate
63. Diethyl phthalate
64. Dimethyl phthalate
65. Benzo(a)anthracene
66. Benzo(a)pyrene
67. 3,4-benzofluorathene
68. Benzo(k)fluoranthane
69. Chrysene
70. Acenaphthylene
71. Anthracene
72. Benzo(ghi)perylene
73. Fluorene
74. Phenanthrene
75. Dibenzo(a,h)anthracene
76. Indeno(1,2,3-cd)pyrene
77. Pyrene
78. Tetrachloroethylene
79. 2,3,7,8-tetrachlorodibenzo-p-dioxin
80. Vinyl Chloride
81. Aldrin
82. Cieldrin
83. Chlordane
84. 4,4'-DDT
85. 4,4'-DDE

86. 4,4'-DDD
87. A-endosulfan-Alpha
88. B-endosulfan-Beta
89. Endosulfan Sulfate
90. Endrin
91. Endrin Aldehyde
92. Heptachlor
93. Heptachlor Epoxide
94. A-BHC-Alpha
95. B-BHC-Beta
96. D-BHC-Delta
97. G.BHC-Gamma
98. PCB-1242
99. PCB-1254
100. PCB-1221
101. PCB-1232
102. PCB-1248
103. PCB-1260
104. PCB-1016
105. Toxaphene
106. Asbestos

For the Cathode Ray Tube subcategory only, an additional toxic pollutant, antimony, is being excluded from further regulation under Paragraph 8(a)(iii), because it was found in amounts too small to be effectively treated.

In the Luminescent Materials subcategory, the six (6) additional toxic pollutants listed in Table 6-1 are being excluded from regulation under Paragraph 8(a)(iii) because EPA believes they are not present at detectable concentrations using state-of-the-art analytical methods. Two additional toxic pollutants are being excluded under paragraph 8(a)(iii). These are lead and chromium which were not detected in effluents from this subcategory.

6.2.2 Exclusion of Subcategories

All subcategory exclusions are based on either Paragraph 8(a)(i), or Paragraph 8(a)(iv) of the Revised Settlement Agreement. Paragraph 8(a)(i) permits exclusion of a subcategory for which "equally or more stringent protection is already provided by an effluent, new source performance, or pretreatment standard or by an effluent limitation. . ." Paragraph 8(a)(iv) permits exclusion of a category or subcategory where "the amount and the toxicity of each pollutant in the discharge does not justify developing national regulations . . ." These exclusions are supported by data and information presented in Section 5.

The Receiving and Transmitting Tube Subcategory is being excluded from regulation under the provisions of Paragraph 8(a)(i) on the basis that the assembly of these tubes is a dry process. Those

unit operations which use water for cleaning, degreasing, and plating are covered under metal finishing limitations.

Existing direct dischargers in the Cathode Ray Tube Subcategory are being excluded from regulation under the provisions of Paragraph 8(a)(iv). Only one plant of the 24 plants in the Cathode Ray Tube subcategory is a direct discharger and that plant has precipitation/clarification plus filtration treatment in place. The discharge of toxic pollutants is insignificant, less than 2 pounds/day after current treatment.

All existing dischargers in the Luminescent Materials Subcategory are being excluded from regulation. Of the five plants in this subcategory, only two are direct dischargers. These two plants discharge after treatment less than one pound/plant of toxic metals per day. For this reason, exclusion under the provision fo paragraph 8(a)(iv) is proposed. In the case of the indirect dischargers, exclusion under the provision of paragraph 8(b)2 is proposed on the basis that the amount of toxic pollutants introduced into POTW's is insignificant.

6.3 CONVENTIONAL POLLUTANTS NOT REGULATED

BOD, and oil and grease are not being regulated for either subcategory because they were found at concentrations below treatability. BOD was found at an average of 7.4 milligrams per liter in cathode ray tube facilities and 5 milligrams per liter in luminescent materials plants; oil and grease was found at an average concentration of 7.7 milligrams per liter in cathode ray tube plants and 3.0 milligrams per liter in luminescent materials plants; and fecal coliform was not present in the process discharge from either subcategory.

SECTION 7

CONTROL AND TREATMENT TECHNOLOGY

The wastewater pollutants of concern generated by the manufacture of cathode ray tubes and luminescent materials are identified by the processes described in Section 5. They are pH, suspended solids, fluoride, antimony, chromium, cadmium, lead, zinc, and toxic organics. A discussion of the treatment technologies currently practiced and most applicable for the reduction of these pollutants is presented below. It is followed by an identification of three recommended treatment and control systems and an analysis of the performance of these systems.

7.1 CURRENT TREATMENT AND CONTROL PRACTICES

Pollutant control technologies currently used in the cathode ray tube and luminescent materials industries include both in-process and end-of-pipe technologies. In-process waste control technologies are meant to remove pollutants from process wastewater by treatment at some point in the manufacturing process, or to limit the introduction of pollutants into process wastewater by control techniques. End-of-pipe treatment is wastewater treatment at the point of discharge.

7.1.1 Cathode Ray Tube Subcategory

In-process Control -- In-process control techniques with widespread use in this subcategory are collection of spent solvents for resale, reuse or disposal, and segregation of other waste streams for treatment or contract hauling; i.e., the industry practice of contracting a firm to collect and transport wastes for off-site disposal.

Available data and information indicate that all color television tube manufacturing plants collect spent solvents for either contractor disposal or reclamation. One plant does not use solvents for a degreasing operation, but rather uses alkaline cleaners. In addition information from several smaller CRT manufacturers indicates that these plants collect and contract haul their solvent wastes. Two plants also have their lead-bearing nitric acid wastes contract-hauled. Four plants have in-process treatment of chromium wastes, and two of these plants also have in-process treatment of strong lead-bearing wastes.

End-of-Pipe Treatment -- Six plants in the Cathode Ray Tube Subcategory use end-of-pipe precipitation/clarification for control of toxic metals, and two plants have combined treatment systems designed to treat CRT process wastes along with metal finishing wastes from other plant manufacturing operations. One plant, which currently only neutralizes its discharge, is planning a new treatment system for control of metals. The one

direct discharger in this subcategory also filters its treated process wastewater after treating it by precipitation/clarification. Some facilities only neutralize their wastes. In addition, some small plants have provisions for solids removal prior to discharge.

7.1.2 Luminescent Materials Subcategory

In the Luminescent Materials Subcategory the two direct dischargers have combined end-of-pipe treatment systems that utilize precipitation/clarification technologies. Of the three other plants in the subcategory, one plant achieves zero discharge through the use of an evaporation pond, one plant neutralizes its wastes at end-of-pipe and the third plant uses precipitation/clarification technology to control toxic metals prior to discharge.

7.2 APPLICABLE TREATMENT TECHNOLOGIES

7.2.1 pH Control

Acids and bases are commonly used in the production of cathode ray tubes and luminescent materials. They result in process waste streams exhibiting high or low pH values. Acids and bases are used frequently in cleaning operations for cathode ray tube manufacture. In the production of luminescent materials, acids are used to dissolve raw materials and bases are used in alkaline scrubbers.

There are several methods that can be used to treat acidic or basic wastes resulting in a pH of 6-9. These methods include mixing acidic and basic wastes, and neutralizing high pH streams with acid or low pH streams with bases. The method of neutralization used is generally selected on the basis of overall cost. Process waters are treated either continuously or on a batch basis. Neutralization can be used alone but is often used in conjunction with precipitation of metals.

Hydrochloric or sulfuric acid may be used to neutralize alkaline wastewaters, however, sulfuric acid is most often chosen because of its lower cost.

Sodium hydroxide (caustic soda), sodium carbonate (soda ash), or calcium hydroxide (lime) may be used to neutralize acidic wastewater. The factors considered in selection include price, neutralization rate, storage and equipment costs, and neutralization end products. Sodium hydroxide is more expensive than most other alkalies but is often selected due to its ease of storage, rapid reaction rate and the solubility of its end product.

7.2.2 Toxic Metals Treatment

Toxic metals appear in process wastewaters from the manufacture of luminescent materials and cathode ray tubes. Zinc and cadmium are major constituents of luminescent materials and, as such, appear in most process waste streams at luminescent materials manufacturing plants and in many waste streams at cathode ray tube plants. Lead, found in the solder used to fuse cathode ray tube panels and funnels, appears in tube salvage wastes at these plants. Chromium, a constituent of photoresist materials, is found in the hexavalent form in several wastes at cathode ray tube plants.

The most commonly used method to remove toxic metals from wastewaters is to precipitate the metals as hydroxides or carbonates and then remove the insoluble precipitates by clarification or settling.

Hydroxide precipitation uses lime or caustic soda to supply the hydroxide ions. The chemistry of the process is simple but must be understood for each metal. To the degree that pH approaches the optimum point, treatment will tend to avoid forming soluble complexes. A simple form of the reaction may be written as:



The treatment levels attainable by hydroxide precipitation can be forecast from a knowledge of the pH system. Figure 7-1 shows the theoretical solubility of those toxic metals which form insoluble hydroxides. It is clear from the figure that for wastewaters containing more than one metal, optimum pH cannot be achieved for each metal. Instead optimum pH for the total waste stream must be based on the comparative concentrations of each metal of concern. For successful application as a wastewater treatment technology, careful control of pH must be practiced if the best removals are to be achieved. Effluent data indicate that pH can be maintained at levels that allow all regulated metals to be controlled effectively at the same time. In practice, hydroxide precipitation is often supplemented by the use of coagulating agents to improve solids removal.

Sodium carbonate is often used for specific treatment of lead-bearing wastes. Lead carbonate precipitates (or lead/hydroxide/carbonate precipitates if hydroxides are also used) are formed. This allows improved settling characteristics for lead.

Hydroxide precipitation has proven to be an effective technique for removing many pollutants from industrial wastewater. Metal ions are precipitated as hydroxides and fluoride is precipitated as insoluble calcium fluoride. The system operates at ambient conditions and is well suited to automatic control. Lime is usually added as a slurry when used in hydroxide precipitation. The slurry must be kept well mixed and the addition lines periodically checked to prevent blocking, which may result from a

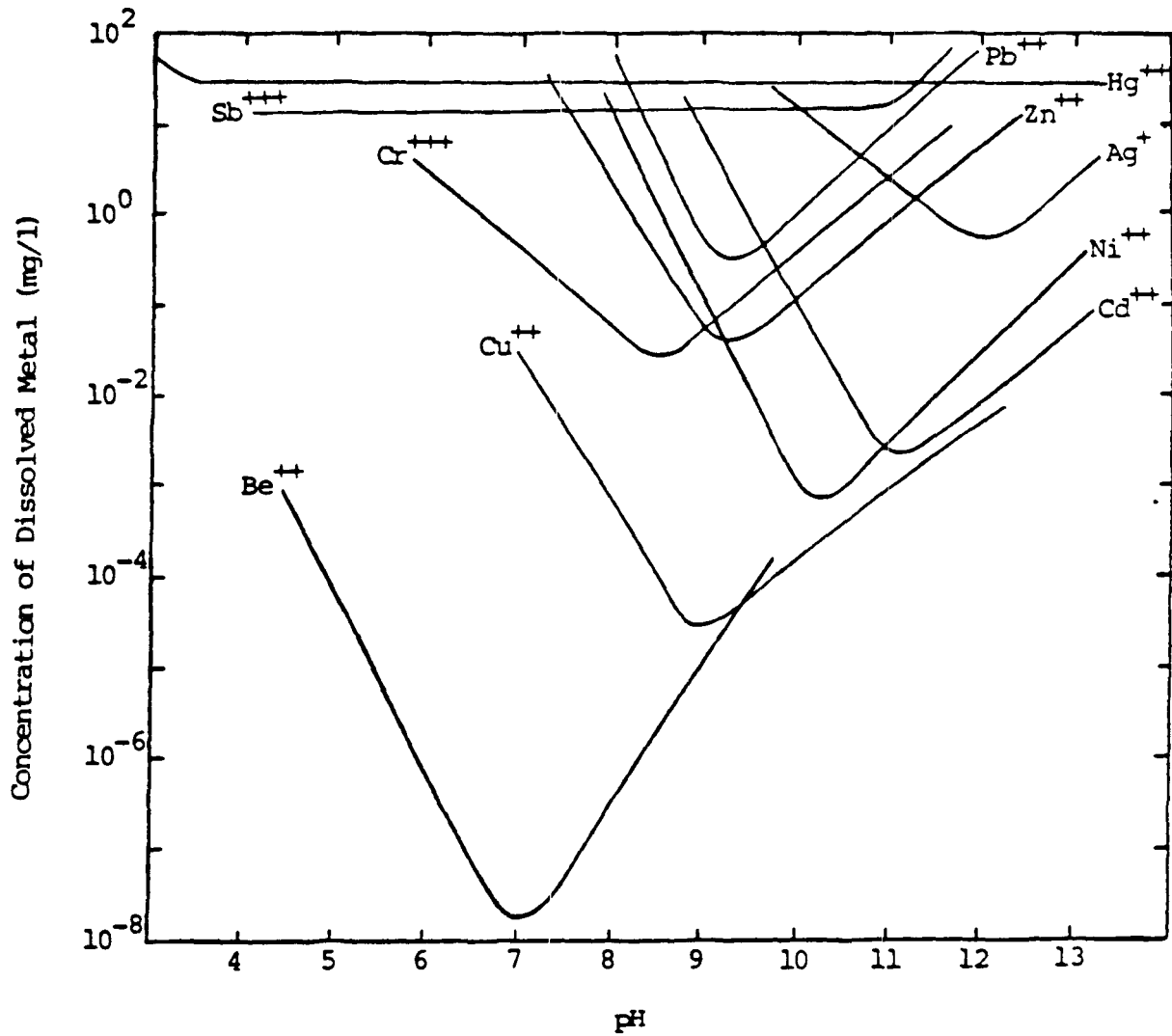

FIGURE 7-1

Theoretical solubilities of toxic metal hydroxides/oxides as a function of pH.

NOTE: Solubilities of metal hydroxides/oxides are from data by M. Pourbaix, Atlas of Electrochemical Equilibria in Aqueous Solutions, Pergamon Press, Oxford, 1966.

build-up of solids. The use of hydroxide precipitation does produce sludge requiring disposal following precipitation.

The performance of a precipitation system depends on several variables. The most important factors affecting precipitation effectiveness are:

1. Addition of sufficient excess chemicals to drive the precipitation reaction to completion. If treatment chemicals are not present in slight excess of the required stoichiometric amount, some pollutants will remain dissolved in the waste stream.
2. Maintenance of an alkaline pH throughout the precipitation reaction and subsequent settling.
3. Effective removal of precipitated solids.

The process of removing suspended solids or precipitates by gravitational forces is referred to as sedimentation and may be conducted in a settling tank, clarifier or lagoon. The operation is effected by establishing quiescent conditions so that gravitational settling can occur. High retention times are generally required. Accumulated sludge can be collected and removed either periodically or continuously and either manually or mechanically.

Inorganic coagulants or polyelectrolytic flocculants are added to enhance coagulation. Common inorganic coagulants include sodium sulfate, sodium aluminate, ferrous or ferric sulfate, and ferric chloride. Organic polyelectrolytes vary in structure, but all usually form larger floccules than coagulants used alone.

The use of a clarifier for sedimentation reduces space requirements, reduces retention time, and increases solids removal efficiency. Conventional clarifiers generally consist of a circular or rectangular tank with a mechanical sludge collecting device or with a sloping funnel-shaped bottom designed for sludge collection. In advanced clarifiers, inclined plates, slanted tubes, or a lamellar network may be included within the clarifier tank in order to increase the effective settling area. A more recently developed "clarifier" utilizes centrifugal force rather than gravity to effect the separation of solids from a liquid. The precipitates are forced outward and accumulate against an outer wall, where they can later be collected. A fraction of the sludge stream is often recirculated to the clarifier inlet, promoting formation of a denser sludge.

The major advantage of simple sedimentation is the simplicity of the process itself - the gravitational settling of solid particulate waste in a holding tank or lagoon. The major disadvantage of sedimentation involves the long retention times necessary to achieve complete settling, especially if the

specific gravity of the suspended matter is close to that of water.

A clarifier is more effective in removing slow settling suspended matter in a short time and in less space than a simple sedimentation system. Also, effluent quality is often better from a clarifier. The cost of installing and maintaining a clarifier is however, substantially greater than the costs associated with sedimentation lagoons.

Depending on the quantity of waste flow, the treatment can either be a batch or continuous operation, with batch treatment favored for small flows. In batch treatment the equipment usually consists of two tanks, each with the capacity to direct the total wastewater volume. For large daily flows, a typical continuous flow scheme consists of an equalization tank, flash mixer, flocculator, settling unit or clarifier and a sludge thickening unit.

7.2.3 Fluoride Treatment

Fluoride appears in cathode ray tube manufacture wastewater because of the use of hydrofluoric acid for cleaning and conditioning glass surfaces. In the production of luminescent materials fluoride appears as ammonium bifluoride in the raw material used, and as calcium fluoride in intermediate and final products.

The most common treatment procedure practiced today in the United States for reducing the fluoride concentration in wastewater is precipitation by the addition of lime (Ca(OH)_2) followed by clarification. That addition forms calcium fluoride by the following reaction:

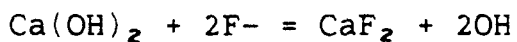

The theoretical solubility of calcium fluoride in distilled water is 7.8 mg fluoride ion per liter at 18°C. The precipitate forms slowly, requiring about 24 hours for completion and the solubility of calcium fluoride soon after its formation is about ten milligrams of fluoride per liter. Data indicates that the effectiveness of this treatment can be improved by the addition of calcium chloride which provides excess calcium for precipitating the fluoride.

Data from the Cathode Ray Tube Subcategory indicate that plants using precipitation and clarification treatment technologies are achieving a long-term average effluent concentration of 14.5 milligrams of fluoride per liter. Addition of a filtration unit would not further reduce the fluoride concentration significantly since 14.5 mg/l of fluoride is approximately equal to the dissolved calcium fluoride concentration soon after formation of the precipitate. It has also been shown in a treatability study

for the Hydrofluoric Acid Subcategory that dual media filtration following alkaline precipitation and settling is not generally effective for the reduction of fluoride. Insoluble, filterable calcium fluoride would probably constitute only a small fraction of the 14.5 mg/l fluoride.

7.2.4 Filtration

A filtration unit can achieve further removal of fine precipitates. Filtration is basic to water treatment technology, and experience with the process dates back to the 1800's. A filtration unit commonly consists of a container holding a granular filter medium or combination of media through which is passed the liquid stream. The unit can operate by gravity flow or under pressure. Silica sand, anthracite coal, and garnet are common filter media used in water treatment plants. These are usually supported by gravel. The multi-media filters may be arranged to maintain relatively distinct layers by virtue of balancing the forces of gravity, flow and buoyancy on the individual particles. This is accomplished by selecting appropriate filter flow rates (gpm/sq ft), media grain size, and density. The flow pattern is usually top-to-bottom, but other patterns are sometimes used.

The usual granular bed filter operates by gravity flow. However, pressure filters are also used. Pressure filters permit higher solids loadings before cleaning and are advantageous when the filter effluent must be pressurized for further downstream treatment. In addition, pressure filter systems are often less costly for low to moderate flow rates.

The principal advantages of granular bed filtration are its low initial and operating costs and reduced land requirements over other methods to achieve the same level of solids removal. However, the filter may require pretreatment if the solids level is high (from 100 to 150 mg/l). Operator training costs may be fairly high due to controls and periodic backwashing.

Improvements in filter technology have significantly increased filtration reliability. Control systems, improved designs, and good operating procedures have made filtration a highly reliable method of wastewater treatment. Filters may be operated with either manual or automatic backwash. In either case, they must be periodically inspected for media attrition, partial plugging, and leakage. Filter backwash is generally recycled within the wastewater treatment system, so that the solids ultimately appear in the clarifier sludge stream for subsequent dewatering. Alternatively, the backwash stream may be dewatered directly. In this situation there is a solids disposal problem similar to that of clarifiers.

7.2.5 Chemical Chromium Reduction

Reduction is a chemical reaction in which electrons are transferred to the chemical being reduced from the chemical initiating the transfer (the reducing agent). Sulfur dioxide, sodium bisulfite, sodium metabisulfite, and ferrous sulfate form strong reducing agents in aqueous solution and are, therefore, useful in industrial waste treatment facilities for the reduction of hexavalent chromium to the trivalent form. The reduction enables the trivalent chromium to be separated from solution in conjunction with other metallic salts by alkaline precipitation. Gaseous sulfur dioxide is a widely used reducing agent and provides a good example of the chemical reduction process. Reduction using other reagents is chemically similar. The reactions involved may be illustrated as follows:

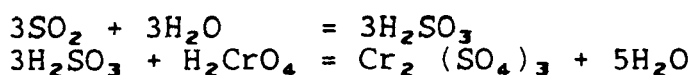

The above reaction is favored by low pH. A pH of 2 to 3 is normal for situations requiring complete reduction. At pH levels above 5, the reduction rate is slow. Oxidizing agents such as dissolved oxygen and ferric iron interfere with the reduction process by consuming the reducing agent.

A typical treatment consists of two hours retention in an equalization tank followed by 45 minutes retention in each of two reaction tanks connected in series. Each reaction tank has an electronic recorder-controller device to control process conditions with respect to pH and oxidation reduction potential (ORP). Gaseous sulfur dioxide is metered to the reaction tanks to maintain the ORP within the range of 250 to 300 millivolts. Sulfuric acid is added to maintain a pH level of 1.8 to 2.0. Each of the reaction tanks is equipped with a propeller agitator designed to provide approximately one turnover per minute. Following reduction of the hexavalent chromium, the waste is combined with other waste streams for final adjustment to an appropriate alkaline pH and sedimentation.

7.2.6 Total Toxic Organics Control

The sources of toxic organics in the Cathode Ray Tube Subcategory are solvents used for cleaning and degreasing operations and toluene-based coatings used to protect phosphors. They can enter wastewaters as a result of contamination of process streams or through dumping of spent solvents. The primary technique in this subcategory for controlling the discharge of toxic organics is the segregation of spent solvents for contract hauling (disposal) or for sale to companies which purify the solvents in bulk for resale. This control technology of solvent management also includes good housekeeping practices such as controlling leaks and spills. EPA also considered the use of carbon adsorption to control basic organics since it is used for this purpose in other industries.

Solvent Management - Solvent management refers to the practice of preventing spent solvents, containing toxic organics, from entering the plant wastewater streams. While a small amount of the solvents will enter the wastewaters through process contamination (e.g., drag out), plants substantially reduce toxic organic discharges by transferring the used solvents to tanks or drums for disposal. Transfer is done both manually and mechanically through minor piping modifications.

Available data and information show that the above practice of collecting solvents is done at all plants to some degree. The effectiveness of solvent management (i.e., the effluent reduction of toxic organics achieved) depends upon the extent to which plants collect the spent solvents and the extent to which they are handled properly in transferring the spent solvents to tanks and drums for disposal. Plants with the best solvent management programs use well designed segregation controls or practices to minimize solvent spills into rinse or other process streams, have some type of system for collecting routine spills and leaks during handling, and have implemented rigorous employee training programs.

A number of CRT plants have demonstrated that solvent management will reduce toxic organic discharges to low concentrations. This in-process control is effective because it reduces the sources of toxic organics in the effluent to that of contaminated process wastewater streams (e.g., drag out). Available data show that contaminated process streams contribute a very small amount of toxic organics to the effluent and this amount of toxic organics is difficult to reduce or eliminate because the concentrations approximate the level of treatability.

In addition to being relatively inexpensive, especially when compared to more sophisticated end-of-pipe treatment such as carbon absorption, solvent management has another advantage. After plants have collected the spent solvents in tanks or drums for disposal, they are able to sell the solvents to companies which purify the used solvents in bulk and then resell these solvents. (Note: Names of some companies which provide this reclaim service can be found in the public record for the electrical and electronic components regulation.) The revenue obtained from the sale of these solvents can in some cases offset the costs of collecting the solvents.

Carbon Adsorption -- Another applicable technology for the control of toxic organic discharges is end-of-pipe treatment using carbon adsorption. Frequently used in advanced wastewater treatment, adsorption is a process in which soluble substances become chemically or physically bonded to a solid surface. In operation, wastewater relatively free of suspended matter is passed through a chamber containing activated carbon which has a high capacity for adsorbing organic substances from the stream.

Once the capacity of the carbon is exhausted, it must be replaced or regenerated.

The effectiveness of carbon in removing specific organics varies and is dependent on molecular weight and polarity of the molecules, and on operating conditions such as contact time, temperature and carbon surface area. Table 7-1 presents the theoretical treatability using activated carbon for the 6 toxic organics found in CRT wastewaters.

Four of the six toxic organics have estimated treatabilities between 0.10 and 1.0 milligrams per liter. The other two toxic organics are theoretically treatable by activated carbon to 0.05 and 0.01 milligrams per liter.

In order to assess the effectiveness of using activated carbon for removal of toxic organics, the Agency used a model plant approach. Data from wastewater sampling in these subcategories have shown that only a few toxic organics occur in any particular plant effluent. The estimated lower limit would consist of a plant having one of the four most difficult pollutants to treat and two organics that can be reduced to 0.05 and 0.01 mg/l. An estimated upper limit could be approximated from a plant having all four of the most difficult pollutants to treat and the remaining 2 reducible to 0.05 and 0.01 mg/l. The TTO effluent concentrations based on these occurrences would range from 0.56 mg/l to 2.06 mg/l.

Because this range approximates the TTO effluent level achievable by solvent management, the use of carbon adsorption would result in minimal, if any additional removal of toxic organics beyond solvent management. While plants could use carbon adsorption to achieve approximately the same effluent concentration of toxic organics as they could using solvent management, carbon adsorption is unlikely to be used since plants have found solvent management to be much less expensive, relatively simple to institute, and approximately as effective in controlling toxic organic discharges.

7.3 RECOMMENDED TREATMENT AND CONTROL SYSTEMS

Based on the pollutants of concern in the Cathode Ray Tube and Luminescent Materials Subcategories, applicable treatment technologies for the control of these pollutants, and the current technologies observed within the two subcategories, five options for control and treatment have been identified.

Option 1 treatment consists of neutralization for pH control.

Option 2 treatment consists of Option 1 treatment with the addition of: chemical precipitation and clarification of all metals-bearing process wastes using lime, calcium chloride (to control fluoride), a coagulant and/or polyelectrolyte, and sludge

TABLE 7-1
 TREATABILITY OF TOXIC ORGANICS
 USING ACTIVATED CARBON

<u>Toxic Pollutant</u>	<u>Treatability mg/l</u>
11 1,1,1-trichloroethane	0.1 - 1.0
23 chloroform	0.1 - 1.0
44 methylene chloride	0.1 - 1.0
66 bis(2-ethylhexyl) phthalate	0.010
86 toluene	0.050
87 trichloroethylene	0.1 - 1.0

dewatering. In addition, for the Cathode Ray Tube Subcategory, Option 2 treatment includes chromium reduction with the use of sulfuric acid and sodium bisulfite, and sodium carbonate precipitation and clarification for lead-bearing wastes. Option 2 is presented schematically in Figure 7-2, for CRTs and Figure 7-3 for Luminescent Materials.

Option 3 treatment consists of Option 2 treatment with the addition of multi-media filtration technology. Option 3 treatment is also depicted in Figure 7-2, for CRTs and Figure 7-3 for Luminescent Materials.

Option 4 (Cathode Ray Tube Subcategory only) consists of solvent management for control of toxic organics. Solvent management is not a treatment system, but rather an in-plant control to collect spent solvents for resale or contract disposal. EPA, therefore, considered it in conjunction with Options 1 through 3.

Option 5 (Cathode Ray Tube Subcategory only) adds end-of-pipe carbon adsorption for further removal of toxic organics.

7.4 ANALYSIS OF INDUSTRY PERFORMANCE DATA

The following subsections present data on the performance of in-plant treatment systems in the Cathode Ray Tube and Luminescent Materials Subcategories as they relate to the identified options presented in Section 7.3. Also presented are the results of analyses of available long-term effluent monitoring data and a discussion of the statistical methodology used to analyze the data.

7.4.1 Cathode Ray Tube Subcategory

Table 7-2 presents a summary (average influent and effluent concentrations) of the performance of Option 2 and Option 3 treatment technologies from results of the three-day samplings of three color television picture tube manufacturing plants.

Plant 30172 uses chromium reduction of concentrated chromium wastes and carbonate precipitation and settling of concentrated lead-bearing wastes. The effluents from these two treatment units are then combined with other process wastes and sent through a precipitation/clarification/filtration treatment system. The treatment system effluent is then combined with dilute process wastes and cooling water in a holding lagoon prior to direct discharge (see Figure 5-1). Sampling data from this plant were not used to derive toxic metals limits for Option 2 performance because not all wastewater sources of toxic metals at this plant do not pass through the precipitation/clarification treatment system (see Figure 5-1, showing that phosphor wastes bypass the clarification system). However, sampling data on the performance of the filtration unit (percent removals) were used to derive toxic metals limits for Option 3 performance. Effluent

OPTION 2

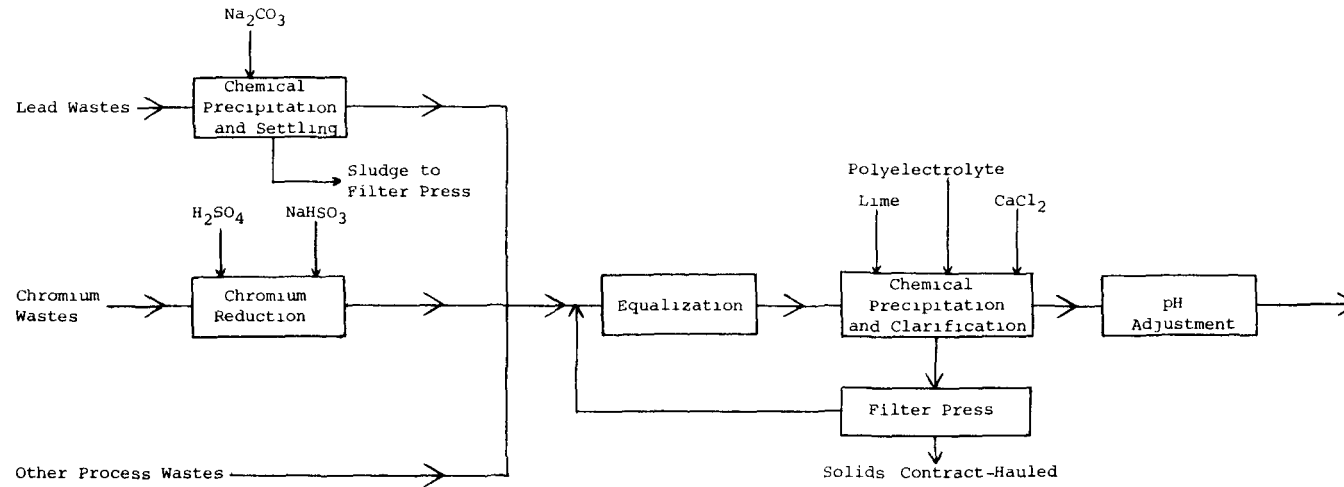

OPTION 3

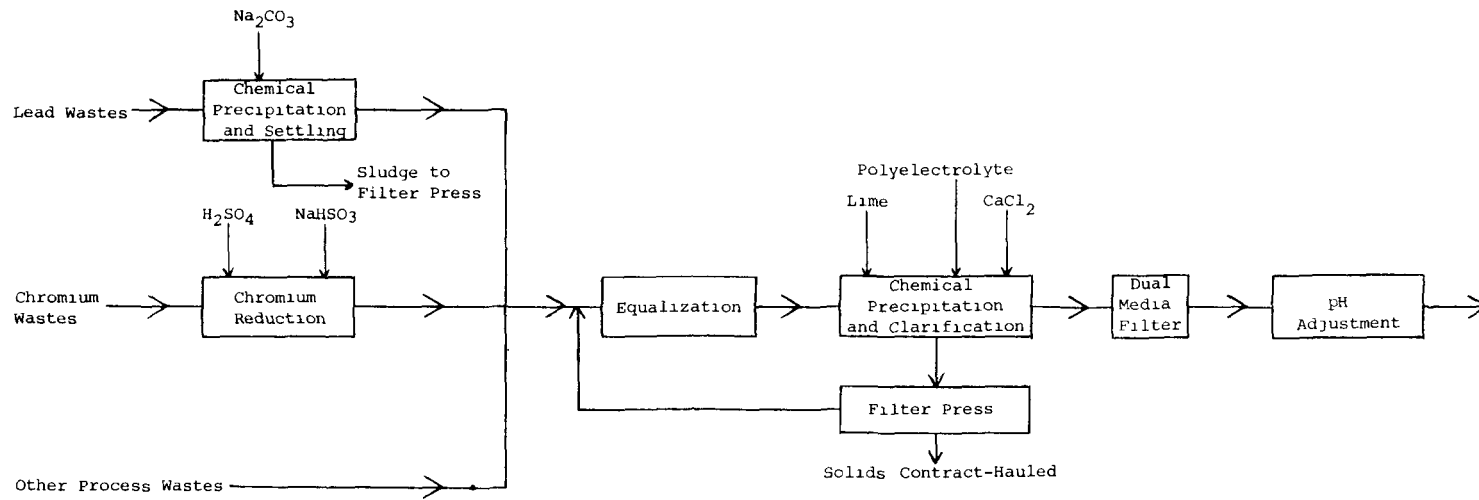
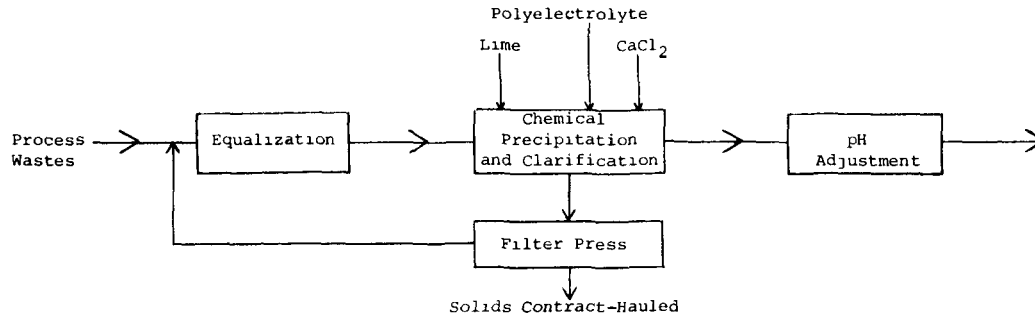

FIGURE 7-2
RECOMMENDED TREATMENT
CATHODE RAY TUBE SUBCATEGORY

OPTION 2



OPTION 3

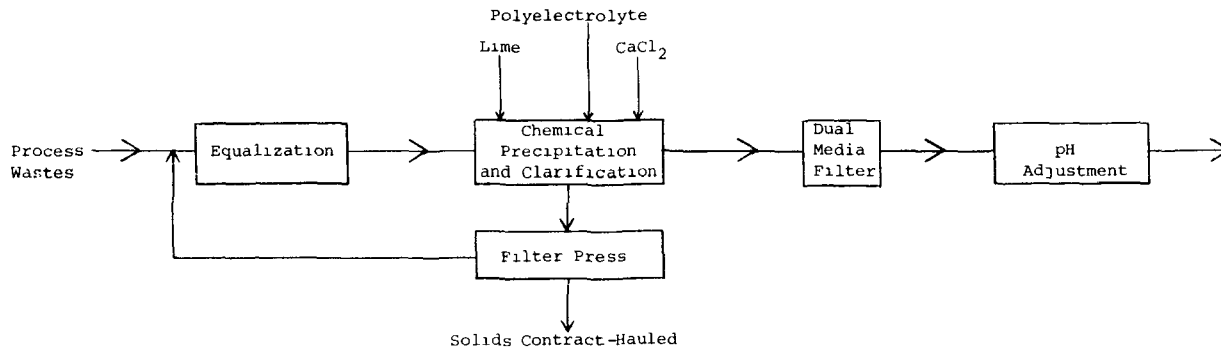

FIGURE 7-3
RECOMMENDED TREATMENT
LUMINESCENT MATERIALS SUBCATEGORY

TABLE 7-2

PERFORMANCE OF IN-PLACE TREATMENT
CATHODE RAY TUBE SUBCATEGORY (1)

Parameter	Option 2 Treatment				Option 3 Treatment	
	Lead Waste Treatment		Precipitation/ Clarification		Dual-Media Filtration	
	Inf. (mg/l)	Eff. (mg/l)	Inf. (mg/l)	Eff. (mg/l)	Inf. (mg/l)	Eff. (mg/l)
<u>PLANT 30172</u>						
<u>Toxic Metals</u>						
Cadmium	1.070	<0.005	0.171	<0.002	<0.002	<0.002
Chromium	4.670	0.022	2.87	0.244	0.244	0.208
Lead	891	1.2	14.2	0.253	0.253	0.163
Zinc	1510	18.7	6.08	0.131	0.131	0.075
<u>Other Pollutants</u>						
TSS	190	11	89	2.5	2.5	3.1
Fluoride	160	78.5	340	7.1	7.1	11.1
<u>PLANT 99796</u>						
<u>Toxic Metals</u>						
Cadmium			0.063	0.019		
Chromium			0.990	0.163		
Lead			13.0	0.300		
Zinc			19.7	0.550		
<u>Other Pollutants</u>						
TSS			380	15		
Fluoride			31.7	30.00		

(1) Data from Tables 5-3 and 5-5.

TTO sampling data (Appendix 3) submitted to the Agency by this facility were used to derive TTO limits since filters will achieve little additional removal of organics once most oil and grease has been removed by precipitation/clarification. Furthermore, since this plant had the highest reported usable TTO effluent data, it represented the maximum observed treated effluent TTO concentration resulting from unavoidable contaminations.

Plant 99796 performs chromium reduction on a chromium-bearing waste stream within a primary tank. A concentrated lead bearing waste is periodically batch discharged to the primary tank for treatment. Overflow from the primary tank is combined with a caustic stream in a secondary tank, lime is added, and the waste is sent through a clarification system. The treatment system effluent enters a holding lagoon prior to indirect discharge (see Figure 5-3). Sampling data from this plant were used in calculating limits for toxic metals. Data were not used for fluoride limits because the plant was not using calcium chloride to treat for fluoride.

Plant 11114, was also sampled. It is a color television picture tube plant which has three separate treatment systems serving different areas of the plant (see Figure 5-2). The sampling results indicated that, although some components achieve pollutant reduction, wastewater treatment is generally ineffective at Plant 11114. Fluoride for example, was present in the effluent at 480 mg/l. For this reason, treatment performance data from this plant were not used to calculate limits.

In addition to sampling data, long-term effluent self-monitoring data were submitted by five plants.

Plant 30172 (described above) submitted data based on monitoring its treatment system effluent following filtration. In addition, several phosphor waste streams bypass the plants clarifier and its filters (see figure 5-1). For both these reasons the data were generally not suitable for use in defining what toxic metals controls could be achieved by precipitation/clarification. However, the long-term data were used to derive limits for fluoride (Appendix 2). This was appropriate because fluoride levels are not affected significantly by filters (see discussion under fluoride treatment).

Plants 99797 and 99798 monitored the final effluents from their precipitation/clarification treatment systems. Data from Plant 99797, however, was considered to show poor treatment performance because of extremely high total suspended solids (TSS) levels in the effluent. Of 33 data points nine were over 100 mg/l, two were over 360 mg/l, and one exceeded 600 mg/l. By comparison other plants had data showing TSS consistently below 100 mg/l. Data from Plant 99798 were used to calculate fluoride and metals

limits (data are presented in Appendix 4), however it could not be used for TTO calculations since it submitted no TTO data.

The two other plants that submitted long-term effluent self monitoring data were not used to calculate limits for the following reasons: Plant 99796 self monitoring data was not used to calculate fluoride limits because, as noted above, the plant does not treat for fluoride with calcium chloride. Its self monitoring data were not used to calculate toxic metals limits because the self submitted data was based on sampling effluent from a large holding lagoon which allows additional removal of pollutants not included in Option 2 technology. In contrast, EPA's sampling data from that plant was based on effluent from the plants precipitation/clarification system. Wastewater treatment at Plant 11114 as discussed above, is generally ineffective.

Table 7-3 presents the results of statistical analyses of long-term and sampling data from the three plants that EPA visited. The derivation of the variability factors presented in Table 7-3 is discussed under statistical methodology in Section 7.4.3.

7.4.2 Luminescent Materials Subcategory

Table 7-4 presents a summary (average influent and effluent concentrations) of available Option 2 performance data for the Luminescent Materials Subcategory. Both Plants 101 and 102 have combined treatment systems which treat wastes from other manufacturing operations. The treatment systems consist of flow equalization, precipitation, clarification and pH adjustment. Influent and effluent data were taken on three days of sampling conducted under this study. Influent data was taken before and after process waste streams were combined for treatment.

7.4.3 Statistical Methodology

Introduction

To establish effluent guideline limitations for the Electrical and Electronic Components Phase 2 Category, the available data were examined to determine the performance levels that were attained by properly operated treatment systems in the category.

Two sources of pollutant concentration measurement data were available for this assessment; data that had been collected under the Agency's supervision and data that had been supplied by industry. The Agency's data consist of pollutant concentrations that had been measured in samples taken from untreated or raw influent wastewater streams and from treated effluent wastewater streams. The Agency's sampling was conducted in both cathode ray tube and luminescent materials plants over periods of one to three days.

TABLE 7-3

SUMMARY STATISTICS OF PLANTS USED FOR LIMITATION DEVELOPMENT
IN THE CATHODE RAY TUBE SUBCATEGORY

<u>POLLUTANT</u>	<u>SOURCE</u> ¹	<u>PLANT</u>	<u>N</u> ²	<u>AVERAGE</u> ³	<u>DAILY</u> ⁴ <u>VF</u>	<u>MONTHLY</u> ⁵ <u>VF</u>
Fluoride	IND	99798	20	12.6	2.16	1.21
	IND	30172	27	16.4	2.64	1.28
		Overall ⁶		14.5	2.40	1.25
Cadmium	EPA	99796	3	0.019	1.69	1.14
	IND	99798	20	0.020	3.85	1.46
		Overall ⁶		0.020	2.77	1.30
Chromium	EPA	99796	3	0.163	1.20	1.04
	IND	99798	20	0.294	4.50	1.55
		Overall ⁶		0.229	2.85	1.30
Lead	EPA	99796	3	0.300	2.16	1.22
	IND	99798	8	0.238	6.16	1.86
		Overall ⁶		0.269	4.16	1.54
Zinc	EPA	99796	3	0.550	3.37	1.42
	IND	99798	20	0.243	3.59	1.41
		Overall ⁶		0.397	3.48	1.42

-
- 1) SOURCE: indicates who conducted the wastewater sampling. IND is industry. EPA is the Agency.
 - 2) N: is the number of pollutant observations.
 - 3) AVERAGE: is the arithmetic average of all the values for a pollutant from a plant. Values that were recorded as below a detection limit were used in the average at the detection limit.
 - 4) DAILY VF: is the ratio of the estimate of the 99th percentile of the lognormally described daily values to an estimate of the expected or average pollutant concentrations.
 - 5) MONTHLY VF: is the ratio of the estimate of the 95th percentile of the lognormally distributed averages of 10 values to an estimate of the expected or average pollutant concentrations.
 - 6) Overall: is the unweighted arithmetic average of the individual plant estimates of AVERAGE, DAILY VF, and MONTHLY VF. The overall averages are used for limitation development.

TABLE 7-4

PERFORMANCE OF IN-PLACE TREATMENT

Luminescent Materials Subcategory(1)
 Option 2 Treatment
 Precipitation/Clarification

<u>Parameter</u>	<u>Plant 101</u>		<u>Plant 102</u>
	<u>Influent</u> mg/l	<u>Effluent</u> mg/l	<u>Effluent</u> mg/l
<u>Toxic Metals</u>			
Antimony	0.029	0.031	0.008
Cadmium	0.34	0.020	0.20
Zinc	5.52	0.289	0.47
<u>Other Pollutants</u>			
TSS	210	45	12

(1) Data are from Tables 5-7 and 5-8.

The pollutant concentration data supplied by industry are from the Cathode Ray Tube Subcategory. These data were pollutant concentrations measured in samples taken from wastewaters at various stages of treatment. The rationale for excluding or including wastewater sampling data are presented in Sections 7.4.1 and 7.4.2 and summaries of these data used for limitation development are presented in Tables 7-2, 7-3 and 7-4. In all cases summary statistics from individual plants were given equal weight regardless of the source (Agency or industry), the purpose for which the data were used (to estimate long term averages or variability), or the sample sizes. Because of the detailed technical evaluation, (presented in sections 7.4.1 and 7.4.2) the Agency has determined that all the plants used for limitation development are representative of the category; thus the Agency finds it reasonable to apply equal weights to the summary statistics of individual plants regardless of the amount of data available from a plant.

Daily and monthly variability estimates are used with the average effluent pollutant concentration estimates to yield daily and monthly effluent limitations. The statistical methodology used to calculate the variability estimates, averages, and limitations for pollutants regulated in the Cathode Ray Tube and Luminescent Materials Subcategories is described below.

Variability Factors

Even well operated wastewater treatment systems experience fluctuations in pollutant concentrations discharged. These fluctuations result from the variation in process flow, raw waste loading of pollutants, treatment chemical feed, mixing effectiveness during treatment, and combinations of these or other factors. The variation among daily measurements of effluent pollutant concentrations is expected to be larger than the variation among the averages of several measurements of pollutant concentrations measured during a month. To estimate these two sources of variation daily and monthly average estimates of variability are determined for each pollutant. The Agency's data and industry's data from the Cathode Ray Tube Subcategory were used for the development of variability estimates for the metals (cadmium, chromium, lead, zinc). These variability estimates were used for the development of metals limitations for all standards in the category. Industry data from the Cathode Ray Tube Subcategory were used to develop variability estimates for fluoride and were used for the development of fluoride limitations for all standards in the category.

The variability of pollutant concentrations measured in wastewater effluents for the daily and monthly maximum limitations were estimated separately for each plant (Table 7.2). The variability is expressed as a variability factor. The one day maximum variability factor is the ratio of the estimated 99th

percentile of the distribution of individual daily observations to the expected value (i.e., an estimate of the long-term average) of the pollutant concentration from that plant. The monthly average variability factor is the ratio of the estimated 95th percentile of the distribution of averages of ten daily observations to the expected value.

The basic assumption underlying the methodology used to estimate percentiles and expected values is that the concentration measurement that are greater than or equal to the limit of detection are lognormally distributed. Shapiro-Wilk goodness-of-fit tests applied to the natural logarithm transformed pollutant (cadmium, chromium, fluoride, lead, zinc) concentrations (greater than or equal to the detection limit) measured in the effluent wastewaters of plant 99798 indicate that the untransformed pollutant concentrations are not significantly different lognormal. Plant 99798 is the only plant with adequate data for testing lognormality. The results of the goodness-of-fit tests applied to the pollutant concentrations from Plant 99798 and the fact that lognormality has been shown to apply to a variety of pollutants in a wide range of industrial categories indicate that the assumption of lognormality is reasonable. Plant 99796 only has three observations for each pollutant. Although distributional goodness-of-fit tests can be applied to small data sets, a data set with three observations is not large enough to allow discrimination among distributional forms. Goodness-of-fit tests could not be applied to the fluoride concentration measurements from Plant 30172 because these data were averages of four daily measurements taken during a month. To use these data for the estimation of the lognormal parameters described below, the log standard deviation of the four-day averages was multiplied by the square root of four.

The percentiles and the expected value of the pollutant concentrations were estimated using the delta lognormal distribution, a generalized form of the lognormal distribution, which allows consideration of pollutant concentrations reported below a limit of detection. In the delta lognormal distribution, measurements greater than or equal to the detection limit are assumed to follow a lognormal distribution and measurements at or below the detection limit occur with a discrete probability. The delta lognormal distribution is described by Aitchison and Brown (1963, The Lognormal Distribution, Cambridge University Press, Cambridge England, Chapter 9).

An arithmetic average of the daily and ten day variability factors from each plant were calculated for each pollutant and used as the overall estimate of variability (Table 7-3).

Long-Term Averages

In addition to estimates of variability, limitations also require that an estimate be made of the average pollutant concentrations

that can be expected in the treated effluent waste stream of a properly designed and well operated wastewater treatment system. As described above, daily pollutant concentration measurements will fluctuate above and below an average effluent pollutant concentration. Except for TSS in both subcategories and fluoride in the Luminescent Materials Subcategory the average effluent pollutant concentrations for a subcategory were determined using data from plants in each subcategory.

Averages were estimated for each pollutant concentration measured in the effluent stream of each plant with acceptable data (Tables 7-3 and 7-4). The Cathode Ray Tube Subcategory averages for the metals and fluoride were calculated by taking the arithmetic average of the untransformed effluent pollutant concentrations. The values reported below a limit of detection were assigned the detection limit value prior to averaging. The long-term averages (Table 7-3) were determined by averaging the plant averages for each pollutant. The total suspended solids long-term average was transferred from the Metal Finishing Category.

An estimate of long-term averages for antimony, zinc, and cadmium in the Luminescent Materials Subcategory was made by using the highest effluent concentration measurement found in plants 101 and 102 (Table 7-4). The fluoride long-term average was transferred from the Cathode Ray Tube Subcategory and the total suspended solids long-term average was transferred from Metal Finishing Category.

Calculation of Effluent Limitations

The effluent limitations are based on the premise that a plant's treatment system can be operated to maintain average effluent concentrations equivalent to those concentrations observed in the effluent data base. As explained above day-to-day concentrations will fluctuate below and above an average concentration. Effluent limitations are set far enough above the average concentration so that plants with properly operated treatment systems will be within the limits most of the time (roughly 99 percent of the time in the case of daily values and 95 percent of the time in the case of monthly averages based on ten days of daily sampling).

Effluent limitations are obtained for each pollutant by multiplying the long-term average concentration by the appropriate daily and monthly variability factors. Expresses as an equation:

$$L = VF \times A.$$

Where L is the effluent limitation, VF is the variability factor, and A is the long term average concentration.

SECTION 8

SELECTION OF APPROPRIATE CONTROL AND TREATMENT TECHNOLOGIES AND BASES FOR LIMITATIONS

Discharge regulations for the Cathode Ray Tube Subcategory and the Luminescent Materials Subcategory are presented in this section. The technology bases and the numerical bases are also presented for each regulation. The statistical methodology used to develop limitations was presented in Section 7.4.

8.1 CATHODE RAY TUBE SUBCATEGORY

The Agency is not regulating direct dischargers in the Cathode Ray Tube Subcategory for reasons presented in Section 6.2. Therefore, BPT, BAT and BCT limitations are not being promulgated.

8.1.1 Pretreatment Standards for Existing Sources (PSES)

Pollutant	Average (LTA) (mg/l)	Monthly Average		Daily Maximum	
		VF	Limit (mg/l)	VF	Limit (mg/l)
Cadmium	0.020	1.30	0.03	2.77	0.06
Chromium	0.229	1.30	0.30	2.85	0.65
Lead	0.269	1.54	0.41	4.16	1.12
Zinc	0.397	1.42	0.56	3.48	1.38
TTO			*		1.58
Fluoride	14.5	1.25	18.0	2.40	35.0

*The Agency is not promulgating monthly TTO limitations for reasons presented below.

EPA is promulgating PSES based on Option 2 and Option 4. Option 4 is solvent management to control toxic organics. Option 2 consists of neutralization, and precipitation/clarification of the final effluent to reduce toxic metals and fluoride along with inprocess control for lead and chromium. Solvent management is widely practiced at cathode ray tube facilities, as is neutralization. Precipitation/clarification technology is known to be currently practiced at six CRT facilities. Option 1, neutralization, was not selected because it will not control toxic metals or fluoride. Option 3, filtration, was not selected because the demonstrated national pollutant reduction of 5.9 pounds per day beyond that achieved by Option 2 is not considered significant for existing sources. Precipitation/clarification technology achieves greater than 96 percent reduction of metals.

Option 5 (carbon adsorption for toxic organics) was rejected for technical reasons. EPA calculated the theoretical concentrations of organics that Option 5 would achieve, and found that it would result in TTO levels equal to, or perhaps worse than, those achieved by proper solvent management.

Toxic Metals and Fluoride -- The limitations for toxic metals (cadmium, chromium, lead and zinc) and fluoride are based on demonstrated performance at CRT plants employing precipitation/clarification treatment technologies. As described in Section 7, both on-site sampling and long-term effluent monitoring data are reflected in the limitations. They therefore incorporate both the plant-to-plant variations in raw wastes and treatment practices and the day-to-day variability of treatment system performance. The concentrations shown are all applicable to the treated effluent prior to any dilution with sanitary wastewater, noncontact cooling water, or water from other processes.

The achievable long-term average concentrations used to develop the limitations are based on EPA sampling data and long-term self-monitoring data as shown in Table 7-3. The averages for the toxic metals represent the average effluent concentrations following Option 2 treatment at Plants 99796 and 99798. The average for fluoride incorporates self monitoring data from the filtered effluent from Plant 30172 as well as the clarifier effluent concentration reported by Plant 99798. Since the EPA sampling data from Plant 30172 show no removal of fluoride following filtration, the data likely reflect performance for Option 2 technology.

The variability factors used to develop these limitations are based on statistical analysis of long-term self monitoring data and EPA data. For cadmium, chromium, lead, zinc, and fluoride EPA averaged self monitoring and EPA monitoring data separately, then used the median of those two averages.

Total Toxic Organics (TTO) -- A daily maximum limit of 1.58 milligrams per liter is being promulgated based on the control technology of solvent management. The Agency is regulating total toxic organics rather than individual organics. TTO represents the sum of toxic organics found in the effluents of CRT facilities at concentrations greater than 0.01 milligrams per liter. Organic compounds included in TTO are listed in Table 61. The Agency is establishing a daily maximum TTO limit but not a monthly average TTO limit. This is because solvent management is not a treatment technology and therefore not subject to significant performance variation. In addition, the final limit is already the highest of several observations.

The Agency also considered an alternative way of developing a TTO limit. EPA had visited or sampled representative CRT facilities. All practiced solvent management by segregating and collecting

spent solvents used in the manufacturing process. Sampling data generally showed very low quantities of TTO. Data from another plant (11114) were unusable because of dilution problems. Because of limited data, the proposed limit for TTO (0.15 mg/l) was in fact based on the maximum TTO observed during three days of sampling at one plant. Recognizing the limited data base, EPA requested in the preamble to the proposed regulations that additional data be submitted by industry.

In response to this request one facility submitted data for one-day sampling. One other plant submitted data; however, the sampling methodology used did not comply with EPA sampling protocol since it did not composite its grab samples before analysis. Additionally, Plant 11114 submitted flow-data which allowed us to calculate the TTO value by deleting the effect of dilution by cooling water and other non-related process streams. Combining these data provided five data points from three plants. Based on these data, we calculated a median TTO value of 1.13 mg/l. Even when multiplied by a significant variability factor that limit would be only 1.47 mg/l. That concentration did not differ significantly from the maximum TTO reported (1.58 mg/l) in the effluent of plants practicing solvent management in this subcategory. Therefore a daily maximum TTO limit of 1.58 is being promulgated.

Finally because only limited TTO data were available from the CRT industry, EPA reviewed data from other industries, including other E&EC subcategories, to assess the reasonableness of this limitation. The TTO limit for the E&EC Phase I subcategories was 1.37 mg/l; that for Metal Finishing was 2.13 mg/l. The limit selected here (1.58 mg/l) appears reasonable in light of likely sources of TTO for this industry and in view of reported concentrations in this subcategory.

8.1.2 New Source Performance Standards (NSPS)

Pollutant	LTA (mg/l)	Monthly Average		Daily Maximum	
		VF	Limit (mg/l)	VF	Limit (mg/l)
Cadmium	0.020	1.30	0.03	2.77	0.06
Chromium	0.196	1.30	0.26	2.85	0.56
Lead	0.174	1.54	0.27	4.16	0.72
Zinc	0.229	1.42	0.33	3.48	0.80
TTO					1.58
Fluoride	14.5	1.25	18.0	2.40	35.0
TSS	12.8	1.85	24.0	3.59	46.0
pH	range from 6 to 9				

The Agency is promulgating NSPS based on Option 3. This technology consists of neutralization and solvent management plus

end-of-pipe precipitation/clarification followed by filtration along with in-process control for lead and chromium. Option 1 was not selected because it will not control toxic metals or fluoride. Option 3 was selected over Option 2 because new plants have the opportunity to install the best demonstrated technologies. The installation of filtration technology will accomplish an additional 1.4 percent reduction in toxic metals. Filters are not expected to produce a measurable reduction in fluoride or TTO. Thus the proposed limitations for these pollutants do not change from PSES.

Toxic Metals -- The percent reduction of each metal following filtration as calculated from Table 7-2 were applied to the long-term average concentrations in PSES to develop the achievable long-term average. Variability factors are the same as those derived for Option 2 technology.

Total Suspended Solids (TSS) -- TSS limitations represent a transfer of data from the Metal Finishing Category. The average effluent concentration of 12.8 milligrams per liter of TSS was derived from EPA sampling data from several metal finishing plants practicing solids removal by clarification and filtration technology. Excluded from the data base were plants with improperly operated treatment systems. The variability factors of 1.85 (monthly) and 3.59 (daily) represent the median of variability factors from 17 metal finishing plants with longterm monitoring data. The rationale for transferring technology from this industry is (1) the raw waste TSS concentrations are similar to those found in CRT wastes, and (2) the treatment technology used for solids reduction in metal finishing plants mentioned above and used to derive these limits, is the same as Option 3 for Cathode Ray Tubes Subcategory.

pH -- Properly operated end-of-pipe neutralization of wastewater will ensure discharges in the pH range of 6 to 9 as demonstrated by sampling data.

8.1.3 Pretreatment Standards for New Sources (PSNS)

Pollutant	LTA (mg/l)	VF	Monthly		
			Average Limit (mg/l)	Daily Maximum VF Limit (mg/l)	
Cadmium	0.020	1.30	0.03	2.77	0.06
Chromium	0.196	1.30	0.26	2.85	0.56
Lead	0.174	1.54	0.27	4.16	0.72
Zinc	0.229	1.42	0.33	3.48	0.80
TTO					1.58
Fluoride	14.5	1.25	18.0	3.40	35.0

The Agency is promulgating PSNS based on Option 3. This technology consists of neutralization and solvent management plus end-of-pipe precipitation/clarification followed by filtration along with in-process control for lead and chromium. As with NSPS the addition of filtration is expected to further reduce toxic metals in the effluent over that expected from precipitation/clarification (Option 2), but no meaningful reduction in fluoride or TTO is expected.

The basis for the toxic metals, total toxic organics (TTO) and fluoride limitations were presented under NSPS. These limitations do not change for PSNS. TSS and pH are not regulated under PSNS because they are conventional pollutants which can be removed by a POTW.

8.2 LUMINESCENT MATERIALS SUBCATEGORY

The Agency is not regulating existing dischargers in the Luminescent Materials Subcategory for reasons presented in Section 6.2.

8.2.1 New Source Performance Standards (NSPS)

Pollutant	LTA (mg/l)	Monthly Average		Daily Maximum	
		VF	Limit (mg/l)	VF	Limit (mg/l)
Cadmium	0.20	1.30	0.26	2.77	0.55
Antimony	0.03	1.42	0.04	3.48	0.10
Zinc	0.47	1.42	0.67	3.48	1.64
Fluoride	14.5	1.25	18.0	2.40	35.0
TSS	16.8	1.85	31.0	3.59	60.0
pH	range from 6-9				

EPA is promulgating NSPS based on Option 2 technology which consists of precipitation/clarification and neutralization. This technology controls pH, total suspended solids (TSS), fluoride, cadmium, antimony, and zinc. All but one of the dischargers in the Luminescent Materials Subcategory are currently practicing this technology. Option 1 was not selected because Option 2 achieves for greater removals and is economically achievable. Option 3, filtration, was not selected because it would only accomplish an additional 0.16 percent reduction in toxic metals.

The bases for pH and fluoride limitations were presented in Section 8.1 for the Cathode Ray Tubes Subcategory. The limitations for these pollutants are the same for the Luminescent Materials Subcategory. Fluoride levels are similar in the raw waste streams of these two subcategories. pH levels will also be controlled to similar levels following

precipitation/clarification treatment. The bases for toxic metals and suspended solids limitations are presented below.

Toxic Metals -- The NSPS limitations for toxic metals (cadmium, antimony and zinc) are based on sampling data from two luminescent materials plants employing precipitation/clarification technologies. Because the available data are limited, the higher value of each toxic metal from the two plants was selected as the achievable long-term average. Variability factors are the same as those derived for the CRT industry, which practices the same treatment technology. These variability factors are discussed in Section 8.1.1. Because no long-term monitoring data were available for antimony, the higher of the variability factors for the other metals, those for zinc were applied for antimony.

Total Suspended Solids (TSS) -- Proposed TSS limitations represent a transfer of data from the Metal Finishing Category. The average concentration of 16.8 milligrams per liter was derived from EPA sampling data from numerous metal finishing plants practicing solids removal by clarification technology. Excluded from the data base were plants with improperly operated treatment systems. The daily and monthly variability factors each represent the median of variability factors from 17 metal finishing plants with long-term monitoring data. The rationale for transferring technology from this industry is (1) the raw waste TSS concentrations are similar to those found in luminescent materials wastes, and (2) the treatment technology used for solids reduction in the metal finishing plants mentioned above and used to derive these limits is the same as Option II for the Luminescent Materials Subcategory.

8.2.2 Pretreatment Standards for New Sources (PSNS)

Pollutant	LTA (mg/l)	Monthly Average		Daily Maximum	
		VF	Limit (mg/l)	VF	Limit (mg/l)
Cadmium	0.20	1.30	0.26	2.77	0.55
Antimony	0.03	1.42	0.04	3.48	0.10
Zinc	0.47	1.42	0.67	3.48	1.64
Fluoride	14.5	1.25	18.0	2.40	35.0

For PSNS, the Agency is promulgating limitations based on Option 2, neutralization and end-of-pipe precipitation/clarification for control of toxic metals and fluoride. Option 1 was not selected because it will not control toxic metals or fluoride as well as Option 2, which has been demonstrated and is economically achievable. Option 3 was not selected for reasons presented under NSPS.

PSNS limitations for luminescent materials producers are the same as those for NSPS except that pH and TSS are not regulated for pretreatment since they are adequately controlled by POTWs. The basis for limitations were presented in Section 8.2.1.

SECTION 9

COST OF WASTEWATER TREATMENT AND CONTROL

This section presents estimates of the costs of implementation of wastewater treatment and control systems for the Cathode Ray Tube and Luminescent Materials subcategories of the Electrical and Electronic Components category. The systems for which cost estimates are presented are those options identified in Section 7. The cost estimates then provide the basis for possible economic impact of regulation on the industry. The general approach or methodology for cost estimating is presented below followed by the treatment and control costs.

9.1 COST ESTIMATING METHODOLOGY

Costs involved in setting up and operating a wastewater treatment unit are comprised of investment costs for construction, equipment, engineering design, and land, and operating costs for energy, labor, and chemicals. There are also costs for disposing of sludge and for routine analysis of the treated effluent.

The costs presented in this section are based on model plants which closely resemble the types and capacities of waste treatment facilities needed for each product subcategory. Model plants are not set up as exemplary plants, but as typical of sufficient design to represent the range of plants and treatment facilities present in the industry. Data are based on plant visits and contacts with industries to verify treatment practices and to obtain data on size, wastewater flow, and solid waste disposal systems. The differences in treatment capacities are reflected in the choice of model plants which are presented for different flow rates covering the existing range of flows at average concentrations of pollutants.

Unit process equipment costs were assembled from vendors and other commercial sources. Information on the costs of equipment, the present costs of chemicals and average costs for hauling sludge was developed with data from industry, engineering firms, and equipment suppliers. Appropriate factors were applied to determine total investment costs and annual costs.

The costs which will actually be incurred by an individual plant may be more or less than presented in the cost estimate. The major variations in treatment costs between plants result from differences in pollutant concentrations and site dependent conditions, as reflected in piping lengths, climate, land availability, water and power supply and the location of the point of final discharge. In addition, solids disposal costs and material costs will vary depending on geographical locations. A broad range of actual costs could exist that would not be

fundamentally different from those analyzed here. However, in general, EPA believes that these are a conservative set of estimates of actual costs.

The following assumptions were employed in the cost development:

1. All non-contact cooling water was excluded from treatment and treatment costs.
2. Source water treatment, cooling tower and boiler blowdown discharges were not considered process wastewater.
3. Sanitary sewage flow is excluded.
4. The treatment facilities were assumed to operate 24-hours per day five days per week.
5. Excluded from the estimates were any costs associated with permits, reports or hearings required by regulatory agencies. These are independent of the costs of actually meeting these substantive performance standards.

Investment costs are expressed in mid-year 1982 dollars to construct facilities at various wastewater flow rates. Operation, maintenance, and amortization of the investment are expressed as elements of annual costs.

9.1.1 Direct Investment Costs for Land and Facilities

Types of direct investment costs for waste treatment facilities and criteria for estimating major components of the model plants are presented below.

Construction Costs -- Construction costs include site preparation, grading, enclosures, buildings, foundations, earthworks, roads, paving, and concrete. Since few if any buildings will be utilized, construction costs have been calculated using a factor of 1.15 applied to the installed equipment cost.

Equipment Cost -- Equipment for wastewater treatment consists of a combination of items such as pumps, chemical feed systems, agitators, flocculant feed systems, tanks, clarifiers and thickeners. Cost tables for these items were developed from vendor's quotations for a range of sizes, capacities and motor horsepower. Except for large size tanks and chemical storage bins, the cost represents packaged, factory-assembled units.

Critical equipment is assumed to be installed in a weatherproof structure. Chemical storage feeders and feedback controls include such items as probes, transmitters, valves, dust filters

and accessories. Critical pumps are furnished in duplicate as a duty and a spare, each capable of handling the entire flow.

Equipment-In-Place Costs (includes installed equipment costs) -- Equipment-in-place is defined to include all services, activities, and miscellaneous material necessary to implement the described wastewater treatment and control system, including piping, fittings, and electrical work. Many factors can affect the cost of installing equipment modules. These include wage rates, manpower availability, who does the job (outside contractor or regular employees), new construction versus modification of existing systems, and site-dependent conditions (e.g., the availability of sufficient electrical service). In these estimates, installation costs were chosen for each model based upon average site conditions taking into consideration the complexity of the system being installed. An appropriate cost is allowed for interconnecting piping, power circuits and controls.

Monitoring Equipment -- It is assumed that monitoring equipment will be installed at the treated effluent discharge point. It will consist of an indicating, integrating, and recording type flow meter, pH meter, sensor, recorder, alarms, controls and an automatic sampler.

Land -- Land availability and cost of land can vary significantly, depending upon geographical location, degree of urbanization and the nature of adjacent development. Land for waste treatment is assumed to be contiguous with the production plant site. For the purpose of the report land is valued at \$24,000 per acre.

Investment Costs for Supporting Services -- Engineering design and inspection are typical services necessary to advance a project from a concept to an operating system. Such services broadly include laboratory and pilot plant work to establish design parameters, site surveys to fix elevation and plant layout, foundation and groundwater investigation, and operating instructions, in addition to design plans, specifications and inspection during construction. These costs, which vary with job conditions, are often estimated as percentages of construction costs, with typical ranges as follow:

Preliminary survey and construction surveying	1 to 2 %
Soils and groundwater investigation	1 to 2 %
Laboratory and pilot process work	2 to 4 %
Engineering design and specifications	7 to 12 %
Inspection during construction	2 to 3 %
Operation and maintenance manual	1 to 3 %

From this range of 14 to 26 percent, a value of 17 percent (except for the 10,000 gpd estimate where 10 percent was used) of equipment-in-place plus construction costs has been used in this

study to represent the engineering and design cost applied to model plant cost estimates.

The Contractor's Fee and Contingency -- These costs are usually expressed as a percentage of equipment-in-place plus construction costs, and include such general items as temporary utilities, small tools, field office overhead and administrative expense. The contractor is entitled to a reasonable profit on his activities and to the cost of interest on capital tied up during construction. Although not all of the above cost will be incurred on every job, an additional 25 percent (except for the 10,000 gpd estimate where 10 percent was used) of the equipment-in-place plus construction costs has been used to cover related cost broadly described as contractor's fees, incidentals, overhead, and contingencies.

9.1.2 Annual Costs

Operation and Maintenance Costs -- Annual operation and maintenance costs are described and calculated as follows:

Labor and Supervision Costs:

Personnel costs are based on an hourly rate of \$20.00. This includes fringe benefits and an allocated portion of costs for management, administration and supervision. Personnel are assigned for specific activities as required by the complexity of the system, ranging from 1-8 hours per day.

Energy Costs:

Energy costs are based on the cost of \$219 per horsepower operating 24 hours per day and 250 days per year. For batch processes appropriate adjustments were made to suit the production schedule. The cost per horsepower year is computed as follows:

$$Cy = 1.1 (0.746 \text{ HP} \times \text{Hr.} \times \text{Ckw}) / (E \times P)$$

where

- Cy = Cost per year
- HP = Total Horsepower Rating of Motor (1 HP = 0.746 kw)
- E = Efficiency Factor (0.9)
- P = Power Factor (1.00)
- Hr. = Annual Operating Hours (250 x 24 = 6000)
- Ckw = Cost per Kilowatt-Hour of Electricity (\$0.040)

Note: The 1.1 factor in the equation represents allowance for incidental energy used such as lighting, etc. It is assumed that no other forms of energy are used in the waste treatment system.

Chemicals:

Prices for the chemicals were obtained from vendors and the Chemical Marketing Reporter. Unit costs of common chemicals delivered to the plant site are based on commercial grade of the strength or active ingredient percentage with prices as follows:

Lime (Calcium Hydroxide) Bulk	\$54/Ton
Sulfuric Acid	\$84/Ton
Flocculant	\$ 2/Lb
Sodium Bisulfite	\$0.32/Lb
Soda Ash	\$0.14/Lb
Calcium Chloride	\$0.24/Lb

Maintenance:

The annual cost of maintenance is estimated as ten percent (10%) of the investment cost, excluding land.

Taxes and Insurance:

An annual provision of three percent of the total investment cost has been included for taxes and insurance.

Residual Waste Disposal:

Sludge disposal costs can vary widely. Chief cost determinants include the amount and type of waste. Off-site hauling and disposal costs are taken as \$50/ton for bulk hauling, with appropriate increases for small quantities in steel containers. Information available to the Agency indicates that the selected treatment technologies for controlling pollutants in this industry will not result in hazardous wastes as defined by RCRA.

Monitoring, Analysis and Reporting:

The manpower requirements covered by the annual labor and supervision costs include those activities associated with the operation and maintenance of monitoring instruments, recorder and automatic samplers as well as the taking of periodic grab samples. Additional costs for analytical laboratory services have been estimated for each subcategory assuming that sampling takes place three times a week at the point of discharge. A cost of \$7500/year has been used for monitoring analyses and reporting.

Amortization:

Amortization of capital costs (investment costs) are computed as follows:

$$CA = B (r(1+r)^n)/((1+r)^n-1)$$

where CA = Annual Cost

B = Initial amount invested excluding cost of land

r = Annual interest rate (assumed 13 percent)

n = Useful life in years

The multiplier for B in equation (1) is often referred to as the capital recovery factor and is 0.2843 for the assumed overall useful life of 5 years. No residual or sludge value is assumed.

9.1.3 Items not Included in Cost Estimate

Although specific plants may encounter extremes of climate, flood hazards and lack of water, the cost of model plants have been estimated for average conditions of temperature, drainage and natural resources. It is assumed that any necessary site drainage, roads, water development, security, environmental studies and permit costs are already included in production facilities costss. Therefore, the model costs are only for facilities, suppliers and services directly related to the treatment and disposal of waterborne wastes, including land needed for treatment and on-site sludge disposal. Air pollution control equipment is not included, except for dust collectors associated with treatment, chemical transfer and feeding. Raw wastes from various sources are assumed to be delivered to the treatment facility at sufficient head to fill the influent equalization basin, and final effluent is discharged by gravity. Cost of pumps, pipes, lines etc., necessary to deliver raw wastewater to the treatment plant or to deliver the treated effluent to the point of discharge are not included in the cost estimates.

9.2 COST ESTIMATES FOR TREATMENT AND CONTROL OPTIONS

Option 1 treatment consists of neutralization for pH control. All direct dischargers in the CRT and Luminescent Materials Subcategories currently practice neutralization of their effluent, therefore no costs are associated with this option.

Option 2 treatment consists of Option 1 treatment with the addition of: chemical precipitation and clarification of all metals-bearing process wastes using lime, calcium chloride (to control fluoride), a coagulant and/or polyelectrolyte, and sludge dewatering. In addition, thr the Cathode Ray Tube Subcategory, Option 2 treatment includes chromium reduction with the use of sulfuric acid and sodium bisulfite, and sodium carbonate precipitation and clarification or lead-bearing wastes. The capital and annual costs for this option are presented in Table 9-1 for CRTs and Table 9-2 for luminescent materials. The range

TABLE 9-1
CATHODE RAY TUBES

OPTION 2 TREATMENT COSTS

FLOW	10,000 GPD	50,000 GPD	100,000 GPD
A. INVESTMENT COSTS			
Construction.....	<u>7,100</u>	<u>15,000</u>	<u>37,000</u>
Equipment in place including piping, fittings, electrical work and controls...	<u>85,900</u>	<u>180,500</u>	<u>448,400</u>
Monitoring equipment in place.....	<u>6,000</u>	<u>6,000</u>	<u>6,000</u>
Engineering Design and inspection.....	<u>9,300</u>	<u>33,200</u>	<u>82,500</u>
Incidentals, overhead, fees, contingencies..	<u>9,300</u>	<u>48,900</u>	<u>121,400</u>
Land.....	<u>6,000</u>	<u>6,000</u>	<u>6,000</u>
TOTAL INVESTMENT COST	<u><u>123,600</u></u>	<u><u>289,600</u></u>	<u><u>701,300</u></u>
B. OPERATION AND MAINTENANCE COST			
Labor and supervision	<u>10,000</u>	<u>25,000</u>	<u>30,000</u>
Energy.....	<u>180</u>	<u>900</u>	<u>1,900</u>
Chemicals.....	<u>1,220</u>	<u>6,000</u>	<u>12,800</u>
Maintenance.....	<u>11,750</u>	<u>28,400</u>	<u>69,500</u>
Taxes and insurance.	<u>3,700</u>	<u>8,700</u>	<u>21,000</u>
Residual waste disposal.....	<u>1,550</u>	<u>5,000</u>	<u>11,000</u>
Monitoring, analysis and reporting.....	<u>7,500</u>	<u>7,500</u>	<u>7,500</u>
TOTAL OPERATION AND MAINTENANCE COST	<u><u>35,900</u></u>	<u><u>81,500</u></u>	<u><u>153,700</u></u>
C. AMORTIZATION OF INVESTMENT COST			
	<u>33,450</u>	<u>80,600</u>	<u>197,700</u>
TOTAL ANNUAL COST	<u><u>69,350</u></u>	<u><u>162,100</u></u>	<u><u>351,400</u></u>

TABLE 9-1
(Continued)
CATHODE RAY TUBES

OPTION 2 TREATMENT COSTS

FLOW	200,000 GPD	500,000 GPD
A. INVESTMENT COSTS		
Construction.....	<u>61,100</u>	<u>84,000</u>
Equipment in place including piping, fittings, electrical work and controls...	<u>741,100</u>	<u>1,019,200</u>
Monitoring equipment in place.....	<u>6,000</u>	<u>6,000</u>
Engineering Design and inspection.....	<u>136,400</u>	<u>187,500</u>
Incidentals, overhead, fees, contingencies..	<u>200,600</u>	<u>275,800</u>
Land.....	<u>6,000</u>	<u>6,000</u>
TOTAL INVESTMENT COST	<u><u>1,151,200</u></u>	<u><u>1,578,500</u></u>
B. OPERATION AND MAINTENANCE COST		
Labor and supervision	<u>40,000</u>	<u>40,000</u>
Energy.....	<u>3,000</u>	<u>9,000</u>
Chemicals.....	<u>24,000</u>	<u>60,000</u>
Maintenance.....	<u>114,500</u>	<u>157,300</u>
Taxes and insurance.	<u>34,500</u>	<u>47,400</u>
Residual waste disposal.....	<u>22,000</u>	<u>58,000</u>
Monitoring, analysis and reporting.....	<u>7,500</u>	<u>7,500</u>
TOTAL OPERATION AND MAINTENANCE COST	<u><u>245,500</u></u>	<u><u>379,200</u></u>
C. AMORTIZATION OF INVESTMENT COST	<u><u>325,600</u></u>	<u><u>447,100</u></u>
TOTAL ANNUAL COST	<u><u><u>571,100</u></u></u>	<u><u><u>826,300</u></u></u>

TABLE 9-2
LUMINESCENT MATERIALS
OPTION 2 TREATMENT COSTS

FLOW	10,000 GPD	100,000 GPD	250,000 GPD
A. INVESTMENT COSTS			
Construction.....	<u>5,600</u>	<u>33,500</u>	<u>62,650</u>
Equipment in place including piping, fittings, electrical work and controls...	<u>68,100</u>	<u>406,200</u>	<u>760,000</u>
Monitoring equipment in place.....	<u>6,000</u>	<u>6,000</u>	<u>6,000</u>
Engineering Design and inspection.....	<u>7,400</u>	<u>74,750</u>	<u>139,850</u>
Incidentals, overhead, fees, contingencies..	<u>7,400</u>	<u>109,950</u>	<u>205,700</u>
Land.....	<u>6,000</u>	<u>6,000</u>	<u>6,000</u>
TOTAL INVESTMENT COST	<u><u>100,500</u></u>	<u><u>636,400</u></u>	<u><u>1,180,200</u></u>
B. OPERATION AND MAINTENANCE COST			
Labor and supervision	<u>10,000</u>	<u>30,000</u>	<u>40,000</u>
Energy.....	<u>190</u>	<u>1,900</u>	<u>4,750</u>
Chemicals.....	<u>815</u>	<u>8,200</u>	<u>21,000</u>
Maintenance.....	<u>9,450</u>	<u>63,050</u>	<u>117,400</u>
Taxes and insurance.	<u>3,000</u>	<u>19,100</u>	<u>35,400</u>
Residual waste disposal.....	<u>1,150</u>	<u>9,950</u>	<u>24,500</u>
Monitoring, analysis and reporting.....	<u>7,500</u>	<u>7,500</u>	<u>7,500</u>
TOTAL OPERATION AND MAINTENANCE COST	<u><u>32,100</u></u>	<u><u>139,700</u></u>	<u><u>250,550</u></u>
C. AMORTIZATION OF INVESTMENT COST	<u>26,900</u>	<u>179,200</u>	<u>335,550</u>
TOTAL ANNUAL COST	<u><u>59,000</u></u>	<u><u>318,900</u></u>	<u><u>586,100</u></u>

of model plant wastewater flows reflects the range of flows that currently exist in the subcategories. Figures 9-1 and 9-2 graphically present the annual costs for this option versus plant wastewater flow for CRTs and Luminescent Materials, respectively.

Option 3 (Cathode Ray Tube Subcategory only) treatment consists of Option 2 treatment with the addition of multi-media filtration technology. The capital and annual costs are presented in Table 9-3. Figure 9-3 graphically presents the annual costs versus plant wastewater flows for this option. The costs are incremental and therefore only reflect the additional costs of adding filtration technology end-of-pipe.

Option 4 (Cathode Ray Tube Subcategory only) consists of solvent management for the control of toxic organics. Solvent management is not a treatment system, but rather in-plant control to segregate and collect spent solvents for resale or contract disposal. EPA, therefore, considered it in conjunction with Options 1 through 3. All plants in the data base currently practice solvent management.

Those plants that are not already in compliance will have to improve the effectiveness of their solvent management program. EPA has assumed the real costs of compliance for such plants are minimal. Primarily, this is because the costs are small increments above existing costs. That is, a discharger who is currently handling and disposing solvents contained in drums or tanks may have some additional amounts of solvents to deal with. He already would have incurred the basic costs of setting up such systems. However, to the extent that there may be incremental costs they may be offset by the resale value of the additional solvents. Data in the record show that resale of spent solvents is commonly practiced.

Although we expect most plants will want to take advantage of the certification alternative, some may decide to monitor. While it is difficult to estimate monitoring frequency for total toxic organics in the absence of significant historical experience, based on a survey of state and regional permitting authorities, we estimate that, on an average, monitoring for TTO will be required once per quarter. In some cases plants may be required to monitor as frequently as once a month. Thus, EPA has done an economic sensitivity analysis to assess the impact of monthly monitoring costs as part of its economic impact analysis. The capital and annual costs of both quarterly and monthly monitoring for TTO, in 1983 dollars, are presented in Table 9-4.

EPA has also performed an economic sensitivity analysis for RCRA costs. As stated above, EPA believes that minimal costs are associated with TTO compliance. Nevertheless, EPA Has costed out and assessed the economic impact if plants presently not in compliance sent the additional solvents to hazardous waste disposal facilities covered by the Resource Conservation and

CATHODE RAY TUBES

11-6

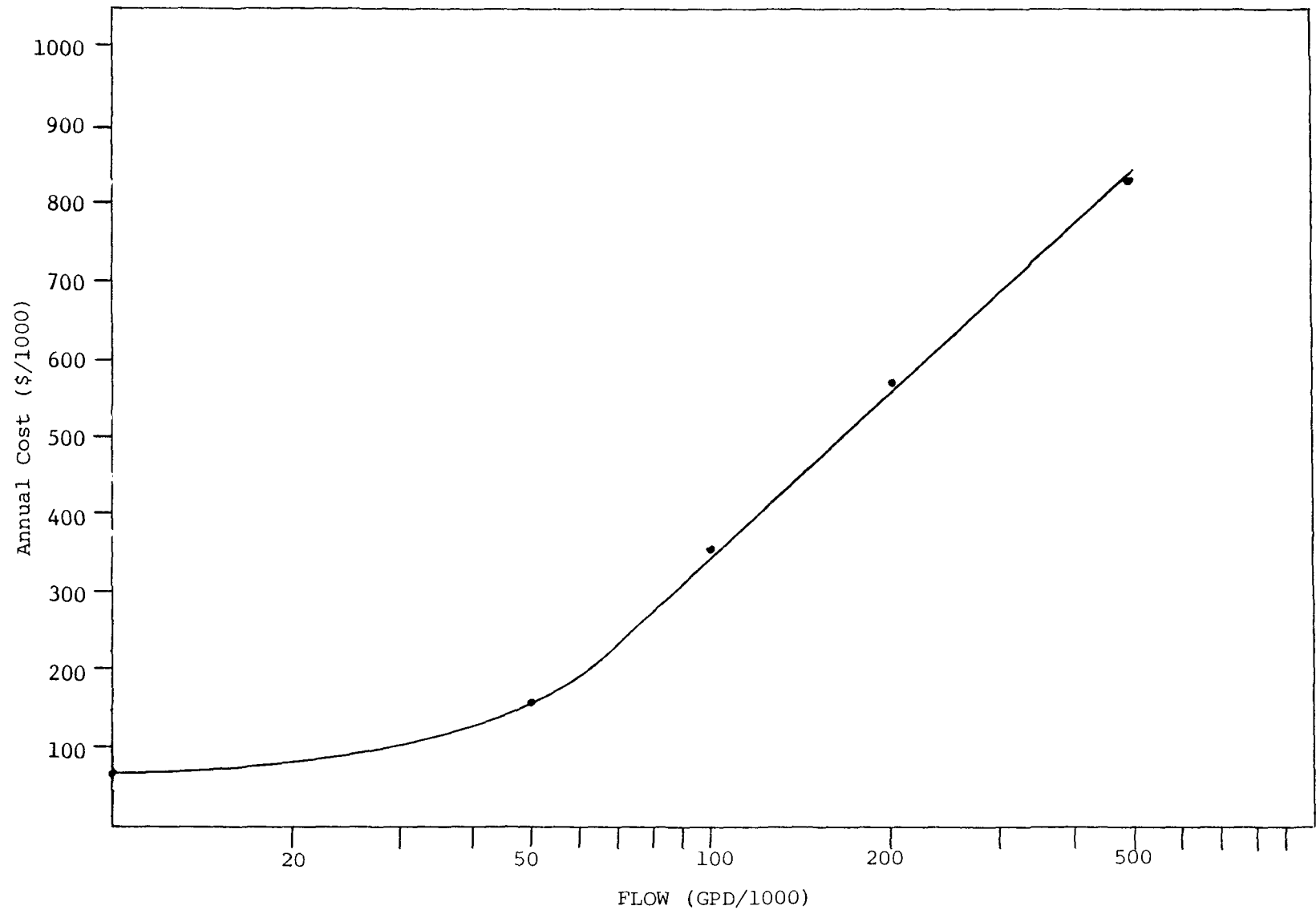
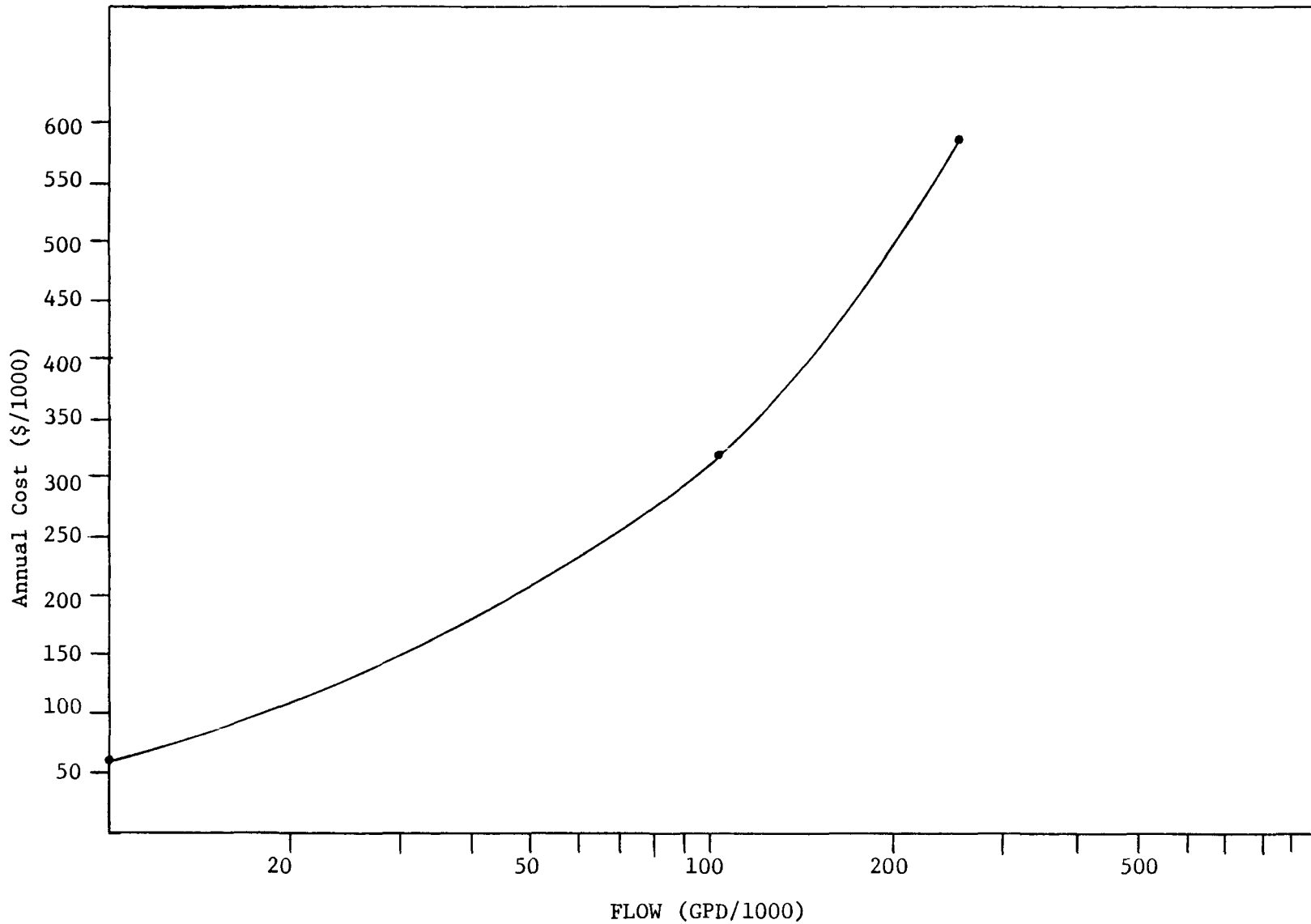

FIGURE 9-1
Annual Cost vs. Flow for
Option 2 Technology

LUMINESCENT MATERIALS



9-12

FIGURE 9- 2
Annual Cost vs. Flow for
Option 2 Technology

TABLE 9-3
CATHODE RAY TUBES

OPTION 3 TREATMENT COSTS

FLOW	10,000 GPD	50,000 GPD	100,000 GPD
A. INVESTMENT COSTS			
Construction.....	<u>400</u>	<u>1,000</u>	<u>3,600</u>
Equipment in place including piping, fittings, electrical work and controls...	<u>4,900</u>	<u>11,600</u>	<u>43,700</u>
Monitoring equipment in place.....	<u>--</u>	<u>--</u>	<u>--</u>
Engineering Design and inspection.....	<u>--</u>	<u>--</u>	<u>--</u>
Incidentals, overhead, fees, contingencies..	<u>530</u>	<u>3,200</u>	<u>11,800</u>
Land.....	<u>--</u>	<u>--</u>	<u>--</u>
TOTAL INVESTMENT COST	<u><u>5,830</u></u>	<u><u>15,800</u></u>	<u><u>59,100</u></u>
B. OPERATION AND MAINTENANCE COST			
Labor and supervision	<u>--</u>	<u>--</u>	<u>--</u>
Energy.....	<u>--</u>	<u>--</u>	<u>--</u>
Chemicals.....	<u>--</u>	<u>--</u>	<u>--</u>
Maintenance.....	<u>580</u>	<u>1,600</u>	<u>5,900</u>
Taxes and insurance.	<u>170</u>	<u>500</u>	<u>1,800</u>
Residual waste disposal.....	<u>--</u>	<u>--</u>	<u>--</u>
Monitoring, analysis and reporting.....	<u>--</u>	<u>--</u>	<u>--</u>
TOTAL OPERATION AND MAINTENANCE COST	<u><u>750</u></u>	<u><u>2,100</u></u>	<u><u>7,700</u></u>
C. AMORTIZATION OF INVESTMENT COST			
	<u>1,650</u>	<u>4,500</u>	<u>16,800</u>
TOTAL ANNUAL COST	<u><u>2,400</u></u>	<u><u>6,600</u></u>	<u><u>24,500</u></u>

TABLE 9-3
(Continued)
CATHODE RAY TUBES

OPTION 3 TREATMENT COSTS

FLOW	200,000 GPD	500,000 GPD
A. INVESTMENT COSTS		
Construction.....	<u>7,000</u>	<u>13,900</u>
Equipment in place including piping, fittings, electrical work and controls...	<u>84,400</u>	<u>168,900</u>
Monitoring equipment in place.....	<u>--</u>	<u>--</u>
Engineering Design and inspection.....	<u>--</u>	<u>--</u>
Incidentals, overhead, fees, contingencies..	<u>22,900</u>	<u>45,700</u>
Land.....	<u>--</u>	<u>--</u>
TOTAL INVESTMENT COST	<u><u>114,300</u></u>	<u><u>228,500</u></u>
B. OPERATION AND MAINTENANCE COST		
Labor and supervision	<u>--</u>	<u>--</u>
Energy.....	<u>--</u>	<u>--</u>
Chemicals.....	<u>--</u>	<u>--</u>
Maintenance.....	<u>11,400</u>	<u>22,900</u>
Taxes and insurance.	<u>3,400</u>	<u>6,900</u>
Residual waste disposal.....	<u>--</u>	<u>--</u>
Monitoring, analysis and reporting.....	<u>--</u>	<u>--</u>
TOTAL OPERATION AND MAINTENANCE COST	<u><u>14,800</u></u>	<u><u>29,800</u></u>
C. AMORTIZATION OF INVESTMENT COST		
	<u>32,500</u>	<u>65,000</u>
TOTAL ANNUAL COST	<u><u>47,300</u></u>	<u><u>94,800</u></u>

CATHODE RAY TUBES

9-15

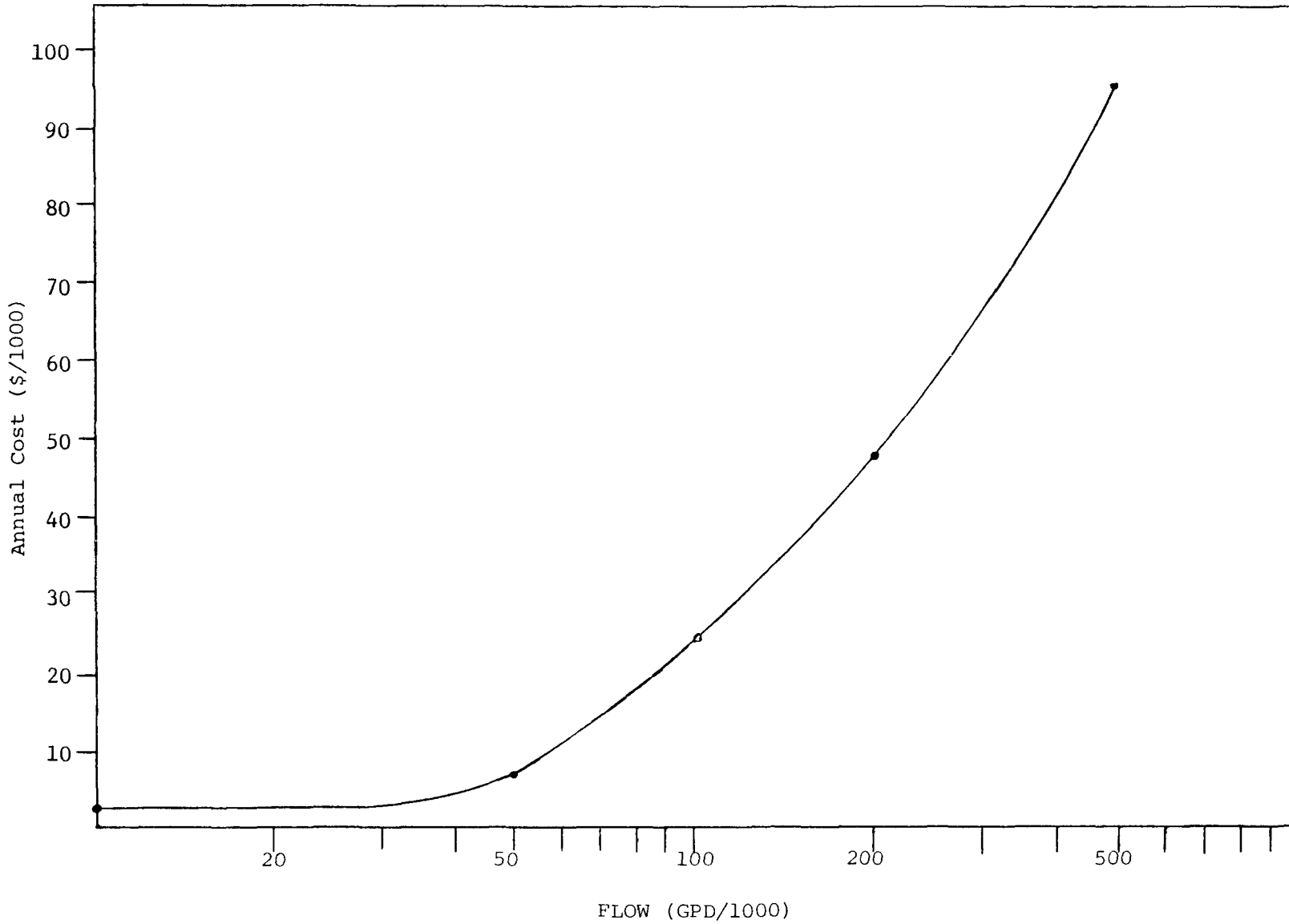

FIGURE 9-3
Annual Cost vs. Flow for
Option 3 Technology

TABLE 9-4
 PLANT MONITORING COSTS
 FOR ORGANICS (1)

INVESTMENT COSTS		
Isco 2100 Sampler. Complete.....		<u>2,500</u>
TOTAL INVESTMENT COST		\$ 2,500
ANNUAL COSTS (2)		
Quarterly analysis	\$ 860 x 4	3,440
Sample kit.....	\$ 50 x 4	200
Sampling personnel @ \$22/hr x 8hrs/episode	\$ x 4	<u>704</u>
TOTAL OPERATION AND MAINTENANCE COST		\$ 4,344
AMORTIZATION OF INVESTMENT COST		<u>711</u>
TOTAL ANNUAL COST		<u><u>\$ 5,055</u></u>

-
- (1) 1983 Dollars
 (2) Assumes quarterly sampling analysis.

Recovery Act. These costs were calculated and were found to be minimal. The analysis is contained in the administrative record supporting this rulemaking.

9.3 ENERGY AND NON-WATER QUALITY ASPECTS

Compliance with the proposed regulations will have no effect on air, noise, or radiation pollution and will only result in minimal energy usage. The amount of solid waste generated will be approximately 1200 metric tons per year. It has not been determined whether the solid wastes generated at CRT and luminescent materials manufacturing plants are hazardous as defined in the Resource Conservation and Recovery Act (RCRA). It is believed that further testing will find the wastewater treatment sludge to be nonhazardous. With regard to solvent wastes resulting from solvent management, EPA has conducted a sensitivity analysis to consider likely economic impacts resulting from the disposal of these wastes as hazardous wastes. Energy requirements associated with these regulations will be 535,000 kilowatt-hours per year or only 214 kilowatt-hours per day per facility. Based on the above non-water quality impacts from these regulations, EPA has concluded that the proposed regulations best serve overall national environmental goals.

SECTION 10

ACKNOWLEDGEMENTS

The Environmental Protection Agency was aided in the preparation of this Development Document by Jacobs Engineering Group Inc. Jacobs' effort was managed by Ms. Bonnie Parrott. Major contributions were made by Mr. Thomas Schaffer, Mr. Robert Mueller, and Ms. Suzanne Phinney.

Mr. John Newbrough of EPA's Effluent Guidelines Division served as Project Officer during the preparation of this document. Mr. Jeffrey Denit, Director, Effluent Guidelines Division, and Mr. Gary E. Stigall, Branch Chief, Effluent Guidelines Division, Inorganic Chemicals Branch, and Mr. David Pepson, Effluent Guidelines Division, offered guidance and suggestions during this project.

Finally, appreciation is extended to the plants that participated in and contributed data for the formulation of this document.

SECTION 11
BIBLIOGRAPHY

- Amick, Charles L., Fluorescent Lighting Manual, McGraw-Hill, 3rd ed., (1961).
- Bogle, W.S., Device Development, The Western Electric Engineer, (July, 1973).
- Buchsbaum, Walter H., Fundamentals of Television, 2nd ed., Hayden Book Co., (1974).
- Cockrell, W.D., Industrial Electronics Handbook, McGraw-Hill (1958).
- Elenbaas, W., Fluorescent Lamps and Lighting, (1959).
- The New Encyclopedia Americana, International Edition, Grolier Inc. Vol. 10 pp. 179-184 (1982).
- Forsythe, William, E., Fluorescent and Other Gaseous Discharge Lamps, 1948).
- Gray, H.J., Dictionary of Physics, Longmans, Green and Co., London (1958).
- Hall, Edwin, "Flat Panels Challenge CRTs for Large-Area Displays," Electronic Design, pp. 61-68., May 28, 1981.
- Helwig, Jane T. and Council, Kathryn A., SAS Users Guide, SAS Institute IAC (1979).
- Hewitt, Harry, Lamps and Lighting, American Elsevier Publishing Co. (1966).
- Hickey, Henry V. and Villings, William M., Elements of Electronics, 3rd ed., McGraw-Hill, (1970).
- Henney, K. and Walsh, C., Eds., Electronic Components Handbook, McGraw-Hill (1975).
- IEEE Standards Committee, IEEE, Standard Dictionary of Electrical and Electronic Terms, J. Wiley and Sons (Oct., 1971).
- Illuminating Engineering Society, IES Lighting Handbook, 3rd ed., (1962).
- Kirk and Othmer, Encyclopedia of Chemical Technology, Interscience, 2nd ed., Vol. 8, pp. 1-23, (1967).

- Kirk and Othmer, Encyclopedia of Chemical Technology, Interscience, 2nd ed., Vol. 12, pp. 616-631, (1967).
- Kirk and Othmer, Encyclopedia of Chemical Technology, Volume 17, McGraw-Hill (1968).
- McGraw-Hill, Dictionary of Scientific and Technical Terms, 2nd ed., McGraw-Hill (1978).
- McGraw-Hill, Encyclopedia of Science and Technology, McGraw-Hill (1960).
- Meyer, Paul L., Introductory Probability and Statistical Applications, Addison-Wesley Publishing Company, 2nd ed., (1970).
- Meyer, Stuart L., Data Analysis for Scientists and Engineers, John Wiley & Sons, Inc. (1975).
- The New Encyclopedia Britannica, Wilbur Denton Publish., Vol. 6, pp. 687-691.
- Simon and Schuster, The Way Things Work, An Illustrated Encyclopedia of Technology, Simon and Schuster (1967).
- Upton, Monroe, Inside Electronics, Devin-Adair Co. (1964).
- U.S. Government Public Law 94-469, Toxic Substances Control Act, (Oct. 11, 1976).
- Warring, R.H., Understanding Electronics, TAB Books (1978).
- Webster's Seventh New Collegiate Dictionary, G & C Merriam Co. (1963).
- Zar, Jerrold H., Biostatistical Analysis, Prentice-Hall Inc. (1974).

SECTION 12

GLOSSARY

- Absorb - To take up matter or radiation.
- Act - Federal Water Pollution Control Act.
- Activate - To treat the cathode or target of an electron tube in order to create or increase the emission of electrons.
- Adjustable Capacitor - A device capable of holding an electrical charge at any one of several discrete values.
- Adsorption - The adhesion of an extremely thin layer of molecules (of gas, liquid) to the surface of solids (granular activated carbon for instance) or liquids with which they are in contact.
- Aging - Storage of a permanent magnet, capacitor, meter or other device (sometimes with a voltage applied) until the characteristics of the device become essentially constant.
- Algicide - Chemicals used to retard the growth of phytoplankton (algae) in bodies of water.
- Aluminum Foil - Aluminum in the form of a sheet of thickness not exceeding 0.005 inch.
- Anneal - To treat a metal, alloy, or glass by a process of heating and slow cooling in order to remove internal stresses and to make the material less brittle.
- Anode - The collector of electrons in an electron tube. Also known as plate; positive electrode.
- Anodizing - An electrochemical process of controlled aluminum oxidation producing a hard, transparent oxide up to several mils in thickness.
- Assembly or Mechanical Attachment - The fitting together of previously manufactured parts or components into a complete machine, unit of a machine, or structure.
- Autotransformer - A power transformer having one continuous winding that is tapped; part of the winding serves as the primary coil and all of it serves as the secondary coil, or vice versa.

Ballast - A circuit element that serves to limit an electric current or to provide a starting voltage, as in certain types of lamps, such as in fluorescent ceiling fixtures.

Binder - A material used to promote cohesion between particles of carbon or graphite to produce solid carbon and graphite rods or pieces.

Biochemical Oxygen Demand - (1) The quantity of oxygen used in the biochemical oxidation of organic matter in a specified time, at a specified temperature, and under specified conditions. (2) Standard test used in assessing wastewater quality.

Biodegradable - The part of organic matter which can be oxidized by bioprocesses, e.g., biodegradable detergents, food wastes, animal manure, etc.

Biological Wastewater Treatment - Forms of wastewater treatment in which bacteria or biochemical action is intensified to stabilize, oxidize, and nitrify the unstable organic matter present. Intermittent sand filters, contact beds, trickling filters, and activated sludge processes are examples.

Breakdown Voltage - Voltage at which a discharge occurs between two electrodes.

Bulb - The glass envelope which incloses an incandescent lamp or an electronic tube.

Busbar - A heavy rigid, metallic conductor, usually uninsulated, used to carry a large current or to make a common connection between several circuits.

Bushing - An insulating structure including a central conductor, or providing a central passage for a conductor, with provision for mounting on a barrier (conducting or otherwise), for the purpose of insulating the conductor from the barrier and conducting current from one side of the barrier to the other.

Calcining - To heat to a high temperature without melting or fusing, as to heat unformed ceramic materials in a kiln, or to heat ores, precipitates, concentrates or residues so that hydrates, carbonates or other compounds are decomposed and volatile material is expelled, e.g., to heat limestone to make lime.

Calibration - The determination, checking, or correction of the graduation of any instrument giving quantitative measurements.

Capacitance - The ratio of the charge on one of the plates of a capacitor to the potential difference between the plates.

Capacitor - An electrical circuit element used to store charge temporarily, consisting in general of two conducting materials separated by a dielectric materials.

Carbon - A nonmetallic, chiefly tetravalent element found native or as a constituent of coal, petroleum, asphalt, limestone, etc.

Cathode - The primary source of electrons in an electron tube; in directly heated tubes the filament is the cathode, and in indirectly heated tubes a coated metal cathode surrounds a heater.

Cathode Ray Tube - An electronic device in which electrons focus through a vacuum to generate a controlled image on a luminescent surface.

Central Treatment Facility - Treatment plant which co-treats process wastewaters from more than one manufacturing operation or co-treats process wastewaters with noncontact cooling water or with non-process wastewaters (e.g., utility blow-down, miscellaneous runoff, etc.).

Centrifuge - The removal of water in a sludge and water slurry by introducing the water and sludge slurry into a centrifuge. The sludge is driven outward with the water remaining near the center. The dewatered sludge is usually landfilled.

Ceramic - A product made by the baking or firing of a nonmetallic mineral such as tile, cement, plaster, refractories, and brick.

Chemical Coagulation - The destabilization and initial aggregation of colloidal and finely divided suspended matter by the addition of a floc-forming chemical.

Chemical Oxidation - The addition of chemical agents to wastewater for the purpose of oxidizing pollutant material, e.g., removal of cyanide.

Chemical Oxygen Demand (COD) - (1) A test based on the fact that all organic compounds, with few exceptions, can be oxidized to carbon dioxide and water by the action of strong oxidizing agents under acid conditions. Organic matter is converted to carbon dioxide and water regardless of the biological assimilability of the substances. One of the chief limitations is its inability to differentiate between biologically oxidizable and biologically inert organic matter. The major advantage of this test is the short time

required for evaluation (2 hours). (2) The amount of oxygen required for the chemical oxidation of organics in a liquid.

Chemical Precipitation - (1) Formation of insoluble materials generated by addition of chemicals to a solution. (2) The process of softening water by the addition of lime and soda ash as the precipitants.

Chlorination - The application of chlorine to water or wastewater generally for the purpose of disinfection, but frequently for accomplishing other biological or chemical results.

Circuit Breaker - Device capable of making, carrying, and breaking currents under normal or abnormal circuit conditions.

Cleaning - The removal of soil and dirt (including grit and grease) from a workpiece using water with or without a detergent or other dispersing agent.

Coil - A number of turns of wire used to introduce inductance into an electric circuit, to produce magnetic flux, or to react mechanically to a changing magnetic flux.

Coil-Core Assembly - A unit made up of the coil windings of a transformer placed over the magnetic core.

Coking - (1) Destructive distillation of coal to make coke. (2) A process for thermally converting the heavy residual bottoms of crude oil entirely to lower-boiling petroleum products and by-product petroleum coke.

Colloids - A finely divided dispersion of one material called the "dispersed phase" (solid) in another material called the "dispersion medium" (liquid). Normally negatively charged.

Composite Wastewater Sample - A combination of individual samples of water or wastewater taken at selected intervals and mixed in proportion to flow or time to minimize the effect of the variability of an individual sample.

Concentric Windings - Transformer windings in which the low-voltage winding is in the form of a cylinder next to the core, and the high-voltage winding, also cylindrical, surrounds the low-voltage winding.

Conductor - A wire, cable, or other body or medium suitable for carrying electric current.

Conduit - Tubing of flexible metal or other material through which insulated electric wires are run.

Contamination - A general term signifying the introduction into water of microorganisms, chemicals, wastes or sewage which renders the water unfit for its intended use.

Contractor Removal - The disposal of oils, spent solutions, or sludge by means of a scavenger service.

Conversion Coating - A metal-surface coating consisting of a compound of the base metal.

Cooling Tower - A device used to cool manufacturing process water before returning the water for reuse.

Copper - A common, reddish, chiefly univalent and bivalent metallic element that is ductile and malleable and one of the best conductors of heat and electricity.

Core (Magnetic Core) - A quantity of ferrous material placed in a coil or transformer to provide a better path than air for magnetic flux, thereby increasing the inductance of the coil or increasing the coupling between the windings of a transformer.

Corona Discharge - A discharge of electricity appearing as a bluishpurple glow on the surface of or adjacent to a conductor when the voltage gradient exceeds a certain critical value; caused by ionization of the surrounding air by the high voltage.

Curing - A heating/drying process carried out in an elevated-temperature enclosure.

Current Carrying Capacity - The maximum current that can be continuously carried without causing permanent deterioration of electrical or mechanical properties of a device or conductor.

Dag (Aquadag) - A conductive graphite coating on the inner and outer side walls of some cathode-ray tubes.

Degreasing - The process of removing grease and oil from the surface of the basis material.

Dewatering - A process in which water is removed from sludge.

Dicing - Sawing or otherwise machining a semiconductor wafer into small squares or dice from which transistors and diodes can be fabricated.

Die - A tool or mold used to cut shapes to or form impressions on materials such as metals and ceramics.

Die Cutting (Also Blanking) - Cutting of plastic or metal sheets into shapes by striking with a punch.

Dielectric - A material that is highly resistant to the conductance of electricity; an insulator.

Di-n-octyl-phthalate - A liquid dielectric that is presently being substituted for a PCB dielectric fluid.

Diode (Semiconductor), (Also Crystal Diode, Crystal Rectifier) - A two-electrode semiconductor device that utilizes the rectifying properties of a p-n junction or point contact.

Discrete Device - Individually manufactured transistor, diode, etc.

Dissolved Solids - Theoretically the anhydrous residues of the dissolved constituents in water. Actually the term is defined by the method used in determination. In water and wastewater treatment, the Standard Methods tests are used.

Distribution Transformer - An element of an electric distribution system located near consumers which changes primary distribution voltage to a lower consumer voltage.

Dopant - An impurity element added to semiconductor materials used in crystal diodes and transistors.

Dragout - The solution that adheres to the part of workpiece and is carried past the edge of the tank.

Dry Electrolytic Capacitor - An electrolytic capacitor with a paste rather than liquid electrolyte.

Drying Beds - Areas for dewatering of sludge by evaporation and seepage.

Dry Slug - Usually refers to a plastic-encased sintered tantalum slug type capacitor.

Dry Transformer - Having the core and coils neither impregnated with an insulating fluid nor immersed in an insulating oil.

Effluent - The quantities, rates, and chemical, physical, biological and other constituents of waters which are discharged from point sources.

Electrochemical Machining - Shaping of an anode by the following process: The anode and cathode are placed close together and electrolyte is pumped into the space between them. An electrical potential is applied to the electrodes causing anode metal to be dissolved selectively, producing a shaped anode that complements the shape of the cathode.

Electrolyte - A nonmetallic electrical conductor in which current is carried by the movement of ions.

Electron Beam Lithography - Similar to photolithography - A fine beam of electrons is used to scan a pattern and expose an electronsensitive resist in the unmasked areas of the object surface.

Electron Discharge Lamp - An electron lamp in which light is produced by passage of an electric current through a metallic vapor or gas.

Electron Gun - An electrode structure that produces and may control, focus, deflect and converge one or more electron beams in an electron tube.

Electron Tube - An electron device in which conduction of electricity is accomplished by electrons moving through a vacuum of gaseous medium within a gas-tight envelope.

Electroplating - The production of a thin coating of one metal on another by electrode position.

Emissive Coating - An oxide coating applied to an electrode to enhance the emission of electrons.

Emulsion Breaking - Decreasing the stability of dispersion of one liquid in another.

End-of-Pipe Treatment - The reduction and/or removal of pollutants by chemical treatment just prior to actual discharge.

Epitaxial Layer - A (thin) semiconductor layer having the same crystalline orientation as the substrate on which it is grown.

Epitaxial Transistor - Transistor with one or more epitaxial layers.

Equalization - The process whereby waste streams from different sources varying in pH, chemical constituents, and flow rates are collected in a common container. The effluent stream from this equalization tank will have a fairly constant flow and pH level, and will contain a homogeneous chemical mixture. This tank will help to prevent unnecessary shock to the waste treatment system.

Etch - To corrode the surface of a metal in order to reveal its composition and structure.

Extrusion - Forcing the carbon-binder-mixture through a die under extreme pressure to produce desirable shapes and characteristics of the piece.

Field-effect Transistors - Transistors made by the metal-oxide-semiconductor (MOS) technique, differing from bipolar ones in that only one kind of charge carrier is active in a single device. Those that employ electrons are called n-MOS transistors; those that employ holes are p-MOS transistors.

Filament - (1) Metallic wire which is heated in an incandescent lamp to produce light by passing an electron current through it. (2) A cathode in a fluorescent lamp that emits electrons when electric current is passed through it.

Filtering Capacitor - A capacitor used in a power-supply filter system to provide a low-reactance path for alternating currents and thereby suppress ripple currents, without affecting direct currents.

Fixed Capacitor - A capacitor having a definite capacitance value that cannot be adjusted.

Float Gauge - A device for measuring the elevation of the surface of a liquid, the actuating element of which is a buoyant float that rests on the surface of the liquid and rises or falls with it. The elevation of the surface is measured by a chain or tape attached to the float.

Floc - A very fine, fluffy mass formed by the aggregation of fine suspended particles.

Flocculation - In water and wastewater treatment, the agglomeration of colloidal and finely divided suspended matter after coagulation by gentle stirring by either mechanical or hydraulic means. In biological wastewater treatment where coagulation is not used, agglomeration may be accomplished biologically.

Flocculator - An apparatus designed for the formation of floc in water or sewage.

Flow-proportioned Sample - A sampled stream whose pollutants are apportioned to contributing streams in proportion to the flow rates of the contributing streams.

Fluorescent Lamp - An electric discharge lamp in which phosphor materials transform ultraviolet radiation from mercury vapor ionization to visible light.

Forming - Application of voltage to an electrolytic capacitor, electrolytic rectifier or semiconductor device to produce a

desired permanent change in electrical characteristics as part of the manufacturing process.

Frit Seal - A seal made by fusing together metallic powders with a glass binder for such applications as hermetically sealing ceramic packages for integrated circuits.

Funnel - The rear, funnel-shaped portion of the glass enclosure of a cathode ray tube.

Fuse - Overcurrent protective device with a circuit-opening fusible part that would be heated and severed by overcurrent passage.

Gate - One of the electrodes in a field effect transistor.

Getter - A metal coating inside a lamp which is activated by an electric current to absorb residual water vapor and oxygen.

Glass - A hard, amorphous, inorganic, usually transparent, brittle substance made by fusing silicates, and sometimes borates and phosphates, with certain basic oxides and then rapidly cooling to prevent crystallization.

Glow Lamp - An electronic device, containing at least two electrodes and an inert gas, in which light is produced by a cloud of electrons close to the negative electrode when a voltage is applied between the electrodes.

Grab Sample - A single sample of wastewater taken at an "instant" in time.

Graphite - A soft black lustrous carbon that conducts electricity and is a constituent of coal, petroleum, asphalt, limestone, etc.

Grease - In wastewater, a group of substances including fats, waxes, free fatty acids, calcium and magnesium soaps, mineral oil and certain other nonfatty materials. The type of solvent and method used for extraction should be stated for quantification.

Grease Skimmer - A device for removing grease or scum from the surface of wastewater in a tank.

Green Body - An unbaked carbon rod or piece that is usually soft and quite easily broken.

Grid - An electrode located between the cathode and anode of an electron tube, which has one or more openings through which electrons or ions can pass, and which controls the flow of electrons from cathode to anode.

Grinding - The process of removing stock from a workpiece by the use of abrasive grains held by a rigid or semi-rigid binder.

Hardness - A characteristic of water, imparted by calcium, magnesium, and iron salts such as bicarbonates, carbonates, sulfates, chlorides, and nitrates. These cause curdling of soap, deposition of scale in boilers, damage in some industrial processes and sometimes objectionable taste. Hardness may be determined by a standard laboratory procedure or computed from the amounts of calcium and magnesium as well as iron, aluminum, manganese, barium, strontium, and zinc, and is expressed as equivalent calcium carbonate.

Heavy Metals - A general name given to the ions of metallic elements such as copper, zinc, chromium, and nickel. They are normally removed from wastewater by an insoluble precipitate (usually a metallic hydroxide).

Holding Tank - A reservoir to contain preparation materials so as to be ready for immediate service.

Hybrid Integrated Circuits - A circuit that is part integrated and part discrete.

Impact Extrusion - A cold extrusion process for producing tubular components by striking a slug of the metal, which has been placed in the cavity of the die, with a punch moving at high velocity.

Impregnate - To force a liquid substance into the spaces of a porous solid in order to change its properties.

Incandescent Lamp - An electric lamp producing light in which a metallic filament is heated white-hot in a vacuum by passage of an electric current through it.

Industrial Wastes - The liquid wastes from industrial processes as distinct from domestic or sanitary wastes.

Influent - Water or other liquid, either raw or partly treated, flowing into a reservoir basin or treatment plant.

In-Process Control Technology - The regulation and conservation of chemicals and rinse water at their point of use as opposed to end-of-pipe treatment.

Insulating Paper - A standard material for insulating electrical equipment, usually consisting of bond or kraft paper coated with black or yellow insulating varnish on both sides.

Insulation (Electrical Insulation) - A material having high electrical resistivity and therefore suitable for separating

adjacent conductors in an electric circuit or preventing possible future contact between conductors.

Insulator - A nonconducting support for an electric conductor.

Integrated Circuit - Assembly of electronic devices interconnected into circuits.

Interleaved Winding - An arrangement of winding coils around a transformer core in which the coils are wound in the form of a disk, with a group of disks for the low-voltage windings stacked alternately with a group of disks for the high-voltage windings.

Intermittent Filter - A natural or artificial bed of sand or other fine-grained material onto which sewage is intermittently flooded and through which it passes, with time allowed for filtration and the maintenance of aerobic conditions.

Ion Exchange - A reversible chemical reaction between a solid (ion exchanger) and a fluid (usually a water solution) by means of which ions may be interchanged from one substance to another. The superficial physical structure of the solid is not affected.

Ion Exchange Resins - Synthetic resins containing active groups (usually sulfonic, carboxylic, phenol, or substituted amino groups) that give the resin the ability to combine with or exchange ions with a solution.

Ion Implantation - A process of introducing impurities into the near surface regions of solids by directing a beam of ions at the solid.

Junction - A region of transition between two different semiconducting regions in a semiconductor device such as a p-n junction, or between a metal and a semiconductor.

Junction Box - A protective enclosure into which wires or cables are led and connected to form joints.

Knife Switch - Form of switch where moving blade enters stationary contact clips.

Klystron - An evacuated electron-beam tube in which an initial velocity modulation imparted to electrons in the beam results subsequently in density modulation of the beam; used as an amplifier in the microwave region or as an oscillator.

Lagoon - A man-made pond or lake for holding wastewater for the removal of suspended solids. Lagoons are also used as retention ponds after chemical clarification to polish the

effluent and to safeguard against upsets in the clarifier; for stabilization of organic matter by biological oxidation; for storage of sludge; and for cooling of water.

Landfill - The disposal of inert, insoluble waste solids by dumping at an approved site and covering with earth.

Lapping - The mechanical abrasion or surface planing of the semiconductor wafer to produce desired surface and wafer thickness.

Lime - Any of a family of chemicals consisting essentially of calcium hydroxide made from limestone (calcite) which is composed almost wholly of calcium carbonates or a mixture of calcium and magnesium carbonates.

Limiting Orifice - A device that limits flow by constriction to a relatively small area. A constant flow can be obtained over a wide range of upstream pressures.

Luminescent Materials - Materials that emit electromagnetic radiation (light) upon excitation by such energy sources as photons, electrons, applied voltage, chemical reactions or mechanical energy and which are specifically used as coatings in fluorescent lamps and cathode ray tubes.

Machining - The process of removing stock from a workpiece by forcing a cutting tool through the workpiece and removing a chip of basis material. Machining operations such as turning, milling, drilling, boring, tapping, planing, broaching, sawing and cutoff, shaving, threading, reaming, shaping, slotting, hobbing, filing, and chamfering are included in this definition.

Magnaflux Inspection - Trade name for magnetic particle test.

Make-up Water - Total amount of water used by any process/process step.

Mandrel - A metal support serving as a core around which the metals are wound and annealed to form a central hole.

Mask (Shadow Mask) - Thin sheet steel screen with thousands of apertures through which electron beams pass to a color picture tube screen. The color of an image depends on the balance from each of three different electron beams passing through the mask.

Metal Oxide Semiconductor Device - A metal insulator semiconductor structure in which the insulating layer is an oxide of the substrate material; for a silicon substrate, the insulating layer is silicon dioxide (SiO_2).

Mica - A group of aluminum silicate minerals that are characterized by their ability to split into thin, flexible flakes because of their basal cleavage.

Miligrams Per Liter (mg/l) - This is a weight per volume designation used in water and wastewater analysis.

Mixed Media Filtration - A filter which uses two or more filter materials of differing specific gravities selected so as to produce a filter uniformly graded from coarse to fine.

MOS - (See Metal Oxide Semiconductor).

Mount Assembly - Funnel neck ending of picture tube holding electron gun(s).

National Pollutant Discharge Elimination System (NPDES) - The federal mechanism for regulating point source discharge by means of permits.

Neutralization - Chemical addition of either acid or base to a solution such that the pH is adjusted to approximately 7.

Noncontact Cooling Water - Water used for cooling which does not come into direct contact with any raw material, intermediate product, waste product or finished product.

Oil-Filled Capacitor - A capacitor whose conductor and insulating elements are immersed in an insulating fluid that is usually, but not necessarily, oil.

Outfall - The point or location where sewage or drainage discharges from a sewer, drain, or conduit.

Oxide Mask - Oxidized layer of silicon wafer through which "windows" are formed which will allow for dopants to be introduced into the silicon.

Panel - The front, screen portion of the glass enclosure of a cathode ray tube.

PCB (Polychlorinated Biphenyl) - A colorless liquid, used as an insulating fluid in electrical equipment. (The future use of PCB for new transformers was banned by the Toxic Substances Control Act of October 1976).

pH - The negative of the logarithm of the hydrogen ion concentration. Neutral water has a pH value of 7. At pH lower than 7, a solution is acidic. At pH higher than 7, a solution is alkaline.

pH Adjustment - A means of maintaining the optimum pH through the use of chemical additives. Can be manual, automatic, or automatic with flow corrections.

Phase - One of the separate circuits or windings of a polyphase system, machine or other apparatus.

Phase Assembly - The coil-core assembly of a single phase of a transformer.

Phosphate Coating - A conversion coating on metal, usually steel, produced by dipping it into a hot aqueous solution of iron, zinc, or manganese phosphate.

Phosphor - Crystalline inorganic compounds that produce light when excited by ultraviolet radiation.

Photolithography - The process by which a microscopic pattern is transferred from a photomask to a material layer (e.g., SiO_2) in an actual circuit.

Photomask - A film or glass negative that has many high-resolution images, used in the production of semiconductor devices and integrated circuits.

Photon - A quantum of electromagnetic energy.

Photoresist - A light-sensitive coating that is applied to a substrate or board, exposed, and developed prior to chemical etching; the exposed areas serve as a mask for selective etching.

Picture Tube - A cathode ray tube used in television receivers to produce an image by varying the electron beam intensity as the beam scans a fluorescent screen.

Plate - (1) Preferably called the anode. The principal electrode to which the electron stream is attracted in an electron tube. (2) One of the conductive electrodes in a capacitor.

Polar Capacitor - An electrolytic capacitor having an oxide film on only one foil or electrode which forms the anode or positive terminal.

Pole Type Transformer - A transformer suitable for mounting on a pole or similar structure.

Poling - A step in the production of ceramic piezoelectric bodies which orients the axes of the crystallites in the preferred direction.

Polishing - The process of removing stock from a workpiece by the action of loose or loosely held abrasive grains carried to

the workpiece by a flexible support. Usually, the amount of stock removed in a polishing operation is only incidental to achieving a desired surface finish or appearance.

Pollutant - The term "pollutant" means dredged spoil, solid wastes, incinerator residue, sewage, garbage, sewage sludge, munitions, chemical wastes, biological materials, radioactive materials, heat, wrecked or discarded equipment, rock, sand, cellar dirt and industrial, municipal and agricultural waste discharged into water.

Pollutant Parameters - Those constituents of wastewater determined to be detrimental and, therefore, requiring control.

Pollution Load - A measure of the unit mass of a wastewater in terms of its solids or oxygen-demanding characteristics, or in terms of harm to receiving waters.

Polyelectrolytes - Synthetic or natural polymers containing ionic constituents, used as a coagulant or a coagulant aid in water and wastewater treatment.

Power Regulators - Transformers used to maintain constant output current for changes in temperature output load, line current and time.

Power Transformer - Transformer used at a generating station to step up the initial voltage to high levels for transmission.

Prechlorination - (1) Chlorination of water prior to filtration.
(2) Chlorination of sewage prior to treatment.

Precipitate - The discrete particles of material settled from a liquid solution.

Pressure Filtration - The process of solid/liquid phase separation effected by passing the more permeable liquid phase through a mesh which is impenetrable to the solid phase.

Pretreatment - Any wastewater treatment process used to reduce pollution load partially before the wastewater is introduced into a main sewer system or delivered to a treatment plant for substantial reduction of the pollution load.

Primary Feeder Circuit (Substation) Transformers - These transformers (at substations) are used to reduce the voltage from the subtransmission level to the primary feeder level.

Primary Treatment - A process to remove substantially all floating and settleable solids in wastewater and partially to reduce the concentration of suspended solids.

Primary Winding - Winding on the supply (i.e., input) side of a transformer.

Priority Pollutant - The 129 specific pollutants established by the EPA from the 65 pollutants and classes of pollutants as outlined in the consent decree of June 8, 1976.

Process Wastewater - Any water which, during manufacturing or processing, comes into direct contact with or results from the production or use of any raw materials, intermediate product, finished product, by-product, or waste product.

Process Water - Water prior to its direct contact use in a process or operation. (This water may be any combination of a raw water, service water, or either process wastewater or treatment facility effluent to be recycled or reused.)

Pyrolysis - The breaking apart of complex molecules into simpler units by the use of heat, as in the pyrolysis of heavy oil to make gasoline.

Quenching - Shock cooling by immersion of liquid or molten material in a cooling medium (liquid or gas). Used in metallurgy, plastics forming, and petroleum refining.

Raceway - A channel used to hold and protect wires, cables or busbars.

Rapid Sandfilter - A filter for the purification of water where water which has been previously treated, usually by coagulation and sedimentation, is passed through a filtering medium consisting of a layer of sand or prepared anthracite coal or other suitable material, usually from 24 to 30 inches thick and resting on a supporting bed of gravel or a porous medium such as carborundum. The filtrate is removed by a drain system. The filter is cleaned periodically by reversing the flow of the water through the filtering medium. Sometimes supplemented by mechanical or air agitation during backwashing to remove mud and other impurities.

Raw Wastewater - Plant water prior to any treatment or use.

Receiving Tubes - Multiterminal devices that conduct electricity more easily in one direction than in the other and are noted for their low voltage and low power applications. They are used to control or amplify electrical signals in radio and television receivers, computers, and sensitive control and measuring equipment.

Rectifier - (1) A device for converting alternating current into direct current. (2) a nonlinear circuit component that,

ideally, allows current to flow in one direction unimpeded but allows no current to flow in the other direction.

Recycled Water - Process wastewater or treatment facility effluent which is recirculated to the same process.

Resistor - A device designed to provide a definite amount of resistance, used in circuits to limit current flow or to provide a voltage drop.

Retention Time - The time allowed for solids to collect in a settling tank. Theoretically retention time is equal to the volume of the tank divided by the flow rate. The actual retention time is determined by the purpose of the tank. Also, the design residence time in a tank or reaction vessel which allows a chemical reaction to go to completion, such as the reduction of hexavalent chromium or the destruction of cyanide.

Reused Water - Process wastewater or treatment facility effluent which is further used in a different manufacturing process.

Rinse - Water for removal of dragout by dipping, spraying, fogging etc.

Sanitary Sewer - A sewer that carries liquid and water wastes from residences, commercial buildings, industrial plants, and institutions together with ground, storm, and surface waters that are not admitted intentionally.

Sanitary Water - The supply of water used for sewage transport and the continuation of such effluents to disposal.

Secondary Settling Tank - A tank through which effluent from some prior treatment process flows for the purpose of removing settleable solids.

Secondary Wastewater Treatment - The treatment of wastewater by biological methods after primary treatment by sedimentation.

Secondary Winding - Winding on the load (i.e. output) side of a transformer.

Sedimentation - Settling of matter suspended in water by gravity. It is usually accomplished by reducing the velocity of the liquid below the point at which it can transport the suspended material.

Semiconductor - A solid crystalline material whose electrical conductivity is intermediate between that of a metal and an insulator.

Settleable Solids - (1) That matter in wastewater which will not stay in suspension during a preselected settling period, such as one hour, but either settles to the bottom or floats to the top. (2) In the Imhoff cone test, the volume of matter that settles to the bottom of the cone in one hour.

Sewer - A pipe or conduit, generally closed, but normally not flowing full, for carrying sewage and other waste liquids.

Silvering - The deposition of thin films of silver on glass, etc. carried by one of several possible processes.

Skimming Tank - A tank so designed that floating matter will rise and remain on the surface of the wastewater until removed, while the liquid discharges continuously under walls or scum boards.

Sludge - The solids (and accompanying water and organic matter) which are separated from sewage or industrial wastewater.

Sludge Cake - The material resulting from air drying or dewatering sludge (usually forkable or spadable).

Sludge Disposal - The final disposal of solid wastes.

Sludge Thickening - The increase in solids concentration of sludge in a sedimentation or digestion tank.

Snubber - Shock absorber.

Soldering - The process of joining metals by flowing a thin (capillary thickness) layer of nonferrous filler metal into the space between them. Bonding results from the intimate contact produced by the dissolution of a small amount of base metal in the molten filler metal, without fusion of the base metal.

Solvent - A liquid capable of dissolving or dispersing one or more other substances.

Solvent Degreasing - The removal of oils and grease from a workpiece using organic solvents or solvent vapors.

Sputtering - A process to deposit a thin layer of metal on a solid surface in a vacuum. Ions bombard a cathode which emits the metal atoms.

Stacked Capacitor - Device containing multiple layers of dielectric and conducting materials and designed to store electrical charge.

Stamping - Almost any press operations including blanking, shearing, hot or cold forming, drawing, blending, or coining.

Steel - An iron-based alloy, malleable under proper conditions, containing up to about 2% carbon.

Step-Down Transformers - (Substation) - A transformer in which the AC voltages of the secondary windings are lower than those applied to the primary windings.

Step-Up Transformer - Transformer in which the energy transfer is from a low-voltage primary (input) winding to a high-voltage secondary (output) winding or windings.

Studs - Metal pins in glass of picture tube onto which shadow mask is hung.

Substation - Complete assemblage of plant, equipment, and the necessary buildings at a place where electrical energy is received (from one more power-stations) for conversion (e.g., from AC to DC by means of rectifiers, rotary converters), for stepping-up or down by means of transformers, or for control (e.g. by means of switch-gear, etc.).

Subtransmission (Substation) Transformers - At the end of a transmission line, the voltage is reduced to the subtransmission level (at substations) by subtransmission transformers.

Suspended Solids - (1) Solids that are either floating or in suspension in water, wastewater, or other liquids, and which are largely removable by laboratory filtering. (2) The quantity of material removed from wastewater in a laboratory test, as prescribed in "Standard Methods for the Examination of Water and Wastewater" and referred to as non-filterable residue.

Tantalum - A lustrous, platinum-gray ductile metal used in making dental and surgical tools, penpoints, and electronic equipment.

Tantalum Foil - A thin sheet of tantalum, usually less than 0.006 inch thick.

Terminal - A screw, soldering lug, or other point to which electric connections can be made.

Testing - A procedure in which the performance of a product is measured under various conditions.

Thermoplastic Resin - A plastic that solidifies when first heated under pressure, and which cannot be remelted or remolded without destroying its original characteristics; examples are epoxides, melamines, phenolics and ureas.

Transformer - A device used to transfer electric energy, usually that of an alternating current, from one circuit to another; especially, a pair of multiply-wound, inductively coupled wire coils that effect such a transfer with a change in voltage, current, phases, or other electric characteristics.

Transistor - An active component of an electronic circuit consisting of a small block of semiconducting material to which at least three electrical contacts are made; used as an amplifier, detector, or switch.

Transmitting Tubes - These tubes are characterized by the use of electrostatic and electromagnetic fields applied externally to a stream of electrons to amplify a radio frequency signal. There are several different types of transmitting tubes such as klystrons, magnetrons and traveling wave tubes. They generally are high powered devices operating over a wide frequency range. They are larger and structurally more rugged than receiving tubes, and are completely evacuated.

Trickling Filter - A filter consisting of an artificial bed of coarse material, such as broken stone, clinkers, slats, or brush over which sewage is distributed and applied in drops, films, or spray, from troughs, drippers, moving distributors or fixed nozzles and through which it trickles to the underdrain giving opportunity for the formation of zoogleal slimes which clarify the oxidized sewage.

Trimmer Capacitors - These are relatively small variable capacitors used in parallel with larger variable or fixed capacitors to permit exact adjustment of the capacitance of the parallel combination.

Vacuum Filter - A filter consisting of a cylindrical drum mounted on horizontal axis, covered with a filter cloth revolving with a partial submergence in liquid. A vacuum is maintained under the cloth for the larger part of a revolution to extract moisture and the cake is scraped off continuously.

Vacuum Metalizing - The process of coating a workpiece with metal by flash heating metal vapor in a high-vacuum chamber containing the workpiece. The vapor condenses on all exposed surfaces.

Vacuum Tube - An electron tube vacuated to such a degree that its electrical characteristics are essentially unaffected by the presence of residual gas or vapor.

Variable Capacitor - A device whose capacitance can be varied continuously by moving one set of metal plates with respect to another.

Voltage Breakdown - The voltage necessary to cause insulation failure.

Voltage Regulator - Like a transformer, it corrects changes in current to provide continuous, constant current flow.

Welding - The process of joining two or more pieces of material by applying heat, pressure or both, with or without filler material, to produce a localized union through fusion or recrystallization across the interface.

Wet Air Scrubber - Air pollution control device which uses a liquid or vapor to absorb contaminants and which produces a wastewater stream.

Wet Capacitor - (See oil-filled capacitor).

Wet Slug Capacitor - Refers to a sintered tantalum capacitor where the anode is placed in a metal can, filled with an electrolyte and then sealed.

Wet Tantalum Capacitor - A polar capacitor the cathode of which is a liquid electrolyte (a highly ionized acid or salt solution).

Wet Transformer - Having the core and coils immersed in an insulating oil.

Yoke - A set of coils placed over the neck of a magnetically deflected cathode-ray tube to deflect the electron beam horizontally and vertically when suitable currents are passed through the coils.

APPENDIX 1

PLANT 99797 RAW WASTES SELF MONITORING DATA

Pollutant Concentrations (mg/l)

	Lead	Zinc	Chromium	Cadmium	Copper	Silver	Nickel	Fluoride	TSS
1	--	2.9	2.7	0.09	0.7	<0.05	0.1	--	150
2	--	2.9	0.3	0.04	0.2	<0.05	0.1	--	182
3	--	2.7	2.7	0.04	0.2	<0.05	<0.1	--	135
4	--	2.1	0.7	0.1	0.3	<0.06	0.2	--	2046
5	--	2.1	1.1	0.1	0.1	<0.06	0.1	--	992
6	--	2.8	1.3	0.05	0.02	<0.06	0.2	--	140
7	73	2.6	0.5	0.04	0.4	<0.06	0.2	104	619
8	--	5.5	3.2	0.03	0.3	<0.06	0.2	--	725
9	23	2.8	2.7	0.1	0.2	<0.06	0.2	236	117
10	--	1.9	4.0	0.07	0.3	<0.06	0.2	--	146
11	--	2.6	2.5	0.06	0.4	<0.06	<0.15	--	42
12	--	3.0	0.8	0.13	1.9	<0.06	<0.15	--	142
13	--	3.1	1.3	0.15	0.4	<0.06	<0.15	--	200
14	77	3.1	1.6	0.12	1.4	<0.06	0.08	221	62
15	--	3.1	2.6	0.09	3.2	<0.06	0.25	--	84
16	--	1.9	0.8	0.11	0.4	<0.06	<0.15	--	85
17	--	3.3	1.6	0.17	0.2	<0.06	0.2	--	365
18	58	3.4	2.1	0.24	0.3	<0.06	0.2	26	652
19	--	3.5	2.1	0.22	0.3	<0.06	0.2	--	902
20	--	3.6	0.07	0.18	0.5	<0.06	0.2	--	51
21	52	4.3	0.07	0.19	0.5	<0.06	0.3	240	436
22	--	4.2	0.18	0.11	0.7	<0.06	<0.15	--	138
23	--	4.4	0.36	0.14	0.6	<0.06	<0.15	--	908
24	--	3.7	1.32	0.14	0.4	<0.06	0.3	--	625
25	46	3.5	0.92	0.10	0.7	<0.06	0.17	292	91
26	--	3.7	0.92	0.08	1.2	<0.06	0.08	--	70
27	--	3.9	1.3	0.11	0.9	<0.06	<0.01	--	620

A1-1

APPENDIX 1 - continued

PLANT 99797 RAW WASTE SELF MONITORING DATA (continued)

	Lead	Zinc	Chromium	Cadmium	Copper	Silver	Nickel	Fluoride	TSS
28	--	3.7	0.9	0.26	0.3	<0.06	0.3	--	2172
29	99	3.7	0.9	0.20	0.3	<0.06	0.11	115	1479
30	--	3.7	0.9	0.22	0.9	<0.06	0.22	--	1423
31	--	3.8	1.0	0.19	0.4	<0.06	0.33	--	1912
32	--	3.7	0.9	0.05	1.8	<0.06	0.33	--	170
33	84	3.8	1.9	0.30	0.9	<0.06	1.00	80	1391
34	112	--	--	--	--	--	--	45	--
35	132	3.4	2.17	0.16	2.8	<0.06	<0.09	175	260
36	--	3.4	1.46	0.11	0.5	--	0.27	--	271
37	--	3.5	2.46	0.14	1.12	<0.06	0.15	--	1792
38	50							210	
39	72							154	
40	68							250	
41	58							240	
42	117							585	
43	44							210	
44	17							250	
45	48							205	
46	45							175	
47	79							63	
48	192							260	
49	139							235	
50	67							390	
51	167							215	
52	65							220	
53	33							250	
54	152							460	
55	158							309	
56	60							24	
57	9							40	

AI-2

APPENDIX 1 - continued

PLANT 99797 RAW WASTE SELF MONITORING DATA (continued)

	Lead	Zinc	Chromium	Cadmium	Copper	Silver	Nickel	Fluoride	TSS
58	15							48	
59	13							67	
60	29							60	
61	10							165	
62	14							53	

APPENDIX 2

PLANT 30172 SELF MONITORING
EFFLUENT DATA FOR FLUORIDE

Fluoride Concentration mg/l

1	14.71
2	15.33
3	14.18
4	15.27
5	15.30
6	13.47
7	36.40
8	12.68
9	14.98
10	20.2
11	16.5
12	19.1
13	13.8
14	15.7
15	13.0
16	16.4
17	16.2
18	17.4
19	15.5
20	11.0
21	12.2
22	18.8
23	11.9
24	21.2
25	18.3
26	16.4
27	15.9

APPENDIX 3

PLANT 30172 TTO MONITORING DATA

Parameters (>0.01 mg/l)
- Trichloroethane - 1.142 mg/l

Plant Effluent - 425 gpm
Cooling Water - 117 gpm
Net Flow 308 gpm

$$1.142 \text{ mg/l} \times \frac{425 \text{ gpm}}{308 \text{ gpm}} = 1.58 \text{ mg/l}$$

APPENDIX 4

PLANT 99798 EFFLUENT MONITORING DATA

POLLUTANT CONCENTRATIONS (mg/l)

	Sampler Source	Fluoride	Cadmium	Chromium	Lead	Zinc
1	Industry	11.2	0.010	0.250	--	0.590
2	POTW	16.6	0.03	0.28	0.45	0.45
3	Industry	11.9	0.020	0.240	--	0.058
4	Industry	12.4	0.020	0.208	--	0.323
5	POTW	14.4	0.01	0.47	0.50	0.15
6	Industry	14.8	0.010	0.810	--	0.260
7	Industry	10.8	0.020	0.104	--	0.169
8	Industry	11.5	0.018	0.150	--	0.230
9	POTW	4.3	0.01	0.14	0.20	0.13
10	Industry	11.5	0.010	0.150	--	0.230
11	Industry	12.4	0.020	0.241	--	0.400
12	Industry	12.0	0.005	0.040	--	0.100
13	Industry	9.0	0.01	0.14	--	0.09
14	POTW	8.6	<0.01	0.75	0.26	0.27
15	Industry	9.0	0.01	0.54	--	0.31
16	Industry	9.2	0.09	0.22	--	0.15
17	Industry	16.0	0.03	0.24	0.08	0.25
18	POTW	26.6	0.01	0.69	<0.096	0.37
19	Industry	13.9	0.03	0.11	<0.30	0.25
20	Industry	15.8	0.02	0.11	<0.02	0.07

APPENDIX A

Calculation of Limitations for the Electrical and Electronic Components - Phase II Category.

Introduction

This memorandum describes the development of final effluent limitations for fluoride (F), cadmium (Cd), chromium (Cr), lead (Pb) and zinc (Zn) which are regulated in the Cathode Ray Tube (CRT) subcategory of the Electrical and Electronic Components - Phase II (EEC) category. Since proposal of the EEC regulation changes have been made to the data base used for development of the concentration limitations. The data base changes include the deletion of data for technical reasons and the addition of data supplied by industry. The Inorganic Chemicals Branch, Effluent Guidelines Division has evaluated the wastewater treatment systems in the EEC plants that provided data to ensure that only the data from CRT plants which have technically acceptable lime and settle wastewater treatment systems were used for limitation development (see Chapter VII of the EEC Development Document). Plants in the Luminescent Materials (LM) subcategory of the EEC category were also sampled by the Agency. The LM limitations incorporate both the Agency's LM data and variability estimates from the CRT category which are described in this memorandum. The details of limitation development for the LM subcategory are explained in Chapter VII of the EEC Development Document.

Data

Two sources of pollutant concentration measurement data were used; data that had been collected under the Agency's supervision and data that had been collected and supplied by industry. The Agency's data consists of Cd, Cr, Pb and Zn concentrations measured in samples taken over 3 consecutive days from the raw untreated wastewaters and treated effluent wastewater of CRT plant number 99796. The Agency's data from plant 99796 are listed in Appendix B.

This analysis used industry supplied concentrations of F, Cd, Cr, Pb and Zn that had been measured in samples taken from the treated wastewater streams of two CRT plants. Plant 30172 provided 27 F monthly averages that were reported from January 1979 to June 1982. Each of the 27 monthly values is an average of four F concentration values that were measured during the month. The F data from plant 30172 are listed in Appendix C. Plant 99798 supplied concentrations of F, Cd, Cr, Pb, and Zn measured in samples taken from the plant's treated wastewaters by either the local publicly owned treatment works or plant personnel. Plant 99798 had eight Pb concentration measurements and 20 F, Cd, Cr, and Zn concentration measurements. Concentration measurements at plant 99798 were reported from 13

January 1982 to 23 March 1983. Appendix D is a listing of the effluent data from plant 99798.

Analysis

The pollutant concentration limitations for F, Cd, Cr, Pb, and Zn were determined on the basis of a lognormal distribution fit to the data. The basic assumption underlying this procedure is that the pollutant concentration data are lognormally distributed by plant. The lognormal has been found to provide a satisfactory fit to effluent data in a wide range of industrial categories for a variety of pollutants and usually provides a good approximation for the distribution of treated effluent pollutant concentration measurements. Shapiro-Wilk goodness-of-fit tests were performed on the pollutant concentration data from plant 99798 because a reasonable number of daily concentration measurements (8 to 20 depending on the pollutant) were available. The test results indicated that the use of the lognormal is not inconsistent with these data; each of the distributions of daily F, Cd, Cr, Pb, and Zn concentrations were not statistically different from lognormal. Goodness-of-fit tests were applied to the data from plant 99796 and indicate that the use of the lognormal is not inconsistent with the Cr, Pb, and Zn concentrations. Two of the three Cd values were the same. A small data set with two or more identical values will reject any hypothesized distributional form. In general goodness-of-fit tests applied to extremely small data sets are not very powerful.

Lognormal goodness-of-fit tests were not applied to the F data from plant 30172 because the only available data were 27 averages of four daily observations taken during each month. The goodness-of-fit tests, used in this analysis, are intended to examine if the distribution of daily values are significantly different from lognormal. The distribution of four day averages from plant 30172 cannot be used to perform a goodness-of-fit test on the distribution of daily values. The individual daily observations that comprise these averages were not provided by industry.

A generalized form of the lognormal distribution, known as the delta lognormal (DLN) distribution, was used to model the data. The DLN models the data as a mixture of zeroes and values above zero that are lognormal distributed. This distribution is described in Chapter 9 of The Lognormal Distribution, by Aitchison and Brown, Cambridge University Press, 1963. The DLN was used because of the presence in the data of observations below the detection limit. Owen, W.J. and DeRouen, T.A. (1980. Estimation of the Mean for Lognormal Data Containing Zeros and Left Censored values, *Biometrics* 36, 707-719), recommended that when data contain below detection limit values the estimate of the mean is most stable and has the lowest mean square error when the below detection limit values are set to zero and the DLN distribution is used to model the data. Plant 99798 is the only

plant with values reported below the detection limit; the detection limit values from plant 99798 have been set to zero. The DLN distribution parameters (delta, logvariance, and logmean) were estimated for each pollutant from each plant.

The daily maximum limitations are based upon estimates of the 99th percentile of the distribution of individual daily values. These estimates were determined by substituting estimates of the DLN distribution parameters, described above, into the mathematical expression for the 99th percentile of the DLN distribution. The monthly average limitations were based on the 95th percentile of the distribution of averages of 10 samples drawn from the distribution of daily values.

Variability factors (VF) were calculated by dividing the percentile estimates for each pollutant at each plant by the estimated mean of the distribution daily effluent concentrations. The plant VFs and plant arithmetic averages were arithmetically averaged to determine an overall average and an overall VF for each pollutant. Table 1 contains the VFs and averages used for limitation development. The methodological details are presented in Appendix E. This method of averaging gives equal consideration to the information from each plant. These plants are equally representative of the effluent pollutant concentrations that can be achieved by plants in the EEC industry and have therefore been weighted equally. The use of various measures of central tendency in the context of effluent guidelines development previously had been discussed in a memorandum from Henry D. Kahn to George M. Jett titled "Averaging Methods Used in Determining BPT Effluent Guidelines Limitations for the Pesticide Industry", March 13, 1978.

Daily maximum limitations and 10 day average limitations are estimated by multiplying the appropriate overall VF by the corresponding overall arithmetic average. Table 2 presents the final overall average, variability factors, and limitations for the CRT subcategory of the EEC category.

Table 1: Summary Statistics of Plants Used for Limitation Development in the Cathode Ray Tube Subcategory of the Electrical and Electronic Components - Phase II Category

<u>POLLUTANT</u> (mg/l)	<u>SOURCE</u> ¹	<u>PLANT</u>	<u>N</u> ²	<u>AVERAGE</u> ³	<u>DAILY</u> <u>VF</u>	<u>MONTHLY</u> <u>VF</u>
FLUORIDE	IND	99798	20	12.6	2.16	1.21
	IND	30172	27	<u>16.4</u>	<u>2.64</u>	<u>1.28</u>
		Overall ⁶		14.5	2.40	1.25
CADMIUM	EPA	99796	3	0.019	1.69	1.14
	IND	99798	20	<u>0.020</u>	<u>3.85</u>	<u>1.46</u>
		Overall ⁶		0.020	2.77	1.30
CHROMIUM	EPA	99796	3	0.163	1.20	1.04
	IND	99798	20	<u>0.294</u>	<u>4.50</u>	<u>1.55</u>
		Overall ⁶		0.229	2.85	1.30
LEAD	EPA	99796	3	0.300	2.16	1.22
	IND	99798	8	<u>0.238</u>	<u>6.16</u>	<u>1.86</u>
		Overall ⁶		0.269	4.16	1.54
ZINC	EPA	99796	3	0.550	3.37	1.42
	IND	99798	20	<u>0.243</u>	<u>3.59</u>	<u>1.41</u>
		Overall ⁶		0.397	3.48	1.42

- ¹SOURCE indicates who conducted the wastewater sampling. IND is industry. EPA is the Agency.
- ²N is the number of pollutant concentration measurements.
- ³AVERAGE is the arithmetic average of all the values for a pollutant from a plant. Values that were recorded as below a detection limit were set at the detection limit in computing the average. This may slightly increase the amount of pollutant that appears to be present.
- ⁴DAILY VF is the ratio of the estimate of the 99th percentile of the lognormally distributed daily values to an estimate of the expected or average pollutant concentration.
- ⁵MONTHLY VF is the ratio of the estimate of the 95th percentile of the lognormally distributed averages of 10 values to an estimate of the expected or average pollutant concentrations.
- ⁶Overall is the unweighted arithmetic average of the individual plant

estimates of AVERAGE, DAILY VF, and MONTHLY VF. These overall averages are used for limitation development.

Table 2: A Listing of the Overall Average, Overall Daily VF's, Overall Monthly VFs, Daily Limitations, and Monthly Limitations for the Cathode Ray Tube Subcategory of the Electrical and Electronic Components - Phase II Category

<u>POLLUTANT</u> <u>(mg/l)</u>	<u>OVERALL</u> <u>AVERAGE</u>	<u>DAILY</u> <u>MAXIMUM</u>		<u>MONTHLY</u> <u>AVERAGE (10 Values)</u>	
		<u>VF</u>	<u>LIMITATION</u>	<u>VF</u>	<u>LIMITATION</u>
FLUORIDE	14.0	2.40	35.0	1.25	18.0
CADMIUM	0.020	2.77	0.055	1.30	0.026
CHROMIUM	0.229	2.85	0.653	1.30	0.298
LEAD	0.269	4.16	1.120	1.54	0.414
ZINC	0.397	3.48	1.38	1.42	0.564

APPENDIX B

A Listing of the Data from Plant 99796

A Listing of the Pollutant Concentrations Measured in
Samples Taken from the Treated Effluent Wastestream of
Cathode Ray Tube Plant 99796

<u>Pollutants (mg/l)</u>				
<u>DATE</u>	<u>Cd</u>	<u>Cr</u>	<u>Pd</u>	<u>ZN</u>
10/6/82	0.021	0.150	0.400	0.944
10/7/82	0.021	0.176	0.200	0.345
10/8/82	0.014	0.164	0.300	0.360

APPENDIX C

A Listing of the Fluoride Data from Plant 30172

A Listing of Monthly Average¹ Fluoride Concentrations from
the Treated Effluent Wastestream of
Cathode Ray Tube Plant 30172

<u>Date</u>	<u>F(mg/l)</u>	<u>Date</u>	<u>F(mg/l)</u>
1/79	14.71	7/81	16.40
2/79	15.33	8/81	16.20
3/79	14.18	9/81	17.40
4/79	15.27	10/81	15.50
5/79	15.30	11/81	11.00
6/79	13.47	12/81	12.20
7/79	36.40	1/81	18.80
8/79	12.68	2/82	11.90
1/81	14.98	3/82	21.20
2/81	20.20	4/82	18.30
3/81	16.50	5/82	16.40
4/81	19.10	6/82	15.90
5/81	13.80		
6/81	15.70		

¹ Each Monthly Average is Calculated Using Four Daily Values Taken During the Month. The Individual Daily Values were not Available.

APPENDIX D

A Listing of the Pollutant Concentration Data from Plant 99798

A Listing of the Pollutant Concentrations Measured in
 Samples Taken from the Treated Effluent Wastestreams of
 Cathode Ray Tube Plant 99798

Pollutants (mg/l)						
<u>DATE</u>	<u>F</u>	<u>Cd</u>	<u>Cr</u>	<u>Pb</u>	<u>Zn</u>	<u>pH</u>
1/13/82	11.2	0.010	0.250		0.590	6.00
1/13/82	16.6	0.030	0.280	0.450	0.450	6.50
2/11/82	11.9	0.020	0.240	0.240	0.058	6.00
3/29/82	12.4	0.020	0.208		0.323	6.00
4/05/82	14.4	0.010	0.470	0.500	0.150	6.80
4/30/82	14.8	0.010	0.810		0.260	6.00
5/25/82	10.8	0.020	0.104		0.169	
6/28/82	11.5	0.018	0.150		0.230	6.00
7/ /82	11.5	0.010	0.150		0.230	6.58
7/21/82	4.3	0.010	0.140	0.200	0.130	7.20
8/ /82	12.4	0.020	0.241		0.400	6.27
9/ /82	12.0	0.005	0.040		0.100	6.60
10/12/82	9.0	0.010	0.140		0.090	6.68
11/8/82	8.6	<0.010	0.750	0.260	0.270	7.40
11/16/82	9.0	0.010	0.450		0.310	6.50
12/16/82	9.2	0.090	0.220		0.150	6.24
1/25/83	16.0	0.030	0.240	0.080	0.25	5.64
1/31/83	26.6	0.010	0.690	<0.096	0.37	6.20
3/15/83	13.9	0.030	0.110	<0.030	0.25	6.37
3/23/83	15.8	0.020	0.110	<0.020	0.07	6.53

APPENDIX E

Details of the Notation and Formulas Used to
Estimate Averages, Variability Factors, and Limitations

Definitions

K	total number of plants.
N_i	total number of observations at plant i.
NO_i	total number of below detection limit observations at plant i.
$Nl_i = N_i - NO_i$	total number of values that were not below the detection limit at plant i.
$\delta_i = NO_i/N_i$	delta, percent of the observations from plant i that were below the detection limit.
$q_i = (.99 - \delta_i)/(1 - \delta_i)$	the 99th quantile of the delta lognormal distribution.
v_{q_i}	the quantile of order q_i of the $N(0,1)$ distribution.
X_{ij}	the concentration of a pollutant in mg/l. Observation j at plant i; $j=1\dots N_i$; $i=1\dots K$.
$\ln(X_{ij}) = Y_{ij}$	natural logarithm of the pollutant concentration values that are not below the detection limit.
$\bar{Y}_i = \mu_i = \sum_{j=1}^{Nl_i} Y_{ij}/Nl_i$	mean of the logarithms at plant i.
$\sigma_i^2 = \sum_{j=1}^{Nl_i} (\bar{Y}_i - Y_{ij})^2/Nl_i - 1$	within plant i logvariance. ¹
$\sigma_i = \sqrt{\sigma_i^2}$	within plant i log standard deviation. ¹
$Y_{.99} = e^{\mu_i + v_{q_i}\sigma_i}$	estimated 99th percentile of the distribution of Y_i .

¹ Because the F data from plant 30172 were averages of four measurements taken during the month the logvariance of daily observations was estimated by multiplying the logvariance of the monthly averages by 4 and the log standard deviation of the daily observations was estimated by multiplying the log standard deviation of the monthly averages by the square root of 4.

$$\bar{X}_i = \sum_{j=1}^{N_i} X_{ij}/N_i$$

arithmetic mean of the pollutant concentrations. Values reported as below a detection limit were averaged using the detection limit value.

$$\mu (10)_i = \mu_i + \sigma_i^2 / 2 -$$

ten day log mean estimate for plant i.

$$(0.5) \ln \left(\frac{e^{\sigma_i^2}}{10} + \frac{10-1}{10} \right)$$

$$\sigma^2 (10)_i = \ln \left(\frac{e^{\sigma_i^2}}{10} + \frac{10-1}{10} \right)$$

ten day logvariance estimate for plant i.

$$\delta (10)_i = \delta_i^{10} \approx 0$$

the estimate of δ for the ten day average distribution.

$$X(10)_{.95i} =$$

the ten day average 95th percentile estimate.

$$e^{\mu (10)_i + 1.645 \sigma (10)_i}$$

$$t = 0.5 \left(\frac{\sigma^2}{i} \right)$$

argument of the Bessel Function approximation.

$$\psi_{n_i}(t) = e^t \left\{ 1 - [t(t+1)/n_i] + [t^2(3t^2+22t+21)/6n_i^2] \right\}$$

an approximation of the Bessel function used in the maximum efficiency estimate for $E(X)_i$.

$$E(X)_i = (n_i! / n_i^i) (e\mu) \psi_{n_i}(t)$$

the estimated mean (expected value) of the distribution of X.

$$VF_i = X_{.95i} / E(X)_i$$

the daily variability factor for plant i.

$$VF = \sum_{i=1}^K VF_i / K$$

the overall daily variability factor.

$$VF(10)_i = X(10)_{.95i} / E(X)_i$$

the ten day average variability factor for plant i.

$$VF(10) = \sum_{i=1}^K VF(10)_i / K$$

the overall ten day variability factor.

$$\bar{X} = \sum_{i=1}^K \bar{X}_i / K$$

the overall average for a pollutant.

Daily Limit = VF (\bar{X})

Daily Limitation.

10 Day Average Limit = VF(10) (\bar{X})

10 Day Average Monthly Limitation.