

CS2P-50174

TREATMENT TECHNOLOGY BACKGROUND DOCUMENT

PB 91-160 556

Larry Rosengrant
Section Chief

Laura Lopez
Project Officer

U.S. Environmental Protection Agency
Office of Solid Waste
401 M Street, SW
Washington, DC 20460

January 1991

TABLE OF CONTENTS

<u>Section</u>	<u>Page No.</u>
EXECUTIVE SUMMARY	viii
Applicability	xi
Underlying Principles of Operation	xiii
Description of the Treatment Process	xiv
Waste Characteristics Affecting Performance (WCAPs)	xv
Design and Operating Parameters	xvii
I. TREATMENT TECHNOLOGIES	
A. DESTRUCTION TECHNOLOGIES	
1. BIOLOGICAL TREATMENT	1
1.1 Applicability	1
1.2 Underlying Principles of Operation	1
1.3 Description of Biological Treatment Processes	3
1.4 Waste Characteristics Affecting Performance (WCAPs).	8
1.5 Design and Operating Parameters	11
1.6 References	16
2. CHEMICAL OXIDATION	17
2.1 Applicability	17
2.2 Underlying Principles of Operation	18
2.3 Description of Chemical Oxidation Processes	21
2.4 Waste Characteristics Affecting Performance (WCAPs).	23
2.5 Design and Operating Parameters	24
2.6 References	28
3. CHEMICAL REDUCTION	29
3.1 Applicability	29
3.2 Underlying Principles of Operation	29
3.3 Description of Chemical Reduction Process	30
3.4 Waste Characteristics Affecting Performance (WCAPs).	32
3.5 Design and Operating Parameters	33
3.6 References	37

TABLE OF CONTENTS (CONTINUED)

<u>Section</u>	<u>Page No.</u>
4. ELECTROLYTIC OXIDATION OF CYANIDE	38
4.1 Applicability	38
4.2 Underlying Principles of Operation	38
4.3 Description of Electrolytic Oxidation of Cyanide Process	39
4.4 Waste Characteristics Affecting Performance (WCAPs).	39
4.5 Design and Operating Parameters	40
4.6 References	43
5. INCINERATION	44
5.1 Applicability	44
5.2 Underlying Principles of Operation	45
5.3 Description of Incineration Process	46
5.4 Waste Characteristics Affecting Performance (WCAPs).	54
5.5 Design and Operating Parameters	57
5.6 References	63
6. WET AIR OXIDATION	64
6.1 Applicability	64
6.2 Underlying Principles of Operation	66
6.3 Description of Wet Air Oxidation Process	66
6.4 Waste Characteristics Affecting Performance (WCAPs).	67
6.5 Design and Operating Parameters	70
6.6 References	73
B. TECHNOLOGIES THAT REDUCE THE SOLUBILITY OR LEACHABILITY OF METALS	
1. AMALGAMATION	74
1.1 Applicability	74
1.2 Underlying Principles of Operation	74
1.3 Description of Amalgamation Treatment Processes	75
1.4 Waste Characteristics Affecting Performance (WCAPs).	75
1.5 Design and Operating Parameters	77
1.6 References	80

TABLE OF CONTENTS (CONTINUED)

<u>Section</u>		<u>Page No.</u>
2.	CHEMICAL PRECIPITATION	81
2.1	Applicability	81
2.2	Underlying Principles of Operation	82
2.3	Description of Chemical Precipitation Process	83
2.4	Waste Characteristics Affecting Performance (WCAPs).	85
2.5	Design and Operating Parameters	89
2.6	References	93
3.	ENCAPSULATION	94
3.1	Applicability	94
3.2	Underlying Principles of Operation	94
3.3	Description of Encapsulation Processes	94
3.4	Waste Characteristics Affecting Performance (WCAPs).	96
3.5	Design and Operating Parameters	98
3.6	References	101
4.	STABILIZATION OF METALS	102
4.1	Applicability	102
4.2	Underlying Principles of Operation	102
4.3	Description of Stabilization Process	104
4.4	Waste Characteristics Affecting Performance (WCAPs).	104
4.5	Design and Operating Parameters	106
4.6	References	110
5.	VITRIFICATION	111
5.1	Applicability	111
5.2	Underlying Principles of Operation	112
5.3	Description of Vitrification Processes	113
5.4	Waste Characteristics Affecting Performance (WCAPs).	115
5.5	Design and Operating Parameters	119
5.6	References	124

TABLE OF CONTENTS (CONTINUED)

<u>Section</u>		<u>Page No.</u>
II. REMOVAL TECHNOLOGIES		
A.	RECOVERY, REUSE, AND/OR SEPARATION TECHNOLOGIES FOR ORGANICS	
1.	CARBON ADSORPTION	125
1.1	Applicability	125
1.2	Underlying Principles of Operation	125
1.3	Description of Carbon Adsorption Process	125
1.4	Waste Characteristics Affecting Performance (WCAPs).	129
1.5	Design and Operating Parameters	130
1.6	References	133
2.	DISTILLATION TECHNOLOGIES	134
2.1	Applicability	134
2.2	Underlying Principles of Operation	135
2.3	Description of Distillation Processes	137
2.4	Waste Characteristics Affecting Performance (WCAPs).	146
2.5	Design and Operating Parameters	150
2.6	References	156
3.	EXTRACTION TECHNOLOGIES	157
3.1	Applicability	157
3.2	Underlying Principles of Operation	157
3.3	Description of Extraction Processes	158
3.4	Waste Characteristics Affecting Performance (WCAPs).	164
3.5	Design and Operating Parameters	166
3.6	References	170
4.	FUEL SUBSTITUTION	171
4.1	Applicability	171
4.2	Underlying Principles of Operation	174
4.3	Description of Fuel Substitution Process	174
4.4	Waste Characteristics Affecting Performance (WCAPs).	177
4.5	Design and Operating Parameters	179
4.6	References	183

TABLE OF CONTENTS (CONTINUED)

<u>Section</u>	<u>Page No.</u>
B. RECOVERY AND/OR SEPARATION TECHNOLOGIES FOR METALS	
1. ACID LEACHING	184
1.1 Applicability	184
1.2 Underlying Principles of Operation	184
1.3 Description of Acid Leaching Process	185
1.4 Waste Characteristics Affecting Performance (WCAPs).	186
1.5 Design and Operating Parameters	188
1.6 References	190
2. FILTRATION TECHNOLOGIES	191
2.1 Applicability	191
2.2 Underlying Principles of Operation	191
2.3 Description of Filtration Processes	192
2.4 Waste Characteristics Affecting Performance (WCAPs).	194
2.5 Design and Operating Parameters	196
2.6 References	200
3. HIGH TEMPERATURE METALS RECOVERY	201
3.1 Applicability	201
3.2 Underlying Principles of Operation	202
3.3 Description of High Temperature Metals Recovery Process	202
3.4 Waste Characteristics Affecting Performance (WCAPs).	205
3.5 Design and Operating Parameters	206
3.6 References	210
4. ION EXCHANGE	211
4.1 Applicability	211
4.2 Underlying Principles of Operation	211
4.3 Description of Ion Exchange Process	212
4.4 Waste Characteristics Affecting Performance (WCAPs).	213
4.5 Design and Operating Parameters	217
4.6 References	220

TABLE OF CONTENTS (CONTINUED)

<u>Section</u>	<u>Page No.</u>
5. RETORTING	221
5.1 Applicability	221
5.2 Underlying Principles of Operation	221
5.3 Description of Retorting Process	222
5.4 Waste Characteristics Affecting Performance (WCAPs).	225
5.5 Design and Operating Parameters	227
5.6 References	228

**III. TECHNOLOGIES APPLICABLE TO MIXED WASTE
(RADIOACTIVE/HAZARDOUS)**

INTRODUCTION	229
A. TECHNOLOGIES FOR WASTES CONTAINING ORGANICS AND INORGANICS OTHER THAN METALS	231
1. Carbon Adsorption	231
2. Distillation Technologies	231
3. Extraction Technologies	232
B. TECHNOLOGIES FOR MIXED WASTES CONTAINING METALS	233
1. Acid Leaching	233
2. Chemical Precipitation	233
3. Filtration	233
4. High Temperature Metals Recovery	233
5. Ion Exchange	234
6. Stabilization of Metals	234
C. TECHNOLOGIES FOR MIXED WASTES IN SPECIAL TREATABILITY GROUPS	235
1. Amalgamation	235
2. Encapsulation	235
3. Vitrification	236
4. Incineration	237
REFERENCES	238

TABLE OF CONTENTS (CONTINUED)

<u>Section</u>		<u>Page No.</u>
APPENDIX A	List of Best Demonstrated Available Technology (BDAT) Background Documents and Associated BDAT(s)	A-1

LIST OF FIGURES

<u>Figure</u>		<u>Page No.</u>
1	Activated Sludge System	4
2	Trickling Filter System	7
3	Anaerobic Digestion	9
4	Continuous Chemical Reduction System	31
5	Liquid Injection Incineration System	49
6	Rotary Kiln Incineration System	50
7	Fluidized Bed Incineration System	52
8	Fixed Hearth Incineration System	53
9	Continuous Wet Air Oxidation System	68
10	Continuous Chemical Precipitation System	84
11	Circular Clarifier Systems	86
12	Inclined Plate Settler System	87
13	Carbon Adsorption Systems	127
14	Plot of Breakthrough Curve	128
15	Batch Distillation System	138
16	Fractionation System	140
17	Steam Stripping System	142
18	Thin Film Evaporation System	143
19	Screw Flight Dryer	145
20	Two-Stage Mixer-Settler Solvent Extraction System	160
21	Packed and Sieve Tray Solvent Extraction Columns	162
22	High Temperature Metals Recovery System	203
23	Two-Step Cation/Anion Ion Exchange System	214
24	Retorting Process (Without a Scrubber and Subsequent Wastewater Discharge)	223
25	Retorting Process (With a Scrubber and Subsequent Wastewater Discharge)	224

EXECUTIVE SUMMARY

This document provides a discussion of the treatment technologies applicable to wastes that are subject to the Land Disposal Restrictions (LDR), which were mandated by Congress as part of the 1984 Hazardous and Solid Waste Amendments (HSWA) to the Resource Conservation and Recovery Act (RCRA). This document does not include every possible technology that may be used to treat wastes subject to the LDR, but discusses those most commonly used. The technologies discussed include those that are demonstrated (commercially available) and have been proven to substantially diminish the toxicity of hazardous constituents and/or to reduce the likelihood of migration of such constituents from the waste of concern. These technologies include those that treat wastewaters* and those that treat nonwastewaters.

Treatment performance data from technologies discussed in this document were the basis for the determination of the Best Demonstrated Available Technology (BDAT), from which the Land Disposal Restrictions treatment standards were promulgated (as numerical standards or methods of treatment). Information supporting the development of these treatment standards may be found in the applicable background documents prepared for EPA's Office of Solid Waste, Waste Treatment Branch. These BDAT background documents contain information on the following: industries affected and waste characterization, applicable and demonstrated treatment technologies for the wastes of concern, determination of BDAT, and treatment performance data with design and operating conditions.

*For the purpose of the Land Disposal Restrictions rule, wastewaters are defined as wastes containing less than or equal to 1 percent (weight basis) filterable solids and less than or equal to 1 percent (weight basis) total organic carbon (TOC). Wastes not meeting this definition are classified as nonwastewaters.

The methodology EPA used to develop the BDAT treatment standards is described in two separate documents: Generic Quality Assurance Project Plan for Land Disposal Restrictions Program ("BDAT") (USEPA 1990) and Methodology for Developing BDAT Treatment Standards (USEPA 1990). The second document also discusses the petition process to be followed in requesting a variance from the BDAT treatment standards.

Appendix A lists the background documents developed for the BDAT program, identifying the technologies and the types of constituents treated (e.g., organics, inorganics, metals, etc.) when present in actual treatment performance data.

The treatment performance data and the design and operating data (see Section 5 of this executive summary for a discussion of design and operating data) contained in these documents may be used to help determine whether a treatment system has been designed and operated properly. The treatment performance data from these background documents may be used to compare the performance of a treatment system of concern treating the same or similar constituents (provided the waste matrices are not significantly dissimilar). Comparisons can be made of the destruction or removal efficiencies, the level of treatment achieved, and the design and operating parameters of a system (for example, feed rate, temperature, and oxygen concentration for incineration systems or concentration of nutrients, dissolved oxygen, residence time, etc. for biological treatment systems).

One document that may be particularly helpful is the F039 (Multisource Leachate) background document, Volumes A through E (USEPA 1990). This document contains comprehensive treatment performance data covering the complete list of P and U waste code constituents. The nonwastewater data, for the most part, were derived from 11 incineration test burns for the organics and from stabilization treatment for the metals. The wastewater data were derived from various sources such as EPA's Office of Water's Industrial Technology Division (ITD), the

National Pollutant Discharge Elimination System (NPDES), Water Engineering Research Laboratory (WERL), and other data sources available to the Agency. These above-mentioned data were generally considered to represent long-term sampling, with many data sets meeting EPA's criteria for quality assurance/quality control. Hence, treatment performance data from the F039 background document and other BDAT documents may be used as a basis for comparison when evaluating the performance of other treatment systems.

The Agency wishes to point out that additional information on treatment technologies may be obtained through EPA's Alternative Treatment Technology Information Center (ATTIC), operated by the Office of Environmental Engineering and Technology Demonstration. The ATTIC is an information retrieval network that provides up-to-date technical information on innovative treatment methods for hazardous wastes. The ATTIC provides information on innovative treatment technologies, cost analysis, and migration and sampling data bases; provides information on experts who can be contacted for assistance; and is a source for locating and ordering documents.

Also, the EPA Office of Waste Programs Enforcement has tapes and manuals for Inspectors of Incinerators (only available to EPA personnel). Information include an introduction to incinerator design, air pollution control, and regulatory guidance. Further information may be obtained by contacting the Regional RCRA training coordinator.

The treatment technologies presented in this document have been organized into three separate groups according to how they treat waste and to what types of waste they are applicable: (1) treatment technologies that destroy or reduce the migration of wastes; (2) removal technologies that separate or recover constituents for recycle/reuse or treatment; and (3) technologies that treat mixed waste, i.e., hazardous/radioactive waste. Although some of the technologies can belong to more than one group, each technology has been placed in the group where it is most commonly used.

The remainder of this introduction describes the purpose and contents of each of the various elements presented in each technology section: applicability, underlying principles of operation, description of the technology, waste characteristics affecting performance, and design and operating parameters. Specifically explained are what information is provided in each technology subsection, how the Agency uses this information as part of its BDAT program, and, when applicable, how the Agency intends to modify the treatment technology discussions as more treatment data and information become available.

1. Applicability

(a) Information Provided. The applicability section contains information on the general application of the treatment technology to various wastes. EPA's analysis of applicability is performed in consideration of the parameters and constituents known to affect treatment selection. That is, in order to identify whether a treatment technology was applicable to any particular waste stream, the Agency considered all parameters and characteristics associated with a hazardous waste that could affect the selection of a treatment technology. EPA uses the acronym PATS (i.e., parameters affecting treatment selection) for these parameters.

EPA's list of PATS, shown in Table 1, identifies all known constituents and parameters that are needed to select a technology or technology train for a given waste.

It is important to point out that in developing this list, EPA's goal was to determine the demonstrated technology or treatment technology train that would best treat all of the constituents in the waste (i.e., achieve the lowest concentration in the residual). Accordingly, EPA will add components to the treatment train as long as they are demonstrated and will achieve statistically significant reduction in the concentrations of the constituents. (Note: the statistical analysis that the Agency uses to determine whether a significant

Table 1 List of Parameters Affecting Treatment Selection

BDAT list metals content
BDAT list organics content
Content of other BDAT constituents (sulfides and fluorides)
Biological oxygen demand (BOD)
Btu content
Presence of complexed metals
Cyanide content
Filterable solids content
Oil and grease content
Oxidation state
pH
Total organic carbon (TOC) content
Total organic halides (TOX) content
Viscosity
Water content
Selectivity value
Sublimation temperature
Ash fusion temperature

reduction in constituents has occurred is referred to as Analysis of Variance (ANOVA). Refer to the Methodology for Developing BDAT Treatment Standards document for further information.)

(b) EPA's Use of This Information. EPA uses the PATS as the basis for making decisions regarding whether a particular technology is "demonstrated" for a particular waste. The Agency is performing treatment tests on specific wastes to "demonstrate" the treatment of the waste using the technology, to develop treatment standards, and to set the criteria by which other wastes can be regulated using the demonstrated technology.

The PATS analysis will sometimes show that several technologies are applicable for treating the waste. EPA will prioritize these technologies based on its analysis of available data and information regarding the effectiveness of the various technologies. For organics, EPA's preference will be technologies that recover or destroy the compounds; for metals, the Agency's preference will be technologies that result in recovery of the metals.

In some instances, analysis of a particular parameter affecting treatment selection will not be possible or would be meaningless with regard to selecting a treatment system. For example, the BOD of a contaminated soil is essentially meaningless since the soil is not likely to be treated in a biological wastewater treatment system.

(c) Use of New Data and Information. As data become available either from industry or through EPA's BDAT data collection program, EPA will modify the PATS analysis to further refine specific concentration ranges for which various technologies can handle various parameters.

2. Underlying Principles of Operation

(a) Information Provided. For each treatment technology EPA provides the fundamental theory of operation of the technology. This section is not meant to provide a detailed discussion on the specific complex physical, chemical, or biological mechanisms by which treatment occurs. Instead, the discussion describes the mechanisms involved so that one can understand what characteristics can affect the performance of the technology. For example, the underlying principle of chemical precipitation is that metals in wastewater are removed by adding a treatment chemical to form a metal precipitate that is generally insoluble and therefore settles out of solution. Formation of the precipitate and the settling mechanism are the principles controlling technology performance.

(b) Use of Information Provided. The theory of operation is necessary as the precursor to analyzing which waste characteristics can affect the performance of a given treatment technology. That is, the principles of treatment operation are used as the rationale and basis on which the Agency determines what waste characteristics can affect performance. Accordingly, waste characteristics affecting performance (WCAPs), which are discussed below, must be understood from the standpoint of how each waste characteristic inhibits or interferes with the fundamental operation of the treatment technology.

3. Description of the Treatment Process

This section provides a brief description of the principal components of a treatment technology. It is intended to provide a basic understanding of the equipment used and the treatment sequence. This presentation relates the discussion on underlying principles of operation with the later discussion of the design and operating parameters important to effective waste treatment. Simplified block diagrams are provided in this section. The information presented is general in nature to avoid attempting to show all combinations and permutations that are possible in describing a particular technology.

4. Waste Characteristics Affecting Performance (WCAPs)

(a) Information Provided. The WCAPs are based on the underlying principles of the treatment technology. For example, the underlying principle of chemical precipitation is formation of the insoluble metal precipitate and the settling of the precipitate out of solution. WCAPs for this technology are those parameters that affect the chemical reaction of the metal compound or the solubility of the metal precipitate (i.e., formation) and/or affect the ability of the precipitated compound to settle. The WCAPs include (a) the concentration and type of metals, (b) the concentration of total dissolved solids, (c) the concentration of complexing agents, and (d) the concentrations of oil and grease. The first three parameters can affect precipitate formation, and the last parameter can affect settling rate.

EPA's selection of WCAPs for the various treatment systems is based on a literature review, as well as information obtained during plant sampling visits that test the treatment technology. EPA is aware that in some cases analytical methods are not available to measure the specific waste characteristics that affect treatment. In such instances, EPA measures the parameter that most closely approximates the actual parameter of concern. For example, a WCAP for steam stripping is the relative volatility of a component. Because relative volatility cannot be measured, EPA uses boiling point as the best measure of assessing the WCAP of relative volatility.

The analysis of waste characteristics affecting performance is conducted where EPA already has determined from a PATS analysis that an untested waste could be treated effectively by the same BDAT technology as another waste for which treatment performance data are available. The WCAP analysis is then used to determine whether the treatment standards from the tested waste can be transferred to the untested waste. Simply stated, this analysis compares, for two separate wastes, the characteristics that affect the level of treatment that can be achieved. Where this comparison shows that the untested waste can be

treated as well or better, the Agency will transfer the treatment standards to the untested waste.

For example, for wastes that can be treated using chemical precipitation, if the Agency tests a waste containing lead at a given level, it will transfer the treatment standards developed from the test to a second lead-containing waste if the second waste meets the following WCAP-based conditions:

- The lead concentration is similar to that of the tested waste;
- The second waste has a lower total dissolved solids level;
- The concentration and type of other metals are similar to those of the tested waste; and
- The untested waste has a concentration of oil and grease similar to or less than that of the tested waste.

(b) Use of Information Provided. In applying the WCAP analyses, it is important to remember that the technology itself and the associated design and operating conditions are fixed (i.e., they are fixed at the values that existed for the already tested waste). EPA does not assume that, where WCAPs for the untested waste show that it would be significantly harder to treat, the addition of another treatment component or a change in design and operating conditions will result in the untested waste achieving the same performance as that of the previously tested waste. EPA is aware that modifying the treatment system or operating conditions could result in similar treatment. However, the Agency is not certain, without demonstrating through testing, that treatment levels associated with BDAT standards (normally in the low (<10) part per million or part per billion range) can be achieved by simply changing treatment conditions. Accordingly, EPA is very cautious in its decisions to transfer treatment standards where the WCAP analysis shows that treatment modifications are needed from the previously tested waste.

(c) Use of New Data and Information. In developing the WCAPs for the various treatment technologies, EPA found little and, in some cases, no information on the relative importance of the various WCAPs for a given technology (i.e., which waste characteristics have the most significant impact on treatment performance). Where information was available with regard to the specific WCAPs that are important when assessing the performance of a particular technology, EPA was unable to find any supporting data that would quantify the relative impact of each of the WCAPs on treatment performance.

As data become available either from industry or through EPA's BDAT data collection program, EPA may modify the WCAP analysis to further refine the parameters identified as affecting treatment technology performance. As previously noted, before it adopts a new WCAP, the Agency must understand how the parameters affect treatment relative to the underlying principles of operation.

5. Design and Operating Parameters

EPA uses design and operating information in several ways. First, this information is used, in conjunction with the Agency's BDAT data collection program, in determining whether a particular treatment system is well designed. That is, the Agency assesses design data prior to determining whether to test a particular piece of equipment or treatment train for potential use in the development of BDAT treatment standards. EPA obtains operating data during the course of an Agency-sponsored treatment test to ensure that the treatment system is well operated. Secondly, EPA expects facilities to provide the appropriate design and operating data when submitting treatment data to be considered in the development of the BDAT treatment standards. Again, the Agency assesses these data to determine whether the treatment system was well designed and well operated.

For example, some of the critical design and operating parameters for steam stripping include the number of equilibrium stages in the column, the temperature

at which the unit is designed to operate, and how well the design temperature is controlled. In evaluating performance data from a steam stripping operation, the Agency would examine the design specifications (e.g., the basis for selecting the number of stages and design temperature) for the treatment unit in order to determine the extent to which the hazardous constituents could be expected to volatilize. After the design specifications are established, the Agency would collect data (e.g., hourly readings of the column temperature) throughout the operation of the treatment process demonstrating that the unit was operating according to design specifications. If the data collected vary considerably from the design requirements, that variation could form the basis for determination that the treatment unit was improperly operated. If the temperature data show, for example, that for significant periods of time the temperature varied considerably from the design requirements, the Agency would not use these data to determine the levels of performance achievable by BDAT.

Finally, EPA requires facilities petitioning for a treatment variance to submit the plant's design values and the operating data during the time of the treatment period to ensure that the treatment system was well designed and well operated.

I. TREATMENT TECHNOLOGIES

A. DESTRUCTION TECHNOLOGIES

1. BIOLOGICAL TREATMENT

1.1 Applicability

Biological treatment can typically be divided into two classifications: aerobic biological treatment and anaerobic biological treatment. Aerobic biological treatment takes place in the presence of oxygen, while anaerobic biological treatment is an oxygen-devoid process.

Aerobic biological treatment is a treatment technology applicable to wastewaters containing biodegradable organic constituents and some nonmetallic inorganic constituents including sulfides and cyanides. Four of the most common aerobic biological treatment processes are (a) activated sludge, (b) aerated lagoon, (c) trickling filter, and (d) rotating biological contactor (RBC). The activated sludge and aerated lagoon processes are suspended-growth processes in which microorganisms are maintained in suspension with the liquid. The trickling filter and the RBC are attached-growth processes in which microorganisms grow on any inert medium such as rocks, slag, or specifically designed ceramic or plastic materials. This section discusses these four processes as well as the powdered activated carbon (PAC) adsorption process, which is a variation of the activated sludge treatment.

Anaerobic digestion is best suited to wastes with a moderate to high pH, nonhalogenated hydrocarbons, moderate to low organic loadings, and low to zero biological oxygen demand. The waste should also be in a semisolid or sludge form. Anaerobic biological treatment typically takes place in an anaerobic digester.

1.2 Underlying Principles of Operation

The basic principle of operation for aerobic biological treatment processes is that living, oxygen-requiring microorganisms decompose organic and nonmetallic inorganics constituents into carbon dioxide, water, nitrates, sulfates, simpler

low-molecular-weight organic byproducts, and cellular biomass. Wastes that can be degraded by a given species or genus of organisms may be very limited. A mixture of organisms may be required to achieve effective treatment, especially for wastes containing mixtures of organic compounds. Nutrients such as nitrogen and phosphorus are also required to aid in the biodegradation process.

The aerobic biodegradation process can be represented by the following generic equation:

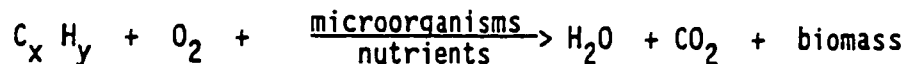

Microorganisms produce enzymes that catalyze the biodegradation reactions, degrading the organic waste to obtain energy for cell metabolism and cell growth.

Aerobic biological treatment of wastewaters containing organic constituents results in the net accumulation of a biomass of expired microorganisms consisting mainly of cell protein. However, the cellular biomass or sludges may also contain entrained constituents from the wastewater or partially degraded constituents. These sludges must be periodically removed ("wasted") to maintain proper operation of the aerobic biological treatment system.

The basic principle of operation of anaerobic biological treatment is that microorganisms in the absence of oxygen transform organic constituents and nitrogen-containing compounds into carbon dioxide and methane gas. Often other nutrients such as nitrogen and phosphorus are necessary to aid digestion. The anaerobic biological treatment process can be described by the following equation:

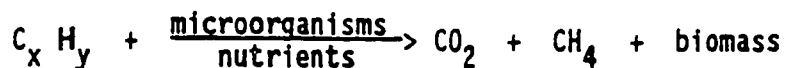

1.3 Description of Biological Treatment Processes

1.3.1 Activated Sludge

The activated sludge process is currently the most widely used biological treatment process. This is partly the result of the fact that recirculation of the biomass, which is an integral part of the process, allows microorganisms to adapt to changes in wastewater composition with a relatively short acclimation time and also allows a greater degree of control over the acclimated bacterial population.

An activated sludge system consists of an equalization basin, a settling tank, an aeration basin, a clarifier, and a sludge recycle line. Wastewater is homogenized in an equalization basin to reduce variations in the feed, which may cause process upsets of the microorganisms and diminish treatment efficiency. Settleable solids are then removed in a settling tank.

Next, wastewater enters an aeration basin, where an aerobic bacterial population is maintained in suspension and oxygen, as well as nutrients, is provided. The contents of the basin are referred to as the mixed liquor. Oxygen is supplied to the aeration basin by mechanical or diffused aeration, which also aids in keeping the microbial population in suspension. The mixed liquor is continuously discharged from the aeration basin into a clarifier, where the biomass is separated from the treated wastewater. A portion of the biomass is recycled to the aeration basin to maintain an optimum concentration of acclimated microorganisms in the aeration basin. The remainder of the separated biomass is discharged or "wasted." The biomass may be further dewatered on sludge drying beds or by sludge filtration (which is further discussed in Section II.B.2) prior to disposal. The clarified effluent is discharged. A schematic diagram of an activated sludge treatment system is shown in Figure 1.

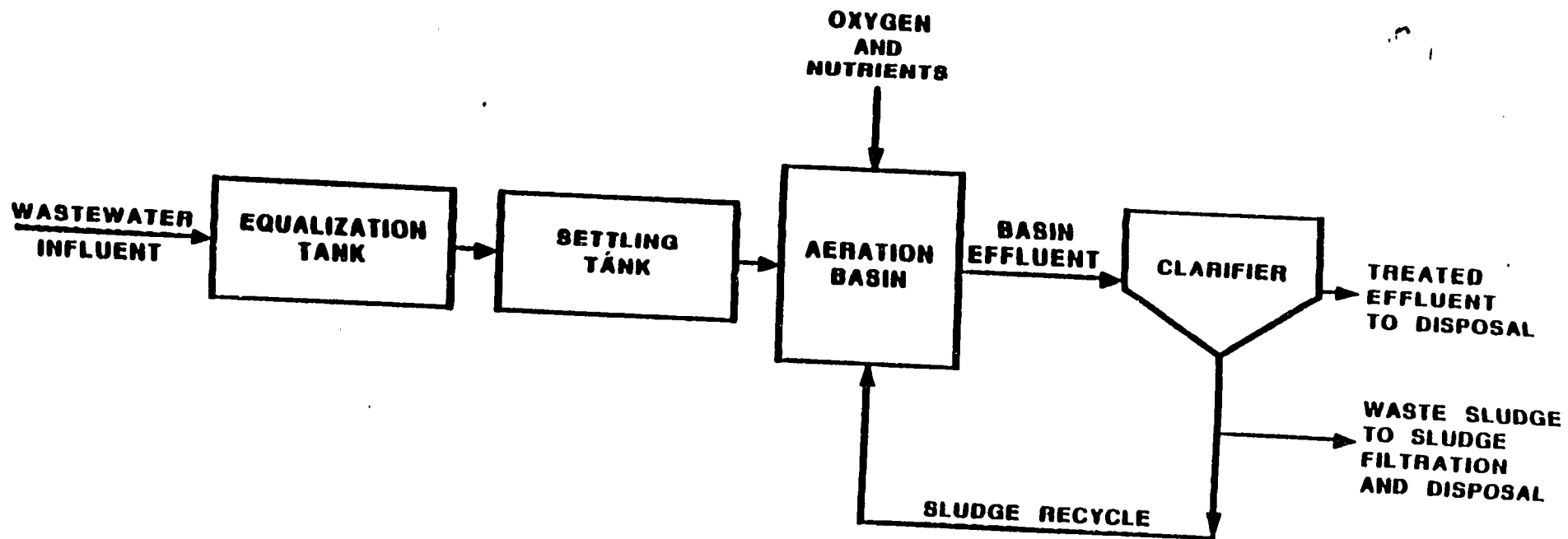

Figure 1 Activated Sludge System

The recycled biomass is referred to as activated sludge. The term "activated" is used because the biomass contains living and acclimated microorganisms that metabolize and assimilate organic material at a higher rate when returned to the aeration basin. This occurs because of the low food-to-microorganism ratio in the sludge from the clarifier.

An important variation on the activated sludge process is the Powdered Activated Carbon Treatment (PACT) process. This process offers a combined treatment and pretreatment system in which noncompatible and toxic constituents are adsorbed onto activated carbon, while microorganism-compatible waste remains in solution. Powdered activated carbon is added directly to the aeration basin of the activated sludge treatment system. Overall removal efficiency is improved because compounds that are not readily biodegradable or that are toxic to the microorganisms are adsorbed onto the surface of the powdered activated carbon. The carbon is removed from the wastewater in the clarifier along with the biological sludge. Usually, the activated carbon is recovered, regenerated, and recycled.

1.3.2 Aerated Lagoon

Like an activated sludge system, an aerated lagoon is a suspended-growth process. The aerated lagoon system consists of a large pond or tank that is equipped with mechanical aerators to maintain an aerobic environment and to prevent settling of the suspended biomass. Initially, the population of microorganisms in an aerated lagoon is much lower than that in an activated sludge system because there is no sludge recycle. Therefore, a significantly longer residence time is required to achieve the same effluent quality. However, this longer residence time may be an advantage when complex organic chemicals are to be degraded. Also, the microorganisms in aerated lagoons are more resistant to process upsets caused by feed variations than those in activated sludge systems because of the larger tank volumes and longer residence times used. The effluent from the aerated lagoon may flow to a settling tank for removal of suspended solids. Alternatively, the mechanical aerators in the system may be

shut off for a period of time to facilitate settling prior to discharge of the effluent. - The settled solids are generally dewatered prior to disposal.

1.3.3 Trickling Filters

A trickling filter is an attached-growth biological treatment process. The system consists of an equalization basin, a settling tank, a filter medium, an influent wastewater distribution system, an under drain system, a clarifier, and a recirculation line. The filter medium consists of a bed of an inert material to which the microorganisms attach themselves and through which the wastewater is percolated. Rocks or synthetic material such as plastic rings and saddles are typically used as filter media. Following equalization and settling of settleable solids in the wastewater, it is distributed over the top of the filter medium by a rotating distribution arm or a fixed distributor system. The wastewater forms a thin layer as it flows downward through the filter and over the microorganism layer on the surface of the medium. As the distribution arm rotates, the microorganism layer is alternately exposed to a flow of wastewater and a flow of air. In the fixed distributor system, the wastewater flow is cycled on and off at a specified dosing rate to ensure that an adequate supply of oxygen is available to the microorganisms. Oxygen from air reaches the microorganisms through the void spaces in the medium. Figure 2 is a diagram of a trickling filter system.

- A trickling filter system is typically used as a roughing filter to reduce the organic loading on a downstream activated sludge process. Trickling filters can be used for the treatment of wastewaters that could potentially produce "bulking" sludge (i.e., a sludge with poor settling characteristics and poor compactability in an activated sludge process) because the microbial solids that slough off the trickling filter medium are relatively dense and can be readily removed in a clarifier.

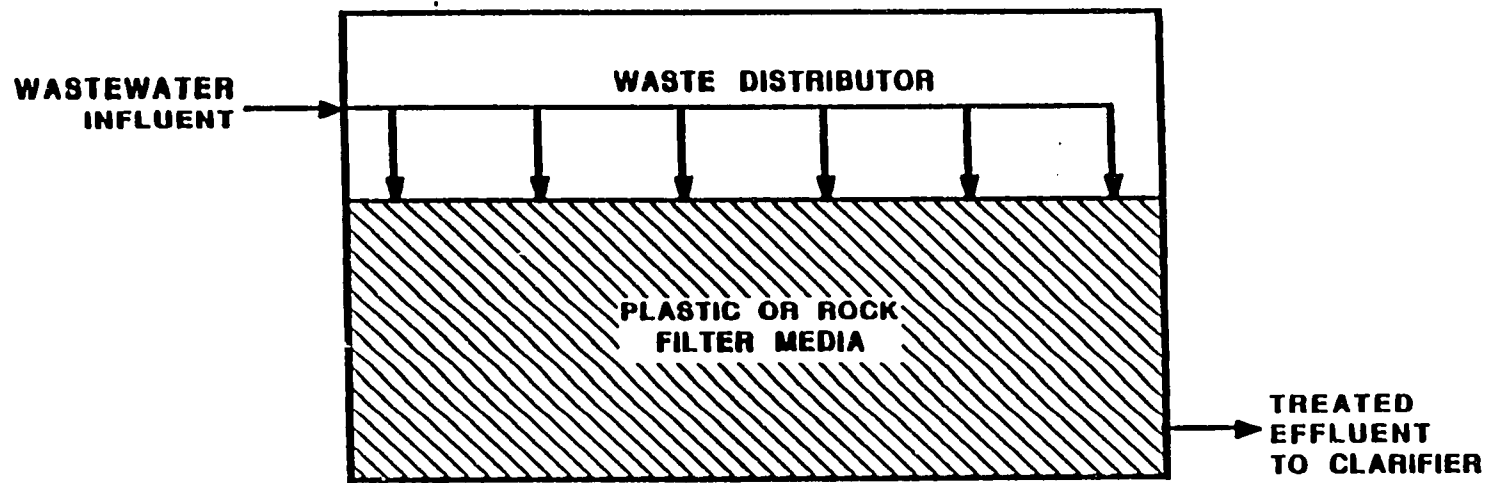

7

Figure 2 Trickling Filter System

1.3.4 Rotating Biological Contactor

A rotating biological contactor (RBC) consists of a series of closely spaced, parallel disks that are rotated at an average rate of 2 to 5 revolutions per minute while submerged to 40 percent of their diameters in a contact tank containing wastewater. The disks are constructed of polystyrene, polyvinyl chloride, or similar materials. Each disk is covered with a biological slime that degrades dissolved organic constituents present in the wastewater. As the disk is rotated out of the tank, it carries a film of the wastewater into the air, where oxygen is available for aerobic biological decomposition. As excess biomass is produced, it sloughs off the disk and is separated from the treated effluent in a clarifier. The sloughing off process is similar to that which occurs in a trickling filter. There is no recycle of sludges or recirculation of treated effluent in an RBC process. Several RBCs are often operated in series, with the effluent from the last RBC being discharged. Biological solids are usually dewatered prior to disposal.

1.3.5 Anaerobic Biological Treatment

In anaerobic biological treatment, the influent sludge is settled and equalized, then pumped to the anaerobic digester (Figure 3) along with an alkaline adjustment additive. There may or may not be mechanical agitation of the digester. After an adequate residence time to allow for proper digestion, the digester contents are allowed to settle. The supernatant is pumped to an aerobic treatment area (typically to an activated sludge unit), while the sludge is taken to disposal areas or subjected to additional treatment, such as drying or incineration.

1.4 Waste Characteristics Affecting Performance (WCAPs)

In determining whether biological treatment will achieve the same level of performance on an untested waste that it achieved on a previously tested waste and whether performance levels can be transferred, EPA examines the following

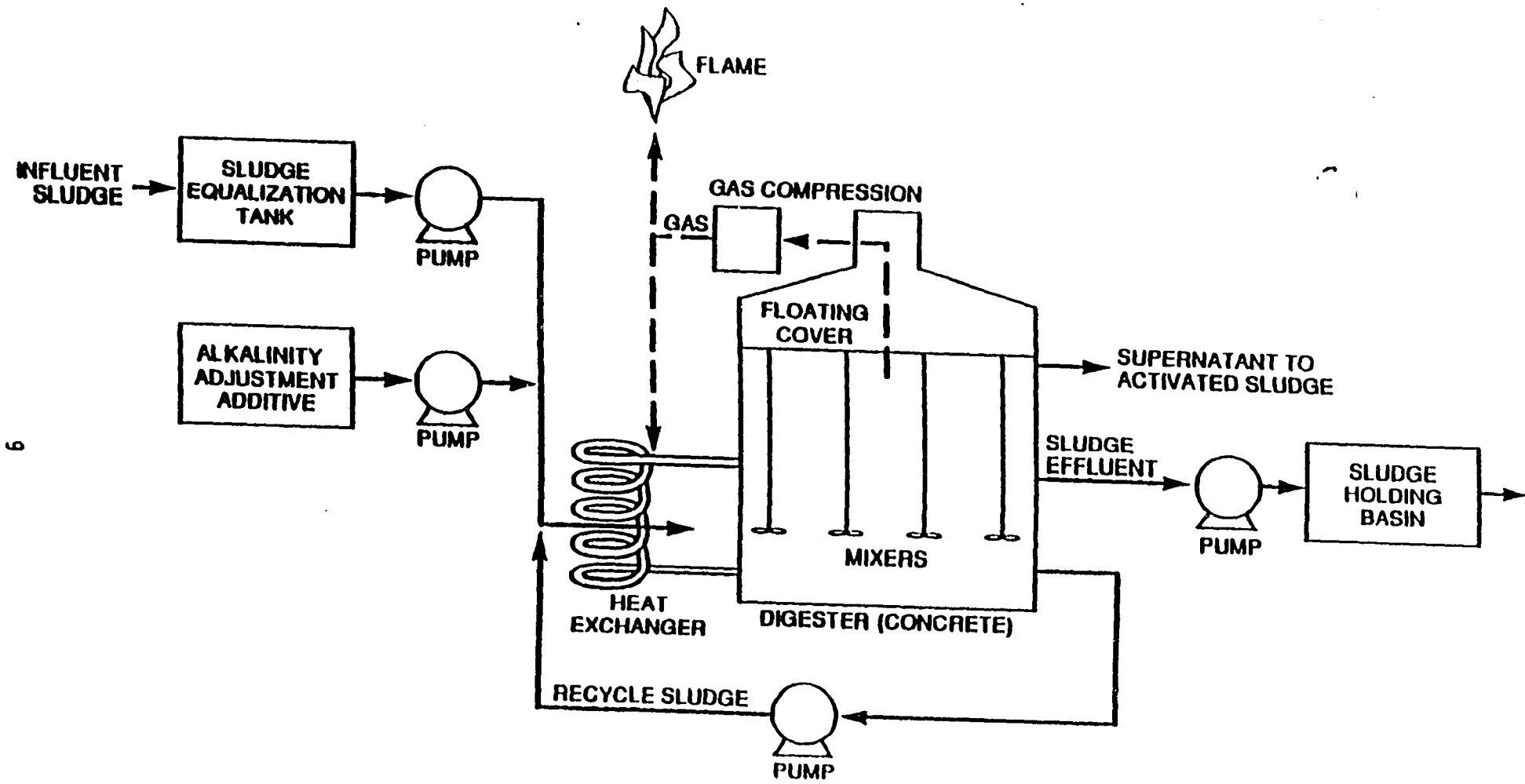

6

Figure 3 Anaerobic Digestion

waste characteristics: (a) the ratio of the biological oxygen demand to the total organic carbon content, (b) the concentration of surfactants, and (c) the concentration of toxic constituents and waste characteristics.

1.4.1 Ratio of Biological Oxygen Demand to Total Organic Carbon Content

Because organic constituents in the waste effectively serve as a food supply for the microorganisms, it is necessary that a significant percentage be biodegradable. If they are not, it will be difficult for the microorganisms to successfully acclimate to the waste and achieve effective treatment. The percentage of biodegradable organics can be estimated by the ratio of the biological oxygen demand (BOD) to the total organic carbon (TOC) content. Since the biological oxygen demand is a measure of the amount of oxygen required for complete microbial oxidation of biodegradable organics, the BOD analysis is mostly relevant to aerobic biological treatment. (In anaerobic biological treatment, BOD is one of the main restrictive characteristics in that BOD must be relatively low or zero.) If the ratio of BOD to TOC in an untested waste is significantly lower than that in the tested waste, the system may not achieve the same performance and other, more applicable technologies may need to be considered for treatment of the untested waste.

1.4.2 Concentration of Surfactants

Surfactants can affect biological treatment performance by forming a film on organic constituents, thereby establishing a barrier to effective biodegradation. If the concentration of surfactants in an untested waste is significantly higher than that in the tested waste, the system may not achieve the same performance and other, more applicable technologies may need to be considered for treatment of the untested waste.

1.4.3 Concentration of Toxic Constituents and Waste Characteristics

A number of constituents and waste characteristics have been identified as potentially toxic to microorganisms. Specific toxic concentrations have not been determined for most of these constituents and waste characteristics. The constituents and waste characteristics found to be potentially toxic to microorganisms include metals and oil and grease, ammonia, and phenols. High concentrations of dissolved solids are treated more effectively by anaerobic treatment than by aerobic treatment. If the concentration of toxic constituents and waste characteristics in an untested waste is significantly higher than that in the tested waste, the system may not achieve the same performance and other, more applicable technologies may need to be considered for treatment of the untested waste.

1.5 Design and Operating Parameters

In assessing the effectiveness of the design and operation of a biological treatment system, EPA examines the following parameters: (a) the amount of nutrients, (b) the concentration of dissolved oxygen, (c) the food-to-microorganism ratio, (d) the pH, (e) the biological treatment temperature, (f) the mean cell residence time, (g) the hydraulic loading rate, (h) the settling time, and (i) the degree of mixing.

For many hazardous organic constituents, analytical methods are not available or the constituent cannot be analyzed in the waste matrix. Therefore, it would normally be impossible to measure the effectiveness of the biological treatment system. In these cases EPA tries to identify measurable parameters or constituents that would act as surrogates in order to verify treatment.

For organic constituents, each compound contains a measurable amount of total organic carbon (TOC). Removal of TOC in the biological treatment system indicates removal of organic constituents. Hence, TOC analysis is likely to be

an adequate surrogate analysis where the specific organic constituent cannot be measured.

However, TOC analysis may not be able to adequately detect treatment of specific organics in matrices that are heavily organic-laden (i.e., the TOC analysis may not be sensitive enough to detect changes at the milligrams per liter (mg/l) level in matrices where total organic concentrations are hundreds or thousands of mg/l). In these cases other surrogate parameters should be sought. For example, if a specific analyzable constituent is expected to be treated as well as the unanalyzable constituent, the analyzable constituent concentration should be monitored as a surrogate.

1.5.1 Amount of Nutrients

Nutrient addition is important in controlling the growth of microorganisms because an insufficient amount of nutrients results in poor microbial growth with poor biodegradation of organic constituents. The principal inorganic nutrients used are nitrogen and phosphorus. In addition, trace amounts of potassium, calcium, sulfur, magnesium, iron, and manganese are also used for optimum microbial growth. The percent distribution of nitrogen and phosphorus added to microorganisms varies with the age of the organism and the particular environmental conditions. The total amount of nutrients required depends on the net mass of organisms produced.

EPA monitors the amount of nutrients added and their method of addition to the wastewater to ensure that a sufficient supply is provided to achieve an effective growth of microorganisms.

1.5.2 Concentration of Dissolved Oxygen

A sufficient concentration of dissolved oxygen (DO) is necessary to metabolize and degrade dissolved organic constituents in aerobic treatment. The DO concentration is controlled by adjusting the aeration rate. The aeration rate

must be adequate to provide a sufficient DO concentration to satisfy the BOD requirements of the waste, as well as to provide adequate mixing to keep the microbial population in suspension (for activated sludge and aerated lagoon processes). The reverse is true for anaerobic treatment, in that DO must be absent for anaerobic treatment to occur. EPA monitors the DO concentrations continuously, if possible, to ensure that the system is operating at the appropriate design condition and to diagnose operational problems.

1.5.3 Food-to-Microorganism Ratio

The food-to-microorganism (F/M) ratio, which applies only to activated sludge systems, is a measure of the amount of biomass available to metabolize the influent organic loading to the aeration unit. This ratio can be determined by dividing the influent BOD concentration by the concentration of active biomass, also referred to as the mixed liquor volatile suspended solids (MLVSS). The F/M ratio is controlled by adjusting the wastewater feed rate or the sludge recycle rate. If the F/M ratio is too high, too few microorganisms will be available to degrade the organics. EPA periodically analyzes the influent BOD and the aeration unit's MLVSS concentrations to ensure that the system is operating at the appropriate design condition.

1.5.4 pH

Generally, neutral or slightly alkaline pH favors microorganism growth. The optimum range for most microorganisms used in biological treatment systems is between 6 and 8. Treatment effectiveness is generally insensitive to changes within this range. However, pH values outside the range can lower treatment performance. EPA monitors the pH continuously, if possible, to ensure that the system is operating at the appropriate design condition and to diagnose operational problems.

1.5.5 Biological Treatment Temperature

Microbial growth can occur under a wide range of temperatures, although the majority of the microbial species used in aerobic biological treatment processes are active between 20 and 35°C (68 to 95°F). For anaerobic systems, the temperature is typically between 30 and 70°C (86 to 158°F). The rate of biochemical reactions in cells increases with temperature up to a maximum above which the rate of activity declines and microorganisms either die off or become less active. EPA monitors the biological treatment temperature continuously, if possible, to ensure that the system is operating at the appropriate design condition and to diagnose operational problems.

1.5.6 Mean Cell Residence Time

In activated sludge, aerated lagoon, and anaerobic digestion systems, the mean cell residence time (MCRT) or sludge age is the length of time organisms are retained in the unit before being drawn off as waste sludge. By controlling the MCRT, the growth phase of the microbial population can be controlled. The MCRT must be long enough to allow the organisms in the unit to reproduce. The MCRT is determined by dividing the total active microbial mass in the unit (MLVSS) by the total quantity of microbial mass withdrawn daily (wasted). EPA monitors the MCRT to ensure that a sufficient number of microorganisms are present in the unit.

1.5.7 Hydraulic Loading Rate

The hydraulic loading rate determines the length of time the organic constituents are in contact with the microorganisms and, hence, the extent of biodegradation that occurs. In trickling filters, the hydraulic loading rate also determines the shear velocities on the microbial layer. Excessively high hydraulic loading rates may wash away the microbial layer faster than it can grow back. However, the hydraulic loading rate must be high enough to keep the microbes moist and to remove dead or dying microbes that have lost their ability

to cling to the filter media. For all aerobic biological treatment processes, the hydraulic loading rate is controlled by adjusting the wastewater feed rate. In addition, for RBCs, the hydraulic loading rate can be controlled by changing the disk speed or adjusting the submersion depth. EPA monitors the wastewater feed rates to ensure that the hydraulic loading provides sufficient time to achieve an effective biodegradation of organic constituents in the wastewater.

1.5.8 Settling Time

Adequate settling time must be provided to separate the biological solids from the mixed liquor. Activated sludge systems cannot function properly if the solids cannot be effectively separated and a portion returned to the aeration basin. EPA monitors the settling time to ensure effective solids removal.

1.5.9 Degree of Mixing

Mixing provides greater uniformity of the wastewater feed in the equalization basin to reduce variations that may cause process upsets of the microorganisms and diminish treatment efficiency. For activated sludge and aerated lagoon systems, sufficient aeration in the aeration unit provides mixing to ensure adequate contact between the microorganisms and the organic constituents in the wastewater. The quantifiable degree of mixing is a complex assessment that includes, among other factors, the amount of energy supplied, the length of time the material is mixed, and the related turbulence effects of the specific size and shape of the mixing unit. The degree of mixing is beyond the scope of simple measurement. EPA, however, evaluates the degree of mixing qualitatively by considering whether mixing is provided and whether the type of mixing device is one that could be expected to achieve uniform mixing of the wastewater.

1.6 References

- Barley, J., and Ollis, D. 1977. Biochemical engineering fundamentals. New York: McGraw-Hill Book Co.
- Burchett, M., and Tshobanoglous, G. 1974. Facilities for controlling the activated sludge process by mean cell residence time. Journal Water Pollution Control Federation. Vol. 46, no. 5 (May 1974), p. 973.
- Clark, J.W., Viessman, W., and Hammer, M. 1977. Water supply and pollution control. New York: Harper & Row, Publishers.
- Eckenfelder Jr., W.W., Patoczka, J., and Watkins, A. 1985. Wastewater treatment. Chemical engineering. September 2, 1985.
- Johnson, S.J. 1978. Biological treatment. Unit operation for treatment of hazardous industrial wastes. Park Ridge, N.J.: Noyes Data Corporation.
- Kobayashi, H., and Rittmann, B. 1982. Microbial removal of hazardous organic compounds. Environmental Science and Technology. Vol. 16, no. 3, pp. 170-183.
- Metcalf & Eddy, Inc. 1979. Wastewater engineering: treatment, disposal, reuse. New York: McGraw-Hill Book Co.
- Nemerow, N.L. 1978. Industrial water pollution origins, characteristics, and treatment. Reading, Mass.: Addison-Wesley Publishing Company.
- Perry, R., and Green, D. 1984. Chemical engineers' handbook. 6th ed. New York: McGraw-Hill Book Co.
- Rittmann, B. 1987. Aerobic biological treatment. Environmental Science and Technology. February 1987. p. 128.
- USEPA. 1985. U.S. Environmental Protection Agency. Final report. Assessment of treatment technologies for hazardous waste and their restrictive waste characteristics. Vol 1. Washington, D.C.: U.S. Environmental Protection Agency.
- USEPA. 1986. U.S. Environmental Protection Agency. Best demonstrated available technology background document for F001-F005 spent solvents. Vol. 1, EPA/530-SW-86-056. pp. 4-43. Washington, D.C.: U.S. Environmental Protection Agency.

2. CHEMICAL OXIDATION

2.1 Applicability

Chemical oxidation is a treatment technology used to treat wastes containing organics. It is also used to treat sulfide wastes by converting the sulfide to sulfate. The destruction of cyanides in wastes is usually accomplished by chemical oxidation. Chemical oxidation can also be used to change the oxidation state of metallic compounds to valences that are less soluble, such as converting arsenic in wastes to the relatively insoluble pentavalent state.

Chemical oxidation is applicable to dissolved cyanides in aqueous solutions, such as wastewaters from metal plating and finishing operations, or to inorganic sludges from these operations that contain cyanide compounds. For cyanides, chemical oxidation is most applicable to solutions containing less than 500 mg/l of cyanides when the cyanides are in a form that can be easily disassociated in water to yield free cyanide ions. If cyanides are present in water as a tightly bound complex ion (e.g., ferrocyanide), only limited treatment may occur. If the waste contains greater than 500 mg/l of cyanide, but no more than about 100,000 mg/l, electrolytic oxidation may be more appropriate. See Section I.A.4.

Chemical oxidation may also be used for destruction of the organic component of organometallic compounds in wastes, thus freeing the metal component for treatment by chemical precipitation or stabilization. Organic compounds such as EDTA, NTA, citric acid, glutaric acid, lactic acid, and tartrates are often used as chelating agents to prevent metal ions from precipitating out in electroless plating solutions. When these spent plating solutions require treatment for metals removal by chemical precipitation, the organic chelating agents must first be destroyed. Chemical oxidants, potassium permanganate in particular, are effective in releasing metals from complexes with these organic compounds.

2.2 Underlying Principles of Operation

The basic principle of operation for chemical oxidation is that inorganic cyanides, some dissolved organic compounds, and sulfides can be chemically oxidized to yield carbon dioxide, water, salts, simple organic acids, and, in the case of sulfides, sulfates. Metallic ions such as arsenites can be oxidized to higher, less soluble valences such as arsenates. The principal chemical oxidants used are hypochlorite, chlorine gas, chlorine dioxide, hydrogen peroxide, ozone, and potassium permanganate. The reaction chemistry for each is discussed below.

2.2.1 Oxidation with Hypochlorite or Chlorine (Alkaline Chlorination)

This type of oxidation is carried out using sodium hypochlorite (NaOCl), calcium hypochlorite (Ca(OCl)₂), chlorine gas (Cl₂), or sometimes chlorine dioxide gas (ClO₂). The reactions are normally conducted under slightly or moderately alkaline conditions. Alkaline chlorination of cyanide is a two-step process usually operated at a pH of 10 to 11.5 for the first step and 8.5 for the second step. The toxic gas cyanogen chloride (CNC1) is formed as a reaction intermediate in the first step of this process and may be liberated if the pH is less than 10 and incomplete reaction occurs. Example reactions for the oxidation of cyanide, phenol, and sulfide using sodium hypochlorite are shown below:



Chlorine dioxide also oxidizes the same pollutants under identical conditions. Chlorine dioxide first hydrolyzes to form a mixture of chlorous

(HClO₂) and chloric (HClO₃) acids. These acids act as the oxidants, as shown in the equations below, for phenol:

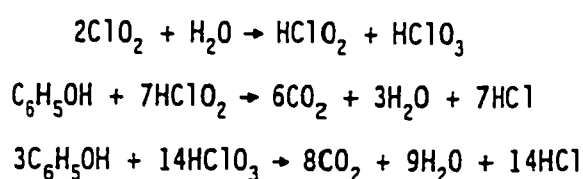

2.2.2 Peroxide Oxidation

Peroxide oxidizes the same constituents that alkaline chlorination oxidizes under similar conditions. The relevant reactions are the following:

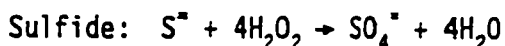
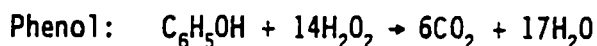
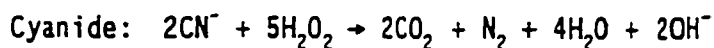

2.2.3 Oxidation with Ozone (Ozonation)

Ozone is an effective oxidizing agent for the treatment of organic compounds and for the oxidation of cyanide to cyanate. Cyanogen gas (C₂N₂) is a reaction intermediate in this reaction. Further oxidation of cyanate to carbon dioxide and nitrogen compounds (N₂ or NH₃) occurs slowly with ozone. The oxidation of cyanide to cyanate proceeds by the following reaction:

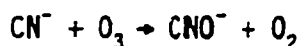

The rates of ozonation reactions can be accelerated by supplying ultraviolet (UV) radiation during treatment. Some literature sources indicate that even the cyanide complexes most difficult to treat, the iron-cyanide complexes, can be oxidized completely.

2.2.4 Oxidation with Potassium Permanganate

Potassium permanganate can also be used to oxidize the same constituents as the other chemical oxidants. The reactions of potassium permanganate with phenol and sulfide at acidic pHs and with cyanide at pH 12 to 14 are as follows:

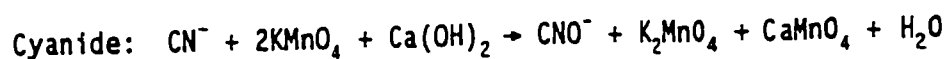
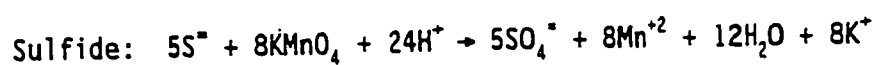
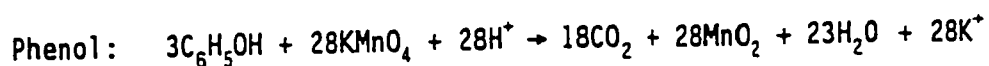

In cyanide oxidation using potassium permanganate, cyanide is oxidized only to cyanate. Further oxidation of cyanate can be accomplished by acid hydrolysis or by the use of another oxidizing agent.

2.2.5 SO₂/Air Oxidation

Cyanide can be oxidized to cyanate in an aqueous solution by bubbling air containing from 1 to 10 percent SO₂ through the waste. The SO₂ is also oxidized to sulfate in this reaction. This treatment process occurs by the following reaction:

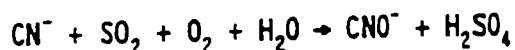

This oxidation reaction requires the use of a soluble copper salt catalyst. Copper sulfate (CuSO₄) is most often used. SO₂/air oxidation is used frequently in the treatment of wastewaters from gold production, which contain both cyanide and thiocyanate, because SO₂/air oxidizes cyanide more strongly than thiocyanate while alkaline chlorination and other common oxidizing agents oxidize thiocyanate more strongly than cyanide. As with potassium permanganate, further oxidation of cyanate can be accomplished by acid hydrolysis or by the use of another oxidizing agent.

2.3 Description of Chemical Oxidation Processes

2.3.1 Alkaline Chlorination

Alkaline chlorination can be accomplished by either batch or continuous processes. For batch treatment, the wastewater is transferred to a reaction tank, where the pH is adjusted and the oxidizing agent is added. In some cases, the tank may be heated to increase the reaction rate. For oxidation of most compounds, a slightly to moderately alkaline pH is used. It is important that the tank be well mixed for effective treatment to occur. After treatment, the wastewater is either directly discharged or transferred to another process for further treatment.

In the continuous process, automatic instrumentation is used to control pH, reagent addition, and temperature. An oxidation-reduction potential (ORP) sensor is usually used to measure the extent of reaction.

In both types of processes, agitation is typically provided to maintain thorough mixing. Typical residence times for these and other oxidation processes range from 1 to 2 hours.

2.3.2 Peroxide Oxidation

The peroxide oxidation process is run under similar conditions, and with similar equipment, to those used in the alkaline chlorination process. Hydrogen peroxide is added as a liquid solution.

2.3.3 Ozonation

Ozonation can be conducted in a batch or continuous process. The ozone for treatment is produced onsite because of the hazards of transporting and storing ozone as well as its short shelf life. The ozone gas is supplied to the reaction vessels by injection into the wastewater. The batch process uses a single

reaction tank. As with alkaline chlorination, the amount of ozone added and the reaction time used are determined by the type and concentration of the oxidizable contaminants, and vigorous mixing should be provided for complete oxidation.

In continuous operation, two separate tanks may be used for reaction. The first tank receives an excess dosage of ozone. Any excess ozone remaining at the outlet of the second tank is recycled to the first tank, thus ensuring that an excess of ozone is maintained and also that no ozone is released to the atmosphere. As with alkaline chlorination, an ORP control system is usually necessary to ensure that sufficient ozone is being added.

2.3.4 Permanganate Oxidation

Permanganate oxidation is conducted in tanks in a manner similar to that used for alkaline chlorination, as discussed previously. Potassium permanganate is normally dissolved in an auxiliary tank and added as a solution. As with the other oxidizing agents, ORP (for continuous processes) and excess oxidizing agent (for batch processes) are monitored to measure the extent of reaction.

2.3.5 SO₂/Air Oxidation

SO₂/air oxidation of cyanide depends on efficient mixing of air with the waste to ensure an adequate supply of oxygen. Because of this factor, the equipment requirements for this process are similar to those for ozonation. SO₂ is sometimes supplied with the air by using flue gas containing SO₂ as the air source. Otherwise, sulfur in the +4 oxidation state can be fed as gaseous sulfur dioxide (SO₂), liquid sulfurous acid (H₂SO₃), sodium sulfite (Na₂SO₃) solution, or sodium bisulfite (NaHSO₃) solution. Sodium bisulfite solution, made by dissolving sodium metabisulfite (Na₂S₂O₅) in water, is the most frequently used source of SO₂. This process is usually run continuously, with the addition of oxidizing agent and acid/alkali being controlled through continuous monitoring of ORP and pH, respectively.

2.4 Waste Characteristics Affecting Performance (WCAPs)

In determining whether chemical oxidation will achieve the same level of performance on an untested waste that it achieved on a previously tested waste and whether performance levels can be transferred, EPA examines the following waste characteristics: (a) the concentration of other oxidizable contaminants and (b) the concentration of metal salts.

2.4.1 Concentration of Other Oxidizable Compounds

The presence of other oxidizable compounds in addition to the constituents of concern will increase the demand for oxidizing agents and, hence, potentially reduce the effectiveness of the treatment process. As a surrogate for the amount of oxidizable organics present, EPA analyzes for total organic carbon (TOC) in the waste. Inorganic reducing compounds such as sulfide may also create a demand for additional oxidizing agent; EPA also attempts to identify and analyze for these constituents. If TOC and/or inorganic reducing compound concentrations in the untested waste are significantly higher than those in the tested waste, the system may not achieve the same performance. Additional oxidizing agent may be required to effectively oxidize the waste and achieve the same treatment performance, or other, more applicable treatment technologies may need to be considered for treatment of the untested waste.

2.4.2 Concentration of Metal Salts

Metal salts, especially lead and silver salts, will react with the oxidizing agent(s) to form metal peroxides, chlorides, hypochlorites, and/or chlorates. These reactions can cause an excessive consumption of oxidizing agents and potentially interfere with the effectiveness of treatment.

An additional problem with metals in cyanide solutions is that metal-cyanide complexes are sometimes formed. These complexes are negatively charged metal-cyanide ions that are extremely soluble. Cyanide in the complexed

form may not be oxidizable, depending on the strength of the metal-cyanide bond in the complex and the type of oxidizing agent used. Iron complexes (for example, the ferrocyanide ion, $\text{Fe}(\text{CN})_6^{-4}$) are the most stable of the complexed cyanides.

If the concentrations of metal salts and/or metal-cyanide complexes in the untested waste are significantly higher than those in the tested waste, the system may not achieve the same performance. Additional oxidizing agent and/or a different oxidizing agent may be required to effectively oxidize the waste and achieve the same treatment performance, or other, more applicable treatment technologies may need to be considered for treatment of the untested waste.

2.5 Design and Operating Parameters

In assessing the effectiveness of the design and operation of a chemical oxidation system, EPA examines the following parameters: (a) the residence time, (b) the amount and type of oxidizing agent, (c) the degree of mixing, (d) the pH, (e) the oxidation temperature, and (f) the amount and type of catalyst.

For many hazardous organic constituents, analytical methods are not available or the constituent cannot be analyzed in the waste matrix. Therefore, it would normally be impossible to measure the effectiveness of the chemical oxidation treatment system. In these cases EPA tries to identify measurable parameters or constituents that would act as surrogates to verify treatment.

For organic constituents, each compound contains a measurable amount of total organic carbon (TOC). Removal of TOC in the chemical oxidation treatment system will indicate removal of organic constituents. Hence, TOC analysis is likely to be an adequate surrogate analysis where the specific organic constituent cannot be measured.

However, TOC analysis may not be able to adequately detect treatment of specific organics in matrices that are heavily organic-laden (i.e., the TOC

analysis may not be sensitive enough to detect changes at the milligrams/liter (mg/l) level in matrices where total organic concentrations are hundreds or thousands of mg/l. In these cases other surrogate parameters should be sought. For example, if a specific analyzable constituent is expected to be treated as well as the unanalyzable constituent, the analyzable constituent concentration should be monitored as a surrogate.

2.5.1 Residence Time

The residence time impacts the extent of volatilization of waste contaminants. For a batch system, the residence time is controlled by adjusting the treatment time in the reaction tank. For a continuous system, the waste feed rate is controlled to make sure that the system is operated at the appropriate design residence time. EPA monitors the residence time to ensure that sufficient time is provided to effectively oxidize the waste.

2.5.2 Amount and Type of Oxidizing Agent

Several factors influence the choice of oxidizing agents and the amount to be added. The amount of oxidizing agent required to treat a given amount of oxidizable constituent(s) will vary with the agent chosen. Enough oxidant must be added to ensure complete oxidation; the specific amount depends on the type of oxidizable compounds in the waste and the chemistry of the oxidation reactions. Theoretically, the amount of oxidizing agent to be added can be computed from oxidation reaction stoichiometry; in practice, an excess of oxidant should be used. Testing for excess oxidizing agent will determine whether the reaction has reached completion. In continuous processes, oxidizing agent is added by automated feed methods. The amount of oxidizing agent needed is usually measured and controlled automatically by an oxidation-reduction potential (ORP) sensor. EPA examines the amount of oxidant added to the chemical oxidation system to ensure that it is sufficient to effectively oxidize the waste and, for continuous processes, examines how the facility ensures that the particular addition rate is maintained. EPA also tests for excess oxidizing agent for batch

processes and continuously monitors the ORP for continuous processes to ensure that excess oxidizing agent, if possible, is supplied.

2.5.3 Degree of Mixing

Process tanks must be equipped with mixers to ensure maximum contact between the oxidizing agent and the waste solution. Proper mixing also limits the production of any solid precipitates from side reactions that may resist oxidation. Mixing also provides an even distribution of tank contents and a homogeneous pH throughout the waste, improving oxidation of wastewater constituents. The quantifiable degree of mixing is a complex assessment that includes, among other factors, the amount of energy supplied, the length of time the material is mixed, and the related turbulence effects of the specific size and shape of the tank. This is beyond the scope of simple measurement. EPA, however, evaluates the degree of mixing qualitatively by considering whether mixing is provided and whether the type of mixing device is one that could be expected to achieve uniform mixing of the waste solution.

2.5.4 pH

Operation at the optimal pH maximizes the chemical oxidation reactions and may, depending on the oxidizing agent being used, limit the formation of undesirable reaction byproducts or the escape of cyanide from solution as HCN, CNCl, or C_2N_2 gas. The pH is controlled by the addition of caustic, lime, or acid to the solution. In most cases, a slightly or moderately alkaline pH is used, depending on the type of oxidizing agent being used and the compound being treated (see Section 2.2, Underlying Principles of Operation). In alkaline chlorination treatment of organics, a slightly acidic pH may be selected as an optimum. In permanganate oxidation, a pH of 2 to 4 is often selected. EPA monitors the pH continuously, if possible, to ensure that the system is operating at the appropriate design condition and to diagnose operational problems.

2.5.5 Oxidation Temperature

Temperature affects the rate of reaction and the solubility of the oxidizing agent in the waste. As the temperature is increased, the solubility of the oxidizing agent, in most instances, is increased and the required residence time, in most cases, is reduced. EPA monitors the oxidation temperature continuously, if possible, to ensure that the system is operating at the appropriate design condition and to diagnose operational problems.

2.5.6 Amount and Type of Catalyst

Adding a catalyst that promotes oxygen transfer and thus enhances oxidation has the effect of lowering the necessary reactor temperature and/or improving the level of destruction of oxidizable compounds. For waste constituents that are more difficult to oxidize, catalyst addition may be necessary to effectively destroy the constituent(s) of concern. Catalysts typically used for this purpose include copper bromide and copper nitrate. If a catalyst is required, EPA examines the amount and type added, as well as the method of addition of the catalyst to the waste, to ensure that effective oxidation is achieved.

2.6 References

- Gurnham, C.F. 1985. Principles of industrial waste treatment. New York: John Wiley and Sons.
- Guroi, M.D., and Holden, T.E. 1988. The effect of copper and iron complexation on removal of cyanide by ozone. Ind. Eng. Chem. Res. 27(7):1157-1162.
- McGraw-Hill. 1982. Encyclopedia of science and technology. Vol. 3, p. 825. New York: McGraw-Hill Book Co.
- Metcalf & Eddy, Inc. 1986. Briefing: Technologies applicable to hazardous waste. Prepared for U.S. Environmental Protection Agency, Hazardous Waste Engineering Research Laboratory. Cincinnati, Ohio: U.S. Environmental Protection Agency.
- Nutt, S.G., and Zaidi, S.A. 1983. Treatment of cyanide-containing wastewaters by the copper-catalyzed SO₂/air oxidation process. In Proceedings of the 38th Industrial Waste Conference, Purdue University, West Lafayette, Indiana, May 10-12, 1983. Stoneham, Mass.: Butterworth Publishers.
- Patterson, J.W. 1985. Industrial wastewater treatment technology. 2nd ed. Stoneham, Mass.: Butterworth Publishers.
- Schroeter, J., and Painter, C. 1987. Potassium permanganate oxidation of electroless plating wastewater. Carus Chemical Company, 1001 Boyce Memorial Drive, P.O. Box 1500, Ottawa, Illinois 61350.
- Weast, R.C., ed. 1978. Handbook of chemistry and physics. 58th ed. Cleveland, Ohio: CRC Press.

3. CHEMICAL REDUCTION

3.1 Applicability

Chemical reduction is a treatment technology used to reduce hexavalent chromium and selenate ions to the less soluble trivalent chromium ion and elemental selenium, respectively. It is also used to treat oxidizing wastes containing reducible organics and inorganic oxidizers such as calcium hypochlorite, hydrogen peroxide (and other peroxides), and nitric acid. Because this technology frequently requires that the pH be in the acidic range, it would not normally be applicable to wastes that contain significant amounts of cyanide or sulfide. In such wastes, lowering of the pH can result in the release of toxic gases such as hydrogen cyanide or hydrogen sulfide.

Hexavalent chromium is usually present in wastes from the plating industry, metal surface preparation processes, the chromium pigments industry, and leather tanning processes. Selenates are frequently found in some mining and ore processing wastes. Organic and inorganic oxidizers are found in propellant explosives and in the chemical manufacturing industries.

3.2 Underlying Principles of Operation

The basic principle of chemical reduction is to reduce the valence of the oxidizer in solution. "Reducing agents" used to effect the reduction include the sulfur compounds sodium sulfite (Na_2SO_3), sodium bisulfite (NaHSO_3), sodium metabisulfite ($\text{Na}_2\text{S}_2\text{O}_5$), sulfur dioxide (SO_2), and sodium hydrosulfide (NaHS). The ferrous form of iron (Fe^{+2}) is a popular reducing agent in many cases. Elemental magnesium (Mg), zinc (Zn), and copper (Cu) are also effective reducing agents. Frequently, hydrazine (N_2H_2) is used as a reducing agent also. Typical reduction reactions are as follows:

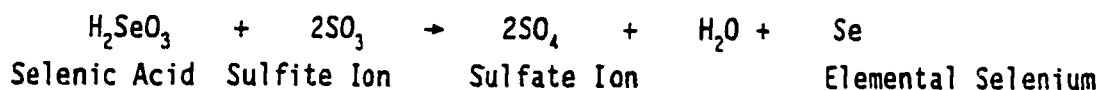
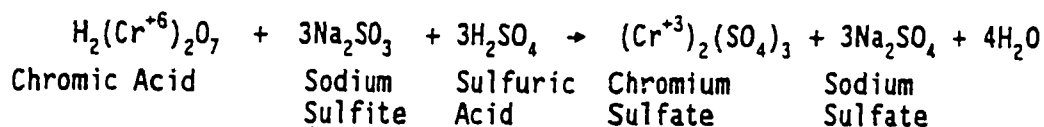
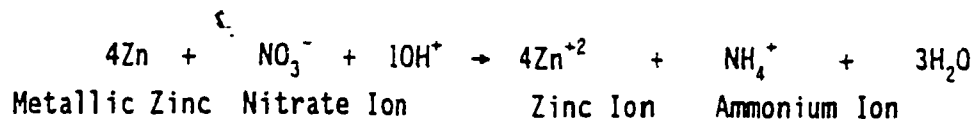
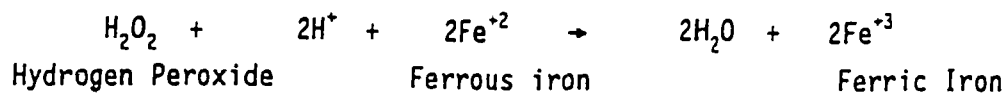

These reactions are usually accomplished at pH values from 2 to 3.

3.3 Description of Chemical Reduction Process

The chemical reduction treatment process can be operated in a batch or continuous mode. A batch system consists of a reaction tank, a mixer to homogenize the contents of the tank, a supply of reducing agent, and a source of acid and base for pH control. A continuous chemical reduction treatment system, as shown in Figure 4, usually includes a holding tank upstream of the reaction tank for flow and concentration equalization. It also typically includes instrumentation to automatically control the amount of reducing agent added and the pH of the reaction tank. The amount of reducing agent is controlled by the use of a sensor called an oxidation-reduction potential (ORP) cell. The ORP sensor electronically measures, in millivolts, the level to which the oxidation/reduction (redox) reaction has proceeded at Figure 4 any given time. It must be noted, however, that the ORP reading is very pH dependent. Consequently, if the pH is not maintained at a steady value, the ORP will vary somewhat, regardless of the level of chemical reduction.

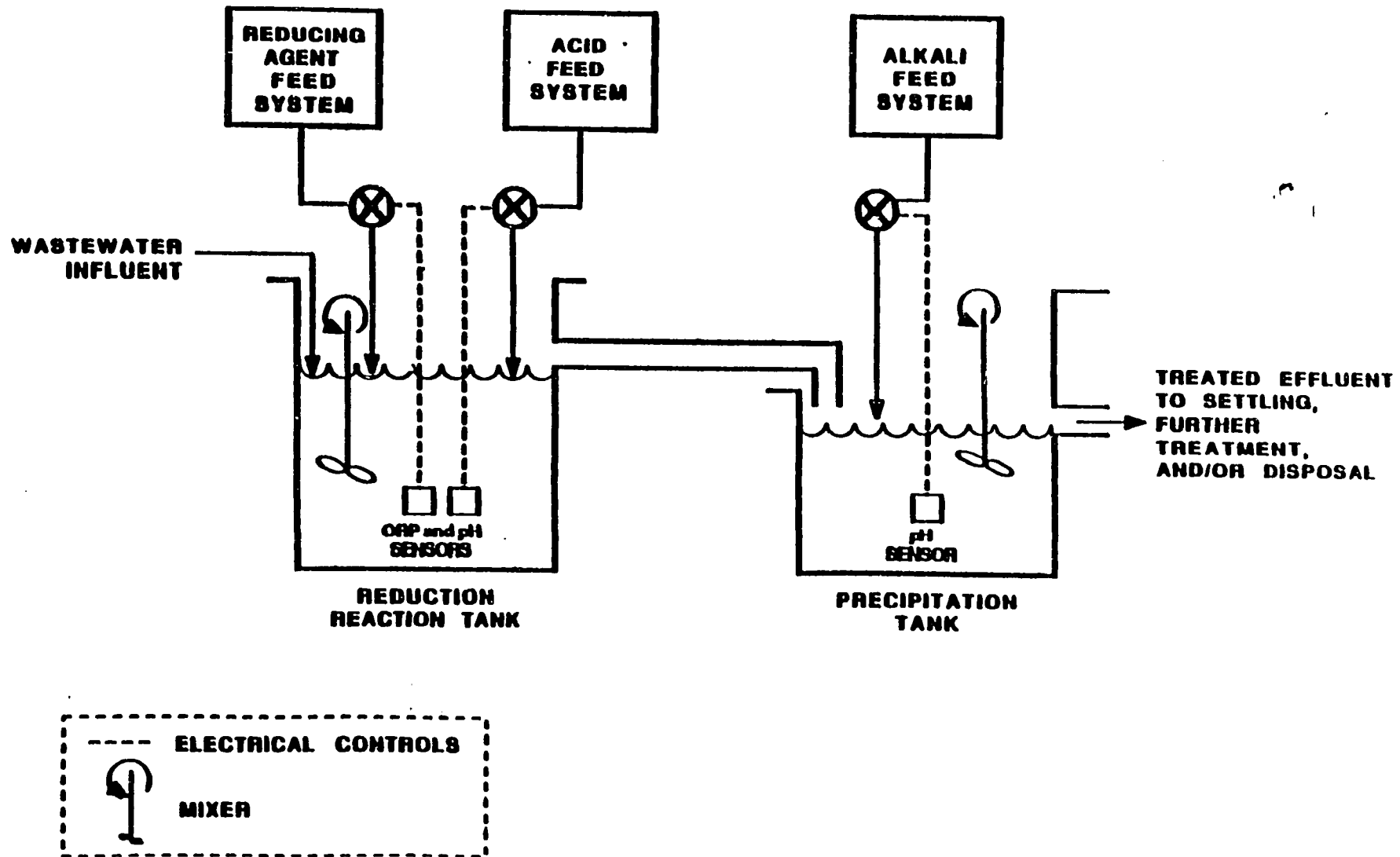

Figure 4 Continuous Chemical Reduction System

When chemical reduction is used for treating hexavalent chromium, the trivalent chromium that is formed is either reused or further treated by stabilization and land disposed. Likewise, for selenium reduction, the precipitated elemental selenium may be recovered or stabilized and disposed of.

3.4 Waste Characteristics Affecting Performance (WCAPs)

In determining whether chemical reduction will achieve the same level of performance on an untested waste that it achieved on a previously tested waste, and whether performance levels can be transferred, EPA examines the following waste characteristics: (a) the concentration of other reducible compounds and (b) the concentration of oil and grease.

3.4.1 Concentration of Other Reducible Compounds

The presence of other reducible compounds (also called oxidizers) in addition to the BDAT list constituents of concern will increase the demand of reducing agents, thereby potentially reducing the effectiveness of the treatment process. As a surrogate for the amount of organic oxidizers present in the waste, EPA might analyze for total organic carbon (TOC) in the waste. Inorganic oxidizing compounds such as ionized metals (e.g., silver, selenium, copper, mercury) may also create a demand for additional reducing agent. EPA might attempt to identify and analyze for these metal constituents. If TOC or inorganic oxidizer concentration in the untested waste is significantly higher than that in previously tested wastes, the system may not achieve the same performance as that achieved previously. Additional reducing agent may be required to effectively reduce the untested waste and achieve the same treatment performance, or other, more applicable treatment technologies may need to be considered for treatment of the untested waste.

3.4.2 Concentration of Oil and Grease

EPA believes that oil and grease compounds could cause monitoring problems because of fouling of instrumentation (e.g., electrodes for pH and ORP sensors). If the concentration of oil and grease in an untested waste is significantly higher than that in a tested waste, the untested system may not achieve the same performance. Therefore, other, more applicable treatment or pretreatment technologies may need to be considered for treatment of the untested waste.

3.5 Design and Operating Parameters

In assessing the effectiveness of the design and operation of a chemical reduction system, EPA examines the following parameters: (a) the residence time, (b) the amount and type of reducing agent, (c) the degree of mixing, (d) the pH, and (e) the reduction temperature.

For many hazardous organic constituents, analytical methods are not available or the constituent cannot be analyzed in the waste matrix. Therefore, it would normally be impossible to measure the effectiveness of the chemical reduction treatment system. In these cases EPA tries to identify measurable parameters or constituents that would act as surrogates to verify treatment.

For organic constituents, each compound contains a measurable amount of total organic carbon (TOC). Removal of TOC in the chemical reduction treatment system indicates removal of organic constituents. Hence, TOC analysis is likely to be an adequate surrogate analysis where the specific organic constituent cannot be measured.

However, TOC analysis may not be able to adequately detect treatment of specific organics in matrices that are heavily organic-laden (i.e., the TOC analysis may not be sensitive enough to detect changes at the milligrams per liter (mg/l) level in matrices where total organic concentrations are hundreds or thousands of mg/l). In these cases other surrogate parameters should be

sought. For example, if a specific analyzable constituent is expected to be treated as well as the unanalyzable constituent, the analyzable constituent concentration should be monitored as a surrogate.

3.5.1 Residence Time

The residence time affects the extent of reaction of waste contaminants with reducing agents. For a batch system, the residence time is controlled by adjustment of the treatment time in the reaction tank. For a continuous system, the waste feed rate is controlled to make sure that the system is operated at the appropriate design residence time. EPA monitors the residence time to ensure that sufficient time is provided to effectively reduce the waste.

3.5.2 Amount and Type of Reducing Agent

Several factors influence the choice of reducing agents and the amount to be added. The amount of reducing agent required to treat a given amount of reducible constituent will vary with the agent chosen. Enough reducing agent must be added to ensure complete reduction; the specific amount will depend on the type of reducible compounds in the waste and the chemistry of the reduction reactions. Theoretically, the amount of reducing agent to be added can be computed from reduction reaction stoichiometry. In practice, however, an excess of reducing agent should be used. Testing for excess reducing agent, if possible, will determine whether the reaction has reached completion.

In continuous processes, the addition of reducing agent is usually accomplished by automated feed methods. The amount of reducing agent needed is usually metered and controlled automatically by an oxidation-reduction potential (ORP) sensor. EPA examines the amount of reduction agent added to the chemical reduction system to ensure that it is sufficient to effectively reduce the waste and, for continuous processes, examines how the facility ensures that the particular addition rate is maintained. EPA may also test for excess reducing agent in the system effluent. For continuous processes, EPA monitors the ORP to

ensure that enough reducing agent is supplied. EPA may also monitor pH to determine whether it is controlled to the appropriate optimum range. For continuous systems, pH is monitored to ensure that it is kept steady to avoid changes in ORP caused by pH variations.

3.5.3 Degree of Mixing

Process tanks must be equipped with mixers to ensure maximum contact between the reducing agent and the waste oxidizing solution. Proper mixing also homogenizes any solid precipitates that may be present, or that may form from side reactions, so that they can also be reduced if necessary. Mixing provides an even distribution of tank contents and a homogeneous pH throughout the waste, improving reduction of wastewater constituents. The quantifiable degree of mixing is a complex assessment that includes, among other factors, the amount of energy supplied, the length of time the material is mixed, and the related turbulence effects of the specific size and shape of the tank. This is beyond the scope of simple measurement. EPA, however, evaluates the degree of mixing qualitatively, using engineering judgment, by considering whether mixing is provided and whether the type of mixing device is one that could be expected to achieve uniform mixing of the waste solution.

3.5.4 pH

For batch and continuous systems, the pH affects the reduction reaction. The reaction speed is usually significantly reduced at higher pH values (typically above 4.0). It is worth noting that some reduction reactions may proceed better under alkaline conditions, in which case pH must be properly controlled to the appropriate alkaline range. For a batch system, the pH can be monitored intermittently during treatment. For a continuous system, the pH must be continuously monitored because it affects the ORP reading. EPA monitors the pH to ensure that the system is operating at the appropriate design condition and to diagnose operational problems.

3.5.5 Reduction Temperature

Temperature affects the rate of reaction and the solubility of the reactants in the waste. As the temperature is increased, the solubility of the reactants, in most instances, is increased and the required residence time, in most cases, is reduced. EPA may monitor the reduction temperature to ensure that the system is operating at the appropriate design condition and to diagnose operational problems.

3.6 References

- McGraw-Hill. 1982. Encyclopedia of science and technology. Vol. 9, pp. 714-718. New York: McGraw-Hill Book Co.
- Nebergall et al. General chemistry. 5th ed. Lexington, Mass.: D.C. Heath and Company.
- Patterson, J.W. 1985. Industrial wastewater treatment technology. 2nd ed. Stoneham, Mass.: Butterworth Publishers.

4. ELECTROLYTIC OXIDATION OF CYANIDE

4.1 Applicability

Electrolytic oxidation is a treatment technology with demonstrated applicability to the treatment of wastes containing high concentrations of cyanide in solution. Because of excessive retention time requirements, the process is often applied as preliminary treatment for highly concentrated cyanide wastes, prior to more conventional chemical cyanide oxidation.

This treatment technology is used in industry for the destruction of cyanide in (a) concentrated spent plating solutions and stripping solutions, (b) spent heat treating baths, (c) alkaline descalers, and (d) metal passivating (rust-inhibiting) solutions. Electrolytic oxidation has been demonstrated successfully for treatment of wastes containing concentrations of cyanide up to 100,000 mg/l. However, for concentrations of cyanide lower than 500 mg/l, chemical oxidation treatment may be more efficient (see Section I.A.2).

4.2 Underlying Principles of Operation

The basic principle of operation for electrolytic oxidation of cyanide is that concentrated cyanide waste subject to an electrolytic reaction with dissolved oxygen in an aqueous solution is broken down to the gaseous products carbon dioxide (CO₂), nitrogen (N₂), and ammonia (NH₃). The process is conducted at elevated temperatures for periods ranging from several hours to over a week, depending on the initial cyanide concentration and the desired final cyanide concentration. The theoretical destruction process that takes place at the anodes is described by the following reaction:

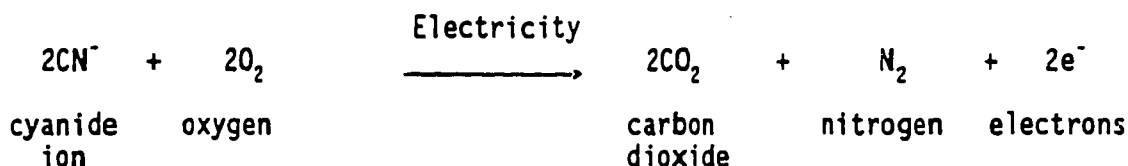

The effectiveness of electrolytic oxidation is dependent on the conductivity of the waste, which is a function of several waste characteristics including the concentration of cyanide and other ions in solution. As the process continues, the waste becomes less capable of conducting electricity as the cyanide concentration is reduced, causing the electrolytic reaction to be much less efficient at longer retention times.

4.3 Description of Electrolytic Oxidation Process

Typically, electrolytic destruction of cyanide takes place in a closed cell. This cell consists of two electrodes suspended in an aqueous solution, with direct current (DC) electricity supplied to drive the reaction to completion. The temperature of the bath containing the cyanide waste is maintained at or above 52°C (125°F). Sodium chloride may be added to the solution as an electrolyte (conductor) to increase the conductivity of the waste being treated. Since the reaction may take days or weeks, water is usually added to the tank periodically to make up for losses due to evaporation from the heated tank. This is necessary to ensure that the electrodes remain fully submerged so that a full flow of current is maintained in the solution during treatment. Following treatment, the treated waste is usually further treated in a conventional chemical oxidation system to destroy residual cyanides.

4.4 Waste Characteristics Affecting Performance (WCAPs)

In determining whether electrolytic oxidation will achieve the same level of performance on an untested waste that it achieved a previously tested waste and whether performance levels can be transferred, EPA examines the following waste characteristics: (a) the concentration of other oxidizable materials and (b) the concentration of reducible metals.

4.4.1 Concentration of Other Oxidizable Materials

The presence of oxidizable organics (such as oil and grease and surfactants) and the presence of inorganic ionic species in a reduced state (such as trivalent chromium or sulfide) may increase the treatment time required to achieve destruction of cyanide because these materials may be oxidized preferentially to the cyanide in solution. If concentrations of other oxidizable materials are significantly higher in the untested waste than in the tested waste, the system may not achieve the same performance. Longer reaction time may be required to oxidize cyanide and achieve the same treatment performance, or other, more applicable treatment technologies may need to be considered for treatment of the untested waste.

4.4.2 Concentration of Reducible Metals

The electrolytic process may cause some of the more easily reduced metals in the waste, such as copper, to plate out onto the cathode as the pure metal. The plating of metals onto the cathode may result in changes in current density and, hence, may change the rate of cyanide oxidation. If the concentration of reducible metals in the untested waste is significantly higher than that in the tested waste, the system may not achieve the same performance and other, more applicable treatment technologies may need to be considered for treatment of the untested waste.

4.5 Design and Operating Parameters

In assessing the effectiveness of the design and operation of an electrolytic oxidation system, EPA examines the following parameters: (a) the oxidation temperature, (b) the residence time, (c) the pH, (d) the electrical conductivity, (e) the electrode spacing and surface area, and (f) the degree of mixing.

4.5.1 Oxidation Temperature

For the electrolytic process, elevated temperatures are used. Normal temperatures range from 52 to 93°C (125 to 200°F). The temperature can be raised by increasing the flow of steam to the coils or jacket supplying heat to the reactor contents. EPA monitors the oxidation temperature to ensure that the system is operating at the appropriate design condition and to diagnose operational problems.

4.5.2 Residence Time

Electrolytic oxidation is usually a batch process. The time allowed to complete the reaction is an important factor in electrolysis and is dependent on the initial concentration of the waste and the desired final cyanide concentration. The rate of cyanide destruction decreases as the cyanide concentration decreases (i.e., the rate of cyanide destruction asymptotically approaches zero). Typical residence times range from periods of several hours to more than a week. EPA observes the residence time to ensure that sufficient time is provided to effectively destroy the cyanides in the wastes.

4.5.3 pH

Typical solutions for electrolytic oxidation have a pH ranging from 11.5 to 12.0. The pH must be maintained in the alkaline range to prevent liberation of toxic hydrogen cyanide. Typically, pH is controlled by the addition of caustic or lime. EPA monitors the pH to ensure that the treatment system is operating at the appropriate design condition and to diagnose operational problems.

4.5.4 Electrical Conductivity

The solution must have an electrical conductivity high enough to allow the reaction to proceed at an acceptable rate. If the conductivity is not high

enough, it can be improved by adding an electrolyte such as sodium chloride. The conductivity of the waste during the reaction is normally determined by monitoring both the current and voltage of the cell. EPA monitors the electrical conductivity to ensure that the treatment system is operating at the appropriate design condition.

4.5.5 Electrode Spacing and Surface Area

The spacing and surface area of the electrodes directly impact the current flowing through the waste. The reaction rate is increased by both closer electrode spacing and more electrode surface area because each increases the current density in the cell. EPA observes the electrode spacing and surface area to ensure that sufficient current density is provided to effectively destroy the cyanides in the waste.

4.5.6 Degree of Mixing

Electrolytic destruction of cyanides requires good mixing in the reaction vessel. Mixing helps ensure an adequate supply of oxygen (from the air) for the electrochemical reaction (see Section 4.2, Underlying Principles of Operation), enhances mass transfer to promote the oxidation reaction, and keeps suspended solids in suspension. Mixing may be provided by the bubbling of air from the bottom of the reactor, or an external source of mixing may be provided. The quantifiable degree of mixing is a complex assessment that includes, among other factors, the amount of energy supplied, the length of time the material is mixed, and the related turbulence effects of the size and shape of the reaction vessel used. The degree of mixing is beyond the scope of simple measurement. EPA, however, evaluates the degree of mixing qualitatively by considering whether mixing is provided and whether the type of mixing device is one that could be expected to achieve uniform mixing of the waste.

4.6 References

- Cushnie, G.C., Jr. 1985. Electroplating wastewater pollution control technology. p. 205. Park Ridge, N.J.: Noyes Publications.
- Easton, J.K. 1967. Electrolytic decomposition of concentrated cyanide plating wastes. Journal Water Pollution Control Federation 39(10):1621-1626.
- Patterson, J.W. 1985. Industrial wastewater treatment technology. 2nd ed., pp. 123-125. Stoneham, Mass. Butterworth Publishers.
- Pearson, G.J., and Karrs, S.R. 1984. Electrolytic cyanide destruction. In Proceedings for plating and surface finishing, pp. 2 and 3.
- Roy, C.H. 1981. Electrolytic wastewater treatment. In a series of American Electroplaters Society, Inc., illustrated lectures, pp. 8-10.

5. INCINERATION

5.1 Applicability

Incineration is a treatment technology applicable to the treatment of wastes containing a wide range of organic concentrations and low concentrations of water, metals, and other inorganics. The four most common incineration systems are liquid injection, rotary kiln, fluidized bed, and fixed hearth.

Liquid injection incineration is applicable to wastes having sufficiently low viscosity values (less than 750 saybolt universal seconds (Sus) such that the waste can be atomized in the combustion chamber. However, viscosity is temperature dependent so that while liquid injection may not be applicable to a waste at ambient conditions, it may become applicable when the waste is heated. In addition, the number of waste particles and the concentration of suspended solids need to be sufficiently low to avoid clogging of the burner nozzle (or atomizer openings).

Rotary kiln, fluidized bed, and fixed hearth incineration are applicable to wastes having a wide range of viscosity, particle size, and suspended solids concentration.

Incineration of highly explosive constituents may require treatment in units that are specially designed and fitted with certain explosion-proof equipment. Incinerators for corrosive waste should be equipped, if necessary, with pollution control devices to remove corrosive gases that may be generated from the burning of corrosive waste. The incineration of hazardous waste must be performed in accordance with the incinerator design and emissions regulations in 40 CFR 264, Subpart O.

5.2 Underlying Principles of Operation

The basic principle of operation for incineration is the thermal decomposition of organic constituents via cracking and oxidation reactions at high temperatures (usually between 760 and 1550°C (1400 and 3000°F) to convert them into carbon dioxide and water vapor along with nitrite oxides, nitrates, and ammonia (for nitrogen-containing wastes); sulfur oxides and sulfate (for sulfur-containing wastes); or halogen acids (for halogenated wastes).

In liquid injection incineration the organic constituents in the waste are volatilized and the chemical bonds are destabilized. Once the chemical bonds are broken, these constituents react with oxygen to form carbon dioxide, water vapor, and other aforementioned compounds.

In rotary kiln and fixed hearth incineration, two chambers are involved in the incineration process. In the primary chamber, the organic constituents in the waste are volatilized. During this volatilization process, some of the organic constituents oxidize to form carbon dioxide and water vapor. In the secondary chamber, the chemical bonds are destabilized, resulting in the organic constituents reacting with oxygen to form carbon dioxide, water vapor, and other aforementioned compounds.

In fluidized bed incineration, a single chamber contains the fluidizing sand and a freeboard section above the sand. The fluidized bed aids in the volatilization and combustion of the organic waste constituents. The sand in the bed provides a sufficient heat capacity to volatilize organic constituents. The forced air used to fluidize the bed provides sufficient oxygen and turbulence to enhance the reactions of organics with oxygen to form carbon dioxide, water vapor, and other aforementioned compounds. Additional time for conversion of the organic constituents is provided by the freeboard above the fluidized bed.

5.3 Description of Incineration Processes

The physical form of the waste determines the appropriate feed method into the incineration system. Liquids are pumped into the combustion chamber through nozzles or via specially designed atomizing burners. Wastes containing suspended particles may need to be screened to avoid clogging of small nozzle or atomizer openings. Sludges and slurries are fed using positive displacement pumps and water-cooled injection ports. Bulk solid wastes may require shredding for control of particle size. Wastes may be fed to the combustion chamber via rams, gravity feed, air lock feeders, vibratory or screw feeders, or belt feeders. Containerized waste is gravity-fed or ram-fed.

Although sustained combustion is possible with waste heat content as low as 2230 kcal/kg (4010 Btu/lb), wastes are typically blended to a net heat content of 4450 kcal/kg (8000 Btu/lb) or higher or auxiliary fuel is used in the combustion chambers to raise the heat content to a level sufficient to sustain the combustion process.

Following incineration of wastes, fly ash particulates, acid gases (halogen acids), and other gaseous pollutants (nitric oxides (NO_x) and sulfur oxides (SO_x)) are further treated in an air pollution control system. Particulate emissions from most waste combustion systems generally have particle diameters less than 1 micron and require high-efficiency collection systems to minimize air emissions. The most common air pollution control system used includes a quench (for gas cooling and conditioning), followed by a high-energy venturi scrubber* (for particulate and acid gas removal), a packed bed or plate tower absorber (for acid gas removal), and a demister (for vapor mist plume elimination).

Packed bed or plate tower scrubbers are commonly used without venturi scrubbers in the air pollution control systems at liquid injection incinerator

*A venturi is a short tube or duct with a tapering constriction that causes an increase in the velocity of fluid flow and a corresponding decrease in pressure.

facilities, where absorption of gaseous pollutants is more important than particulate control. (Wastes burned in liquid injection incinerators typically have a low ash content and, hence, generate a low level of fly ash particulates.)

Some liquid injection incinerator facilities do not employ any air pollution control system because the wastes burned contain low levels of both ash and halogen content, thereby generating low (i.e., untreatable) levels of fly ash particulates and acid gases.

Many air pollution control system designs in recent years have begun to incorporate waste heat boilers as a substitute for gas quenching as a means of energy recovery. Wet electrostatic precipitators (ESP), ionizing wet scrubbers (IWS), and fabric filters are also being incorporated into newer systems because these devices have high removal efficiencies for small particles and a lower pressure drop than that of venturi scrubbers.

The inorganic constituents of wastes (noncombustible ash) are not destroyed by incineration. These materials, depending on their composition, exit the incinerator as either bottom ash from the combustion chamber or fly ash particulates suspended in the combustion gas stream. Bottom ash is typically either air-cooled or quenched with water following discharge from the combustion chamber. This waste is then stabilized (if levels of leachable metal constituents of concern are found) and/or land disposed.

Fly ash particulates, as well as acid gases and other gaseous pollutants, are entrained in the scrubber waters of the air pollution control system and collected in the sumps of recirculation tanks. Here the acids are neutralized with caustic and much of the water is returned to the air pollution control system. Eventually, a portion or all of these scrubber waters are discharged for treatment and disposal when the total dissolved solids level becomes excessively high. Scrubber waters are discharged either to a settling tank or lagoon or to a chemical precipitation system (if treatable levels of soluble metal constituents of concern are found) to remove these solids prior to their land

disposal. Depending on the nature of the remaining dissolved constituents and their concentrations, treated scrubber waters may be returned to the air pollution control system, further treated in filtration processes, or discharged.

Below are descriptions of the incineration processes for the four most common incinerator systems.

5.3.1 Liquid Injection

In a liquid injection incineration system, a burner or nozzle atomizes the waste and injects it into the combustion chamber, where it is incinerated in the presence of air or oxygen. A forced-draft system supplies the combustion chamber with air to provide oxygen for combustion and turbulence for mixing. The combustion chamber is usually a cylinder lined with refractory (i.e., heat-resistant) brick and can be fired horizontally, vertically upward, or vertically downward. Figure 5 illustrates a liquid injection incineration system.

5.3.2 Rotary Kiln

A rotary kiln is a slowly rotating, refractory-lined cylinder that is mounted at a slight incline from the horizontal. Solid wastes enter at the high end of the kiln, and liquid or gaseous wastes generally enter through atomizing nozzles in the afterburner section of the kiln. A forced-draft system supplies the kiln with air to provide oxygen for combustion and turbulence for mixing. Rotation of the kiln enhances the exposure of the solids to the heat, thereby aiding their volatilization as well as providing additional mixing of the solids with air combustion. In addition, the rotation causes the ash to move to the lower end of the kiln, from which it is removed. Rotary kiln systems usually have a secondary combustion chamber or afterburner following the kiln for further combustion of the volatilized waste constituents. Figure 6 is a diagram of a rotary kiln incineration system.

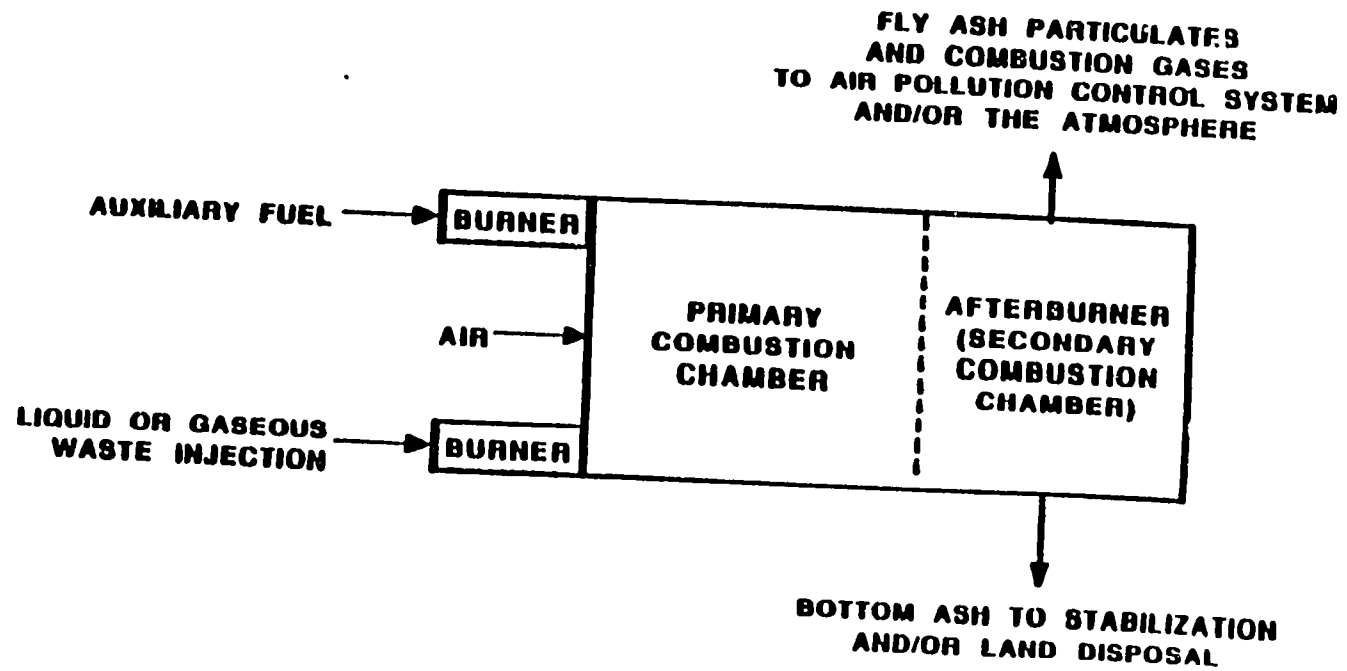

Figure 5 Liquid Injection Incineration System

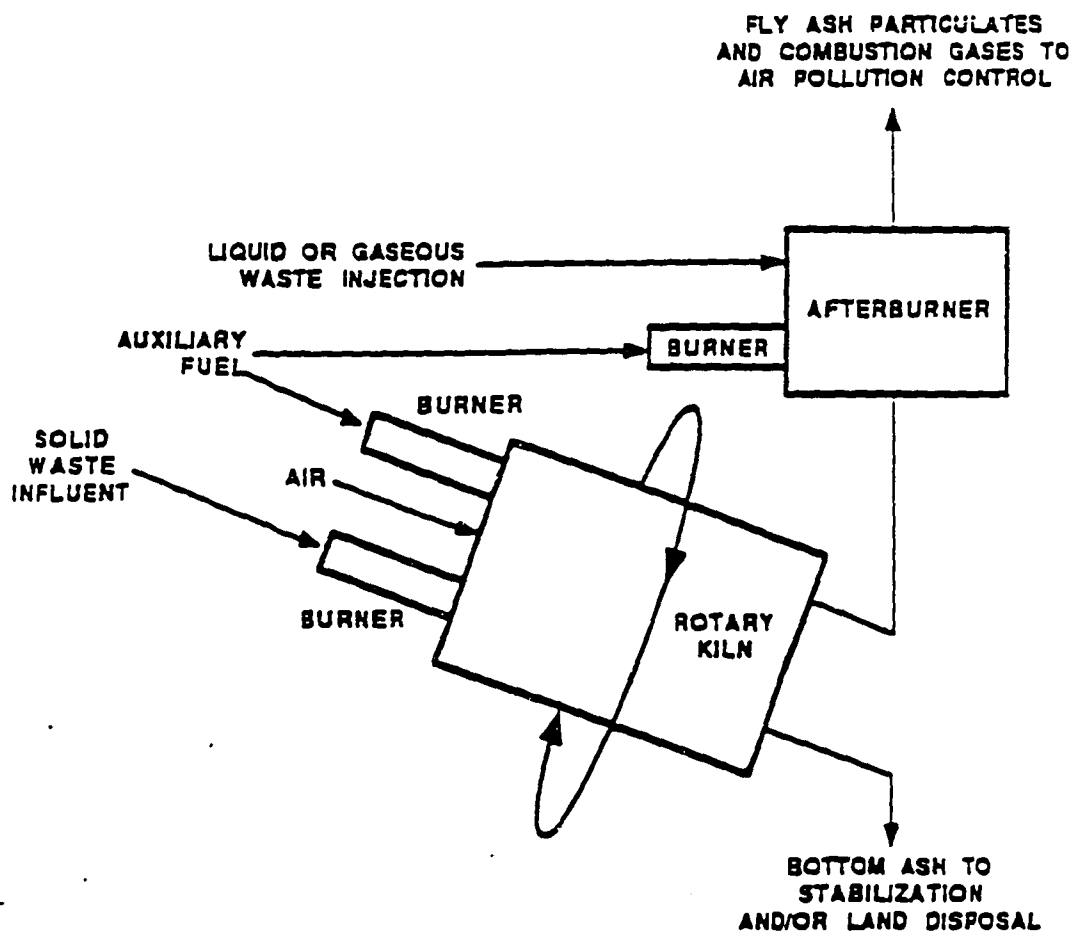

Figure 6 Rotary Kiln Incineration System

5.3.3 Fluidized Bed

A fluidized bed incinerator consists of a column containing inert particles such as sand, which is referred to as the bed. Air, driven by a blower, enters the bottom of the bed to fluidize the sand. Air passage through the bed provides oxygen for combustion and promotes rapid and uniform mixing of the injected waste material within the fluidized bed. The fluidized bed has an extremely high heat capacity (approximately three times that of flue (combustion) gases at the same temperature), thereby providing a large heat reservoir. The injected waste reaches incineration temperature quickly and transfers the heat of combustion back to the bed. The freeboard above the fluidized bed provides additional time for combustion of organic constituents. Because of the excellent mixing properties associated with fluidized bed incinerators, they can operate at lower temperatures more effectively than other incinerators. Figure 7 is a diagram of a fluidized bed incineration system.

5.3.4 Fixed Hearth Incineration

Fixed hearth (also called controlled air or starved air) incineration is a two-stage combustion process. Waste is ram-fed into the first stage, or primary chamber, and burned at less than stoichiometric conditions (not enough oxygen for complete combustion). The resultant smoke and pyrolysis products, consisting primarily of volatile hydrocarbons and carbon monoxide, along with the typical products of combustion, pass to the secondary chamber. Here additional air is injected to complete the combustion process. This two-stage process generally yields low fly ash particulate and carbon monoxide (CO) emissions. The primary chamber combustion reactions and resultant combustion gas velocities are maintained at low levels by the starved air conditions so that particulate entrainment and carryover in the combustion gases are minimized. Figure 8 is a diagram of a fixed hearth incineration system.

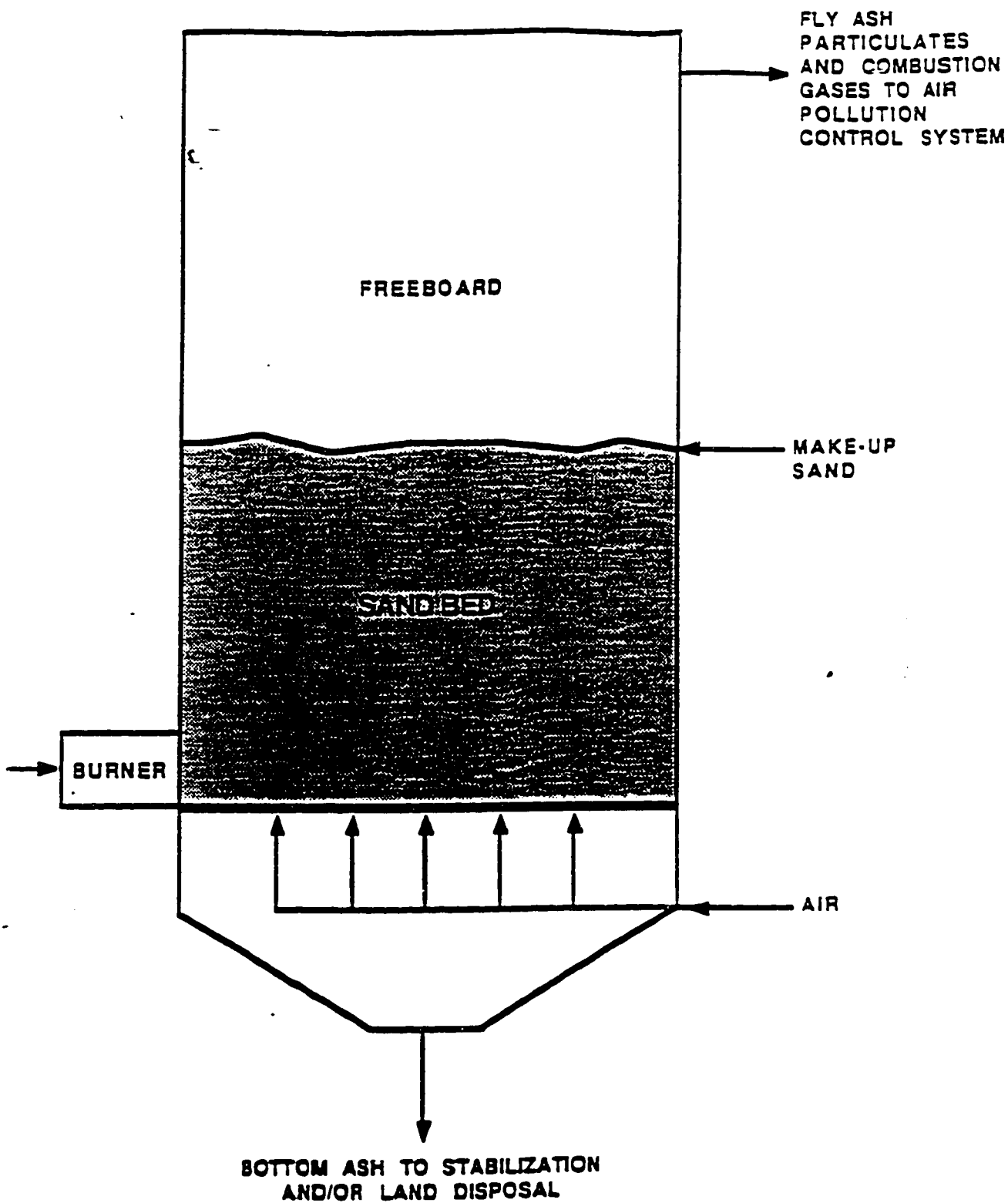
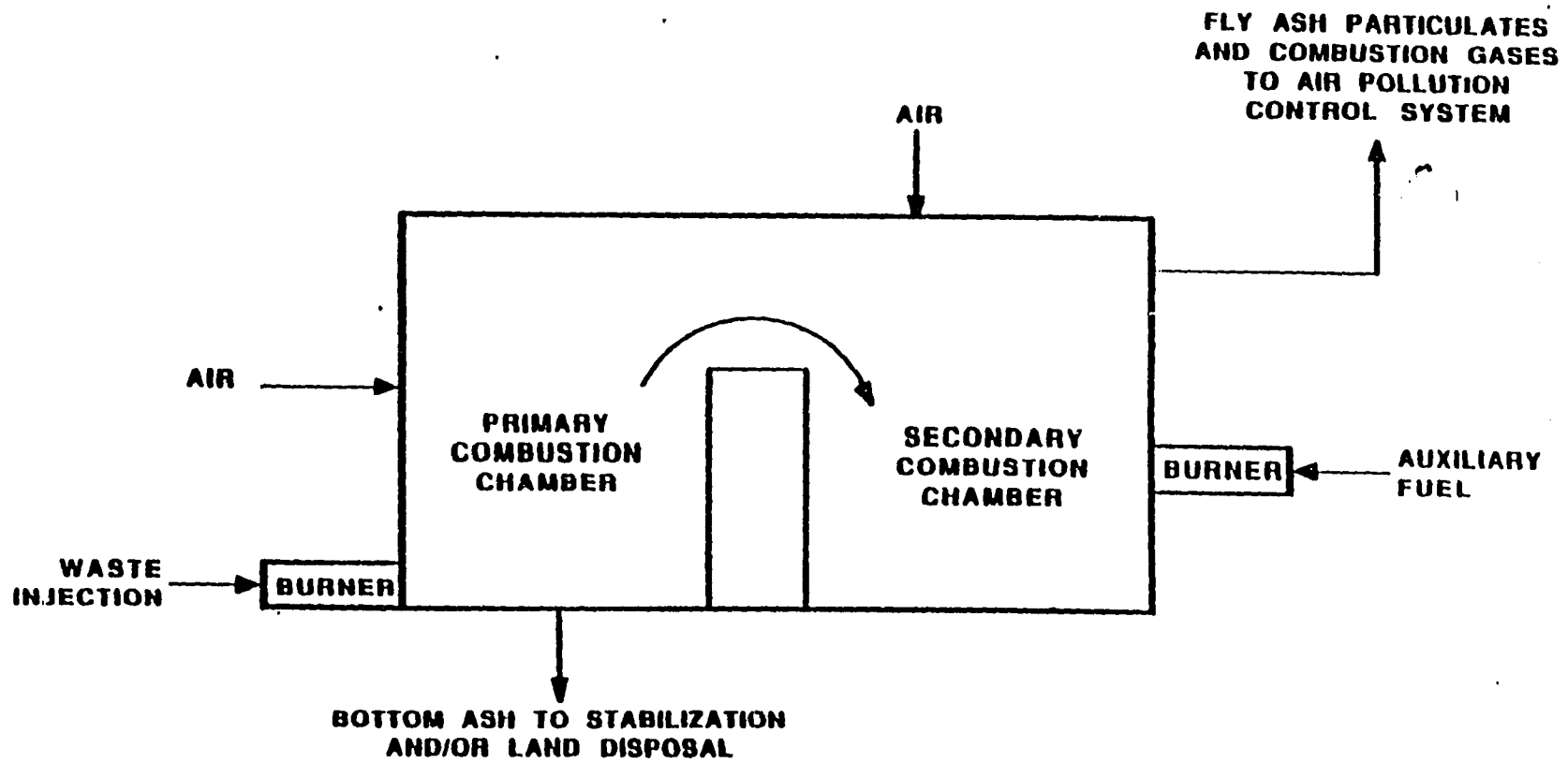

Figure 7 Fluidized Bed Incineration System



53

Figure 8 Fixed Hearth Incineration System

5.4 Waste Characteristics Affecting Performance (WCAPs)

In determining whether incineration will achieve the same level of performance on an untested waste that it achieved on a previously tested waste and whether performance levels can be transferred, EPA examines the following waste characteristics: (a) the thermal conductivity of the waste, (b) the component boiling points, (c) the component bond dissociation energies, (d) the heating value of the waste, (e) the concentration of explosive constituents, and (f) the concentration of noncombustible constituents.

5.4.1 Thermal Conductivity of the Waste

A major factor determining whether a particular constituent will volatilize is the transfer of heat through the waste. For rotary kiln, fluidized bed, and fixed hearth incineration, heat is transferred through the waste by radiation, convection, and conduction.

EPA examined all three methods of heat transfer. For a given incinerator, heat transferred through various wastes by radiation and convection is more a function of the design and type of incinerator than of the waste being treated; therefore, EPA believes that conduction would be the primary cause of heat transfer differences between wastes. Heat flow by conduction is proportional to the temperature gradient across the material. The proportionality constant, referred to as the thermal conductivity, is a property of the material to be incinerated.

Thermal conductivity measurements, as part of a treatability comparison for two different wastes to be treated by a single incinerator, are most meaningful when applied to wastes that are homogeneous (i.e., uniform throughout). As wastes exhibit greater degrees of nonhomogeneity, thermal conductivity becomes less accurate in predicting treatability because the measurement essentially reflects heat flow through regions having the greatest conductivity (i.e., the path of least resistance) and not heat flow through all parts of the waste.

Nevertheless, EPA believes that thermal conductivity may provide the best measure of performance transfer. If the thermal conductivity of an untested waste is significantly lower than that of the tested waste, the system may not achieve the same performance. Higher temperatures may be required to improve heat transfer through the waste and achieve the same treatment performance, or other, more applicable treatment technologies may need to be considered for treatment of the untested wastes.

5.4.2 Component Boiling Points

Following transfer of heat to a constituent within a waste, the constituent's removal depends on its volatility. EPA recognizes, however, that volatilities are difficult to measure or calculate directly for the types of wastes generally treated by incineration because the wastes usually consist of a mixture of components. However, because the volatilities of components are usually inversely proportional to their boiling points (i.e., the higher the boiling point, the lower the volatility), EPA uses the boiling points of waste components as a surrogate waste characteristic for volatility. If the boiling points of waste components in the untested waste are significantly higher than those in the tested waste, the system may not achieve the same performance. Higher temperatures may be required to volatilize less volatile components and achieve the same treatment performance or other, more applicable treatment technologies may need to be considered for treatment of the untested wastes.

5.4.3 Component Bond Dissociation Energies

The activation energy is the amount of heat energy needed to destabilize molecular bonds so that the exothermic combustion reactions can proceed. Typically, the activation energy required for incineration of solids is greater than that required for liquids, and the activation energy required for liquids is higher than that required for gases. However, the activation energies for components are difficult to measure or calculate directly and usually must be determined empirically. The bond dissociation energy is the amount of energy

needed to break each of the individual bonds in a molecule. Theoretically, the bond dissociation energy and the activation energy are equivalent. However, other energy effects including interactions between different molecular bonds may have a significant influence on the activation energy. Nevertheless, EPA believes that bond dissociation energy is the best indicator for activation energy and therefore uses it as a surrogate waste characteristic. If the bond dissociation energies of waste components in an untested waste are significantly higher than those in the tested waste, the system may not achieve the same performance. Higher temperatures may be required to destabilize molecular bonds for waste components with high bond dissociation energies and achieve the same treatment performance, or other, more applicable treatment technologies may need to be considered for treatment of the untested waste.

5.4.4 Heating Value of the Waste

The amount of heat released from the exothermic combustion reactions of a waste is referred to as its heating value. To maintain combustion, the heating value of a waste must be sufficient to heat incoming waste up to the appropriate design incineration temperature and provide the necessary activation energy for additional combustion reactions to occur. Higher waste heating values are required for higher incineration temperatures and higher amounts of excess oxygen to sustain combustion without auxiliary fuel consumption. Low heating values for an organic waste are usually caused by high concentrations of water or halogenated compounds. If the heating value of an untested waste is significantly lower than that of the tested waste, the system may not achieve the same performance. Auxiliary fuel may be required to provide the necessary heat to maintain combustion and achieve the same treatment performance, or other, more applicable treatment technologies may need to be considered for treatment of the untested waste.

5.4.5 Concentration of Explosive Constituents

Explosive constituents may interfere with the smooth operation of an incinerator, causing process upsets resulting in ineffective treatment of the waste. If the concentration of explosive constituents in an untested waste is significantly higher than that in the tested waste, the system may not achieve the same performance and other, more applicable treatment technologies may need to be considered for treatment of the untested waste.

5.4.6 Concentration of Noncombustible Constituents

Noncombustible constituents include water, metals, and other inorganics. High concentrations of noncombustible constituents result in low waste heating values, requiring auxiliary fuel; large quantities of bottom ash, requiring stabilization treatment (if treatable levels of leachable metal constituents of concern are present) and/or disposal; and large quantities of fly ash particulates and volatile metals in the combustion gases, requiring removal in an air pollution control system and treatment in a settling tank or lagoon or by means of a chemical precipitation system (if treatable levels of soluble metal constituents of concern are present) followed by disposal. Volatile metals such as arsenic may also fuse to the refractory walls in the combustion chamber, inhibiting effective operation of the incinerator. If the concentration of noncombustible constituents in an untested waste is significantly higher than that in the tested waste, the system may not achieve the same performance and other, more applicable treatment technologies may need to be considered for treatment of the untested waste.

5.5 Design and Operating Parameters

In assessing the effectiveness of the design and operation of an incineration system, EPA examines the following parameters: (a) the incineration temperature, (b) the concentration of excess oxygen in the combustion gas, (c) the concentration of carbon monoxide in the combustion gas, (d) the waste

feed rate, and (e) the degree of waste/air mixing. In addition, incineration of hazardous waste must be performed in accordance with the incineration design and emissions regulations in 40 CFR 264, Subpart O. For many hazardous organic constituents, analytical methods are not available or the constituent cannot be analyzed in the waste matrix. Therefore, it would normally be impossible to measure the effectiveness of the incineration treatment system. In these cases EPA tries to identify measurable parameters or constituents that would act as surrogates to verify treatment.

For organic constituents, each constituent contains a measurable amount of total organic carbon (TOC). Removal of TOC in the incineration treatment system indicates removal of organic constituents. Hence, TOC analysis is likely to be an adequate surrogate analysis where the specific organic constituent cannot be measured.

However, TOC analysis may not be able to adequately detect treatment of specific organics in matrices that are heavily organic-laden (i.e., the TOC analysis may not be sensitive enough to detect changes at the milligrams per liter (mg/l) level in matrices where total organic concentrations are hundreds or thousands of mg/l). In these cases other surrogate parameters should be sought. For example, if a specific analyzable constituent is expected to be treated as well as the unanalyzable constituent, the analyzable constituent concentration should be monitored as a surrogate.

5.5.1 Incineration Temperature

Temperature provides an indirect measure of the energy available (i.e., Btu/hr) to both volatilize organic waste constituents and overcome their activation energy. As the design temperature in the combustion chamber increases, more constituents with lower volatilities and higher activation energies will be destroyed. EPA monitors the incineration temperature continuously to ensure that the system is operating at the appropriate design condition and to diagnose operational problems.

5.5.2 Concentration of Excess Oxygen in the Combustion Gas

A sufficient supply of oxygen must be supplied to the combustion chamber to effectively incinerate the organic waste constituents. The stoichiometric or minimum theoretical oxygen requirement to completely combust the waste is based on the amounts of combustible constituents in the waste. If perfect mixing could be achieved and the waste burned instantaneously, only the stoichiometric amount of oxygen would be needed for complete combustion. However, neither of these phenomena occur in commercial incinerators. The amount of excess oxygen in a given incinerator depends on the degree of waste/air mixing achieved in the combustion chamber and the desired degree of combustion gas cooling. Because excess air (oxygen) supplied to the combustion chamber acts as a diluent in the combustion process, it reduces the overall temperature in the incinerator (i.e., maximum theoretical incineration temperatures are achieved at zero percent excess air). This temperature reduction might be desirable to limit refractory degradation when high-heating value wastes are being burned. However, when low-heating-value wastes are being burned, excess air should be minimized to keep the system temperature as high as possible. Even with high-heating-value waste, it is desirable for equipment design considerations to limit the amount of excess air to some extent so that combustion chamber volume and downstream air pollution control system sizes can be limited.

An inadequate supply of oxygen, on the other hand, will lead to ineffective incineration with higher concentrations of carbon monoxide (CO) and organic products of incomplete combustion (PICs), resulting in a heavier load on the air pollution control system. Typically, 20 to 60 percent excess oxygen is required to provide adequate waste/oxygen contact and, subsequently, effective incineration of the waste. EPA monitors the concentration of excess oxygen in the combustion gas continuously to ensure that the system is operating at the appropriate design condition and to diagnose operational problems.

5.5.3 Concentration of Carbon Monoxide in the Combustion Gas

The concentration of carbon monoxide in the combustion gas provides an indication of the extent to which organic waste constituents are converted to carbon dioxide and water vapor. Higher carbon monoxide levels are an indication of ineffective incineration with the presence of greater amounts of unreacted or partially reacted organic waste constituents in the combustion gas, resulting in a heavier load on the air pollution control system. Higher carbon monoxide levels can result from an insufficient incineration temperature; an inadequate supply of excess oxygen; a waste feed rate that is too high, resulting in an insufficient residence time for the waste; and improper mixing in the combustion chamber. EPA monitors the concentration of carbon monoxide in the combustion gas continuously to ensure that the system is operating at the appropriate design conditions and to diagnose operational problems.

5.5.4 Waste Feed Rate

The waste feed rate determines the residence time of the waste in the combustion chamber. Sufficient residence time must be provided to allow for volatilization of the organic waste constituents, mixing with oxygen in the combustion chamber, and completion of the combustion reactions. The total residence time required for these processes to occur depends on the incineration temperature, the amount of excess oxygen provided in the combustion chamber, the degree of waste/air mixing in the combustion chamber, the size and type of incinerator used, the physical form of the waste, and the waste particle size (which determines the amount of waste surface area available for heat transfer). Typical incinerator residence times range from approximately 2 seconds for liquid and gaseous wastes in liquid injection incinerators and the afterburner, freeboard, and secondary combustion chambers of rotary kiln, fluidized bed, and fixed hearth incinerators to 30 minutes to 1 hour for solid wastes in a rotary kiln incinerator. EPA monitors the waste feed rate continuously to ensure that sufficient residence time is provided to effectively incinerate organic waste constituents.

5.5.5 Degree of Waste/Air Mixing

The incineration temperature, the amount of excess oxygen, and the residence time required to achieve effective incineration of a waste all depend to some extent on the degree of waste/air mixing in the combustion chamber. For liquid injection incinerators, the degree of waste/air mixing is primarily determined by the specific burner design and the degree of atomization of the waste/air mixture achieved. The degree of atomization is dependent on the viscosity of the liquid waste and the amount of solid impurities present. If the waste viscosity exceeds 750 Sus or the amount of solid impurities is too high, the degree of atomization may not be fine enough, resulting in ineffective incineration.

For rotary kiln incineration, the degree of waste/air mixing is determined by the airflow rate into the kiln as well as the rate of rotation (revolutions per minute (RPM)) of the kiln. As the airflow rate is increased, the degree of waste/air mixing is improved although this also reduces the incineration temperature and residence time of the combustion gases. Increasing the rate of rotation of the kiln also improves waste/air mixing; however, the residence time of the waste solids is also reduced. Typical rotation rates for rotary kilns range from 0.3 to 1.5 meters per minute (1 to 5 feet per minute).

For fluidized bed incineration, the degree of waste/air mixing is indicated by the pressure drop through the bed caused by the airflow rate used to fluidize the bed. The higher the pressure drop, the greater the degree of mixing in the fluidized bed. However, this also reduces the incineration temperature and the residence time of the waste solids and combustion gases.

For fixed hearth incineration, the degree of waste/air mixing is determined by the airflow rate into the combustion chamber. As the airflow rate is increased, the degree of waste/air mixing is improved. However, this also reduces the incineration temperature and the residence time of the combustion gases.

The quantifiable degree of waste/air mixing is a complex assessment that is difficult to express in absolute terms. However, for liquid injection incineration, EPA evaluates the degree of mixing qualitatively by examining the burner design and determining whether it could be expected to achieve effective atomization of the waste/air mixture. For rotary kiln incineration, EPA estimates the degree of mixing by monitoring the airflow rate into the kiln as well as the kiln's rate of rotation to ensure that effective mixing of the waste and air is achieved. For fluidized bed incineration, EPA estimates the degree of mixing by monitoring the pressure drop through the bed to ensure that effective mixing of waste and air is achieved. For fixed hearth incineration, EPA estimates the degree of mixing by monitoring the airflow rate into the combustion chamber to ensure that effective mixing of the waste and air is achieved.

5.6 References

- Ackerman, D.G., McGaughey, J.F., and Wagoner, D.E. 1983. At sea incineration of PCB-containing wastes on board the M/T vulcanus. 600/7-83-024. U.S. Environmental Protection Agency, Washington, D.C.
- Bonner, T.A., et al. 1981. Engineering handbook for hazardous waste incineration. Prepared by Monsanto Research Corporation for U.S. Environmental Protection Agency. PB 81-248166.
- Moller, J.J., and Christiansen, O.B. 1984. Dry scrubbing of hazardous waste incinerator flue gas by spray dryer absorption. In Proceedings of the 77th annual APCA meeting.
- Novak, R.G., Troxler, W.L., and Dehnke, T.H. 1984. Recovering energy from hazardous waste incineration, Chemical engineering progress 91:146.
- Oppelt, E.T. 1987. Incineration of hazardous waste, JAPCA vol. 37, no. 5, May 1987.
- Santoleri, J.J. 1983. Energy recovery--a by product of hazardous waste incineration systems. In Proceedings of the 15th Mid-Atlantic Industrial Waste Conference on Toxic and Hazardous Waste.
- Vogel, G., et al. 1983. Composition of hazardous waste streams currently incinerated. Prepared by Mitre Corp. for U.S. Environmental Protection Agency.
- Vogel, G., et al. 1986. Incineration and cement kiln capacity for hazardous waste treatment. In Proceedings of the 12th Annual Research Symposium on Incineration and Treatment of Hazardous Wastes, Cincinnati, Ohio.

6. WET AIR OXIDATION

6.1 Applicability

Wet air oxidation is a treatment technology applicable to wastewaters containing organics and oxidizable inorganics such as cyanide. The process is typically used to oxidize sewage sludge, regenerate spent activated carbon, and treat process wastewaters. Wastewaters treated using this technology include pesticide wastes, petrochemical process wastes, cyanide-containing metal finishing wastes, spent caustic wastewaters containing phenolic compounds, and some organic chemical production wastewaters.

This technology differs from other treatment technologies generally used to treat wastewaters containing organics in the following ways. First, wet air oxidation can be used to treat wastewaters that have higher organic concentrations than are normally handled by biological treatment, carbon adsorption, and chemical oxidation but may be too dilute to be effectively treated by thermal processes such as incineration. Wet air oxidation is most applicable for waste streams containing dissolved or suspended organics in the 500 to 50,000 mg/l range. Below 500 mg/l, the rates of wet air oxidation of most organic constituents are too slow for efficient application of this technology. For these more dilute waste streams, biological treatment, carbon adsorption, or chemical oxidation may be more applicable. For more concentrated waste streams (above 50,000 mg/l), thermal processes such as incineration may be more applicable. Second, wet air oxidation can be applied to wastes that have significant concentrations of metals (roughly 2 percent), whereas biological treatment, carbon adsorption, and chemical oxidation may have difficulty in treating such wastes.

It is important to point out that wet air oxidation proceeds by a series of reaction steps and the intermediate products formed are not always as readily oxidized as are the original constituents. Therefore, the process does not always achieve complete oxidation of the organic constituents. Accordingly, in

applying this technology it is important to assess potential products of incomplete oxidation to determine whether further treatment is necessary or whether this technology is appropriate at all.

Studies of the wet air oxidation of different compounds have led to the following empirical observations concerning a compound's susceptibility to wet air oxidation based on its chemical structure:

1. Aliphatic compounds, even with multiple halogen atoms, can be destroyed within conventional wet air oxidation conditions. Oxygenated compounds (such as low-molecular-weight alcohols, aldehydes, ketones, and carboxylic acids) are formed, but these compounds are readily biotreatable.
2. Aromatic hydrocarbons, such as toluene, acenaphthene, or pyrene, are easily oxidized.
3. Halogenated aromatic compounds can be oxidized provided there is at least one nonhalogen functional group present on the ring (e.g., pentachlorophenol (-OH) or 2,4,6-trichloroaniline (-NH₂)).
4. Halogenated aromatic compounds, such as 1,2-dichlorobenzene, and PCBs, such as Aroclor 1254, are resistant to wet air oxidation under conventional conditions.
5. Halogenated ring compounds, such as the pesticides aldrin, dieldrin, and endrin, are expected to be resistant to conventional wet air oxidation.
6. DDT can be oxidized, but results in the formation of intractable oils in conventional wet air oxidation.

7. Heterocyclic compounds containing oxygen, nitrogen, or sulfur are expected to be destroyed by wet air oxidation because the O, N, or S atoms provide a point of attack for oxidation reactions to occur.

6.2 Underlying Principles of Operation

The basic principle of operation for wet air oxidation is that the enhanced solubility of oxygen in water at high temperatures and pressures aids in the oxidation of organics. The typical operating temperature for the wet air oxidation treatment process ranges from 175 to 325°C (347 to 617°F). The pressure is maintained at a level high enough to prevent excessive evaporation of the liquid phase at the operating temperature, generally between 300 and 3000 psi. At these elevated temperatures and pressures, the solubility of oxygen in water is dramatically increased, thus providing a strong driving force for the oxidation. The reaction must take place in the aqueous phase because the chemical reactions involve both oxygen (oxidation) and water (hydrolysis). The wet air oxidation process for a specific organic compound generally involves a number of oxidation and hydrolysis reactions in series, which degrade the initial compound by steps into a series of compounds of simpler structure. Complete wet air oxidation results in the conversion of organic compounds into carbon dioxide, water vapor, ammonia (for nitrogen-containing wastes), sulfate (for sulfur-containing wastes), and halogen acids (for halogenated wastes).

However, treatable quantities of partial degradation products may remain in the treated wastewaters from wet air oxidation. Therefore, effluents from wet air oxidation processes may be given subsequent treatment including biological treatment, carbon adsorption, or chemical oxidation before being discharged.

6.3 Description of Wet Air Oxidation Process

A conventional wet air oxidation system consists of a high-pressure liquid feed pump, an oxygen source (air compressor or liquid oxygen vaporizer), a

reactor, heat exchangers, a vapor-liquid separator, and process regulators. A basic flow diagram is shown in Figure 9.

A typical batch wet air oxidation process proceeds as follows. First, a copper catalyst solution may be mixed with the aqueous waste stream if preliminary testing indicates that a catalyst is necessary. The waste is then pumped into the reaction chamber. The aqueous waste is pressurized and heated to the design pressure and temperature. After reaction conditions have been established, air is fed to the reactor for the duration of the design reaction time. At the completion of the wet air oxidation process, suspended solids or gases are removed and the remaining treated aqueous waste is either discharged directly to disposal or fed to a biological treatment, carbon adsorption, or chemical oxidation treatment system if further treatment is necessary prior to discharge to disposal.

Wet air oxidation can also be operated in a continuous process. In continuous operation, the waste is pressurized, mixed with pressurized air or oxygen, preheated in a series of heat exchangers by the hot reactor effluent and steam, and fed to the reactor. The waste feed flow rate controls the reactor residence time. Steam is fed into the reactor column to adjust the column temperature. The treated waste is separated in a gas-liquid separator, with the gases treated in an air pollution control system and/or discharged to the atmosphere, and the liquids either further treated, as mentioned above, and/or discharged to disposal.

6.4 Waste Characteristics Affecting Performance (WCAPs)

In determining whether wet air oxidation will achieve the same level of performance on an untested waste that it achieved on a previously tested waste and whether performance levels can be transferred, EPA examines the following waste characteristics: (a) the chemical oxygen demand and (b) the concentration of interfering substances.

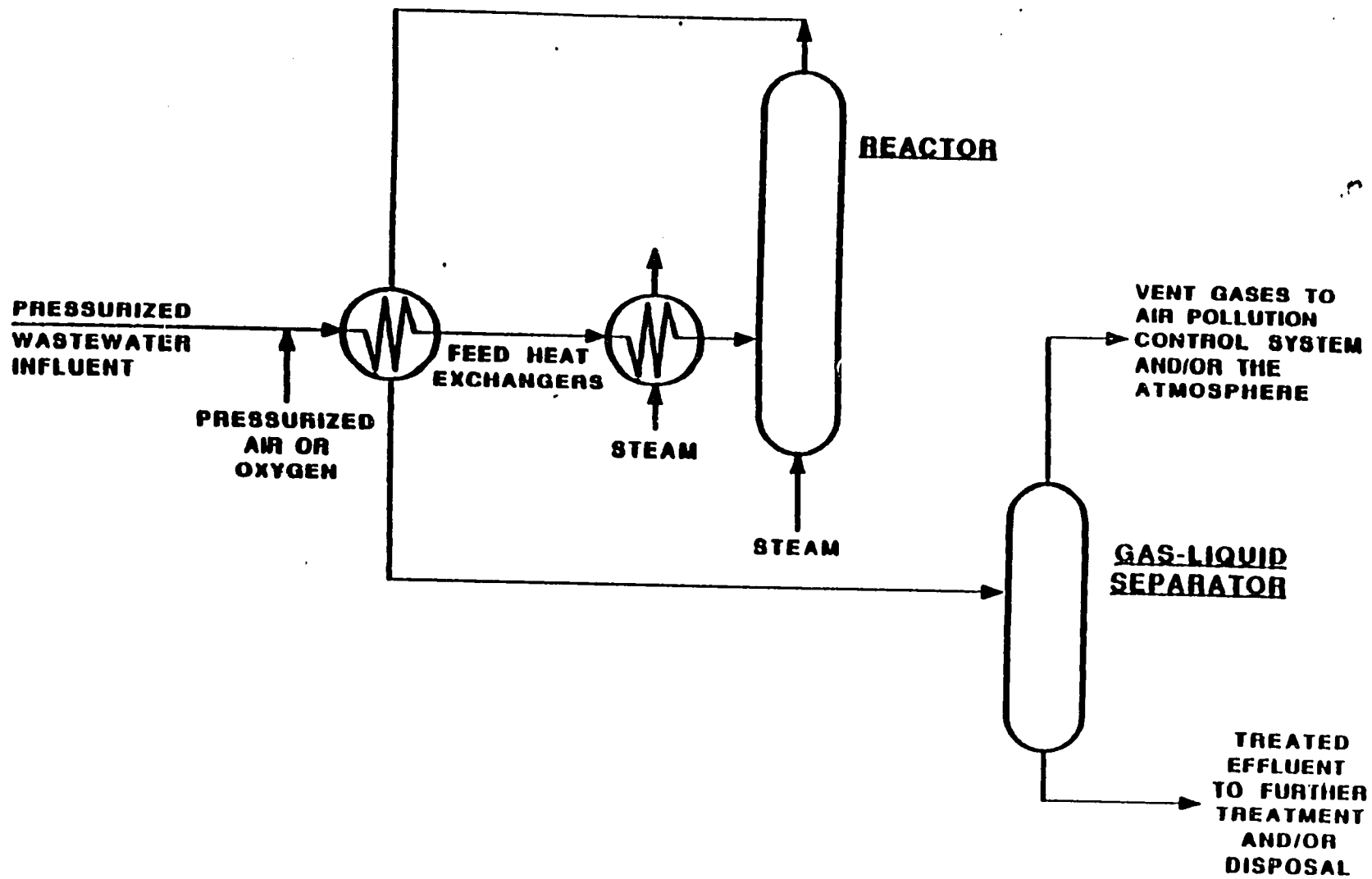

Figure 9 Continuous Wet Air Oxidation System

6.4.1 Chemical Oxygen Demand

The chemical oxygen demand (COD) of the waste is a measure of the oxygen required for complete oxidation of the oxidizable waste constituents. The limit to the amount of oxygen that can be supplied to the waste is dependent on the solubility of oxygen in the aqueous waste and the rate of dissolution of oxygen from the gas phase to the liquid phase. This sets an upper limit on the amount of oxidizable compounds that can be treated by wet air oxidation. Thus, high-COD wastes may require dilution for effective treatment to occur. If the COD of the untested waste is significantly higher than that of the tested waste, the system may not achieve the same performance. Pretreatment of the waste or dilution as part of treatment may be needed to reduce the COD to within levels treatable by the dissolved oxygen concentration and to achieve the same treatment performance, or other, more applicable treatment technologies may need to be considered for treatment of the untested waste.

6.4.2 Concentration of Interfering Substances

In some cases, addition of a water-soluble copper salt catalyst to the waste before processing is necessary for efficient oxidation treatment (for example, for oxidation of some halogenated organics). Other metals have been tested and have been found to be less effective. Interfering substances for the wet air oxidation process are essentially those that cause the formation of insoluble copper salts when copper catalysts are used. To be effective in catalyzing the oxidation reaction, the copper ions must be dissolved in solution. Sulfide, carbonate, and other negative ions that form insoluble copper salts may interfere with treatment effectiveness if they are present in significant concentrations in wastes for which copper catalysts are necessary for effective treatment. If an untested waste for which a copper catalyst is necessary for effective treatment has a concentration of interfering substances (including sulfide, carbonate, or other anions that form insoluble copper salts) significantly higher than that in a tested waste, the system may not achieve the

same performance and other, more applicable treatment technologies may need to be considered for treatment of the untested waste.

6.5 Design and Operating Parameters

In assessing the effectiveness of the design and operation of a wet air oxidation system, EPA examines the following parameters: (a) the oxidation temperature, (b) the residence time, (c) the excess oxygen concentration, (d) the oxidation pressure, and (e) the amount and type of catalyst. For many hazardous organic constituents, analytical methods are not available or the constituent cannot be analyzed in the waste matrix. Therefore, it would normally be impossible to measure the effectiveness of the wet air oxidation treatment system. In these cases EPA tries to identify measurable parameters or constituents that would act as surrogates to verify treatment.

For organic constituents, each compound contains a measurable amount of total organic carbon (TOC). Removal of TOC in the wet air oxidation treatment system indicates removal of organic constituents. Hence, TOC analysis is likely to be an adequate surrogate analysis where the specific organic constituent cannot be measured.

However, TOC analysis may not be able to adequately detect treatment of specific organics in matrices that are heavily organic-laden (i.e., the TOC analysis may not be sensitive enough to detect changes at the milligrams per liter (mg/l) level in matrices where total organic concentrations are hundreds or thousands of mg/l). In these cases other surrogate parameters should be sought. For example, if a specific analyzable constituent is expected to be treated as well as the unanalyzable constituent, the analyzable constituent concentration should be monitored as a surrogate.

6.5.1 Oxidation Temperature

Temperature is the most important parameter affecting the system. The design temperature must be high enough to allow the oxidation reactions to proceed at acceptable rates. Raising the temperature increases the wet air oxidation rate by enhancing oxygen solubility and oxygen diffusivity. The process is normally operated in the temperature range of 175 to 325°C (347 to 617°F), depending on the hazardous constituent(s) to be treated. EPA monitors the oxidation temperature continuously, if possible, to ensure that the system is operating at the appropriate design condition and to diagnose operational problems.

6.5.2 Residence Time

The residence time impacts the extent of oxidation of waste contaminants. For a batch system, the residence time is controlled directly by adjusting the treatment time in the reaction tank. For a continuous system, the waste feed rate is controlled to make sure that the system is operated at the appropriate design residence time. Generally, the reaction rates are relatively fast for the first 30 minutes and become slow after 60 minutes. Typical residence times, therefore, are approximately 1 hour. EPA monitors the residence time to ensure that sufficient time is provided to effectively oxidize the waste.

6.5.3 Excess Oxygen Concentration

The system must be designed to supply adequate amounts of oxygen for the compounds to be oxidized. An estimate of the amount of oxygen needed can be made based on the COD content of the untreated waste; excess oxygen should be supplied to ensure complete oxidation. The source of oxygen is compressed air or a high-pressure pure oxygen stream. EPA monitors the excess oxygen concentration (the concentration of oxygen in the gas leaving the reactor) continuously, if possible, by sampling the vent gas from the gas-liquid separator to ensure that an effective amount of oxygen or air is being supplied to the waste.

6.5.4 Oxidation Pressure

The design pressure must be high enough to prevent excessive evaporation of water and volatile organics at the design temperature. This allows the oxidation reaction to occur in the aqueous phase, thereby improving treatment effectiveness. Typical oxidation pressures range from 900 to 3000 psig. EPA monitors the oxidation pressure continuously, if possible, to ensure that the system is operating at the appropriate design condition and to diagnose operational problems.

6.5.5 Amount and Type of Catalyst

Adding a catalyst that promotes oxygen transfer and thus enhances oxidation has the effect of lowering the necessary reactor temperature and/or improving the level of destruction of oxidizable compounds. For waste constituents that are more difficult to oxidize, the addition of a catalyst may be necessary to effectively destroy the constituent(s) of concern. Catalysts typically used for this purpose include copper bromide and copper nitrate. If a catalyst is required, EPA examines the amount and type added, as well as the method of addition of the catalyst to the waste, to ensure that effective oxidation is achieved.

6.6 References

- Detrich, M.J., Randall, T.L., and Canney, P.J. 1985. Wet air oxidation of hazardous organics in wastewater. Environmental Progress 4:171-197.
- Randall, T.L. 1981. Wet oxidation of toxic and hazardous compounds, Zimpro technical bulletin I-610. Presented at the 13th Mid-Atlantic Industrial Waste Conference, June 29-30, 1981, University of Delaware, Newark, Del.
- USEPA. 1990. U.S. Environmental Protection Agency, Office of Solid Waste. Best demonstrated available technology (BDAT) background document addendum for acrylonitrile wastes. Washington, D.C.: U.S. Environmental Protection Agency.

I. TREATMENT TECHNOLOGIES (CONTINUED)

**B. TECHNOLOGIES THAT REDUCE THE SOLUBILITY OR
LEACHABILITY OF METALS**

1. AMALGAMATION

1.1 Applicability

The term amalgamation refers to two types of processes that can be used as treatment for mercury wastes. Neither amalgamation process significantly reduces the leachability of mercury; both processes only convert it into a more easily processed form. In both processes, a solid alloy of mercury and a base metal, such as zinc, is formed. This alloy can be subsequently processed by retorting to recover mercury.

The two processes differ from each other in the types of wastes managed. The first process is applicable only to solutions containing dissolved mercury salts. The principal current use for the process is in treatment of wastewaters containing organomercury salts. The second process is usable only for wastes rich in elemental mercury. Since the use of this second process is merely a convenience to avoid handling mercury in liquid form, its use is negligible. Both processes are applicable only to wastes containing mercury where selective recovery of the mercury is deemed viable.

1.2 Underlying Principles of Operation

The amalgamation processes depend on the ability of mercury to form low-melting-point solid alloys with metals such as copper and zinc, which have the thermodynamic capability of simultaneously reducing mercuric and mercurous salts to elemental mercury. Basically, an excess of the less noble metal (zinc or copper) is contacted with a waste containing mercury or mercury salts. The chemical reaction reducing the mercury in the mercury salts occurs and the elemental mercury liberated forms an alloy with the excess metal added. For zinc and mercuric nitrate, the reaction may be written:

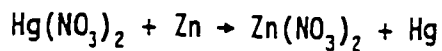

1.3 Description of Amalgamation Treatment Processes

The two types of amalgamation processes are operated as follows:

1. The aqueous replacement process (solution process) involves addition of excess base metal, such as zinc, to a wastewater solution containing dissolved mercury salts. The elemental zinc, or other base metal, reacts with the mercuric or mercurous salts to form elemental mercury, which subsequently alloys with the excess base metal to form a solid amalgam (or alloy) that can be recovered by filtration and then sent for mercury recovery if applicable. Generally, finely divided zinc (zinc dust) is used. The high surface area of this material allows for rapid reaction and alloy formation.
2. The nonaqueous process, which is seldom used, involves contacting waste liquid mercury with finely divided zinc powders. The mass rapidly solidifies into a solid amalgam, which may be more easily managed than liquid mercury. This type of process is typically limited in utility only to waste scrap elemental mercury.

1.4 Waste Characterization Affecting Performance (WCAPs)

In determining whether amalgamation will achieve the same level of performance on an untested waste that it achieved on a previously tested waste and whether performance levels can be transferred, EPA examines the following waste characteristics: (a) the chemical form of the mercury, (b) the solution pH, (c) the presence of solids, and (d) the presence of other interfering materials.

1.4.1 Chemical Form of the Mercury

The solution process requires that the mercury be present in the form of a dissolved mercury salt. As a result, the process is not applicable to wastes containing insoluble mercury compounds. The nonaqueous process is applicable only to waste scrap mercury in elemental form.

1.4.2 Solution pH

The solution process involves reactions of finely divided zinc with mercury salts in solution. Reactions such as those consuming zinc by reaction with the acidic content of wastewaters are undesirable. Therefore, the pH of the wastewater solution should be adjusted to near neutral value before the process is used. This characteristic does not apply to the second process, where scrap liquid mercury is a required feedstock.

1.4.3 Presence of Solids

The solution process is aimed at recovery of a solid amalgam that can be shipped to mercury reprocessors. The presence of other solids in the amalgam may be undesirable. Therefore, if mercury is to be recovered, wastewater solutions should be filtered to remove extraneous solids before the process is used. This characteristic does not apply to the second process.

1.4.4 Presence of Interfering Materials

The solution process requires a clear solution as a feedstock. Solutions containing oils, greases, and emulsified or suspended materials need to be pretreated before use of the process. The presence of many other dissolved salts, such as those of copper, which can react with zinc, is also undesirable, but does not exclude use of the process. The presence of such salts will increase the amounts of zinc required for process operation.

The nonaqueous process requires elemental mercury as a feedstock. Scrap mercury contaminated with oils, greases, and emulsion is better managed by retorting directly since these interfering substances may inhibit amalgam formation.

1.5 Design and Operating Parameters

1.5.1 Solution Process Design and Operating Parameters

In assessing the effectiveness of the design and operation of a solution process, EPA examines the following parameters: (a) temperature, (b) degree of mixing, (c) zinc usage, (d) solution pretreatment, and (e) residual mercury in the treated wastewater.

1.5.1.1 Temperature

The solution process is normally operated at ~~ambient~~ temperature but can be run at temperatures up to about 60°C to enhance the reaction rate between zinc and dissolved mercury salts. EPA will examine the basis for the choice of operating temperature and temperature monitoring equipment to ensure proper process operation.

1.5.1.2 Degree of Mixing

Finely divided zinc powder is normally added to the solution containing the mercury compound. To ensure adequate contact between the zinc particles and mercury ions present in solution, good agitation is needed. EPA will examine the equipment used to determine that the treatment vessel contains the proper stirring equipment.

1.5.1.3 Zinc Usage

Sufficient zinc must be added to the solutions to ensure that all of the mercury present is converted to an amalgam. To achieve this end, the concentration of mercury in the solution to be processed must be known to estimate the minimum amount of zinc to be added. EPA will examine a facility's calculations for zinc addition for individual batches to ensure proper operation.

1.5.1.4 Solution Pretreatment

In a properly operated unit, the mercury-containing solutions processed should be clear and free of oil, grease, and suspended solids when introduced to the processing equipment. EPA will inspect the solutions entering the process to ensure that proper pretreatment is being used.

1.5.1.5 Residual Mercury Levels in Treated Liquid Phase

One final design and operating parameter of importance is the concentration of mercury in the treated water after amalgam removal. For a properly designed and operated unit, both the entering and final mercury concentrations should be determined on a batch-by-batch basis. EPA will examine these records to ensure proper operation. EPA will also determine proper operation by examination of capabilities for posttreatment to precipitate any residual mercury from the treated wastewaters prior to their discharge. Amalgamation processes are normally used as part of treatment trains devoted to recovering elemental mercury. The reaction of zinc with mercury salts in solution occurs rapidly at higher mercury salt concentrations but may become very slow as the concentration falls to low levels. As a result, treated solutions are likely to contain some residual mercury salts requiring separate treatment.

1.5.2 Nonaqueous Process Design and Operating Parameters

The nonaqueous (solid) process is very rarely used on a significant scale. Generally, waste mercury is either retorted or redistilled as such without formation of amalgams. There are, however, a few instances in which it might be desirable to amalgamate elemental mercury, the most important of which is when the mercury is contaminated by radioisotopes. The solid process involving amalgamation with zinc is basically simple, and there are two design and operating parameters of concern: (a) the amount of zinc used and (b) the adequacy of the mixing.

1.5.2.1 Amount of Zinc Used

The properties of the final amalgam prepared will depend on the ratio of zinc powder to mercury used. Mercury and zinc form amalgams over a very wide composition range. However, it is necessary to add sufficient zinc so that an alloy that is solid at room temperature is obtained. This entails using sufficient zinc to ensure that an amalgam with at least 25 percent zinc content is obtained.

1.5.2.2 Adequacy of Mixing

To form uniform zinc-mercury amalgams, the constituents need to be uniformly mixed. Historically, such amalgams have been prepared in small quantities. If a facility desires to process mercury by this route in higher volumes, a specially designed mixing system may be needed. EPA will examine the design and operation of the mixing system to determine whether adequate mixing is likely to be achieved.

1.6 References

- Mellor, J.W., 1948. Comprehensive treatise on theoretical and inorganic chemistry. Vol. 4, pp. 1022-1049. London, U.K.: Longmans Green.
- Signer, W., and Nowak M., 1978. Mercury compounds. In Kirk-Othmer encyclopedia of chemical technology. Vol. 15, pp. 157-171. New York: John Wiley Interscience.
- Rissmann, E.F., and Schwartz, S., 1989. Treatment of wastes containing arsenic, selenium, thallium, and mercury compounds. In Proceedings of the 44th Industrial Waste Conference, Purdue University. pp. 643-648. Ann Arbor, Mich.: Lewis Publishers.

2. CHEMICAL PRECIPITATION

2.1 Applicability

Chemical precipitation is a treatment technology applicable to wastewaters containing a wide range of dissolved and other metals, as well as other inorganic substances such as fluorides. This technology removes these metals and inorganics from solution in the form of insoluble solid precipitates. The solids formed are then separated from the wastewater by settling, clarification, and/or polishing filtration.

For some wastewaters, such as chromium plating baths or plating baths containing cyanides, the metals exist in solution in a very soluble form. This solubility can be caused by the metal's oxidation state (for example, hexavalent chromium wastewaters) or by complexing of the metals (for example, high cyanide-containing wastewaters). In both cases, pretreatment, such as hexavalent chromium reduction or oxidation of the metal-cyanide complexes, may be required before the chemical precipitation process can be applied effectively. In the case of arsenic, the arsenic-containing solution is normally treated first with oxidizing agents such as alkali hypochlorite solution to convert the lower-valence arsenic compound to arsenate. The arsenic ion is then typically precipitated out as ferric arsenate. Some compounds must be reduced prior to precipitation. For instance, selenites and selenates are oxidants and are readily reduced to elemental selenium, which is insoluble in aqueous solutions. Sulfur dioxide, sulfides, sulfites, and ferrous ion are all effective for this reduction reaction.

Chemical precipitation may also be applicable to mixed waste for separating radionuclides from other hazardous constituents in wastewaters. Specific conditions of pH, temperature, and precipitating reagent addition are required to selectively remove part or all of the radioactive component as a precipitate.

2.2 Underlying Principles of Operation

The basic principle of operation of chemical precipitation is that metals and inorganics in wastewater are removed by the addition of a precipitating agent that converts the soluble metals and inorganics to insoluble precipitates. These precipitates are settled, clarified, and/or filtered out of solution, leaving a lower concentration of metals and inorganics in the wastewater. The principal precipitation agents used to convert soluble metal and inorganic compounds to less soluble forms include lime ($\text{Ca}(\text{OH})_2$), caustic (NaOH), sodium sulfide (Na_2S), and, to a lesser extent, soda ash (Na_2CO_3), phosphate (PO_4^{3-}), and ferrous sulfide (FeS).

The solubility of a particular compound depends on the extent to which the electrostatic forces holding the ions of the compound together can be overcome. The solubility changes significantly with temperature, with most metal compounds becoming more soluble as the temperature increases. Additionally, the solubility is affected by other constituents present in the wastewater, including other ions and complexing agents. Regarding specific ionic forms, nitrates, chlorides, and sulfates are, in general, more soluble than hydroxides, sulfides, carbonates, and phosphates.

Once the soluble metal and inorganic compounds have been converted to precipitates, the effectiveness of chemical precipitation is determined by how successfully the precipitates are physically removed. Removal usually relies on a settling process; that is, a particle of a specific size, shape, and composition will settle at a specific velocity, as described by Stokes' Law. For a batch system, Stokes' Law is a good predictor of settling time because the pertinent particle parameters essentially remain constant. In practice, however, settling time for a batch system is normally determined by empirical testing. For a continuous system, the theory of settling is complicated by such factors as turbulence, short-circuiting of the wastewater, and velocity gradients, thus increasing the importance of empirical tests to accurately determine appropriate settling times.

2.3 Description of Chemical Precipitation Process

The equipment and instrumentation required for chemical precipitation vary depending on whether the system is batch or continuous. Both systems are discussed below.

For a batch system, chemical precipitation requires a feed system for the treatment chemicals and a reaction tank where the waste can be treated and allowed to settle. When lime is used, it is usually added to the reaction tank in a slurry form. The supernatant liquid is generally analyzed before discharge to ensure that settling of precipitates is adequate.

For a continuous system, additional tanks are necessary, as well as the instrumentation to ensure that the system is operating properly. A schematic of a continuous chemical precipitation system is shown in Figure 10. In this system, wastewater is fed into an equalization tank, where it is mixed to provide more uniformity, thus minimizing the variability in the type and concentration of constituents sent to the reaction tank.

Following equalization, the wastewater is pumped to a reaction tank where precipitating agents are added. This is done automatically by using instrumentation that senses the pH of the system for hydroxide precipitating agents, or the oxidation-reduction potential (ORP) for nonhydroxide precipitating agents, and then pneumatically adjusts the position of the treatment chemical feed valve until the design pH or ORP value is achieved. (The pH and ORP values are affected by the concentration of hydroxide and nonhydroxide precipitating agents, respectively, and are thus used as indicators of their concentrations in the reaction tank.)

In the reaction tank, the wastewater and precipitating agents are mixed to ensure commingling of the metal and inorganic constituents to be removed and the precipitating agents. In addition, effective dispersion of the precipitating

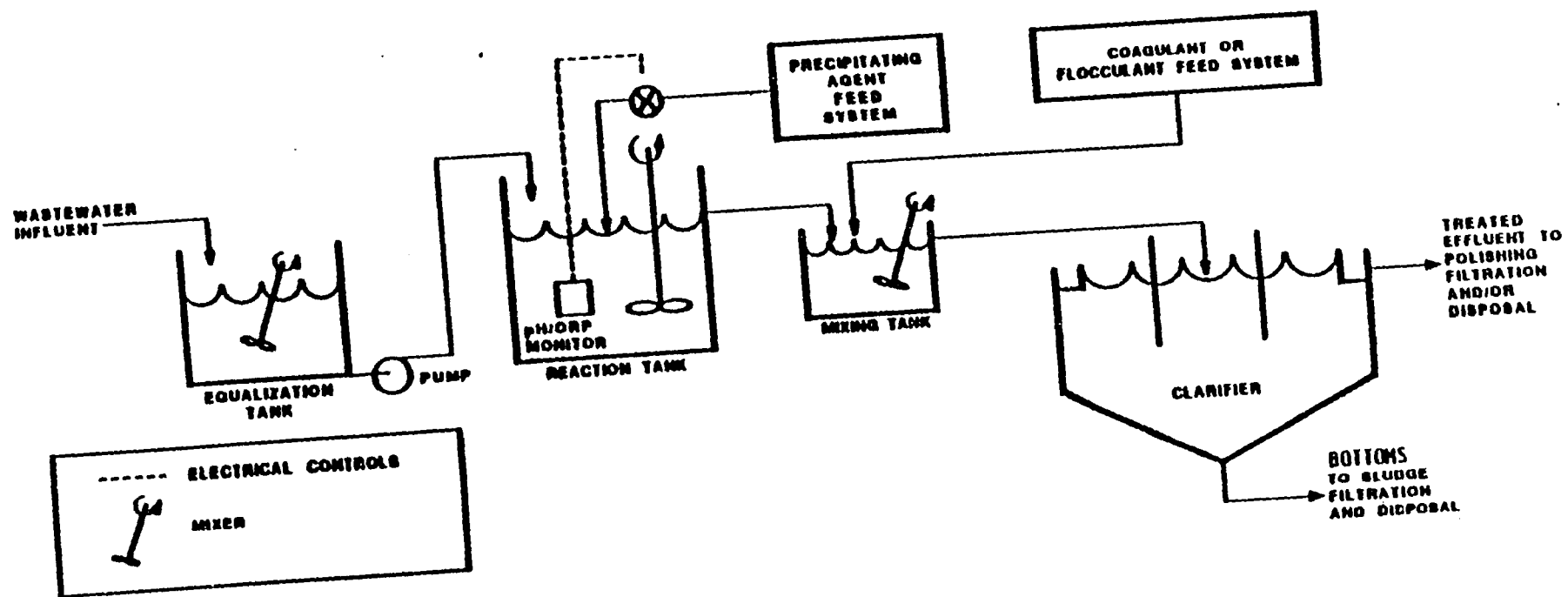

Figure 10 Continuous Chemical Precipitation System

agents throughout the tank is necessary to properly monitor and thereby control the amount added.

Following reaction of the wastewater with the stabilizing agents, coagulating or flocculating compounds are added to chemically assist the settling process. Coagulants and flocculants increase the particle size and density of the precipitated solids, both of which increase the rate of settling. The coagulant or flocculating agent that best improves settling characteristics varies depending on the particular precipitates to be settled.

Settling can be conducted in a large tank by relying solely on gravity or can be mechanically assisted through the use of a circular clarifier or an inclined plate settler. Schematics of the two settling systems are shown in Figures 11 and 12. Following the addition of coagulating or flocculating agents, the wastewater is fed to a large settling tank, circular clarifier, or inclined plate settler, where the precipitated solids are removed. These solids are generally further treated in a sludge filtration system to dewater them prior to disposal. Sludge filtration is discussed in Section II.B.2 of this document.

The supernatant liquid effluent can be further treated in a polishing filtration system to remove precipitated residuals both in cases where the settling system is underdesigned and in cases where the particles are difficult to settle. Polishing filtration is discussed in Section II.B.2 of this document.

2.4 Waste Characteristics Affecting Performance (WCAPs)

In determining whether chemical precipitation will achieve the same level of performance on an untested waste that it achieved on a previously tested waste and whether performance levels can be transferred, EPA examines the following waste characteristics: (a) the concentration and type of metals, (b) the concentration of total dissolved solids (TDS), (c) the concentration of complexing agents, and (d) the concentration of oil and grease.

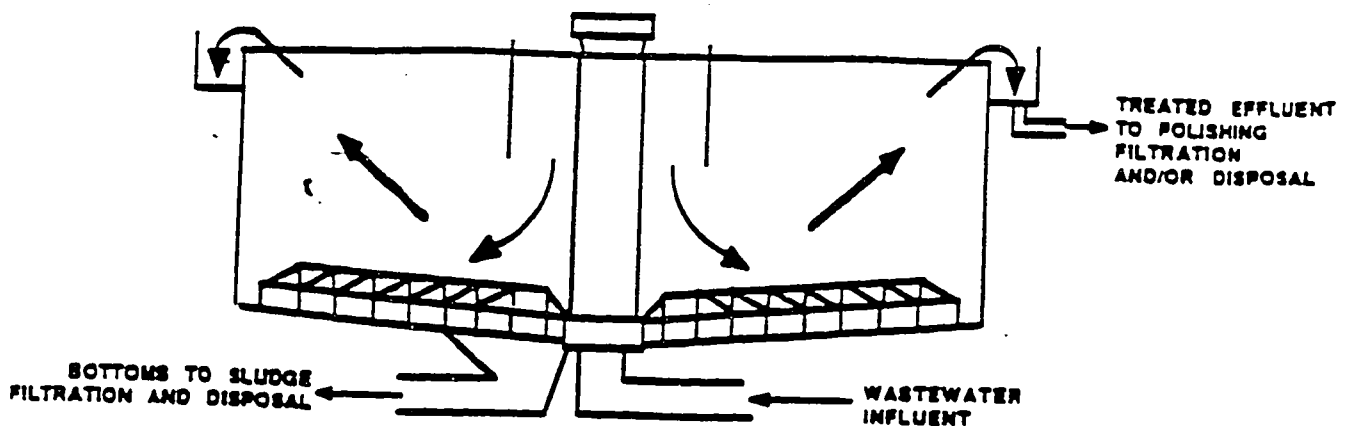

CENTER FEED CLARIFIER WITH SCRAPER SLUDGE REMOVAL SYSTEM

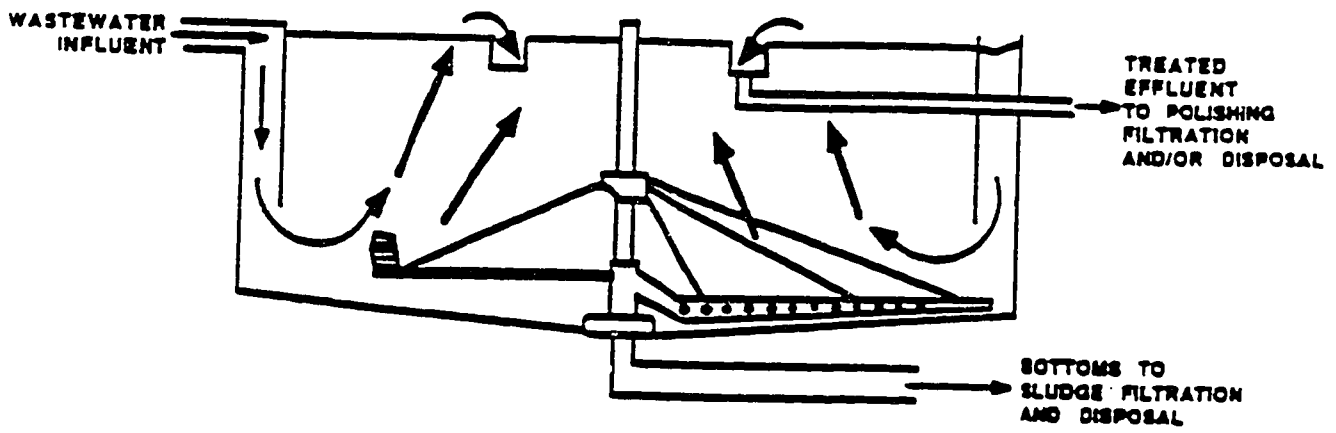

RIM FEED - CENTER TAKEOFF CLARIFIER WITH HYDRAULIC SUCTION SLUDGE REMOVAL SYSTEM

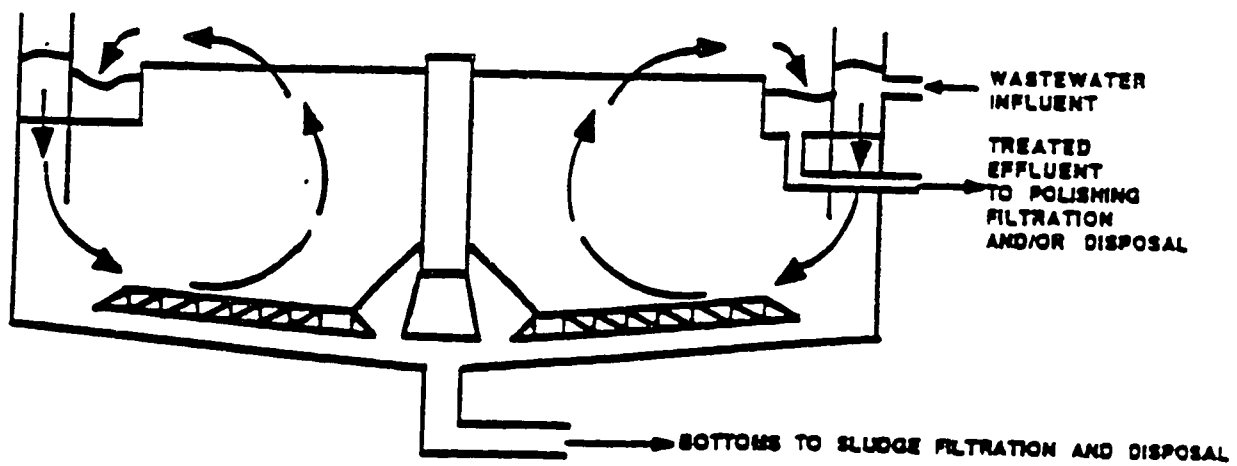

RIM FEED - RIM TAKEOFF CLARIFIER

Figure 11 Circular Clarifier Systems

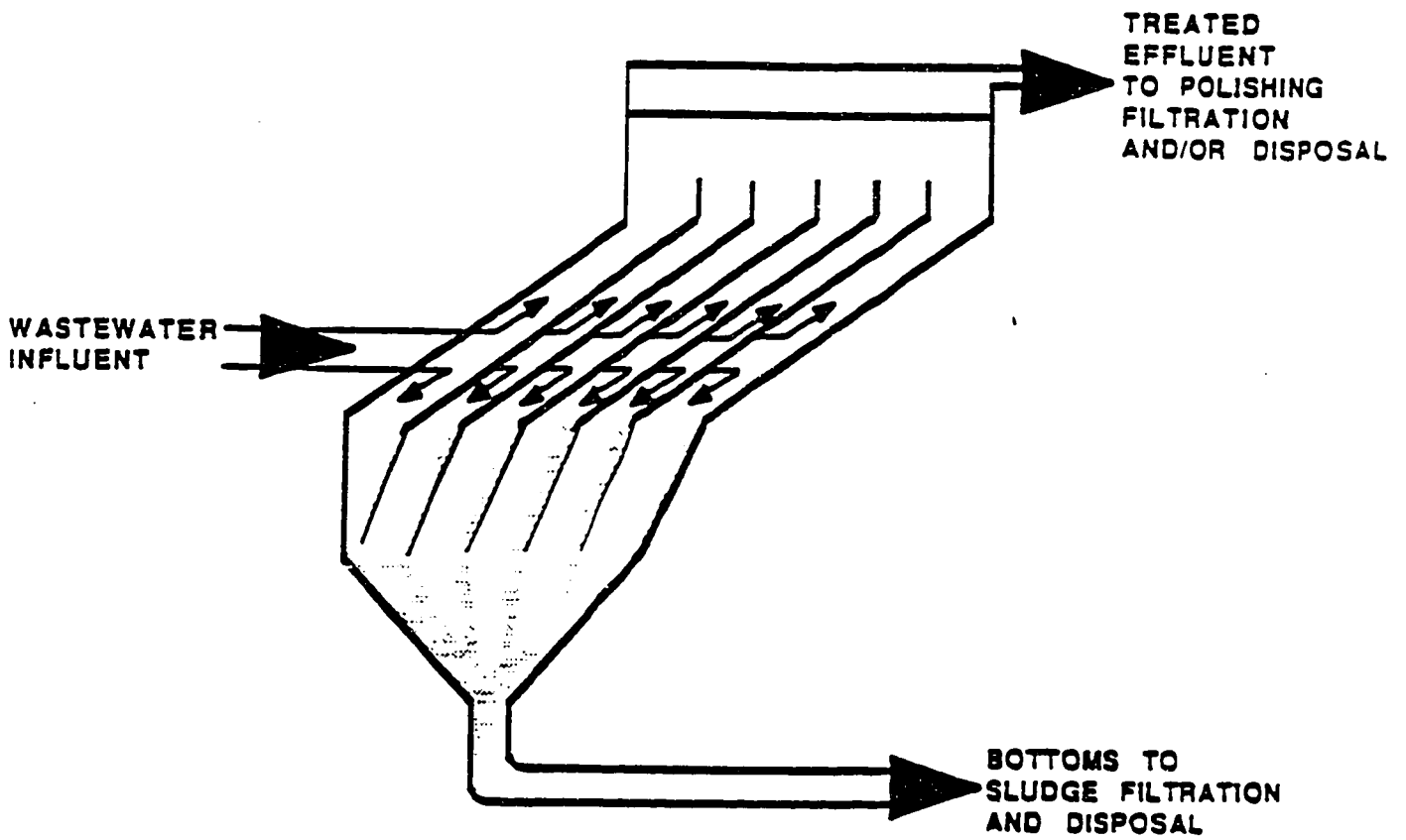

Figure 12 Inclined Plate Settler System

2.4.1 Concentration and Type of Metals

For most metals, there is a specific pH at which the metal precipitate is least soluble. As a result, when a waste contains a mixture of many metals, it is not possible to operate a treatment system at a single pH or ORP value that is optimal for the removal of all metals. The extent to which this affects treatment depends on the particular metals to be removed and their respective concentrations. One alternative is to operate multiple precipitations, with intermediate settling, when the optimum pH occurs at markedly different levels for the metals present. If the concentration and type of metals in an untested waste differ from and are significantly higher than those in the tested waste, the system may not achieve the same performance. Additional precipitating agents, alternate pH/ORP values, and/or multiple precipitations may be required to achieve the same treatment performance, or other, more applicable treatment technologies may need to be considered for treatment of the untested waste.

2.4.2 Concentration of Total Dissolved Solids

High concentrations of total dissolved solids (TDS) can interfere with precipitation reactions, as well as inhibit settling. Poor precipitate formation and flocculation are results of high TDS concentrations, and higher concentrations of solids are found in the treated wastewater residuals. If the TDS concentration in an untested waste is significantly higher than that in the tested waste, the system may not achieve the same performance. Higher concentrations of precipitating agents may be required to achieve the same treatment performance, or other, more applicable treatment technologies may need to be considered for treatment of the untested waste.

2.4.3 Concentration of Complexing Agents

A metal complex consists of a metal ion surrounded by a group of other inorganic or organic ions or molecules (often called ligands). In the complexed form, metals have a greater solubility. Also, complexed metals inhibit the

reaction of the metal with the precipitating agents and therefore may not be removed as effectively from solution by chemical precipitation. However, EPA does not have analytical methods to determine the concentration of complexed metals in wastewaters. The Agency believes that the best indicator for complexed metals is to analyze for complexing agents, such as cyanide, chlorides, EDTA, ammonia, amines, and methanol, for which analytical methods are available. Therefore, EPA uses the concentration of complexing agents as a surrogate waste characteristic for the concentration of metal complexes. If the concentration of complexing agents in an untested waste is significantly higher than that in the tested waste, the system may not achieve the same performance. Higher concentrations of precipitating agents may be required to achieve the same treatment performance, or other, more applicable treatment technologies may need to be considered for treatment of the untested waste.

2.4.4 Concentration of Oil and Grease

The concentration of oil and grease in a waste inhibits the settling of the precipitate by creating emulsions that require a long settling time. Suspended oil droplets in water tend to suspend particles such as chemical precipitates that would otherwise settle out of solution. Even with the use of coagulants or flocculants, the settling of the precipitate is less effective. If the concentration of oil and grease in an untested waste is significantly higher than that in the tested waste, the system may not achieve the same performance. Pretreatment of the waste may be required to reduce the oil and grease concentration and achieve the same treatment performance, or other, more applicable treatment technologies may need to be considered for treatment of the untested waste.

2.5 Design and Operating Parameters

In assessing the effectiveness of the design and operation of a chemical precipitation system, EPA examines the following parameters: (a) the pH/ORP value; (b) the precipitation temperature; (c) the residence time; (d) the amount

and type of precipitating agents, coagulants, and flocculants; (e) the degree of mixing; and (f) the settling time.

2.5.1 pH/ORP Value

The pH/ORP value in continuous chemical precipitation systems is used as an indicator of the concentration of precipitating agents in the reaction tank and thus is used to regulate their addition to the tank. The pH/ORP value also affects the solubility of metal precipitates formed and therefore directly impacts the effectiveness of their removal. EPA monitors the pH/ORP value continuously, if possible, to ensure that the system is operating at the appropriate design condition and to diagnose operational problems.

2.5.2 Precipitation Temperature

The precipitation temperature affects the solubility of the metal precipitates. Generally, the lower the temperature, the lower the solubility of the metal precipitates and vice versa. EPA monitors the precipitation temperature continuously, if possible, to ensure that the system is operating at the appropriate design condition and to diagnose operational problems.

2.5.3 Residence Time

The residence time impacts the extent of the chemical reactions to form metal precipitates and, as a result, the amount of precipitates that can be settled out of solution. For batch systems, the residence time is controlled directly by adjusting the treatment time in the reaction tank. For continuous systems, the wastewater feed rate is controlled to make sure that the system is operating at the appropriate design residence time. EPA monitors the residence time to ensure that sufficient time is provided to effectively precipitate metals and inorganics from the wastewater.

2.5.4 Amount and Type of Precipitating Agents, Coagulants, and Flocculants

The amount and type of precipitating agent used to effectively treat the wastewater depends on the amount and type of metal and inorganic constituents in the wastewater to be treated. Other design and operating parameters, such as the pH/ORP value, the precipitation temperature, the residence time, the amount and type of coagulants and flocculants, and the settling time, are determined by the selection of precipitating agents. The addition of coagulants and flocculants improves the settling rate of the precipitated metals and inorganics and allows for smaller settling systems (i.e., lower settling time) to achieve the same degree of settling as a much larger system. Typically, anionic polyelectrolyte flocculating agents are most effective with metal precipitates, although cationic or nonionic polyelectrolytes also are effective. Typical doses range from 0.1 to 10 mg/l of the total influent wastewater stream. Conventional coagulants, such as alum (aluminum sulfate), are also effective, but must be dosed at much higher concentrations to achieve the same result. Therefore, these coagulants add more to the settled sludge volume requiring disposal than do the polyelectrolyte flocculants. EPA examines the amount and type of precipitating agents, coagulants, and flocculants added, and their method of addition to the wastewater, to ensure effective precipitation.

2.5.5 Degree of Mixing

Mixing provides greater uniformity of the wastewater feed and disperses precipitating agents, coagulants, and flocculants throughout the wastewater to ensure the most rapid precipitation reactions and settling of precipitate solids possible. The quantifiable degree of mixing is a complex assessment that includes, among other things, the amount of energy supplied, the length of time the material is mixed, and the related turbulence effects of the specific size and shape of the tank. This is beyond the scope of simple measurement. EPA, however, evaluates the degree of mixing qualitatively by considering whether mixing is provided and whether the type of mixing device is one that could be expected to achieve uniform mixing of the wastewater.

2.5.6 Settling Time

Adequate settling time must be provided to make sure that removal of the precipitated solids from the wastewater has been completed. EPA monitors the settling time to ensure effective solids removal.

2.6 References

Cherry, K.F. 1982. Plating waste treatment. pp. 45-62. Ann Arbor, Mich.: Ann Arbor Science Publishers, Inc.

Cushnie, G.C., Jr. 1985. Electroplating wastewater pollution control technology. pp. 48-62, 84-90. Park Ridge, N.J.: Noyes Publications.

Cushnie, G.C., Jr. 1984. Removal of metals from wastewater: neutralization and precipitation. pp. 55-92. Park Ridge, N.J.: Noyes Publications.

Gurnham, C.F. 1955. Principles of industrial waste treatment. pp. 224-234. New York: John Wiley and Sons.

Kirk-Othmer. 1980. Flocculation. In Encyclopedia of chemical technology, 3rd ed., vol. 10, pp. 489-516. New York: John Wiley and Sons.

USEPA. 1983. U.S. Environmental Protection Agency. Treatability manual: Vol. III, Technology for control/removal of pollutants, p. III.3.1.3.2. EPA-600/2-82-001C. Washington, D.C.: U.S. Environmental Protection Agency.

3. ENCAPSULATION

3.1 Applicability

Encapsulation processes refer to a family of processes wherein high-solids nonwastewaters are mixed with an organic polymeric substance or with asphalt. The mixture is then allowed to cure into a solid mass prior to disposal. These processes are applicable to a wide variety of wastes. They are not applicable to wastes containing materials that decompose at high temperatures or to wastes containing oxidizers that can react with the binder materials. Also, some aromatic solvents such as xylene and toluene can diffuse through the encapsulating agent. Oils, greases, and some chelating agents may interfere with the hardening and solidification of the encapsulating material. EPA believes that encapsulation technologies are applicable primarily to wastes containing hazardous metal constituents. Encapsulation may immobilize hazardous organics as well as metals; however, incineration is more applicable to organics since incineration destroys organics completely, whereas encapsulation can only immobilize them.

3.2 Underlying Principles of Operation

There are a number of very similar encapsulation processes that differ from each other only in the encapsulating agent used. In all of the processes, the waste is first dried to remove moisture. The waste is then usually reheated and mixed with hot asphalt or thermoplastic material such as polyethylene. The mixture is then cooled to solidify the mass. The ratio of matrix (fixative or encapsulating agent) to waste is generally high (i.e., 1:1 or 1:2 fixative to waste on a dry basis). The matrix, once solidified, coats the waste to minimize leaching.

3.3 Description of Encapsulation Processes

Encapsulation processes can take the form of macroencapsulation, microencapsulation, or both. Microencapsulation is the containment of individual

waste particles in the polymer or asphalt matrix. Macroencapsulation is the encasement of a mass of waste in a thick polymer coating. The waste mass may have been microencapsulated prior to macroencapsulation.

3.3.1 Microencapsulation

Microencapsulation processes typically involve the following unit operations in series:

- Predrying of the waste to remove entrained moisture.
- Mixing of the heated waste with molten encapsulating agent (asphalt, polyethylene, thermosetting resins).
- Cooling of the hot mixture to allow the mixed mass to harden into a solid mass.

Generally, ratios of matrix to waste used are high compared to those of pozzolanic stabilization processes (i.e., for encapsulation the ratio is in the 1:1 to 1:2 range). Mixing is generally done at 120 to 130°C depending on the melting characteristics of the matrix and the type of equipment used for mixing. A few processes differ from the above description in that polymerization of monomers mixed with waste is conducted at ambient or near ambient temperatures in the presence of catalysts. The monomer (or monomeric mixture) then polymerizes at room temperature, coating the individual waste particles.

3.3.2 Macroencapsulation

The macroencapsulation process of hazardous waste solids usually involves two steps. In the first step, the hazardous wastes may be chemically treated by using low-cost dehydrating agents such as lime, kiln dust, or Portland cement. This operation does not increase the volume of the solids significantly because

only a small amount of dehydrating agent is needed to dewater the solids. The resulting mixtures are friable, and they can easily be ground.

In the second step, the dehydrated sludges are ground and the particles may be microencapsulated, typically by a polybutadiene binder. Then the mass is macroencapsulated, or coated, typically by high-density polyethylene.

The typical apparatus for macroencapsulation processes features heated or cooled molds, a method of waste and hardened product manipulation, and hydraulics for mold actuation. The molds typically contain electrical band heaters and water cooling channels. After the polymer coating hardens, the mold is split to facilitate product demolding.

3.4 Waste Characteristics Affecting Performance (WCAPs)

In determining whether encapsulation will achieve the same level of performance on an untested waste that it achieved on a previously tested waste and whether performance levels can be transferred, EPA examines the following waste characteristics: (a) the water content of the waste; (b) the presence of oxidizing agents in the waste; (c) the presence of certain organic solvents; (d) the presence of oils, greases, and chelating agents; and (e) the presence of thermally unstable materials in the waste. These characteristics are described below.

3.4.1 Water Content

The processes normally require a dry solid waste. Wet solids need to be dried at elevated temperature, or chemically treated, to remove entrained moisture before they can be mixed with molten polymers, asphalt, or monomeric mixtures. The presence of free water interferes with the elevated temperature encapsulation processes by forming steam during the mixing and preventing a smooth coating of the particles. In ambient temperature processes, water may

react with the polymerization catalyst, preventing it from initiating the polymerization reactions.

3.4.2 Presence of Oxidizing Agents

Strong oxidization salts such as nitrites, chlorates, or perchlorates will react with the organic matrix materials and slowly deteriorate the matrix. These oxidants may also react spontaneously with the heated matrix material to cause a fire or explosion. Wastes containing such strong oxidants should not be managed by polymer encapsulation processes.

3.4.3 Presence of Organic Solvents

Organic solvents, particularly aromatic solvents, may be capable of dissolving the polymer matrix material. They will also cause significant air emissions due to volatilization during the mixing of the heated waste and matrix materials. The process should not be used on wastes containing such solvents unless the wastes have been pretreated to remove such materials.

3.4.4 Presence of Oils, Greases, and Chelating Agents

Oils, greases, and organic chelating agents are likely to dissolve in and migrate through the polymeric matrices used for encapsulation. They may also, to some extent, coat individual waste particles and prevent firm microencapsulation binding between waste particles and the polymer matrix surrounding them. Because of the ability of these organics to diffuse through polymeric matrices, wastes containing oils, greases, and organic chelating agents should not be managed by polymer encapsulation.

3.4.5 Presence of Thermally Unstable Materials

Hydrated salts are likely to decompose during the initial hot mixing of matrix and waste materials, liberating water vapor. These salts will also

rehydrate during cooling and thus interfere with the uniform coating of waste particles by the matrix polymer. Wastes containing hydrated salts should not be managed by this process. Salts that are known to cause such problems include hydrated sodium sulfate, magnesium sulfate, and hydrated metal chlorides. The soluble hydrates need to be removed from the waste by chemical or physical means before the wastes are managed by polymer microencapsulation.

3.5 Design and Operating Parameters

There are five design and operating parameters for this set of processes: (a) the choice of the polymeric matrix material, (b) the mixing equipment used, (c) the ratio of polymer to waste used, (d) process temperature control, and (e) air emissions control. These are described in the following paragraphs.

3.5.1 Choice of Polymeric Matrix

Several polymeric matrices are available for use in these encapsulation processes. These include asphalt, polyethylene, thermosetting plastics (such as urea formaldehyde type resins), and resins that can be polymerized under ambient temperature in the presence of a catalyst. The choice of the polymeric matrix determines the temperature and equipment to be used and strongly influences the needed cure time. It also determines to some degree the choice of wastes that can be accepted because of differences in the properties of the polymers. EPA will examine the basis for the choice of polymer matrix, available test data, and the wastes being accepted for processing.

3.5.2 Mixing Equipment Used

For microencapsulation, polymers or monomers and catalysts must be well mixed with wastes to ensure that uniformly coated waste particles are produced. EPA will examine the design and operating characteristics of the mixing system to ensure that it is capable of generating uniform mixes.

3.5.3 Ratio of Polymer to Waste Used

Sufficient polymer must be used to ensure that the waste is uniformly coated. Generally, a 1:1 or 1:2 polymer-to-waste ratio on a weight basis is used. EPA will examine the basis for the choice of polymer-to-waste ratio used to ensure that sufficient polymer is being added.

3.5.4 Process Temperature Control

To achieve uniform mixing, the encapsulation matrix must be in a liquid state. The melting points of the different thermoplastic polymers will differ from each other. During mixing of the molten polymer and waste, the temperature needs to be maintained above the thermoplastic polymer melting point and below the point at which polymer vaporization or thermal decomposition begins. Thus, for a given thermoplastic polymer, there is only a certain temperature range in which the process can be satisfactorily operated. For thermosetting resins the temperature selected must be appropriate to cause polymerization (hardening) after thorough mixing. EPA will examine data on the properties of the polymers, including decomposition, to ensure that a proper operating temperature was selected. EPA will also examine the temperature control instrumentation in use to ensure that it is operating properly.

3.5.5 Air Emissions Control

Heating of mixtures of waste with polymers or asphalt can cause the release of hydrocarbon air emissions that may include volatile components of the waste, plasticizers present in the polymers, polymer decomposition products, and low-molecular-weight ingredients of the asphalt. In a properly operating system, air emissions testing may be needed during at least initial operation to determine levels of emissions and to assess the need for air emissions control. EPA will examine such air monitoring data to determine whether air emissions control systems are appropriate. The Agency will also examine the air emissions control

systems in use to ensure that they are operating and in proper operating condition.

3.6 References

Pierce, J., and Vesilind, P.A. 1981. Hazardous waste management. pp. 82-4. Ann Arbor, Mich.: Ann Arbor Science Publishers.

Rich, G., and Cherry, K. 1987. Hazardous waste treatment technologies. Chapter 6, pp. 9-3. Northbrook, Ill.: Purdue Publishing Company.

4. STABILIZATION OF METALS

4.1 Applicability

Stabilization is a treatment technology applicable to wastes containing leachable metals and having a high filterable solids content, low total organic carbon (TOC) content, and low oil and grease content. This technology is commonly used to treat residuals generated from treatment of wastes such as electroplating wastewaters, incineration ash residues, and characteristic D-metal wastes such as cadmium (D006), chromium (D007), lead (D008), and mercury (D009). For wastes with recoverable levels of metals, high temperature metals recovery and retorting technologies may be applicable.

Stabilization refers to a broad class of treatment processes that immobilize hazardous constituents in a waste. Related technologies are encapsulation and thermoplastic binding. However, EPA considers stabilization technologies to be distinct from the other technologies in that their operational principles are significantly different. Stabilization typically requires a chemical reaction between the waste and the stabilizing agent for effective treatment, while thermoplastic binding and encapsulation usually employ physical containment of hazardous particulates by the encapsulating agent.

4.2 Underlying Principles of Operation

The basic principle of operation for stabilization is that leachable metals in a waste are immobilized following the addition of stabilizing agents and other chemicals. The leachability is reduced by the formation of a lattice structure and/or chemical bonds that chemically bind the metals to the solid matrix and thereby limit the amount of metal constituents that can be leached when water or a mild acid solution comes into contact with the waste material. Stabilization is most effective when the waste metal is in its least soluble state, thereby decreasing the potential for leaching. For example, hexavalent chromium is much more soluble and more difficult to stabilize than trivalent chromium.

The two principal stabilization processes used are cement-based and lime/pozzolan-based processes. A brief discussion of each is provided below. In both cement-based and lime/pozzolan-based techniques, the stabilizing process can be modified through the use of additives, such as silicates, that control curing rates, reduce permeability, and enhance the properties of the solid material.

4.2.1 Portland Cement-Based Process

Portland cement is a mixture of powdered oxides of calcium, silica, aluminum, and iron, produced by kiln burning of materials rich in calcium and silica at high temperatures (i.e., 1,400 to 1,500°C (2,552 to 2,732°F)). When the anhydrous cement powder is mixed with water, hydration occurs and the cement begins to set. The chemistry involved is complex because many different reactions occur depending on the composition of the cement mixture.

As the cement begins to set, a colloidal gel of indefinite composition and structure is formed. Over time, the gel swells and forms a matrix composed of interlacing, thin, densely packed silicate fibrils. Constituents present in the waste slurry (e.g., hydroxides and carbonates of various metals) are incorporated into the interstices of the cement matrix. The high pH of the cement mixture tends to keep metals in the form of insoluble hydroxide and carbonate salts. It has been hypothesized that metal ions may also be incorporated into the crystal structure of the cement matrix, but this hypothesis has not been verified.

4.2.2 Lime/Pozzolan-Based Process

Pozzolan, which contains finely divided, noncrystalline silica (e.g., fly ash or components of cement kiln dust), is a material that is not cementitious in itself, but becomes so upon the addition of lime. Metals in the waste are converted to insoluble silicates or hydroxides and are incorporated into the interstices of the binder matrix, thereby inhibiting leaching.

4.3 Description of Stabilization Process

The stabilization process consists of a weighing device, a mixing unit, and a curing vessel or pad. Commercial concrete mixing and handling equipment is typically used in stabilization processes. Weighing conveyors, metering cement hoppers, and mixers similar to concrete batching plants have been adapted in some operations. When extremely dangerous materials are treated, remote-control and in-drum mixing equipment, such as that used with nuclear waste, is employed.

In most stabilization processes, the waste, stabilizing agent, and other additives, if used, are mixed in a mixing vessel and then transferred to a curing vessel or pad and allowed to cure. The actual operation (equipment requirements and process sequencing) depends on several factors including the nature of the waste, the quantity of the waste, the location of the waste in relation to the disposal site, the particular stabilization formulation used, and the curing rate. Following curing, the stabilized solid formed is recovered from the processing equipment and disposed of.

4.4 Waste Characteristics Affecting Performance (WCAPs)

In determining whether stabilization will achieve the same level of performance on an untested waste that it achieved on a previously tested waste and whether performance levels can be transferred, EPA examines the following waste characteristics: (a) the concentration of fine particulates, (b) the concentration of oil and grease, (c) the concentration of organic compounds, (d) the concentration of sulfate and chloride compounds, and (e) the solubility of the metal compound.

4.4.1 Concentration of Fine Particulates

For both cement-based and lime/pozzolan-based processes, very fine solid materials (i.e., those that pass through a No. 200 mesh sieve (less than 74 μm particle size)) weaken the bonding between waste particles and the cement or

lime/pozzolan binder by coating the particles. This coating inhibits chemical bond formation, thereby decreasing the resistance of the material to leaching. If the concentration of fine particulates in an untested waste is significantly higher than that in the tested waste, the system may not achieve the same performance. Pretreatment of the waste may be required to reduce the fine particulate concentration and achieve the same treatment performance, or other, more applicable treatment technologies may need to be considered for treatment of the untested waste.

4.4.2 Concentration of Oil and Grease

Oil and grease in both cement-based and lime/pozzolan-based systems result in the coating of waste particles and the weakening of the bond between the particle and the stabilizing agent, thereby decreasing the resistance of the material to leaching. If the concentration of oil and grease in the untested waste is significantly higher than that in the tested waste, the system may not achieve the same performance. Pretreatment may be required to reduce the oil and grease concentration and achieve the same treatment performance, or other, more applicable treatment technologies may need to be considered for treatment of the untested waste.

4.4.3 Concentration of Organic Compounds

Organic compounds in the waste interfere with the stabilization chemical reactions and bond formation, thus inhibiting curing of the stabilized material. This interference results in a stabilized waste having decreased resistance to leaching. If the total organic carbon (TOC) content of the untested waste is significantly higher than that of the tested waste, the system may not achieve the same performance. Pretreatment may be required to reduce the TOC and achieve the same treatment performance, or other, more applicable treatment technologies may need to be considered for treatment of the untested waste.

4.4.4 Concentration of Sulfate and Chloride Compounds

Sulfate and chloride compounds interfere with the stabilization chemical reactions, weakening bond strength and prolonging setting and curing time. Sulfate and chloride compounds may reduce the dimensional stability of the cured matrix, thereby increasing leachability potential. If the concentration of sulfate and chloride compounds in the untested waste is significantly higher than that in the tested waste, the system may not achieve the same performance. Pretreatment may be required to reduce the sulfate and chloride concentrations and achieve the same treatment performance, or other, more applicable treatment technologies may need to be considered for treatment of the untested waste.

4.4.5 Solubility of the Metal Compound

The metal to be stabilized should be in its least soluble state, or the stabilized waste may exhibit a potential for increased leachability. Pretreatment may be required to chemically reduce or oxidize the metal to a lower solubility state and achieve maximum stabilization performance. For example, hexavalent chromium is much more soluble and more difficult to stabilize than trivalent chromium.

4.5 Design and Operating Parameters

In assessing the effectiveness of the design and operation of a stabilization system, EPA examines the following parameters: (a) the amount and type of stabilizing agent and additives, (b) the degree of mixing, (c) the residence time, (d) the stabilization temperature and humidity, and (e) the form of the metal compound.

4.5.1 Amount and Type of Stabilizing Agent and Additives

The stabilizing agent and additives used will determine the chemistry and structure of the stabilized material and therefore its leachability. Stabilizing

agents and additives must be carefully selected based on the chemical and physical characteristics of the waste to be stabilized. To select the most effective type of stabilizing agent and additives, the waste should be tested in the laboratory with a variety of these materials to determine the best combination.

The amount of stabilizing agent and additives is a critical parameter in that sufficient stabilizing materials are necessary to properly bind the waste constituents of concern, making them less susceptible to leaching. The appropriate weight ratios of stabilizing agent and additives to waste are established empirically by setting up a series of laboratory tests that allow separate leachate testing of different mix ratios. The ratio of water to stabilizing agent (including water in waste) will also impact the strength and leaching characteristics of the stabilized material. Too much water will cause low strength; too little will make mixing difficult and, more important, may not allow the chemical reactions that bind the hazardous constituents to be fully completed. EPA evaluates the amount of stabilizing agent, water, and other additives used in the stabilization process to ensure that sufficient stabilizing materials are added to the waste to effectively immobilize the waste constituents of concern.

4.5.2 Degree of Mixing

Mixing is necessary to ensure homogeneous distribution of the waste, stabilizing agent, and additives. Both undermixing and overmixing are undesirable. The first condition results in a nonhomogeneous mixture; consequently, areas will exist within the waste where waste particles are neither chemically bonded to the stabilizing agent nor physically held within the lattice structure. Overmixing, on the other hand, may inhibit gel formation and ion adsorption in some stabilization systems. Optimal mixing conditions are usually determined through laboratory tests. The quantifiable degree of mixing is a complex assessment that includes, among other factors, the amount of energy supplied, the length of time the material is mixed, and the related turbulence

effects of the specific size and shape of the mix tank or vessel. The degree of mixing is beyond the scope of simple measurement. EPA, however, evaluates the degree of mixing qualitatively by considering whether mixing is provided and whether the type of mixing device is one that could be expected to achieve homogeneous distribution of the waste, stabilizing agent, and additives.

4.5.3 Residence Time

The residence time or duration of curing ensures that the waste particles have had sufficient time in which to incorporate into lattice structures and/or form stable chemical bonds. The time necessary for complete stabilization depends on the waste and the stabilization process used. The performance of the stabilized waste (i.e., the levels of waste constituents in the leachate) will be highly dependent on whether complete stabilization has occurred. Typical residence times range from 7 to 28 days. EPA monitors the residence time to ensure that sufficient time is provided to effectively stabilize the waste.

4.5.4 Stabilization Temperature and Humidity

Higher temperatures and lower humidity increase the rate of curing by increasing the rate of evaporation of water from the stabilization mixtures. If temperatures are too high, however, the evaporation rate can be excessive, resulting in too little water being available for completion of the stabilization reaction. EPA monitors the stabilization temperature and humidity continuously, if possible, to ensure that the system is operating at the appropriate design conditions and to diagnose operational problems.

4.5.5 Form of the Metal Compound

Ideally, the waste metal to be stabilized should be in its least soluble state to reduce leaching of the stabilized waste. Pretreatment such as chemical oxidation or chemical reduction may be required to oxidize or reduce the metal to a state of lower solubility. Additionally, the solubility of the metal can

be decreased by precipitating it with an appropriate compound. For example, ferric arsenate is less soluble and less leachable than calcium arsenate. EPA can monitor solubility of the metal by performing a standard leaching test (Extraction Procedure (EP) or Toxicity Characteristic Leaching Procedure (TCLP)).

4.6 References

- Ajax Floor Products Corp. n.d. Product literature: technical data sheets, Hazardous Waste Disposal System. P.O. Box 161, Great Meadows, N.J. 07838.
- Austin, G.T. 1984. Shreve's chemical process industries. 5th ed. New York: McGraw-Hill Book Co.
- Bishop, P.L., Ransom, S.B., and Grass, D.L. 1983. Fixation mechanisms in solidification/stabilization of inorganic hazardous wastes. In Proceedings of the 38th Industrial Waste Conference, May 10-12, 1983, at Purdue University, West Lafayette, Indiana.
- Conner, J.R. 1986. Fixation and solidification of wastes. Chemical Engineering. Nov. 10, 1986.
- Cullinane, M.J., Jr., Jones, L.W., and Malone, P.G. 1986. Handbook for stabilization/solidification of hazardous waste. U.S. Army Engineer Waterways Experiment Station. EPA report no. 540/2-86/001. Cincinnati, Ohio: U.S. Environmental Protection Agency.
- Electric Power Research Institute. 1980. FGD sludge disposal, annual. 2nd ed. Prepared by Michael Baker Jr., Inc. EPRI CS-1515 Project 1685-1. Palo Alto, Calif.: Electric Power Research Institute.
- Malone, P.G., Jones, L.W., and Burkes, J.P. Application of solidification/stabilization technology to electroplating wastes. Office of Water and Waste Management. SW-873. Washington, D.C.: U.S. Environmental Protection Agency.
- Mishuck, E., Taylor, D.R., Telles, R., and Lubowitz, H. 1984. Encapsulation/fixation (E/F) mechanisms. Report no. DRXTH-TE-CR-84298. Prepared by S-Cubed under Contract no. DAAK11-81-C-0164.
- Pojasek RB. 1979. Solid-waste disposal: solidification. Chemical Engineering 86(17): 141-145.
- USEPA. 1980. U.S. Environmental Protection Agency. U.S. Army Engineer Waterways Experiment Station. Guide to the disposal of chemically stabilized and solidified waste. Prepared for MERL/ORD under Interagency Agreement No. EPA-IAG-D4-0569. PB 81 181 505. Cincinnati, Ohio: U.S. Environmental Protection Agency.

5. VITRIFICATION

5.1 Applicability

Vitrification technologies include glass and slag vitrification and elevated-temperature calcination processes. Vitrification processes involve dissolving the waste at high temperatures into glass or a glasslike matrix. Calcination involves merely heating the material at high temperatures.

High-temperature vitrification is applicable to nonwastewaters containing arsenic* or other characteristic toxic metal constituents that are relatively nonvolatile at the temperatures at which the process is operated. This technology is also applicable to many wastes containing organometallic compounds, where the organic portion of the compound can be completely oxidized at process-operating conditions. Afterburners may be required to convert unburned organics to carbon dioxide.

The process is not generally applicable to volatile metallic compounds or to wastes containing high levels of constituents that will interfere with the vitrification process. High levels of chlorides and other halogen salts should be avoided in the wastes being processed because they interfere with glassmaking processes and cause corrosion problems.

Calcination processes are applicable to inorganic wastes that do not contain volatile constituents.

*Volatile arsenic compounds are usually converted to nonvolatile arsenate salts such as calcium arsenate prior to use of this process. In ordinary glass-making, arsenic volatilization problems are minimized by adding arsenic as arsenate salts.

5.2 Underlying Principles of Operation

The basic principles of operation for vitrification technologies depend on the technology used. In glass and slag vitrification processes, the waste constituents become chemically bonded inside a glasslike matrix in many cases. In all instances, the waste becomes surrounded by a glass matrix that immobilizes the waste constituents and retards or prevents their reintroduction into the environment. Arsenates are converted to silicoarsenates, and other metals are converted to silicates.

High-temperature calcination processes remove water of hydration from the toxic metal-bearing solids, convert hydroxides present to oxides, and sinter the material, reducing its surface area to a minimum. Conversion of hydroxides to oxides and minimization of available surface area retard surface reactions that would reintroduce the material into the environment. Calcination may also be accompanied by chemical reaction if a material such as lime is blended with the waste before it is heated. For example, lime will react with arsenic oxides at higher temperatures to form calcium arsenate, and this material will then be sintered at elevated temperatures. Brief descriptions of each of the high-temperature processes are given in the following subsections.

5.2.1 Glass Vitrification

In the glass vitrification process, the waste and normal glassmaking constituents are first blended together and then fed to a glassmaking furnace, where the mixed feed materials are introduced into a pool of molten glass. The feed materials then react with each other to form additional molten glass, in which particles of the waste material become dissolved or suspended. The molten glass is subsequently cooled. As it cools, it solidifies into a solid mass that contains the dissolved and/or suspended waste constituents. Entrapment and chemical bonding within the glass matrix render the waste constituents unavailable for reaction.

5.2.2 Slag Vitrification

Slag vitrification differs from glass vitrification in that finely ground slag from metal-refining processes and waste are premixed and fed to the same type of furnace as that used for glassmaking. The slag liquifies at the process temperature (1100 to 1200°C), and the waste constituents either dissolve or become suspended in the molten slag. Subsequent cooling of the slag causes it to solidify, trapping the waste inside a glasslike matrix and rendering it unavailable for chemical reaction or migration into the environment.

5.2.3 High-Temperature Calcination

In the high-temperature calcination process, the waste is heated in a furnace or kiln to between 400 and 800°C. In some instances, the waste may be blended with lime prior to heating. In those cases, chemical reaction may occur during the calcining process. Water present as either free water or water of hydration is evaporated, and hydroxides present are thermally decomposed to the corresponding oxides and water vapor. At the higher temperatures, the surface area of the dehydrated material is decreased by thermal sintering. Conversion of hydroxides to oxides and substantial losses of surface area render the material less reactive in the environment and lower the leachability of characteristic toxic metals present. In general, the higher the calcination temperatures used, the more complete the loss of water and the greater the accompanying loss of surface area, resulting in lower leachability potential.

5.3 Description of Vitrification Processes

This chapter discusses three types of high-temperature stabilization processes, which differ considerably from each other. Individual process descriptions are given in the following subsections.

5.3.1 Glass Vitrification

Soda ash, lime, silica, boron oxide, and other glassmaking constituents are first blended with the waste to be treated. The amount of waste added to the blend is dependent on the waste composition. Different metal oxides have differing solubility limits in glass matrices. The blended waste and glass raw material mixture is then fed to a conventional, heated glass electric furnace.

The introduced material typically is added through a port at the top of the furnace and falls into a pool of molten glass. The glass constituents dissolve in the molten glass and form additional glass. Molten glass is periodically withdrawn from the bottom of the furnace and cooled. This material then solidifies on cooling into solid blocks of glasslike material. Organics present in the feed mixture undergo combustion at the normal operating temperatures of 1100 to 1400°C and are fully oxidized to carbon dioxide and water vapor.

The top of the furnace is normally cooled so that volatile materials, such as arsenic oxides, that are present in the feed mixtures can condense on the cooled surface and fall back into the melt, where they can undergo chemical reaction to form silicoarsenates involved in the glassmaking process. Most of the arsenic used in making glass by this method is present as salts such as calcium arsenate. This approach was introduced into the glass industry to minimize fugitive arsenic losses.

Gases, such as carbon dioxide, that are liberated during the glassmaking process exit the furnace through the top and are generally wet-scrubbed prior to reentering the atmosphere.

5.3.2 Slag Vitrification

The slag vitrification process is basically similar to glass vitrification except that granulated slag, instead of the normal glassmaking constituents, is blended with the waste for feed to the system. A pool of liquid slag is present

in the furnace, and the blended raw material mix typically is introduced at the top of the furnace and falls into this molten slag. The granulated slag-waste mixture liquifies to form additional slag. Slag is periodically withdrawn from the slag pool and cooled into blocks.

The type of furnace used for glass vitrification can also be used for slag vitrification. The operating parameters are similar.

5.3.3 High-Temperature Calcination

In the high-temperature calcination process, wastes containing inorganic compounds are fed to ovens or kilns, where they are heated to high temperatures (i.e., 500 to 900°C) to drive off water of hydration and to convert hydroxides present to the corresponding oxides. This process is primarily applicable to inorganic wastes that contain nonvolatile constituents.

The waste is heated in the oven or kiln to the desired temperature, moisture and water of hydration are driven off; and, at the 500 to 900°C temperature range, hydroxides decompose to the corresponding oxides and water vapor. The high-temperature treatment also significantly reduces the surface areas of the oxides formed by sintering, thereby reducing the reactivity of the material. After the waste material has been calcined at an elevated temperature, it is withdrawn from the oven or kiln, cooled, and either land disposed or forwarded to another process, such as stabilization, for further treatment.

5.4 Waste Characteristics Affecting Performance (WCAPs)

The waste characteristics affecting performance are different for the two vitrification processes and the calcination process. Accordingly, they are discussed separately in the following subsections.

5.4.1 Waste Characteristics Affecting Performance (WCAPs)

In determining whether vitrification will achieve the same level of performance on an untested waste as on a previously tested waste, and whether performance levels can be transferred, EPA examines the following waste characteristics that affect performance of the vitrification processes: (a) organic content of the waste, (b) concentrations of specific metal ions in the waste, (c) concentrations of compounds in the waste that interfere with the glassmaking process, and (d) moisture content of the waste.

5.4.1.1 Organic Content

At process operating temperatures (1100 to 1400°C), organics are combusted to carbon dioxide, water, and other gaseous products. The combustion process liberates heat, reducing the external energy requirements for the process.

The amount of heat liberated by combustion is a function of the Btu value of the waste. The Btu content merely changes the energy input needs for the process and does not affect waste treatment performance. The amount of material that may not oxidize completely is a function of the organic halogen content of the waste. The presence of these halogenated organics does impact process performance because sodium chloride has a low solubility in glass. The presence of high chlorides results in a porous glass that is undesirable. If the halogenated organic content of an untested waste is the same as or less than that present in an already tested waste, the system should achieve the same performance for organic destruction.

5.4.1.2 Concentrations of Specific Metal Ions

Most metal oxides have solubility limits in glass matrices. Hence, their concentration determines the amount of glass-forming materials or slag with which they must be reacted in this process to generate a nonleaching slag or glass. The solubility limits of most common metal oxides and salts in glass are found

1

in the Handbook of Glass Manufacture and other treatises on glass production. Oxides for which extensive solubility information is available are alumina, antimony oxide, arsenic oxides, barium oxide, cadmium oxide, chromium oxides, copper oxides, cobalt oxides, iron oxides, lead oxides, manganese oxides, nickel oxides, selenium oxides, tin oxides, and zinc oxides. Analysis for individual metal concentrations in the waste can be performed according to EPA-approved methods. If the concentrations of specific metals in an untested waste are less than those in a tested waste, then the same ratio of slag or glass raw materials to waste may be used for vitrification purposes. If, however, the concentration of metal is greater than that in the tested waste, a different formulation must be used.

5.4.1.3 Concentrations of Deleterious Materials

Some waste constituents, such as chlorides, fluorides, and sulfates, interfere with the vitrification process if they are present at high levels. These salts have limited solubilities in glass; therefore, when they are present, additional glass-forming raw materials must be added to compensate for their presence. The solubility limits of various salts in glasses are discussed in references on glass production such as the Handbook of Glass Manufacture. Generally, if the concentrations of such materials in an untested waste are lower than those in a tested waste, then the same ratio of glass-forming constituents to waste may be used. Reducing agents such as carbon or ferrous salts reduce arsenates and selenates to lower valence compounds that are more volatile. These compounds should not be present in significant quantities in arsenic- or selenium-containing wastes to be vitrified.

5.4.1.4 Moisture Content

Materials fed to the vitrification process should be reasonably dry (i.e., contain less than 5 percent free moisture). If a waste has excess moisture above this level, it should be thermally dried before it is blended with glass-forming

materials; otherwise, it may react violently when introduced to the molten glass or slag pool.

5.4.2 Waste Characteristics Affecting Performance of High-Temperature Calcination

In determining whether high-temperature calcination will achieve the same level of performance on an untested waste as on a previously tested waste and whether performance levels can be transferred, EPA examines the following waste characteristics that impact the performance of the high-temperature calcination process: (a) the organic content of the waste, (b) the moisture content of the waste, and (c) the inorganic composition of the waste. These characteristics are discussed below.

5.4.2.1 Organic Content

Calcination temperatures normally used are too low to initiate combustion of some types of organic compounds. However, they are high enough to cause volatilization of organics, which have to be removed from process off-gases. For these reasons, the presence of significant levels of organics is undesirable but can be handled with appropriate air pollution controls. Organics, per se, do not interfere with the conversion of oxides to hydroxides or with sintering processes. Afterburners may be required on vitrification units managing high-organic-content wastes to ensure complete combustion of the organics present.

5.4.2.2 Moisture Content

Excess water that has to be removed from the waste by heating increases the amount of time needed to bring the waste to the calcination temperature. For this reason, wastes with high moisture content should be dewatered prior to the use of this process.

5.4.2.3 Inorganic Composition

Calcination temperatures are normally selected based on the temperatures at which hydroxides are thermally decomposed to the corresponding oxides and water vapor. To select an optimum operating temperature, one should know the approximate composition of the waste. A few toxic metal oxides have fairly low volatilization temperatures. Arsenic oxide, selenium dioxide, and mercuric oxide all volatilize below 500°C. High-temperature calcination should not be used for wastes that contain these volatile constituents unless the wastes are blended with materials such as lime, which will react with the constituents before they can vaporize. Nonvolatile arsenic compounds such as ferric and calcium arsenates can be calcined without concern for vaporization of material.

5.5 Design and Operating Parameters

The design and operating parameters for the vitrification processes are similar to each other, but differ considerably from those for high-temperature calcination. The following subsections discuss these two technologies separately.

5.5.1 Design and Operating Parameters for Vitrification Processes

In assessing the effectiveness of the design and operation of a vitrification system, EPA examines the following parameters: (a) the composition of the vitrifying agent, (b) the operating temperature, (c) the residence time, and (d) the vitrification furnace design.

5.5.1.1 Composition of the Vitrifying Agent

Slag and various glassmaking formulations are used as vitrifying agents. The choice of the vitrifying agent is determined by the solubility of the waste constituents to be vitrified. Different inorganic oxides have differing solubilities in various glass matrices.

For slags, the presence of carbon or other reducing agents is undesirable when arsenic-bearing or selenium-bearing wastes are vitrified. Carbon or ferrous salts in the slag reduce arsenates in the waste to arsenic trioxide, which has a low volatilization temperature. In a similar manner, these same reducing agents reduce selenates to elemental selenium, which also has a low volatilization temperature. When slags are used for vitrifying arsenic-bearing and selenium-bearing wastes, EPA monitors the composition of the granulated slags to ensure that they do not contain significant concentrations of carbon or ferrous salts.

In glass vitrification, various glassmaking formulations can be used. EPA examines the proposed formulations to ensure that the toxic metal ion concentrations of the final product do not exceed solubility limits. Hence, EPA examines the material balances based on waste composition and glassmaking additives and the published solubility limits for metal oxides in various glasses to ensure that the vitrified product is indeed a glass containing the solubilized toxic waste constituents.

5.5.1.2 Operating Temperature

Vitrification furnaces are normally operated in the 1100 to 1400°C range. The exact operating temperature is usually selected based on the desired composition of the final product. Furnaces are normally equipped with automatic temperature control systems. EPA examines the basis of choice for operating temperatures and the nature and physical condition of the temperature monitoring and control equipment to ensure that the system is being properly operated.

5.5.1.3 Residence Time

Sufficient time must be allowed for the materials added to glass furnaces to reach operating temperatures and then undergo the chemical reactions needed to produce glasses. Residence times are normally on the order of 1 to 2 hours for processes operated at 1100 to 1200°C. For glasses or slags requiring

slightly higher temperatures, slightly longer residence times are usually selected. EPA examines the basis for the facility's choice of residence times to ensure that the system is well operated.

5.5.1.4 Vitrification Furnace Design

Vitrification furnaces normally incorporate the following design features:

- Withdrawal of the product in liquid form from the base of the furnace.
- Maintenance of a liquid pool of product in the furnace.
- Addition of product constituent mix at the top of the furnace.
- Design of the top area of the furnace in a manner that allows for cooling of this area. (This is important because volatile constituents of the input feed may vaporize from the melt. The cool top area allows these constituents to condense and fall back into the melt.)
- Presence and proper operation of an air emissions control afterburner and scrubbing system to manage vent gas emissions from the system such as volatilized noncombusted organics and hydrogen chloride vapors from combustion of any chlorinated organics present.

EPA examines the furnaces to be used for waste vitrification to ensure that the design features mentioned above are present since they are important for proper operation of the systems.

5.5.2 Design and Operating Parameters for High-Temperature Calcination Systems

In assessing the effectiveness of the design and operation of a high-temperature calcination process, EPA examines the following parameters: (a) the operating temperature, (b) the residence time, and (c) the air emission control units in place on the ovens or kilns used.

5.5.2.1 Operating Temperature

Calcination temperatures of from 500 to 900°C have been used in industry. The calcination temperature selected is generally a temperature above which metal hydroxides present will decompose to the corresponding oxides. Data on decomposition temperatures of some metal hydroxides are given in Table 2. The temperature chosen is normally high enough to cause extensive sintering (surface area loss) of the oxides formed, while at the same time not volatilizing these materials. EPA examines the technical basis for selection of the calcining temperature to determine whether the system is properly operated. EPA also examines the temperature monitoring and control systems in place to determine whether they are properly operated and reliable.

Table 2 Metal Hydroxide Decomposition Temperatures

Metal hydroxide	Decomposition temperature (°C)
Cadmium hydroxide	300
Chromic acid	400
Lead hydroxide	145
Nickel hydroxide	230
Zinc hydroxide	125

Source: Weast 1977.

5.5.2.2 Residence Time

Calcination is generally a batch process, and sufficient time must be allowed for samples to be brought to the operating temperature. Residence times of several hours are normally used to minimize the effects of heat-up time. EPA examines the technical basis for the choice of residence time to ensure that sufficient heating at the required temperature is allowed to complete the dehydration and sintering processes. Residence time is a function of the time needed to bring the calcination furnace or kiln to the desired temperature and the time needed to complete the dehydration and sintering processes at the selected temperature.

5.5.2.3 Air Emission Control Systems

During the calcination process, water vapor is driven off as it is formed by the decomposition of hydroxides present in the waste. These hot gases exit the calcination furnace or kiln as they are formed. Some particulates from the waste material, as well as organics present in the waste, may become entrained in these vent gases. Therefore, for air pollution control purposes, the calcination units must be equipped with wet or dry particulate collection systems that are properly designed and operated. If wastes containing organics are processed by high-temperature calcination, the calcination furnaces need to be equipped with afterburners to combust organic vapors emitted. EPA examines the design basis, physical condition, and maintenance of these air emission control units to determine whether they are properly designed, maintained, and operated. EPA also examines the system of management in use for handling and subsequent treatment of the collected particulates to ensure that these finely divided waste particles are properly managed.

5.6 References

- Penberthy, L. 1984. Electric melting of glass. In Handbook of glass manufacture. Vol. I, pp. 387-399. New York: Ashlee Publishing Co.
- Penberthy, L. 1981. Method and apparatus for converting hazardous material to a relatively harmless condition. U.S. Patent 4299.611. November 10, 1981.
- Steitz, W.R., Hibscher, C.W., and Mattocks, G.R. 1984. Electric melting of glass. In Handbook of glass manufacture. Vol. I, pp. 400-428. New York: Ashlee Publishing Co.
- Tooley, F.V. 1984. Raw materials. In Handbook of glass manufacture. Vol. I, pp. 19-56. New York: Ashlee Publishing Co.
- Twidwell, L.G., and Mehta, A.K. 1985. Disposal of arsenic bearing copper smelter flue dust. In Nuclear and chemical waste management. Vol. 5, pp. 297-303. Butte, Mont.: Montana College of Mineral Science and Technology.
- Weast, R.C., ed. 1978. Handbook of chemistry and physics. 58th ed. Cleveland, Ohio: CRC Press.

II. REMOVAL TECHNOLOGIES

A. RECOVERY, REUSE*, AND/OR SEPARATION TECHNOLOGIES FOR ORGANICS

*The Agency encourages pollution prevention efforts such as those in recovery and reuse practices (see 40 CFR Part 261.1 for the definition of reuse, reclamation, and recycling). However, the Agency recognizes that currently there is some confusion over the definition of what constitutes a solid waste that has led to the proliferation of so-called "sham recycling" by some facilities. Sham recycling are illegitimate waste management practices whereby hazardous waste materials having no saleable value (no market for reuse) are claimed to be recycled/reused in order to escape the stringent RCRA hazardous waste definitions.

1. CARBON ADSORPTION

1.1 Applicability

Carbon adsorption is a treatment technology used to treat wastewaters containing dissolved organics at concentrations less than about 5 percent and, to a lesser extent, dissolved metal and other inorganic contaminants. The most effective metals removal is achieved with metal complexes.

The two most common carbon adsorption processes are the granular activated carbon (GAC), which is used in packed beds, and the powdered activated carbon (PAC), which is added loosely to wastewater. This section discusses the GAC process; the PAC process is discussed in Section I.A.1 of this document, i.e., Biological Treatment.

1.2 Underlying Principles of Operation

The basic principle of operation for carbon adsorption is the mass transfer and adsorption of a molecule from a liquid or gas onto a solid surface. Activated carbon is manufactured in such a way as to produce extremely porous carbon particles whose internal surface area is very large (500 to 1,400 square meters per gram of carbon). This porous structure attracts and holds (adsorbs) organic molecules as well as certain metal and inorganic molecules.

Adsorption occurs because (a) the contaminant has a low solubility in the waste, (b) the contaminant has a greater affinity for the carbon than for the waste, or (c) a combination of the two. The amount of contaminants that can be adsorbed by activated carbon ranges from 0.10 to 0.15 gram per gram of carbon.

1.3 Description of Carbon Adsorption Process

In GAC systems, the carbon is packed in a column and the wastewater is passed through the carbon bed(s). The flow can be either down or up through the

vertical column(s). Figure 13 shows two carbon adsorption systems. In the carbon adsorption process, the wastewater is passed through a stationary bed of carbon. The contaminants in the wastewater are adsorbed most rapidly and effectively by the upper layers of carbon during the initial stages of operation. These upper layers are in contact with the wastewater at its highest concentrations of contaminants. The small amounts of the contaminants that are not adsorbed in the first few layers of the activated carbon bed are removed from solution in the lower or downstream portion of the bed. Initially, none of the contaminants escapes from the carbon bed.

As the wastewater flows down the column (or the location in the column where the majority of adsorption is occurring) and the adsorption capacity is reached in the top layers, the adsorption zone moves down the column. As the adsorption zone approaches the end of the carbon bed, the concentration in the effluent rapidly approaches the influent concentration. This point in the process is referred to as breakthrough. A breakthrough curve (Figure 14) shows the plot of the ratio of effluent to influent concentrations versus time of process operation. At breakthrough, the adsorptive capacity of the carbon bed is exhausted, and little additional removal of contaminants occurs. Treated wastewater is then either treated further in another carbon adsorption column, if necessary, or disposed of.

Once the carbon bed is spent and can no longer remove contaminants from the waste, it is taken off-line. The activated carbon is then either regenerated by thermal or chemical methods for further use or treated by incineration and disposed of. If carbon adsorption is used to treat very toxic or hazardous materials, the spent carbon usually is incinerated and disposed of directly.

Regeneration is accomplished thermally by heating the carbon to a temperature (between 1,500 and 1,700°F) at which most of the adsorbed contaminants are volatilized and destroyed but which is not high enough to burn the surface of the carbon. About 4 to 9 percent of the carbon is lost in this process. Steam can also be used to regenerate carbon by volatilizing adsorbed

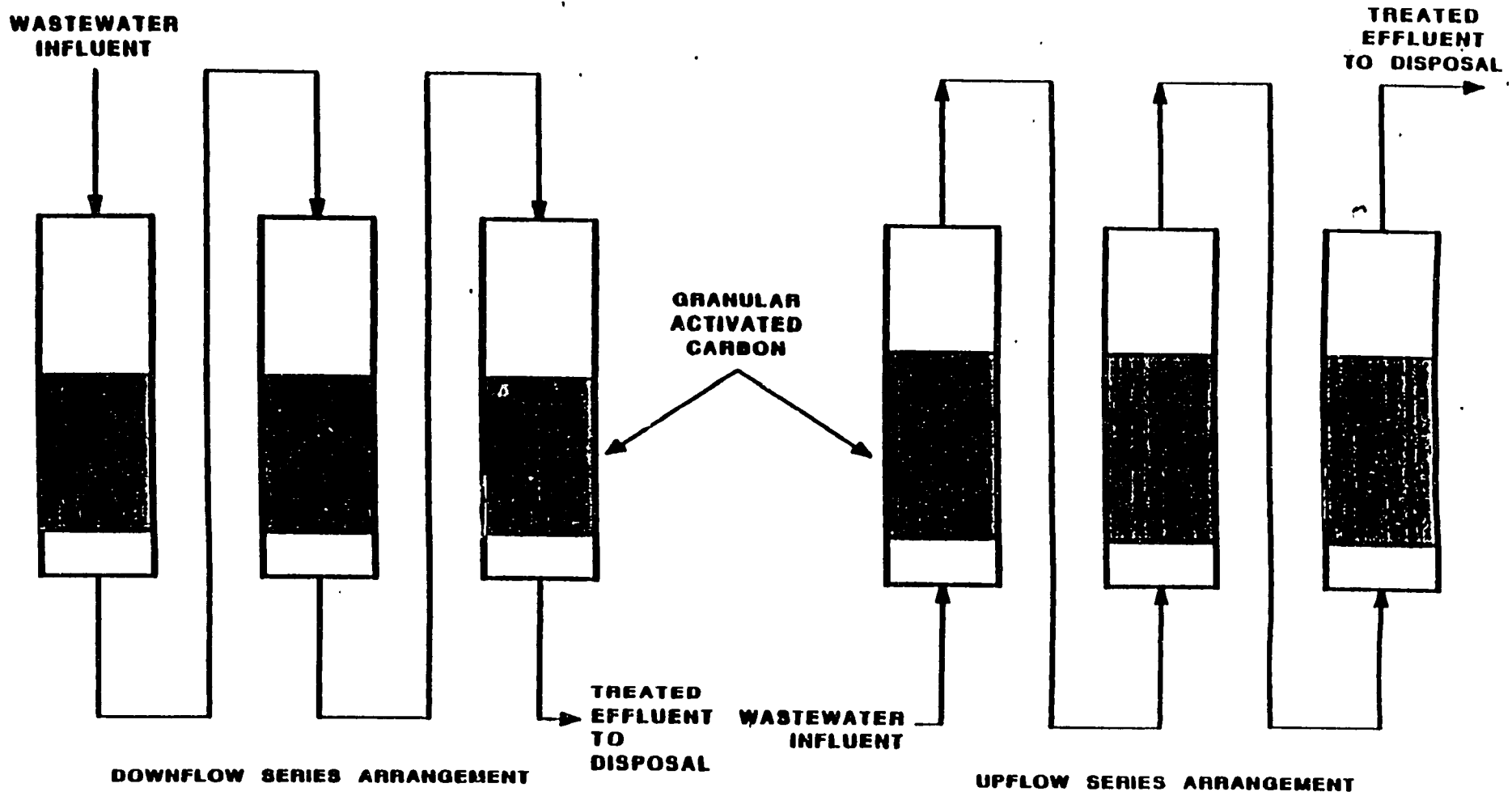

Figure 13 Carbon Adsorption Systems

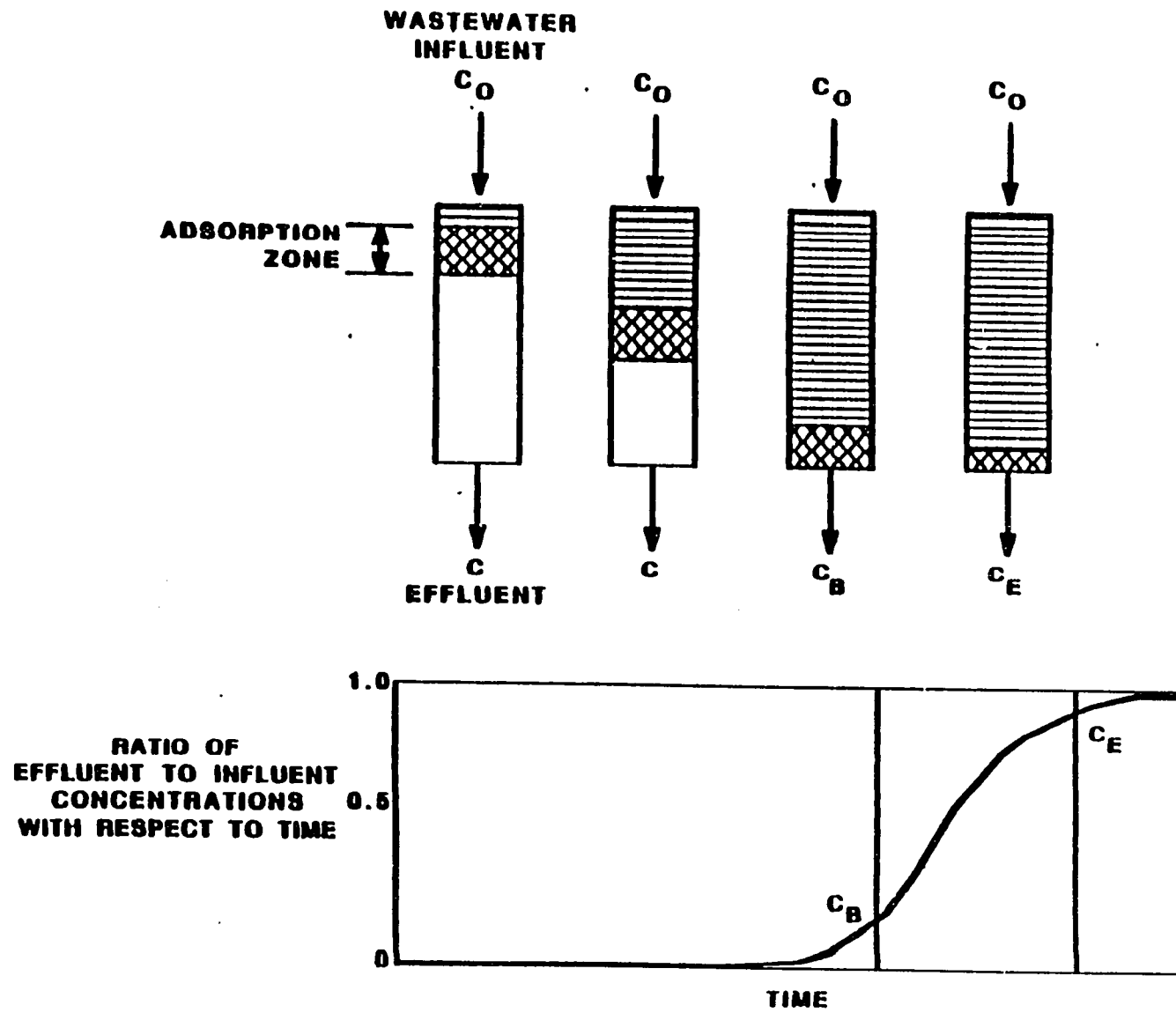

Figure 14 Plot of Breakthrough Curve

organics for subsequent condensation, recovery, and reuse or for treatment and disposal. -Chemical regeneration involves the use of an acid, alkali, or organic solvent to redissolve contaminants for subsequent recovery and reuse or for further treatment and disposal. There is a loss of performance with each regeneration of spent carbon because metals (such as calcium, magnesium, and iron) plug small pores in the carbon and prevent some organic contaminants from being desorbed at the thermal regeneration temperature. In each thermal regeneration process, some carbon becomes spent, requiring treatment and disposal. As a result, makeup carbon has to be added to the regenerated carbon being placed back in service.

The number of times that the carbon can be regenerated is determined by the extent of its physical erosion and the loss of its adsorptive capacity. Isotherm tests can be performed on the regenerated carbon to determine adsorptive capacity; such tests can thus aid in predicting the number of times the carbon can be regenerated.

1.4 Waste Characteristics Affecting Performance (WCAPs)

In determining whether carbon adsorption will achieve the same level of performance on an untested waste as it achieved on a previously tested waste and whether performance levels can be transferred, EPA examines the following waste characteristics: (a) the waste type and concentration of adsorbable contaminants and (b) the concentrations of suspended solids and oil and grease.

1.4.1 Waste Type and Concentration of Adsorbable Contaminants

The concentration of adsorbable contaminants is a measure of the fraction of the wastewater constituents that can be expected to be adsorbed by a carbon adsorption column. Concentrations of organics in the wastewater greater than about 5 percent result in excessive activated carbon consumption requiring frequent regeneration. At the higher organic concentrations other treatment

technologies, such as wet air oxidation, solvent extraction, or incineration, may be more appropriate.

Although all organics can be adsorbed to some degree, activated carbon has a greater affinity for aromatic than for aliphatic compounds and for nonpolar than for polar compounds. If the type and concentration of adsorbable contaminants in an untested waste are significantly less adsorbable and higher, respectively, than in the tested waste, the system may not achieve the same performance.

1.4.2 Concentrations of Suspended Solids and Oil and Grease

Suspended solids and oil and grease can reduce the effectiveness of carbon adsorption by clogging and coating the pores, as well as by competing for adsorption sites, thereby interfering with the treatment of contaminants of concern. EPA has information showing that this treatment interference occurs with suspended solids at levels greater than about 50 mg/l and with oil and grease at above 10 mg/l.

1.5 Design and Operating Parameters

In assessing the effectiveness of the design and operation of a carbon adsorption system, EPA examines the following parameters: (a) the type and pore size of the carbon particles, (b) the adsorption temperature, (c) the pH, and (d) the hydraulic loading rate.

For many hazardous organic constituents, analytical methods are not available or the constituent cannot be analyzed in the waste matrix. Therefore, it would normally be impossible to measure the effectiveness of the carbon adsorption treatment system. In these cases EPA tries to identify measurable parameters or constituents that would act as surrogates in order to verify treatment.

1

For organic constituents, each compound contains a measurable amount of total organic carbon (TOC). Removal of TOC in the carbon adsorption treatment system will indicate removal of organic constituents. Hence, TOC analysis is likely to be an adequate surrogate analysis where the specific organic constituent cannot be measured.

However, TOC analysis may not be able to adequately detect treatment of specific organics in matrices that are heavily organic-laden (i.e., the TOC analysis may not be sensitive enough to detect changes at the milligrams/liter (mg/l) level in matrices where total organic concentrations are hundreds or thousands of mg/l). In these cases, other surrogate parameters should be sought. For example, if a specific analyzable constituent is expected to be treated as well as the unanalyzable constituent, the analyzable constituent concentration should be monitored as a surrogate.

1.5.1 Type and Pore Size of Carbon Particles

Activated carbon is made from a variety of substances (e.g., coal, wood), ground to many different sizes, and manufactured with a number of different pore sizes. The pore size determines the surface area available for adsorption and, hence, the carbon's adsorptive capacity. The type and pore size of carbon particles exhibit different adsorptive capacities for different contaminants. Another property that is important in assessing the effectiveness of carbon particles is the iodine number; this value is an indicator of the adsorptive capacity for low-molecular-weight-organics. Laboratory bench testing is used to determine the most effective type and pore size of carbon particles for treating particular wastewaters. EPA examines the type and pore size of the carbon particles used to ensure that effective adsorption is achieved.

1.5.2 Adsorption Temperature

As the temperature increases, the solubility of the contaminants generally increases as well, which results in less effective adsorption. EPA monitors the

temperature continuously, if possible, to ensure that the system is operating at the appropriate design condition and to diagnose operational problems.

1.5.3 pH

The pH impacts both the solubility of the various contaminants and the potential for chemical bonding to occur. EPA monitors the pH continuously, if possible, to ensure that the system is operating at the appropriate design conditions and to diagnose operational problems.

1.5.4 Hydraulic Loading Rate

The amount of time that the waste contaminants are in contact with the carbon particles (i.e., residence time) impacts the extent to which adsorption occurs. Higher residence times generally improve adsorption performance but require longer carbon beds to maintain the same overall throughput. Typical residence times for GAC adsorption systems range from 30 to 100 minutes. For a given size carbon bed, the residence time can be determined by the hydraulic loading rate. Typical hydraulic loading rates for downflow adsorption systems range from 0.5 to 8.0 gal/min-ft², while upflow systems typically operate around 15 gal/min-ft². EPA monitors the hydraulic loading rate to ensure that sufficient time is provided to effectively adsorb contaminants.

1.6 References

- Authur D. Little, Inc. 1977. Physical, chemical and biological treatment techniques for industrial wastes. Vol. I., pp. 1-1 to 1-18 and 1-37 to 1-41. NTIS, PB275-054.
- DeJohn, P. B. 1975. Carbon from lignite or coal: Which is better? Chemical Engineering, April 28.
- Eckenfelder, W.W. Jr., Patoczka, J., and Watkins A. 1985. Wastewater treatment. Chemical Engineering, September 2, 1985.
- GCA Corp. 1984. Technical assessment of treatment alternatives for wastes containing halogenated organics. Prepared for U.S. Environmental Protection Agency, Contract No. 68-01-6871, pp. 150-160.
- Metcalf & Eddy, Inc. 1985. Briefing: Technologies applicable to hazardous waste. Prepared for U.S. Environmental Protection Agency, Office of Research and Development, Hazardous Waste Engineering Research Laboratory. Section 2.13.
- Patterson, J. W. 1985. Industrial wastewater treatment technology, 2nd ed. Stoneham, Mass.: Butterworth Publishers. pp. 329-340.
- Touhill, Shuckrow & Assoc. 1981. Concentration technologies for hazardous aqueous waste treatment. NTIS, PB81-150583. pp. 53-55.
- USEPA. 1973. U.S. Environmental Protection Agency. Process design manual for carbon adsorption. NTIS, PB227-157. pp. 3-21 and 53.
- USEPA. 1982. U.S. Environmental Protection Agency. Development Document for the Porcelain Enameling Point Source Category. pp. 172-241. Washington, D.C.: U.S. Environmental Protection Agency.
- USEPA. 1986. U.S. Environmental Protection Agency. Best demonstrated available technology (BDAT) background document for F001-F005 Spent Solvents, Vol. 1, EPA/530-SW-86-056, p. 4-4. Washington, D.C.: U.S. Environmental Protection Agency.
- Versar. 1985. Versar, Inc. An Overview of Carbon Adsorption. Draft final report prepared for U.S. Environmental Protection Agency, Exposure Evaluation Division, Office of Toxic Substances. Contract No. 68-02-3968, Task No. 58.

2. DISTILLATION TECHNOLOGIES

2.1 Applicability

Distillation is a thermal treatment technology applicable to the treatment of wastes containing organics that are volatile enough to be removed by the application of heat. Constituents that are not volatilized may be reused or incinerated as appropriate. The four most common distillation processes are batch distillation, fractionation, steam stripping, and thin film evaporation. Thermal drying is also included in this section because of its similarity to distillation processes. Thermal drying uses heat to volatilize water from wastes.

Batch distillation can be used to treat wastes having a relatively high percentage of volatile organics. In general, batch distillation is applied to spent solvent wastes where the wastes are highly concentrated in the solvent and yield significant amounts of recoverable materials upon separation. Batch distillation is particularly applicable for wastes that have both very volatile and very nonvolatile components since the separation of that combination of components is amenable to the relatively unsophisticated batch distillation equipment.

Fractionation is typically applied to wastes containing greater than about 7 percent organics. It is designed to achieve the highest degree of distillate purity of the separated components. Fractionation can be operated to produce multiple product streams for recovery of more than one organic constituent from a waste while generating relatively small amounts of residue to be land disposed. In general, this technology is used where recovery of multiple constituents is desired and where the waste contains minimal amounts of suspended solids.

Steam stripping is a form of distillation applicable to the treatment of wastewaters containing organics that are volatile enough to be removed by the

application of heat using steam as the heat source. Typically, steam stripping is applied where the waste contains less than 1 percent volatile organics.

Thin film evaporation is typically applied to wastes containing greater than 40 percent organics. However, the feed stream to the thin film evaporator must contain low concentrations of suspended solids.

Thermal drying is a treatment technology applicable to solid wastes typically having a filterable solids content of approximately 40 percent or greater. Thermal drying removes water and volatile organics from a solid waste through evaporation. Thermal dryers operate in the range of 300 to 700°F and usually have mechanical agitation to improve heat transfer. Use of this technology results in a smaller volume of waste with reduced concentrations of water and volatile organics.

A thermal dryer or "sludge dryer" is an enclosed device that is typically used to dehydrate sludge. The dryer's input (from wastes and auxiliary fuel) usually does not exceed 1500 Btu per pound of wastes treated, compared to 3,300 to 19,000 Btu per pound for incineration.

2.2 Underlying Principles of Operation

The basic principle of operation for distillation processes, i.e., batch distillation, fractionation, thin film evaporation, and steam stripping, is the volatilization of hazardous components through the application of heat. The components that are volatilized are then condensed and typically either reused or further treated, usually by liquid injection incineration. In thermal drying, the basic principle of operation for drying is the removal of a liquid from a solid waste by evaporation. This is similar to distillation in that volatilization of organic constituents also occurs. However, the primary purpose of thermal drying is to volatilize water. Liquid constituents will vaporize as a result of applied heat. In thermal drying, the rate at which liquid evaporation occurs depends on the thermal conductivity of the solid waste to be

dried and the boiling points of the volatile liquid constituents to be evaporated.

An integral part of the theory of the distillation process is the principle of vapor-liquid equilibrium. When a liquid mixture of two or more components is heated, the vapor phase present above the liquid phase becomes more concentrated in the more volatile constituents (those having higher vapor pressures). The vapor phase above the liquid phase is then removed and cooled to yield a condensate that is also more concentrated in the more volatile components. The degree of separation of components depends on the relative differences in the vapor pressures of the constituents; the larger the difference in the vapor pressures, the more easily the separation can be accomplished.

If the difference between the vapor pressures is extremely large, a single separation cycle or a single "equilibrium stage" of vaporization and condensation may achieve a significant separation of the constituents. In such cases, batch distillation or thin film evaporation would be used. Typically, batch distillation units and thin film evaporation units contain only one equilibrium stage and are thus limited in the degree of separation by the relative volatilities of the constituents.

If the difference between the vapor pressures of volatile components is small, then multiple equilibrium stages are needed to achieve effective separation. In practice, the multiple equilibrium stages are obtained by stacking "trays" or placing "packing" into a column. Essentially, each tray represents one equilibrium stage. In a packed steam stripping column or fractionation column, the individual equilibrium stages are not discernible, but the number of equivalent trays can be calculated from mathematical relationships. The vapor phase from a tray rises to the tray above it, where it condenses; the liquid phase falls to the tray below it, where it is again heated and separated.

The vapor-liquid equilibrium of the waste components can be expressed as relative volatility, which is the ratio of the vapor-to-liquid concentrations of

a constituent divided by the ratio of the vapor-to-liquid concentrations of another constituent. The relative volatility is a direct indicator of the ease of separation. If the numerical value is 1, then separation is impossible because the constituents have the same concentrations in the vapor and liquid phases. When the relative volatility is 1, the liquid mixture is called an azeotrope. Separation becomes increasingly easier as the value of the relative volatility becomes increasingly different from unity.

2.3 Description of Distillation Processes

2.3.1 Batch Distillation

A batch distillation unit usually consists of a steam-jacketed vessel, a condenser, and a product receiver. As the name implies, it is a batch process, not a continuous process. Figure 15 is a schematic showing the major components of a batch distillation unit. The steam jacket provides the heat required to vaporize the volatile constituents in the liquid fraction of the waste. The rising vapor is collected in the condenser, cooled, and condensed. The liquid product stream is then routed to the product receiver.

It is important to note that this technology treats wastes by vaporizing constituents, not destroying them. Accordingly, an integral part of this technology is a condensation system to collect the organics, as well as an air emission control system to collect or destroy those organics that are not condensed. The cooling load of the condenser is calculated in the design to ensure that the product recovery rate is maximized and emissions from condenser venting are minimized. The "bottoms," which are the least volatile constituents of the waste, are withdrawn from the bottom of the batch still. Because batch distillation is used to remove the volatile organics from wastes, the bottoms are reduced in volatile organic content. However, prior to disposal, the bottoms generally require additional treatment, such as incineration, for residual, less volatile organics.

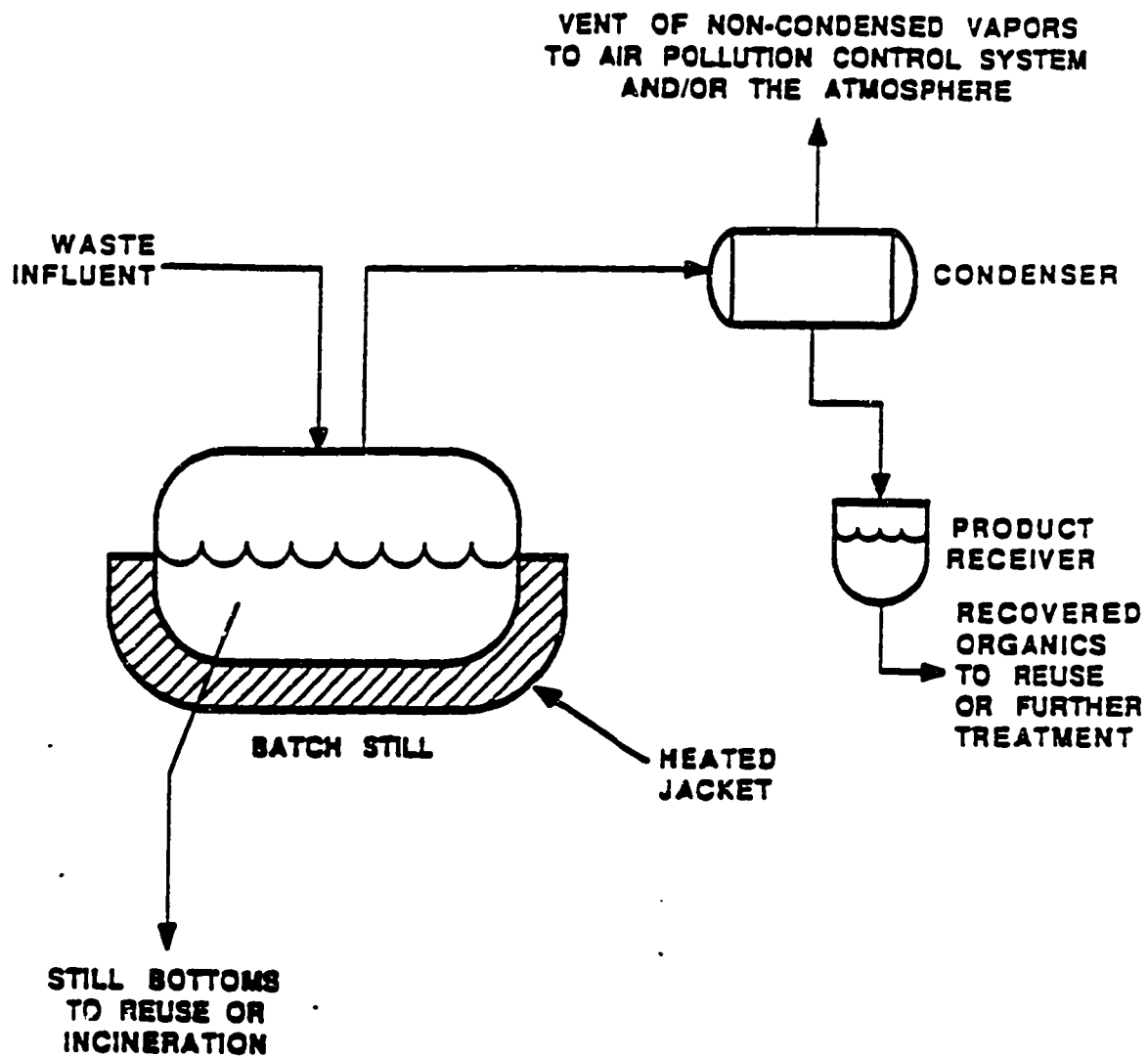

Figure 15 Batch Distillation System

2.3.2 Fractionation

Fractionation is a continuous process conducted in a unit that consists of a reboiler, a column containing stripping and rectification sections, a condenser, and a "reflux" system. Figure 16 is a schematic showing the major components of a fractionation unit. The reboiler is a device that provides the heat required to vaporize the liquid fraction of the waste. It supplies enough heat to maintain the liquid in the column at its boiling point. The stripping and rectifying sections are composed of a set of trays in a vertical column. The discrete trays may be replaced by loose packing consisting of plastic, metal, or ceramic geometric shapes that provide surface area for the continuous boiling/condensing that takes place in the column. In the stripping section, vapor rising from the boiler is contacted with the downflowing liquid feed. Through this contact, the constituents with lower boiling points (i.e., those that are more volatile) are concentrated in the vapor. In the rectification section, the vapor rising above the feed tray is contacted with downflowing condensed liquid product (reflux). Through this contact, the vapor is further enriched in the constituents with lower boiling points (i.e., the more volatile constituents). The rising vapor is collected at the top of the column and condensed in a condenser. The liquid product stream, except for the portion returned to the column as reflux, is then routed to a product receiver. The "bottoms," which are the least volatile components (i.e., those with the highest boiling points), are continuously withdrawn from the reboiler. Because the liquid composition varies slightly from one equilibrium stage to the next, it is also possible to withdraw streams of differing quality (sometimes called "fractions") from different locations throughout the column. This is typically done in refining petroleum, resulting in different grades or "cuts" of petroleum products.

2.3.3 Steam Stripping

Steam stripping is a continuous process conducted in a unit that consists of a boiler, a stripping column, a condenser, and a collection tank, as shown in

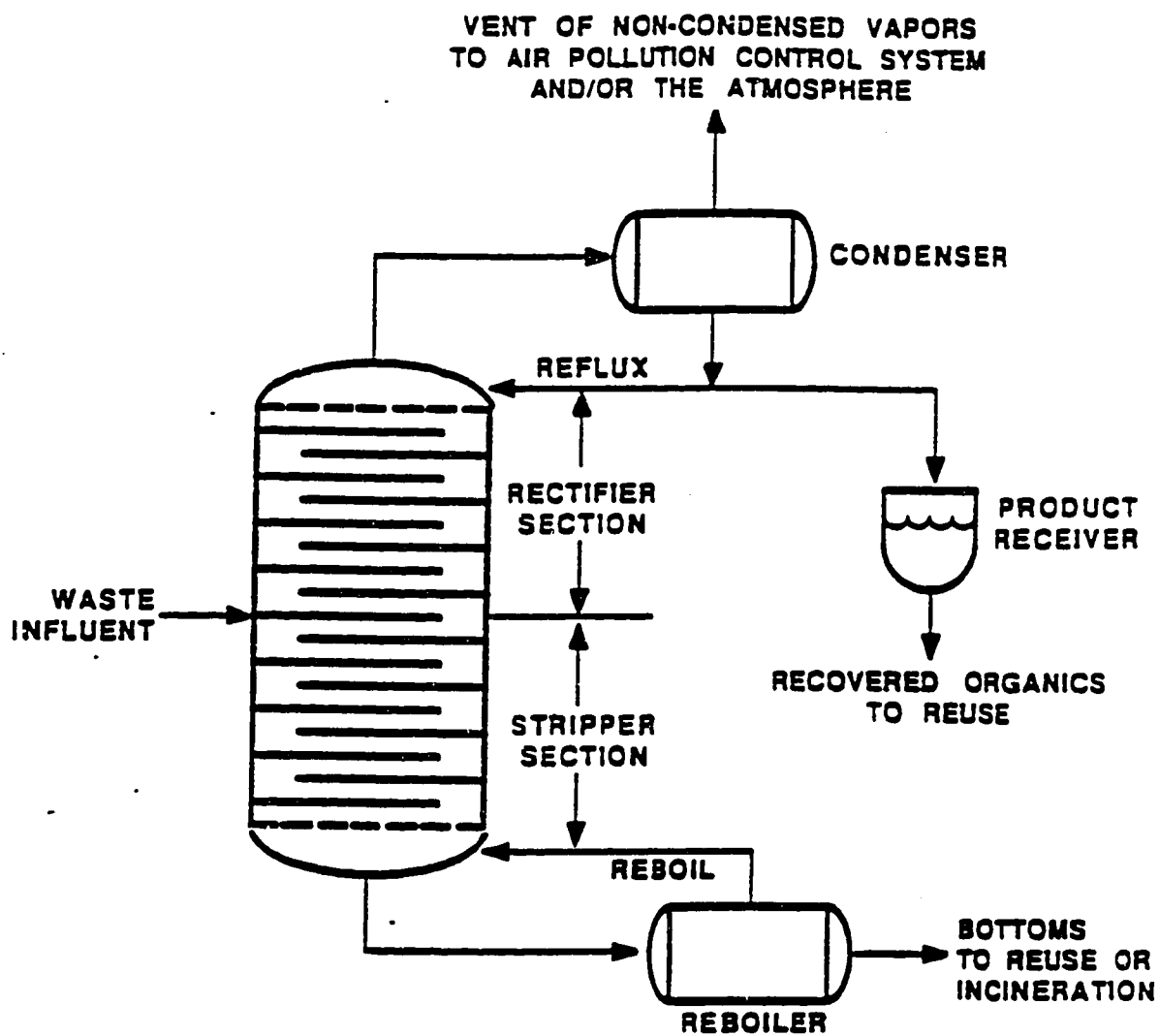

Figure 16 Fractionation System

Figure 17. The boiler provides the heat required to vaporize the liquid fraction of the waste. The stripping column is composed of a set of trays or packing placed in a vertical column.

The steam stripping process uses multiple equilibrium stages, with the initial waste mixture entering at the top, the uppermost equilibrium stage. The boiler is located beneath the lowermost equilibrium stage, allowing the vapor to move upward in the column, coming into contact with the falling liquid. As the vapor comes into contact with the liquid at each stage, the more volatile components are removed or "stripped" from the liquid by the vapor phase. The concentration of the emerging vapor is enriched in the more volatile constituents, and the liquid exiting the bottom of the boiler ("bottoms"), which is predominantly water, contains high concentrations of the lower vapor pressure constituents. This effluent from the bottom of the stripper is reduced in organic content but may still require additional treatment such as carbon adsorption or biological treatment. The steam and organic vapors exiting the top of the column are condensed. As condensed liquids, the organic components are usually immiscible with water. The two immiscible phases are then separated in a product receiver. Organics in the organic phase are typically recovered or disposed of in a liquid injection incinerator, while the aqueous condensate is recycled to the stripper.

2.3.4 Thin Film Evaporation

Thin film evaporation is a continuous process conducted in a unit that typically consists of a steam-jacketed cylindrical vessel and a condenser. Figure 18 is a schematic showing the major components of a thin film evaporator. The steam-heated surface of the cylindrical vessel provides the heat required to vaporize the volatile constituents in the waste. The evaporator walls are heated from the outside as the feed trickles down the inside walls in a thin film. Unique to this form of distillation is the distribution device that spreads the thin film over the heated surface. The feed rate of waste is controlled to allow the more volatile material adequate time to vaporize. The heat transfer from the

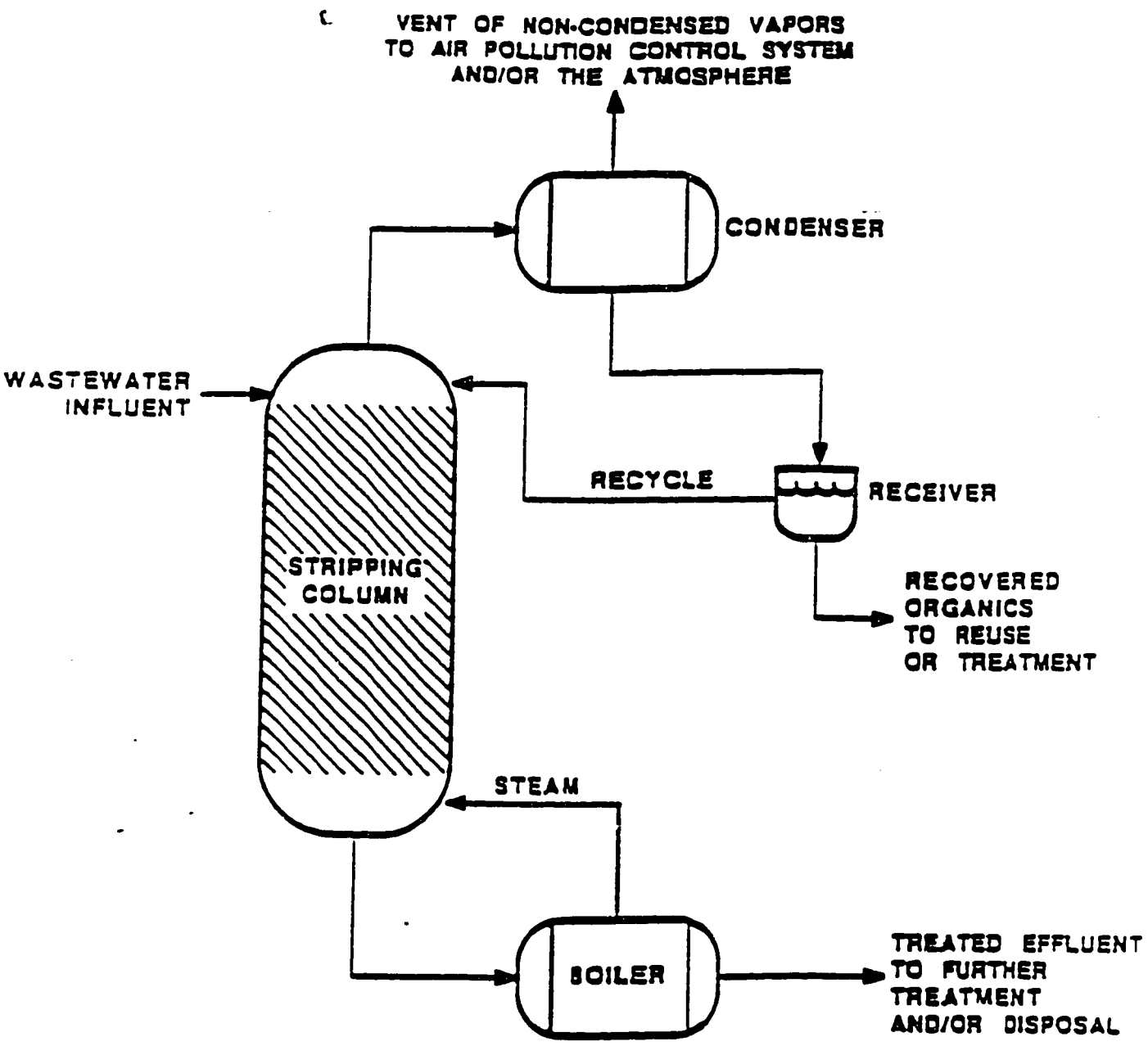

Figure 17 Steam Stripping System

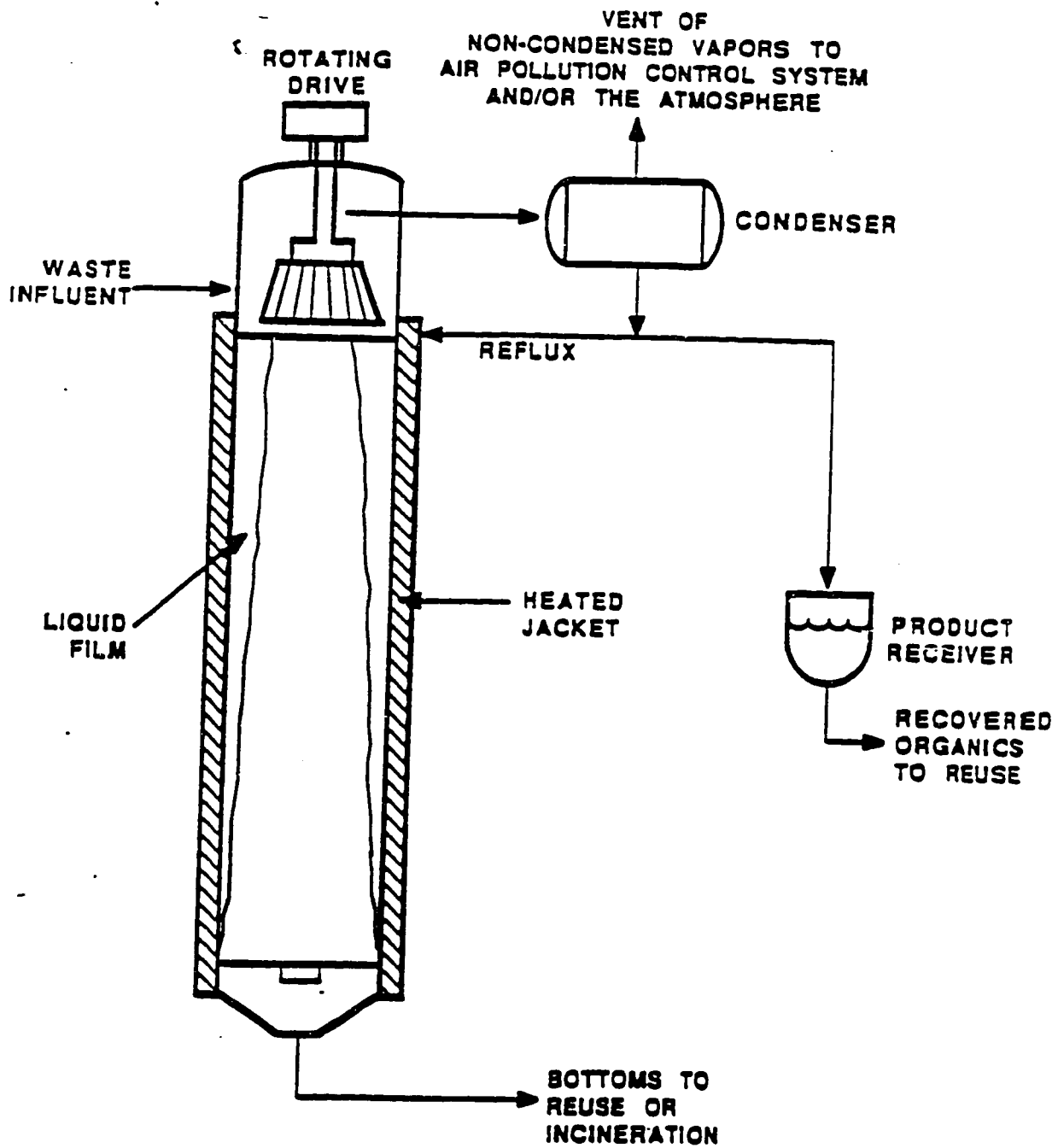

Figure 18 Thin Film Evaporation System

heating medium (steam) to the waste is determined by their relative temperatures, the heat transfer rate of the vessel materials, and the thermal properties of the waste stream forming the film. The rising vapor is collected at the top of the column, cooled, and condensed in a condenser. The condensed liquid product stream is then routed to a product receiver. The "bottoms," which are the least volatile components of the waste, are continuously withdrawn from the bottom of the thin film evaporator. Because thin film evaporation is used to remove the volatile organics from wastes, the bottoms are reduced in volatile organic content. However, prior to disposal, the bottoms usually require additional treatment, such as incineration, for residual, less volatile organics.

2.3.5 Thermal Drying

A wide range of batch and continuous dryers is available. One commonly used continuous type is the screw-flight dryer, the major components of which are shown in Figure 19. The screw-flight dryer consists of a screw surrounding a hollow shaft enclosed in a trough. Heat transfer fluid is heated to temperatures as high as 750°F and circulated, usually countercurrent to the flow of waste, through the hollow shaft. Heat transfers from the shaft to the screw blades, and then into the feed material, causing water and organics to be driven off in a vapor form. The dried cake is discharged from the dryer.

The dryer is designed to create good contact between the screw and feed material. The screw is usually equipped with breaker bars to ensure proper shearing of the input materials and to prevent the screw surfaces from fouling.

Vapors emerging from this system are managed in one of two ways, depending on their composition. If the vapors contain only water, they are usually directly vented to the atmosphere. However, if the vapors contain volatile organics, they are generally passed through a water-cooled condenser system. The recovered organic liquids from the condenser unit are then forwarded to another process for treatment or recovery.

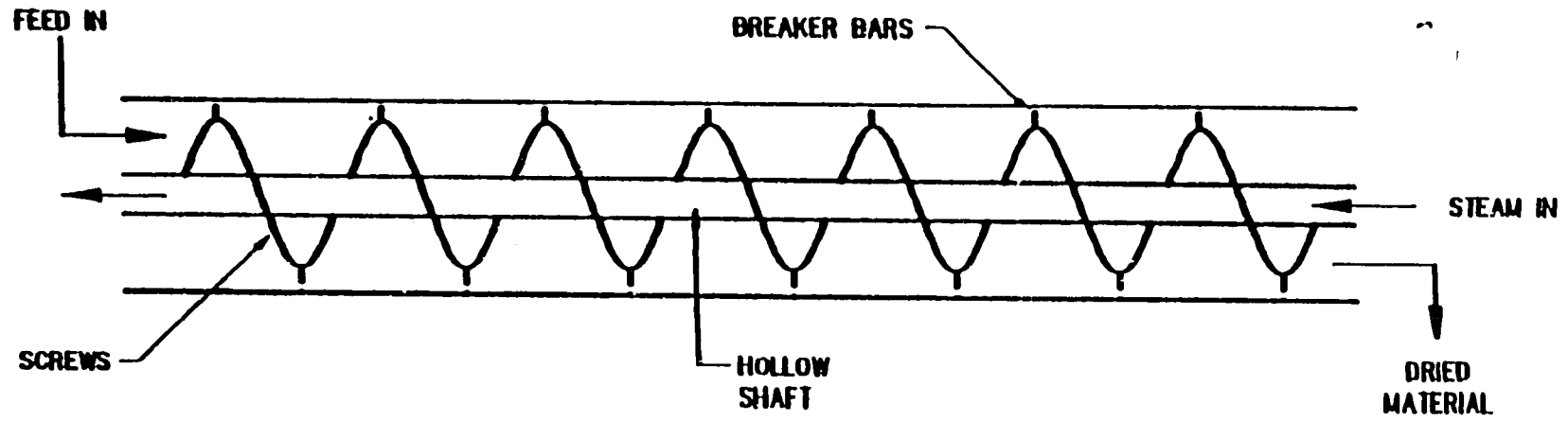

Figure 19 Screw Flight Dryer

2.4 Waste Characteristics Affecting Performance (WCAPs)

In determining whether distillation technologies will achieve the same level of performance on an untested waste as on a previously tested waste and whether performance levels can be transferred, EPA examines the following waste characteristics: (a) the component boiling points, (b) the thermal conductivity, (c) the concentration of volatiles, (d) the concentration of suspended solids, (e) the surface tension, and (f) the oil and grease content. The above-mentioned waste characteristics affecting performance vary for each distillation technology.

The WCAPs for each specific distillation process are as follows:

- Batch distillation: thermal conductivity, component boiling points, and concentration of volatiles.
- Fractionation, steam stripping, and thin film evaporation: concentration of suspended solids, component boiling points, concentration of volatiles, surface tension, and oil and grease content.
- Thermal drying: thermal conductivity and component boiling points.

2.4.1 Component Boiling Points

As noted earlier, the greater the ratio of volatility of the waste constituents, the more easily the separation of these constituents can proceed. This ratio is called relative volatility. EPA recognizes, however, that relative volatilities cannot be measured or calculated directly for the types of wastes generally treated by distillation processes because such wastes usually consist of a myriad of components, all with different vapor pressure-versus-temperature relationships. However, because the volatility of components is usually inversely proportional to their boiling points (i.e., the higher the boiling

point, the lower the volatility), EPA uses the boiling point of waste components as a surrogate waste characteristic for relative volatility. If the differences in boiling points between the more volatile and less volatile constituents are significantly smaller in the untested waste than in the tested waste, the system may not achieve the same performance and more rigorous operating conditions or other, more applicable treatment technologies may need to be considered for treatment of the untested waste.

2.4.2 Thermal Conductivity of the Waste

A major factor determining whether a particular constituent will volatilize is the potential for transfer of heat through the waste. For batch distillation, heat transfer is accomplished principally by conduction from the external source of heat (with some convection within the waste). For thermal drying, heat transfer is accomplished primarily by conduction rather than convection since the wastes are usually not liquids. Thermal conductivity is not as critical a consideration with other forms of distillation because the wastes are broken up into thin films, which conduct heat relatively rapidly.

Heat flow by conduction is proportional to the temperature gradient across the material. The proportionality constant, referred to as the thermal conductivity, is a property of the material to be distilled (or dried in the case of thermal drying). With regard to convection, EPA believes that the amount of heat transferred by convection is not dependent on the waste's thermal conductivity. Convection will usually be more a function of the system design than of the waste itself (i.e., how well the waste can be mixed during the process).

Thermal conductivity measurements, as part of a treatability comparison for two different wastes to be treated by a single batch distillation unit, are most meaningful when applied to wastes that are homogeneous (i.e., uniform throughout). As wastes exhibit greater degrees of nonhomogeneity, thermal conductivity becomes less accurate in predicting treatability because the

conductivity becomes less accurate in predicting treatability because the measurement essentially reflects heat flow through regions having the greatest conductivity (i.e., the path of least resistance) and not heat flow through all parts of the waste. Nevertheless, EPA believes that thermal conductivity may provide the best measure of performance of heat transfer. If the thermal conductivity of an untested waste is significantly lower than that of the tested waste, the system may not achieve the same performance, and other, more applicable treatment technologies may need to be considered for treatment of the untested waste.

2.4.3 Concentration of Volatile Components

The concentration of volatile components is a measure of the maximum fraction of the waste that can be expected to volatilize during a distillation process. A relatively low concentration of volatile components implies that most of the waste may become bottoms (i.e., relatively nonvolatile). If the concentration of relatively volatile components in the untested waste is significantly lower than that in the tested waste, the untested system may not perform adequately. More rigorous operating conditions, such as higher temperatures, higher residence times, etc., may be required to volatilize less volatile components and achieve the same treatment performance, or other, more applicable treatment technologies may need to be considered for treatment of the untested waste.

2.4.4 Concentration of Suspended Solids

Wastes containing large amounts of suspended solids--organic or inorganic--may have an adverse effect on distillation treatment systems. For example, in thin film evaporation, large amounts of suspended solids may coat heat transfer surfaces, thereby disturbing the uniform film and inhibiting volatilization of constituents. In fractionation and steam stripping, large amounts of suspended solids may clog column internals and coat heat transfer surfaces, thereby inhibiting heat transfer and mass transfer of constituents

between the vapor and liquid phases. If the concentration of suspended solids in the untested waste is significantly higher than that in the tested waste, the system may not achieve the same performance. Filtration may be required prior to distillation processes to reduce the concentration of suspended solids and achieve the same treatment performance, or other, more applicable treatment technologies may need to be considered for treatment of the untested waste.

2.4.5 Surface Tension

The surface tension of the waste is a measure of the tendency of the waste to foam and to "wet" the heat and mass transfer surfaces. The higher the surface tension of the liquid, the higher its tendency to foam. Also, higher surface tensions will not allow a film of the waste to coat heat and mass transfer surfaces as well as low surface tensions will. The likelihood of foaming requires special column design or the incorporation of defoaming compounds. Packed columns are usually less susceptible to foaming than are tray columns. Waste with high surface tensions that cannot effectively wet column packing or evaporator walls will not form the thin films that enhance heat and mass transfer. If the surface tension of the untested waste is significantly higher than that of the tested waste, the system may not achieve the same performance. Defoaming compounds and/or the use of a packed column may be required to reduce foaming and achieve the same treatment performance, or other, more applicable treatment technologies may need to be considered for treatment of the untested waste.

2.4.6 Concentration of Oil and Grease

High concentrations of oil and grease may clog steam stripping and fractionation equipment, thereby reducing their effectiveness. In thin film evaporation, high concentrations of oil and grease may result in the waste coating the evaporator walls, preventing a uniform film from forming and inhibiting volatilization of waste components. If the concentration of oil and grease in the untested waste is significantly higher than that in the tested

applicable treatment technologies may need to be considered for treatment of the untested waste.

2.5 Design and Operating Parameters

In assessing the effectiveness of the design and operation of distillation technologies, EPA may examine the following parameters: (a) the temperature and pressure, (b) the differential pressure, (c) the liquid and vapor flow rates, (d) the internal column design, (e) the number of separation stages, (f) the residence time, (g) the surface area, and (h) the mechanical system design.

The above-mentioned design and operating parameters vary for each distillation technology. The design and operating conditions for each specific distillation process are as follows:

- Batch distillation: temperature and pressure, and residence time.
- Fractionation: number of separation stages, liquid and vapor flow rates, temperature and pressure, differential pressure, and internal column design.
- Steam stripping: number of separation stages, liquid and vapor flow rates, temperature and pressure, and internal column design.
- Thin film evaporation: evaporator surface area, temperature and pressure, residence time, and the speed and design of the waste disposal mechanism.
- Thermal dryer: temperature and pressure, residence time, and the design and speed of the screw mechanism.

To evaluate the effectiveness of design and operating variables, it is necessary to measure the concentrations of the components to be separated in both the feed system and the process residuals (e.g., overheads and bottoms). For many hazardous organic constituents, analytical methods are not available or the constituent cannot be analyzed in the waste matrix. Therefore, it would normally be impossible to measure the effectiveness of treatment of distillation systems. In these cases EPA tries to identify measurable parameters or constituents that would act as surrogates to verify treatment.

For organic constituents, each compound contains a measurable amount of total organic carbon (TOC). Removal of TOC in the distillation treatment system will indicate removal of organic constituents. Hence, TOC analysis is likely to be an adequate surrogate analysis where the specific organic constituent cannot be measured.

However, TOC analysis may not be able to adequately detect treatment of specific organics in matrices that are heavily organic-laden; that is, the TOC analysis may not be sensitive enough to detect changes at the milligrams per liter (mg/l) level in matrices where total organic concentrations are hundreds or thousands of mg/l. In these cases other surrogate parameters should be sought. For example, if a specific analyzable constituent is expected to be treated as well as the unanalyzable constituent, the analyzable constituent concentration might be monitored as a surrogate.

2.5.1 Temperature and Pressure

These parameters are integrally related to the vapor-liquid equilibrium conditions. In steam stripping and fractionation, the temperature at any point in the column is an indicator of the constituent concentrations at that point, thus revealing whether the separation of components is taking place as expected. Overall column pressure influences the boiling point of the liquid at any location in the column. For example, through application of a partial vacuum to the column, the temperatures required to achieve the desired separation can be

reduced because liquids volatilize at lower temperatures when pressures are reduced. EPA monitors the temperature and pressure of a steam stripping column and a fractionation column continuously, if possible, to ensure that the system is operating at the appropriate design conditions and to diagnose operational problems.

In thin film evaporation, to achieve the desired volatilization, the evaporator may be operated at pressures below atmospheric (slight vacuum). At vacuum conditions, lower temperatures can be used, requiring less heat input, because boiling points decrease as pressure decreases. EPA monitors the thin film evaporator temperature as well as the pressure (if pressures other than atmospheric are used) continuously, if possible, to ensure that the system is operating at the appropriate design condition and to diagnose operational problems.

In batch distillation and in thermal drying, temperature provides an indirect measure of the energy available (i.e., Btu/hr) to vaporize the waste constituents. As the design temperature increases, more constituents with lower volatilities will be removed from the waste. Pressure is integrally related to the boiling point of the waste and the subsequent vaporization of the organic constituents. As the pressure is lowered below atmospheric (i.e., as vacuum is increased), the boiling point of the waste will also be lowered, thereby requiring less heat input to volatilize waste constituents. EPA monitors the distillation temperature as well as the pressure (if pressures other than atmospheric are used) to ensure that the system is operating at the appropriate design conditions and to diagnose operational problems.

2.5.2 Differential Pressure

In fractionation, measuring the differential pressure between the top and bottom of the column indicates whether the flow rate of either the liquid or the vapor phase is excessive. For instance, a high pressure drop across the column may indicate a condition of "flooding," in which the liquid phase cannot flow

down through the column as fast as feed is entering, causing backing up or "flooding" to occur. EPA monitors the pressure drop across the fractionation column continuously, if possible, to ensure that the system is operating at the appropriate design condition and to diagnose operational problems.

2.5.3 Liquid and Vapor Flow Rates

For steam stripping and fractionation, the vapor-liquid equilibrium data are also used to determine the liquid and vapor flow rates that provide sufficient contact and residence time between the liquid and vapor streams. The appropriate flow rates are affected by the column diameter. EPA monitors the liquid and vapor flow rates to ensure that sufficient contact time between the liquid and vapor streams is provided to effectively separate the organics from the wastewater, and to ensure that the column does not "flood" (i.e., the vapor or liquid flow is so high that the vapor cannot exit the top of the column as rapidly as it is generated and/or the liquid cannot run out the bottom as rapidly as it is fed into the column). Also see Differential Pressure, above.

2.5.4 Internal Column Design

In steam stripping and fractionation, column internals are designed to accommodate the physical and chemical properties of the waste to be fractionated. Two types of internals may be used in steam stripping and fractionation: trays and packing. Tray types include bubble cap, sieve, valve, and turbo-grid. Trays have several advantages over packing. They are less susceptible to blockage by solids, they have a lower capital cost for large-diameter columns (more than approximately 3 feet), and they accommodate a wider range of liquid and vapor flow rates. Compared to trays, packing has the advantages of having a lower pressure drop per theoretical stage, being more resistant to corrosive materials, having a lower capital cost for small-diameter columns (less than approximately 3 feet), and being less susceptible to foaming because of a more uniform flow distribution (i.e., lower local variations in flow rates). EPA examines the internal column design of a steam stripping or fractionation column to ensure

that the system is designed to handle potential operational problems (e.g., corrosion, foaming, channeling).

2.5.5 Number of Separation Stages

The number of separation stages in a steam stripping or fractionation column required to achieve the desired separation of the more volatile constituents from the less volatile constituents is calculated from vapor-liquid equilibrium data, which are determined empirically. Using the theoretical number of stages, one can determine the actual number of stages through the use of empirical tray efficiency data, typically supplied by equipment manufacturers. EPA examines the actual number of stages in the steam stripping or fractionation column to ensure that the system is designed to achieve an effective degree of separation of organics from the wastewater stream.

2.5.6 Residence Time

The residence time determines the necessary energy input into the system as well as the degree of volatilization achieved for organic constituents. The residence time requirement is dependent on the distillation or evaporation temperature (or dryer temperature in the case of thermal drying) and the thermal conductivity of the waste. EPA observes the residence time to ensure that sufficient time is provided to effectively volatilize organic constituents from the waste. In the case of thermal drying, the residence time must be sufficient to effectively evaporate the volatile liquid constituents and, hence, to dry the waste.

2.5.7 Evaporator Surface Area

In thin film evaporation, the evaporator surface area required to achieve the desired volatilization of organic components from the waste is calculated from the vapor-liquid equilibrium data, which are determined empirically, and from waste liquid flow rates. EPA examines the surface area of the evaporator

to ensure that sufficient surface area is provided to achieve effective volatilization of the more volatile organic components.

2.5.8 Mechanical System Design

Both thin film evaporation and thermal drying have rotating parts. For the evaporator, the speed and design of the feed distributor will help determine how well the feed will coat the evaporator surfaces. For the dryer, the size, screw flight, spacing, and speed of the screw mechanism will affect residence time and heat transfer. Typically, higher rotational speed will distribute feed more effectively in an evaporator and will provide more mixing turbulence in a dryer (for improved heat transfer). However, increased speed will reduce residence time in the dryer and will cause earlier mechanical failure in both evaporators and dryers (i.e., the bearings and shafts will wear more rapidly).

2.6 References

- DeRenzo, D.J., ed. 1978. Unit operation for treatment of hazardous industrial wastes. Park Ridge, N.J.: Noyes Data Corporation,
- Kirk-Othmer. 1965. Encyclopedia of chemical technology. 2nd ed., vol. 7, pp. 204-248. New York: John Wiley and Sons.
- McCabe, W.L., Smith, J.C., and Harriot, P. 1985. Unit operations of chemical engineering. pp. 533-606. New York: McGraw-Hill Book Co.
- Perry, R.H. and Chilton, C.H. 1973. Chemical engineers' handbook. 5th ed., pp. 13-1 to 13-60. New York: McGraw-Hill Book Co.
- Rose, L.M. 1985. Distillation design in practice. pp. 1-307. New York: Elsevier.
- Van Winkle, M. 1967. Distillation. pp. 1-684. New York: McGraw-Hill Book Co.
- Water Chemical Corporation. 1984. Process design manual for stripping of organics. PB84-232628. pp. 1-1 to F4. Prepared for the Industrial Environmental Research Laboratory, Office of Research and Development, U.S. Environmental Protection Agency.

3. EXTRACTION TECHNOLOGIES

3.1 Applicability

Extraction technologies (i.e., solvent extraction and critical fluid extraction) are used to treat wastes containing a variety of organic constituents and a broad range of total organic content. Extraction technologies have been demonstrated for treatment of API separator sludges and other hydrocarbon-bearing wastes generated by the petroleum and petrochemicals industries. In theory, these technologies are also applicable to wastes of similar composition generated by other industries such as the organic chemicals industry.

In solvent extraction, the selection of an extraction fluid (solvent) is dependent on the solubility of the organic waste constituents in the extraction fluid.

Critical fluid extraction is applicable to wastes containing organics that are soluble in pressurized fluids such as carbon dioxide, propane, butane, or pentane (extraction fluids). Compounds that have been successfully extracted from wastes by this process include aliphatic hydrocarbons, alkenes, simple aromatics such as benzene and toluene, polynuclear aromatics, and phenols.

3.2 Underlying Principles of Operation

The basic principle of operation in extraction technologies is that constituents are removed from a waste by mixing the waste with an extraction fluid (solvent) that will preferentially dissolve the waste constituents of concern from the waste. In the simplest extraction systems, two components are mixed: (a) the waste stream to be extracted and (b) extraction fluid. The extraction fluid and waste stream are mixed to allow mass transfer of the constituent (the solute) from the waste stream to the extraction fluid.

Except for the waste constituents that are to be extracted, the waste must be immiscible in the extracted fluid, so that after mixing, the two immiscible phases can physically separate by gravity. Separation of the extraction fluid phase and the waste stream phase occurs under quiescent conditions, relying on the density differences between the two phases.

The extraction fluid, which now contains the extracted contaminants, is called the extract; the extracted waste stream from which the contaminants have been removed is called the raffinate. The extract can be either the heavy (more dense) phase or the light (less dense) phase. In theory, the maximum degree of separation that can be achieved is provided by the selectivity value, which is the ratio of the equilibrium concentration of the contaminants in the extraction fluid to the equilibrium concentration of the contaminants in the waste. The solvent extraction process can be either batch or continuous.

In critical fluid extraction, the extraction fluids used are compounds that are usually gases at ambient conditions. Since the extraction fluid being used is a gas, it is first pressurized, which converts it to a liquid. As a liquid, it leaches (dissolves) the organic constituents out of the complex waste with which it is mixed. The enhanced solubilities of various organic compounds in hydrocarbons and other extraction fluids at high pressure aid in their removal from a waste. The process is usually carried out at or near the extraction fluid's "critical pressure," which is the pressure above which the liquid form of the extraction fluid cannot be gasified, no matter how much the fluid is heated. (In fact, above the critical pressure liquid and gas phases become physically indistinguishable, in that two phases do not really exist.)

3.3 Description of Extraction Process

3.3.1 Solvent Extraction

The simplest, least effective solvent extraction unit is a single-stage system (mixer-settler system). The solvent and the liquid waste stream are mixed

together; the raffinate and extract are separated by settling without further extraction.

The more effective multistage contact extraction is basically a series of batch mixer-settler units. The waste stream is contacted with solvent in a series of successive steps or stages. Raffinate from the first extraction stage is contacted with fresh solvent in a second stage, and so on.

In countercurrent, multistage extraction columns, fresh solvent and the waste stream continuously enter at opposite ends of a column consisting of a series of extraction stages. Extract and raffinate layers pass continuously and countercurrently from stage to stage through the system.

Several types of extraction systems are used for contact and separation. Three of the most common systems--mixer-settler systems, extraction columns, and centrifugal contactors--are discussed below.

3.3.2 Mixer-Settler Systems

Single-stage mixer-settler systems are extraction systems composed of a mixing chamber for phase dispersion, followed by a settling chamber for phase separation. Mixer-settler systems are typically used to treat solids or highly viscous wastes and can handle difficult-to-mix components. The vessels may be either vertical or horizontal. Dispersion in the mixing chamber occurs by pump circulation, nonmechanical in-line mixing, air agitation, or mechanical stirring. In a two-stage mixer-settler system (a simple multistage contact extractor), as shown in Figure 20, the extract from the first stage is sent to a recovery unit to separate the solvent from the remaining extract containing the organic constituents of concern. The recovered solvent is used, and the remaining extract is either reused or further treated in an incineration unit. The raffinate from the first stage is sent to the second-stage unit for additional extraction. Recycled solvent from recovery of the first-stage extract and/or fresh solvent makeup is added to the first-stage raffinate before it is

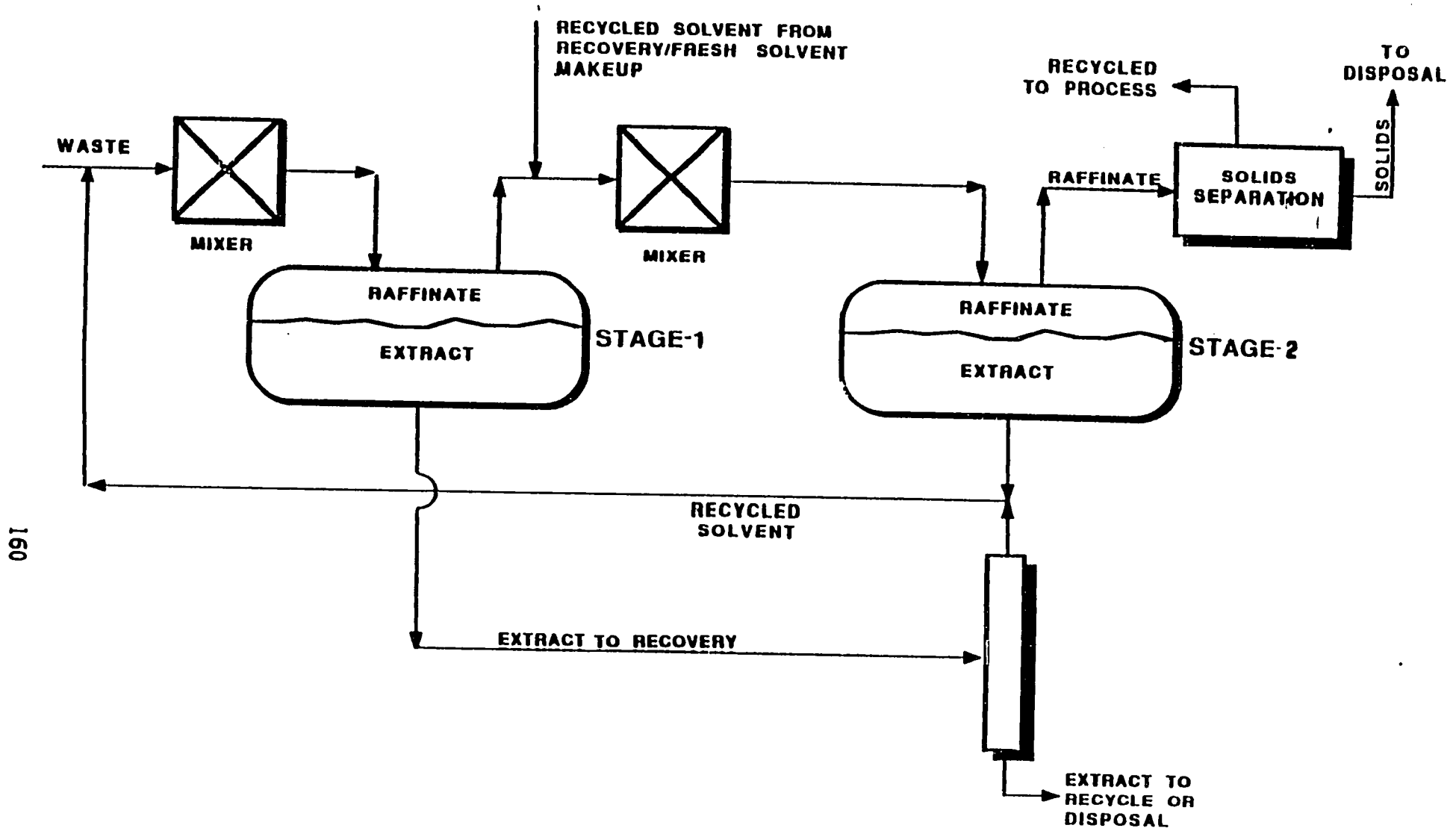

Figure 20 Two-Stage Mixer-Settler Solvent Extraction System

mixed and sent to the second stage. The extract from the second stage, containing mainly solvent, is recycled to the first-stage unit as the solvent stream. The resulting raffinate from the second stage may require filtering to remove solids before it is sent to further treatment (if required). If solids collected during filtration contain treatable levels of hazardous constituents, they will require further treatment, such as stabilization (for metals) and/or incineration (for organics) prior to disposal.

Parameters such as the density or specific constituent concentrations in the extract may be monitored to determine when the second-stage extract must be sent to solvent recovery and when fresh or recycled solvent must be added to the first-stage unit.

3.3.3 Extraction Columns

Extraction columns are continuous flow, countercurrent, multistage contact systems. Two types of extraction columns are packed extractors and sieve-tray extractors. Figure 21 presents schematics of these two types of extraction columns. A packed extractor contains plastic or ceramic materials in various geometric shapes or structured packings of wire gauze or mesh. Mass transfer of the contaminants from the waste to the extract is promoted because of breakup and distortion of both phases as they contact the packing, resulting in the intimate mixing of the waste and the solvent.

The sieve-tray extractor is similar to the sieve-tray column used in fractionation distillation. Tray perforations cause the formation of liquid droplets that aid the mass transfer process by allowing for more intimate contact between the solute and the solvent.

3.3.4 Centrifugal Contactors

Centrifugal contactors are based on the application of centrifugal force to increase rates of countercurrent flow and enhance separation of the phases.

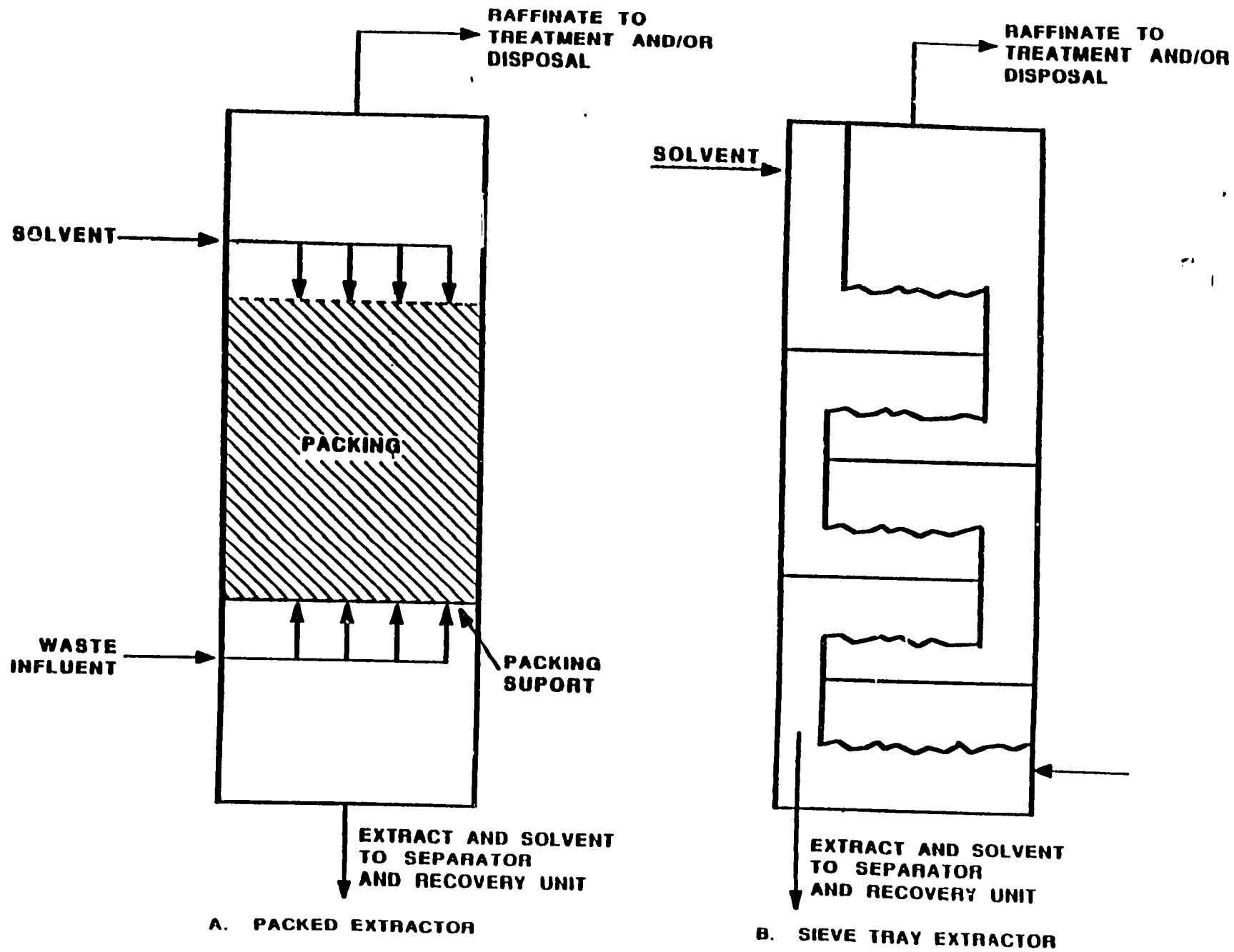

Figure 21 Packed and Sieve Tray Solvent Extraction Columns

Centrifugal units are used when short contact times are required, such as when unstable materials are being processed. One type of centrifugal contactor consists of a drum that rotates around a shaft equipped with annular passages at each end for feed and raffinate. The light phase is injected under pressure through a shaft and is then routed to the periphery of the drum through perforations. The heavy phase is also charged through the shaft, but it is channeled to the center of the drum through perforations. Centrifugal force acting on the phase-density difference promotes dispersion as the phases are forced through the perforations. Centrifugal extractors provide short contact time, have minimal space requirements, and easily handle emulsified materials and fluids with small density differences.

3.3.5 Critical Fluid Extraction

A critical fluid extraction system consists of a blending tank, one or more extraction vessels, one or more decanters, one or more filters, and an evaporation unit. Organic wastes such as oil refinery sludges are first combined in a blending tank and mixed well to yield a homogeneous, pumpable mixture. This mixture is then pumped under pressure to an extraction vessel filled with a liquified gas such as carbon dioxide, propane, butane, or pentane and is mixed under pressure to extract (dissolve) hydrocarbon components from the waste into the liquified gas extraction fluid. After the hydrocarbon components of the waste dissolve in the pressurized liquid, the resulting solution is gravity-separated in a decanter into a wastewater (or waste solids) stream and an extraction fluid-rich stream. The wastewater stream, containing inorganic solids, is sometimes filtered under pressure to remove the insoluble components. The extraction fluid-rich stream is fed to a pressurized evaporation unit. The extraction fluid (carbon dioxide, propane, butane, or pentane) is evaporated by dropping the pressure and is subsequently recovered, repressurized, and recondensed for reuse. The residue from the evaporation, consisting of a liquid hydrocarbon mixture, is then reprocessed or reused, blended with fuels for heat recovery, or incinerated. If the extracted waste stream still exceeds treatment

requirements, it may be extracted again with fresh extraction fluid at the high pressure conditions.

If inorganic residuals (or waste solids) filtered from the waste/solvent mixture contain treatable levels of hazardous constituents such as certain metals (e.g., chromium, lead) or organics, they will require further treatment such as stabilization or incineration prior to disposal.

3.4 Waste Characteristics Affecting Performance (WCAPs)

In determining whether extraction processes will achieve the same level of performance on an untested waste as on a previously tested waste and whether performance levels can be transferred, EPA examines the following waste characteristics: (a) the concentration of extractable hydrocarbons, (b) the solubility of the waste constituents of concern in the extraction fluid, (c) the surface tension, and (d) the alkalinity of the waste.

3.4.1 Concentration of Extractable Hydrocarbons

The concentration of extractable hydrocarbons in the waste feed is a measure of the maximum fraction of the waste that can be expected to be extracted in the process. A relatively low concentration of extractable hydrocarbons implies that most of the waste may become wastewater or waste solids (i.e., is nonextractable). Total extractable hydrocarbon content can be estimated by measurement of the total organic carbon (TOC) content. If the TOC of an untested waste is significantly lower than that of the tested waste, the untested system may not remove as much hydrocarbon as the tested system. More rigorous extraction conditions such as higher temperatures and pressures, additional mixing, and longer settling times may be required to extract less extractable components and achieve the same treatment performance, or other, more applicable treatment technologies may need to be considered for treatment of the untested waste.

Critical fluid extraction processes are designed to extract hydrocarbon components from mixed oily and organic waste liquids and sludges. For critical fluid extraction to be economically applied, the waste should contain at least a few percent by weight of extractable hydrocarbons. This process has been demonstrated on wastes containing from 5 to 34 percent hydrocarbons. For lower concentrations, batch distillation or conventional solvent extraction may be more economical. Also, critical fluid extraction is not economical for wastes containing high concentrations of extractable hydrocarbons (higher than 95 percent). These wastes are more amenable to fractionation treatment.

3.4.2 Solubility of the Waste Constituents of Concern in the Extraction Fluid

The constituents in the waste feed that are to be extracted determine the type of extraction fluid that is best suited for the process. For example, polar organic molecules (e.g., phenol) in an organic feed can be extracted with an aqueous solvent. Organic constituents in aqueous feeds can be extracted with various organic solvents. Metal-containing wastes can be extracted with acids (e.g., trialkylphosphoric and carboxylic acids) or amine solvents. If the solubility of the waste constituents of concern in the extraction fluid in the untested waste is significantly lower than that in the tested waste, the untested system may not achieve adequate performance. Use of another extraction fluid may be required to increase the solubility of the waste constituents of concern and achieve the same treatment performance, or other, more applicable treatment technologies may need to be considered for treatment of the untested waste.

3.4.3 Surface Tension

The surface tension of the waste is a measure of the tendency of the waste to foam. The higher the surface tension of the liquid, the higher its tendency to foam. If foaming is likely, the system design must be modified or defoaming compounds may be required. For column extractors, packed columns are less susceptible to foaming than are tray columns. If the surface tension of the untested waste is significantly higher than that of the tested waste, the

untested system may not achieve adequate performance. Defoaming compounds and/or the use of a packed column may be required to reduce foaming and achieve the same treatment performance, or other, more applicable treatment technologies may need to be considered for treatment of the untested waste. Foaming has not been found to affect the performance of critical fluid extraction processes.

3.4.4 Alkalinity of the Waste

In critical fluid extraction, when carbon dioxide is used as the extraction fluid, high alkalinity will interfere with the process because carbon dioxide will react to form carbonates and bicarbonates. This will result in excessive carbon dioxide consumption. For wastes having high alkalinity levels, an extraction fluid other than carbon dioxide should be used in the critical fluid extraction process. The same problem does not arise if a hydrocarbon fluid (propane, butane, or pentane) is used. If carbon dioxide was the extraction fluid used on a tested waste and the alkalinity of the untested waste is significantly higher than that of the tested waste, the system may not achieve the same performance. Use of another extraction fluid may be required to achieve the same treatment performance, or other, more applicable treatment technologies may need to be considered for treatment of the untested waste. Alkalinity of the waste has not been found to affect the performance of conventional solvent extraction processes.

3.5 Design and Operating Parameters

In assessing the effectiveness of the design and operation of extraction systems, EPA examines the following parameters: (a) the number of separation stages, (b) the extraction temperature and pH, (c) the degree of mixing, (d) the residence time, (e) the settling time, and (f) the extraction pressure.

For many hazardous organic constituents, analytical methods are not available or the constituent cannot be analyzed in the waste matrix. Therefore, it would normally be impossible to measure the effectiveness of the extraction

treatment system. In these cases, EPA tries to identify measurable parameters or constituents that would act as surrogates to verify treatment.

c

For organic constituents, each compound contains a measurable amount of total organic carbon (TOC). Removal of TOC in the extraction treatment system implies removal of organic constituents. Hence, TOC analysis is likely to be an adequate surrogate analysis where the specific organic constituent cannot be measured.

However, TOC analysis may not be able to adequately detect treatment of specific organics in matrices that are heavily organic-laden; that is, the TOC analysis may not be sensitive enough to detect changes at the milligrams per liter (mg/l) level in matrices where total organic concentrations are hundreds or thousands of mg/l. In these cases, other surrogate parameters should be sought. For example, if a specific analyzable constituent is expected to be treated as well as the unanalyzable constituent, the analyzable constituent concentration should be monitored as a surrogate.

3.5.1 Number of Separation Stages

For solvent extraction columns, the number of theoretical stages required to achieve the desired separation of hazardous constituents from a liquid waste into the selected extraction fluid is calculated from solvent equilibrium data, which are determined empirically. Using the theoretical number of stages, one can then determine the actual number of stages through the use of empirical tray efficiency data typically supplied by equipment manufacturers. EPA examines the actual number of stages in a solvent extraction column system to ensure that the system is designed to achieve an effective degree of extraction.

3.5.2 Extraction Temperature and pH

Temperature and pH changes can affect equilibrium conditions (pH will affect equilibrium when the waste or the extraction fluid is aqueous) and,

consequently, the performance of the solvent extraction system. Critical fluid extraction is normally performed at ambient temperature although it is possible to use higher temperatures when necessary. In all cases, temperatures used must be below the critical temperature* of the extraction fluid used to ensure that the fluid is present in the extraction vessel in the liquid phase (so that maximum contact with the waste can be achieved). EPA monitors the temperature and pH (as applicable) continuously, if possible, to ensure that the system is operating at the appropriate design conditions and to diagnose operational problems.

3.5.3 Degree of Mixing

For mixer-settler solvent extractors, mixing determines the amount of contact between the two immiscible phases and, accordingly, affects the degree of mass transfer of the constituents to be extracted. Intense agitation to provide high rates of mass transfer, however, can produce solvent waste dispersions that are difficult to separate into distinct phases. The waste must be premixed before introduction into the critical fluid extraction system to ensure a uniform, pumpable blend of material. The waste is normally mixed in tanks or other vessels. Any well-designed and well-operated system should have such waste blending equipment. The quantifiable degree of mixing is a complex assessment that includes, among other things, the amount of mixing energy supplied, the length of time the material is mixed, and the related turbulence effects of the specific size and shape of the tank vessel. This is beyond the scope of simple measurement. During the fluid extraction, the extraction fluid and waste need to be mixed to ensure maximum contact and, hence, efficiency of extraction. Any well-designed system should include a pressurized extraction vessel that is equipped with an operable mixing system. EPA, however, evaluates the degree of mixing qualitatively by considering whether the type of mixing

*The critical temperature of a substance is that temperature above which the substance cannot be liquified, no matter how high the operating pressures.

device provided is one that could be expected to achieve adequate uniform mixing of the waste.

3.5.4 Residence Time

The residence time in the extraction vessel impacts the extent of extraction of organic contaminants from the waste. Residence time will vary with the solubility of the organic contaminants in the solvent and the degree of mixing. For a batch solvent extraction system, the residence time is controlled directly by adjusting the treatment time in the extraction vessel. For a continuous solvent extraction system, the waste feed rate is controlled to ensure that the system is operating at the appropriate design residence time. In critical fluid extraction, as with conventional solvent extraction, the residence time in the extraction vessel impacts the extent of extraction of organic contaminants from the waste. EPA monitors the residence time to ensure that sufficient time is provided to effectively extract the organic contaminants from the waste.

3.5.5 Settling Time

For mixer-settler solvent extractors and critical fluid extractors, adequate settling time must be provided to make sure that separation of the phases has been effectively completed. EPA monitors the settling time to ensure effective phase separation.

3.5.6 Extraction Pressure

Critical fluid extraction systems operate at pressures at which the extraction fluids will be liquids at ambient temperatures. Pressure is normally monitored by means of gauges and recorders attached to the extraction vessel. EPA monitors the extraction pressure continuously, if possible, to ensure that the system is operating at the appropriate design condition and to diagnose operational problems.

3.6 References

- CF Systems Corporation. 1988. CF Systems units to render refinery wastes non-hazardous.
- De Renzo, D.J., ed. 1978. Unit operations for treatment of hazardous industrial wastes. Park Ridge, N.J.: Noyes Data Corporation.
- Gallacher, L.V. 1981. Liquid ion exchange in metal recovery and recycling. Third Conference on Advanced Pollution Control for the Metal Finishing Industry. USEPA 600/2-81-028. pp. 39-41.
- Hackman, E. 1978. Toxic organic chemicals, destruction and waste treatment. pp. 109-111. Park Ridge, N.J.: Noyes Data Corporation.
- Hanson, C. 1968. Solvent extraction theory, equipment, commercial operations, and economics. Chemical Engineering, August 26, 1968, p. 81.
- Humphrey, J.L., Rocha, J.A., and Fair, J.R. 1984. The essentials of extraction. Chemical Engineering, September 17, 1984, pp. 76-95.
- Johnston, K. 1978. Supercritical fluids. In Kirk-Othmer encyclopedia of chemical technology. Supplement Vol. I, pp. 872-983. New York: Wiley-Interscience.
- Lo, Teh C., Baird, M.H.I., and Manson, C., eds. 1983. Handbook of solvent extraction. pp. 53-89. New York: John Wiley and Sons.
- Perry, R.H., and Chilton, C.H. 1973. Chemical engineer's handbook, 5th ed., pp. 15-1 to 15-24. New York: McGraw-Hill Book Company.
- Weast, R.C., ed. 1978. Handbook of chemistry and physics. 58th ed. Cleveland, Ohio: CRC Press.

4. FUEL SUBSTITUTION

Fuel substitution involves using hazardous waste as a fuel in industrial furnaces or in boilers. The hazardous waste may be blended with other nonhazardous wastes (e.g., municipal sewer sludge) and/or fossil fuels.

On December 31, 1990, EPA promulgated regulations to control emissions from industrial furnaces and boilers from treatment of hazardous waste. Permit requirements are similar to those for incineration, in that controls limit the emissions of total organic carbons, toxic metals, HCl, and wastewaters. Like the incinerator regulations (40 CFR 264, Subpart O), the boiler and furnace regulations (40 CFR 266, Subpart H) require 99.99 percent destruction and removal efficiency of principal organic hazardous constituents (POHCs). These regulations will also minimize products of incomplete combustion (PICs), including carbon monoxide (CO). These regulations will also minimize particulate emissions by regulating the metal emissions.

4.1 Applicability

Fuel substitution has been used with industrial waste solvents, refinery wastes, synthetic fibers/petrochemical wastes, and waste oils. It can also be used when combusting other waste types produced during the manufacture of pharmaceuticals, pulp and paper, and pesticides. These wastes can be handled in a solid, liquid, or gaseous form.

Industrial furnaces include a variety of industrial processes that produce heat and/or products by burning fuels. They include blast furnaces, electric arc smelting furnaces, cement kilns, lime kilns, smelters, coke ovens, and halogen acid furnaces (HAFs). Industrial boilers are units wherein fuel is used to produce steam for process and plant use. Industrial boilers typically use coal, oil, or gas as the primary fuel source.

The parameters that affect the applicability of fuel substitution are the following:

- Halogen content of the waste;
- Inorganic solids content (ash content) of the waste, particularly heavy metals;
- Heating value of the waste;
- Viscosity of the waste (for liquids);
- Filterable solids concentration (for liquids); and
- Sulfur content.

4.1.1 Halogen Content of the Waste

If halogenated organics are burned, halogenated acids and free halogen are among the products of combustion. These released corrosive gases may require subsequent treatment prior to venting to the atmosphere. Also, halogens and halogenated acids formed during combustion are likely to severely corrode boiler tubes and other process equipment. To minimize such problems, halogenated wastes are blended into fuels only at very low concentrations. High chlorine content can also lead to the incidental production (at very low concentrations) of other hazardous compounds such as polychlorinated biphenyls (PCBs), chlorinated dibenzo-p-dioxins (CDDs), chlorinated dibenzofurans (CDFs), and chlorinated phenols.

4.1.2 Inorganic Solids Content of the Waste

High inorganic solids content (i.e., ash content) of wastes may cause two problems: (1) scaling in the boiler and (2) particulate air emissions. Scaling results from deposition of inorganic solids on the walls of the boiler. Particulate emissions are produced by noncombustible inorganic constituents that flow out of the boiler with the gaseous combustion products. Because of these

problems, wastes with significant concentrations of inorganic materials are not usually handled in boilers unless the boilers have an air pollution control system.

Industrial furnaces vary in their tolerance to inorganic constituents. Heavy metal concentrations, found in both halogenated and nonhalogenated wastes used as fuel, can cause environmental concern because they may be emitted in the gaseous emissions from the combustion process, in the ash residues, or in any produced solids. The partitioning of the heavy metals to these residual streams primarily depends on the volatility of the metal, waste matrix, and furnace design.

4.1.3 Heating Value of the Waste

The heating value of the waste must be high enough (either alone or in combination with other fuels) to maintain combustion temperatures consistent with efficient waste destruction and operation of the boiler or furnace. For many applications, only supplemental fuels having minimum heating values of 4,400 to 5,600 kcal/kg (8,000 to 10,000 Btu/lb) are considered to be feasible. Below this value, the unblended fuel would not be likely to maintain a stable flame, and its combustion would release insufficient energy to provide needed steam generation potential in the boiler or the necessary heat for an industrial furnace. Some wastes with heating values of less than 4,400 kcal/kg (8,000 Btu/lb) can be used if sufficient auxiliary fuel is used to support combustion or if special designs are incorporated into the combustion device. Occasionally, for wastes with heating values higher than virgin fuels, blending with auxiliary fuel may be required to prevent overheating or overcharging of the combustion device.

4.1.4 Viscosity of the Waste

In combustion devices designed to burn liquid fuels, the viscosity of the liquid waste must be low enough that it can be atomized in the combustion chamber. If the viscosity is too high, heating the storage tanks may be required

prior to combustion. For atomization of liquids, a viscosity of 165 centistokes (750 Saybolt Universal Seconds (Sus)) or less is typically required.

4.1.5 Filterable Solids Concentration

Filterable materials suspended in the liquid fuel may prevent or hinder pumping or atomization and if so other technologies may need to be considered.

4.1.6 Sulfur Content

A waste's sulfur content may affect whether it can be burned or not because the waste may emit sulfur oxide into the atmosphere. For instance, the EPA has promulgated sulfur oxide emission regulations for certain new source industrial boilers (40 CFR 266, Subpart H). Air pollution control devices are available to remove sulfur oxides from the stack gases.

4.2 Underlying Principles of Operation

For a boiler and most industrial furnaces there are two distinct principles of operation. Initially, energy in the form of heat is transferred to the waste to achieve volatilization of the various waste constituents. For liquids, volatilization energy may also be supplied by using pressurized atomization. The energy used to pressurize the liquid waste allows the atomized waste to break into smaller particles, thus enhancing its rate of volatilization. The volatilized constituents then require additional energy to destabilize the chemical bonds, allowing the constituents to react with oxygen to form carbon dioxide and water vapor. The energy needed to destabilize the chemical bonds is referred to as the energy of activation.

4.3 Description of Fuel Substitution Process

Since a number of industrial applications can use fuel substitution, there is no one process description that will fit all of these applications. The

following section, however, provides a general description of industrial kilns (one form-of industrial furnace) and industrial boilers.

4.3.1 Kilns

Combustible wastes have the potential to be used as fuel in kilns and, for waste liquids, are often used with oil to co-fire kilns. Coal-fired kilns are capable of handling some solid wastes. In the case of cement kilns, there are usually no residuals requiring land disposal since any ash formed becomes part of the product or is removed by particulate collection systems and recycled back to the kiln. The only residuals may be low levels of unburned gases that escape with combustion products. If this is the case, air pollution control devices may be required.

Three types of kilns are particularly applicable: cement kilns, lime kilns, and lightweight aggregate kilns.

4.3.1.1 Cement Kilns

The cement kiln is a rotary furnace, which is a refractory-lined steel shell used to calcine a mixture of calcium, silicon, aluminum, iron, and magnesium-containing minerals. The kiln is normally fired by coal or oil. Liquid and solid combustible wastes may then serve as auxiliary fuel. Temperatures within the kiln are typically between 1,380 and 1,540°C (2,500 to 2,800°F). To date, only liquid hazardous wastes have been burned in cement kilns.

Most cement kilns have a dry particulate collection device (i.e., either an electrostatic precipitator or a baghouse), with the fly ash collected and recycled back to the kiln. Buildup of metals or other noncombustibles is prevented through their incorporation into the product cement. Many types of cement require a source of chloride so that most halogenated liquid hazardous

wastes currently can be burned in cement kilns. Available information shows that scrubbers are not used.

4.3.1.2 Lime Kilns

Quick lime (CaO) is manufactured in a calcination process using limestone (CaCO₃) or dolomite (CaCO₃ and MgCO₃). These raw materials are also heated in a refractory-lined rotary kiln, typically to temperatures of 980 to 1,260°C (1,800 to 2,300°F). Lime kilns are less likely to burn hazardous wastes than are cement kilns because product lime is often added to potable water systems. Only one lime kiln in the United States currently burns hazardous waste. That particular facility sells its product lime for use as flux or as refractory in blast furnaces.

As with cement kilns, any fly ash collected is recycled back to the lime kiln; thus, no residual streams are produced by the kiln. Available information shows that scrubbers are not used.

4.3.1.3 Lightweight Aggregate Kilns

Lightweight aggregate kilns heat clay to produce an expanded lightweight inorganic material used in Portland cement formulations and other applications. The kiln has a normal temperature range of 1,100 to 1,150°C (2,000 to 2,100°F). Lightweight aggregate kilns are less amenable to combustion of hazardous wastes as fuels than are the other kilns described above because these kilns lack material to adsorb halogens. As a result, burning of halogenated organics in these kilns would likely require afterburners to ensure complete destruction of the halogenated organics and scrubbers to control acid gas production. Such controls would produce a wastewater residual stream subject to treatment standards.

4.3.2 Industrial Boilers

A boiler is a closed vessel in which water is transformed into steam by the application of heat. Normally, heat is supplied by the combustion of pulverized coal, fuel oil, or gas. These fuels are fired into a combustion chamber with nozzles and burners that provide mixing with air. Liquid wastes, and granulated solid wastes in the case of grate-fired boilers, can be burned as auxiliary fuel in a boiler. However, few grate-fired boilers burn hazardous wastes. For liquid-fired boilers, residuals requiring land disposal are generated only when the boiler is shut down and cleaned. This is generally done once or twice per year. Other residuals from liquid-fired boilers would be the gas emission stream, which would consist of any products of incomplete combustion, along with the normal combustion products. For example, chlorinated wastes would produce acid gases. If this is the case, air pollution control devices may be required. For solid-fired boilers, an ash normally is generated. This ash may contain residual amounts of organics from the blended waste/fuels, as well as noncombustible materials. Land disposal of this ash would require compliance with applicable BDAT treatment standards.

4.4 Waste Characteristics Affecting Performance (WCAPs)

In determining whether fuel substitution will achieve the same level of performance on an untested waste as on a previously tested waste and whether performance levels can be transferred, EPA examines the following waste characteristics: (a) the component boiling points, (b) the thermal conductivity of the waste, and (c) the component bond dissociation energies.

4.4.1 Component Boiling Points

The term relative volatility refers to the ease with which a substance present in a solid or liquid waste will vaporize from that waste upon application of heat from an external source. Hence, it bears a relationship to the equilibrium vapor pressure of the substance.

EPA recognizes that the relative volatilities cannot be measured or calculated directly for the types of wastes generally treated in an industrial boiler or furnace. The Agency believes that the best measure of relative volatility is the boiling point of the various hazardous constituents and will, therefore, use this parameter in assessing volatility of the organic constituents.

4.4.2 Thermal Conductivity of the Waste

Consistent with the underlying principles of combustion in aggregate kilns or boilers, a major factor with regard to whether a particular constituent will volatilize is the transfer of heat through the waste. In the case of industrial boilers burning solid fuels, heat is transferred through the waste by three mechanisms: radiation, convection, and conduction. For a given boiler, it can be assumed that the type of waste will have a minimal impact on the heat transferred from radiation. With regard to convection, EPA believes that the range of wastes treated would exhibit similar properties with regard to the amount of heat transferred by convection. Therefore, EPA will not evaluate the radiation or convection heat transfer properties of wastes in determining similar treatability. For solids, the third heat transfer mechanism, conductivity, is the one principally operative and most likely to change between wastes.

Using thermal conductivity measurements as part of a treatability comparison for two different wastes through a given boiler or furnace is most meaningful when applied to wastes that are homogeneous. As wastes exhibit greater degrees of nonhomogeneity, thermal conductivity becomes less accurate in predicting treatability because the measurement essentially reflects heat flow through regions having the greatest conductivity (i.e., the path of least resistance) and not heat flow through all parts of the waste. Nevertheless, EPA has not identified a better alternative to thermal conductivity, even for wastes that are nonhomogeneous.

4.4.3 Component Bond Dissociation Energies

Given an excess of oxygen, an organic waste in an industrial furnace or boiler would be expected to convert to carbon dioxide and water vapor provided that the activation energy is achieved. Activation energy is the quantity of heat (energy) needed to destabilize molecular bonds so that the oxidation (combustion) reaction will proceed to completion. As a measure of activation energy, EPA is using bond dissociation energies. In theory, the bond dissociation energy would be equal to the activation energy; in practice, however, this is not always the case because of molecular interaction bonds. In some instances, bond dissociation energies will not be available and will have to be estimated, or other energy effects will have a significant influence on activation energy.

4.5 Design and Operating Parameters

In assessing the effectiveness of the design and operation of a fuel substitution system, EPA examines the following parameters: (a) the combustion temperature, (b) the residence time, (c) the degree of mixing, (d) the air feed rate, (e) the fuel feed rate, and (f) the steam pressure/rate of production.

For many hazardous organic constituents, analytical methods are not available or the constituent cannot be analyzed in the waste matrix. Therefore, it would normally be impossible to measure the effectiveness of the fuel substitution treatment system. In these cases, EPA tries to identify measurable parameters or constituents that would act as surrogates to verify treatment.

For organic constituents, each compound contains a measurable amount of total organic carbon (TOC). Removal of TOC in the fuel substitution treatment system will indicate removal of organic constituents. Hence, TOC analysis is likely to be an adequate surrogate analysis where the specific organic constituent cannot be measured.

However, TOC analysis may not be able to adequately detect treatment of specific organics in matrices that are heavily organic-laden (i.e., the TOC analysis may not be sensitive enough to detect changes at the milligrams/liter (mg/l) level in matrices where total organic concentrations are hundreds or thousands of mg/l). In these cases, other surrogate parameters should be sought. For example, if a specific analyzable constituent is expected to be treated as well as the unanalyzable constituent, the analyzable constituent concentration should be monitored as a surrogate.

4.5.1 Combustion Temperature

Industrial boilers are generally designed based on their steam generation potential (Btu output). This factor is related to the design combustion temperature, which, in turn, depends on the amount of fuel burned and its Btu value. The fuel feed rates and combustion temperatures of industrial boilers are generally fixed based on the Btu values of fuels normally handled (e.g., No. 2 versus No. 6 fuel oils). When wastes are to be blended with fossil fuels for combustion, the blending, based on Btu values, must be such that the resulting Btu value of the mixture is close to that of the fuel value used in the design of the boiler. Industrial furnaces also are designed to operate at specific ranges of temperature to produce the desired product (e.g., lightweight aggregate). The blended waste/fuel mixture should be capable of maintaining the design temperature range.

4.5.2 Residence Time

A sufficient residence time of combustion products is normally necessary to ensure that the hazardous substances being combusted (or formed during combustion) are completely oxidized. Residence times on the order of a few seconds are generally needed at normal operating conditions. For industrial furnaces as well as boilers, the residence time is a function of the size of the furnace and the fuel feed rates. For most boilers and furnaces, the residence time usually exceeds a few seconds.

4.5.3 Degree of Mixing

Boilers are designed so that fuel and air are intimately mixed. This helps to ensure that complete combustion takes place. The shape of the boiler and the method of fuel and air feed influence the turbulence required for good mixing. Industrial furnaces also are designed for turbulent mixing where fuel and air are mixed.

4.5.4 Air Feed Rate

An important operating parameter in boilers and many industrial furnaces is the oxygen content in the flue gas, which is a function of the air feed rate. Stable combustion of a fuel generally occurs within a specific range of air-to-fuel ratios. An oxygen analyzer in the combustion gases can be used to control the feed ratio of air to fuel to ensure complete thermal destruction of the waste and efficient operation of the boiler. When necessary, the air feed rate can be increased or decreased to maintain proper fuel-to-oxygen ratios. Some industrial furnaces do not completely combust fuels (e.g., coke ovens and blast furnaces); hence, oxygen concentration in the flue gas is a meaningless variable.

4.5.5 Fuel Feed Rate

The rate at which fuel is injected into the boiler or industrial furnace will determine the thermal output of the system per unit of time (Btu/hr). If steam is produced, steam pressure monitoring will indirectly determine whether the fuel feed rate is adequate. However, various velocity and mass measurement devices can be used to monitor fuel flow directly.

4.5.6 Steam Pressure or Rate of Production

Steam pressure in boilers provides a direct measure of the thermal output of the system and is directly monitored by use of in-system pressure gauges.

Increases or decreases in steam pressure can be effected by increasing or decreasing the fuel and air feed rates within certain operating design limits. Most industrial furnaces do not produce steam; instead they produce a product (e.g., cement, aggregate) and monitor the rate of production.

4.6 References

- Bonner, T.A., et al. 1981. Engineering handbook for hazardous waste incineration. Prepared by Monsanto Research Corporation for U.S. Environmental Protection Agency PB 81-248163.
- Castaldini C., et al. 1986. Disposal of hazardous wastes in industrial boilers or furnaces, Park Ridge, N.J.: Noyes Publications.
- USEPA. 1990. Office of Solid Waste. Standards for owners and operators of hazardous wastes in boilers and industrial furnaces; proposed and supplemental proposed rule, technical corrections, and request for comments. 55 FR 17862, April 27, 1990.
- Versar. 1984. Estimating PMN incineration results. EPA Contract No. 68-01-6271, Task No. 66. Draft report for Exposure Evaluation Division, Office of Toxic Substances. Washington, D.C.: U.S. Environmental Protection Agency.

II. REMOVAL TECHNOLOGIES (CONTINUED)

**B. RECOVERY AND/OR SEPARATION TECHNOLOGIES
FOR METALS**

1. ACID LEACHING

1.1 Applicability

Acid leaching is a treatment technology used to treat wastes in solid or slurry form containing metal constituents that are soluble in a strong acid solution or can be converted by reaction with a strong acid to a soluble form. This process has been used to recover metals such as mercury, copper, nickel, silver, and cadmium from inorganic wastes generated in the primary metals and inorganic chemicals industries.

The acid leaching process is most effective with wastes having high (over 1,000 ppm) levels of metal constituents. Wastes containing lower levels of such contaminants are more difficult to process because the low metal concentrations require longer contact times.

Acid leaching can also be used to extract heavy metals or radionuclides from mixed wastes, principally soils, separating the material into its hazardous and radioactive components. This process has greater utility when combined with unit operations such as ion exchange, solvent extraction, chemical precipitation, and filtration.

Another type of leaching process, alkaline leaching, is used to treat wastes containing metal constituents that are soluble in a strong caustic or alkaline solution. This process is mainly useful in recovering aluminum from bauxite ore. Generally, the following information on acid leaching would be applicable to alkaline leaching.

1.2 Underlying Principles of Operation

The basic principle of operation for acid leaching is that solubilities of various metals in acid solutions aid in their removal from a waste. The process concentrates the constituent(s) leached by the acid solutions. These constituents can then be filtered to remove residual solids and neutralized to

precipitate solids containing high concentrations of the constituents of interest, which can be further treated in metals recovery processes. Alternatively, the acid solutions can be electrolyzed to recover pure metals. An acid leaching system usually consists of a solid/liquid contacting unit followed by a solid/liquid separator. The most frequently used acids include sulfuric (H_2SO_4), hydrochloric (HCl), and nitric (HNO_3). Although any acidic pH can theoretically be used, acid leaching processes are normally run at a pH from 1 to 4.

1.3 Description of Acid Leaching Process

Acid leaching processes can be categorized into two major types: (a) treatment by percolation of the acid through the solids or (b) treatment by dispersion of the solids within the acid solution. Both treatments are followed by subsequent separation of the solids from the liquid. In both types of systems, sufficient acid must be supplied to keep the pH at the level needed to effectively leach the metals from the waste.

1.3.1 Percolation Processes

Percolation is typically conducted in batch tanks. Batch percolators are large tanks ranging in size up to 50,000 gallons. First, the solids are placed in the tank, and then acid is added. The acid percolates through the solids and drains out through screens or a porous medium in the tank bottom. Following treatment, the solids are removed and further treated using stabilization, and/or they are land disposed.

1.3.2 Dispersed-Solids Processes

Acid leaching by dispersion of fine solids into the acid is performed in batch tanks. The untreated waste and the acid are mixed in the reaction tank to ensure effective contact between the solids and the acid. Following mixing, the suspension may be pumped to stirred holding tanks, where the leaching is allowed

to proceed to completion. The treated solids are then usually separated from the acid by filtration and further treated using stabilization, and/or they are land disposed.

1.4 Waste Characteristics Affecting Performance (WCAPs)

In determining whether acid leaching will achieve the same level of performance on an untested waste that it achieved on a previously tested waste and whether performance levels can be transferred, EPA examines the following waste characteristics: (a) the solid waste particle size, (b) the alkalinity of the waste, (c) the solubility of metal constituents in the acid, and (d) the concentration of leachable metals.

1.4.1 Solid Waste Particle Size

Both the solubility reaction rate of the acid with the hazardous metal constituents in the waste and the rate of transport of acid to and from the site of the hazardous constituents are affected by the size of the solid waste particles. The smaller the particles, the more rapidly they will leach because of the increased surface area of the waste that is exposed to the acid. If the particle size of the untested waste is greater than that of the tested waste, the system may not achieve the same performance. Grinding the untested waste may be required to reduce the particle size and achieve the same treatment performance, or it may be necessary to consider other, more applicable treatment technologies for treatment of the untested waste.

1.4.2 Alkalinity of the Waste

The neutralizing capacity (or alkalinity) of the waste solids affects the amount of acid that must be added to the waste to achieve and/or maintain the desired reactor pH. In addition to dissolving the waste contaminants, the acid will also dissolve some of the alkaline bulk solids; therefore, highly alkaline wastes require more acid or a stronger acid to maintain pH during treatment. If

the alkalinity in an untested waste is greater than that in a tested waste, the system may not achieve the same performance. Use of additional acid or a stronger acid may be required to compensate for the increased alkalinity and achieve the same treatment performance, or other, more applicable treatment technologies may need to be considered for treatment of the untested waste.

1.4.3 Solubility of the Metal Constituents in the Acid

The metal constituents must dissolve in the acid to form soluble salts for the process to be effective. Thus, the acid selected should be one that forms soluble salts for all of the constituents to be removed. If the solubility of a metal constituent(s) of concern in an untested waste is less than that of another constituent(s) of concern in a previously tested waste in the same acid, or less than the solubility of the same metal(s) tested with a different acid, the system may not achieve the same performance. Use of another acid may be required to increase the solubilities of the metal constituent(s) of concern and achieve the same treatment performance, or other, more applicable treatment technologies may need to be considered for treatment of the untested waste.

1.4.4 Concentration of Leachable Metals

The amount of leachable metals is a measure of the maximum fraction of the waste that can be expected to leach in the acid leaching system. A relatively low concentration of leachable metals implies that most of the waste will remain in the solid or slurry waste residues (i.e., it is nonleachable). If the concentration of leachable metals in the untested waste is significantly less than that in the tested waste, the system may not achieve the same performance. Use of a higher concentration of acid or a stronger acid may be required to leach less leachable components and achieve the same treatment performance, or other, more applicable treatment technologies may need to be considered for treatment of the untested waste.

1.5 Design and Operating Parameters

In assessing the effectiveness of the design and operation of an acid leaching system, EPA examines the following parameters: (a) the residence time, (b) the type and concentration of acid used, (c) the pH, and (d) the degree of mixing.

1.5.1 Residence Time

The extent of reaction and dissolution of the contaminants in the acid is directly related to the contact time. EPA monitors the residence time to ensure that sufficient time is provided to effectively leach the metal contaminants from the waste.

1.5.2 Type and Concentration of Acid Used

If the hazardous constituents to be removed in the acid leaching system are already present in the waste in soluble form, or are solubilized by pH reduction, then any acid that will reduce the pH to the desired value may be used. However, if chemical reaction is necessary to form soluble species, then the appropriate acid, as well as the appropriate concentration of the acid, must be used to ensure effective leaching of the metal constituents. EPA examines the type and concentration of acid used to ensure that the acid solution selected is capable of effectively leaching the metal constituents from the waste.

1.5.3 pH

For dispersed solids systems, the feed of acid to the leaching reactor is based on pH monitoring and control because the reaction rate is highly pH dependent. Therefore, a pH should be determined, based on the residence time and amount of hazardous metal constituents in the waste, that provides for complete dissolution of metal constituents. For percolation systems, pH monitoring of the acid percolating through the tank (i.e., leaving the system) should ensure that

enough acid is being added. EPA monitors the pH to ensure that the system is operating at the appropriate design conditions and to diagnose operational problems.

1.5.4 Degree of Mixing

Mixing provides greater contact between the acid and the solid waste particles, ensuring more rapid leaching of metal contaminants from the waste. The quantifiable degree of mixing is a complex assessment that includes, among other factors, the amount of energy supplied, the length of time the material is mixed, and the related turbulence effects of the specific size and shape of the tank. Although the exact degree of mixing is beyond simple measurement, EPA evaluates it by considering whether mixing is provided and whether the type of mixing device is one that could be expected to achieve uniform mixing of the waste solution.

1.6 References

Kirk-Othmer. 1978. Encyclopedia of chemical technology. Vol. 2, pp. 140-144. New York: John Wiley and Sons.

McCabe, L., and Smith, J. 1976. Unit operations of chemical engineering. 3rd ed., pp. 607-610. New York: McGraw-Hill Book Co.

Perry, R.H., and Chilton, C.H. 1973. Chemical engineers' handbook. 5th ed., pp. 19-41 to 19-43. New York: McGraw-Hill Book Co.

2. FILTRATION TECHNOLOGIES

2.1 Applicability

Filtration technologies (i.e., polishing filtration and sludge filtration) are used to remove particles from waste streams that are predominantly water or to remove water from wet solids and sludges.

Polishing filtration is a treatment technology applicable to wastewaters containing relatively low concentrations of solids (usually less than 1,000 mg/l). This type of filtration is typically used as a polishing step for the supernatant liquid following chemical precipitation and settling/clarification of wastewaters containing metal and other inorganic precipitates. Polishing filtration removes particles that are difficult to settle because of their size and/or density, as well as precipitated particles from an underdesigned settling system.

Sludge filtration, also known as sludge dewatering or cake-formation filtration, is a technology used on wastes that contain high concentrations of suspended solids, usually higher than 1 percent (10,000 mg/l). Sludge filtration is commonly applied to waste sludges, such as clarifier solids, for dewatering. Typically, these sludges can be dewatered to 19 to 50 percent solids concentration using this technology.

2.2 Underlying Principles of Operation

The basic principle of operation for sludge and polishing filtration is the removal/separation of particles from a mixture of fluid and particles by a medium that permits the flow of the fluid but retains the particles. Usually, the larger the particles, the easier they are to remove from the fluid.

Extremely small particles, in the colloidal size range, may not be removed or filtered effectively in a sludge or polishing filtration system and thus may

appear in the wastewater passing through the filter. To mitigate this problem, the wastewater can be treated prior to filtration to modify the particle size distribution and/or particle electrostatic charge by using appropriate precipitants, coagulants, flocculants, and filter aids. The selection of the appropriate precipitant and coagulant is important because they affect the type of waste particles formed. For example, lime (calcium hydroxide) precipitation usually produces larger, less gelatinous particles (which are easier to remove from aqueous wastes by using filtration) than does caustic soda (sodium hydroxide) precipitation. For particles that become too small or too highly charged to remove effectively, the use of coagulants and flocculants both decreases particle charge and increases the size of the particles. Also, if pumps are used, shear can be minimized by lowering the pump speed or using a low-shear type of pump. Excessive shear breaks up agglomerated particles, making them smaller and more difficult to filter. Filter aids such as diatomaceous earth are used to precoat cloth-type filter media and to provide an initial filter cake onto which additional solids can be deposited during the filtration process. The presence of the precoat aids in the removal of small particles from the solution being filtered. These particles adhere to, and are actually filtered by, the precoat solids during the filtration process.

2.3 Description of Filtration Processes

2.3.1 Polishing Filtration Processes

During polishing filtration, wastewater may flow by gravity or under pressure to the filter. The two most common polishing filtration processes are cartridge and granular bed filtration. Both processes remove particles that are much smaller than the pore size of the filter medium by straining, adsorption, and coagulation/flocculation mechanisms; these processes are also capable of producing an effluent with a low level of solids (typically less than 10 mg/l).

2.3.1.1 Cartridge Filtration

Cartridge filters can be used for relatively low waste feed flows. In this process, a hollow, cylindrically shaped cartridge with a matted cloth-type filter medium is placed within a sealed vessel. Wastewater is pumped through the cartridge wall until the flow drops excessively or until the pumping pressure becomes too high because of plugging of the filter medium. The sealed vessel is then opened, and the plugged cartridge is removed and replaced with a new cartridge. The plugged cartridge is then cleaned and/or disposed of. Cartridge filters can be assembled in a parallel arrangement to increase the overall system flow.

2.3.1.2 Granular Bed Filtration

For relatively large volume flows, granulated media such as sand, garnet, or anthracite coal are used singly or in combination to trap suspended solids within the pore spaces of the media. Dual and multimedia filter arrangements allow higher flow rates and efficiencies. Typical hydraulic loading rates range from 2 to 5 gal/sq ft-min for single-medium filters and from 4 to 8 gal/sq ft-min for multimedia filters.

In this process, wastewater is either gravity-fed or pumped through the granular bed media and filtered until either the flow drops excessively or the pumping pressure becomes too high because of plugging of the granular filter media. Granular media filters are usually cleaned by backwashing with previously filtered water in an upflow manner to expand the bed, loosen the media granules, and resuspend the entrapped filtered solids. The backwash water, which may be as much as 10 percent of the volume of the filtered wastewater, is then returned to the head of the wastewater treatment system so that the filtered solids in the backwash water can be settled out of solution and the water refiltered prior to discharge.

2.3.2 Sludge Filtration Process

For sludge filtration, waste is pumped through a cloth-type filter medium (also known as pressure filtration, such as that performed with a plate-and-frame filter); drawn by vacuum through the cloth or metal mesh medium (also known as vacuum filtration, such as that performed with a vacuum drum filter); or gravity-drained and mechanically pressed through two continuous fabric belts (also known as belt filtration, such as that performed with a belt filter press). In all cases, the solids "cake" builds up on the filter medium and acts as a filter for subsequent solids removal.

For a plate-and-frame filter, removal of the solids is accomplished by taking the unit off-line, opening the filter, and using mechanical or manual methods to scrape off the solids (a batch process). For the vacuum filter, cake is removed continuously by using an adjustable knife mechanism to scrape the sludge from the vacuum drum as the drum rotates. For the belt filter, the cake is continuously removed by a discharge roller and blade, which dislodge the cake from the belt. For a specific sludge, the plate-and-frame filter will usually produce the driest cake (highest percentage of solids). The belt filter produces a drier cake than does a vacuum filter, but usually not as dry as that produced by a plate-and-frame filter. Dewatered solids are further treated in processes such as sludge drying, incineration, solvent extraction (if treatable levels of organics are present), stabilization (if treatable levels of leachable metals are present), and/or disposal. The liquid filtrate that penetrates the filter medium is further treated in processes such as polishing filtration, carbon adsorption, and biological treatment, and/or it is disposed of.

2.4 Waste Characteristics Affecting Performance (WCAPs)

In determining whether polishing and sludge filtration will achieve the same level of performance on an untested waste as on a previously tested waste and whether performance levels can be transferred, EPA examines the following

waste characteristics: (a) the solid waste particle size and (b) the type of solid waste particles.

2.4.1 Solid Waste Particle Size

Extremely small particles, in the colloidal range, may not be filtered effectively in a polishing filter and thus may appear in the filtrate.

In sludge filtration, the smaller the particle size, the more the particles tend to go through the filter media. This is especially true for a vacuum filter. For a pressure filter (such as a plate and frame), smaller particles may require higher pressures for equivalent fluid throughput because the smaller pore spaces between particles collected on the filter medium create resistance to flow. If the solid waste particle size distribution of an untested waste is significantly lower than that of the tested waste, the system may not achieve the same performance. In practice, it is usually difficult to measure particle size accurately and representatively. However, it can be said that individual particles formed by chemical precipitation are typically much smaller than particles formed mechanically (e.g., by erosion, grinding, or abrasion). Pretreatment of the waste with coagulants and flocculants may be required to increase the particle sizes and achieve the same treatment performance, or other, more applicable treatment technologies may need to be considered for treatment of the untested waste.

2.4.2 Type of Solid Waste Particles

Some solids formed during metal precipitation are gelatinous in nature because of high levels of electrostatic charge. Such solids are difficult to filter by polishing filtration and may be impossible to dewater effectively by sludge filtration. In most cases, solids can be made less gelatinous by use of the appropriate coagulants and coagulant dosage prior to settling/clarification, or after settling/clarification but prior to filtration. In addition, the use of lime instead of caustic in chemical precipitation of metals reduces the

formation of gelatinous solids. Also, in the case of sludge filtration, adding filter aids, such as lime or diatomaceous earth, to a gelatinous sludge increases its filterability significantly. Finally, precoating filter media with diatomaceous earth prior to sludge filtration assists in dewatering gelatinous sludges. If solids in an untested waste are significantly more gelatinous than those in the tested waste, the system may not achieve adequate performance. Pretreatment of the waste with coagulants may be required to decrease the gelatinous nature of the waste and achieve the same treatment performance, or other, more applicable treatment technologies may need to be considered for treatment of the untested waste.

2.5 Design and Operating Parameters

In assessing the effectiveness of the design and operation of a polishing filtration system, EPA examines the following parameters: (a) the type and size of the filter; (b) the filtration pressure; (c) the amount and type of coagulants, flocculants, and filter aids used; (d) the hydraulic loading rate; and (e) the pore size of the filter media.

2.5.1 Type and Size of Filter

The type and size of the filtration system used is dependent on the rate of feed, the nature of the particles to be removed/separated, the desired solids concentration in the filtrate (usually just for polishing filtration) and in the filter cake (in sludge filtration), the amount and concentration of solids in the feed, and the required downtime for solids removal and maintenance. As noted earlier, with polishing filtration, cartridge filtration is limited to lower volume wastewaters and those with lower solids concentrations as compared to granular bed filtration. For granular bed filtration, when more than one medium is used (dual and multimedia filter arrangements such as sand, garnet, and anthracite coal), a higher capacity can be expected for the same size filter bed.

In sludge filtration, typically a pressure filter (such as a plate and frame) will yield a drier cake than a belt or vacuum filter and will also be more tolerant of variations in influent sludge characteristics. Pressure filters, however, are characterized by batch processes requiring downtime for solids removal. When cake is built up to the maximum depth physically possible (constrained by filter geometry) or to the maximum design pressure, the filtration system is taken off-line while the cake is removed. (An alternate unit can be put on-line while the other is being cleaned.) Belt and vacuum filters are continuous systems (i.e., cake discharges continuously), but each of these filters is usually much larger than a pressure filter with the same capacity.

For all filtration processes, the larger the filter, the greater its hydraulic capacity (overall throughput) and the longer the filter runs between solids removal. EPA examines the type and size of the filter chosen to ensure that it is capable of achieving effective filtration of the wastewater.

2.5.2 Filtration Pressure

Pressure impacts both the design pore size of the filter media and the design feed flow rate (hydraulic loading rate). The higher the feed pressure, the longer the run will be prior to solids removal in polishing filtration. In sludge filtration, at higher pressures the cake will be drier and the runs will usually be longer prior to cake discharge. However, for gelatinous solids, such as some metal hydroxides, excessive pressure may cause the solids to clog the filter pores and prevent additional polishing or sludge filtration. Also, high pressures may force particles through the filter medium, especially early in a filter run, resulting in ineffective filtration. In vacuum sludge filtration, the maximum amount of vacuum typically applied ranges from 20 to 25 inches of mercury. (The absolute maximum amount of vacuum that can theoretically be applied is 29.9 inches of mercury, or atmospheric pressure.) For belt filters, neither hydraulic pressure nor vacuum is applied to the waste feed (although mechanical pressure is applied). For plate-and-frame and vacuum filtration

systems, EPA monitors the filtration pressure (or vacuum) applied to the waste feed continuously, if possible, to ensure that the system is operating at the appropriate design condition and to diagnose operational problems.

2.5.3 Amount and Type of Coagulants, Flocculants, and Filter Aids

Coagulants, flocculants, and filter aids may be mixed with the waste feed prior to filtration. Coagulants and flocculants affect the type and size of the particles in the waste and, hence, their ease of removal. In vacuum filtration their effect is particularly significant since they may make the difference between no cake formation and the forming of a relatively dry cake. In a pressure filter, coagulants, flocculants, and filter aids can significantly improve overall throughput and cake dryness. Filter aids, such as diatomaceous earth, can be precoated on all sludge filters for particularly difficult-to-filter sludges (those containing a high concentration of gelatinous solids). The precoat layer acts somewhat like a filter in that sludge solids are trapped in the precoat pore spaces. In polishing filtration, filter aids both improve the effectiveness of filtering gelatinous particles and increase the time that the filter can stay on-line.

Coagulants, flocculants, and filter aids are particularly useful when the sludge (in the case of sludge filters) and wastewater (in the case of polishing filtration) have a high percentage of very small particles or when the concentration of solids in the waste feed or wastewater is low. Inorganic coagulants include alum, ferric sulfate, and lime. Organic flocculants, which are called polyelectrolytes, are anionic, cationic, or nonionic in nature. Diatomaceous earth is the most commonly used filter aid. The use of coagulants, flocculants, and filter aids increases the amount of solids requiring disposal. Polyelectrolyte flocculant usage, however, usually does not increase the solids volume significantly because the required dosage is relatively low. If the addition of coagulants, flocculants, and filter aids is required, EPA examines the amount and type added to the waste, along with their method of addition, to ensure effective dewatering and filtration.

2.5.4 Hydraulic Loading Rate

Lower hydraulic loading rates generally improve filtration performance. For sludge filtration, higher hydraulic loading rates for a given size filter yield greater overall throughput but result in the formation of wetter cakes (lower percent solids) and, for plate-and-frame filters, shorter cycle times. For polishing filtration, higher hydraulic loading rates yield greater throughput but result in shorter cycle times. EPA monitors the hydraulic loading rate to ensure effective dewatering and filtration of waste sludge and effective filtration of wastewater.

2.5.5 Pore Size of the Filter Media

For polishing filtration systems, the pore size of the filter media determines the particle size that will be effectively removed from the wastewater. EPA examines the pore size of the filter media to ensure effective filtration of wastewater. For sludge filters, the pore size and type relate to resistance to abrasion and corrosion.

2.6 References

- Anonymous. 1985. Feature report. Wastewater treatment. Chemical Engineering 92(18):71-72.
- Crain, R.W. 1981. Solids removal and concentration. In Third Conference on Advanced Pollution Control for the Metal Finishing Industry, pp. 56-62. Cincinnati, Ohio: U.S. Environmental Protection Agency.
- Eckenfelder, W.W., Jr., Patoczka, J., and Watkins, A. 1985. Wastewater treatment. Chemical Engineering, September 2, 1985.
- Kirk-Othmer. 1980. Encyclopedia of chemical technology. 3rd ed. Vol. 10. New York: John Wiley and Sons.
- Perry, R.H., and Chilton, C.H. 1973. Chemical engineers' handbook. 5th ed., Section 19. New York: McGraw Hill Book Co.

3. HIGH TEMPERATURE METALS RECOVERY

3.1 Applicability

High temperature metals recovery (HTMR) is a technology applicable to wastes containing metal oxides and metal salts (including cadmium, chromium, lead, nickel, and zinc compounds) at concentrations ranging from 10 percent to over 70 percent with low levels (i.e., below 5 percent) of organics and water in the wastes. There are a number of different types of high temperature metals recovery systems, which generally differ from one another in the source of energy used and the method of recovery. These HTMR systems include the rotary kiln process, the plasma arc reactor, the rotary hearth electric furnace system, the molten slag reactor, and the flame reactor.

HTMR is generally not used for mercury-containing wastes even though mercury will volatilize readily at the process temperatures present in the high temperature units. The retorting process is normally used for mercury recovery because mercury is very volatile and lower operating temperatures can be used. Thus, the retorting process is more economical than HTMR for mercury-bearing wastes. Retorting is discussed in Section II.B.5.

The HTMR process has been demonstrated on wastes such as baghouse dusts and dewatered scrubber sludge from the production of steels and ferroalloys. Zinc, cadmium, and lead are the metals most frequently recovered. The process has not been extensively evaluated for use with metal sulfides. The sulfides are chemically identical to natural minerals ordinarily present in ores used as feedstocks by primary smelters. Some sulfide-bearing wastes from the chrome pigments industry have been sent to such primary smelters. However, with sulfides, a possibility exists for formation of either carbon disulfide from reaction with carbon or sulfur dioxide from reaction with oxygen in the HTMR processes.

Metal halide salts are also not directly used in HTMR processes. They, however, may be converted to oxides or hydroxides, which are acceptable feedstocks for HTMR processes.

3.2 Underlying Principles of Operation

The basic principle of operation for HTMR is that metal oxides and salts are separated from a waste through a high temperature thermal reduction process that uses carbon, limestone, and silica (sand) as raw materials. The carbon acts as a reducing agent and reacts with metal oxides to generate carbon dioxide and free metal. The silica and limestone serve as fluxing agents. This process yields a metal product for reuse and reduces the concentration of metals in the residuals and, hence, the amount of waste that needs to be land disposed. An example HTMR reaction is the recovery of zinc, which proceeds as follows:

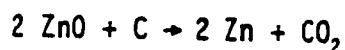

3.3 Description of High Temperature Metals Recovery Process

The HTMR process consists of a mixing unit, a high temperature processing unit (kiln, furnace, etc.), a product collection system, and a residual treatment system. A schematic diagram for a high temperature metals recovery system is shown in Figure 22.

The mixing unit homogenizes metal-bearing wastes, thus minimizing feed variations to the high temperature processing unit. Before the wastes are fed into the high temperature processing unit, fluxing agents and carbon can be added to the mixing unit and mixed with the wastes. The fluxes used (sand and limestone) are often added to react with certain metal components, preventing their volatilization and resulting in an enhanced purity of the desired volatile metals removed.

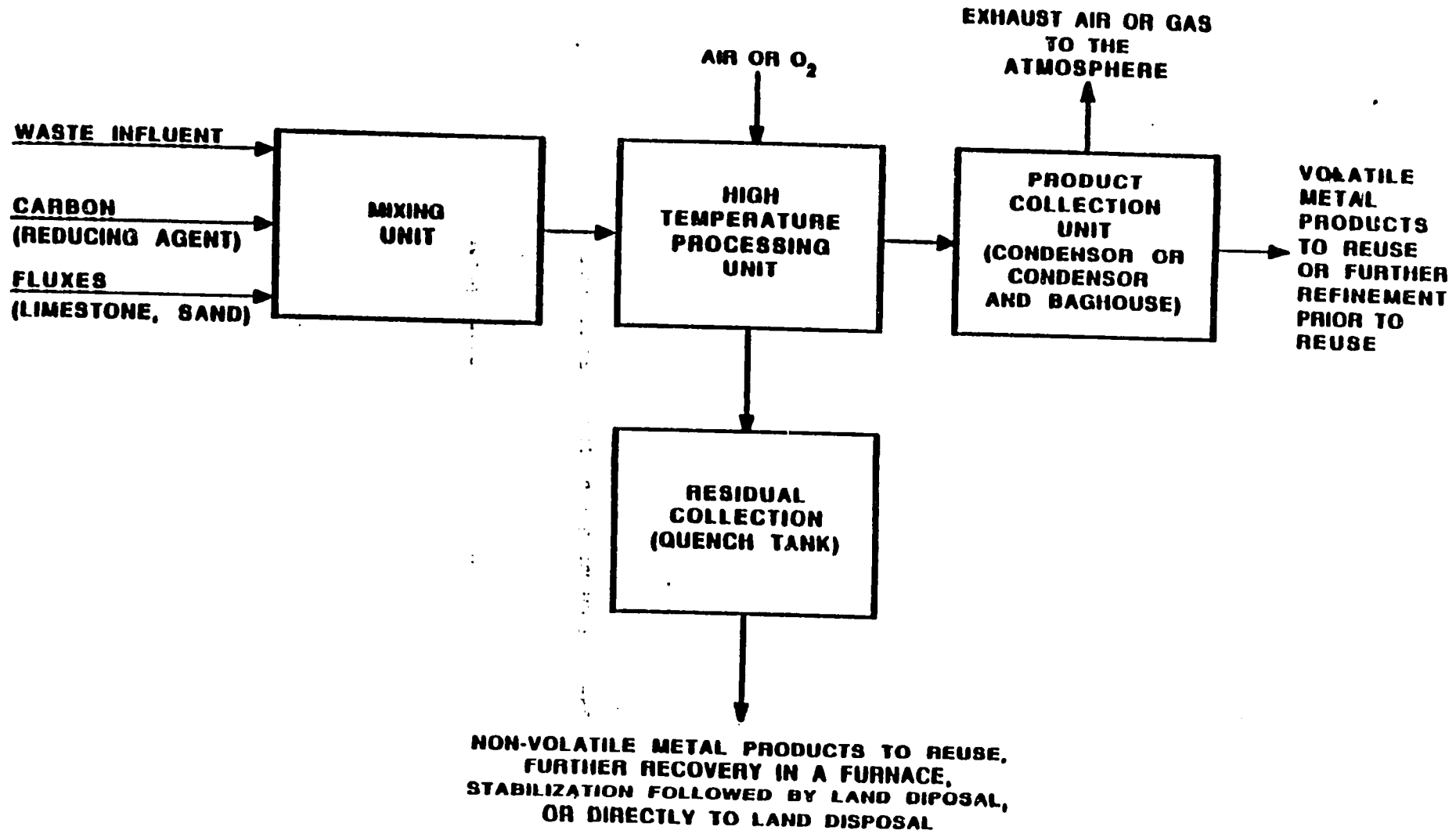

Figure 22 High Temperature Metals Recovery System

The blended waste materials are fed to a furnace, where they are heated to temperatures ranging from 1100 to 1400°C (2012 to 2552°F), resulting in the reduction and volatilization of the desired metals. The combination of temperature, residence time, and turbulence provided by rotation of the unit or addition of an air or oxygen stream helps ensure the maximum reduction and volatilization of metal constituents.

The product collection system can consist of either a condenser or a combination condenser and baghouse. The choice of a particular system depends on whether the metal is to be collected in the metallic form or as an oxide. Recovery and collection are accomplished for the metallic form by condensation alone, and for the oxide by reoxidation, condensation, and subsequent collection of the metal oxide particulates in a baghouse. There is no difference in these two types of metal recovery and collection systems relative to the kinds of waste that can be treated; the use of one system or the other simply reflects the facility's preference relative to product purity. In the former case, the direct condensation of metals allows for the separation and collection of individual metals in a relatively uncontaminated form; in the latter case, the metals are collected as a combination of several metal oxides.

The treated waste residual slag, containing higher concentrations of the less-volatile metals than the untreated waste, is sometimes cooled in a quench tank and (a) reused directly as a product (e.g., a waste residual containing mostly iron can be reused in steelmaking); (b) reused after further processing (e.g., a waste residual containing oxides of iron, chromium, and nickel can be reduced to metallic form and then recovered for use in the manufacture of stainless steel); (c) stabilized (material has no recoverable value) to immobilize any remaining metal constituents and then land disposed; or (d) directly land disposed as a slag.

3.4 Waste Characteristics Affecting Performance (WCAPs)

In determining whether high temperature metals recovery will achieve the same level of performance on an untested waste that it achieved on a previously tested waste and whether performance levels can be transferred, EPA examines the following waste characteristics: (a) the concentrations of undesirable volatile metals, (b) the metal constituent boiling points, and (c) the thermal conductivity of the waste.

3.4.1 Concentration of Undesirable Volatile Metals

Because HTMR is a recovery process, the product must meet certain purity requirements prior to reuse. If the waste contains other volatile metals, such as arsenic or antimony, which are difficult to separate from the desired metal products and whose presence may affect the ability to reuse the product or refine it for subsequent reuse, HTMR may not be an appropriate technology. If the concentration of undesirable volatile metals in the untested waste is significantly higher than that in the tested waste, the system may not achieve the same performance, and other, more applicable treatment technologies may need to be considered for treatment of the untested waste.

3.4.2 Metal Constituent Boiling Points

The greater the ratio of volatility of the waste constituents, the more easily the separation of these constituents can proceed. This ratio is called relative volatility. EPA recognizes, however, that the relative volatilities cannot be measured or calculated directly for the types of wastes generally treated by high temperature metals recovery. This is because the wastes usually consist of a myriad of components, all with different vapor pressure-versus-temperature relationships. However, because the volatility of components is usually inversely proportional to their boiling points (i.e., the higher the boiling point, the lower the volatility), EPA uses the boiling point of waste components as a surrogate waste characteristic for relative volatility. If the

differences in boiling points between the more volatile and less volatile constituents are significantly smaller in the untested waste than in the tested waste, the system may not achieve the same performance and other, more applicable treatment technologies may need to be considered for treatment of the untested waste.

3.4.3 Thermal Conductivity of the Waste

The ability to heat constituents within an HTMR process feed matrix is a function of the heat transfer characteristics of the individual feed components (coke, limestone, untreated waste, etc.). The constituents being recovered from the waste must be heated to near or above their boiling points in order for them to be volatilized and recovered. The rate at which heat will be transferred to the feed mixture is dependent on the mixture's thermal conductivity, which is the ratio of the conductive heat flow to the temperature gradient across the material. Thermal conductivity measurements, as part of a treatability comparison of two different wastes to be treated by a single HTMR system, are most meaningful when applied to wastes that are homogeneous (i.e., uniform throughout). As wastes exhibit greater degrees of nonhomogeneity, thermal conductivity becomes less accurate in predicting treatability because the measurement reflects heat flow through regions having the greatest conductivity (i.e., the path of least resistance) and not heat flow through all parts of the waste. Nevertheless, EPA believes that thermal conductivity may provide the best measure of performance of heat transfer. If the thermal conductivity of the untested waste is significantly lower than that of the tested waste, the system may not achieve the same performance and other, more applicable treatment technologies may need to be considered for treatment of the untested waste.

3.5 Design and Operating Parameters

In assessing the effectiveness of the design and operation of an HTMR system, EPA examines the following parameters: (a) the HTMR temperature, (b) the

residence time, (c) the degree of mixing, (d) the carbon content of the feed, and (e) the calcium-to-silica ratio of the feed.

3.5.1 HTMR Temperature

Temperature provides an indirect measure of the energy available (i.e., Btu/hr) to volatilize the metal waste constituents. The higher the temperature in the high temperature processor, the more likely it is that the constituents will react with carbon to form free metals and volatilize. The temperature must be equal to or greater than the boiling point of the metals being volatilized for recovery. However, excessive temperatures could volatilize less-volatile, undesirable metals into the product, possibly inhibiting the potential for reuse of the product. EPA monitors the HTMR processor temperature continuously, if possible, to ensure that the system is operating at the appropriate design condition (at or above the boiling point(s) of the metal or metals being recovered, but not so high that it volatilizes other unwanted constituents) and to diagnose operational problems.

3.5.2 Residence Time

The residence time affects the amount of volatile metals volatilized and recovered. It is dependent on the HTMR processor temperature and the thermal conductivity of the feed blend. EPA monitors the residence time to ensure that sufficient time is provided to effectively volatilize the volatile constituents for recovery.

3.5.3 Degree of Mixing

Effective mixing of the waste with coke, silica, and limestone is necessary to produce a uniform feed blend to the system. The quantifiable degree of mixing is a complex assessment that includes, among other things, the amount of energy supplied, the length of time the material is mixed, and the related turbulence effects of the specific size and shape of the tank or vessel. This is beyond the

scope of simple measurement. EPA, however, evaluates the degree of mixing qualitatively by considering whether mixing is provided and whether the type of mixing device is one that could be expected to achieve uniform mixing of the waste.

3.5.4 Carbon Content of the Feed

The amount of carbon added to the waste must be sufficient to ensure complete reduction of the volatile metals being recovered. EPA examines the basis for calculation of the amount of carbon added to the waste to ensure that sufficient carbon is being used in the feed blend to effectively reduce metal compounds.

3.5.5 Calcium-to-Silica Ratio of the Feed

The calcium-to-silica ratio in the feed blend must be controlled to limit precipitation of metallic iron in the high temperature processor. The iron forms as solid calcium iron silicate, which is very difficult to subsequently process into any useful material. Aluminum oxide will also undergo reactions with lime and silica to form calcium aluminosilicates, which will lower the density and increase the volume of slag generated.

Precipitates and modified slags affect the reduction, volatilization, and recovery of volatile metals by changing heat flow characteristics in the system and by undergoing secondary, high temperature chemical reactions with metal oxides in the feed, converting them to the previously noted inert metal silicates or silicoaluminates. The ratio of calcium to silica to be used is dependent on the waste composition. Generally, a one-to-one silica-to-calcium oxide ratio is highly desired, so amounts of limestone and sand need to be adjusted based on the calcium and silica content of the waste to achieve this ratio.

Excess lime may also be added to fix sulfur in the feed as calcium sulfate. This will prevent the volatile metals from reacting with sulfur to form metal

sulfides, thereby lowering the recovery of metals or oxides. EPA monitors the amounts of limestone and sand added to the waste to ensure that the calcium-to-silica ratio selected to maximize metal or oxide recovery is maintained during treatment.

3.6 References

- Center for Metals Production. 1985. Electric arc furnace dust--disposal, recycle and recovery. Pittsburgh, Pa.
- Duby, P. 1980. Extractive metallurgy. In Kirk-Othmer encyclopedia of chemical technology. 3rd ed. Vol. 9, p. 741. New York: John Wiley and Sons.
- Lloyd, T. 1980. Zinc compounds. In Kirk-Othmer encyclopedia of chemical technology. 3rd ed. Vol. 24, p. 824. New York: John Wiley and Sons.
- Maczek, H., and Kola, R. 1980. Recovery of zinc and lead from electric furnace steelmaking dust at Berzelius. Journal of Metals 32:53-58.
- Price, L. 1986. Tensions mount in EAF dust bowl. Metal Producing. February 1986.

4. ION EXCHANGE

4.1 Applicability

Ion exchange is a treatment technology applicable to (a) metals in wastewaters where the metals are present as soluble ionic species (e.g., Cr^{+3} and CrO_4^{-2}); (b) nonmetallic anions such as halides, sulfates, nitrates, and cyanides; and (c) water-soluble, ionic organic compounds including (1) acids such as carboxylics, sulfonics, and some phenols, at a pH sufficiently alkaline to yield ionic species, (2) amines, when the solution acidity is sufficiently acid to form the corresponding acid salt, and (3) quaternary amines and alkylsulfates.

4.2 Underlying Principles of Operation

Ion exchange, when used in hazardous waste treatment, is a reversible process in which hazardous cations and/or anions are removed from an aqueous solution and are replaced by nonhazardous cations and/or anions such as sodium, hydrogen, chloride, or hydroxyl ions. Ion exchange resins are cationic if they exchange positive ions (cations) and anionic if they exchange negative ions (anions). When the waste stream to be treated is brought into contact with a bed of resin beads (usually in a packed column), an exchange of hazardous ions for nonhazardous ions occurs on the surface of the resin beads. Initially, a nonhazardous ion is loosely bound to the surface of the resin. When a hazardous ion is near the resin, it is preferentially adsorbed to the surface of the resin (based on the differences in ionic potential), releasing the nonhazardous ion.

Cation exchange resins contain mobile positive ions, such as hydrogen (H^+) or sodium (Na^+), which are attached to immobile functional acid groups, such as sulfonic (SO_3^-) and carboxylic (COO^-) groups. Anion exchange resins have immobile basic ions, such as amine (NH_2^-), to which the mobile anions, such as hydroxyl (OH^-) or chloride (Cl^-), are attached.

Ion exchange material is contacted with the solution containing the ion to be removed until the active sites in the exchange material are partially or completely used up ("exhausted") by that ion. For example, a cation exchange resin (designated R^-) to which a mobile positive ion (N^+) is attached reacts with a solution of electrolyte (M^+X^-) as shown below:



After exhaustion, the resin is then contacted with a relatively low volume of a very concentrated solution of the exchange ion to convert ("regenerate") it back to its original form. The regeneration reaction may be written as follows:



For instance, in the case of a sodium-based resin, a strong solution of sodium chloride is typically the regenerant solution. The regenerant solution forces the previously removed ions back into solution. This relatively low volume solution, now highly concentrated with the contaminant ions, must then be treated prior to disposal for recovery or removal of the hazardous cation or anion contaminants. There will continue to be a high concentration of the regenerant ion (sodium in the above example) in the used regenerant solution because excess regenerant ion is necessary to force the contaminant ions back into solution. The direction and extent of the completion of the exchange reaction depend upon the equilibrium that is established between the ions in the solution (M^+X^-) and those in the exchange material (R^-N^+).

4.3 Description of Ion Exchange Process

Most ion exchange operations are conducted in packed columns. The aqueous solution to be treated is continuously fed to either the top or the bottom of the column. A typical fixed-bed ion exchange column consists of a vertical cylindrical pressure vessel with corrosion-resistant linings. If appropriate, a filter is installed at the inlet of the column to remove suspended particles

because they may plug the exchange resin. Spargers are provided at the top and bottom of the column to distribute waste flow. Frequently, a separate distributor is used for the regenerant solution to ensure an even flow. The resin bed, usually consisting of several feet of ion exchange resin beads, is supported by a screen near the bottom distributor or by a support bed of inert granular material. Externally, the unit has a valve manifold to permit downflow operation, upflow backwashing (to remove any suspended material), injection of the regenerant solution, and rinsing of any excess regenerant.

A typical process schematic for a basic two-step cation/anion ion exchange system is presented in Figure 23. The ion exchange system shown in this schematic includes a series treatment with separate cation and anion exchange systems. Some systems contain both anion and cation exchange resins in the same vessel. The pressure vessels used for ion exchange generally range in size from 2 to 6 feet in diameter for prepackaged modular systems, which typically handle 25- to 300-gpm flow rates, to a maximum custom size of 12 feet in diameter, which can handle flow rates up to 1,150 gpm. The height of these vessels varies between 6 and 10 feet to provide adequate resin storage, distribution nozzle layout, and freeboard capacity for bed expansion during backwashing. The nominal surface loading area of the ion exchange vessels ranges from 8 to 10 gpm per square foot.

4.4 Waste Characteristics Affecting Performance (WCAPs)

In determining whether ion exchange will achieve the same level of performance on an untested waste as on a previously tested waste and whether performance levels can be transferred, EPA examines the following waste characteristics: (a) the concentration and valence of the contaminant, (b) the concentration of competing ionic species, (c) the concentration of interfering inorganics and organics, (d) the concentrations of dissolved and suspended solids and oil and grease, and (e) the corrosiveness relative to the resin material.

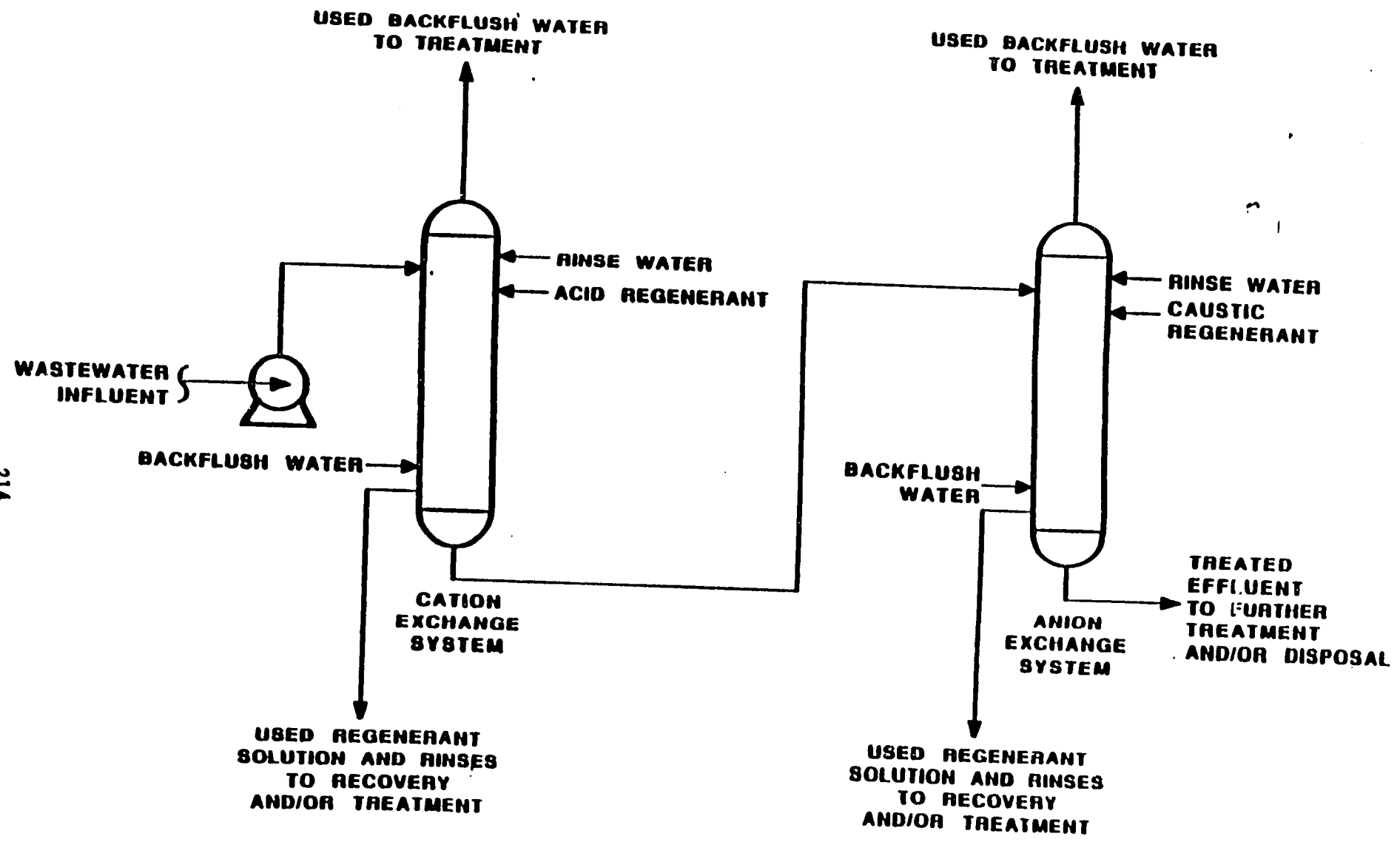

Figure 23 Two-Step Cation/Anion Ion Exchange System

4.4.1 Concentration and Valence of the Contaminant

As the concentration and valence of adsorbable ions in the wastewater increase, the size of the resin bed required will increase as well, or, alternatively, the bed will become exhausted more rapidly. This is because a given amount of ion exchange resin has a limited number of sites to adsorb charged ions. If, for example, the valence is doubled or the concentration of the adsorbed ions is doubled, the sites will be exhausted twice as quickly. Hence, very high concentrations of the waste may be inappropriate for ion exchange because of rapid site exhaustion, which could conceivably require regenerant volumes to be essentially equal to waste flow volumes. If the concentration and/or the valence of the contaminant in an untested waste is significantly higher than that of the tested waste, the system may not achieve the same performance. A larger exchange bed or more frequent regeneration may be required to exchange higher concentrations and/or higher valences of the contaminant and achieve the same treatment performance, or other, more applicable treatment technologies may need to be considered for treatment of the untested waste.

4.4.2 Concentration of Competing Ionic Species

The presence of other contaminants or ions in the wastewater can affect the performance of the ion exchange unit in removing the hazardous contaminant of concern. Other ions in the wastewater with the same charge as the contaminant of concern will compete for exchange sites on the resin. Also, ions with a higher valence will be preferentially adsorbed. While a low concentration of the contaminant of concern may be readily removed from a solution with a low concentration of other similarly charged ionic species, the contaminant may not be removed as efficiently from solutions where high concentrations of similarly charged ions exist, especially if those ions have a higher valence than that of the contaminants. If the ions of concern are removed from a solution with high concentrations of other similarly charged ions, the resin will become exhausted more rapidly because most resins cannot selectively adsorb one contaminant in a

solution containing other similarly charged ionic species. If the concentration of competing ionic species in an untested waste is significantly higher than that in the tested waste, the system may not achieve the same performance. A larger exchange bed or more frequent regeneration may be required to exchange higher concentrations of competing ionic species and achieve the same treatment performance, or other, more applicable treatment technologies may need to be considered for treatment of the untested waste.

4.4.3 Concentration of Interfering Inorganics and Organics

Interfering inorganics, such as iron precipitates, can accumulate in the pores of anion exchangers; these inorganics will physically break down or block the resin particles. Some organic compounds, particularly aromatics, can be irreversibly adsorbed by the exchange resins. Also, some ions tend to oxidize after they are removed from solution. For instance, Mn^{+2} (manganese) may oxidize to the insoluble Mn^{+4} state, thereby permanently fouling the exchange sites and requiring the premature replacement of the resin. If the concentration of interfering inorganics and organics in an untested waste is significantly higher than that in the tested waste, the system may not achieve the same performance and other, more applicable treatment technologies may need to be considered for treatment of the untested waste.

4.4.4 Concentrations of Dissolved and Suspended Solids and Oil and Grease

High concentrations of dissolved and suspended solids and oil and grease can affect the performance of ion exchange sites. Conventional ion exchange systems are usually downflow; i.e., the wastewater flows down through the resin bed. Regeneration is accomplished in either the downflow or upflow mode. If excessive concentrations of dissolved and suspended solids and/or oil and grease are present in the wastewater, the bed may clog and require backwashing prior to exhausting its exchange capacity. Backwashing may prove ineffective in the removal of some solids or oils. If the concentration of dissolved and suspended solids and/or oil and grease in an untested waste is significantly higher than

that in the tested waste, the system may not achieve the same performance and other, more applicable treatment technologies may need to be considered for treatment of the untested waste.

4.4.5 Corrosiveness

Some wastewaters are extremely corrosive to ion exchange resin materials, reducing efficiency or increasing downtime for maintenance and repair. For instance, strong solutions of chromates may oxidize many resins, requiring premature replacement. If the corrosiveness of the untested waste is significantly higher than that of the tested waste, the system may not achieve the same performance and other, more applicable treatment technologies may need to be considered for treatment of the untested waste.

4.5 Design and Operating Parameters

In assessing the effectiveness of the design and operation of an ion exchange system, EPA examines the following parameters: (a) the amount and type of resin, (b) the amount and type of regenerant solution, (c) the hydraulic loading, and (d) the exchange temperature.

For many hazardous organic constituents, analytical methods are not available or the constituent cannot be analyzed in the waste matrix. Therefore, it would normally be impossible to measure the effectiveness of the ion exchange system. In these cases EPA tries to identify measurable parameters or constituents that would act as surrogates to verify treatment.

For organic constituents, each compound contains a measurable amount of total organic carbon (TOC). Removal of TOC in the ion exchange system will indicate removal of organic constituents. Hence, TOC analysis is likely to be an adequate surrogate analysis where the specific organic constituent cannot be measured. However, TOC analysis may not be able to adequately detect treatment of specific organics in matrices that are heavily organic-laden (i.e., the TOC

analysis may not be sensitive enough to detect changes at the milligrams/liter (mg/l) level in matrices where total organic concentrations are hundreds or thousands of mg/d. In these cases other surrogate parameters should be sought. For example, if a specific analyzable constituent is expected to be treated as well as the unanalyzable constituent, the analyzable constituent concentration should be monitored as a surrogate.

4.5.1 Amount and Type of Resin

The main design parameter that affects the performance of ion exchange systems is the amount and type of resin used. Numerous cationic and anionic resins are commercially available. The selection of a resin is based on a variety of factors. Different resins have different exchange capacities, and some have greater affinity than others for specific ions. Certain resins are designed to tolerate corrosive, oxidizing, or high temperature solutions, so their exchange capacity does not degrade as rapidly with use. Most resins will effectively remove contaminant ions from solution until they become exhausted. However, if resin bed exhaustion occurs too frequently, or if regeneration requires excessive volumes of the regenerant, the type and/or amount of resin might need to be changed. In some instances, pretreatment technologies may be required prior to ion exchange. For most metals removal, cation resins are usually required. However, some metal complexes, such as copper cyanide ($\text{Cu}(\text{CN})_4^{-2}$), chromates (CrO_4^{-2}), and arsenates (AsO_4^{-3}), are anionic and require the use of anion exchange resins. EPA examines the amount and type of ion exchange resin in the treatment system to ensure that a sufficient amount of ion exchange resin is provided to effectively exchange the metal ions of concern.

4.5.2 Amount and Type of Regenerant Solution

For hydrogen-based cation exchangers, acid regenerant solutions are used (e.g., sulfuric, nitric, or hydrochloric acids). For sodium-based cation resins, sodium chloride is generally used. For anion exchange resins, alkali (commonly sodium hydroxide) is used to regenerate hydroxide-based resins. Sodium chloride

is used for chloride-based anion resins. EPA examines the amount and type of regenerant solution used to ensure that it is compatible with the resin and waste treated and that effective removal of the contaminant ions from the exchange resin is achieved.

4.5.3 Hydraulic Loading Rate

The amount of time that the wastewater contaminants are in contact in the ion exchange resin (i.e., residence time) impacts the extent to which ion exchange occurs. Higher residence times generally improve exchange performance, but require larger ion exchange beds to maintain the same overall throughput. For a given size ion exchange bed, the residence time can be determined by the hydraulic loading rate. Typical hydraulic loading rates for ion exchange systems range from 600 to 15,000 gal/day-ft². EPA monitors the hydraulic loading rate to ensure that sufficient time is provided to effectively exchange contaminants.

4.5.4 Exchange Temperature

High temperatures reduce resin life, requiring premature replacement. EPA monitors the temperature in an ion exchange column continuously, if possible, to ensure that the system is operating at the appropriate design condition and to diagnose operational problems. EPA has information showing that the high temperature limit for anionic resins may be approximately 60°C.

4.6 References

- De Renzo, D.J., ed. 1978. Unit operations for treatment of hazardous industrial wastes. Park Ridge, N.J.: Noyes Data Corporation.
- Dorfner, K. 1972. Ion exchangers: properties and applications. Ann Arbor, Mich.: Ann Arbor Science Publishers, Inc.
- Metcalf & Eddy, Inc. 1979. Wastewater engineering: treatment disposal reuse. 2nd ed. New York: McGraw-Hill Book Co.
- Patterson, J.W. 1985. Industrial waste treatment technology. 2nd ed. Stoneham, Mass.: Butterworth Publishers.
- Perry, R.H., and Chilton, C.H. 1973. Chemical engineers' handbook. 5th ed. New York: McGraw-Hill Book Co.
- Sundstrom, D.W., and Klei, H.E. 1979. Wastewater treatment. Englewood Cliffs, N.J.: Prentice-Hall, Inc.
- USEPA. 1982. U.S. Environmental Protection Agency. Development document for the porcelain enameling point source category. pp. 172-241. Washington, D.C.: U.S. Environmental Protection Agency.
- USEPA. 1983. U.S. Environmental Protection Agency. Treatability manual: Vol. III. Technology for control/removal of pollutants. EPA-600/2-82-001c. Washington, D.C.: U.S. Environmental Protection Agency.
- Wheaton, R.M. 1978. Kirk-Othmer encyclopedia of chemical technology. 3rd ed. Vol. 13. New York: John Wiley and Sons.

5. RETORTING

5.1 Applicability

Retorting is a treatment technology applicable to wastes containing elemental mercury, as well as mercury present in the oxide, hydroxide, and sulfide forms, at levels above 100 parts per million, provided that the waste has a low total organic content (i.e., below 1 percent). For metals other than mercury, the typical retort operating temperatures (700 to 1000°F) are not high enough to decompose the metal compounds. High temperature metals recovery (HTMR) processes must be used to recover most other metals when they are not present in the pure metal form.

For most retorting processes, there is an additional requirement that the waste have a low water content, preferably below 20 percent. Dewatering reduces energy consumption by minimizing the amount of water evaporated and precludes problems involving the separation of recovered metals from large quantities of water.

5.2 Underlying Principles of Operation

The basic principle of operation for retorting is a process similar to that for high temperature metals recovery in that it provides for recovery of metals from wastes primarily by volatilization and subsequent collection and condensation of the volatilized components. Retorting yields a metal product for reuse and significantly reduces the concentration of metals in the waste residual, and, hence, the amount of treated waste that needs to be land disposed. This technology is different from HTMR in that HTMR includes a reduction reaction involving the use of carbon, while retorting does not use a reducing agent. Additionally, this process differs with regard to the form and, possibly, the leachability of the residue generated; HTMR generates a slag, while retorting generates a granular solid residue that may have lower leachability than a slag if mercury is the only constituent of concern present in the untreated waste.

The basic principle of operation of retorting is that sufficient heat must be transferred to the waste to cause elemental metals to vaporize. In the case of mercury present as an oxide, hydroxide, or sulfide compound, sufficient heat must be transferred to the waste to first decompose the compounds to the elemental form and then volatilize the mercury. In mercury wastes that are wastewater treatment sludges, mercury is most often present in the form of the sulfide (HgS) as a result of the use of sodium hydrosulfide treatment of mercury-bearing wastewaters. In a few instances, hydrazine is used to treat these same wastewaters; in such instances, a mercurous hydroxide sludge is generated. This latter compound can be more easily treated to yield elemental mercury because this reaction occurs more readily than the sulfide decomposition at the temperatures at which the process is normally operated. Preheated air is provided to the retort to supply the oxygen necessary for the sulfide decomposition and to enhance the heat transfer to the waste.

The equations for decomposition of both forms of mercury are presented below:

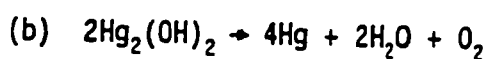
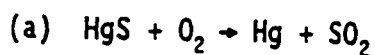

5.3 Description of Retorting Process

The retorting process generally consists of a retort (typically an oven, i.e., multiple hearth furnace or rotary kiln) in which the waste is heated to volatilize the metal constituents, a condenser, a metals collection system, and an air pollution control system. Figures 24 and 25 show a retort system without and with a scrubber-type air pollution control system.

Trays of wastes are placed in the retort, where they are heated, and decomposition of mercury compounds and volatilization of the metallic mercury and

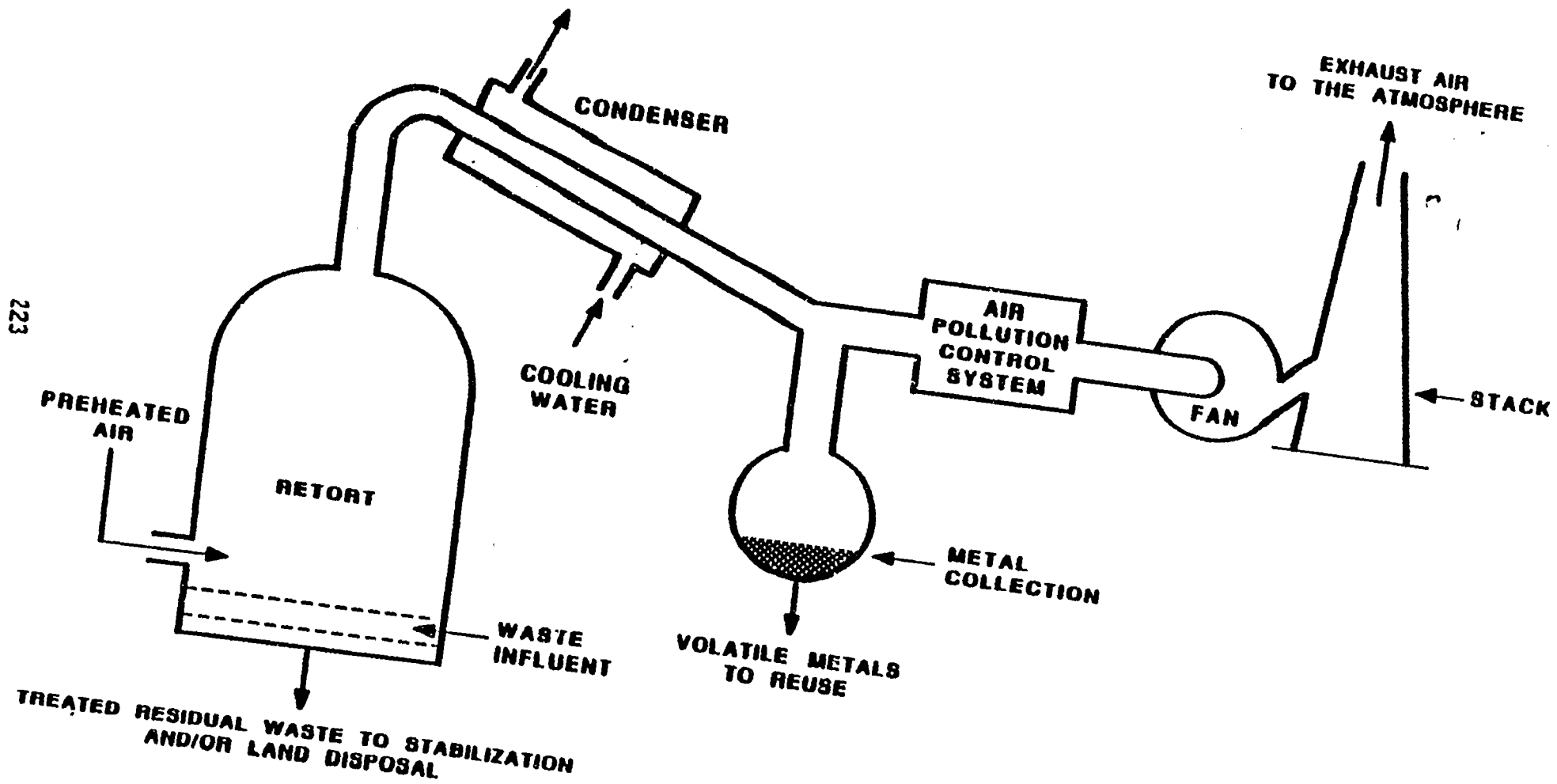

Figure 24 Retorting Process (Without a Scrubber and Subsequent Wastewater Discharge)

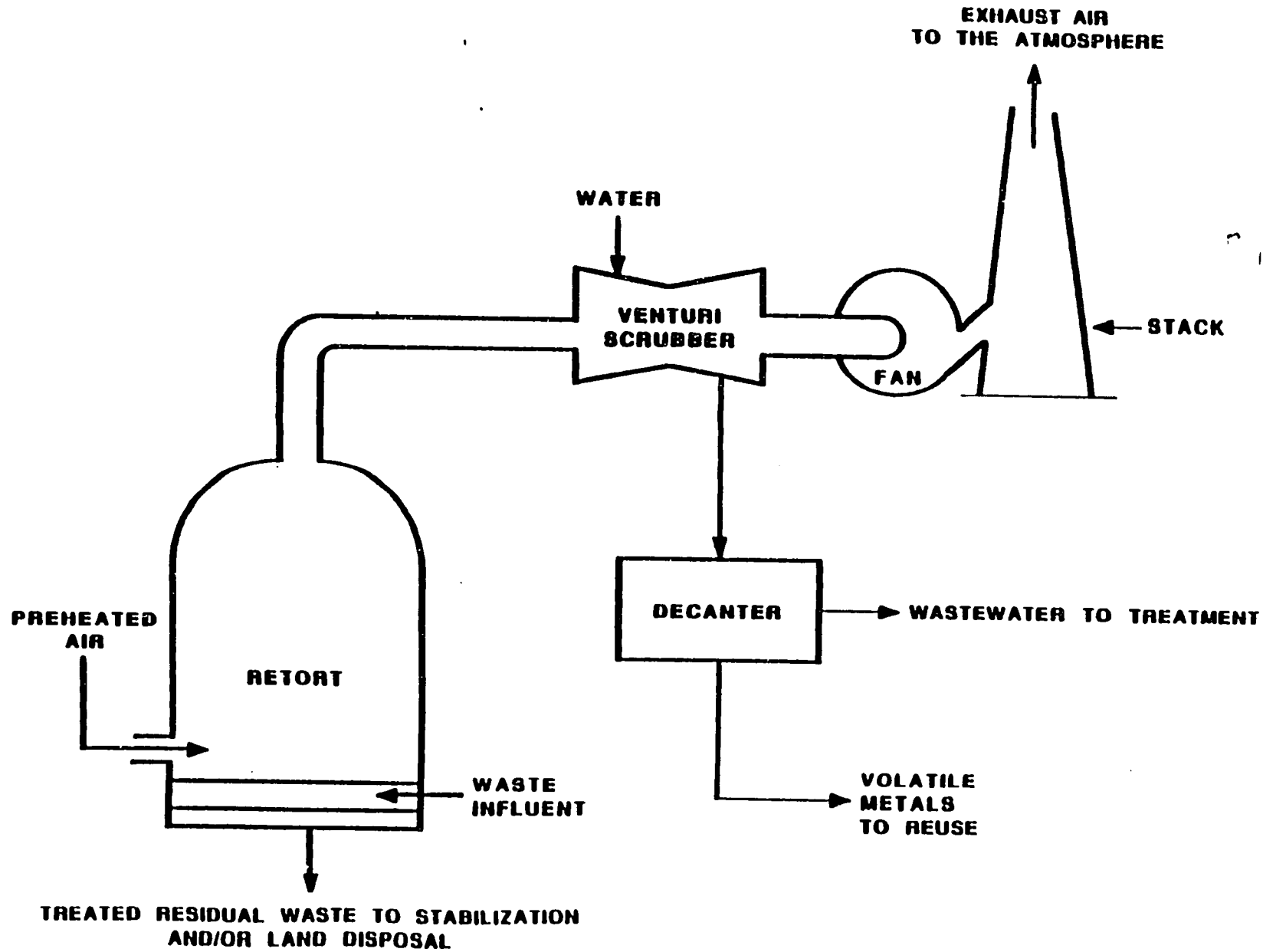

Figure 25 Retorting Process (With a Scrubber and Subsequent Wastewater Discharge)

other volatile elemental metals occur. Although most commonly carried out in an oven, retorting can also be performed in a multiple hearth furnace.

The vapor stream from the retort is cooled in a condenser. If a scrubber is not used as an air pollution control device, an electrostatic precipitator is provided after the condenser to remove any residual metal in the exhaust vapor stream, as well as to control other potential emissions such as sulfur dioxide (SO₂), fly ash, and hydrogen chloride (HCl) vapors. Condensed metal is collected for reuse before the electrostatic precipitator.

Residual solids remaining in the retort, stripped of volatile metal contaminants, are collected and may be either directly land disposed or stabilized, to immobilize any remaining metal constituents, and then land disposed.

5.4 Waste Characteristics Affecting Performance (WCAPs)

In determining whether retorting will achieve the same level of performance on an untested waste that it achieved on a previously tested waste and whether performance levels can be transferred, EPA examines the following waste characteristics: (a) the concentration of undesirable volatile constituents in the waste and (b) the thermal conductivity of the waste.

5.4.1 Concentration of Undesirable Volatile Constituents

Because retorting is a recovery process, its product must meet certain purity requirements prior to reuse. If the waste contains other volatile constituents with boiling points equal to or below that of the metal(s) to be recovered, they will be volatilized and condensed along with the desired metal(s) present in the waste. These constituents may be difficult to separate from the recovered product and may affect the ability to reuse the product metal or refine it for subsequent reuse. Undesirable volatile constituents sometimes present in mercury-bearing wastes include (a) mercury chlorides, which distill unchanged in

the retorting process, and other volatile metal halides; (b) arsenic oxide and arsenic trichloride; and (c) organomercury compounds, such as phenylmercuric acetate, which are not decomposed to elemental mercury by the retorting process.

For wastes containing significant levels (i.e., above 1 percent) of these contaminants, retorting may not be an appropriate technology. If the concentration of undesirable volatile constituents in the untested waste is significantly higher than that in the tested waste, the system may not achieve the same performance. Chemical pretreatment may be required to convert mercury chlorides and organomercury compounds to mercuric sulfide and/or elemental mercury and achieve the same treatment performance, or other, more applicable treatment technologies may need to be considered for treatment of the untested waste.

5.4.2 Thermal Conductivity of the Waste

The ability to heat constituents within a waste matrix is a function of the heat transfer characteristics of the waste material. Mercury and other recoverable metals in the waste must be heated to near or above their boiling points in order to be volatilized and recovered. The rate at which heat will be transferred to the waste material is dependent on the material's thermal conductivity, which is the ratio of the conductive heat flow to the temperature gradient across the material. Thermal conductivity measurements, as part of a treatability comparison of two different wastes to be treated by a single retort system, are most meaningful when applied to wastes that are homogeneous (i.e., uniform throughout). As wastes exhibit greater degrees of nonhomogeneity, thermal conductivity becomes less accurate in predicting treatability because the measurement reflects heat flow through regions having the greatest conductivity (i.e., the path of least resistance) and not through all parts of the waste. Nevertheless, EPA believes that thermal conductivity may provide the best measure of performance of heat transfer. If the thermal conductivity of the untested waste is significantly lower than that of the tested waste, the system may not

achieve the same performance and other, more applicable treatment technologies may need to be considered for treatment of the untested waste.

5.5 Design and Operating Parameters

In assessing the effectiveness of the design and operation of a retort system, EPA examines the following parameters: (a) the retorting temperature and (b) the residence time.

5.5.1 Retorting Temperature

Temperature provides an indirect measure of the energy available (i.e., Btu/hr) to vaporize the metal of concern. The higher the temperature in the retort, the more likely it is that the metal will volatilize. The temperature must be equal to or greater than the boiling point of the metal. However, excessive temperatures could volatilize undesirable constituents into the product, possibly inhibiting its potential reuse, and also could cause sintering of the feed material. For mercury retorting, EPA monitors the retort temperature to ensure that the system is operating at the appropriate design condition (a temperature at least equal to the boiling point of mercury (674°F) but below 1000°F) and to diagnose operational problems.

5.5.2 Residence Time

The residence time impacts the amount of volatile metal volatilized and recovered. It is dependent on the retort temperature and the thermal conductivity of the waste. Typical residence times in retort systems for mercury range from 4 hours to 20 hours. EPA monitors the residence time to ensure that sufficient time is provided to effectively volatilize all of the mercury and/or other metals to be removed from the waste.

5.6 References

- Occidental Chemical Corp. 1987. Delisting petition, chloralkali plant, Muscle Shoals, Alabama. Submitted to U.S. Environmental Protection Agency, July 20, 1987.
- Perry, R.A. 1984. Mercury recovery from contaminated wastewaters and sludges. PB 238 600.
- Sittig, M. 1975. Resource recovery and recycling handbook of industrial wastes. Park Ridge, N.J.: Noyes Publications.
- Versar. 1987. Waste minimization audit report - case studies of minimization of mercury bearing wastes from chloralkali plants. Prepared for U.S. Environmental Protection Agency, Office of Research and Development, Hazardous Waste Engineering Research Laboratory by Versar Inc., Contract No. 68-01-7053.

III. TECHNOLOGIES APPLICABLE TO MIXED WASTE
(RADIOACTIVE/HAZARDOUS)

Introduction

This section describes the treatment technologies applicable to mixed waste (i.e., waste that is both radioactive and hazardous). This introduction explains what mixed wastes are and how they are classified, where they are likely to be generated, and how they are regulated. Following this introduction are sections discussing (a) technologies for treating mixed wastes containing organics and inorganics other than metals, (b) technologies for treating mixed wastes containing metals, and (c) technologies for treating mixed wastes that cannot be treated by technologies determined to be BDAT for the corresponding nonradioactive wastes (i.e., special mixed wastes treatability group). Each of these three sections includes subsections describing applicable treatment technologies.

Mixed wastes are those wastes that satisfy the definition of radioactive waste subject to the Atomic Energy Act (AEA) and that also contain waste that either is listed as a hazardous waste in Subpart D of 40 Code of Federal Regulations (CFR) Part 261 or exhibits any of the hazardous waste characteristics identified in Subpart C of 40 CFR Part 261. Because they are hazardous, mixed wastes are subject to the Resource Conservation and Recovery Act (RCRA) Land Disposal Restrictions. All promulgated treatment standards for RCRA listed and characteristic wastes apply to the RCRA mixed wastes unless EPA has specifically established a separate treatability group for a specific category of mixed waste (see following Section C). Although mixed wastes are regulated by EPA under RCRA, the specific standards for radioactive material management developed under the AEA are administered by the Department of Energy (DOE) for government-owned facilities and by the Nuclear Regulatory Commission (NRC) for commercially owned facilities. The majority of mixed wastes can be divided into the following three categories based on the radioactive component of the waste: (a) low-level wastes, (b) transuranic (TRU) wastes, and (c) high-level wastes. Low-level wastes include radioactive waste that is not classified as spent fuel from commercial nuclear power plants or as defense high-level radioactive waste from the production of weapons. TRU wastes are those wastes containing elements with

an atomic number greater than 92 (the atomic number for uranium). TRU wastes generally pose greater radioactivity hazards than low-level wastes because they contain long-lived alpha radiation emitters. However, commercial transuranic waste is included as low-level radioactive waste. High-level mixed wastes have high levels of radioactivity and are extremely dangerous to handle. High-level mixed wastes are generated from the reprocessing of irradiated fuel rods from commercial and military nuclear reactors.

Mixed low-level wastes are generated principally from nuclear power plants, the Department of Energy (DOE), and academic and medical institutions. Some examples of low-level mixed wastes include spent solvents containing suspended or dissolved radionuclides, scintillation cocktails from diagnostic procedures, spent Freon used for cleaning protective garments, acetone or solvents used for cleaning pipes or other equipment, and still bottoms from the distillation of chlorofluorocarbon solvents (CFCs). Other wastes in this category include a wide range of solid materials such as spent ion-exchange resins (contaminated with various metals), filters used in reclaiming CFCs, adsorbents, residues from the cleanup of spills, lead shields, lead-lined containers, welding rods, and batteries. Also, the production of military weapons produces large amounts of wastes that fall into the low-level and TRU categories of mixed waste.

A. TECHNOLOGIES FOR MIXED WASTES CONTAINING ORGANICS AND INORGANICS OTHER THAN METALS

The following technologies have been determined to be applicable for treating mixed waste. These technologies were described in detail in previous sections in this document for hazardous wastes that are not mixed. Technologies for mixed waste operate under the same principles of operation used for treating nonmixed waste. However, with mixed waste these technologies typically separate the hazardous waste components from the radioactive components, thereby reducing the volume of the radioactive component requiring treatment, or immobilize the waste (in the case of stabilization technologies). If the hazardous component is also radioactive (e.g., a hazardous solvent whose structure contains radioactive carbon), that component may sometimes be removed from the waste, leaving a less hazardous, less radioactive residual.

1. Carbon Adsorption

For organic low-level mixed wastes, carbon adsorption may be used to remove organics in wastewaters. If the organic component is not radioactive, then this treatment reduces the quantity of the hazardous waste component in the mixed waste.

2. Distillation Technologies

A distillation technology such as batch distillation, steam stripping, fractionation, thin film evaporation, or thermal drying may be applied to a mixed waste in that it can be used to separate the mixed waste into the hazardous and radioactive waste components, as long as the hazardous component is not also radioactive. The separation can be made where the volatility of the hazardous components is significantly different from the volatility of the radioactive components. The distillation process will remove the more volatile organic components, leaving the less volatile constituents in the still bottoms.

3. Extraction Technologies

As with distillation, extraction technologies (i.e., solvent extraction and critical fluid extraction) may be used to separate a mixed waste into its radioactive and hazardous components if either the hazardous or the radioactive components can be selectively extracted by the extracting solvent.

B. TECHNOLOGIES FOR MIXED WASTES CONTAINING METALS

1. Acid Leaching

Acid leaching may be used to extract hazardous metals (regardless of whether the metals are radioactive) from mixed wastes, principally soils, separating the material into its hazardous and radioactive components or removing the hazardous and radioactive component from the rest of the waste. This process may have greater utility when combined with unit operations such as ion exchange, solvent extraction, chemical precipitation, and filtration.

2. Chemical Precipitation

Chemical precipitation may be applicable to mixed wastes for separating hazardous metals and/or hazardous metal radionuclides from other constituents in wastewaters. Specific conditions of pH, temperature, and precipitating reagent addition are required to selectively remove part or all of the radioactive components as a precipitate.

3. Filtration

Filtration technologies may be used following precipitation and settling processes to separate low-level mixed waste from high-level mixed waste. Hence, filtration may concentrate the high-level waste components in the filter cake, leaving a relatively low-level filtrate.

4. High Temperature Metals Recovery

The high temperature metals recovery (HTMR) process may be applicable to mixed wastes if the volatility of the radioactive metal component is significantly different from that of the nonradioactive portion. This technology is similar to distillation of organics, but instead "distills" more volatile inorganic components from less volatile ones.

5. Ion Exchange

Ion exchange treatment may be used to separate a mixed waste into its radioactive and hazardous constituents if the radioactive components are ionic. It will also concentrate the radioactive ionic species into a small volume, leaving a nonradioactive aqueous phase. The principal mixed waste application of this process is to recover metallic radionuclides from wastewaters or acid leach liquors. If more than one radionuclide exists in solution, it may be necessary to use either a mixed bed ion exchange unit or different types of ion exchange resins to recover all the radionuclides.

6. Stabilization of Metals

Stabilization refers to a broad class of treatment processes that immobilize hazardous constituents in a waste. For treatment of metals in low-level mixed wastes and for some TRU wastes containing low-level radioactive components, stabilization technologies will reduce the leachability of the hazardous metal constituents (regardless of whether the metals are radioactive) in nonwastewater matrices. However, EPA does not believe that stabilization using cementitious binders is an appropriate treatment for high-level radioactive mixed wastes generated during the reprocessing of fuel rods. It does not adequately immobilize the high-level radioactive portion of the mixed wastes.

C. TECHNOLOGIES FOR MIXED WASTES IN SPECIAL TREATABILITY GROUPS

1. Amalgamation

Amalgamation is applicable to radioactive wastes containing mercury and particularly to wastes containing radioactive mercury isotopes. Mercury compounds are converted into a solid mercury-zinc alloy, which is more easily managed and less mobile than solutions containing radioactive mercury. The process can be used directly with radioactive wastes provided that additional precautions are taken to prevent release of radioactive materials and to protect operations from radioactive emissions.

The Agency has established amalgamation as a method of treatment for mixed wastes containing elemental mercury. These types of wastes are typically found in vacuum pumps and related manometers. In the nuclear industry, this form of mercury has been contaminated with radioactive tritium (a radioisotope of hydrogen).

EPA has determined that amalgamation not only provides a significant reduction in air emissions of mercury but also provides a change in mobility from liquid mercury to a paste-like solid, potentially reducing leachability. The required method of treatment, i.e., amalgamation, may be performed using any of the following elements: zinc, copper, nickel, gold, and sulfur. Further information on the amalgamation process may be found in Section I.B.1.

2. Encapsulation

Encapsulation processes such as plastic and asphalt encapsulation may be used for the management of mixed wastes. However, the equipment used for mixing of the wastes with molten encapsulating agents must be of special design to protect workers from radioactive hazards. Additional precautions may be needed to prevent generation of airborne particulates or vapors of radioactive material

during the processing. More information on encapsulation may be found in the encapsulation section (see Section I.B.3).

c.

The Agency has established a treatment standard of macroencapsulation (encapsulating an entire mass, rather than microencapsulation, which coats individual particles of a waste) as a method of treatment for radioactive lead solids. This treatment standard applies to all forms of radioactive mixed waste containing elemental lead (including discarded equipment containing elemental lead that served as personnel or equipment shielding prior to becoming a RCRA hazardous waste). These lead solids do not include treatment residuals such as hydroxide sludges, other wastewater treatment residuals, or incinerator ash, which are usually amenable to conventional pozzolanic stabilization, nor do they include organolead materials that can be incinerated and then stabilized as ash.

3. Vitrification

Vitrification is a treatment technology that will provide effective immobilization of the inorganic constituents (i.e., both radioactive and hazardous components) of a mixed waste. Vitrification has been demonstrated to be an effective treatment technology for high-level mixed waste generated during the reprocessing of fuel rods. Since vitrification is a high-temperature process, small quantities of organics that may be present will be volatilized during the vitrification process. If there are gamma-emitting radionuclides present, the gamma dose rate will be reduced as a result of the increase in density of the vitrified matrix (going from the density of soil or other solids to the density of glass). If radium is present, the radon flux rate will also be reduced because of the change in the density. Both alpha and beta emitters will be sealed in the glass matrix. More information on the vitrification process may be found in the vitrification section (see Section I.B.5).

4. Incineration

Incineration is a technology applicable to nonradioactive elemental mercury (i.e., retorting) waste containing high levels of organics. The Agency has determined that incineration is also an applicable technology for mercury-containing hydraulic oil contaminated with radioactive material (low-level mixed waste) and has set incineration as the standard (method of treatment) for that waste. Incineration of radioactive mercury and other volatile mixed waste components is likely to cause the mercury or other volatile components to volatilize. Therefore, incinerators must be equipped with air pollution control devices to ensure that any volatilized hazardous and/or radioactive components are not released to the atmosphere above permitted levels. Incineration of organic wastes containing concentrations of the radionuclides tritium and carbon 14 will cause the escape of radioactive compounds since the combustion products of tritium (radioactive hydrogen) and carbon 14 are steam and carbon dioxide, respectively, both of which will usually escape conventional air pollution control devices.

References

- U.S. Congress, Office of Technology Assessment. 1989. Partnerships under pressure: managing commercial low-level radioactive waste. Washington, D.C.: U.S. Government Printing Office. OTA-O-426.
- USEPA. 1990. U.S. Environmental Protection Agency. Federal Register Notice, 55 FR 22626, June 1, 1990.
- U.S. General Accounting Office. 1989. Fact sheet for the Chairman, Environment, Energy, and Natural Resources Subcommittee, Committee on Government Operations, House of Representatives; Nuclear Waste, DOE's program to prepare high-level radioactive waste for final disposal. Washington, D.C.: U.S. General Accounting Office.
- U.S. General Accounting Office. 1989. Report to the Chairman, Committee on Governmental Affairs, U.S. Senate; Nuclear Regulation, the military would benefit from a comprehensive waste disposal program.
- Westinghouse Electric Corp. 1983. Waste technology reprints: Nuclear waste management in the United States.

APPENDIX A

LIST OF BEST DEMONSTRATED AVAILABLE TECHNOLOGY (BDAT)
BACKGROUND DOCUMENTS AND ASSOCIATED BDAT(S)

This appendix contains a list of BDAT background documents prepared for EPA's Office of Solid Waste, Waste Treatment Branch, in support of the Land Disposal Restrictions. (The specific Third under which each document was prepared is also noted.) This appendix is meant to be a quick reference, however, for details on a specific waste code see the relevant background document for that waste code. In summary, this appendix presents the following:

- The waste codes, industries, or sources of the waste associated with each background document.
- The treatment technologies on which the treatment standards were based i.e., BDAT. The BDAT associated with each background document is also identified. (Note that BDAT(s) may vary for individual waste codes contained in a background document. For specific information on the BDAT applicable to a certain waste code, see the applicable background document.)
- The source of the treatment data used to set the treatment standard and whether the data were collected or submitted to EPA (actual data) or transferred from existing data.
- The category of waste treated (i.e., organics, inorganics, metals).

LIST OF BDAT BACKGROUND DOCUMENTS AND ASSOCIATED BDAT(S)

Third	Waste Code/ (Background Document)	Industry or Source of Waste	BDAT(s)	Actual Data or Transferred and Origin of Data	Types of Wastes Regulated
1/3	F001-F005 (revised for methylene chloride)	Pharmaceutical Industry	Steam stripping (wastewaters)	Data/industry-submitted	Methylene chloride
1/3	F006	Electroplating operations	Stabilization (nonwastewaters)	Data/industry-submitted	Metals, cyanides
1/3	K001	Wood preserving Industry	Rotary kiln incineration, Stabilization (nonwastewaters, wastewaters); chemical precipitation (metals in wastewaters)	Data/EPA test, transfer/F006	Organics, metals
1/3	K015	Distillation of benzyl chloride	Liquid injection incineration (nonwastewaters); chemical precipitation (wastewaters)	Transfer/K019	Organics, metals
1/3	K016, K018, K019, K020, K030	Chlorinated organics production	Rotary kiln incineration (nonwastewaters, wastewaters)	Data/EPA test	Organics
1/3	K022	Phenol/acetone production	Fuel substitution, atabilization (nonwastewaters)	Data/industry-submitted, transfer/F006	Organics, metals
1/3	K024	Phthalic anhydride production	Rotary kiln incineration (nonwastewaters, wastewaters)	Data/EPA test	Phthalic acid
1/3	K037	Disulfoton production	Rotary kiln incineration (nonwastewaters, wastewaters)	Data/EPA test	Disulfoton, toluene
1/3	K044, K045, K047	Manufacturing and processing of explosives	Open burning/Open detonation, incineration (nonwastewaters)	Data/DOD	Reactive waste from K044, K045, K047
1/3	K046 (nonreactives)	Lead-based initiating compounds production	Stabilization (nonwastewaters)	Data/EPA test	Lead (metals)

LIST OF BDAT BACKGROUND DOCUMENTS AND ASSOCIATED BOAT(S)

Third	Waste Code/ (Background Document)	Industry or Source of Waste	BDAT(s)	Actual Data or Transferred and Origin of Data	Types of Wastes Regulated
1/3	K048-K052	Petrol refining industry	Solvent extraction, fluidized bed incineration, stabilization (nonwastewaters); incineration, chromium reduction, chemical precipitation, and filtering (wastewaters)	Data/industry-submitted	Organics, metals, inorganics
1/3	K061	Primary steel production industry	High temperature metals recovery for high zinc subcategory, stabilization for low zinc subcategory	Data/EPA test	Metals
1/3	K062	Steel finishing from iron and steel production	Chromium reduction, chemical precipitation, settling, filtering (nonwastewaters, wastewaters)	Data/EPA test	Metals
1/3	K069	Secondary lead smelting operations	Recycling (noncalcium sulfate category); (nonwastewaters)	Data/industry-submitted	Metals
1/3	K071	Chlorine production from the mercury cell process	Acid leaching, chemical oxidation sludge dewatering/acid washing (nonwastewaters), chemical precipitation and filtering (wastewaters)	Data/industry-submitted	Mercury
1/3	K083	Distillation bottoms from aniline production	Liquid injection incineration (nonwastewaters, wastewaters)	Data/industry-submitted	Organics
1/3	K086	Solvent washes and sludges from the production of inks, pigments, soaps, and stabilizers	Liquid injection incineration (nonwastewaters, wastewaters); chromium reduction, chemical precipitation, settling, filtering (wastewaters)	Data/EPA test, transfer/K062	Organics, metals

A-3

LIST OF BDAT BACKGROUND DOCUMENTS AND ASSOCIATED BDAT(S)

Third	Waste Code/ (Background Document)	Industry or Source of Waste	BDAT(s)	Actual Data or Transferred and Origin of Data	Types of Wastes Regulated
1/3	K087	Tar sludge from coking operations	Rotary kiln incineration (nonwastewaters); chromium reduction, chemical precipitation, settling, filtering (wastewaters)	Data/EPA test, transfer/K062	Organics, metals
1/3	K099	2,4-Dichlorophenoxy- acetic acid (2,4-D) production	Chemical oxidation (nonwastewaters, Wastewaters)	Data/EPA collected	2,4-Dichlorophenoxy- acetic acid, chlorinated dibenzo-p-dioxins, chlorinated dibenzofurans
1/3	K101, K102	Production of veterinary pharmaceuticals from arsenic	Rotary kiln incineration (nonwastewaters); chemical precipitation, settling, filtering (wastewaters)	Data/EPA test, transfer/K062	Organics, metals
1/3	K103, K104	Aniline/nitrobenzene production	Solvent extraction, steam stripping, and activated carbon adsorption followed by incineration of the solvent stream from extraction (nonwastewaters, wastewaters)	Data/EPA test	Organics, inorganics (cyanides)
1/3	K106	Sludges from the mercury cell process in chlorine production	Thermal recovery (retorting) (nonwastewaters)	Data/industry-submitted	Mercury
1/3	K004-K008, K021 K025, K036, K060, K100 (no document prepared)	Pigments, fluoro- methane, nitrobenzene, disulfoton, coking and lead production	Chromium reduction, carbon adsorption; chemical oxidation and metal precipitation (nonwastewaters, wastewaters)	Data/industry-submitted	Metals, organics
2/3	F006-F012, F019	Electroplating, heat treating operations	Alkaline chlorination, stabilization (nonwastewaters), alkaline chlorination, chemical precipitation, settling, filtering (wastewaters)	Data/industry-submitted	Cyanides, metals

A-4

LIST OF BOAT BACKGROUND DOCUMENTS AND ASSOCIATED BOAT(S)

Third	Waste Code/ (Background Document)	Industry or Source of Waste	BOAT(s)	Actual Data or Transferred and Origin of Data	Types of Wastes Regulated
2/3	K011, K013, K014	Acrylonitrile production	Rotary kiln incineration (Nonwastewaters)	Data/EPA test	Acrylonitriles, cyanides
2/3	Cyanide P wastes (P013, P021, P029, P030, P063, P074, P098, P099, P104, P106, P121)	Cyanide P wastes	Electrolytic oxidation, alkaline chlorination, stabilization (nonwastewaters), alkaline chlorination, chemical precipitation, settling and filtration (wastewaters)	Data/industry-submitted, transfer/F006-F012, F019	Cyanides, metals
2/3	F024	Chlorinated aliphatics production	Rotary kiln incineration (nonwastewaters); rotary kiln incineration, lime and sulfide precipitation, vacuum filtering (wastewaters)	Data/industry-submitted, transfer/K062	Organics, metals
2/3	Inorganic pigments (K002-K008)	Pigments production	Not established under 2/3 rule; see 3/3	See 3/3	See 3/3
2/3	K009, K010	Acetaldehyde production	Rotary kiln incineration (nonwastewaters); steam stripping, biological treatment (wastewaters)	Transfer/K019, Transfer/data from Office of Water	Organics
2/3	K023, K093, K094, U028, U069, U088, U102, U107, U190	Phthalic anhydride production	Rotary kiln incineration (nonwastewaters and wastewaters)	Transfer/K024	Organics
2/3	K027, K111, K112, K113, K114, K115, K116, K221, U223	Toluene diisocyanate production	Incineration or fuel substitution (nonwastewaters); direct incineration, or carbon adsorption followed by incineration or fuel substitution, stabilization (wastewaters)	Transfer/K015, K086, F006	Organics, metals
2/3	K028, K029, K095, K096	1,1,1-trichloroethane production	Incineration, stabilization (nonwastewaters); lime and sulfide precipitation (wastewaters)	Transfer/K019, Transfer/K062	Organics, metals

A-5

LIST OF RDAT BACKGROUND DOCUMENTS AND ASSOCIATED BDAT(S)

Third	Waste Code/ (Background Document)	Industry or Source of Waste	BDAT(s)	Actual Data or Transferred and Origin of Data	Types of Wastes Regulated
2/3	K036, K038, K039, K040, P039, P040, P041, P043, P044, P062, P07, P085, P089, P094, P097, P109, P111, U058, U087, U235	Organophosphorous pesticide production, e.g., disulfoton, phorates, and others P and U wastes	Rotary kiln incineration (nonwastewaters); biological treatment; carbon adsorption incineration (wastewaters)	Transfer/K037, Data/industry-submitted	Organics, organophos- phorus compounds, dioxins and furans
2/3	K043	2,4-Dichlorophenol production	Incinerator (nonwastewaters, wastewaters)	Data/industry-submitted	Phenols, dioxins, and furans
2/3	K069 (Calcium sulfate)	Secondary lead smelting industry	Stabilization (nonwastewaters); chromium reduction, chemical precipitation, settling, and/or filtering (wastewaters)	Transfer/F006 and K062	Metals
3/3	D001	Wastes having the characteristic of ignitability	Deactivation* to remove ignitability, or incineration/fuel substitution, recovery for high TOC D001	Information references	Waste having the characteristic of ignitability
3/3	D002	Wastes having the characteristic of corrosivity	Deactivation* to remove corrosivity	Information references	Waste having the characteristic of corrosivity
3/3	D003	Wastes having the characteristic of reactivity	Deactivation* of cyanides; alkaline except for cyanides; alkaline chlorination (cyanides)	Information references, Industry submitted data, transfer/Office of Water	Wastes having the characteristics of reactivity

A-6

LIST OF BDAT BACKGROUND DOCUMENTS AND ASSOCIATED DAT(S)

Third	Waste Code/ (Background Document)	Industry or Source of Waste	BDAT(s)	Actual Data or Transferred and Origin of Data	Types of Wastes Regulated
3/3	Arsenic, selenium, (D004, D010, K031, K084, K101, K102, P010, P011, P012, P036, P038, P103, P114, P204, P205, U136)	characteristic and P&U wastes & K wastes for arsenic and selenium and wastes from veterinary pharmaceuticals production	Vitrification (nonwastewaters); chemical precipitation (wastewaters)	Data/industry-submitted transfer/Office of Water	Arsenic, metals, inorganics
3/3	Barium (D005, P013)	Characteristic and P waste for barium	Stabilization (nonwastewaters); chemical precipitation settling, filtration (wastewaters)	Data/Office of Water, Data/industry-submitted	Barium
3/3	Cadmium (D006)	Characteristic waste for cadmium	Stabilization, thermal recovery (cadmium batteries) (nonwastewaters); chemical precipitation, filtration (wastewaters)	Data/industry-submitted, transfer F006, K062	Cadmium
3/3	Chromium (D007, U032)	Characteristic and U wastes for chromium	Chromium reduction, chemical precipitation, settling, filtration, dewatering of solids (nonwastewaters and wastewaters)	Transfer/K062	Chromium
3/3	Lead (D008, K069, K100, P110, U144-U146)	Characteristic and U&P wastes for lead, and K waste from lead smelting operations	Stabilization/vitrification (non-wastewaters); chemical precipitation, flocculation, clarification, filtration, and sludge thickening (wastewaters)	Data/industry-submitted	Lead, organometallic compounds
3/3	Mercury (D009, K071, K106, P065, P092, U151)	Characteristic and U&P wastes for mercury and K waste from chlorine production	Thermal processing, incineration acid leaching, roasting, retorting amalgamation, stabilization (nonwastewaters); chemical precipitation, filtration, incineration, ion exchange, carbon adsorption (wastewaters)	Data/industry-submitted, transfer/K071	Metals, organometallic compounds
3/3	Silver (D011, P099, P104)	Characteristic wastes for silver, and P silver wastes	Recovery, stabilization (nonwastewater...); chemical precipitation, filtration (wastewaters)	Data/industry-submitted, and transfer/F006/ Office of Water	Metals

A-7

LIST OF BDAT BACKGROUND DOCUMENTS AND ASSOCIATED BDAT(S)

Third	Waste Code/ (Background Document)	Industry or Source of Waste	BDAT(s)	Actual Data or Transferred and Origin of Data	Types of Wastes Regulated
3/3	Thallium (P113, P114, P115, U214, U215, U216, U217)	U&P thallium wastes	Recovery, stabilization (nonwastewaters); chemical oxidation, chemical precipitation settling, filtration (wastewaters)	Data/industry-submitted	Metals
3/3	Vanadium (P119, P120)	U&P vanadium wastes	Stabilization (nonwastewaters); recovery, chemical precipitation (wastewaters)	Data/industry-submitted	Metals
3/3	F002, F005	Spent halogenated and nonhalogenated solvents	Incineration (nonwastewaters); biological treatment, steam stripping, carbon adsorption, wet air oxidation/chemical oxidation liquid extraction (wastewaters)	Transfer/EPA data from various sources	Organics
3/3	F006	Sludges from electroplating operation	Stabilization (nonwastewaters); alkaline chlorination, chromium reduction, chemical precipitation (wastewaters)	Transfer/K062	Metals, cyanides
3/3	F019	Sludges from the chemical conversion coating of aluminum	Alkaline chlorination, stabilization (nonwastewaters); alkaline chlorination, chromium reduction, chemical precipitation (wastewaters)	Transfer/F006-F012	Metals, cyanides
3/3	F024	Production of chlorinated aliphatic hydrocarbons	Stabilization, incineration (nonwastewaters)	Data/EPA test	Metals, organics
3/3	F025	Wastes from production of chlorinated aliphatic hydrocarbons having carbon chain linkage	Incineration (nonwastewaters) biotreatment, steam stripping, carbon adsorption, liquid extraction (wastewaters)	Transfer/K019, K001, F039 (Vol. A)	Organics
3/3	F039 and associated U&P wastes (Vol. A-E)	Multisource leachate and U&P wastes	See footnote b.	Data/transfer/EPA data from various sources and EPA test	Metals, inorganics, organics

A-8

LIST OF BDAY BACKGROUND DOCUMENTS AND ASSOCIATED BDAT(S)

Third	Waste Code/ (Background Document)	Industry or Source of Waste	BDAT(s)	Actual Data or Transferred and Origin of Data	Types of Wastes Regulated
3/3	K001, U051 (addendum)	Wood preserving industry	Incineration (nonwastewaters, wastewaters)	Data/EPA test	Organics, metals
3/3	K002-K008	Pigment industry sludges	Chemical precipitation, stabilization (nonwastewaters); alkaline chlorination followed by chromium reduction (wastewaters)	Data/transfer/industry, K062, transfer/F006	Metals, inorganics
3/3	K011, K013, K014	Acrylonitrile, production	Wet air oxidation (wastewaters)	Data/industry-submitted	Metals, organics
3/3	K015	Still bottoms from distillation of benzyl chloride	Incineration, stabilization (nonwastewaters)	Transfer/K048-52, K087, transfer/F039 (Volume A)	Organics, metals
3/3	K017	Production of epichlorohydrin	Incineration (nonwastewaters); biotreatment (wastewaters)	Transfer/F039, (Vol. A and C)	Organics
3/3	K021	Aqueous antimony catalyst from fluoromethane production	Incineration (nonwastewaters); biotreatment, steam stripping, lime conditioning, sedimentation, filtration (wastewaters)	Transfer/K019, K048-52, F039 (Vol. A)	Metals, organics
3/3	K073	Chlorine production	Incineration (nonwastewaters); biotreatment, steam stripping, filtration (wastewaters)	Transfer/K019, transfer/F039 (Vol. A)	Organics
3/3	K022	Bottoms, tars from production of phenol/acetone	Chemical precipitation, vacuum filtration (wastewaters)	Transfer/F039 (Vol. A), K062	Metals, organics
3/3	K025	Distillation bottoms from the production of nitro- benzene	Incineration (nonwastewaters); liquid-liquid extraction, steam stripping, carbon adsorption, incineration of spent carbon (wastewaters)	Transfer/previous EPA incineration tests, transfer/K103-K104	Organics
3/3	K026	Tails from the produc- tion of methyl ethyl pyridines	Incineration (nonwastewaters, wastewaters)	Transfer/previous incineration tests	Organics

6-A

LIST OF BDAT BACKGROUND DOCUMENTS AND ASSOCIATED BDAT(S)

Third	Waste Code/ (Background Document)	Industry or Source of Waste	BDAT(s)	Actual Data or Transferred and Origin of Data	Types of Wastes Regulated
3/3	K028, K029, K095, K096	Wastes from production of 1,1,1-trichloroethane	Stabilization (nonwastewaters); biotreatment, steam stripping carbon adsorption, filtration (wastewaters)	Transfer/F039 (Vol. A), transfer/F024	Organics, metals
3/3	K032-K034, K041-K042, K085, K097, K098, K105, D012-D017	Halogenated pesticides and chlorobenzene waste	Incineration (nonwastewaters) biotreatment, steam stripping, carbon adsorption, liquid extraction incineration/wet air oxidation/chemical oxidation (wastewaters)	Transfer/EPA data	Various halogenated pesticides, chlorinated nonbornane deriva- tives, other organics
3/3	K035	Wastewater treatment sludges from the production of creosote	Incineration (nonwastewaters); biotreatment (wastewaters)	Transfer/K087	Organics
3/3	K036	Still bottoms from toluene reclamation distillation in the production of disulfoton	Incineration (nonwastewaters for disulfoton)	Transfer/K037	Organics
3/3	K037	Wastewater treatment Sludges from the Production of Disulfoton	Biological treatment (wastewaters)	Data/EPA test	Organics, organo- phosphorus pesticides
3/3	K044, K045, K047	Manufacturing explosives and lead- based initiating compounds	Deactivation, settling and filtration, alkaline precipitation (wastewaters)	Data/industry-submitted, EPA	Reactive wastes
3/3	K046 (reactives)	Lead-based initiating compounds	Deactivation by chemical treatment or specialized incineration followed by stabilization (nonwastewaters); chemical deactivation followed by alkaline precipitation, settling, and filtrating (wastewaters)	Data/industry-submitted Transfer/K062	Lead

A-10

LIST OF BDAT BACKGROUND DOCUMENTS AND ASSOCIATED BDAT(S)

Third	Waste Code/ (Background Document)	Industry or Source of Waste	BDAT(s)	Actual Data or Transferred and Origin of Data	Types of Wastes Regulated
3/3	K048-K052 (addendum)	Petroleum refining industry	Incineration, solvent extraction (nonwastewaters)	Data/industry-submitted	Organics, metals, inorganics
3/3	K060	Ammonia still lime sludge from coking operations	Incineration (nonwastewaters) biological treatment (wastewaters)	Transfer/Office of Water, transfer/K087	Organics, inorganics
3/3	K061	Emission control dust/sludge from the primary production of steel in electric furnaces	Chemical reduction, chemical precipitation (wastewaters)	Transfer/K062, industry data	Metals
3/3	K083	Distillation bottoms from the production of aniline	Incineration, stabilization (nonwastewaters); liquid-liquid extraction, steam stripping, carbon adsorption, biological treatment (wastewaters)	Transfer/previous EPA incineration test, Transfer/ F039 (Vol. A)	Organics, metals
3/3	K086	Wastes from cleaning equipment used in formulation of ink from pigments, driers, soaps, and stabilizers containing chromium and lead	Incineration, chromium reduction, chemical precipitation, filtration, stabilization (nonwastewaters), incineration, wet air oxidation or chemical oxidation, carbon adsorption, biological treatment, or steam stripping	Data/EPA test, transfer/F006-F012, transfer/F039 (Vol. A)	Organics, cyanides (inorganic)

The Agency has promulgated a treatment standard of Deactivation for wastes exhibiting the characteristic of Ignitability (D001), Corrosivity (D002), or Reactivity (D003). As part of the land disposal restrictions, treaters of these above-mentioned wastes are required to use a deactivation technology that will remove the characteristic for which the waste is hazardous. Technologies that are applicable and demonstrated for treating these characteristic wastes are listed in 40 CFR Part 268, Appendix 6.

The F039 background document (Volumes A through E) contains treatment performance data from various sources such as the BDAT program, the Office of Water's Industrial Technology Division, the National Pollutant Discharge Elimination System, the Hazardous Waste Engineering Resource Laboratories, and other sources. The F039 background document presents numerous technologies as BDAT. For further information, refer to the F039 background document, Volumes A through E.