

# Comments Received during the Public Review Period on the “Inventory of U.S. Greenhouse Gas Emissions and Sinks: 1990-2009”

---

## **Commenter: Dan Heintz, Director, ASES Programs, Air Liquide**

*Comment: Based on its experience and knowledge of the hydrogen industry, Air Liquide sees a need for better understanding of how the draft US Inventory Report accounts for GHG emissions from hydrogen production and further requests that future US GHG Inventory Reports more clearly address GHG emissions from hydrogen production. Recently, the industrial gases industry commissioned a study of its GHG emissions for the years 2007 and 2008. The study shows that industrial gas hydrogen production resulted in between 13.5 and 14.5 million metric tons per year of direct GHG emissions in 2007 and 2008. We have studied the current GHG Inventory Draft and have not been able to identify where these emissions are accounted for. The following steps were undertaken but do not resolve this question:*

- *Chapter 3 Energy covers the wide range of energy-related emissions categories, including fuel production at refineries, which would appear on its face to include hydrogen production.*
- *Section 3.7 Petroleum Systems does not include a hydrogen source category.*
- *Section 3.1 Fossil Fuel Combustion could possibly include hydrogen production, more specifically perhaps as part of the Combustion Industrial subgroup.*
- *The emission estimation methodology for Fossil Fuel Combustion at Annex 2, Part 2.1 indicates that emissions from certain activities are subtracted from the fossil fuel combustion sector fuel totals (see Annex 2.1, Steps 2 and 4). However, hydrogen production is not identified as one of the reasons for subtracting emissions from the combustion emissions totals.*
- *The Energy Information Administration (EIA) Monthly Energy Review is cited as the source for the fuel consumption data. A review of the most recent publication (<http://www.eia.doe.gov/mer/pdf/mer.pdf>) does not appear to provide information that could demonstrate whether hydrogen production is included.*

*In the Draft Report, GHG emissions from hydrogen production may or may not be captured in GHG emissions attributed to petroleum systems or industrial combustion. Even if those emissions are in fact included in the overall emissions inventory, they are an undifferentiated subset of some sector's emissions. Air Liquide believes that the US emissions inventory should provide accurate data regarding GHG emissions from hydrogen production for several reasons. Providing a more accurate industry profile through better defined emission categories would benefit all users of the data. Accurate representation of the proportion of emissions from independent hydrogen production facilities is necessary given the size and rapid growth of the emission source. In addition, accurate baseline emission data for hydrogen production (and perhaps other sectors now subsumed into other reporting categories) in the US Inventory Report will ensure that increased efficiencies are recognized and producers and the US are appropriately credited for any emission reduction efforts. Air Liquide would like to confirm that*

*GHG emissions from hydrogen production facilities are included in the inventory and to recommend the establishment of a subcategory for hydrogen production be explored, given the nature and size of this source.*

**Commenter: Karin Ritter, Manager, Regulatory and Scientific Affairs, American Petroleum Institute (API)**

*(See Attachment A for referenced tables).*

**Sections 3.6 (Natural Gas Systems) and 3.7 (Petroleum Systems)**

*Comment: Some significant changes have been made to specific emission factors in the inventory this year. We anticipate that the inventory will continue to change and be refined as companies begin reporting under the GHG Reporting Program (GHGRP). As a result, we are concerned that revisions to the inventory this year will be misinterpreted to imply significant under reporting of specific emission sources. We request that EPA reformat the presentation of information provided in the inventory to appropriately reflect current emission reduction activities. Further details are provided below.*

**Emission Reductions**

*Comment: The most significant issue with EPA's 2009 national inventory is that the national emission factors do not account for activities widely used by industry to reduce CH<sub>4</sub> emissions. EPA indicates (page A-150) that "accounting for CH<sub>4</sub> reductions reported to the Natural Gas STAR Program and CH<sub>4</sub> reductions resulting from regulations, such as the National Emissions Standards for Hazardous Air Pollutants (NESHAP) regulations is done after the total national inventory is compiled." (emphasis added). EPA provides the total sector emission reductions in Tables A-125 and A-126, for Natural Gas STAR and regulatory driven reductions, respectively. However, the reductions shown are not split by emission source type. Not clearly identifying the reductions associated with each emission source, consistent with the presentation of emission factors by source, implies that the sources emit larger quantities of GHG than they actually do. Emission reductions for many of the inventory source types, especially the sources which were revised as a part of the 2009 inventory (e.g., gas well cleanups) are significant.*

*Comment: EPA also indicates that "Before incorporating the reductions into the Inventory, quality assurance and quality control checks are undertaken to identify errors, inconsistencies, or irregular data. The checks include matching Natural Gas STAR reported reductions to specific inventory sources to make sure that a reported reduction for one source is not greater than the emission estimate for that source. This check has lead (sic) to emissions updates to sources such as well completions and workovers, and well clean up." This implies that if EPA Natural Gas STAR emission reductions are greater than EPA's national estimate of emissions for a particular source, then EPA inflates the national emission result, presumably by inflating the emission factor, so that the reduction does not produce a negative emission. EPA indicates that such an adjustment was made to the completion, workover, and well clean up emission factors, but does not elaborate on the method or significance of the adjustments. This also indicates that EPA has the information available to report the reductions for each individual*

*emission source. The result is that the emission factors reported by EPA are artificially inflated to balance out the Natural Gas STAR reductions, and do not account for significant emission reduction and emission controls. The inflated national emission factors may result in a false conclusion that emissions from some of the source types (particularly those that EPA has recently modified) have been significantly underestimated in the past. For full transparency and a realistic representation of the industry operational practices, EPA's reported emission factor for each source type should account for the emission reduction practices and regulatory impacts within each region.*

**Comment:** *To further investigate the transparency of the reported Natural Gas STAR reduction data, the 2009 CH<sub>4</sub> reductions in Table A-125 of the draft 2009 national inventory attributed to EPA Natural Gas STAR were compared to the Gas STAR paper, EPA Natural Gas STAR Program Accomplishments for 2009, as shown in Table 1 [See Table 1 on page 3 of Attachment A]. As shown, the 2009 CH<sub>4</sub> emission reductions reported in the draft EPA national inventory attributed to Gas STAR are higher than the reductions reported in the Gas STAR accomplishments paper, and the differences are not explained. EPA should clearly document the differences and explain the basis for the values provided in Table A-125.*

### **Gas Well Workovers**

**Comment:** *For the 2009 inventory, EPA split gas well workovers into two emission sources: conventional gas well workovers and unconventional gas well workovers. EPA classifies unconventional wells as those involving hydraulic fracturing, and notes in the Technical Support Document (TSD) associated with 40 CFR 98 Subpart W2 that "it is understood that not all unconventional wells involve hydraulic fracturing, but some conventional wells are hydraulically fractured, which is assumed to balance the over-estimate." Industry commented on the proposed Subpart W that the terms "conventional" and "unconventional" were confusing and not commonly used by industry. For consistency and clarity, EPA should adopt the terminology used in the final Subpart W (i.e., with and without hydraulic fracturing). While the emission factors for conventional (without hydraulic fracturing) gas well workovers are on the same order of magnitude as the "well workover" factors that were used in the 2008 inventory, the unconventional (with hydraulic fracturing) well workover factors are over three thousand times larger, which seems to be excessively overestimated with no applicable documentation. Table 2 compares the 2008 and 2009 workover emission factors by region [See Table 2 on page 4 of Attachment A].*

**Comment:** *The national inventory does not describe how EPA determined the emission factors for conventional gas well workovers. However, the TSD indicates an emission factor for well workovers from the EPA/GRI study is applied for conventional wells. The emission factor provided in the EPA/GRI study is 2,454 Mcf of methane/workover. Minor adjustments to this emission factor are believed to be reflected in Table 2 to account for different methane compositions in each region [See Table 2 on page 4 of Attachment A]. For unconventional well workovers, the TSD indicates that the emission factor is assumed to be the same as unconventional well completions. An analysis of the unconventional completion emission factor and emission estimates is provided in the following section.*

**Comment:** As noted previously, EPA adjusts the total national inventory for emission reductions reported through the Gas STAR program and reductions that results from regulatory requirements, such as NESHAP. Hence, it is also not possible to determine which of the emission reductions shown in Table A-125 and A-126 are attributed unconventional well workovers, as the tables do not split reductions by activity.

### **Unconventional Well Completions**

**Comment:** As a part of the 2009 inventory, “unconventional well completions” is added as a new emission source to the “Drilling and Well Completion” inventory category. Unconventional well completions now account for approximately 7% of the total natural gas production CH<sub>4</sub> emissions, where as in 2008, “well drilling” emissions accounted for approximately 0.07% of total natural gas production CH<sub>4</sub> emissions. EPA’s inventory documentation does not reference the source of information for the reported counts of wells drilled and unconventional completions. The only statement is that “the Inventory tracks activity data for unconventional well counts (which we assumed to be completed by hydraulic fracture for the purposes of this analysis) in each region.” EPA should indicate which of the numerous references listed for activity data are associated with the individual emission sources, particularly if activity data are derived from other information.

**Comment:** The regional emission factors used for unconventional gas well completions are the same as those used for unconventional gas well workovers (shown in Table 2). The emission factors for unconventional gas well completions are much larger than the emission factors for well drilling; as noted for well workovers. EPA justifies the use of larger emission factors due to the higher pressure venting of gas used to drive large volumes of liquid from the production well.

**Comment:** As mentioned for unconventional well workovers, EPA does not describe how the emission factor for unconventional gas well completions was developed. For unconventional completions, the TSD associated with 40 CFR 98 Subpart W indicates the emission factor was derived from participant information shared and presented at Natural Gas STAR technology transfer workshops. EPA cites two Gas STAR presentations as the source of information for the unconventional well completion/workover emission factor. The TSD for Subpart W provides further details on the data specifically used in developing the Subpart W average emission factor of 9,175 Mscf/completion. It is assumed that the emission factors shown in Table 2 vary from the Subpart W average emission factor due to different gas compositions in the region, but this is not documented in the inventory.

**Comment:** Table 3 summarizes the information presented in the two Gas STAR presentations referenced in the 2009 national inventory and demonstrates the basis for the average emission factor [See Table 3 on page 5 of Attachment A.]. API notes the following based on reviewing the information in Table 3: • EIA clearly indicates that the volumes reported are vented and flared emissions combined. EPA is assuming the total volume of gas is vented, which inflates the emission factor. It is also interesting that although EIA reports this information annually, EPA only evaluated the 2002 data presented in the Gas STAR report.

**Comment:** EPA did not use the information provided by the second (unidentified) source. This data set shows a wide spread of recovered gas volumes and percentages. As this was presented

at a Gas STAR workshop, it would be useful if EPA could request more details on this data from the source of the information.

**Comment:** *It is not clear why EPA did not include the information presented by BP. The BP data point represents a controlled completion and would support the development of a controlled emission factor.*

**Comment:** *The Williams data provides the total amount of gas generated from completions. However, the Williams presentation provides data that demonstrates the majority of this gas is recovered, and the small amount that is not recovered is either vented or flared. In fact, using the data Williams provides, which demonstrates the actual emissions that result accounting for emission reduction activities, produces an average emission factor of approximately 2,000 Mscf/well, which is about one-fifth of the emission factor used in EPA's inventory.*

**Comment:** *For this source it is not clear where EPA may adjust the emissions to account for emission reduction activities or regulatory requirements, such as flaring. EPA notes "some states, such as Wyoming, may require that natural gas produced during well completions not be vented. In these regions emissions from natural gas well completions and re-completions are either recovered for sales or must be flared. The volume of gas recovered by bringing equipment to the wellsite for the treatment and injection of the produced completion gas into the sales pipeline is reported by Natural Gas STAR. The remaining volume of completion gas from states that do not allow the venting of this gas is flared". The inventory includes a source "completion flaring" but EPA does not discuss how this source relates to the unconventional completion emissions.*

**Comment:** *The number of completions flared does not appear to have changed, and in fact is slightly larger for 2009 compared to 2008. This indicates that EPA has not made a significant adjustment to the accounting for emissions from completion flaring. However, it would seem that some portion of the unconventional completion emissions would be flared and should thus be represented in the source category for completion flaring. EPA should reflect the actual flared and vented emissions, as represented by current industry practices, by appropriately accounting for completion emissions that are vented versus flared and eliminating the artificial inflation of the emission factor and potential double counting of some completion activities.*

### **Well Clean Ups (LP gas wells)**

**Comment:** *In the 2009 inventory, the total emissions from "well clean ups" account for approximately 51% of the total natural gas production sector CH<sub>4</sub> emissions. For comparison, in the 2008 inventory, well clean up emissions accounted for approximately 6% of the total natural gas production CH<sub>4</sub> emissions, when not accounting for emission reductions due to Natural Gas STAR or other regulations. EPA notes that the methodology for quantifying emissions from this source category was revised to include a large sample of well and reservoir characteristics from the HPDI database of production and permit information along with an engineering equation to estimate the volume of natural gas necessary to expel a liquid column choking the well production. The approach used for the emission factor is based on a fluid equilibrium calculation to determine the volume of gas necessary to blow out a column of liquid for a given well pressure, depth, and casing diameter.*

**Comment:** EPA notes in Section 3.6 that the HPDI database for well production and well properties was queried to obtain sample data on average well depth, shut-in pressure, well counts, and well production rates from each basin. Although EPA does not state explicitly, it is implied that differences in these characteristics across basins account for the regional differences reported in the inventory. For complete transparency, EPA should publish the equation and the average characteristics used for each basin.

**Comment:** Emission reductions for this source type are significant. EPA even notes that emission reductions may be under reported in the Planned Improvements portion of Section 3.6, and that the potential for emission reductions from gas well cleanups to be underestimated will be investigated in the next Inventory cycle. The Natural Gas STAR Lessons Learned for installing plunger lift systems reports emission reduction ranging from 4,700 to 18,250 Mscf/yr. In addition, the West Coast emission factor, the second largest of the regional factors, clearly does not account for the practices in California, where petroleum producers have strict emission controls on CH<sub>4</sub>. EPA describes in Annex 3.4 that some states may require that natural gas produced during well completions not be vented; in these regions the natural gas is recovered to sales or flared. The natural gas from gas well clean ups can also be recovered to sales or flared. Alternatively, if gas and liquids/water are piped separately to the surface from a gas well, and any artificial lift method (not just plunger lift) was applied to bring the liquids to the surface, then there would be no venting of gas and liquids from the well from liquids unloading. All such artificial lift practices and other methods for reducing emissions should be clearly identified in EPA's inventory. The inventory should provide separate factors for controlled and uncontrolled activities, as is done for condensate tanks.

### **Flashing Losses from Oil and Condensate Tanks**

**Comment:** The 2009 national inventory includes an adjustment to the condensate tank emission factors for the Mid-Central and South West regions for both condensate tanks without control devices and condensate tanks with control devices. EPA noted in Section 3.6 that the 2009 inventory includes, for the first time, data from a Texas Environmental Research Consortium (TERC) study (TERC 2009) which provided a small sample of data representing two regions in Texas where separator dump valve malfunctions were detected and measured. The TERC study measured emissions rates from several oil and condensate tanks in Texas. These data were plotted and compared to flashing emissions simulated via E&P Tanks. EPA observed that the E&P Tanks results indicated additional emissions beyond flashing losses were present in approximately 50 percent of the tanks and concluded that the emissions may be attributed to separator dump valves malfunctioning or other methods of associated gas entering the tank and venting from the roof. It is not clear how EPA applied the TERC study data to determine the 2009 emission factors. The TERC study specifically addressed Volatile Organic Compounds (VOC) emissions from oil and condensate storage tanks, and also provided vent sample data, including for methane. The TERC study was designed to specifically capture all of the emissions from each tank, and therefore it is unlikely that half of the tanks measured would have missed emissions. In addition, the TERC study did not capture all of the input data necessary to run E&P Tanks (e.g., pressurized separator liquid compositions). Therefore, it seems more likely that the "additional emissions" resulting from EPA's simulation runs of the flashing emissions are actually a result of assumptions EPA used to assign the model input parameters.

**Comment:** Furthermore, the E&P Tanks modeling EPA is referencing does not incorporate dump valve malfunctions as an emission parameter in the model algorithm. If EPA wishes to accurately quantify emissions from separator dump valve malfunctions, testing should be performed to specifically focus on emissions from malfunctioning dump valves. The activity factors for condensate tanks did not vary significantly from 2008 to 2009. However, EPA does not clearly identify how the throughput is differentiated between tanks with and without control devices. Instead, it appears that the same throughput is being applied to each tank type, presumably based on an assumption that 50% of tanks are controlled. EPA should clearly identify what source was used to obtain the throughput information for each tank type.

### **Centrifugal Compressors**

**Comment:** The 2009 inventory includes for the first time emission factors for centrifugal compressors by seal type (wet and dry seals, respectively) for the natural gas processing and natural gas transmission sectors. Table 4 compares the 2008 and 2009 emission factors and equipment counts by sector [See Table 4 on page 9 of Attachment A]. As shown in Table 4, the emission factors for centrifugal compressors increased from 2008 to 2009, regardless of seal type. The resultant emissions increase was most significant in the gas processing sector. Table 4 also shows that the activity factors for compressors have been split into compressors with wet and dry seals. However, EPA does not clearly identify how the counts of compressors were allocated between wet and dry seals or what information source EPA used to make this allocation. An EPA Natural Gas STAR Lessons Learned paper on replacing wet seals with dry seals notes that about 90 percent of all new compressors come with dry seals. It is anticipated that the number of centrifugal compressors with wet seals will decrease over time as centrifugal compressors with wet seals are replaced by centrifugal compressors with dry seals.

**Comment:** EPA notes that the centrifugal compressor emission factors were revised as a part of the 2009 Natural Gas STAR paper on replacing wet seals with dry seals and a Methane to Markets study of measurements at four gas processing plants. The WGC report notes that “Methane to Markets experience, combined with another assessment of four natural gas facilities, has identified measurements from 48 wet seal centrifugal compressors, with methane emissions totaling 14,860 thousand m<sup>3</sup> methane/year. The data, which show that seal oil degassing rates for individual compressors could range from 0 to 2,756 thousand m<sup>3</sup>/year, can be divided into two groups: a low-emitting group (33 compressors) and a high-emitting group (15 compressors). The low emitters have an average emission rate of 26 thousand m<sup>3</sup> methane/year for a single compressor. The high emitters have an average emission rate of 934 thousand m<sup>3</sup> methane/year for a single compressor.” inventory based on guidance from a World Gas Conference paper (WGC, 2009), which gathered 48 sample measurements of centrifugal compressor wet seal oil degassing emissions and published the results. The World Gas Conference paper, which is cited as the source of the 2009 inventory emission factors, is actually in turn citing a combination of data provided in the

**Comment:** The basis of the EPA wet seal emission factors is not clear and is inconsistent with Subpart W of the EPA’s Mandatory Reporting Rule. Subpart W, §98.233(o)(7), presents a default wet seal compressor emission factor of 12.2 million scf methane/yr (at 68°F and 14.7 psia), which converts to 33,425 scfd/compressor – consistent with the data presented in the WGC

report. The values used for the 2009 EPA inventory are much higher, at 51,370 scfd/compressor for processing, 50,222 scfd/compressor for transmission, and 45,441 scfd/compressor for storage. EPA does not provide documentation to explain the basis for the differences among the industry sectors. The Subpart W default emission factor for wet seal compressor degassing is based on 14,860 thousand m<sup>3</sup> methane/yr from the World Gas Conference paper divided by 43 centrifugal compressors (EPA Technical Support Document, 2010). Note that denominator is 43 compressors rather than all 48. The Technical Support Document indicates that five of the 48 wet seal centrifugal compressors were found to not be emitting<sup>10</sup>; thus the emission factor is incorrectly averaged only over the leaking compressors and does not account for the fact that a portion of the compressor seals do not leak, thus the total number of compressors (i.e. 48) ought to be included when deriving the emission factor.

**Comment:** Table 5 of the Methane to Markets paper presents a comparison of the emission factors measured during the study to the EPA/GRI 1996 emission factors. The average factor measured for compressor seals was 0.852 kg THC/h/source, while the EPA/GRI (1996) study average factor was actually larger by about 30%, at 1.172 kg THC/h/source. Footnote 4 to Table 5 notes that the “compressor seals component category accounts for emissions from individual compressor seals. As compressor seal leakage was typically measured from common vent and drain lines, emissions have been divided evenly among the seals on units with detected leakage.” The factors are not split by wet or dry seals. As Appendices I and II (containing site specific field measurement data) are missing to protect business confidentiality, it is not possible to determine whether the study further separates compressor seal measurements into wet and dry seals. EPA does not directly cite a source for the updated dry seal emission factors, but provides in the References section for the Natural Gas Systems a reference to the Natural Gas STAR paper discussed above. The executive summary of the paper notes that dry seals emit up to 6 scfm; on page 4 of the paper it is noted that dry seals emit less during normal operation (0.5 to 3 scfm across each seal, depending on the size of the seal and operating pressure). The cost savings in Exhibit 5 are calculated assuming 2 dry seals at a total of 6 scfm.

**Comment:** If EPA is citing the Natural Gas STAR paper as the reference for the dry seal emission factor, it can be assumed that the emission factor derived from such data will be on an order of magnitude similar to that provided in the reference document. It can conservatively be assumed that the emissions will be estimated using the maximum leakage rate (6 scfm), instead of the normal operation leakage rate (0.5 to 3 scfm). However, when converting the 6 scfm identified in the Natural Gas STAR paper to a scfd basis, as is used in the 2009 inventory, the factor should be around 8,640 scfd/compressor on a natural gas basis, even lower on a methane basis, and+E81 significantly less than the factor shown in the 2009 inventory for natural gas processing (25,189 scfd/compressors), transmission (32,208 scfd/compressors), and storage (31,989 scfd/compressors). EPA should explain these differences and clearly state the reference of the emission factors for each segment.

## **National Energy Modeling System (NEMS) Regions**

**Comment:** EPA notes that the regions are divided in accordance with the National Energy Modeling System. However, according to EIA, the NEMS regions are: Pacific, Mountain, West North Central, East North Central, New England, Middle Atlantic, South Atlantic, East South Central, and West South Central. EPA should clearly identify which of the NEMS regions are



*included in each of the natural gas production regions (North East, Mid-Central, Rocky Mountain, South West, West Coast, and Gulf Coast). In addition, Texas (the state for which the TERC study was conducted) falls into one NEMS region: West South Central. Yet in the 2009 inventory, the condensate storage tank emission factors for both the Mid-Central and South West regions were revised. EPA notes in Section 3.6 that because the TERC dataset was limited to represent production from only 14 counties that represent 0.5 percent of U.S. production, the national emission factor was scaled up such that only production from these counties is affected by the occurrence of associated gas venting through the storage tank. EPA should clearly identify how the factors for both the Mid-Central and South West regions were adjusted. If Texas does fall within both the Mid-Central and South West regions, and if the factors were truly scaled according to the counties affected, the factors should not be identical for both Mid-Central and South West regions.*

### **Updated API Compendium**

**Comment:** *API provided comment on the draft 1990 – 2008 inventory that, as indicated above, API revised the API Compendium in 2009. References to emission factors from the API Compendium should be updated to reflect the 2009 version of API’s Compendium of Greenhouse Gas Emissions Estimation Methodologies for the Oil and Gas Industry. For example, Section 3.7 Petroleum Systems (p. 3-51, line 15) and Annex 3.5 Petroleum Systems (p. A-168, line 34) reference “API (2004)”, but should instead reference the newest version of the API Compendium as the source of the asphalt blowing emission factor.*

### **Asphalt Blowing**

**Comment:** *API provided comment on the draft 1990 – 2008 inventory that the most significant change noted in the 2008 national inventory was the addition of asphalt blowing CO<sub>2</sub> emissions for refineries in the Petroleum Systems category. This emission source accounted for 36% of the total non-combustion CO<sub>2</sub> emissions from petroleum systems in 2008, and accounts for 31% of the total non-combustion CO<sub>2</sub> emissions from petroleum systems in 2009.*

**Comment:** *The CH<sub>4</sub> factor for asphalt blowing in the 2009 EPA Inventory of Greenhouse Gas Emissions and Sinks is the same as is used in the 2008 EPA Inventory of Greenhouse Gas Emissions and Sinks. As a part of API’s comments on the draft 1990 – 2008 inventory, API also noted that neither emission factor is consistent with the 2009 API Compendium. The 2009 Compendium+E86 presents the same factor as the 2004 API Compendium, which is the cited source of the emission factor used in the EPA Inventory of Greenhouse Gas Emissions and Sinks. The 2009 API Compendium cites a simple emission factor for uncontrolled asphalt blowing from AP-42 (EPA, AP-42, Section 5.1.2.10, 1995). The AP-42 emission factor for asphalt blowing is assumed to be on an air-free basis (AP-42 does not specify this, but notes the factor represents “emissions”). Asphalt blowing exhaust composition data (13 mol% CH<sub>4</sub> and 9 mol% CO<sub>2</sub>, on an air free basis) presented in an Oil & Gas Journal article<sup>12</sup> is applied to derive the CH<sub>4</sub> and CO<sub>2</sub> emission factors of 5.55E-4 tonnes CH<sub>4</sub>/bbl asphalt blown and 1.01E-3 tonnes CO<sub>2</sub>/bbl asphalt blown, respectively. (Further details on the derivation of these emission factors are provided in Appendix B of the 2009 API Compendium.) For comparison, the EPA emission factors converted to a similar basis are 4.9E-5 tonnes CH<sub>4</sub>/bbl and 1.09E-3 tonnes CO<sub>2</sub>/bbl. However, the primary distinction between the API Compendium emission factors and those used in the*

*EPA inventory is the units of measure applied to the activity factor. The API emission factors are based on the volume (or mass) of asphalt blown, while the EPA emission factors appear to be based on the total volume of asphalt produced (411 Mbbl/cd production). As a result, the EPA emission factors result in much higher emission estimates.*

### **Refining Emissions**

***Comment:** There are a number of sources that do not appear to be included in the national GHG inventory. For the refining sector, these include CO<sub>2</sub> emissions from flares, hydrogen production, catalytic cracking units, fluid coking units, catalytic reforming units, sulfur recovery units, and coke calcining units. Emissions from each of these sources are required to be reported under the GHGRP, and for which EPA had to assess the emissions as part of the justification for their inclusion in the regulation. The inventory should incorporate EPA's current understanding of these emissions or document why they are excluded from the inventory.*

### **Alignment with the EPA GHG Reporting Program**

***Comment:** EPA indicates in the Planned Improvements portion of both of Sections 3.6 (Natural Gas Systems) and 3.7 (Petroleum Systems) that data collected through 40 CFR Part 98 (Mandatory Reporting of Greenhouse Gases; Final Rule) will be used as a source for potential improvements to the inventory. API supports the continued improvement of the national inventory, but urges EPA to provide transparent justification and formal technical review for the changes. In Section 3.6 (page 3-48, line 25) EPA notes that reporting will begin in 2010 for natural gas suppliers. EPA is referring to reporting under Subpart NN (Suppliers of Natural Gas and Natural Gas Liquids) for local distribution systems. However, Subpart NN only requires reporting of volumes and emissions associated with potential end-use combustion of the natural gas and the natural gas liquids supplied. The information reported under Subpart NN does not represent actual emissions, and if the gas supplied were to be combusted their emissions would fall under Section 3.1 (Fossil Fuel Combustion), not to Section 3.6.*

***Comment:** EPA should clarify that data collection begins for Subpart NN in 2010, with emissions reported beginning in 2011 for calendar year 2010. In addition, if EPA is implying that emissions reported under Subpart W will be used to improve the Natural Gas Systems inventory, EPA should clarify that data collection for Subpart W begins in 2011, with emission reporting beginning in 2012 for calendar year 2011.*

***Comment:** In Section 3.7 (page 3-52, line 37) EPA notes that U.S. petroleum refineries will be required to calculate and report their greenhouse gas emissions beginning in 2010. EPA should clarify that data collection begins for petroleum refineries in 2010, with emissions reported beginning in 2011 for calendar year 2010.*

### **Section 3.6 and Annex 3.4, Natural Gas Systems**

***Comment:** The changes to the emission factors for gas well workovers, gas well cleanups, well completions, condensate storage tanks, and centrifugal compressors should all be documented in Section 3.6 and Annex 3.4, as discussed above. Many other emission factors also changed from 2008 to 2009; a few examples are provided in Table 5 [See Table 5 on page 14 of Attachment A]. One example is provided for each region except West Coast, for which the emission factor revisions are due to rounding differences between the two inventories. Note that the table below*

*is not all inclusive of the emission factor revisions. The reasons for all emission factor revisions should be documented in the inventory, not just the reasons for major emission factor revisions.*

### **Annex 3.4 Natural Gas Systems**

**Comment:** *Emission factors and activity factors are only provided for 2008 (with the exception of “key activity data drivers” provided in Table A-124), yet emissions are shown for multiple years. API recommends adding emission and activity factors for all years for which emissions are being estimated, for full disclosure. (In addition, it is discussed in Step 1 that activity factors vary by year.)*

**Comment:** *If emission factors determined for 1995 are assumed to be representative of emissions from each source type over the period 1990 through 2009, API recommends adding that information to Step 1 or Step 3, similar to the text in Annex 3.5 Petroleum Systems, p. A-168, line 21. Alternatively, if emission factors are not assumed to be representative of emissions from each source type over the period 1990 through 2009, this should be noted as well, and emission factors should be added for all years for which emissions are being estimated, for full disclosure.*

**Comment:** *p. A-150, Step 1, Second Paragraph, Line 3) The reference to “Table A-123” should instead be to “Table A-124”.*

**Comment:** *Multiple Tables- Where tables are split onto multiple pages, EPA should add table header for each continued page.*

**Comment:** *Table A-123- Emission factor units for Mishaps (Dig-ins) should be “Mscfy/mile” instead of “mscfy/mile”, to be consistent with the other units presented in the annex.*

**Comment:** *Table A-125- API recommends adding a note that indicates “Totals may not sum due to independent rounding.”*

### **Annex 3.5 Petroleum Systems**

**Comment:** *Emission factors and activity factors are only provided for 2009, yet emissions are shown for multiple years. API recommends adding emission and activity factors for all years for which emissions are being estimated, for full disclosure. (In addition, it is discussed in Step 2 that activity factors vary by year.)*

### **Section 3.7 Petroleum Systems,**

**Comment:** *Tables 3-43, 3-46, and 3-47- API recommends adding a note that indicates “Totals may not sum due to independent rounding.”*

**Comment:** *Table 3-43- The values shown for Tank Venting for 2005, 2006, and 2008 should be 0.2 Tg CO<sub>2</sub> Eq., not 0.3 Tg CO<sub>2</sub> Eq. This change corresponds with the values shown in Table A-142 for Tank Venting. API recommends verifying the values.*

**Comment:** *Table 3-47- The totals shown appear to vary more than would be due to rounding error. For example, the 2008 total should be approximately 43,410 Gg, but is shown as 43,311 Gg. API recommends verifying the totals.*

**Comment:** Tables 3-43 and 3-46- Where tables are split onto multiple pages, EPA should add the table header for each continued page.

**Comment:** Tables A-136 through A-138, and Table A-14- API recommends adding a header row above the last four columns noting “2009 EPA Inventory Values”, similar to the table presentation for Annex 3.4 (Natural Gas Systems).

**Comment:** p. A-170, Table A-137- Remove the period after “bbl” in the units for the emission factor and activity factor for Heaters.

**Comment:** p. A-170, Table A-138, and p. A-172, Table A-141- API recommends spelling out “cd” for emission factors with units of “cd refinery feed” or “cd feed”.

**Comment:** p. A-170, Table A-137- API recommends formatting with the Activity Factor for the Marine Loading and Pump Stations activity factors. The Marine Loading activity factor appears to have a digit (4) on the row below; the Pump Station activity factor does not clearly show all digits.

**Comment:** p. A-169- API recommends mentioning Table A-140, and how the values presented are used in calculation of the CO<sub>2</sub> emissions presented in Annex 3.5.

**Comment:** p. A-171, Table A-139) API recommends adding a note that indicates “Totals may not sum due to independent rounding.”

**Comment:** p. A-172, Table A-142) The value shown for Production Field Operations should be 317 instead of 319, which affects the total row in Table A-142 (the total should be 461 Gg instead of 463 Gg) and the values shown in Table 3-43 and Table 3-44.

### **Annex 3.4 Natural Gas Systems, and Annex 3.5 Petroleum Systems**

**Comment:** Multiple table references have a space before the table number. Tables are currently referenced as “Table AX” and should be “Table A-X”.

### **Peter D. Robertson, Senior Vice President for Legislative and Regulatory Affairs, America’s Natural Gas Alliance**

**Comment:** To ensure the accuracy and credibility of the inventory, ANGA urges EPA to work collaboratively with industry and other stakeholders to develop a more robust methodology for estimating emissions from well cleanup and unconventional well completions and workovers before including new emissions estimates from these sources. ANGA urges EPA to respond to the critical issues we have identified below and provide more information on the data and assumptions that were not specifically identified in the Draft Inventory or its appendices.

## **Emission Estimates from Natural Gas Field Production**

**Comment:** *EPA Has Dramatically Increased Emission Estimates from Natural Gas Field Production: We are concerned about changes that have been made in calculating emissions from natural gas field production. The Draft Inventory contains new methodologies and assumptions for estimating emissions from natural gas field production that dramatically increase the emissions estimated from this sector. EPA's previous national inventory estimated 2008 emissions from natural gas field production at 14.1 Tg CO<sub>2</sub> Eq.1 Draft Inventory of U.S. Greenhouse Gas Emissions and Sinks: 1990-2008 (2010 Inventory), Table 3-37. In the new Draft Inventory, estimated emissions in 2008 are 122.9 Tg CO<sub>2</sub> Eq, an increase of 108.8 Tg CO<sub>2</sub> Eq. To put this in perspective, the new draft estimate for natural gas field production is nearly 9 times higher than the previous estimate, more than double the previous estimate for all natural gas system emissions (which also includes processing, transmission and storage, and distribution) and on its own represents 1.5 percent of the 2011 draft national emissions inventory. No other emission source underwent such a striking adjustment. ANGA supports adjustments to the methodologies and assumptions used to estimate emissions in the national inventory, but only insofar as they are supported by new, robust data and reasonable methods of calculation. These requirements are heightened in the case of EPA's new estimates for natural gas field production, given the magnitude of the changes. Nearly 95 percent of the increased emissions estimates for 2008 are attributable to two changes: (1) a new methodology for natural gas well cleanups accounts for 66 percent of new emissions and (2) the inclusion of emissions from unconventional wells (shale gas and coal bed methane) accounts for 28 percent.*

**Comment:** *ANGA is concerned that at least two elements of the EPA's Draft Inventory – revised emissions estimates from natural gas well cleanups and new emissions estimates from “unconventional” well completions and workovers – rely on fundamentally flawed data and analysis. Given the magnitude of the new emissions estimated from these sources – the Draft Inventory repeatedly highlights that they are the largest sources of emission increases in the inventory – we believe that EPA must provide a more robust analytical justification. Failing to do so is counterproductive to EPA's mission to provide reasonable, scientifically sound information and could lead policymakers, scientists and others relying on the inventory to draw incorrect conclusions about greenhouse gas emissions from the natural gas sector and the greenhouse gas benefits of natural gas relative to other sources of energy.*

## **Emissions from Natural Gas Well Cleanups**

**Comment:** *The majority of increased emissions from natural gas field production come from a change in the methodology for estimating emissions from natural gas well liquid unloading, also referred to as cleanups in the Draft Inventory. The new methodology contains a critical flaw in its failure to include emission reductions from the use of artificial lift systems, such as plunger lifts, and raises a number of other concerns. Artificial lift systems provide substantial reductions in emissions from liquid unloading but it does not appear that EPA accounts for their use in the inventory. Generally, venting of gas during lift cycles is an old practice that has been largely replaced with methods that capture the gas. In addition to plunger lift systems – which can eliminate emissions entirely – there are a number of technologies used to reduce or eliminate venting from unloading, including but not limited to: • Velocity string (install smaller diameter tubing to increase the velocity); • Compression (reduce tubing pressure); • Pumps; • Gaslift (added gas to boost flow above critical); • Foaming (soap sticks, back side soap injection, cap*

string); • Injection systems (inject water below packer); and • Venting/Stop Clocking/Equalizing (temporary methods that are used in some cases). The omission of emission reductions from the application of these practices results in a worst-case scenario approach that is not appropriate for an emissions inventory and dramatically overestimates the emissions from natural gas production. It is not enough to adjust the inventory by results from the Natural Gas STAR program since not all natural gas producers are Natural Gas STAR partners and not all Natural Gas Star partners report all emission reduction activities. In fact, artificial lift may be under-reported even among Natural Gas STAR Partners as it is part of producing a well and not looked at as an emissions reduction technology.

**Comment:** EPA appears to have developed the methodology based on two sources. The first source, an EPA/Natural Gas STAR report “Lessons Learned: Installing Plunger Lift Systems in Natural Gas Wells”, provides an equation for estimating the volume of gas vented during a blowdown. EPA has not indicated whether the equation or the results were adjusted for the purposes of the Draft Inventory, nor has EPA provided the data, or average characteristics, that it used in the equation. EPA states that it used its other source, production and permit data obtained from HPDI in October 2009, for at least part of the data to run the equation. HPDI supplied information on well depth, shut-in pressure, well counts and well production data. However, more detail on the data actually used, particularly the data used to calculate shut-in pressure (which is needed to ensure that EPA focused on low pressure wells where liquid unloading is more prevalent), is necessary to adequately evaluate the methodology and results. The equation only provides the volume vented for each blowdown. To complete the inventory, EPA needs to know how many wells required cleanups (Wc) and how many blowdowns are required annually at those wells (BDa) so that:  $U.S. \text{ Methane Emissions from Cleanups} = Wc * BDa * V_v * 0.7886$ . The documentation for the inventory does not indicate what data were used to estimate Wc or BDa. While the HPDI data would have provided the total number of wells, it is unlikely that HPDI’s production data would have provided information on which wells perform cleanups and the number of blowdowns performed each year at those wells. EPA has recently estimated these two variables. Appendix B of the Technical Support Document (TSD) developed in support of Subpart W of the Mandatory Greenhouse Gas Reporting Rule uses data from a 1992 survey conducted by the Gas Research Institute (GRI) to estimate that 41.3 percent of conventional wells require cleanups. The 1992 survey was of 25 well sites.

**Comment:** To determine the average number of blowdowns at each well, the TSD uses a simple average of 31 blowdowns per well based on publicly available data from two Natural Gas STAR partners: 1. BP recovered 4 Bcf of emissions using plunger lifts with automation to optimize plunger cycles on 2,200 wells in the San Juan basin. Using the equation for blowdown emissions, EPA determined that 51 blowdowns per well would be required to match the reported 4 Bcf of emissions. 2. ExxonMobil reported it recovered 12 MMcf using plunger lifts on 19 wells in Big Piney. ANGA asks EPA to clarify whether it used these same assumptions – 41.3 percent of conventional wells require liquid unloading and these wells require 31 blowdowns annually – for the Draft Inventory. If the Agency did not use these assumptions, we ask that it supply this information so that stakeholders can provide comment. If the Agency did use the TSD assumptions, then ANGA notes that the blowdown estimate is based on two isolated data points and does not appear to account for well-specific variables, such as differences in well depth (shallow wells such as those in the San Juan Basin require more blowdowns than deep wells),

that drive the number of necessary blowdowns. If EPA has developed additional assumptions for determining the number of blowdowns, including well-specific data, it should disclose them and provide an opportunity for comment.

### **Emissions from Unconventional Well Completions and Workovers**

**Comment:** According to Table A-120, which provides region specific emission estimates, the Draft Inventory uses emission factors ranging from 7,194 Mcf/completion to 8,630 Mcf/completion. While this suggests some modifications from the TSD that EPA should clarify, it appears that the Draft Inventory largely utilizes the same methodology and data points since two presentations are the only referenced sources. This raises a number of concerns. Not only is the emission factor based on four data points with the high end nearly 30 times higher than the low end, a fatal flaw in itself, but none of these data points were purported to be representative estimates of emissions from completions or workovers. Rather, they are case studies from a voluntary EPA program aimed at reducing emissions and, as such, they are simply reporting the results of a handful projects in the field. They are not based on standardized and audited protocols. Moreover, case studies, by their nature, are typically based on the “cream-of-crop” projects. Since in this context, the best projects are the ones that reduce the greatest amount of emissions, using emission reductions from those case studies as the basis for a national inventory can lead to grossly inaccurate results. The bottom line is that EPA has the methodology backwards: the Agency should evaluate the volumes that are emitted from non-green completion activities rather than rely on green completion volumes from a voluntary program that were never intended to provide inventory-grade information to the Agency.

**Comment:** We note that even the data point that was not based on green completions (the EIA data used for the 6,000 Mcf/completion estimate) raises serious concerns. First, when backing out emissions attributable to conventional well completions and workovers, the TSD uses the old emission factors for conventional wells and assumes the rest is attributable to unconventional wells. The TSD provides no support in the EIA data for this assumption, nor does EPA explain why it uses an old emissions factor that has been revised in the TSD. Based on the lack of data, a more reasonable approach would be to adjust based on the fraction of conventional wells – 40 percent. Making this adjustment, conventional wells would be responsible for 18 Bcf, leaving 27 Bcf to unconventional wells. The TSD then applies all remaining emissions to completions, instead of first adjusting for workovers (the 45 Bcf applies to completions and workovers, but the TSD emissions estimate is for completions only). For example, according to data in the TSD, there were 13,403 unconventional well completions and workovers in 2007 and of these, 31 percent were workovers. After this adjustment, 18.6 Bcf are attributable to unconventional well completions. Dividing that by the number of completed wells yields an average emission rate of approximately 2,350/Mcf per completion – substantially less than half the estimate in the TSD. This provides further support to the conclusion emissions from unconventional well completions and workovers have been significantly overestimated.

**Comment:** Moreover, the emissions estimates assume that all of the gas is vented and none of it is flared. In discussing the effects of the new emissions estimates on inventories, the TSD assumed that about half of the wells would flare their emissions. This assumption itself is suspect, since it is based on an oversimplification of state regulations and not on industry practice. But it appears that the Draft Inventory may compound this by not assuming any flaring

*for unconventional completions or workovers – if flaring reductions are included, they are not readily identifiable. Our experience indicates that, while the amount of flaring will vary depending on state regulations and specific operational characteristics of the well, in many U.S. fields sending gas to flare is relatively easy and preferred to venting strictly for safety reasons (this is particularly true for sour gas). Coupled with state regulations requiring flaring or emissions controls (e.g. in Louisiana and Wyoming), failing to adequately account for flaring in the inventory will lead to an inaccurate estimate of emissions from completions and workovers. Accordingly, we ask EPA to clarify its flaring assumptions and provide further opportunity for comment.*

***Comment:** Finally, the Draft Inventory indicates that activity data were used, but does not specify the source or reference the data. The Draft Inventory also assumes that the emissions from completions and workovers are the same without providing an explanation on how these two different processes result in the same emissions. EPA should provide the activity data and an explanation of its assumption that emissions from completions and workovers are the same and provide an opportunity for stakeholder comment on this information.*

**Commenter: Fiji George, Carbon Strategies Director, El Paso Corporation**

**Well Clean up (Low Pressure Gas Wells)**

***Comment:** The US EPA has not accounted for the use of all artificial lift techniques in reducing or eliminating emissions.*

***Comment:** EPA does not indicate if the minimum volume or if an adjustment was made to account for potentially longer vent times in its computational methods.*

***Comment:** For complete transparency, EPA should publish the average characteristics used in its computational methods for each basin.*

***Comment:** EPA used statistically insignificant dataset to make a massive change in emission rates to represent the entire industry.*

***Comment:** The most significant issue with the approach applied to quantify low pressure well clean up emissions, and also a universal issue with EPA's national inventory, is that the national emission factors do not account for activities widely used by industry to reduce CH<sub>4</sub> emissions. If gas and liquids/water are piped separately to the surface from a gas well, and any artificial lift method (not just plunger lift) was applied to bring the liquids to the surface, then there would be no venting of gas and liquids from the well from liquids unloading.*

***Comment:** EPA must account for contribution and use of all such artificial lift practices in the emissions from liquids unloading activity and must revise its total emissions in a manner it provides a reasonable reflection of industry practices.*



## **Well Workovers and Completions**

**Comment:** EPA has made some undocumented increases in the emission factor for workovers.

**Comment:** EPA proposes that higher pressure frack fluid results in higher natural gas emissions. This conclusion has no documented basis.

**Comment:** EPA should indicate which of the numerous references listed for activity data are associated with the individual emission sources.

**Comment:** EPA has made some undocumented increase in the emission factor for workovers/completions to account for emission reductions that are subtracted from the inventory totals.

**Comment:** EPA should indicate which of the numerous references listed for activity data are associated with the individual emission sources, particularly if activity data are derived from other information.

**Comment:** EPA cites two Gas STAR presentations as the source of information for the unconventional well completion/workover emission factor. This is a statistically insignificant dataset to extrapolate to support for such a large increases for the entire industry.

**Comment:** EPA is assuming the total volume of gas is vented, which inflates the emission factor.

**Comment:** EPA has made some undocumented increase in the emission factor for completions to account for emission reductions that are subtracted from the inventory totals, when in actuality the regional emission factors reported in the inventory are somewhat less than the average value shown in.

**Comment:** EPA should reflect the actual flared and vented emissions, as represented by current industry practices, by appropriately accounting for completion emissions that are vented versus flared, and eliminate the artificial inflation of the emission factor and potential double counting of some completion activities.

**Comment:** The unconventional completion and workover emission factors are inflated by more than 4 times.

## **Condensate Tanks**

**Comment:** EPA does not account for emission reductions from the Natural Gas STAR and NESHAP programs and may have assumed a malfunction condition that results in inflated emission factors.

**Comment:** The percentages of control shown do not account for emission reductions reported through the Natural Gas STAR Program or associated with NESHAP Regulations.

**Comment:** These emissions may be attributed to separator dump valves malfunctioning or other methods of associated gas entering the tank and venting from the roof.

**Comment:** Comparing the TERC study results to the E&P Tank model results could result in drawing an incorrect conclusion because it assumes that the model runs accurately estimates the flashing losses.

**Comment:** If EPA wishes to accurately quantify emissions from separator dump valve malfunctions, testing or modeling should be performed to quantify emissions from tank flashing with and without malfunctioning dump valves, instead of an approach that compares measured data to a model.

**Comment:** EPA should clearly identify how the factors for both the Mid-Central and South West regions were adjusted. If Texas does fall within both the Mid-Central and South West regions, if the factors were truly scaled according to the counties affected, the factors should not be identical for both Mid-Central and South West regions.

**Comment:** The CO<sub>2</sub> emission factor does not mention the range of condensate production gravities from the HPDI database that were used to improve the methane emission factor.

**Comment:** It is recommended that EPA adopt this approach for other activities within the national inventory (e.g., well completions, well workovers, well clean ups, and compressor wet and dry seals), as described in the other sections of this report.

## **Centrifugal Compressors**

**Comment:** EPA has over-estimated the emissions for the processing sector by approximately 10.4% and the total inventory for the transmission/storage sector by approximately 4.2% due to incorrect averaging of the main data source.

**Comment:** If the emission factor calculated by using the correct average of the WGC data had been used in the draft inventory, then the emissions due to wet seal compressors would be reduced to 58% of the current estimate for processing, 60% of the current estimate for transmission, and 66% of the current estimate for storage. This would reduce the total inventory for the processing sector by approximately 10.4%, and the total inventory for the transmission/storage sector by approximately 4.2%.

## **General**

**Comment:** Given the extremely large changes that EPA has made in some categories from the previous published inventories, EPA should have provided all of the background data. In many cases, EPA has failed to provide the background information or data necessary to properly vet or test many of the alleged increased emissions. Neither the DRAFT inventory nor the Federal Register notice refer to the EPA's Mandatory Reporting Rule Subpart W Technical Support Document (TSD), which shaped the emissions estimates from certain sources that allegedly, contributed to the largest changes.

**Comment:** We are also very concerned that the EPA, in the haste of finalizing the inventory by April 15, 2011 will not have sufficient time to fully analyze and consider our comments. A revision of this magnitude to the inventory from the gas sector, when actual measured data is

*now being collected under requirements of Subpart W, seems unnecessarily hasty and potentially counter-productive. Some NGOs and certain members of the press have already begun to draw conclusions from some of the unvetted changes that EPA has made in this proposed inventory.*

**Comment:** *We are also concerned that the DRAFT inventory may become the basis for other mandatory reduction policies or rules currently being drafted by the EPA. Considering the far reaching implications, and since the goal is to “get the numbers sufficiently right”, we urge the EPA should to wait until real data is available in March 2012 and in the meantime revert back to the 2008 methods, rather than making unsubstantiated changes this year based on very limited data or ignoring the substantial reductions already undertaken by industry.*

**Commenter: Fredrick I. Rippee, PE**

**Comment:** *Hello Leif, It scares me that the EPA is about to increase regulations pertaining to the so-called climate change that appears to merely be alchemy created by some scientists bent on increased funding of their personal projects. The rest of the ethical scientists appear not to be on board with this alchemy. A short lesson in American history regarding her might will show that fossil fuel based manufacturing is the source of that might and economic prowess. A simple poll in world politics will show that the rest of society is belly laughing at how American bureaucrats blindly destroy American might - while the world ignores the 'climate change problem' - so that the net result is American stature is self destroyed while the world hysterically moves forward polluting through no control whatsoever to make their products that are ultimately sold in America. Those+E10 foreign products contribute factors of times more pollution to 'the planet' in foreign countries - countries grateful to the EPA for single handedly destroying American industry and moving the jobs, wealth and manufacturing overseas and out of EPA bullying reach. For what, I ask? Because we can? Do you really want to go down in history as the sonofbitches that finally did what the Soviets could not do - crush America? I don't believe that the EPA really gives a tinker's damn about realistic and balanced environmental regulation. If you did, you would do one simple and effective act: you would mandate that the US-wide incompetence of the holistic inability of city engineers to properly set traffic lights would be corrected. Look at your own data. A simple fix of setting traffic lights to ensure that traffic would remain at speed, following Newton's law that a body in motion tends to stay in motion unless acted upon by an external force, would enjoy minimal fuel consumption and, therefore, minimal 'climate change' gas production. It is a published fact that acceleration and idling of motor vehicle engines creates many times more 'climate change' gas than a vehicle at speed being maintained at speed. I have queried several city engineers and it is amazing how often these traffic stops are dictated by the engineers' boss to appease the mayor, city counsel, or other political abuse of power wielder, such that the entire town is forced to stop in front of their drapery - or other such similar - business in an unethical attempt to foster traffic from the street's stopped captive audience into their business. Therefore, that the EPA ignores their residential 'climate change' factor - the millions of unnecessary stoppages, idling, and accelerations due to traffic light incompetence - just signifies to me that this is a political blanket of feces designed to kill the American way of life through killing her industrial might. The EPA considers it a crime against nature to drop any petrochemicals, including fuel and lubricants,*

*onto the ground: the very ground from which those petrochemicals came. Additionally, the EPA mandates monitoring and tight control of petrochemical discharge into the atmosphere by virtually all industry and motor vehicles. We might have to breathe that. They are even considering regulating lawn mowers, for crying out loud. What's next, mammal flatulence? Regardless, the whole world fleet of major airliners atomize tens of thousands of pounds of petrochemicals into the atmosphere every day in the name of flight safety. Yes, it is a shame to waste all of that fuel. However, it goes to prove that purposeful atomization of those petrochemicals has daily literally flown in the face of EPA bemoaning, and, golly gee, Wilbur, 'the planet' seems to be doing just fine. My BS meter looks like a fan. I don't understand, you say? I am a degreed chemical engineer, have a professional chemical engineering license in two states, and have been working as a chemical engineer for over 30 years. I think I might get it. I implore you to give the Idaho salute to the loud mouthed ignoramuses eating granola, hugging trees and crapping in the woods and do your American duty of promoting growth in America by imposing on industry only those regulations that make a significant and real difference as balanced by the cost in jobs and might. The Love Canal regulations would fall in that set. 'Climate change' regulations would not.*

**Commenter: Jorge Verde**

*Comment: Dear EPA, You have no business wasting my time and money monitoring CO<sub>2</sub> or any other greenhouse gases. Your agency is more dangerous to the welfare and livelihood of people in this country than Islamic Terrorism. S., Jorge Verde, Pawtucket, RI*

*Comment: The epa should stay out of it. CO/CO<sub>2</sub> is not a pollutant. Nothing you can do will substantially alter it. Stop spending my money on this boondoggle. Your agency should be cut 90%.*

**Commenter: Juanita Nicholson**

*Comment: Please do everything in your power to protect our country's environment by regulating greenhouse gases. Everyone, whether Democrat or Republican, needs clean air to breathe!*

**Commenter: National Alliance of Forest Owners (NAFO)**

*Comment: NAFO supports EPA's use of the IPCC Guidelines in the GHG Inventory. Not only do the IPCC Guidelines produce meaningful data that can be compared over time and across countries, they also distinguish biomass emissions and fossil fuel emissions and demonstrate unequivocally that biomass is a carbon neutral energy source. Despite some calls for EPA to*

*adopt a different accounting method for biomass energy combustion, NAFO encourages EPA to continue its current practice which produces accurate and efficient GHG data for the forestry sector.*

**Commenter: Cynthia A. Finley, Director, Regulatory Affairs, National Association of Clean Water Agencies (NACWA)**

*Comment: NACWA believes that the Inventory emission calculation methods for nitrous oxide could still be improved to more accurately reflect actual emissions from POTWs. The Draft Inventory calculates nitrous oxide emissions using estimated nitrogen loadings to wastewater that are based on reported annual protein consumption, which is the method used in the Intergovernmental Panel on Climate Change (IPCC) protocol document1 (IPCC Guidelines). NACWA believes these loading rates are too high, and that EPA needs to conduct more research to determine more accurate loading rates to use in the Inventory. As NACWA has pointed out in its previous comments on the Inventory, the rates currently used in the Inventory are higher than rates presented in standard wastewater engineering references such as Metcalf & Eddy. Metcalf & Eddy reports a per capita nitrogen loading rate to wastewater of 15 g N/capita-day, a value usually considered the “industry standard” by POTWs. This value is supported by a wealth of data and has been widely confirmed in U.S. practice. The type of data used in Metcalf & Eddy represents all domestic sources of nitrogen, including meal production and consumption, the use of other nitrogen-containing compounds, and both residential and commercial sources. EPA states in the Draft Inventory that “the dataset previously provided by NACWA was reviewed to determine if it was representative of the larger population of centralized treatment plants for potential inclusion into the inventory.” However, EPA concluded that “this limited dataset did not represent the number of systems by state and the service populations served in the United States.” NACWA disagrees with this conclusion. The survey of measured nitrogen loading rates at POTWs illustrates that the Metcalf & Eddy loading rate is representative of U.S. POTWs, as are other published loading rates cited in NACWA’s previous comments. NACWA recommends that EPA conduct its own study of nitrogen loading rates to centralized treatment plants. EPA should have enough data available through its National Pollution Discharge Elimination System (NPDES) permitting program to determine an appropriate and justifiable nitrogen loading rate. The NPDES permitting program is nationwide in scope and long-term in nature, which would allow changes to be made in emissions estimates over the time series represented in the Inventory. Since EPA believes that further data of a broader and more representative scope are required before changing the Inventory, the NPDES database would certainly suffice as it represents every POTW in the U.S. NACWA believes that using the literature nitrogen loading values or EPA-collected values from U.S. POTWs would better reflect the actual emissions from POTWs than the current methods based on the IPCC Guidelines, which do not necessarily reflect actual conditions at POTWs throughout the nation. This is illustrated by the emission factor (“EF1”) of 3.2 g N<sub>2</sub>O/person-year for plants with no intentional denitrification, which is used in the Inventory and IPCC Guidelines to calculate nitrous oxide emissions from centralized wastewater treatment plants. This value was obtained from a single study of a very small wastewater treatment plant (1.06 million gallons per day, or MGD) in a small university town in New Hampshire. The population of this town is 12,500*

during the school year, but drops to 6,200 in the summer months, during which most of the measurements for this study were made. If the IPCC can use this single study to define an emission factor that is used for centralized treatment facilities all over the world, certainly EPA can justify changing the nitrogen loading rate for facilities in the U.S. based on literature values and data that it can collect from POTWs across the nation.

**Comment:** In the  $N_2O_{\text{EFFLUENT}}$  equation (line 45, page 8-13), the USPOP factor should be multiplied by the WWTP factor, as it is in the  $N_2O_{\text{WOUT NIT/DENIT}}$  equation, since septic system users should not be included in the amount of effluent discharged to aquatic environments. NACWA recommends that any nitrous oxide contributions from septic systems be calculated in a separate equation if they are to be included in the Inventory.

**Comment:** The value of 271 Tg N for  $N_{\text{SLUDGE}}$  (line 46, page 8-15) appears to be an error, resulting in a negative value for  $N_2O_{\text{EFFLUENT}}$ . The value of 144 Gg N found in the Draft Inventory Annex in Table A-206 (page A-254) is a more appropriate magnitude. However, even substituting this 144 Gg N value for  $N_{\text{SLUDGE}}$  does not result in a  $N_{\text{TOTAL}}$  value that agrees with the value of 16.2 Gg  $N_2O$  in Table 8-7. EPA must review the equation for  $N_2O_{\text{EFFLUENT}}$  and all of the values used in it for accuracy.

**Commenter: Patricia Brewer, Acting Chief, Air Resources Division,  
National Park Service**

**Comment:** Now that EO 13514 has directed federal agencies to develop GHG inventories, there are now two different national inventories of GHG emissions in existence, and they are not formatted to be comparable. The Department of Energy-Federal Energy Management Program (FEMP) Federal GHG Accounting Guide was used for the first time in January 2011 for Federal agencies to submit 2008 baseline and 2010 inventories. The DOE-FEMP guidance uses the same IPCC guidelines as EPA, but because the inventory formats are so different, it is almost impossible to compare the results of the EPA Inventory with the DOE-FEMP submittals. EPA's Draft U.S. GHG Emissions & Sinks organizes the inventory by source category and sector and does not use the terms followed by the FEMP inventory: "scope 1, 2, or 3," "FEMP," "Federal GHG Accounting," or "Executive Order 13514." The DOE-FEMP GHG Accounting Guidance inventories report emissions by Scopes 1, 2, and 3, which are based on federal or contractor responsibility rather than by source category. The DOE-FEMP inventory does not refer to the EPA inventory categories. Since the Executive Order 13514 has made more people aware of GHG emissions and efforts to inventory them, it would be helpful to discuss in the draft EPA inventory how or whether the DOE-FEMP GHG Accounting Guidance relates to the U.S. GHG Emissions & Sinks Inventory.

**Commenter: Claudio H. Ternieden, Assistant Director of Research,  
Water Environment Research Foundation (WERF)**

*(See Attachments B and C for referenced reports)*

**Determining the N<sub>2</sub>O Generation Potential of Wastewater**

*Comment: Page 8-7 - Line 27/28 “The principal factor in determining the N<sub>2</sub>O generation potential of wastewater is the amount of N in the wastewater” WERF suggests the following clarification of the above statement to read: “the principal factors in determining N<sub>2</sub>O generation potential are the amount and variability of influent N-loading to a plant and the operating conditions of the plant itself”. This clarification is important because WERF has conducted studies at wastewater treatment plants (WERF Report U4R07a Interim Report Greenhouse Gas Emissions from Wastewater Treatment Operations (2010)) [see Attachment B for this report] and found that wastewater treatment operations (over loaded and under-designed plants across numerous process configurations) generated higher levels of N<sub>2</sub>O than some other differently-designed and operated BNR facilities, which generated very little N<sub>2</sub>O. Variability in the generation of N<sub>2</sub>O across BNR and other treatment plants is considerable. In other words, the “amount of N in the wastewater” is not “[t]he principal factor in determining the N<sub>2</sub>O generation potential of wastewater” by itself, but that operating conditions of the plant itself is an important component in the determination of the appropriate N<sub>2</sub>O generation potential of wastewater.*

**Domestic Wastewater N<sub>2</sub>O Emission Estimates**

*Comment: Page 8-14 - Lines 41 – “Approximately 7 grams N<sub>2</sub>O is generated per capita per year if wastewater treatment included intentional nitrification and denitrification”; and Line 47- “Plants without intentional nitrification/denitrification are assumed to generate 3.2 grams N<sub>2</sub>O per capita per year.” Based on our study (WERF Report U4R07a Interim Report Greenhouse Gas Emissions from Wastewater Treatment Operations (2010)) [see Attachment B for this report], WERF discourages EPA from using these single emission factors as identified in Lines 41 and 47 of page 8-14. Our study identified such variability in N<sub>2</sub>O emissions from our set of monitored wastewater plants - both those with nitrification and denitrification and those considered conventional activated sludge processes- that identifying single factors or averages such as these are statistically inappropriate and could be rendered meaningless from data that does not exhibit central tendency according statistical principals.*

*Comment: Page 8-17- Line 33 “Such data will be reviewed to determine if a country-specific N<sub>2</sub>O emission factor can be developed”. WERF appreciates that the Agency is reviewing our two reports: 1) on N<sub>2</sub>O emissions from municipal wastewater treatment systems (WERF Report U4R07a) [see Attachment B for this report]; and 2) on greenhouse gas emission from septic systems (WERF Report DEC1R09 Evaluation of Greenhouse Gas Emissions from Septic Systems (2010) [see Attachment C for this report]. Both reports contain a lot of new data. The N<sub>2</sub>O generation report will be released as a final report with more facility data by the end of 2011. However, we are concerned that the Agency is still supporting a single, country-specific emissions factor based on the nitrogen present in the wastewater, although our study shows that operations also affect N<sub>2</sub>O generation and emission, therefore rendering a country-specific emissions factor potentially meaningless.*

# Attachment A





**Karin Ritter**  
Manager

Regulatory and Scientific Affairs

1220 L Street, NW  
Washington, DC 20005-4070  
USA  
Telephone 202-682-8472  
Fax 202-682-8270  
Email [ritterk@api.org](mailto:ritterk@api.org)  
[www.api.org](http://www.api.org)

March 25, 2011

Mr. Leif Hockstad and Mr. Brian Cook  
U.S. Environmental Protection Agency, Climate Change Division (6207J)  
1200 Pennsylvania Ave., NW  
Washington, DC 20460  
[hockstad.leif@epa.gov](mailto:hockstad.leif@epa.gov) and [cook.brianb@epa.gov](mailto:cook.brianb@epa.gov)

Re: Review of EPA's Draft Inventory of U.S. Greenhouse Gas Emissions and Sinks: 1990-2009

Dear Sirs:

The American Petroleum Institute (API) appreciates the opportunity to offer input to the US EPA on the draft 1990-2009 US inventory of greenhouse gas (GHG) emissions (referred to as the 2009 national inventory).

As you know, API represents about 400 companies involved in all aspects of the oil and natural gas industry throughout the USA and globally. Over nearly a decade, API has developed an extensive record of ongoing activities related to GHG emissions estimation and reporting, and its guidelines are used worldwide for developing corporate GHG emission inventories for all segments of the oil and natural gas industry. This experience includes:

- Production of the *Petroleum Industry Guidelines for Reporting Greenhouse Gas Emissions* (IPIECA/OGP/API, December 2003, revised version expected Fall 2011);
- Development of the *API Compendium of Greenhouse Gas Emissions Estimation Methodologies for the Oil and Gas Industry* ('Road Test' version April 2001; Revised February 2004, Revised August 2009); and
- Participation in the Expert 'Cadre' of the US Technical Advisory Group (TAG) to the International Standards Organization (ISO).

Our comments are organized to focus first on the most significant inventory changes and API's most significant comments. Additional recommendations and editorial revisions follow.

Some significant changes have been made to specific emission factors in the inventory this year. We anticipate that the inventory will continue to change and be refined as companies begin reporting under the GHG Reporting Program (GHGRP). As a result, we are concerned that revisions to the inventory this year will be misinterpreted to imply significant under reporting of specific emission sources. We request that EPA reformat the presentation of information provided in the inventory to appropriately reflect current emission reduction activities. Further details are provided below.

## 1. Significant Inventory Revisions and Issues

### 1.1 Emission Reductions

The most significant issue with EPA's 2009 national inventory is that the national emission factors do not account for activities widely used by industry to reduce CH<sub>4</sub> emissions. EPA indicates (page A-150) that “*accounting for CH<sub>4</sub> reductions reported to the Natural Gas STAR Program and CH<sub>4</sub> reductions resulting from regulations, such as the National Emissions Standards for Hazardous Air Pollutants (NESHAP)<sup>1</sup> regulations is done after the total national inventory is compiled.*” (emphasis added). EPA provides the total sector emission reductions in Tables A-125 and A-126, for Natural Gas STAR and regulatory driven reductions, respectively. However, the reductions shown are not split by emission source type. Not clearly identifying the reductions associated with each emission source, consistent with the presentation of emission factors by source, implies that the sources emit larger quantities of GHG than they actually do. Emission reductions for many of the inventory source types, especially the sources which were revised as a part of the 2009 inventory (e.g., gas well cleanups) are significant.

EPA also indicates that “*Before incorporating the reductions into the Inventory, quality assurance and quality control checks are undertaken to identify errors, inconsistencies, or irregular data. The checks include matching Natural Gas STAR reported reductions to specific inventory sources to make sure that a reported reduction for one source is not greater than the emission estimate for that source. This check has lead (sic) to emissions updates to sources such as well completions and workovers, and well clean up.*” This implies that if EPA Natural Gas STAR emission reductions are greater than EPA's national estimate of emissions for a particular source, then EPA inflates the national emission result, presumably by inflating the emission factor, so that the reduction does not produce a negative emission. EPA indicates that such an adjustment was made to the completion, workover, and well clean up emission factors, but does not elaborate on the method or significance of the adjustments. This also indicates that EPA has the information available to report the reductions for each individual emission source.

The result is that the emission factors reported by EPA are artificially inflated to balance out the Natural Gas STAR reductions, and do not account for significant emission reduction and emission controls. The inflated national emission factors may result in a false conclusion that emissions from some of the source types (particularly those that EPA has recently modified) have been significantly underestimated in the past. For full transparency and a realistic representation of the industry operational practices, EPA's reported emission factor for each source type should account for the emission reduction practices and regulatory impacts within each region.

To further investigate the transparency of the reported Natural Gas STAR reduction data, the 2009 CH<sub>4</sub> reductions in Table A-125 of the draft 2009 national inventory attributed to EPA Natural Gas STAR were compared to the Gas STAR paper, *EPA Natural Gas STAR Program Accomplishments for 2009*, as shown in Table 1. As shown, the 2009 CH<sub>4</sub> emission reductions reported in the draft EPA national inventory attributed to Gas STAR are higher than the reductions reported in the Gas STAR accomplishments paper, and the differences are not

---

<sup>1</sup> 40 CFR 63 Subpart HH regulates glycol dehydrators, flashing losses, and fugitives.

explained. EPA should clearly document the differences and explain the basis for the values provided in Table A-125.

**Table 1. Comparison of 2009 Methane Emission Reductions from EPA Inventory and Natural Gas STAR**

<b>Industry Sector</b>	<b>Table A-125 of Draft 1990-2009 EPA GHG Inventory (Gg/yr)</b>	<b>Gas STAR Program Accomplishments (Original units, Bcf/yr)</b>	<b>Gas STAR Program Accomplishments (Converted to Gg/yr<sup>a</sup>)</b>
Production	1,993	70	1,318
Processing	83	3.7	69.7 <sup>b</sup>
Distribution	367	10.7	201.5 <sup>c</sup>
	41	2.1	39.6
<b>Total</b>	<b>2,484</b>	<b>86</b>	<b>1,629</b>

<sup>a</sup> Converted from standard cubic feet to mass assuming standard conditions of 14.7 psia and 68°F.

<sup>b</sup> Includes processing and gathering.

<sup>c</sup> Includes transmission but the Gas STAR paper is not clear whether storage is included.

## 1.2 Gas Well Workovers

For the 2009 inventory, EPA split gas well workovers into two emission sources: conventional gas well workovers and unconventional gas well workovers. EPA classifies unconventional wells as those involving hydraulic fracturing, and notes in the Technical Support Document (TSD) associated with 40 CFR 98 Subpart W<sup>2</sup> that “*it is understood that not all unconventional wells involve hydraulic fracturing, but some conventional wells are hydraulically fractured, which is assumed to balance the over-estimate.*” Industry commented on the proposed Subpart W that the terms “conventional” and “unconventional” were confusing and not commonly used by industry. For consistency and clarity, EPA should adopt the terminology used in the final Subpart W (i.e., with and without hydraulic fracturing).

While the emission factors for conventional (without hydraulic fracturing) gas well workovers are on the same order of magnitude as the “well workover” factors that were used in the 2008 inventory, the unconventional (with hydraulic fracturing) well workover factors are over three thousand times larger, which seems to be excessively overestimated with no applicable documentation. Table 2 compares the 2008 and 2009 workover emission factors by region.

<sup>2</sup> EPA, Greenhouse Gas Emissions Reporting From the Petroleum and Natural Gas Industry, Background Technical Support Document, November 9, 2010.

**Table 2. Comparison of Well Workover Emission Factors for 2008 and 2009.**

Region	2008 Well Workovers		2009 Conventional Wells		2009 Unconventional Wells	
	Emission Factor, scf/workover	Count of Workovers	Emission Factor, scf/workover	Count of Workovers	Emission Factor, scf/workover	Count of Workovers
North East	2,463	7,595	2,612	7,997	7,694,435	0
Mid Central	2,584	3,602	2,604	3,793	7,672,247	1,328
Rocky Mountain	2,447	3,848	2,442	4,299	7,194,624	2,342
South West	2,507	1,655	2,507	1,807	7,387,499	1,374
West Coast	2,861	74	2,861	78	8,429,754	0
Gulf Coast	2,757	3,019	2,759	3,265	8,127,942	0
<b>Total</b>		<b>19,793</b>		<b>21,239</b>		<b>5,044</b>

The national inventory does not describe how EPA determined the emission factors for conventional gas well workovers. However, the TSD indicates an emission factor for well workovers from the EPA/GRI study is applied for conventional wells. The emission factor provided in the EPA/GRI study is 2,454 Mcf of methane/workover. Minor adjustments to this emission factor are believed to be reflected in Table 2 to account for different methane compositions in each region. For unconventional well workovers, the TSD indicates that the emission factor is assumed to be the same as unconventional well completions. An analysis of the unconventional completion emission factor and emission estimates is provided in the following section.

As noted previously, EPA adjusts the total national inventory for emission reductions reported through the Gas STAR program and reductions that results from regulatory requirements, such as NESHAP. Hence, it is also not possible to determine which of the emission reductions shown in Table A-125 and A-126 are attributed unconventional well workovers, as the tables do not split reductions by activity.

### 1.3 Unconventional Well Completions

As a part of the 2009 inventory, “unconventional well completions” is added as a new emission source to the "Drilling and Well Completion" inventory category. Unconventional well completions now account for approximately 7% of the total natural gas production CH<sub>4</sub> emissions, where as in 2008, “well drilling” emissions accounted for approximately 0.07% of total natural gas production CH<sub>4</sub> emissions.

EPA’s inventory documentation does not reference the source of information for the reported counts of wells drilled and unconventional completions. The only statement is that “the

Inventory tracks activity data for unconventional well counts (which we assumed to be completed by hydraulic fracture for the purposes of this analysis) in each region.” EPA should indicate which of the numerous references listed for activity data are associated with the individual emission sources, particularly if activity data are derived from other information.

The regional emission factors used for unconventional gas well completions are the same as those used for unconventional gas well workovers (shown in Table 2). The emission factors for unconventional gas well completions are much larger than the emission factors for well drilling; as noted for well workovers. EPA justifies the use of larger emission factors due to the higher pressure venting of gas used to drive large volumes of liquid from the production well.

As mentioned for unconventional well workovers, EPA does not describe how the emission factor for unconventional gas well completions was developed. For unconventional completions, the TSD associated with 40 CFR 98 Subpart W indicates the emission factor was derived from participant information shared and presented at Natural Gas STAR technology transfer workshops. EPA cites two Gas STAR presentations as the source of information for the unconventional well completion/workover emission factor<sup>3</sup>. The TSD for Subpart W provides further details on the data specifically used in developing the Subpart W average emission factor of 9,175 Mscf/completion. It is assumed that the emission factors shown in Table 2 vary from the Subpart W average emission factor due to different gas compositions in the region, but this is not documented in the inventory.

Table 3 summarizes the information presented in the two Gas STAR presentations referenced in the 2009 national inventory and demonstrates the basis for the average emission factor.

**Table 3. Data Support EPA’s Emission Factor for Unconventional Completions/Workovers**

Data Source		# Wells	Gas Volumes	Uncontrolled Emission Factor, Mscf/well	Rounded Emission Factor, Mscf/well	Notes and Comments
“Green Completions”, Lessons Learned from Natural Gas STAR, Producers Technology Transfer Workshop, September 21, 2004 <sup>4</sup>	2002 EIA Data	7,783	44.7 Bcf	5,744	6,000	The EIA gas volumes represent combined vented and flared gas from completions
	Source not identified	No count provided	7 to 12,500 Mcf recovered (2-89% of total gas)	3,000	EPA did not use this data.	

<sup>3</sup> EPA. Reducing Methane Emissions During Completion Operations. Natural Gas STAR Producer’s Technology Transfer Workshop. September 11, 2007.

Available online at: <[http://epa.gov/gasstar/documents/workshops/glenwood-2007/04\\_recs.pdf](http://epa.gov/gasstar/documents/workshops/glenwood-2007/04_recs.pdf)>.

EPA. Green Completions. Natural Gas STAR Producer’s Technology Transfer Workshop. September 21, 2004.

Available online at: <<http://epa.gov/gasstar/workshops/techtransfer/2004/houston-02.html>>.

<sup>4</sup> <http://www.epa.gov/gasstar/documents/workshops/houston-2004-2/GreenCompletions.ppt>

Data Source		# Wells	Gas Volumes	Uncontrolled Emission Factor, Mscf/well	Rounded Emission Factor, Mscf/well	Notes and Comments
	BP	106	350 MMscf total gas recovered	3,669	EPA did not use this data.	Uncontrolled emission factor assumes 90% of the gas was recovered
	Devon	30	Total not provided	11,900	10,000	Gas volume represents recovered natural gas
	CBM wells	3	2.22 MMscf	741	700	
"Reducing Methane Emissions During Completion Operations", 2007 Natural Gas STAR Production Technology Transfer Workshop, September 11, 2007 <sup>5</sup>	Williams, 2006	426	10.9 Bcf	25,500	20,000	Williams' presentation provides data that demonstrates the majority of this gas is recovered, and the small amount that is not recovered is either vented or flared (see Table 6)
	Williams, 2005	275	8.07 Bcf	29,345		
	Williams, 2004	241	5.06 Bcf	20,996		
	Williams, 2003	76	1.23 Bcf	16,145		
	Williams, 2002	46	0.79 Bcf	17,261		
					9,175	Straight Average

API notes the following based on reviewing the information in Table 3:

- EIA clearly indicates that the volumes reported are vented and flared emissions combined. EPA is assuming the total volume of gas is vented, which inflates the emission factor. It is also interesting that although EIA reports this information annually, EPA only evaluated the 2002 data presented in the Gas STAR report.
- EPA did not use the information provided by the second (unidentified) source. This data set shows a wide spread of recovered gas volumes and percentages. As this was presented at a Gas STAR workshop, it would be useful if EPA could request more details on this data from the source of the information.
- It is not clear why EPA did not include the information presented by BP. The BP data point represents a controlled completion and would support the development of a controlled emission factor.
- The Williams data provides the total amount of gas generated from completions. However, the Williams presentation provides data that demonstrates the majority of this gas is recovered, and the small amount that is not recovered is either vented or flared. **In fact, using the data Williams provides, which demonstrates the actual emissions that result accounting for emission reduction activities, produces an average emission factor of approximately 2,000 Mscf/well, which is about one-fifth of the emission factor used in EPA's inventory.**

<sup>5</sup> [http://www.epa.gov/gasstar/documents/workshops/glenwood-2007/04\\_recs.pdf](http://www.epa.gov/gasstar/documents/workshops/glenwood-2007/04_recs.pdf)

For this source it is not clear where EPA may adjust the emissions to account for emission reduction activities or regulatory requirements, such as flaring. EPA notes *“some states, such as Wyoming, may require that natural gas produced during well completions not be vented. In these regions emissions from natural gas well completions and re-completions are either recovered for sales or must be flared. The volume of gas recovered by bringing equipment to the wellsite for the treatment and injection of the produced completion gas into the sales pipeline is reported by Natural Gas STAR. The remaining volume of completion gas from states that do not allow the venting of this gas is flared”*. The inventory includes a source “completion flaring” but EPA does not discuss how this source relates to the unconventional completion emissions.

The number of completions flared does not appear to have changed, and in fact is slightly larger for 2009 compared to 2008. This indicates that EPA has not made a significant adjustment to the accounting for emissions from completion flaring. However, it would seem that some portion of the unconventional completion emissions would be flared and should thus be represented in the source category for completion flaring. EPA should reflect the actual flared and vented emissions, as represented by current industry practices, by appropriately accounting for completion emissions that are vented versus flared and eliminating the artificial inflation of the emission factor and potential double counting of some completion activities.

#### 1.4 Well Clean Ups (LP gas wells)

In the 2009 inventory, the total emissions from “well clean ups” account for approximately 51% of the total natural gas production sector CH<sub>4</sub> emissions. For comparison, in the 2008 inventory, well clean up emissions accounted for approximately 6% of the total natural gas production CH<sub>4</sub> emissions, when not accounting for emission reductions due to Natural Gas STAR or other regulations.

EPA notes that the methodology for quantifying emissions from this source category was revised to include a large sample of well and reservoir characteristics from the HPDI database of production and permit information along with an engineering equation to estimate the volume of natural gas necessary to expel a liquid column choking the well production. The approach used for the emission factor is based on a fluid equilibrium calculation to determine the volume of gas necessary to blow out a column of liquid for a given well pressure, depth, and casing diameter.

EPA notes in Section 3.6 that the HPDI database for well production and well properties was queried to obtain sample data on average well depth, shut-in pressure, well counts, and well production rates from each basin. Although EPA does not state explicitly, it is implied that differences in these characteristics across basins account for the regional differences reported in the inventory. For complete transparency, EPA should publish the equation and the average characteristics used for each basin.

Emission reductions for this source type are significant. EPA even notes that emission reductions may be under reported in the Planned Improvements portion of Section 3.6, and that the potential for emission reductions from gas well cleanups to be underestimated will be investigated in the next Inventory cycle. The Natural Gas STAR Lessons Learned for installing plunger lift systems reports emission reduction ranging from 4,700 to 18,250 Mscf/yr. In

addition, the West Coast emission factor, the second largest of the regional factors, clearly does not account for the practices in California, where petroleum producers have strict emission controls on CH<sub>4</sub>. EPA describes in Annex 3.4 that some states may require that natural gas produced during well completions not be vented; in these regions the natural gas is recovered to sales or flared. The natural gas from gas well clean ups can also be recovered to sales or flared. Alternatively, if gas and liquids/water are piped separately to the surface from a gas well, and any artificial lift method (not just plunger lift) was applied to bring the liquids to the surface, then there would be no venting of gas and liquids from the well from liquids unloading. All such artificial lift practices and other methods for reducing emissions should be clearly identified in EPA's inventory. The inventory should provide separate factors for controlled and uncontrolled activities, as is done for condensate tanks.

### 1.5 Flashing Losses from Oil and Condensate Tanks

The 2009 national inventory includes an adjustment to the condensate tank emission factors for the Mid-Central and South West regions for both condensate tanks without control devices and condensate tanks with control devices. EPA noted in Section 3.6 that the 2009 inventory includes, for the first time, data from a Texas Environmental Research Consortium (TERC) study (TERC 2009)<sup>6</sup> which provided a small sample of data representing two regions in Texas where separator dump valve malfunctions were detected and measured. The TERC study measured emissions rates from several oil and condensate tanks in Texas. These data were plotted and compared to flashing emissions simulated via E&P Tanks. EPA observed that the E&P Tanks results indicated additional emissions beyond flashing losses were present in approximately 50 percent of the tanks and concluded that the emissions may be attributed to separator dump valves malfunctioning or other methods of associated gas entering the tank and venting from the roof.

It is not clear how EPA applied the TERC study data to determine the 2009 emission factors. The TERC study specifically addressed Volatile Organic Compounds (VOC) emissions from oil and condensate storage tanks, and also provided vent sample data, including for methane. The TERC study was designed to specifically capture all of the emissions from each tank, and therefore it is unlikely that half of the tanks measured would have missed emissions. In addition, the TERC study did not capture all of the input data necessary to run E&P Tanks (e.g., pressurized separator liquid compositions). Therefore, it seems more likely that the "additional emissions" resulting from EPA's simulation runs of the flashing emissions are actually a result of assumptions EPA used to assign the model input parameters.

Furthermore, the E&P Tanks modeling EPA is referencing does not incorporate dump valve malfunctions as an emission parameter in the model algorithm. If EPA wishes to accurately quantify emissions from separator dump valve malfunctions, testing should be performed to specifically focus on emissions from malfunctioning dump valves.

---

<sup>6</sup> TERC (2009). VOC Emissions from Oil and Condensate Storage Tanks. Hendler, Albert, URS Corporation; Nunn, Jim, COMM Engineering; Lundeen, Joe, Trimeric Corporation. Revised April 2, 2009. Available online at: <<http://files.harc.edu/Projects/AirQuality/Projects/H051C/H051CFinalReport.pdf>>.



The activity factors for condensate tanks did not vary significantly from 2008 to 2009. However, EPA does not clearly identify how the throughput is differentiated between tanks with and without control devices. Instead, it appears that the same throughput is being applied to each tank type, presumably based on an assumption that 50% of tanks are controlled. EPA should clearly identify what source was used to obtain the throughput information for each tank type.

## 1.6 Centrifugal Compressors

The 2009 inventory includes for the first time emission factors for centrifugal compressors by seal type (wet and dry seals, respectively) for the natural gas processing and natural gas transmission sectors. Table 4 compares the 2008 and 2009 emission factors and equipment counts by sector.

**Table 4. Comparison of Centrifugal Compressor Emissions for 2008 and 2009**

Sector	2008 Inventory		2009 Inventory			
	Centrifugal Compressors		Centrifugal Compressors – Wet Seals		Centrifugal Compressors – Dry Seals	
	Emission Factor (scfd/compressor)	Number of Compressors	Emission Factor (scfd/compressor)	Number of Compressors	Emission Factor (scfd/compressor)	Number of Compressors
Natural Gas Processing	21,230	771	51,370	646	25,189	140
Transmission	30,305	705	50,222	667	32,208	55
Storage	30,573	116	45,441	84	31,989	29

As shown in Table 4, the emission factors for centrifugal compressors increased from 2008 to 2009, regardless of seal type. The resultant emissions increase was most significant in the gas processing sector. Table 4 also shows that the activity factors for compressors have been split into compressors with wet and dry seals. However, EPA does not clearly identify how the counts of compressors were allocated between wet and dry seals or what information source EPA used to make this allocation. An EPA Natural Gas STAR Lessons Learned paper on replacing wet seals with dry seals<sup>7</sup> notes that about 90 percent of all new compressors come with dry seals. It is anticipated that the number of centrifugal compressors with wet seals will decrease over time as centrifugal compressors with wet seals are replaced by centrifugal compressors with dry seals.

EPA notes that the centrifugal compressor emission factors were revised as a part of the 2009 inventory based on guidance from a World Gas Conference paper (WGC, 2009), which gathered 48 sample measurements of centrifugal compressor wet seal oil degassing emissions and published the results. The World Gas Conference paper, which is cited as the source of the 2009 inventory emission factors, is actually in turn citing a combination of data provided in the

<sup>7</sup> EPA (2006b) Replacing Wet Seals with Dry Seals in Centrifugal Compressors. Lessons Learned from Natural Gas STAR Partners. October 2006. <[http://epa.gov/gasstar/documents/ll\\_wetseals.pdf](http://epa.gov/gasstar/documents/ll_wetseals.pdf)>.

Natural Gas STAR paper on replacing wet seals with dry seals<sup>8</sup> and a Methane to Markets study of measurements at four gas processing plants<sup>9</sup>. The WGC report notes that

*“Methane to Markets experience, combined with another assessment of four natural gas facilities, has identified measurements from 48 wet seal centrifugal compressors, with methane emissions totaling 14,860 thousand m<sup>3</sup> methane/year. The data, which show that seal oil degassing rates for individual compressors could range from 0 to 2,756 thousand m<sup>3</sup>/year, can be divided into two groups: a low-emitting group (33 compressors) and a high-emitting group (15 compressors). The low emitters have an average emission rate of 26 thousand m<sup>3</sup> methane/year for a single compressor. The high emitters have an average emission rate of 934 thousand m<sup>3</sup> methane/year for a single compressor.”*

The basis of the EPA wet seal emission factors is not clear and is inconsistent with Subpart W of the EPA’s Mandatory Reporting Rule. Subpart W, §98.233(o)(7), presents a default wet seal compressor emission factor of 12.2 million scf methane/yr (at 68°F and 14.7 psia), which converts to 33,425 scfd/compressor – consistent with the data presented in the WGC report. The values used for the 2009 EPA inventory are much higher, at 51,370 scfd/compressor for processing, 50,222 scfd/compressor for transmission, and 45,441 scfd/compressor for storage. EPA does not provide documentation to explain the basis for the differences among the industry sectors. The Subpart W default emission factor for wet seal compressor degassing is based on 14,860 thousand m<sup>3</sup> methane/yr from the World Gas Conference paper divided by 43 centrifugal compressors (EPA Technical Support Document, 2010). Note that denominator is 43 compressors rather than all 48. The Technical Support Document indicates that five of the 48 wet seal centrifugal compressors were found to not be emitting<sup>10</sup>; thus the emission factor is incorrectly averaged only over the leaking compressors and does not account for the fact that a portion of the compressor seals do not leak, thus the total number of compressors (i.e. 48) ought to be included when deriving the emission factor.

Table 5 of the Methane to Markets paper presents a comparison of the emission factors measured during the study to the EPA/GRI 1996 emission factors. The average factor measured for compressor seals was 0.852 kg THC/h/source, while the EPA/GRI (1996) study average factor was actually larger by about 30%, at 1.172 kg THC/h/source. Footnote 4 to Table 5 notes that the *“compressor seals component category accounts for emissions from individual compressor seals. As compressor seal leakage was typically measured from common vent and drain lines, emissions have been divided evenly among the seals on units with detected leakage.”* The factors are not split by wet or dry seals. As Appendices I and II (containing site specific field measurement data) are missing to protect business confidentiality, it is not possible to determine whether the study further separates compressor seal measurements into wet and dry seals.

---

<sup>8</sup> EPA (2006b) Replacing Wet Seals with Dry Seals in Centrifugal Compressors. Lessons Learned from Natural Gas STAR Partners. October 2006. <[http://epa.gov/gasstar/documents/ll\\_wetseals.pdf](http://epa.gov/gasstar/documents/ll_wetseals.pdf)>.

<sup>9</sup> EPA/GTI/Clearstone. Identification and Evaluation of Opportunities to Reduce Methane Losses at Four Gas Processing Plants. June 20, 2002. <[http://epa.gov/gasstar/documents/four\\_plants.pdf](http://epa.gov/gasstar/documents/four_plants.pdf)>.

<sup>10</sup> EPA (2010) Greenhouse Gas Emissions Reporting from the Petroleum and Natural Gas Industry, Background Technical Support Document. 2010. <[http://www.epa.gov/climatechange/emissions/downloads10/Subpart-W\\_TSD.pdf](http://www.epa.gov/climatechange/emissions/downloads10/Subpart-W_TSD.pdf)>.

EPA does not directly cite a source for the updated dry seal emission factors, but provides in the References section for the Natural Gas Systems a reference to the Natural Gas STAR paper discussed above. The executive summary of the paper notes that dry seals emit up to 6 scfm; on page 4 of the paper it is noted that dry seals emit less during normal operation (0.5 to 3 scfm across each seal, depending on the size of the seal and operating pressure). The cost savings in Exhibit 5 are calculated assuming 2 dry seals at a total of 6 scfm.

If EPA is citing the Natural Gas STAR paper as the reference for the dry seal emission factor, it can be assumed that the emission factor derived from such data will be on an order of magnitude similar to that provided in the reference document. It can conservatively be assumed that the emissions will be estimated using the maximum leakage rate (6 scfm), instead of the normal operation leakage rate (0.5 to 3 scfm). However, when converting the 6 scfm identified in the Natural Gas STAR paper to a scfd basis, as is used in the 2009 inventory, the factor should be around 8,640 scfd/compressor on a natural gas basis, even lower on a methane basis, and significantly less than the factor shown in the 2009 inventory for natural gas processing (25,189 scfd/compressors), transmission (32,208 scfd/compressors), and storage (31,989 scfd/compressors). EPA should explain these differences and clearly state the reference of the emission factors for each segment.

## **2. Additional Comments on the Revised National Inventory**

### **2.1 National Energy Modeling System (NEMS) Regions**

EPA notes that the regions are divided in accordance with the National Energy Modeling System. However, according to EIA<sup>11</sup>, the NEMS regions are: Pacific, Mountain, West North Central, East North Central, New England, Middle Atlantic, South Atlantic, East South Central, and West South Central. EPA should clearly identify which of the NEMS regions are included in each of the natural gas production regions (North East, Mid-Central, Rocky Mountain, South West, West Coast, and Gulf Coast).

In addition, Texas (the state for which the TERC study was conducted) falls into one NEMS region: West South Central. Yet in the 2009 inventory, the condensate storage tank emission factors for both the Mid-Central and South West regions were revised. EPA notes in Section 3.6 that because the TERC dataset was limited to represent production from only 14 counties that represent 0.5 percent of U.S. production, the national emission factor was scaled up such that only production from these counties is affected by the occurrence of associated gas venting through the storage tank. EPA should clearly identify how the factors for both the Mid-Central and South West regions were adjusted. If Texas does fall within both the Mid-Central and South West regions, and if the factors were truly scaled according to the counties affected, the factors should not be identical for both Mid-Central and South West regions.

### **2.2 Updated API Compendium**

API provided comment on the draft 1990 – 2008 inventory that, as indicated above, API revised the API Compendium in 2009. References to emission factors from the API Compendium

---

<sup>11</sup> EIA. The National Energy Modeling System: An Overview 2009. <[http://www.eia.doe.gov/oiaf/aeo/overview/figure\\_1.html](http://www.eia.doe.gov/oiaf/aeo/overview/figure_1.html)>

should be updated to reflect the 2009 version of API's *Compendium of Greenhouse Gas Emissions Estimation Methodologies for the Oil and Gas Industry*. For example, Section 3.7 Petroleum Systems (p. 3-51, line 15) and Annex 3.5 Petroleum Systems (p. A-168, line 34) reference "API (2004)", but should instead reference the newest version of the API Compendium as the source of the asphalt blowing emission factor.

### 2.3 Asphalt Blowing

API provided comment on the draft 1990 – 2008 inventory that the most significant change noted in the 2008 national inventory was the addition of asphalt blowing CO<sub>2</sub> emissions for refineries in the Petroleum Systems category. This emission source accounted for 36% of the total non-combustion CO<sub>2</sub> emissions from petroleum systems in 2008, and accounts for 31% of the total non-combustion CO<sub>2</sub> emissions from petroleum systems in 2009.

The CH<sub>4</sub> factor for asphalt blowing in the 2009 EPA *Inventory of Greenhouse Gas Emissions and Sinks* is the same as is used in the 2008 EPA *Inventory of Greenhouse Gas Emissions and Sinks*. As a part of API's comments on the draft 1990 – 2008 inventory, API also noted that neither emission factor is consistent with the 2009 API Compendium. The 2009 Compendium presents the same factor as the 2004 API Compendium, which is the cited source of the emission factor used in the EPA *Inventory of Greenhouse Gas Emissions and Sinks*.

The 2009 API Compendium cites a simple emission factor for uncontrolled asphalt blowing from AP-42 (EPA, AP-42, Section 5.1.2.10, 1995). The AP-42 emission factor for asphalt blowing is assumed to be on an air-free basis (AP-42 does not specify this, but notes the factor represents "emissions"). Asphalt blowing exhaust composition data (13 mol% CH<sub>4</sub> and 9 mol% CO<sub>2</sub>, on an air free basis) presented in an Oil & Gas Journal article<sup>12</sup> is applied to derive the CH<sub>4</sub> and CO<sub>2</sub> emission factors of 5.55E-4 tonnes CH<sub>4</sub>/bbl asphalt blown and 1.01E-3 tonnes CO<sub>2</sub>/bbl asphalt blown, respectively. (Further details on the derivation of these emission factors are provided in Appendix B of the 2009 API Compendium.)

For comparison, the EPA emission factors converted to a similar basis are 4.9E-5 tonnes CH<sub>4</sub>/bbl and 1.09E-3 tonnes CO<sub>2</sub>/bbl. However, the primary distinction between the API Compendium emission factors and those used in the EPA inventory is the units of measure applied to the activity factor. The API emission factors are based on the volume (or mass) of asphalt blown, while the EPA emission factors appear to be based on the total volume of asphalt produced (411 Mbbbl/cd production). As a result, the EPA emission factors result in much higher emission estimates.

### 2.3 Refining Emissions

There are a number of sources that do not appear to be included in the national GHG inventory. For the refining sector, these include CO<sub>2</sub> emissions from flares, hydrogen production, catalytic cracking units, fluid coking units, catalytic reforming units, sulfur recovery units, and coke calcining units. Emissions from each of these sources are required to be reported under the

<sup>12</sup> Dimpfl, L.H. Study Gives Insight Into Asphalt Tank Explosions, "Oil and Gas Journal", December 1980

GHGRP, and for which EPA had to assess the emissions as part of the justification for their inclusion in the regulation. The inventory should incorporate EPA's current understanding of these emissions or document why they are excluded from the inventory.

## 2.4 Alignment with the EPA GHG Reporting Program

EPA indicates in the Planned Improvements portion of both of Sections 3.6 (Natural Gas Systems) and 3.7 (Petroleum Systems) that data collected through 40 CFR Part 98 (Mandatory Reporting of Greenhouse Gases; Final Rule) will be used as a source for potential improvements to the inventory. API supports the continued improvement of the national inventory, but urges EPA to provide transparent justification and formal technical review for the changes.

In Section 3.6 (page 3-48, line 25) EPA notes that reporting will begin in 2010 for natural gas suppliers. EPA is referring to reporting under Subpart NN (Suppliers of Natural Gas and Natural Gas Liquids) for local distribution systems. However, Subpart NN only requires reporting of volumes and emissions associated with potential end-use combustion of the natural gas and the natural gas liquids supplied. The information reported under Subpart NN does not represent actual emissions, and if the gas supplied were to be combusted their emissions would fall under Section 3.1 (Fossil Fuel Combustion), not to Section 3.6.<sup>13</sup>

EPA should clarify that data collection begins for Subpart NN in 2010, with emissions reported beginning in 2011 for calendar year 2010. In addition, if EPA is implying that emissions reported under Subpart W will be used to improve the Natural Gas Systems inventory, EPA should clarify that data collection for Subpart W begins in 2011, with emission reporting beginning in 2012 for calendar year 2011.

In Section 3.7 (page 3-52, line 37) EPA notes that U.S. petroleum refineries will be required to calculate and report their greenhouse gas emissions beginning in 2010. EPA should clarify that data collection begins for petroleum refineries in 2010, with emissions reported beginning in 2011 for calendar year 2010.

## 3. Recommendations

1. (Section 3.6 and Annex 3.4, Natural Gas Systems) The changes to the emission factors for gas well workovers, gas well cleanups, well completions, condensate storage tanks, and centrifugal compressors should all be documented in Section 3.6 and Annex 3.4, as discussed above. Many other emission factors also changed from 2008 to 2009; a few examples are provided in Table 5. One example is provided for each region except West Coast, for which the emission factor revisions are due to rounding differences between the two inventories. Note that the table below is not all inclusive of the emission factor revisions. The reasons for all emission factor revisions should be documented in the inventory, not just the reasons for major emission factor revisions.

---

<sup>13</sup> Interestingly, in Section 3.7 Petroleum Systems (page 3-50, line 14), EPA notes that "the estimates of CH<sub>4</sub> emissions from petroleum systems do not include emissions downstream of oil refineries because these emissions are negligible."

**Table 5. Examples of 2008 to 2009 Emission Factor Revisions**

Activity	Region	Emission Factor	
		2008	2009
Small Reciprocating Compressors	North East	269 scfd/comp	284.95 scfd/comp
Large Reciprocating Compressors	Mid-Central	16,013 scfd/comp	16,135 scfd/comp
Normal Operations – Dehydrator Vents	Rocky Mountain	274.3 scf/MMscf	275 scf/MMscf
SW – Unconventional Gas Wells	South West	NA	36.52 scfd/well
Large Reciprocating Stations	Gulf Coast	9,266 scfd/station	9,270.90 scfd/station

2. (Annex 3.4 Natural Gas Systems) Emission factors and activity factors are only provided for 2008 (with the exception of “key activity data drivers” provided in Table A-124), yet emissions are shown for multiple years. API recommends adding emission and activity factors for all years for which emissions are being estimated, for full disclosure. (In addition, it is discussed in Step 1 that activity factors vary by year.)
3. (Annex 3.4 Natural Gas Systems) If emission factors determined for 1995 are assumed to be representative of emissions from each source type over the period 1990 through 2009, API recommends adding that information to Step 1 or Step 3, similar to the text in Annex 3.5 Petroleum Systems, p. A-168, line 21. Alternatively, if emission factors are not assumed to be representative of emissions from each source type over the period 1990 through 2009, this should be noted as well, and emission factors should be added for all years for which emissions are being estimated, for full disclosure.
4. (Annex 3.5 Petroleum Systems) Emission factors and activity factors are only provided for 2009, yet emissions are shown for multiple years. API recommends adding emission and activity factors for all years for which emissions are being estimated, for full disclosure. (In addition, it is discussed in Step 2 that activity factors vary by year.)

#### 4. Editorial Comments

- (Section 3.7 Petroleum Systems, Tables 3-43, 3-46, and 3-47) API recommends adding a note that indicates “Totals may not sum due to independent rounding.”
- (Section 3.7 Petroleum Systems, Tables 3-43) The values shown for Tank Venting for 2005, 2006, and 2008 should be 0.2 Tg CO<sub>2</sub> Eq., not 0.3 Tg CO<sub>2</sub> Eq. This change corresponds with the values shown in Table A-142 for Tank Venting. API recommends verifying the values.
- (Section 3.7 Petroleum Systems, Table 3-47) The totals shown appear to vary more than would be due to rounding error. For example, the 2008 total should be approximately 43,410 Gg, but is shown as 43,311 Gg. API recommends verifying the totals.
- (Section 3.7 Petroleum Systems, Tables 3-43 and 3-46) Where tables are split onto multiple pages, EPA should add the table header for each continued page.

- (Annex 3.4 Natural Gas Systems, and Annex 3.5 Petroleum Systems) Multiple table references have a space before the table number. Tables are currently referenced as “Table A-X” and should be “Table A-X”.
- (Annex 3.4 Natural Gas Systems, p. A-150, Step 1, Second Paragraph, Line 3) The reference to “Table A-123” should instead be to “Table A-124”.
- (Annex 3.4 Natural Gas Systems, Multiple Tables) Where tables are split onto multiple pages, EPA should add table header for each continued page.
- (Annex 3.4 Natural Gas Systems, Table A-123) Emission factor units for Mishaps (Dig-ins) should be “Mscfy/mile” instead of “mscfy/mile”, to be consistent with the other units presented in the annex.
- (Annex 3.4 Natural Gas Systems, Table A-125) API recommends adding a note that indicates “Totals may not sum due to independent rounding.”
- (Annex 3.5 Petroleum Systems, Tables A-136 through A-138, and Table A-141) API recommends adding a header row above the last four columns noting “2009 EPA Inventory Values”, similar to the table presentation for Annex 3.4 (Natural Gas Systems).
- (Annex 3.5 Petroleum Systems, p. A-170, Table A-137) Remove the period after “bbl” in the units for the emission factor and activity factor for Heaters.
- (Annex 3.5 Petroleum Systems, p. A-170, Table A-138, and p. A-172, Table A-141) API recommends spelling out “cd” for emission factors with units of “cd refinery feed” or “cd feed”.
- (Annex 3.5 Petroleum Systems, p. A-170, Table A-137) API recommends formatting with the Activity Factor for the Marine Loading and Pump Stations activity factors. The Marine Loading activity factor appears to have a digit (4) on the row below; the Pump Station activity factor does not clearly show all digits.
- (Annex 3.5 Petroleum Systems, p. A-169) API recommends mentioning Table A-140, and how the values presented are used in calculation of the CO<sub>2</sub> emissions presented in Annex 3.5.
- (Annex 3.5 Petroleum Systems, p. A-171, Table A-139) API recommends adding a note that indicates “Totals may not sum due to independent rounding.”
- (Annex 3.5 Petroleum Systems, p. A-172, Table A-142) The value shown for Production Field Operations should be 317 instead of 319, which affects the total row in Table A-142 (the total should be 461 Gg instead of 463 Gg) and the values shown in Table 3-43 and Table 3-44.

Sincerely,

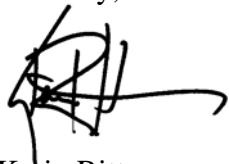

Karin Ritter

# Attachment B





Water Environment Research Foundation  
*Collaboration. Innovation. Results.*

Climate Change



**FINAL  
REPORT**

# Greenhouse Nitrogen Emission from Wastewater Treatment Operations

INTERIM REPORT

**U4R07a**

# GREENHOUSE NITROGEN EMISSION FROM WASTEWATER TREATMENT OPERATIONS

INTERIM REPORT

by:

**Kartik Chandran, Ph.D.**

Department of Earth and Environmental Engineering

Director, CUBES Program

Columbia University

*2010*



## Attachment B

The Water Environment Research Foundation, a not-for-profit organization, funds and manages water quality research for its subscribers through a diverse public-private partnership between municipal utilities, corporations, academia, industry, and the federal government. WERF subscribers include municipal and regional water and wastewater utilities, industrial corporations, environmental engineering firms, and others that share a commitment to cost-effective water quality solutions. WERF is dedicated to advancing science and technology addressing water quality issues as they impact water resources, the atmosphere, the lands, and quality of life.

For more information, contact:  
Water Environment Research Foundation  
635 Slaters Lane, Suite G-110  
Alexandria, VA 22314-1177  
Tel: (571) 384-2100  
Fax: (703) 299-0742  
[www.werf.org](http://www.werf.org)  
[werf@werf.org](mailto:werf@werf.org)

© Copyright 2010 by the Water Environment Research Foundation. All rights reserved. Permission to copy must be obtained from the Water Environment Research Foundation.

Library of Congress Catalog Card Number: 2010930022

Printed in the United States of America

This report was prepared by the organization(s) named below as an account of work sponsored by the Water Environment Research Foundation (WERF). Neither WERF, members of WERF, the organization(s) named below, nor any person acting on their behalf: (a) makes any warranty, express or implied, with respect to the use of any information, apparatus, method, or process disclosed in this report or that such use may not infringe on privately owned rights; or (b) assumes any liabilities with respect to the use of, or for damages resulting from the use of, any information, apparatus, method, or process disclosed in this report.

Columbia University

This document was reviewed by a panel of independent experts selected by WERF. Mention of trade names or commercial products or services does not constitute endorsement or recommendations for use. Similarly, omission of products or trade names indicates nothing concerning WERF's positions regarding product effectiveness or applicability.

## ACKNOWLEDGMENTS

Several global collaborations participated in this project. Funding from the District of Columbia Water and Sewer Authority (DCWater), the Los Angeles County Sanitation Districts and SCAP, the Southern California Alliance of Publicly Owned Treatment Works (POTWs) supplemented the full-scale monitoring effort of this WERF project. In a Targeted Collaborative Research component, utilities (New York City Department of Environmental Protection, Los Angeles City Department of Public Works, Alexandria (Virginia) Sanitation Authority, City of Stamford, Connecticut, Central Davis (Utah) Sewer District, and Metropolitan Water Reclamation District of Greater Chicago contributed funds or in-kind support. Under the Global Water Research Coalition (GWRC), the project team and WERF shared protocols and results with researchers in the Netherlands and Australia. The Principal Investigator, Kartik Chandran also spent a six month sabbatical at the Delft University of Technology researching mechanisms of autotrophic N<sub>2</sub>O and NO emissions. Several collaborative works have already resulted from the exchange between Columbia and Delft. Funding was provided by the National Science Foundation CAREER and TU-Delft Visiting Professor awards to Prof. Kartik Chandran. A newly established collaboration between DCWASA, George Washington University and Columbia University is also underway.

### Report Preparation

**Principal Investigator:**

Kartik Chandran Ph. D.  
*Columbia University*

### Research Team:

Joon Ho Ahn, *Columbia University, Doctoral Candidate*  
 Hongkeun Park, *Columbia University, Doctoral Candidate*  
 Sungpyo Kim, Ph.D., *Columbia University, Post Doctoral Fellow*  
 Brian Rahm, Ph.D., *Columbia University, Post Doctoral Fellow*  
 Krishna Pagilla, Ph.D., P.E., *Illinois Institute of Technology*  
 Dimitri Katehis, Ph.D., P.E., *CH2M HILL*  
 William Hiatt, Ph. D., P.E. *CH2M HILL*

### Project Subcommittee

Gregory M. Adams, *LA County Sanitation Districts*  
 Eugenio Geraldo, Ph.D., *American Water*  
 Sudhir Murthy, Ph.D., *DC Water*  
 Denny Parker, Ph.D., *Brown and Caldwell*  
 Peter Strom, Ph.D., *Rutgers University*  
 Jeffrey Weiss, *LA County Sanitation Districts*

### Water Environment Research Foundation Staff

**Director of Research:** Daniel M. Woltering, Ph.D.  
**Program Director:** Lauren Fillmore, M.Sc.

# TABLE OF CONTENTS

Acknowledgements.....	iii
List of Tables .....	vii
List of Figures.....	viii
List of Acronyms .....	x
Executive Summary .....	ES-1
<b>1.0 Literature and Introduction.....</b>	<b>1-1</b>
1.1 Background.....	1-1
1.2 Mechanisms of Autotrophic N <sub>2</sub> O and NO Emissions.....	1-3
1.3 Impact of Different External Carbon sources on N <sub>2</sub> O Emissions from Denitrification.....	1-4
1.4 Organization of Report .....	1-5
<b>2.0 Methods and Procedures – Protocol for Determination of N<sub>2</sub>O Emissions Fluxes and Other Analytical Procedures .....</b>	<b>2-1</b>
2.1 Introduction.....	2-1
2.2 Sampling Design for Full-Scale Monitoring.....	2-1
2.3 Sampling Procedures-Headspace Gas Measurement.....	2-2
2.4 Sampling Procedures-Aqueous N <sub>2</sub> O Concentrations.....	2-3
2.5 Sampling Procedures-Measurement of Advective Gas Flow Rate from Bioreactor Headspace .....	2-3
2.6 Determination of Advective Gas Flowrates through the Flux-Chamber from Non-Aerated Zones.....	2-3
2.7 Sampling Procedures-Wastewater and Process Characterization.....	2-4
2.8 Intensive On-Site Sampling and Analysis .....	2-4
2.9 Sample Collection Responsibilities .....	2-5
2.10 Principles of real-time N <sub>2</sub> O, NO and NO <sub>2</sub> measurements .....	2-5
2.10.1 Principles of N <sub>2</sub> O Measurement .....	2-5
2.10.2 Principles of NO and NO <sub>2</sub> Measurement.....	2-5
2.11 Data Analysis and Processing.....	2-6
2.11.1 Determination of Fluxes .....	2-6
2.11.2 Determination of Lumped Emission Fractions .....	2-6
2.11.3 Calculation of N <sub>2</sub> O Emission Factors .....	2-7
2.11.4 Correlation between WWTP Operating Conditions and N <sub>2</sub> O Emissions .....	2-8
2.12 Standardization of Protocol and Comparison with Established Emissions Flux Measurement Methods.....	2-8
2.13 Sampling and Analytical Methods and Procedures for Pure Culture Lab-Scale Nitrification Studies.....	2-14
2.13.1 Cell Cultivation.....	2-14
2.13.2 Cell Collection and RNA Extraction .....	2-15
2.13.3 Functional Gene Expression .....	2-15
2.13.4 Link between Specific Activity of <i>N. europaea</i> Cultures and N <sub>2</sub> O Emissions .....	2-16

2.14	Sampling and Analytical Methods and Procedures for Mixed Culture Lab-Scale Denitrification Studies .....	2-17
2.14.1	Bioreactor Operation.....	2-17
2.14.2	Characterization of Steady-State and Transient State Operations .....	2-17
2.14.3	Headspace N <sub>2</sub> O and NO Measurements .....	2-18
2.14.4	Extant Biokinetics of Denitrification .....	2-18
<b>3.0</b>	<b>Summary of Process Schematics Sampled .....</b>	<b>3-1</b>
<b>4.0</b>	<b>Results: Nitrous Oxide Emissions Fluxes from Full-Scale Activated Sludge in the United States .....</b>	<b>4-1</b>
4.1	N <sub>2</sub> O Emission Fluxes from Activated Sludge Processes.....	4-1
4.2	Model Based Discrimination of Process Operating Conditions Contributing to N <sub>2</sub> O Emission.....	4-2
4.3	Spatial and Temporal Variability in N <sub>2</sub> O Generation and Emission from Selected Full-Scale BNR and Non-BNR Processes.....	4-4
4.3.1	Spatial and Temporal Trends in N <sub>2</sub> O Emission Fluxes from Full-Scale WWTPs.....	4-4
4.3.2	Four-Pass Step-Feed BNR Process.....	4-4
4.3.3	Four-Stage Bardenpho Process .....	4-5
4.3.4	Low-Rate Separate Stage Nitrification-Denitrification Process.....	4-6
4.3.5	Plug-Flow Processes .....	4-6
4.3.6	Four-Pass Step-Feed (non-BNR) Process (covered aeration tanks).....	4-7
4.4	Conclusions.....	4-7
<b>5.0</b>	<b>Results: Molecular Mechanisms of Autotrophic N<sub>2</sub>O and NO Generation and Emission .....</b>	<b>5-1</b>
5.1	Impact of Anoxic Conditions on Nitrification by <i>Nitrosomonas europaea</i> 19718 ..	5-1
5.2	Impact of Transient Anoxic Conditions on Whole-Cell Responses .....	5-1
5.3	Impact of Transient Anoxia on Gene Expression.....	5-2
5.4	Directionality in N <sub>2</sub> O Generation .....	5-2
5.5	Mechanisms of Autotrophic Responses to Transient Anoxia.....	5-3
5.6	N <sub>2</sub> O and NO as Indicators of Metabolic Activity in <i>N. europaea</i> .....	5-4
5.7	Conclusions.....	5-4
<b>6.0</b>	<b>Results: Factors Promoting Emissions of Nitrous Oxide and Nitric Oxide from Denitrifying Sequencing Batch Reactors Operated with Methanol and Ethanol as Electron Donors .....</b>	<b>6-1</b>
6.1	Steady State Performance and Emissions of N <sub>2</sub> O and NO during Denitrification Using Methanol and Ethanol as Electron Donors.....	6-1
6.2	Impact of Transient Carbon Limitation .....	6-1
6.3	Impact of Nitrite Inhibition.....	6-2
6.4	Impact of Oxygen Inhibition.....	6-3
6.5	Conclusions.....	6-4

<b>7.0</b>	<b>Interim Conclusions, Recommendations, and Ongoing Studies</b> .....	7-1
7.1	N <sub>2</sub> O Emissions from Different WWTP Configurations .....	7-1
7.2	Estimation of N <sub>2</sub> O Emission Factors .....	7-1
7.3	N <sub>2</sub> O Emissions from Different WWTP Configurations .....	7-1
7.4	Implications of Variability in N <sub>2</sub> O Emissions on Inventory Calculations.....	7-2
7.5	Mechanisms of N <sub>2</sub> O Emissions by Nitrification and Denitrification .....	7-2
7.6	N <sub>2</sub> O Emissions from WWTPs and Sustainable BNR Design and Operations ....	7-3
7.7	Ongoing Studies and Future Perspectives.....	7-3
Appendix A: Field Protocol with Quality Assurance Plan .....		A-1
Appendix B: Data (available on CD Rom by request) .....		B-1
Appendix C: Process Schematics of WWTPs Sampled .....		C-1
References.....		R-1

**LIST OF TABLES**

3-1	Summary of Process Schematics Sampled .....	3-2
4-1	Summary of N <sub>2</sub> O Fluxes and Emission Factors Measured at Full-Scale WWTPs ....	4-9
4-2	Factors Correlating with N <sub>2</sub> O Emission Fluxes (g N <sub>2</sub> O-N/day) from Aerobic Zones ..	4-10
4-3	Factors Correlating with N <sub>2</sub> O Emission Fluxes (g N <sub>2</sub> O-N/day) from Anoxic Zones....	4-10
4-4	Comparison of N <sub>2</sub> O Emissions from Full-Scale Studies Conducted to Date .....	4-11
5-1	Endpoint and Real-Time PCR Primers Employed in this Study .....	5-6



## LIST OF FIGURES

2-1	Schematic of Flux-Chamber Employed for N <sub>2</sub> O Measurement.....	2-10
2-2	Comparison Between N <sub>2</sub> O Fluxes Obtained via Three Independent Methods.....	2-11
2-3	Comparison Between Gas Flow Rates Obtained via the Tracer Gas (CES) and Successive Dilution (WERF-Columbia) Methods .....	2-12
2-4	Illustration of Spatial and Temporal Variability in N <sub>2</sub> O Concentrations in the Headspace of an Aerobic Zone .....	2-13
4-1	N <sub>2</sub> O Emissions from Aerobic and Anoxic Zones in Different WWTPs Measured at High (A) and Low (B) Temperatures.....	4-12
4-2	Time-Varying N <sub>2</sub> O Emission Factors for Four Select Processes Sampled in this Study at 23 ± 0.28°C (A), 23 ± 0.20°C (B), 26 ± 0.81°C (C) and 34 ± 0.32°C (D) .....	4-13
4-3	Spatial Profile of Gaseous N <sub>2</sub> O Concentrations and Typical Activated Sludge Variables in a Full-Scale Step-Feed BNR Process Showing Individual Sampling Locations .....	4-14
4-4	Diurnal Variability in Gaseous N <sub>2</sub> O Concentrations Measured from an Aerobic Zone of the Full-Scale Step-Feed BNR Process Depicted in Figure 4-3 .....	4-15
4-5	Spatial Profile of Gaseous N <sub>2</sub> O Concentrations and Typical Activated Sludge Variables In a Full-Scale Four-Stage Bardenpho Process .....	4-16
4-6	Diurnal Variability in Gaseous N <sub>2</sub> O Concentrations Measured from the First Aerobic Zone (A-B) and First Anoxic Zone (C-D) of the Full-Scale Four-Stage Bardenpho Process Depicted In Figure 4-4 .....	4-17
4-7	Spatial Profile of Gaseous N <sub>2</sub> O Concentrations and Typical Activated Sludge Variables in a Full-Scale Separate-Stage Nitrification-Denitrification Process .....	4-18
4-8	Spatial Profile of Gaseous N <sub>2</sub> O Concentrations and Typical Activated Sludge Variables in a Full-Scale Plug-Flow Process .....	4-19
4-9	Spatial Profile of Gaseous N <sub>2</sub> O Concentrations and Typical Activated Sludge Variables in a Full-Scale Plug-Flow Process .....	4-20
4-10	Spatial Profile of Gaseous N <sub>2</sub> O Concentrations and Typical Influent and Effluent Variables in a Full-Scale Step-Feed (Non-BNR) Activated Sludge Process.....	4-21

5-1	Electron Transport Pathway in <i>N. Europaea</i> .....	5-7
5-2	Impact of Transient Oxygen Limitation on <i>N. Europaea</i> .....	5-8
5-3	Concurrent Peaking of $Q_{ns}/Q_{max,Ns}$ and Gaseous $N_2O$ Concentrations .....	5-9
5-4	Impact of Transient Oxygen Limitation on Select Functional Gene Expression Profiles In <i>N. Europaea</i> .....	5-10
6-1	Fraction of Influent Nitrate Load Emitted as $N_2O$ And NO in (A) Methanol Fed SBR and (B) Ethanol Fed SBR.....	6-5
6-2	Representative $N_2O$ (Primary Axis) and NO (Secondary Axis) Emissions from (A) Methanol Fed SBR and (B) Ethanol Fed SBR.....	6-6
6-3	Representative Nitrate and Nitrite Concentrations from (A) Methanol Fed SBR and (B) Ethanol Fed SBR .....	6-7
6-4	$N_2O$ and NO Emissions from Ethanol Fed SBR Under Steady State (A) and Different DO Concentrations (B-D) .....	6-8
6-5	Impact of DO Concentrations on Biokinetics of Methanol and Ethanol Based Denitrification .....	6-9

## LIST OF ACRONYMS

ASM	Activated Sludge Model	TKN	Total Kjeldahl nitrogen
BNR	Biological Nutrient Removal	U.S EPA	U.S. Environmental Protection Agency
BOD	Biochemical Oxygen Demand	WERF	Water Environment Research Foundation
COD	Chemical Oxygen Demand	IPCC	Intergovernmental Panel on Climate Change
DO	Dissolved oxygen	WWTP	Wastewater Treatment Plants
N <sub>2</sub> O	Nitrous oxide	Nir	Nitrite Reductase
NO	Nitric oxide	Nor	Nitric oxide Reductase
GHG	Greenhouse gas	NaR	Nitrate Reductase
GWRC	Global Water Research Coalition	N <sub>2</sub> OR	Nitrous oxide Reducatase
mg/L	Milligrams per Litre	SCAQMD	South Coast Air Quality Management District
mgd	Million-Gallons per Day	AOB	Ammonia-oxidizing Bacteria
SRT	Solids Retention Time	N <sub>2</sub> O <sub>4</sub>	Dimeric nitrogen dioxide
NH <sub>4</sub> <sup>+</sup>	Ammonium	SEIFC	Surface emission isolation flux chamber
NH <sub>2</sub> OH	Hydroxylamine	GC	Gas Chromatograph
O <sub>3</sub>	Ozone	TCD	Thermal Conductivity Detector
nm	Nanometer	IR	Infra-red
sCOD	Soluble Chemical Oxygen Demand	FTIR	Fourier Transform Infrared Spectroscopy
ATCC	American Type Culture Collection	AMO	Ammonia monooxygenase
PCR	Polymerase Chain Reaction	HAO	Hydroxylamine oxidoreductase
sOUR	Specific Oxygen Uptake Rate	NIOSH	National Institute for Occupational Safety and Health
DNA	Deoxyribonucleic acid	ORP	Oxidation Reduction Potential
Da	Dalton	MLE	Modified Lutzack Ettinger
SBR	Sequencing Batch Reactor	rbCO	readily biodegradable COD
HRT	Hydraulic Retention Time	ffCOD	filtered-flocculated chemical oxygen demand
ppmv	Parts Per Million by Volume	RNA	Ribonucleic acid
sDNR	Specific Denitrification Rates	mRNA	messenger RNA
UQ	Ubiquinone	rRNA	Ribosomal RNA
N <sub>2</sub>	Nitrogen gas	Cyt	Oxidase Cytochrome Oxidase

# EXECUTIVE SUMMARY

## Problem Definition

The push to achieve greater nutrient removal from wastewater treatment plant effluents has resulted in the development of a wide range of innovative biological nitrogen removal (BNR) processes. However, BNR strategies could be a potential contributor to atmospheric N<sub>2</sub>O and NO depending upon the reactor configurations and operating conditions. In the future, as BNR is implemented at wastewater treatment plants nationwide, the flux of these gases to the atmosphere could increase. Such increased releases would be of possible concern since the greenhouse impact of nitrous oxide is about three hundred times that of carbon dioxide.

## Project Description

The goal of this project is to characterize nitrogenous emissions from the activated sludge portion (only) of wastewater treatment plants. This project represents one of the first attempts at characterizing nitrogenous GHG emissions from wastewater treatment plants, and at developing a methodology for collection of full scale plant data from a range of nutrient removal facilities in the United States. Building on previous work by the project team, this information will be integrated into a mechanistic activated sludge process model, which will be refined through this project by the addition of autotrophic pathways for N<sub>2</sub>O and NO emission. The refined mechanistic model will allow the industry to codify the results of this research, and develop a tool that will aid in the prediction and therefore, mitigation of N<sub>2</sub>O, NO, and NO<sub>2</sub> emissions from WWTPs utilizing a range of wastewater treatment processes. Ultimately, this would allow the wastewater sector to engineer strategies for wastewater treatment that minimize gaseous nitrogen oxide emissions.

This study is the first of its kind in the United States and there are only two other similar studies being conducted in the Netherlands and Australia. To facilitate a global monitoring effort, the protocol developed in this study has been shared upon request with additional groups in Spain, Portugal, Germany and Belgium, which are just beginning similar monitoring programs. It is expected that broad application of the protocol will allow WWTPs to quantify their N<sub>2</sub>O emissions using a standard approach and to ultimately engineer environmentally sustainable BNR operating strategies and configurations.

## Project Objectives

The objectives of this project were to:

- ◆ Identify principal aqueous and gaseous intermediates in activated sludge tanks under different configurations, nitrogen loads, and operating conditions (i.e. extant dissolved oxygen concentrations).
- ◆ Determine the relative mechanisms and contributions of oxidative and reductive pathways in gaseous nitrogen oxide production by activated sludge bacteria.
- ◆ Develop a tool based on activated sludge model (ASM) algorithms augmented to allow the results of this research to be codified and available for use. The tool will facilitate optimization of nutrient removal processes to minimize both aqueous and gaseous nitrogen greenhouse gas (GHG) emissions. This step is not part of this interim study report.
- ◆ Conduct a full-scale demonstration study aimed at mitigation of N<sub>2</sub>O emissions at a selected BNR activated sludge facility. This step is ongoing and also not included in this interim report.

These project objectives have been accomplished via two inter-related components: characterization of nitrogen greenhouse gas emissions from full scale wastewater treatment operations (nitrification/denitrification process tanks) and bench-scale reactors experiments conducted at Columbia University.

## Project Results and Findings

**National-Scale N<sub>2</sub>O Measurement Survey:** A wide range of N<sub>2</sub>O emissions was measured across the twelve WWTPs around the United States. For the twelve plants included in this analysis, on average, the fraction of influent TKN emitted as N<sub>2</sub>O (mass/mass) was in the range 0.01-1.8%. Measured emission factors (g-N<sub>2</sub>O/population equivalent flow-year) were in the range 0.28-140. Emissions from aerobic zones were consistently higher than those from anoxic zones. Based on a multivariate linear regression model, ammonia, DO and nitrite concentrations correlate positively with N<sub>2</sub>O emissions fluxes from aerobic zones. In anoxic zones, DO and nitrite correlate positively with N<sub>2</sub>O emissions fluxes. Significant temporal variability was also observed in N<sub>2</sub>O emissions with liquid-phase N-species concentrations correlating well with N<sub>2</sub>O headspace concentrations. Based on these observations, a single lumped emission factor approach to ‘estimating’ N<sub>2</sub>O emissions from wastewater treatment processes is not appropriate. Furthermore, due to significant differences in local or global wastewater composition (Tchobanoglous et al., 2003), the use of flow normalized emission factors to describe N<sub>2</sub>O emissions is not recommended. Although not the primary focus of this study, emissions of nitric oxide (NO) were also concurrently measured during each sampling campaign. NO emissions

were consistently far lower than N<sub>2</sub>O emissions by at least a factor of 10-100. However, the *trends* in the concentration profiles of N<sub>2</sub>O and NO were nearly identical. This parallel is consistent with the sequential formation of NO and N<sub>2</sub>O by both nitrification and denitrification pathways.

**Molecular Mechanisms of N<sub>2</sub>O and NO Emissions from Nitrification:** Based on lab-scale studies, the mechanisms of autotrophic (from nitrification) N<sub>2</sub>O emissions were determined at the whole-cell and gene expression levels by subjecting chemostat cultures of *Nitrosomonas europaea* 19718 to transient anoxia. Contrary to the governing hypotheses, researchers found that N<sub>2</sub>O production via nitrification is related to a *recovery* from anoxic conditions rather than *imposition* thereof. Additionally, in contrast to N<sub>2</sub>O generation by denitrifying bacteria, the generation of NO and N<sub>2</sub>O were mutually exclusive. N<sub>2</sub>O generation occurred only during aerobic conditions whereas NO generation occurred only during anoxic conditions. The extent of N<sub>2</sub>O emissions was also linked to ammonia concentrations in the nitrifying bioreactor. The production of NO and N<sub>2</sub>O was attributed to a major imbalance at the gene expression level. Finally, a new dimensionless number that captures the ratio of the specific substrate utilization rate to the maximum substrate utilization rate, was formulated and used to describe the propensity of nitrifying bacteria for N<sub>2</sub>O production.

**Factors Impacting N<sub>2</sub>O and NO Emissions from Denitrification:** Lab-scale studies were also conducted to determine the factors for N<sub>2</sub>O from denitrifying reactors operated using methanol and ethanol as external carbon sources. During steady-state operation, emissions of both N<sub>2</sub>O and NO from either reactor were minimal and in the range of <0.2% of influent nitrate-N load. Subsequently, the two reactors were challenged with transient organic carbon limitation and nitrite pulses, both of which had little impact on N<sub>2</sub>O or NO emissions for either electron donor. In contrast, transient exposure to oxygen led to increased production of N<sub>2</sub>O (up to 7.1% of influent nitrate-N load) from ethanol grown cultures, owing to their higher kinetics and potentially lower susceptibility to oxygen inhibition. A similar increase in N<sub>2</sub>O production was not observed from methanol grown cultures. These results suggest that for dissolved oxygen, but not for carbon limitation or nitrite exposure, N<sub>2</sub>O emissions from heterotrophic denitrification reactors can vary as a function of the electron donor used.



## CHAPTER 1.0

## LITERATURE AND INTRODUCTION

**1.1 Background**

Based on recent field-scale measurements, engineered BNR facilities, while effective to varying degrees in reducing *aqueous* nitrogen pollution, could emit up to 7% of the influent nitrogen load as *gaseous* N<sub>2</sub>O and NO (Kampschreur et al., 2008b). Such emissions are deleterious to the environment. The greenhouse equivalence of N<sub>2</sub>O is about three hundred times that of carbon dioxide and both N<sub>2</sub>O and NO contribute to depletion of the ozone layer (Ravishankara et al., 2009).

Although, from a fundamental perspective, N<sub>2</sub>O and NO are known intermediates in heterotrophic denitrification (Knowles, 1982; Zumft, 1997) and autotrophic nitrification and denitrification (Anderson and Levine, 1986; Anderson et al., 1993; Kester et al., 1997; Ritchie and Nicholas, 1972; Stuvén et al., 1992), the net contribution of BNR processes to N<sub>2</sub>O emissions from wastewater treatment has only recently been explicitly acknowledged (U.S. EPA, 2009). Based on the latest U.S. EPA report on sources and sinks of N<sub>2</sub>O from wastewater treatment operations, denitrification in anoxic zones is implicated as the dominant source of N<sub>2</sub>O from BNR activated sludge reactors (U.S. EPA, 2009). However, nitrification could also play a role in N<sub>2</sub>O generation and emission from WWTPs, especially under cycling between anoxic and aerobic conditions (Kampschreur et al., 2008b), as is common in BNR reactors. Therefore, N<sub>2</sub>O fluxes from aerobic zones of WWTPs also need to be included in N<sub>2</sub>O emissions inventories.

At this point, while there is considerable debate and interest on the ‘potential’ of constituent BNR processes for N<sub>2</sub>O generation and emission, there are few reports that systematically quantify such emissions from full-scale BNR operations (Czepiel et al., 1995; Kampschreur et al.; 2008b, Kimochi et al.; 1998, Sommer et al., 1998; Sümer et al., 1995; Wicht and Beier, 1995). Of these, only one has been conducted in the United States and focuses on a single non-BNR WWTP in New Hampshire (Czepiel et al., 1995). Other full-scale studies have been conducted in Europe and have employed different methods for measuring N<sub>2</sub>O emissions including the use of grab samples (Czepiel et al., 1995; Kampschreur et al.; 2008b, Sommer et al., 1998; Sümer et al., 1995; Wicht and Beier, 1995) or online measurements (Kampschreur et



al., 2008b; Kimochi et al., 1998). Given the broad diversity of BNR and non-BNR configurations that exist in the United States, a more detailed N<sub>2</sub>O emissions database of WWTPs was needed, specifically obtained using a consistent protocol. Despite recognition of the possible role of biological nitrogen removal (BNR) processes in nitrous oxide (N<sub>2</sub>O) emission, a measured database of N<sub>2</sub>O emissions from these processes at the national scale does not currently exist. This project focused on the quantification of N<sub>2</sub>O emissions at twelve wastewater treatment plants (WWTPs) across the United States using a newly developed U.S. EPA reviewed protocol. A subsequent focus was on determining the mechanisms and triggers of these emissions.

The principal motivation of conducting such a detailed monitoring campaign is the limited data currently used to “estimate” the N<sub>2</sub>O emissions of WWTPs. The current method is based on emission factor values of 3.2 g N<sub>2</sub>O/population equivalents/year from non-BNR operations and 7.0 g N<sub>2</sub>O/population equivalent/year for BNR operations (Czepiel et al., 1995; U.S. EPA, 2009). Both emission factors are based on a limited data set and may not be broadly representative.

The release of N<sub>2</sub>O from wastewater treatment processes is well recognized (U.S. EPA, 2009). The greenhouse impact of N<sub>2</sub>O is about three hundred times that of carbon dioxide, the primary greenhouse gas (GHG). Furthermore, as recently shown, atmospheric N<sub>2</sub>O can also contribute directly to the depletion of the atmospheric ozone layer (Ravishankara et al., 2009). From a regulatory and policy perspective, organizations such as the U.S. EPA are now beginning to explicitly include the contribution of BNR processes such as denitrification on the overall N<sub>2</sub>O emission inventory from WWTPs (U.S. EPA, 2009). A common approach to estimating the N<sub>2</sub>O inventory of wastewater treatment processes is by using a ‘single’ emission factor with a value of 3.2 g N<sub>2</sub>O/population equivalent/year and 7.0 g N<sub>2</sub>O/population equivalent/year for non-BNR and BNR processes (U.S. EPA, 2009). In these calculations, one population equivalent is defined as 100 gallons of wastewater discharged per capita per day. Conceptually, given that the inputs to a wastewater treatment plant and correspondingly the activity of the activated sludge bacteria are highly variable (Grady et al., 1999), it can be expected that there would be some degree of diurnal variability in N<sub>2</sub>O emissions. Furthermore, owing to the fact that activated sludge bacteria have varying activities in different zones of the bioreactors (Grady et al., 1999), a certain degree of spatial variability in N<sub>2</sub>O emissions is also expected from anoxic, anaerobic and even aerobic zones.

However, such spatial and diurnal variability in N<sub>2</sub>O emissions is not considered in the simple emission factor approach adopted by the U.S. EPA and IPCC for estimating the N<sub>2</sub>O

inventory of BNR and non BNR processes. Furthermore, by approximating the N<sub>2</sub>O emissions from wastewater treatment processes using single emission factors across the board, the ability of certain operating conditions to selectively promote or minimize N<sub>2</sub>O emissions is not understood. Furthermore, not all emission factors are created equal.

Based on these gaps in knowledge, the overall goal of the first part of this study (insert chapter number) was to quantify the emission of N<sub>2</sub>O from WWTPs across the nation operated under different process conditions and configurations. The specific objectives of this first part of the study were to:

- ◆ Develop a database of N<sub>2</sub>O emissions fluxes from different activated sludge process configurations using a standard protocol.
- ◆ Identify key factors that are correlated with N<sub>2</sub>O emission from activated sludge.
- ◆ Determine the spatial and temporal variability in N<sub>2</sub>O emissions from WWTPs (both BNR and non BNR) across the nation and examine the validity of the single emission factor approach in estimating the inventory of N<sub>2</sub>O from WWTPs.

The remaining parts of this study deal with laboratory studies in pure and mixed cultures, modeling, and full scale demonstration of mitigation efforts via process engineering.

## 1.2 Mechanisms of Autotrophic N<sub>2</sub>O and NO Emissions

There is now ample evidence of direct N<sub>2</sub>O and NO generation by autotrophic ammonia oxidizing bacteria (AOB) under oxygen limitation or complete anoxia (Bock, 1995; Hooper et al., 1997; Schmidt and Bock, 1997; Schmidt and Bock, 1998). Under oxygen limiting and anoxic conditions, AOB including *Nitrosomonas europaea* and *N. eutropha* can utilize alternate electron acceptors such as nitrite (NO<sub>2</sub><sup>-</sup>) or dimeric nitrogen dioxide (N<sub>2</sub>O<sub>4</sub>), and ammonium (NH<sub>4</sub><sup>+</sup>) or hydrogen gas (H<sub>2</sub>) as electron donors to produce substantial amounts of N<sub>2</sub>O and NO.

*N. europaea* indeed contains *nirK* and *norQB* gene homologs that encode a periplasmic copper-containing nitrite reductase (NirK) and nitric oxide reductase (Nor), respectively (Chain et al., 2003). Functional NirK and NorR enzymes have been detected during aerobic NH<sub>4</sub><sup>+</sup> oxidation in *N. europaea* (Beaumont et al., 2002; Beaumont et al., 2004a). NirK activity is essential to confer tolerance to nitrite in *N. europaea* and can result in NO production (Beaumont et al., 2002).

There is some controversy about the exclusive production of N<sub>2</sub>O and NO via nitrifier denitrification, as alternate paths for their production, including hydroxylamine (NH<sub>2</sub>OH) chemodenitrification and auto-oxidation, may exist (Arp and Stein, 2003; Beaumont et al., 2002; Schmidt et al., 2004). Although it was thought that low oxygen tension is the primary factor

contributing to NO and N<sub>2</sub>O production (Colliver and Stephenson, 2000, Poth, 1985, Poth and Focht, 1985), production of N<sub>2</sub>O has been described in *N. europaea* cultures under aerobic conditions (Beaumont et al., 2004a; Beaumont et al., 2004b; Shaw et al., 2006; Anderson and Levine, 1986).

Previous work on N<sub>2</sub>O and NO generation by AOB in pure and mixed culture has shown that especially dynamic conditions (changes in oxygen or ammonium concentrations) lead to production of these gaseous compounds (Kampschreur et al., 2008a; Kampschreur et al., 2008b; Kester et al., 1997). However, the experimental designs of these studies do not allow discrimination of whether the generation of these gases is related to the *imposition* of anoxia or to *recovery* back to aerobic conditions and metabolic reactions after the anoxic shock (Kester et al., 1997). Furthermore, it is not a simple matter to predict the specific contribution of autotrophic and heterotrophic pathways to the overall N<sub>2</sub>O and NO generation emission, which have been reported in some past mixed culture studies (Kampschreur et al., 2008a; Kampschreur et al., 2008b). Finally, from a fundamental perspective, the molecular underpinnings of N<sub>2</sub>O and NO emissions from AOB in terms of functional gene expression are also largely unknown.

Based on experimental data from previous studies using AOB (Bock, 1995; Hooper et al., 1997; Ritchie and Nicholas, 1972; Schmidt and Bock, 1997) and known gene regulation in heterotrophic denitrifying bacteria (Zumft, 1997), it was hypothesized that transition from aerobic to anoxic conditions would stimulate the combined expression of nitrite and nitric oxide reductase genes in *N. europaea* and concurrently give rise to gaseous NO and N<sub>2</sub>O. By corollary it was also hypothesized that upon *recovery* back to aerobic conditions, the gene expression and gaseous emission patterns would be suppressed, thereby leading to a reduction in NO and N<sub>2</sub>O concentrations. The principal goal of this pure-culture component of the overall study was therefore to systematically determine the impact of transient anoxic conditions under different influent NH<sub>4</sub><sup>+</sup> concentrations on chemostat cultures of *N. europaea*.

### **1.3 Impact of Different External Carbon Sources on N<sub>2</sub>O Emissions from Denitrification**

Chemo-organo-heterotrophic denitrification is the dissimilatory reduction of ionic nitrogen oxides such as nitrate and nitrite, to nitric oxide (NO), nitrous oxide (N<sub>2</sub>O) and ultimately to dinitrogen gas (N<sub>2</sub>) using organic electron donors (Knowles, 1982). Sequential actions of several enzymes including nitrate reductase (NaR), nitrite reductase (NiR), nitric oxide reductase (NOR) and nitrous oxide reductase (N<sub>2</sub>OR) are involved. As one of the two main reactions in engineered BNR systems, denitrification is implicated as a potential source of global

N<sub>2</sub>O emissions (U.S. EPA, 2009). Although autotrophic nitrification can itself contribute to N<sub>2</sub>O emissions from wastewater treatment plants, as will be discussed in Chapter 4.0 of this report and as shown in (Ahn et al., 2009; Kampschreur et al., 2008a), the sole focus of this work was to elucidate potential triggers of N<sub>2</sub>O emissions from two distinctly operated heterotrophic denitrifying reactors.

Several factors have been linked to N<sub>2</sub>O and NO generation and emission from denitrifying bioreactors including low pH (Focht, 1974), short solids retention time (Hanaki et al., 1992), organic carbon limitation (Hanaki et al., 1992), dissolved oxygen inhibition (Tallec et al., 2008; Park et al., 2000) and nitrite inhibition (von Schultess et al., 1995). However, the impact of the specific carbon source on resulting N<sub>2</sub>O and NO generation and emission has received limited attention. From an engineering perspective, with increasing methanol costs, wastewater utilities may adopt alternate external carbon sources, e.g., ethanol, to sustain and enhance denitrification. Even though higher specific denitrification rates might be fostered by these alternatives to methanol, it is imperative to determine associated N<sub>2</sub>O or NO emissions to ensure minimization of both aqueous and gaseous nitrogenous pollution. Such an evaluation is especially important since it has been recently shown that different organic carbon sources foster distinct microorganisms, even in mixed cultures (Ginige et al., 2004; Osaka et al., 2008; Baytshtok et al., 2009). Thus, it could be hypothesized that the resulting differences in microbial community structure and their tolerance or susceptibility to transient stressors could give rise to different emissions on different carbon sources.

Therefore, the overall goal of this part of the study was to systematically evaluate N<sub>2</sub>O and NO emissions from denitrification using two organic carbon sources, methanol and ethanol in response to three stressors, transient organic carbon limitation, exposure to high nitrite concentration spikes and a range of inhibitory oxygen concentrations.

#### **1.4 Organization of Report**

This is an interim report from this project. There is considerable interest in greenhouse gas (GHG) emissions globally. As a result of this interest and the need for research results, WERF will release this interim report with the project findings. The final report, meeting all project objectives, is expected by 2012.

The interim report is presented in the following sections.

Executive Summary

Chapter 1.0 Literature and Introduction

Chapter 2.0 Methods and Procedures-Protocol for Determination of N<sub>2</sub>O Emissions Fluxes and Other Analytical Methods

Chapter 3.0 Summary of Process Schematics Sampled

Chapter 4.0 Results: Nitrous Oxide Emission Fluxes from Full-Scale Activated Sludge in the United States

Chapter 5.0 Results: Molecular Mechanisms of Autotrophic N<sub>2</sub>O and NO Generation and Emission

Chapter 6.0 Results: Factors Promoting Emissions of Nitrous Oxide and Nitric Oxide from Denitrifying Sequencing Batch Reactors Operated with Methanol and Ethanol as Electron Donors

Chapter 7.0 Interim Conclusions Recommendations and Ongoing Studies

Appendix A Field Protocol with Quality Assurance Plan

Appendix B Data (available on CD Rom by request)

Appendix C Process Schematics of WWTPs Sampled

References

## CHAPTER 2.0

# METHODS AND PROCEDURES - PROTOCOL FOR DETERMINATION OF N<sub>2</sub>O EMISSIONS FLUXES AND OTHER ANALYTICAL PROCEDURES

## 2.1 Introduction

One of the most significant outputs from this project has been the development of a protocol that enables collection of N<sub>2</sub>O emission fluxes from open-surface activated sludge bioreactors using consistent methodology. The protocol was submitted to the United States Environmental Protection Agency for review during fall 2008 and the comments provided have been duly incorporated herein. The protocol is intended to provide utilities and field sampling teams with a detailed description of the data collection methodology and analysis requirements to enable calculation of gaseous nitrogen fluxes from different zones of activated sludge trains in a wastewater treatment facility. The protocol was officially released during the 2<sup>nd</sup> Water Environment Federation Nutrient Removal Conference in Washington DC during June 2009 and is also available online at [www.werf.org](http://www.werf.org). The entire protocol is also provided as an appendix as part of this report.

## 2.2 Sampling Design for Full-Scale Monitoring

The N<sub>2</sub>O emission fluxes of several wastewater treatment plants that are accomplishing nitrification and denitrification were determined. Testing was conducted at each plant during which gas phase monitoring was performed in real-time continuous mode and liquid phase sampling was performed via discrete grab sampling. Plants were subjected to two campaigns conducted once in warm temperature conditions (i.e. summer, early fall), and cold temperature conditions (winter/early spring) in the Northeast and Midwest and twice in plants along the West Coast (Fall and Spring), not subject to significant temperature changes.

## 2.3 Sampling Procedures-Headspace Gas Measurement

The overall procedure for measuring  $N_2O$ ,  $NO$  and  $NO_2$  fluxes from the head-space of activated sludge tanks involves a variant of the EPA/600/8-86/008 and the South Coast Air Quality Management District (SCAQMD) tracer methods. This variant was developed to measure those sources that have a relatively high surface flux rate when compared to diffusion (for instance, spilled oil containment).

Commercially available replicas of the U.S. EPA surface emission isolation flux chamber (SEIFC, Figure 2-1) were used to measure gaseous N fluxes from activated sludge reactors. The SEIFC consists of a floating enclosed space from which exhaust gas is collected in a real-time or discrete fashion. Since the surface area under the SEIFC can be measured, the specific flux of the gaseous compound of interest can be indirectly determined. The SEIFC ‘floats’ on the activated sludge tank surface and several replicate measurements can be taken at different locations in a single tank as well as from different tanks (nitrification, denitrification) along a treatment train.

The SEIFC is also equipped with mixing (physical mixer or via sweep gas circulation) to ensure adequate gas mixing and in some cases, an online temperature probe. The SEIFC is currently one of the few devices accepted by the U.S. EPA for measuring gaseous fluxes (Tata et al., 2003) and as such will be employed for this study. Gas-phase analyses was conducted via infra-red ( $N_2O$ ) and chemiluminescence ( $NO_x$ ).

In general, sampling was conducted at multiple locations of the activated sludge train in each wastewater treatment facility. These locations included aerobic, anoxic and anaerobic zones, depending upon the configuration of the given facility. During the course of the gas phase sampling, liquid phase samples were collected adjacent to the hood location. The samples were filtered immediately upon collection in the field and analyzed by host plant personnel for ammonia, nitrite and nitrate concentration, utilizing readily available field methods (i.e. Hach kits) and standard laboratory analytical methods.

The specific locations selected were the geometric center of each demarcated anoxic or aerobic zone in the WWTP, or alternately locations where nitrification could be inferred based on initial screening of  $NH_4^+$ -N and DO concentrations (as in the plug-flow processes). For discrete measurement at each of these locations, 30 replicate measurements of gaseous  $N_2O$  and 1 measurement of aqueous  $N_2O$  were obtained over a period of 30 min. During continuous measurement at each of these specific locations over a 24 hour period, gaseous  $N_2O$

concentrations were still measured at 1/min, while aqueous N<sub>2</sub>O concentrations were measured four-five times per day. Independent replication at each location (on different days) was not conducted owing to practical limitations associated with such an extensive campaign.

## 2.4 Sampling Procedures-Aqueous N<sub>2</sub>O Concentrations

Aqueous phase N<sub>2</sub>O concentrations were measured using a miniaturized Clark-type sensor with an internal reference and a guard cathode (Unisense, Aarhus, Denmark). The sensor is equipped with an oxygen front guard, which prevents oxygen from interfering with the nitrous oxide measurements. The sensor is connected to a high-sensitivity picoammeter and the cathode is polarized against the internal reference. Driven by the external partial pressure, nitrous oxide from the environment will penetrate through the sensor tip membranes and be reduced at the metal cathode surface. The picoammeter converts the resulting reduction current to a signal. The internal guard cathode is also polarized and scavenges oxygen in the electrolyte, thus minimizing zero-current and pre-polarization time.

## 2.5 Sampling Procedures: Measurement of Advective Gas Flow Rate from Bioreactor Headspace

Advective flow of gas through the flux-chamber ( $Q_{\text{emission}}$ ) *in aerated zones* was measured using a modification of ASTM method D1946. Briefly, a tracer gas consisting of 10,000 ppmv ( $C_{\text{helium-tracer}}$ ) He was introduced into the flux-chamber at a known flow rate,  $Q_{\text{tracer}}$  (equation 1). He concentrations in the off-gas from the flux-chamber ( $C_{\text{helium-FC}}$ ) were measured using a field gas-chromatograph equipped with a thermal conductivity detector (GC-TCD).  $Q_{\text{emission}}$  was computed using equation 1.

$$Q_{\text{tracer}} * C_{\text{helium-tracer}} = (Q_{\text{tracer}} + Q_{\text{emission}}) * C_{\text{helium-FC}}$$

$$Q_{\text{emission}} = \frac{Q_{\text{tracer}} * (C_{\text{helium-tracer}} - C_{\text{helium-FC}})}{C_{\text{helium-FC}}} \quad (\text{Equation 1})$$

## 2.6 Determination of Advective Gas Flowrates through the Flux-Chamber from Non-Aerated Zones

The only modification to the protocol to measure the emission flow rate from *non-aerated zones* was the introduction of sweep gas (air) or carrier gas through the flux-chamber at a known flow rate ( $Q_{\text{sweep}}$ ), in addition to the He tracer gas. The corresponding  $Q_{\text{emission}}$  was computed using Equation 2. Addition of sweep gas is needed to promote mixing of the SEIFC contents, owing to the low advective gas flow from the anoxic-zone headspace. Sweep-air N<sub>2</sub>O



concentrations were always measured and typically below the detection limits of the N<sub>2</sub>O analyzer.

$$Q_{\text{tracer}} * C_{\text{helium-tracer}} = (Q_{\text{tracer}} + Q_{\text{sweep}} + Q_{\text{emission}}) * C_{\text{helium-FC}}$$

$$Q_{\text{emission}} = \frac{Q_{\text{tracer}} * (C_{\text{helium-tracer}} - C_{\text{helium-FC}})}{C_{\text{helium-FC}}} - Q_{\text{sweep}} \quad (\text{Equation 2})$$

During continuous N<sub>2</sub>O measurements, Q<sub>emission</sub> was determined several times a day to match liquid-phase N<sub>2</sub>O measurements.

## 2.7 Sampling Procedures-Wastewater and Process Characterization

**Preliminary Data Gathering and Steady State Process Analysis.** The integral dependence of N<sub>2</sub>O and NO emissions on the process operating conditions made the development of a preliminary reconnaissance analysis crucial. The following background information was collected from candidate evaluation sites:

- ◆ **Overall Plant Description.** First, general information related to treatment plant configuration, liquid and solids process flow diagrams, design criteria, major mechanical process equipment, etc from the plant's design reports and/or O&M manuals were obtained. In addition, the following secondary process operating data was gathered via meetings with plant operations teams and process engineers:
- ◆ **Secondary Process Configuration.** including zone configuration, zone volumes, operating set points, basins in service, aeration flow and distribution, recycle streams and flow rates (if applicable)
- ◆ **Plant Operating Data.** Summary of a minimum of three months plant data applicable to the treatment process to allow for characterization of the process influent, target and actual operating setpoints for key operational parameters (DO, SRT), effluent concentrations.

## 2.8 Intensive On-Site Sampling and Analysis

Intensive diurnal sampling was conducted during each N<sub>2</sub>O sampling campaign at the different plants to develop correlations between process state variables and gas-phase N<sub>2</sub>O and NO<sub>x</sub> concentrations (presented in Chapter 3.0). Typical state variables measured, measurement

locations and frequency are summarized in the detailed protocol (Appendix A).

## **2.9 Sample Collection Responsibilities**

The measurement of nitrogen GHG emissions and collection of samples using the flux chamber were done by Columbia University researchers and field technicians under the direct supervision of Dr. Kartik Chandran. As the measurement of these parameters were conducted by real-time analyzers or *in-situ* liquid probes, there was no need for sample collection, handling and preservation. The real-time data from the analyzers or probes was automatically downloaded on to a field computer or recorded in laboratory notebooks under the control of the Columbia University researchers. All electronic data were backed up immediately upon return to New York to a duplicate location in the Environmental Biotechnology Laboratories at Columbia University. Additionally, where feasible electronic data was stored on a temporary disk drive (in addition to the PC hard drive) during the field testing events.

## **2.10 Principles of Real-Time N<sub>2</sub>O, NO and NO<sub>2</sub> Measurements**

### **2.10.1 Principles of N<sub>2</sub>O Measurement**

Continuous N<sub>2</sub>O measurements were performed via infra-red (IR) gas-filter correlation, which is based on the absorption of IR radiation by N<sub>2</sub>O molecules at wavelengths near 4.5 μm. As part of the measurement process, a broad wavelength IR beam is generated inside the instrument and passed through a rotating gas filter wheel, which causes the beam to alternately pass through a gas cell filled with dinitrogen, (measure cell) and a cell filled with N<sub>2</sub>O/N<sub>2</sub> mixture (reference cell) at a frequency of 30 cycles/sec. N<sub>2</sub>O concentrations are inferred based on the amount of IR absorption at wavelengths close of 4.5 μm. Ultimately, the ‘stripped’ beam strikes the detector which is a thermoelectrically cooled solid-state photo-conductor. This detector, along with its pre-amplifier converts the light signal into a modulated voltage signal.

### **2.10.2 Principles of NO and NO<sub>2</sub> Measurement**

The chemiluminescence approach is based on the gas-phase reaction of NO with excess ozone (O<sub>3</sub>), which produces a characteristic near-infrared luminescence (broad-band radiation from 500 to 3,000 nm, with a maximum intensity at approximately 1,100 nm) with an intensity that is proportional to the concentration of NO.

## **Reaction chemistry involved in measurement of NO concentrations**

$\text{NO} + \text{O}_3 \rightarrow \text{NO}_2 + \text{NO}_2^* + \text{O}_2$       Formation of stable and excited  $\text{NO}_2$  by reaction of NO with  $\text{O}_3$

$\text{NO}_2^* \rightarrow \text{NO}_2 + h\nu$       Conversion of excited  $\text{NO}_2$  to stable  $\text{NO}_2$  with release of luminescent radiation

## **Reaction chemistry involved in measurement of $\text{NO}_2$ concentrations**

$\text{NO}_2 + \text{reducing agent} \rightarrow \text{NO} + \text{oxidized products}$       Reduction of  $\text{NO}_2$  to NO

NO measurement by chemiluminescence (Reactions 1 and 2)

To determine the concentration of NO by chemiluminescence, the sample gas flow from the nitrifying reactors is mixed with  $\text{O}_3$  in a reaction chamber operated under negative pressure (vacuum). The chemiluminescence that results from these reactions is monitored by an optically filtered high sensitivity photomultiplier, that responds to  $\text{NO}_2$  chemiluminescence emission at wavelengths longer than 600 nm. The electronic signal produced in the photomultiplier is proportional to the NO concentration in the sample gas. Measurement of  $\text{NO}_2$  is achieved by means of a heated converter that reduces  $\text{NO}_2$  to NO.

## **2.11 Data “Analysis and Processing**

### **2.11.1 Determination of Fluxes**

The net flux of gaseous N species ( $\text{mg}/\text{min}\cdot\text{m}^2$ ) was calculated based on the gas flow rate out of the flux chamber ( $Q_{\text{emission}}$ , L/min), gas concentration (parts per million) and the cross-sectional area of the SEIFC ( $\text{m}^2$ ) (Equation 3).

$$\text{Flux} = \frac{Q_{\text{emission}} * C}{A} \quad (\text{Equation 3})$$

### **2.11.2 Determination of Lumped Emission Fractions**

The surface flux calculated from Equation 3 was translated into the flux of a given zone by multiplying with the specific zone area. The  $\text{N}_2\text{O}$  emission fractions (mass/mass) for each WWTP at any given time point were computed by normalizing the measured flux from each zone in the facility to the daily influent total Kjeldahl nitrogen (TKN) loading according to

equation 4. Emission fractions were averaged over the course of the diurnal sampling period and reported as the average (avg.)  $\pm$  standard deviation (sd) for each individual process sampled.

During each campaign, wastewater nitrogen species concentrations including influent, bioreactor and effluent total Kjeldahl nitrogen (TKN), ammonium ( $\text{NH}_4^+$ -N), nitrite ( $\text{NO}_2^-$ -N) and nitrate ( $\text{NO}_3^-$ -N) were measured simultaneously about six-times per day according to Standard Methods (Eaton et al., 2005) to supplement the gas-phase measurements. The discrete measurements were averaged to generate the emission fractions described in Equation 4. Additionally, seven out of the twelve processes were sampled at minimum and maximum annual wastewater temperatures to examine seasonal temperature impacts on  $\text{N}_2\text{O}$  generation and emission.

$$\text{Emission fraction} = \frac{\sum_{i=1}^n \text{Flux}_i * \text{Area}_i \text{ (kg } \text{N}_2\text{O} - \text{N)}}{\text{Daily influent TKN load (kg - N)}} \quad (\text{Equation 4})$$

Where:

$\text{Flux}_i$  =  $\text{N}_2\text{O}$  emission flux calculated from the  $i^{\text{th}}$  zone ( $\text{kg } \text{N}_2\text{O-N/m}^2\text{-d}$ )

$\text{Area}_i$  = Surface area of the  $i^{\text{th}}$  zone ( $\text{m}^2$ )

$n$  = number of zones in a given facility from which  $\text{N}_2\text{O}$  fluxes are captured

Daily influent TKN load: Average influent load (influent flow rate \* influent TKN concentrations) over the course of 24 hours.

On average, wastewater characterization was performed at each gas sampling location as well as in the tank influent and effluent about six times per day. At facilities where analysis was not as frequent, daily composite measurements were employed, for instance in the influent and effluent samples. Alternately, in some facilities, online measurement devices (for measuring pH, dissolved oxygen, redox potential and select N-species, including  $\text{NH}_4^+$ -N and  $\text{NO}_3^-$ -N) were employed at different locations of the activated sludge tank, which also facilitated the wastewater characterization efforts.

### 2.11.3 Calculation of $\text{N}_2\text{O}$ Emission Factors

$\text{N}_2\text{O}$  emission factors were computed by normalizing the total reactor  $\text{N}_2\text{O}$  mass flux to the unit population equivalent flow rate (100 gal/PE/day) and were expressed in units consistent

with the U.S. EPA inventory report (g N<sub>2</sub>O/PE/year) (U.S. EPA, 2009). For aerobic zones, the helium-based advective gas-flow data were correlated to plant-recorded airflow rates for any given zone via linear regression and used to calculate diurnal N<sub>2</sub>O emission factors. For anoxic (non-aerated) zones lacking associated plant airflow data, the average of the experimentally obtained helium-based gas flow rates was used to calculate diurnal N<sub>2</sub>O emission factors.

#### **2.11.4 Correlation between WWTP Operating Conditions and N<sub>2</sub>O Emissions**

Possible links between WWTP operating conditions and N<sub>2</sub>O emission fluxes were examined via multivariate linear regression modeling of emissions and several wastewater state variables using SAS (Cary, NC). For aerobic zones, N<sub>2</sub>O fluxes were correlated with liquid temperature and sampling location-specific pH, temperature, dissolved oxygen (DO), NH<sub>4</sub><sup>+</sup>-N and NO<sub>2</sub><sup>-</sup>-N concentrations and multiplicative combinations thereof. For anoxic zones, N<sub>2</sub>O fluxes were correlated with sampling location-specific soluble chemical oxygen demand (sCOD), pH, temperature, DO, NO<sub>2</sub><sup>-</sup>-N and NO<sub>3</sub><sup>-</sup>-N concentrations and interactive combinations thereof. Assumptions of state variable normality and equal variance were evaluated using error residual and covariance plots (not shown). The variables not normally distributed were log-transformed, verified for normality and equal-variance and subsequently used for regression modeling. Time points where all state variables had not been measured simultaneously were not included in regression analysis.

### **2.12 Standardization of Protocol and Comparison with Established Emissions Flux Measurement Methods**

The validity of the measurements using the protocol developed for this study was determined via a parallel sampling effort among three teams on September 9 and 10, 2008 at one of the test wastewater treatment facilities. The plant staff used an U.S. EPA flux chamber technology and sampled nitrogen oxide compounds using a field photo-acoustic analyzer. The Columbia University-WERF team used a flux chamber manufactured by St. Croix Sensory and measured N<sub>2</sub>O off-gas concentrations via gas-filter correlation, described above. A third team led by Dr. Charles Schmidt used an U.S. EPA flux chamber and sampled the off-gas into opaque Tedlar® bags for FTIR analysis (NIOSH 6660) by a commercial laboratory (Peak Analytical, Boulder, CO).

Based on these parallel measurements, the three methods resulted in similar results (Figure 2-2), with good correspondence in both the nitrous oxide concentrations and off-gas flow-rate (only done by the Columbia-WERF team and Dr. Schmidt's team, Figure 2-3). Briefly,

the following observations were made based on the results obtained and incorporated into subsequent full-scale measurement campaigns.

The use of an inert gas tracer was demonstrated to be an appropriate method to determine the advective off-gas flow rate. This was an improvement over the initial method developed by the Columbia-WERF team based on successive dilution of the N<sub>2</sub>O concentrations. The initial method was discontinued following the validation study and replaced with He-tracer based method to determine advective flow rate.

Significant spatial and temporal variability in the measured concentrations of headspace N<sub>2</sub>O was observed by the Columbia-WERF and Schmidt teams (Figure 2-4). Therefore, for subsequent full-scale measurements, discrete measurements (once a day) of N<sub>2</sub>O at different locations in any given WWTP was discontinued. Rather, a substantially more involved sampling strategy that entailed 24-hour “real-time online monitoring” of emissions at each location was initiated. The degree of spatial and diurnal variability in the measurements is further highlighted for four selected WWTPs in Chapter 5.0 in this report. Consequently, in modular systems such as four-pass step-feed BNR reactors, the measurement campaigns lasted for about a week, with pass-by-pass sampling (each lasting 24 hours). Additionally, in select WWTPs where resources permitted, (such as the four-pass step-feed BNR reactor 2 presented in Chapter 3.0), emissions were monitored over a period of five days to explore day-to-day variability.

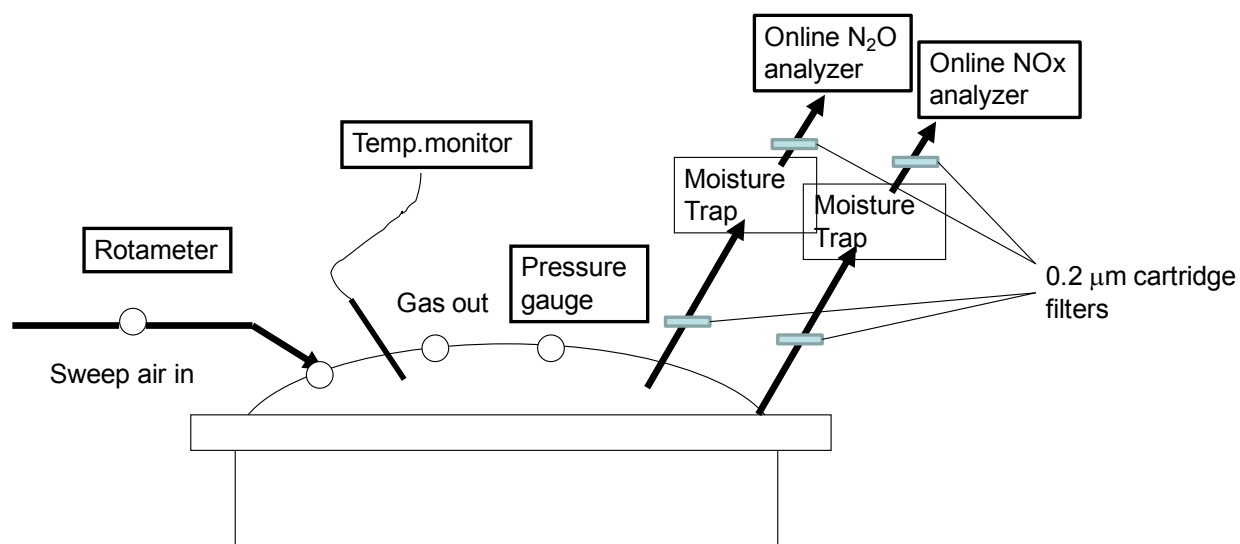
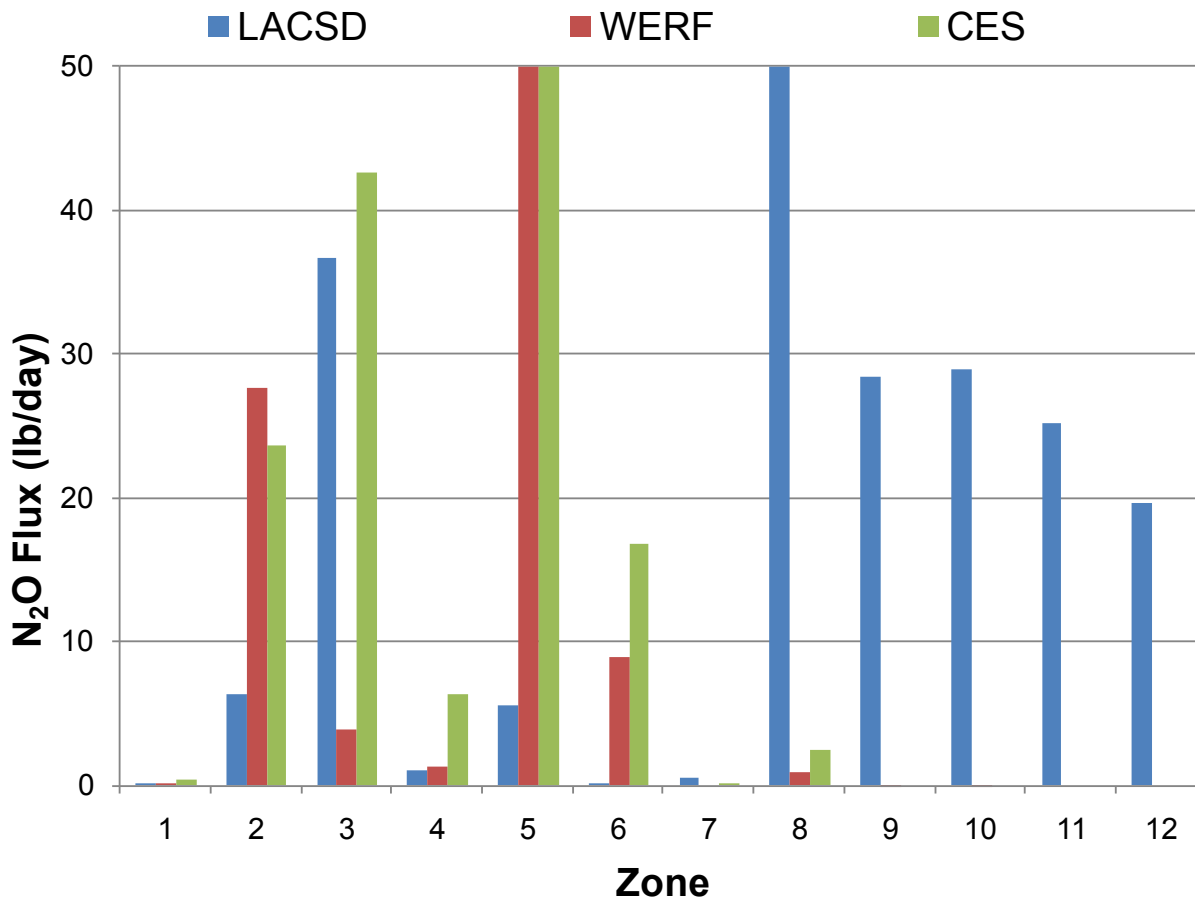

Figure 2-1. Schematic of Flux-Chamber Employed for N<sub>2</sub>O Measurement.



**Figure 2-2. Comparison between N<sub>2</sub>O fluxes Obtained via Three Independent Methods.**

Note: Only the CES and WERF fluxes can be directly compared since they were conducted concurrently.



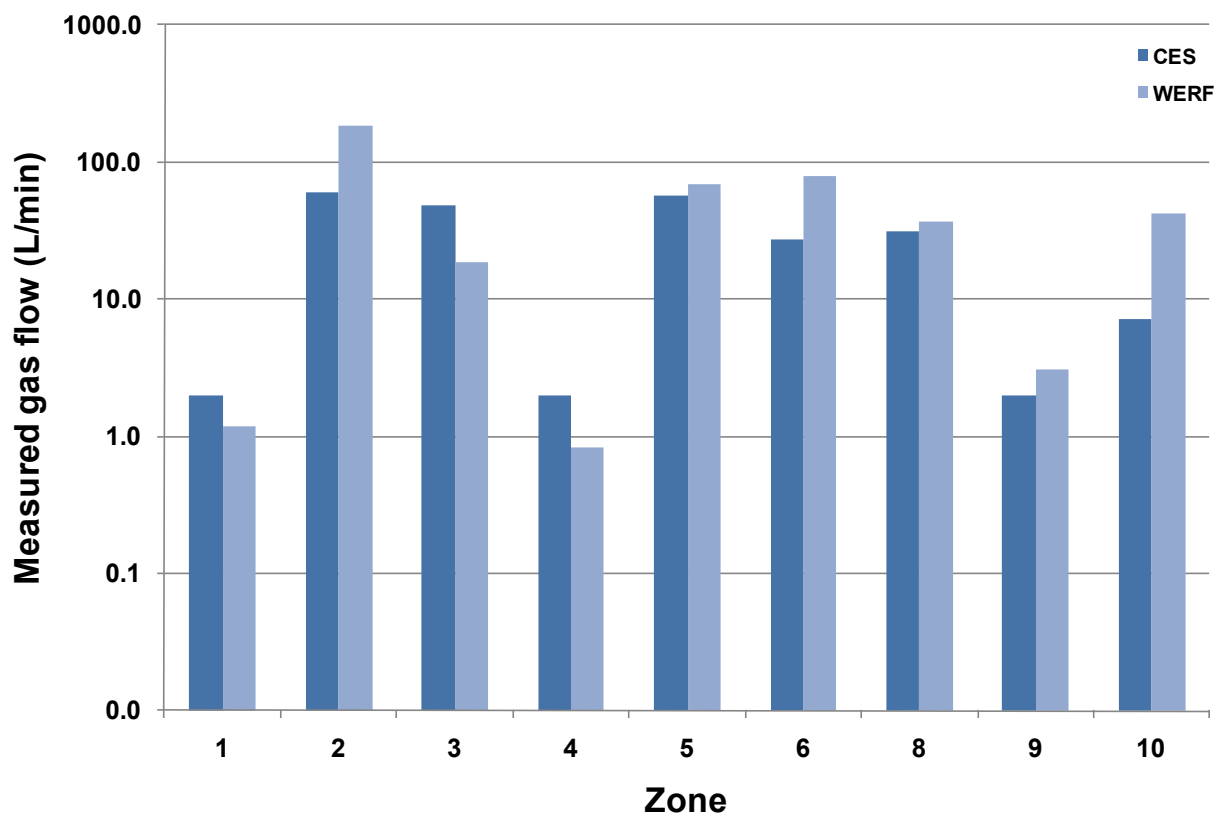

Figure 2-3. Comparison between Gas Flow Rates Obtained via the Tracer Gas (CES) and Successive Dilution (WERF-Columbia) Methods.

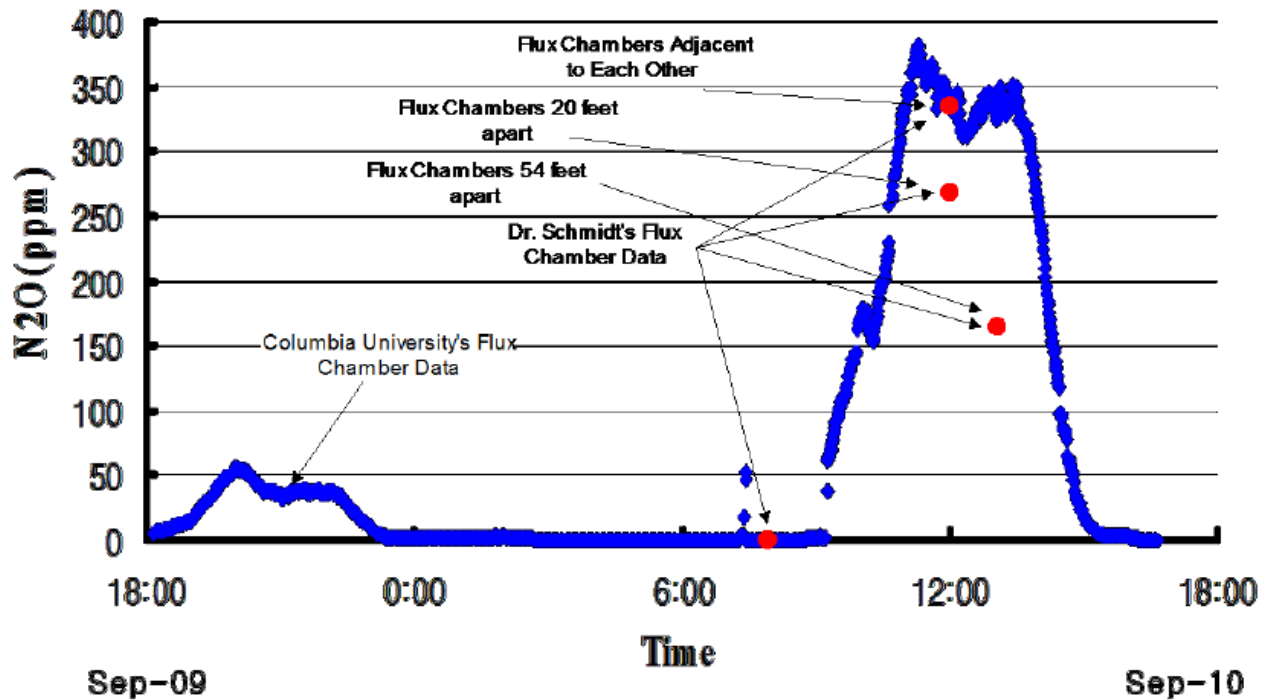

Figure 2-4. Illustration of Spatial and Temporal Variability in N<sub>2</sub>O Concentrations in the Headspace of an Aerobic Zone that Necessitates Real-Time Online Monitoring.

Columbia University's flux chamber data given by near continuous blue diamonds.

Dr. Schmidt's flux chamber data given by 4 red dots.

## 2.13 Sampling and Analytical Methods and Procedures for Pure Culture Lab-Scale Nitrification Studies

### 2.13.1 Cell Cultivation

*N. europaea* (ATCC 19718) cultures were cultivated in chemostat mode ( $V = 4\text{L}$ ) in duplicate at a dilution rate of  $0.45\text{ d}^{-1}$ . The growth medium was as described previously (Chandran and Love, 2008) and contained  $20\text{ mM NH}_4^+$  and in addition (per liter):  $0.2\text{ g}$  of  $\text{MgSO}_4 \cdot 7\text{H}_2\text{O}$ ,  $0.02\text{ g}$  of  $\text{CaCl}_2 \cdot 2\text{H}_2\text{O}$ ,  $0.087\text{ g}$  of  $\text{K}_2\text{HPO}_4$ ,  $2.52\text{ g}$  EPPS (3-[4-(2-hydroxyethyl)-1-piperazine] propanesulfonic acid),  $1\text{ mL}$  of  $13\%$  EDTA- $\text{Fe}^{3+}$ ,  $1\text{ mL}$  of trace elements solution ( $10\text{ mg}$  of  $\text{Na}_2\text{MoO}_4 \cdot 2\text{H}_2\text{O}$ ,  $172\text{ mg}$  of  $\text{MnCl}_2 \cdot 4\text{H}_2\text{O}$ ,  $10\text{ mg}$  of  $\text{ZnSO}_4 \cdot 7\text{H}_2\text{O}$ ,  $0.4\text{ mg}$  of  $\text{CoCl}_2 \cdot 6\text{H}_2\text{O}$ , and  $100\text{ mL}$  of distilled water),  $0.5\text{ mL}$  of  $0.5\%$  phenol red, and  $0.5\text{ mL}$  of  $2\text{ mM}$   $\text{CuSO}_4 \cdot 5\text{H}_2\text{O}$ . Reactor pH was automatically controlled at  $7.5 \pm 0.1$  using a sterile solution of  $40\text{ g/L}$  sodium bicarbonate. The reactor was maintained at  $21^\circ\text{C}$  in dark and aerated using filtered air at a constant flow rate of  $1.16\text{ L/min}$ . Transient anoxic conditions were imposed by substituting filter sterilized  $\text{N}_2$  gas for air at the same gas-flow rate. During the transient anoxic conditions, chemostat cultures were subjected to three different influent  $\text{NH}_4^+$  concentrations,  $20\text{ mM}$  (equal to the steady-state influent  $\text{NH}_4^+$  concentration),  $10\text{ mM}$  and  $2\text{ mM}$ . Consequently, the impact of different  $\text{NH}_4^+$  concentrations accumulated during anoxia on *recovery* back to aerobic conditions could be studied.

$\text{NH}_4^+$  (gas-sensing electrode, Corning, Corning, NY),  $\text{NH}_2\text{OH}$  (Frear and Burrell, 1955),  $\text{NO}_2^-$  (diazotization, (Eaton et al., 2005), cell concentration (direct counting using a cell counting chamber, Hawksley Scientific, England), gaseous  $\text{N}_2\text{O}$  (gas-filter correlation, Teledyne API 320E, San Diego, CA),  $\text{NO}$  (chemiluminescence, CLD-64, Ecophysics, Ann Arbor, MI), intracellular  $\text{NO}$  presence ( $2',7'$ -difluorofluorescein diacetate staining, Molecular Probes, Eugene, OR), dissolved oxygen (Clark-type polarographic electrode, Yellow Springs Inc., Yellow Springs, OH) and specific oxygen uptake rate (sOUR, (Chandran and Love, 2008)) based activity were measured periodically. Direct measurements of liquid-phase  $\text{N}_2\text{O}$  concentrations with a micro-electrode (Unisense, Aarhus, Denmark) were attempted but precluded by interference with dissolved oxygen and possibly  $\text{NO}$  (data not shown). Hence, liquid-phase  $\text{N}_2\text{O}$  concentrations were calculated via Equation 5.

$$\text{N}_2\text{O}(\text{l}) = \left[ \frac{dC_{\text{g},\text{N}_2\text{O}}}{dt} + \frac{Q_{\text{g}} * C_{\text{g},\text{N}_2\text{O}}}{V_{\text{g}}} \right] * \frac{V_{\text{g}} * K_{\text{H},\text{N}_2\text{O}}}{k_{\text{l},\text{a}} * V_{\text{L}}} \quad (\text{Equation 5})$$

Where:

$N_2O(l)$ : numerically computed liquid phase  $N_2O$  concentration (mg-N/L)

$C_{g,N_2O}$ : gas phase concentration of  $N_2O$  (atm)

$dC_{g,N_2O}/dt$ : three point continuously running time derivative of experimentally measured gas phase  $N_2O$  concentration, (atm/h)

$Q_g$ : gas flow rate of air or  $N_2$ , 69.6 L/h

$V_L$ : liquid volume in reactor, 4L

$V_g$ : headspace gas volume in reactor, 2 L

$K_{H,N_2O}$  : 42 mg-N/(L-atm) (Dean, 1985)

$k_{l,a}$ : average experimentally determined  $N_2O$  gas-liquid mass transfer coefficient,  $8.2 \text{ h}^{-1}$ , (sd =  $0.8 \text{ h}^{-1}$ , n=4)

### 2.13.2 Cell Collection and RNA Extraction

At each sample point, 40 mL cell suspensions were collected and immediately centrifuged at  $4^\circ\text{C}$  and  $5000 \times g$  for 10 min. Resulting cell-pellets were resuspended and lysed in 1 mL TRIzol<sup>®</sup> solution (Invitrogen, Carlsbad, CA). RNA was isolated from lysed cell pellets following the TRIzol<sup>®</sup> RNA isolation protocol (Invitrogen) and stored at  $-80^\circ\text{C}$  until further processing.

### 2.13.3 Functional Gene Expression

Expression of four functional genes coding for  $\text{NH}_4^+$  oxidation (*amo* subunit A, *amoA*),  $\text{NH}_2\text{OH}$  oxidation (*hao*),  $\text{NO}_2^-$  reduction (*nirK*) and the catalytic subunit of the NO reductase cluster (*norB*) was quantified by real-time reverse-transcriptase polymerase chain reaction (q-RT-PCR) using previously documented and newly designed primer sets (see later Table 5-1). These four genes were chosen since they code for the enzymes in the principal oxidative and reductive nitrogen transformations in *N. europaea* (Chain et al., 2003). Additional primers for conventional end-point PCR were also designed for *hao*, *nirK* and *norB* and used for preparing standard curves for q-RT-PCR (Table 5.I). Expression of functional genes was normalized to expression of the 16S rRNA gene quantified using primers EUBF and EUBR (Nadkarni et al., 2002).

DNA removal and reverse transcription from total RNA was performed using the QuantiTect<sup>®</sup> Reverse Transcriptase kit (Qiagen, Valencia, CA). The qPCR and endpoint PCR assays were performed in duplicate on an iCycler iQ<sup>TM</sup>5 (Bio-Rad Laboratories, Hercules, CA). A no-template-control was included for each set of PCR and q-RT-PCR reactions. Standard curves for q-RT-PCR consisted of six decimal dilutions of the respective plasmid DNA, containing a given endpoint PCR product. Plasmid concentrations were quantified (50 Bio 5

UV-Visible Spectrophotometer, Varian, Palo Alto, CA) and translated to copy number assuming 660 Da per base pair of double-stranded DNA (Madigan and Martinko, 2006).

#### 2.13.4 Link between Specific Activity of *N. europaea* Cultures and N<sub>2</sub>O Emissions

The applicability of N<sub>2</sub>O emissions to gauge the specific activity of nitrifying bacteria has recently been proposed (Burgess et al., 2002; Butler et al., 2009). Along these lines, the ratio of the ‘extant’ specific activity ( $q_{ns}$ ) to the maximum specific activity ( $q_{max,ns}$ ) of *N. europaea* was computed based on a multiplicative Monod-model. The model included saturation-type functions to describe NH<sub>4</sub><sup>+</sup> limitation, O<sub>2</sub> limitation and NO<sub>2</sub><sup>-</sup> inhibition (as free nitrous acid, HNO<sub>2</sub>, Equation 2). Trends in the ratio of  $q_{ns}/q_{max,ns}$  were tracked over time and correlated to N<sub>2</sub>O emission profiles.

$$\frac{q_{ns}}{q_{max,ns}} = \left( \frac{S_{nh}}{K_{S,nh} + S_{nh}} \right) \left( \frac{S_{O_2}}{K_{S,O_2} + S_{O_2}} \right) \left( \frac{K_{I,NO_2^-}}{K_{I,NO_2^-} + S_{NO_2^-}} \right) \quad (\text{Equation 6})$$

Where:

$S_{nh}$ : NH<sub>4</sub><sup>+</sup> concentration (mg-N/L)

$K_{S,nh}$ : NH<sub>4</sub><sup>+</sup> half-saturation coefficient, 0.5 mg-N/L (Rittmann and McCarty, 2001)

$S_{O_2}$ : dissolved oxygen concentration (mg O<sub>2</sub>/L)

$K_{S,O_2}$ : oxygen half-saturation coefficient, 0.75 mg O<sub>2</sub>/L (Guisasola et al., 2005)

$S_{NO_2^-}$ : NO<sub>2</sub><sup>-</sup> concentration (mg-N/L)

$K_{I,NO_2^-}$ : NO<sub>2</sub><sup>-</sup> inhibition coefficient, 0.52 mg non-ionized HNO<sub>2</sub>-N/L (Vadivelu et al., 2007)

## 2.14 Sampling and Analytical Methods and Procedures for Mixed Culture Lab-Scale Denitrification Studies

### 2.14.1 Bioreactor Operation

Two denitrifying SBRs ( $V = 9.2$  L) were operated with methanol and ethanol respectively, using nitrate as the terminal electron acceptor as previously described (Baytshtok et al., 2008; Baytshtok et al., 2009). The target solids retention time (SRT) for both SBRs was 10 days and the hydraulic retention time (HRT) was 1 day. Each SBR had a six-hour cycle comprised of 1 h anoxic feed and react, 3.5 h anoxic react, 0.5 h aerobic mixing (to strip out dinitrogen gas and improve settling), 0.75 h settle and 0.25 h decant phases. SBR phases were automatically controlled via a digital controller (Chroncontrol Corp, San Diego, CA). The influent COD and  $\text{NO}_3^-$ -N concentrations for both SBRs were 500 mg chemical oxygen demand (COD)/L (methanol or ethanol) and 100 mg  $\text{NO}_3^-$ -N/L. The pH of the SBRs was automatically controlled in the range of  $7.3 \pm 0.2$  using concentrated hydrochloric acid during steady-state operation, but not during gas measurements, during which, the pH ranged from about 7.3 to 8.1.

### 2.14.2 Characterization of Steady-State and Transient State Operations

Aqueous and gaseous nitrogen species were measured during individual SBR cycles, corresponding to steady-state or transient operations with carbon limitation, nitrite and oxygen inhibition. Each transient condition was imposed at least three times independently upon each of the two SBRs to obtain a measure of biological reproducibility. The transients were specifically imposed as follows:

**Carbon limitation.** Methanol or ethanol along with nitrate was provided during the first 0.5h of anoxic feeding phase, followed by 1 h of carbon limitation (but not nitrate limitation) and finally followed by 0.5 h of carbon feeding (without nitrate). In this manner, temporary carbon limitation followed by recovery to non-limiting conditions was imposed. However, the overall carbon and nitrate mass fed during a given SBR cycle during transient limitation and steady-state were identical.

**Nitrite inhibition.** 10 ml of stock sodium nitrite solution (46 g  $\text{NO}_2^-$ -N/L) was spiked into the SBR during the middle of the feeding phase to achieve a peak  $\text{NO}_2^-$ -N concentration of 50 mg-N/L. Methanol or ethanol and nitrate were fed to the SBR as during steady state.

**Dissolved oxygen inhibition.** Oxygen inhibition in the SBR was achieved by continuously pumping air (0.5 L/min for  $\text{DO} = 2.5 \pm 0.5$  mg/L; 1 L/min for  $\text{DO} = 5.1 \pm 1.2$  mg/L) or pure

oxygen (0.5L/min for DO = 9.0 ± 1.1mg/L) during an SBR cycle. Methanol or ethanol and nitrate were fed to the SBR as during steady state.

### 2.14.3 Headspace N<sub>2</sub>O and NO Measurements

Headspace gas collection was performed using a modification of the full-scale protocol for measuring N<sub>2</sub>O and NO fluxes from open surface wastewater treatment plants (described above and in (Chandran, 2009)). Gas collection was performed using a custom-made plastic flux chamber (volume = 3.5 L), which was sealed to the SBR body. Sweep air was introduced into the chamber at a flow rate of 4 L/min, except during transient oxygen inhibition, where the sum of the sweep gas flow rate and air (or oxygen) flow rate equaled 4 L/min. Real-time N<sub>2</sub>O and NO concentrations (ppmv) in the flux-chamber were measured via gas-filter correlation (Teledyne API, San Diego, CA) and chemiluminescence (Ecophysics, Ann Arbor, MI), respectively. Nitrite (diazotization), nitrate (ion-selective electrode, Accumet<sup>®</sup>), pH, ORP and DO (Yellow Springs Instruments, Yellow Springs, OH) were measured at 30 min intervals. Reactor and effluent biomass COD concentrations were measured based on standard methods (Eaton et al., 2005). The fraction of influent nitrate emitted as N<sub>2</sub>O or NO was determined by numerically integrating the real-time profile of N<sub>2</sub>O or NO emission mass flux (Equation 7) and normalizing to mass of nitrate fed during a cycle.

$$M_N = Q \times C \times \frac{MW_N}{V_0} \times t_0 \quad (\text{Equation 7})$$

where,  $M_N$  is the mass of emitted nitrogen during a cycle as either NO or N<sub>2</sub>O (mg-N),  $Q$  is the flow rate of sweep air and gas pumped into the flux chamber (4 L/min),  $C$  is the accumulated concentration of N<sub>2</sub>O or NO during a cycle (ppmv),  $MW_N$  is the molecular weight of nitrogen in N<sub>2</sub>O and NO (14, 28 g/mol),  $V_0$  is the molar volume of an ideal gas, 24.05 L/mol at 1atm and 22°C and  $t_0$  is the duration of one cycle (6h).

### 2.14.4 Extant Biokinetics of Denitrification

Batch experiments were conducted as described previously (Baytshtok et al., 2008 ) to determine denitrification kinetics with methanol and ethanol at steady state and exposure to three DO concentrations: 2, 5 and 9 mg O<sub>2</sub>/L (comparable to DO concentrations transiently imposed upon the SBRs). Briefly, 500 mL biomass samples were withdrawn from the SBRs towards the end of the react cycle, washed, and resuspended in nitrate and COD free medium and sparged with N<sub>2</sub> gas to render them anoxic (DO < 0.2 mg/L). Biokinetic assays were conducted by

spiking the biomass samples with non-limiting concentrations of nitrate and COD (methanol or ethanol) and tracking the resulting nitrate and nitrite profiles over time. In selected assays, air or pure oxygen was introduced into the batch denitrification vessels, to achieve different DO concentrations. Specific denitrification rates (sDNR) were computed via linear regression of the nitrate depletion profiles vs time and normalizing to total biomass COD concentrations.





## CHAPTER 3.0

# SUMMARY OF PROCESS SCHEMATICS SAMPLED

N<sub>2</sub>O emissions were monitored during this study from a wide range of activated sludge processes (both non-BNR and BNR). The modes of operation are summarized in this chapter according to the process configuration. For the sake of confidentiality, the specific locations of these processes are not described. For the sake of geographic representativeness, these processes were broadly distributed around the North-East (4), Mid-Atlantic (2), Mid-West (2), and South-West (4) regions of the United States. The dimensions of the process bioreactors sampled and the sampling locations are further provided in Appendix C of this report. The emissions from these processes are presented in Table 4-1.

Table 3-1. Summary of Process Schematics Sampled.

Plant Configuration	Description
Separate-stage BNR	The low-rate separate-stage nitrification denitrification process at this WWTP was sampled. The process was configured as a sequence of five reactors in series, as shown in Appendix C. The influent to this process consisted of the clarified effluent from an upstream high-rate process, mainly engaged organic carbon removal. The influent was fed in a step-feed fashion to the first two aerobic zones. The last three zones of this process were non-aerated and the second non-aerated zone received methanol to promote denitrification. The effluent channel of this process was aerated prior to secondary clarification.
Four-stage Bardenpho	The four-stage Bardenpho process consisted of pre-denitrification (without external carbon addition) followed by a primary aerated zone, as shown in Appendix C. The effluent of the primary aerated zone was internally recycled to the anoxic zone. Following the primary aerated zone was a de-oxygenation zone to scavenge dissolved oxygen, prior to methanol addition for enhanced denitrification. The final zone in this process was aerated primarily for stripping off the dinitrogen gas produced during denitrification, prior to secondary clarification.
Step-feed BNR 1	The four-pass step-feed BNR process sampled consisted of pre-anoxic zones comprising about 1/3 of the pass volume followed by aerated zones, as shown in Appendix C. The transition zone between each pass was non-aerated to facilitate deoxygenation. The approximate influent flow split was 10%-40%-30%-20% to passes A, B, C and D, respectively. Pass A also received pre-settled anaerobic digestion centrate, which constituted approximately 30% of the influent TKN load to the process. Return activated sludge was also fed to Pass A.
Step-feed non-BNR	The step-feed non-BNR process sampled was configured and operated in four-pass step-aeration mode. The process was completely covered primarily for odor control. The headspace off-gases were consolidated and fed to a biofilter. The approximate influent flow split was 10%/40%/30%/20% to passes A, B, C and D, respectively. Return activated sludge was fed to Pass A.
Separate centrate	The separate centrate treatment process was operated to process pre-settled anaerobic digestion centrate and partially convert the influent $\text{NH}_4^+\text{-N}$ to $\text{NO}_2^-\text{-N}$ . The separate centrate treatment process was operated in plug flow mode, as shown in Appendix C. Effluent from the separate centrate tank was fed to the overall plant return activated sludge line for possible bioaugmentation with primarily ammonia oxidizing bacteria (AOB) and for nitrogen removal via the short-cut nitrite pathway.
Plug-flow 1	The first plug-flow process sampled was designed and operated primarily for organic carbon removal and nitrification and did not have dedicated anoxic zones or external organic carbon addition. The process was configured in four-pass mode, as shown in Appendix C.

<b>Plug-flow 2</b>	The second plug-flow process sampled was also designed and operated for organic carbon removal and nitrification and did not have dedicated anoxic zones or external organic carbon addition. The process was configured in two-pass mode, as shown in Appendix C.
<b>MLE 1</b>	The first modified Lutzack Ettinger (MLE) process sampled was originally designed for operation in enhanced biological phosphorous removal mode, but subsequently operated in MLE mode. As shown in Appendix C, the process consisted of pre-denitrification without external organic carbon addition. Biomass from zone 6, which was aerated, was internally recycled to anoxic zone 2. Return activated sludge was fed to anoxic zone 1.
<b>MLE 2</b>	The second modified Lutzack Ettinger (MLE) process sampled was also originally designed for operation in enhanced biological phosphorous removal mode, but subsequently operated in MLE mode. As shown in Appendix C, the process consisted of pre-denitrification without external organic carbon addition. Biomass from zone 6, which was aerated, was internally recycled to anoxic zone 2. Return activated sludge was fed to anoxic zone 1.
<b>Step-feed BNR 2</b>	The second step-feed process sampled was configured in four-pass mode as shown in Appendix C. Each pass consisted of pre-anoxic zones comprising 1/3 of the pass volume followed by aerobic zones. The approximate influent flow split was 50%-30%-20%-0% to passes A, B, C and D, respectively. The anoxic zones were mixed via low intensity pulse aeration. The return activated sludge was fed to Pass A.
<b>Oxidation ditch</b>	The oxidation ditch process shown in Appendix C was operated to achieve simultaneous nitrification and denitrification by operation at uniformly low aeration intensities and dissolved oxygen concentrations. The influent flow to the process was fed to the inner loop and was mixed and circulated using surface mixers. No external organic carbon was added to enhance denitrification. Return activated sludge was fed to the inner loop of the process.
<b>Step-feed BNR 3</b>	The third four-pass step-feed BNR process sampled consisted of pre-anoxic zones comprising about 1/3 of the pass volume followed by aerated zones, as shown in Appendix C. The approximate influent flow split was 33.3%-33.3%-33.3%-0% to passes A, B, C and D, respectively. Pass A also received pre-settled anaerobic digestion centrate, which constituted approximately 40% of the influent TKN load to the process. Return activated sludge was also fed to Pass A. The reactors of this process were also covered and thus only composite measurements of the overall headspace could be performed.



## CHAPTER 4.0

# RESULTS: NITROUS OXIDE EMISSIONS FLUXES FROM FULL-SCALE ACTIVATED SLUDGE IN THE UNITED STATES

## 4.1 N<sub>2</sub>O Emission Fluxes from Activated Sludge Processes

A wide range of N<sub>2</sub>O emissions was measured across the twelve WWTPs operated at different temperatures, configurations and influent characteristics (Table 4-1). On average, N<sub>2</sub>O emission fractions varied from 0.01-1.8% or 0.01-3.3%, when normalized to influent TKN load or influent TKN load processed, respectively. These emission fractions were on the lower end of the range reported by previous studies, which varied between 0-15% of influent TKN load (Czepiel et al., 1995; Kampschreur et al., 2008b; Kimochi et al., 1998; Sommer et al., 1998; Sümer et al., 1995; Wicht and Beier, 1995).

In general, N<sub>2</sub>O emissions in aerated zones were higher than those in non-aerated zones (Figure 4-1). Therefore the currently held premise that N<sub>2</sub>O emissions from WWTPs mostly occur in the anoxic zones (U.S. EPA, 2009) is not accurate. Higher emissions from aerobic zones can be attributed to three possible phenomena: increased air-stripping of N<sub>2</sub>O, N<sub>2</sub>O production due to oxygen inhibited heterotrophic denitrification or N<sub>2</sub>O production by autotrophic nitrification during changes in aeration. While it was not possible to infer the specific contribution of these phenomena to overall emissions from our data set, attempts were indeed made to identify links between principal operating parameters and measured emissions (described in the modeling section).

Computed flow-normalized emission factors also varied in a wide range (Table 4-1), and were mostly statistically higher (at the  $\alpha=0.05$  confidence level) than currently used values of 3.2 g N<sub>2</sub>O/PE/yr (non-BNR processes (Czepiel et al., 1995)) or 7.0 g N<sub>2</sub>O/PE/yr (BNR processes (U.S. EPA, 2009)). Emission factor values from the separate-stage BNR and oxidation ditch process were statistically lower, (at the  $\alpha=0.05$  confidence level) and the those from the two MLE processes were statistically not dissimilar, (at the  $\alpha=0.05$  confidence level) relative to the

current estimates (Czepiel et al., 1995; U.S. EPA, 2009). The high emission factors for the separate centrate treatment process are primarily because centrate streams have disproportionately low flow rates compared to their TKN concentrations. Therefore, the current convention for normalizing emissions factors to wastewater flow rates may not be universally valid due to significant differences in local or global differences in wastewater composition (Tchobanoglous et al., 2003) and is not recommended. Expression of emissions as a fraction of influent TKN load or influent TKN load processed is possibly more appropriate. A high degree of diurnal variability in emission factors was also observed (shown for four select processes in Figure 4-2) and could be linked diurnal variations in influent N-loading as reported (Ahn et al., 2009). Based on the observed variability either diurnally or across the range of WWTPs sampled, the use of a 'single' universal emission factor to calculate N<sub>2</sub>O emissions from all wastewater treatment processes is also inadequate.

## 4.2 Model Based Discrimination of Process Operating Conditions Contributing to N<sub>2</sub>O Emission

**Aerobic zones:** Based on multivariate regression modeling, the factors correlated positively with N<sub>2</sub>O emissions from aerobic zones, were NH<sub>4</sub><sup>+</sup>-N, NO<sub>2</sub><sup>-</sup>-N and DO concentrations (isolated effect), and NH<sub>4</sub><sup>+</sup>-N and NO<sub>2</sub><sup>-</sup>-N concentrations (interactive effect, Table 4-2). From a fundamental perspective, nitrite is one of the most important factors contributing to N<sub>2</sub>O production from nitrification (Beaumont et al., 2005; Beaumont et al., 2004b; Beaumont et al., 2004a). Thus, correlation of NO<sub>2</sub><sup>-</sup>-N concentrations with aerobic zone N<sub>2</sub>O emissions is consistent with basic biochemical principles. Although it was previously proposed that low DO concentrations were directly responsible for autotrophic nitrification-related N<sub>2</sub>O emissions (Tallec et al., 2006), recent results suggest that N<sub>2</sub>O is generated by *recovery* from low DO conditions rather than *imposition* thereof (Yu et al., 2010). In fact, abrupt increases in DO concentrations in the presence of NH<sub>4</sub><sup>+</sup> can also lead to transient accumulation of NO<sub>2</sub><sup>-</sup>, which can in turn result in autotrophic NO and N<sub>2</sub>O generation (Kampschreur et al., 2008a; Yu et al., 2010). The magnitude of autotrophic nitrification driven N<sub>2</sub>O emissions also depends directly on NH<sub>4</sub><sup>+</sup>-N concentrations (Yu et al., 2010). Therefore, the positive correlation of NH<sub>4</sub><sup>+</sup>-N and DO concentrations individually with N<sub>2</sub>O emissions in the aerobic zones is in congruence with this new understanding of aerobic autotrophic N<sub>2</sub>O production (Yu et al., 2010). The positive interactive correlation between NH<sub>4</sub><sup>+</sup> and NO<sub>2</sub><sup>-</sup> concentrations and N<sub>2</sub>O emissions suggests high N<sub>2</sub>O emissions from aerobic zone locations, with *simultaneously* high concentrations of both NH<sub>4</sub><sup>+</sup> and NO<sub>2</sub><sup>-</sup>. This interactive correlation also points to autotrophic N<sub>2</sub>O generation mechanisms, since both NH<sub>4</sub><sup>+</sup> and NO<sub>2</sub><sup>-</sup> are co-substrates in autotrophic denitrification by nitrifying bacteria (Beaumont et al., 2005; Beaumont et al., 2004b, Beaumont et al., 2004a).

It should be noted that while nitrification dominates N-cycling in aerobic zones, the possibility of heterotrophic denitrification within activated sludge flocs even under ‘bulk’ aerobic conditions cannot be discounted (Grady et al., 1999). Interestingly, as with nitrification, denitrification driven  $N_2O$  emissions are also caused by high DO and  $NO_2^-$ -N concentrations (Korner and Zumft, 1989; Park et al., 2000; von Schultess et al., 1995; Tallec et al., 2008; Zumft, 1997), among other factors. Thus aerobic zone  $N_2O$  emissions might be linked to both nitrification and denitrification, although it is not possible to differentiate between the two using bulk headspace measurements alone. (von Schultess et al., 1995)

**Anoxic zones:** Several factors have been implicated in  $N_2O$  and NO generation and emission from denitrifying bioreactors, such as low pH (Focht, 1974), short solids retention time (Hanaki et al., 1992), organic carbon limitation (Hanaki et al., 1992; von Schultess et al., 1995; von Schultess et al., 1994), DO inhibition (Tallec et al., 2008; Park et al., 2000) and  $NO_2^-$ -N inhibition (Korner and Zumft, 1989; von Schultess et al., 1995; Zumft, 1997). Inhibition of denitrification by high DO concentrations could also lead to  $NO_2^-$ -N build-up, indirectly leading to  $N_2O$  emissions (Hanaki et al., 1992; Zhou et al., 2008). Thus, the positive correlation of DO and  $NO_2^-$ -N concentrations with  $N_2O$  emissions (Table 4-3) is consistent with known mechanisms of denitrification-related  $N_2O$  production. Soluble COD concentrations in anoxic zones were mostly non-limiting and expectedly did not correlate with  $N_2O$  emissions. A better correlation would be expected with readily biodegradable COD concentrations (rbCOD). However, rbCOD is analytically difficult to measure in the matrix of activated sludge. Thus, a sound inference on organic carbon limitation and  $N_2O$  emissions from the full-scale WWTPs cannot be made. To address the issue of COD limitation on denitrification-related  $N_2O$  emissions better, lab-scale studies were conducted, as described in Chapter 6.0.

The regression model did not correlate temperature and  $N_2O$  fluxes in either aerobic or anoxic zones (Tables 4-2 through 4-3). A possible reason could be that  $N_2O$  fluxes are indirectly governed by temperature through manifestation in  $NH_4^+$ -N,  $NO_2^-$ -N or DO concentrations, described above.

While several factors relevant to activated sludge processes including  $NH_4^+$ ,  $NO_2^-$ , DO, temperature, COD limitation can all lead to  $N_2O$  emissions, it may be difficult to discern their specific contributions from highly noisy full-scale data from multiple plants, each operated under different modes and temperatures. Therefore, it is noteworthy that  $N_2O$  emissions in aerobic and anoxic zones could be correlated with select specific factors and explained via mechanistic



arguments. Further, all model parameter estimates except the intercept of the anoxic zone were statistically valid at the  $\alpha=0.05$  confidence level (Tables 4-1 through 4-2). Nevertheless, it should be noted that the developed model is not a conclusive mechanistic descriptor of causative biological processes contributing to N<sub>2</sub>O emissions from activated sludge. Caution is also advised with respect to predicting emissions on the basis of process configuration alone. The factors correlating with N<sub>2</sub>O emissions, (NH<sub>4</sub><sup>+</sup>-N, NO<sub>2</sub><sup>-</sup>-N and DO concentrations) are inherently linked with process parameters such as TKN loadings, SRT and wastewater composition. Therefore, the propensity for N<sub>2</sub>O emissions of any given WWTP configuration can only be evaluated within the framework of its process operation and performance characteristics.

### **4.3 Spatial and Temporal Variability in N<sub>2</sub>O Generation and Emission from Selected Full-Scale BNR and non-BNR Processes**

#### **4.3.1 Spatial and Temporal Trends in N<sub>2</sub>O Emission Fluxes from Full-Scale WWTPs**

A wide range of N<sub>2</sub>O emission fluxes was observed over the course of the monitoring campaign at different BNR and non-BNR activated sludge facilities (Table 4-1). At the first two facilities sampled, both discrete short-term (lasting about 30 min) and continuous (lasting 24 hours) N<sub>2</sub>O measurements were conducted in multiple locations or zones (Figure 4-3). However, subsequently, the 30 min discrete measurements are not reported, since they did not capture the considerable temporal variability observed in each zone (for instance, as shown in Figure 4-4). For following campaigns, each location or zone was subjected only to 24 diurnal continuous monitoring (Figures 4-7 through 4-10). The results of the campaigns are summarized below systematically according to the plant operating configurations. For the sake of illustrating spatial and temporal variability, the following subset of the overall sampling set was used:

- ◆ Four-pass step-feed BNR process sampled in fall 2008
- ◆ Four-stage Bardenpho process sampled in winter 2009
- ◆ Low-rate separate stage nitrification-denitrification process sampled in winter 2009
- ◆ Two plug-flow processes sampled in winter 2009
- ◆ Four-pass step-feed process with covered aeration tanks sampled in winter 2009

#### **4.3.2 Four-Pass Step-Feed BNR Process**

Based on discrete sampling conducted in different zones of the four-pass step-feed process, in general higher gas-phase and liquid phase N<sub>2</sub>O was measured in the aerobic zones, especially in  $\text{N}_2\text{O}$  was also observed (Figure 4-4).

Based on known microbial pathways responsible for N<sub>2</sub>O generation by bacteria engaged

in BNR reactions, three different potential hypotheses can be put forth to explain these trends in N<sub>2</sub>O emissions.

- (1) At the transition point between the first-anoxic and aerobic zones, it is possible that both nitrification and heterotrophic denitrification contribute to N<sub>2</sub>O emissions. Heterotrophic N<sub>2</sub>O emissions could be related to oxygen inhibition (Knowles, 1982; Korner and Zumft, 1989; Zumft, 1992; Hanaki et al., 1992) experienced by heterotrophic denitrifying bacteria at the transition between the anoxic and aerobic zones. This reasoning is supported by the parallel trends in the diurnal DO concentrations and N<sub>2</sub>O headspace concentrations (For instance, in Figure 4-5).
- (2) The abrupt direction transition from anoxic to aerobic conditions (in the presence of non-limiting NH<sub>4</sub><sup>+</sup> and DO concentrations) also leads to N<sub>2</sub>O generation by nitrifying bacteria. According to recent results, N<sub>2</sub>O generation by ammonia oxidizing bacteria is related to their recovery from anoxic periods and transient imbalances at the gene expression and metabolic levels (Yu et al., 2010). Thus, autotrophic reactions could potentially contribute to the observed N<sub>2</sub>O fluxes at the transition between the upstream anoxic and oxic reactors.
- (3) The high liquid and gaseous N<sub>2</sub>O concentrations observed at the transition of the anoxic and aerobic zones could also be a carryover from the preceding anoxic zone.

At this stage, the individual contribution of each of these factors to overall measured N<sub>2</sub>O emissions cannot be determined and further studies to discriminate between autotrophic and heterotrophic N<sub>2</sub>O production are needed.

### 4.3.3 Four-Stage Bardenpho Process

Based on discrete and continuous measurements, the highest generation and emission of N<sub>2</sub>O occurred at two distinct locations. The first location was at the point of transition between the first-anoxic and aerobic zones (Figure 4-5). The second location was near the effluent end of the aerobic zone (Figure 4-5, aerobic zone 2, diurnal data for this location not shown). The emissions of N<sub>2</sub>O from the anoxic zones were generally statistically lower ( $p < 1.0 \times 10^{-4}$  for all two-tailed t-test comparisons  $\alpha=0.05$  for this WWTP) and less variable than in the aerobic zones (Figure 4.4). A positive although delayed correlation between NH<sub>4</sub><sup>+</sup>, NO<sub>3</sub><sup>-</sup> and gaseous N<sub>2</sub>O concentrations was observed in the aerobic zone (Figure 4-6). At the same time, increasing DO concentrations also correlated well with aerobic zone N<sub>2</sub>O emissions (Figure 4-6). The diurnal variability in anoxic zone N<sub>2</sub>O emissions was much lower and did not correlate with liquid phase

nitrogen species or DO concentrations (Figure 4-6).

#### 4.3.4 Low-Rate Separate Stage Nitrification-Denitrification Process

The low-rate process sampled is located downstream of a high-rate carbonaceous oxygen demand (COD) removal process, which is scheduled for a future sampling campaign. The N<sub>2</sub>O emissions in the low-rate process were much lower than in any of the others tested. The degree of diurnal variability from this process was also much lower than those in others sampled (Figure 4-7). During diurnal sampling, little correlation between N<sub>2</sub>O concentrations and aqueous nitrogen species, dissolved oxygen concentrations or filtered-flocculated chemical oxygen demand (ffCOD) concentrations could be discerned (data not shown) possibly due to the low emission levels. Nevertheless, gaseous N<sub>2</sub>O concentrations in the aerobic zones were statistically higher than those in the downstream anoxic zones (Figure 4-7,  $p=0$  for all two-tailed t-test comparisons at  $\alpha=0.05$ ). These emissions are lower than those measured in a separate nitrification stage of an activated sludge treatment plant measured in the Netherlands (Kampschreur et al., 2008b).

It is believed that the unique configuration and operation of this process contributed to its low N<sub>2</sub>O footprint and can be explained in the following manner. First and foremost, the low degree of diurnal variability in the influent nitrogen to this process (which is dampened by a preceding high-rate carbonaceous removal process) could have led to the low degree of temporal variability in emissions. Secondly, the sequence of anoxic zones following the primary aerobic zones is singular to this process. Based on lab-scale studies, nitrifying bacteria produce N<sub>2</sub>O in a directional fashion (Yu et al., 2010), when they are shifted from a low DO concentration to a high DO concentration in the presence of non-limiting NH<sub>4</sub><sup>+</sup> concentrations. Such a transition (but without the dependency on NH<sub>4</sub><sup>+</sup>) is also responsible for heterotrophic N<sub>2</sub>O production, if factors such as rbCOD limitation occur (as seen in the four-stage Bardenpho process, Figures 4-5 and 4-6). Based on the configuration of this specific process, the unique conditions (individually or in combination) that give rise to a combination of these above factors promoting autotrophic or heterotrophic N<sub>2</sub>O production were all missing, which could explain the relatively lower N<sub>2</sub>O emissions. These observations highlight the need for further development and validation of specific BNR designs that minimize both liquid-phase and gaseous phase nitrogen emissions.

#### 4.3.5 Plug-Flow Processes

Both plug-flow processes sampled are primarily configured and operated for COD removal and nitrification. However, the influent end of both plug-flow processes is typified by oxygen limiting conditions during parts of the day, which could possibly support simultaneous

nitrification and limited denitrification (as suggested by the DO concentrations in Figures 4-8 and 4-9).

Based on initial inferences related to the occurrence of nitrification over the entire tank, two sampling points were chosen, one in the middle of pass 1 and the second in the middle of pass 2 (Figures 4-8 and 4-9). N<sub>2</sub>O emission was higher in the middle region of the second pass of both plug-flow bioreactors, in the presence of non-limiting ammonia and DO concentrations, where nitrification is expected to dominate nitrogen cycling reactions. However, liquid-phase N<sub>2</sub>O concentrations at both the influent end and middle regions of the passes were statistically similar ( $p=0.26$  and  $1.0$ , respectively for two-tailed t-test comparisons at  $\alpha = 0.05$  for the two processes). The relatively lower levels of N<sub>2</sub>O in the influent end of the reactor were possibly due to the N<sub>2</sub>O reducing activity of denitrifying heterotrophic bacteria therein (Figures 4-8 and 4-9). Thus, promoting the co-culture and concerted activity of nitrifying and denitrifying bacteria through appropriate BNR configurations seems essential for the mitigation of biogenic N<sub>2</sub>O from wastewater treatment plants. Notwithstanding the relative magnitudes of relative N<sub>2</sub>O generation and emission, consistent patterns and trends were observed in the two plug-flow processes sampled in this study (Figures 4-8 and 4-9).

#### **4.3.6 Four-Pass Step-Deed (non-BNR) Process (covered aeration tanks)**

The main objective of this plant is COD removal, although based on annual plant data, intermittent nitrification is observed during warmer temperatures. The aeration tanks in this plant are covered to minimize odors. The headspace gases from the aeration tanks are combined and treated in a scrubber.

Due to limited access to the individual covered activated sludge bioreactors, the overall scope of this campaign was focused on determining the magnitude of N<sub>2</sub>O emissions as a fraction of the influent TKN load. Spatial variability in N<sub>2</sub>O emissions could not be inferred. During the diurnal sampling campaign, the headspace N<sub>2</sub>O levels were also quite variable and ranged from 1.0-43 ppmv, resulting in an especially high variability in the emissions flux (Figure 4.10). Given the lack of detailed reactor specific chemical profiling as performed for other facilities and the fact that the headspace gases were gathered and sampled collectively, it was not possible to directly implicate the biological reactions contributing to the observed emissions.

## **4.4 Conclusions**

A high degree of variability in field-scale measurements of N<sub>2</sub>O was observed, both across the WWTPs sampled and within each WWTP. Additionally, aerobic zones, which have

hitherto not been considered in the U.S. EPA approach of estimating N<sub>2</sub>O emissions, generally contributed more to N<sub>2</sub>O fluxes than anoxic zones from BNR reactors. These results severely qualify the conventional use of a single emission factor to ‘estimate’ N<sub>2</sub>O emissions from BNR processes solely by virtue of denitrification. Upon subjecting the nationwide dataset to multivariate regression data mining, high nitrite, ammonium and dissolved oxygen concentrations were positively correlated with N<sub>2</sub>O emissions from aerobic zones of BNR reactors. On the other hand, high nitrite and dissolved oxygen concentrations were positively correlated with N<sub>2</sub>O emissions from anoxic zones. Based on these results, it can be argued that BNR processes that minimize transient or permanent build up of ammonium or nitrite, especially in the presence of dissolved oxygen, are expected to have low N<sub>2</sub>O emissions.

Further information on the mechanisms and triggers for N<sub>2</sub>O emissions from WWTPs needs to be developed and included in mechanistic process models that will enable WWTPs to sustainably minimize both liquid effluent and gaseous nitrogen emissions. These mechanisms are the focus of the lab-scale studies presented next in Chapters 5.0 and 6.0.

Table 4-1. Summary of N<sub>2</sub>O Fluxes and Emission Factors Measured at Full-Scale WWTPs.

Plant Configuration	Temp(°C)	Reactor influent TKN load (g-N/day)	Reactor effluent TN load (g-N/day)	Q (MGD)	% influent TKN emitted as N <sub>2</sub> O	% TN removed emitted as N <sub>2</sub> O	Emission factor (g N <sub>2</sub> O/PE/yr)
<b>Separate-stage BNR</b>	15 ± 0.48	1.8 x 10 <sup>6</sup>	3.6 x 10 <sup>5</sup>	23	0.03 ± 0.00	0.03 ± 0.01	1.2 ± 0.18
	23 ± 0.28	2.3 x 10 <sup>6</sup>	4.3 x 10 <sup>5</sup>	27	0.01 ± 0.00	0.01 ± 0.00	0.28 ± 0.13
<b>Four-stage Bardenpho</b>	14 ± 0.26	8.6 x 10 <sup>5</sup>	1.7 x 10 <sup>5</sup>	7.8	0.16 ± 0.10	0.19 ± 0.12	9.8 ± 6.1
	23 ± 0.20	7.4 x 10 <sup>5</sup>	7.6 x 10 <sup>4</sup>	8.1	0.60 ± 0.29	0.66 ± 0.32	33 ± 16
<b>Step-feed BNR 1</b>	19 ± 0.22	3.1 x 10 <sup>6</sup>	1.4 x 10 <sup>6</sup>	29	1.6 ± 0.83	2.9 ± 1.5	92 ± 47
	25 ± 0.28	2.9 x 10 <sup>6</sup>	9.4 x 10 <sup>5</sup>	30	0.62 ± 0.27	0.90 ± 0.39	33 ± 14
<b>Step-feed non-BNR</b>	17 ± 0.12	8.6 x 10 <sup>6</sup>	4.4 x 10 <sup>6</sup>	71	0.18 ± 0.18	0.37 ± 0.36	13 ± 13
	26 ± 0.81	8.9 x 10 <sup>6</sup>	4.2 x 10 <sup>6</sup>	93	1.8 ± 0.79	3.3 ± 1.5	97 ± 43
<b>Separate centrate*</b>	30 ± 2.3	8.8 x 10 <sup>6</sup>	5.5 x 10 <sup>6</sup>	2.0	0.24 ± 0.02	0.63 ± 0.06	*
	34 ± 0.32	8.5 x 10 <sup>6</sup>	4.2 x 10 <sup>6</sup>	1.6	0.54 ± 0.16	0.96 ± 0.32	*
<b>Plug-flow 1</b>	11 ± 0.20	1.8 x 10 <sup>6</sup>	1.0 x 10 <sup>6</sup>	18	0.40 ± 0.14	0.92 ± 0.32	23 ± 7.9
	23 ± 0.46	1.8 x 10 <sup>6</sup>	7.3 x 10 <sup>5</sup>	15	0.41 ± 0.14	0.70 ± 0.24	28 ± 9.6
<b>Plug-flow 2</b>	11 ± 0.41	6.3 x 10 <sup>5</sup>	4.0 x 10 <sup>5</sup>	8.7	0.62 ± 0.15	1.7 ± 0.41	26 ± 6.4
	22 ± 0.58	6.6 x 10 <sup>5</sup>	4.0 x 10 <sup>5</sup>	6.6	0.09 ± 0.03	0.22 ± 0.06	5.0 ± 1.4
<b>MLE 1</b>	26 ± 1.8	6.8 x 10 <sup>5</sup>	1.9 x 10 <sup>5</sup>	4.0	0.07 ± 0.04	0.09 ± 0.05	6.8 ± 3.5
<b>MLE 2</b>	26 ± 0.17	6.9 x 10 <sup>5</sup>	1.5 x 10 <sup>5</sup>	4.1	0.06 ± 0.02	0.07 ± 0.03	5.4 ± 2.0
<b>Step-feed BNR 2</b>	29 ± 0.18	2.2 x 10 <sup>6</sup>	2.9 x 10 <sup>5</sup>	14	1.5 ± 0.02	1.7 ± 0.02	140 ± 1.2
<b>Oxidation ditch</b>	19 ± 0.58	3.9 x 10 <sup>5</sup>	4.3 x 10 <sup>4</sup>	3.4	0.03 ± 0.01	0.03 ± 0.01	1.8 ± 0.77
<b>Step-feed BNR 3</b>	24 ± 0.78	7.8 x 10 <sup>6</sup>	8.6 x 10 <sup>5</sup>	57	0.05 ± 0.03	0.06 ± 0.03	4.1 ± 2.2

\*: Flow normalized emission factors for centrate are inappropriate since centrate constitutes a miniscule flow rate, while containing up to 30% of the influent TKN load.

Table 4-2. Factors Correlating with N<sub>2</sub>O Emission Fluxes (g N<sub>2</sub>O-N/day) from Aerobic Zones.

<b>Variable</b>	<b>Parameter estimate</b>	<b>Standard error</b>	<b>t value</b>	<b>Pr &gt;  t </b>
Intercept	6.1	0.48	13	0.00
Log(ammonia)	1.0	0.25	4.1	0.00
Log(nitrite)	0.60	0.16	3.7	0.00
Log(DO)	0.59	0.18	3.2	0.00
Log(ammonia)-log(nitrite)	0.18	0.08	2.3	0.03

Table 4-3. Factors Correlating with N<sub>2</sub>O Emission Fluxes (g N<sub>2</sub>O-N/day) from Aerobic Zones.

<b>Variable</b>	<b>Parameter estimate</b>	<b>Standard error</b>	<b>t value</b>	<b>Pr &gt;  t </b>
Intercept	-1.2	0.89	-1.3	0.21
Log(DO)-log(nitrite)	0.67	0.25	2.7	0.01

Table 4-4. Comparison of N<sub>2</sub>O Emissions from Full-Scale Studies Conducted to Date.

Process	Proportion of influent TKN emitted as N <sub>2</sub> O (%)	Reference
Activated sludge (11,000 p.e.)	0.035	(Czepiel et al., 1995)
Nitritation-anammox	2.3	(Kampschreur et al., 2008b)
Separate nitrification stage (620,000 p.e.)	4.0	(Kampschreur et al., 2008b)
Activated sludge (1,000 p.e.)	0.01 – 0.08	(Kimochi et al., 1998)
Activated sludge (60,000 p.e.)	0.02	(Sommer et al., 1998)
Activated sludge (60,000 p.e.)	0.001	(Sümer et al., 1995)
Study of 25 activated sludge processes	0-15	(Wicht and Beier, 1995)
Study of BNR and non-BNR activated sludge processes (range of average emissions)	0.01-1.8	This study



Figures

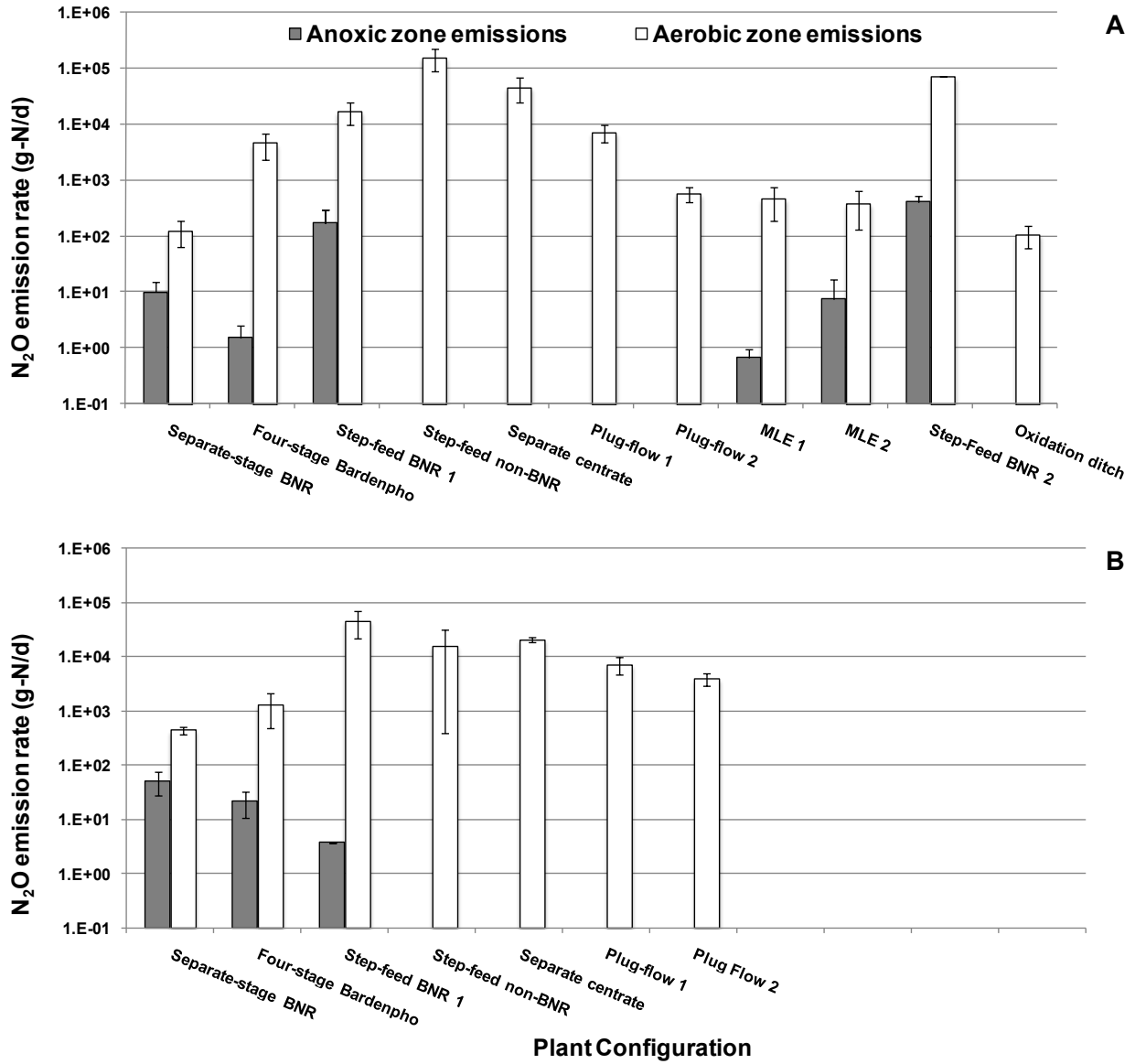

Figure 4-1. N<sub>2</sub>O Emissions from Aerobic and Anoxic Zones in Different WWTPs Measured at High (A) and Low (B) Temperatures. Specific temperatures described in Table 4-1. Step-feed BNR 3 is not included since the emissions from the covered aerobic and anoxic zones could not be distinctly measured.

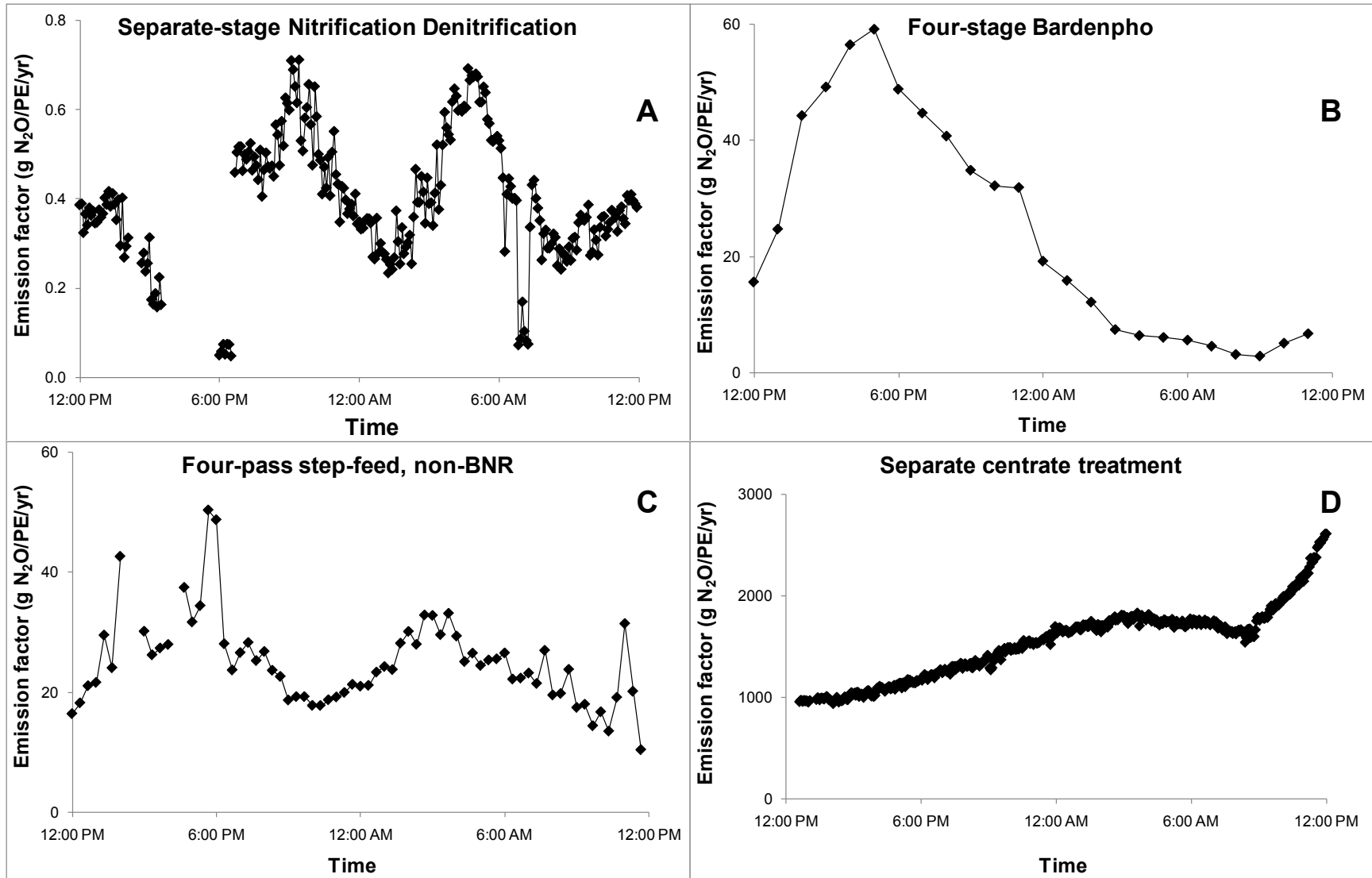





Figure 4-2. Time-Varying N<sub>2</sub>O Emission Factors for Four Select Processes Sampled in this Study at 23 ± 0.28°C (A), 23 ± 0.20°C (B), 26 ± 0.81°C (C) and 34 ± 0.32°C (D).

Species	Anoxic 	Aerobic 1 	Aerobic 2 
NH <sub>4</sub> <sup>+</sup> (mg-N/L)	14	12 ± 5	1.5 ± 0.71
NO <sub>2</sub> <sup>-</sup> (mg-N/L)	0.00 ± 0.00	0.00 ± 0.00	0.00 ± 0.00
NO <sub>3</sub> <sup>-</sup> (mg-N/L)	0.85 ± 0.10	2.7 ± 0.35	10 .± 0.21
DO (mg O <sub>2</sub> /L)	0.10	2.3	4.2
Aqueous N <sub>2</sub> O (μg/L)	55	1 <u>9</u> 0	5 <u>7</u> 0
Gaseous N <sub>2</sub> O (ppmv)	1.5 ± 0.14	16 ± 0.27	23 ± 0.67

**Figure 4-3. Spatial Profile of Gaseous N<sub>2</sub>O Concentrations and Typical Activated Sludge Variables in a Full-Scale Step-Feed BNR Process Showing Individual Sampling Locations.**

Results are from discrete sampling over a period of 30 minutes at each sampling point. Arrows indicate wastewater flow. Shaded and unshaded boxes represent non-aerated and aerated zones, respectively. Gaseous N<sub>2</sub>O concentrations are expressed as avg. ± sd. of 30 measurements.

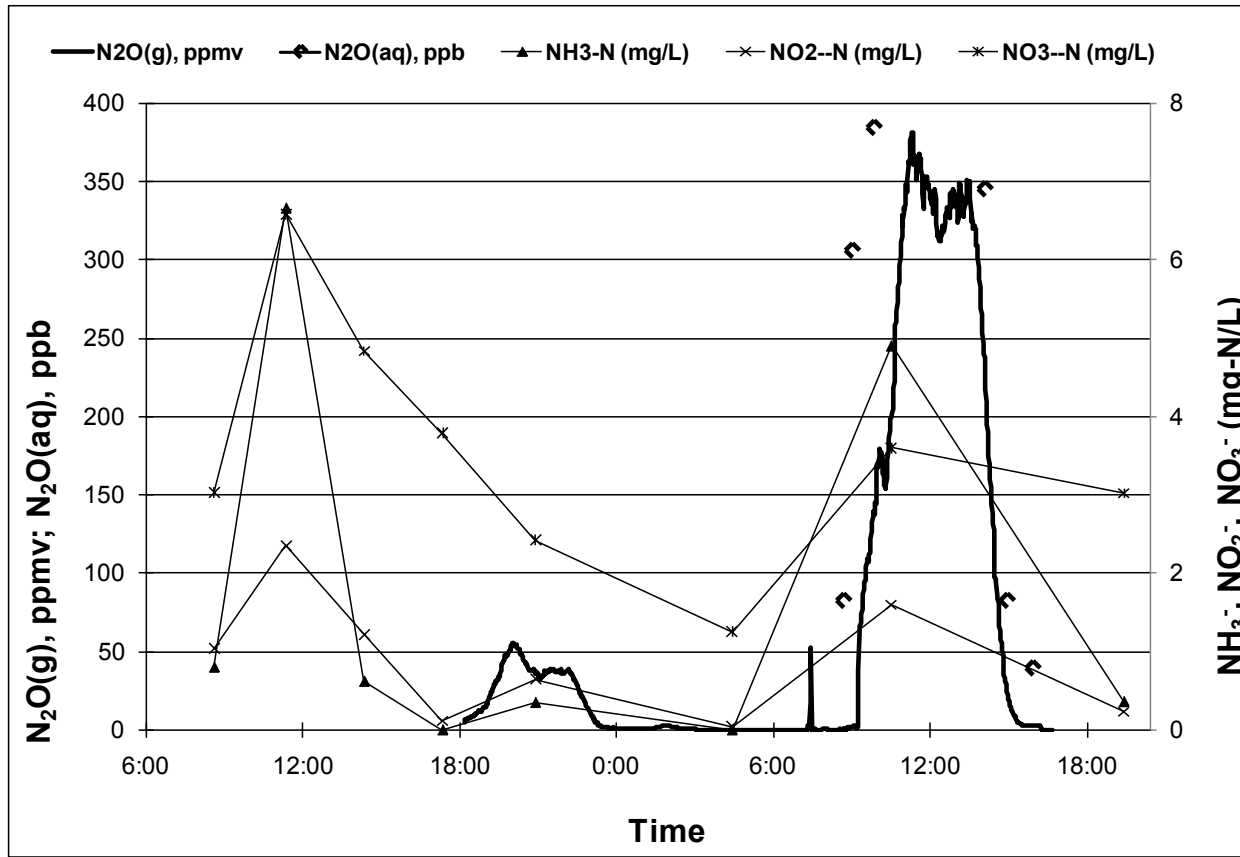

Figure 4-4. Diurnal Variability in Gaseous  $N_2O$  Concentrations Measured from an Aerobic Zone of the Full-Scale Step-Feed BNR Process Depicted in Figure 4-3.

Species	Anoxic →	Aerobic 1 →	Aerobic 2 →	Anoxic 1 →	Anoxic 2 (methanol) →	Aerobic 3 →
NH <sub>4</sub> <sup>+</sup> (mg-N/L)	4.9	3.2	0.50	0.30	0.0	0.0
NO <sub>2</sub> <sup>-</sup> (mg-N/L)	0.10	0.0	0.0	0.0	0.0	0.0
NO <sub>3</sub> <sup>-</sup> (mg-N/L)	5.2	6.9	9.6	7.3	3.6	3.1
DO (mg O <sub>2</sub> /L)	0.16	5.2	4.0	0.21	0.17	4.9
Aqueous N <sub>2</sub> O (μg/L)	22	27	22	12	17	17
Gaseous N <sub>2</sub> O (ppmv)	1.2 ± 0.10	1.8 ± 0.00	2.4 ± 0.14	1.0 ± 0.10	0.69 ± 0.00	1.1 ± 0.00

**Figure 4-5. Spatial Profile of Gaseous N<sub>2</sub>O Concentrations and Typical Activated Sludge Variables in a Full-Scale Four-Stage Bardenpho Process.**

Results are from discrete sampling over a period of 30 min at each sampling point. Arrows indicate wastewater flow. Shaded and unshaded boxes represent non-aerated and aerated zones, respectively. Gaseous N<sub>2</sub>O concentrations are expressed as avg. ± sd. of 30 measurements.

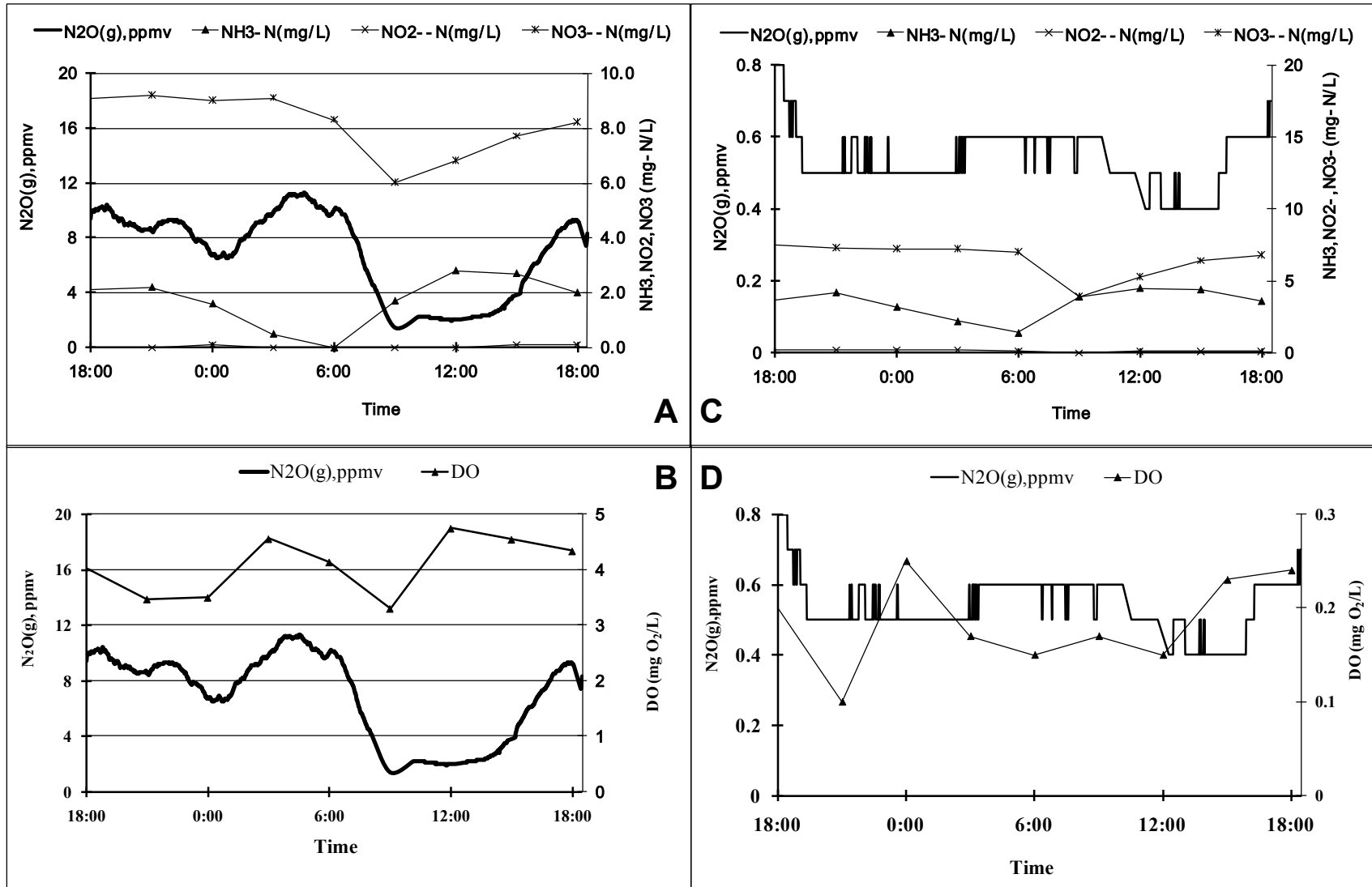



Figure 4-6. Diurnal Variability in Gaseous N<sub>2</sub>O Concentrations Measured from the First Aerobic Zone (A-B) and First Anoxic Zone (C-D) of the Full-Scale Four-Stage Bardenpho Process Depicted in Figure 4-4.



Species	Aerobic 1 →	Aerobic 2 →	De-oxic →	Anoxic (methanol) →
NH <sub>4</sub> <sup>+</sup> (mg-N/L)	4.5 ± 2.9	5.1 ± 3.6	0.57 ± 0.71	1.6 ± 1.1
NO <sub>2</sub> <sup>-</sup> (mg-N/L)	0.00 ± 0.00	0.10 ± 0.00	0.00 ± 0.00	0.10 ± 0.00
NO <sub>3</sub> <sup>-</sup> (mg-N/L)	4.9 ± 1.5	5.1 ± 1.4	7.7 ± 0.60	5.5 ± 1.9
DO (mg O <sub>2</sub> /L)	2.7 ± 0.99	2.0 ± 0.54	0.81 ± 0.68	0.40 ± 0.19
Aqueous N <sub>2</sub> O (µg/L)	21 ± 3.8	24 ± 15	19 ± 9.8	16 ± 7.8
Gaseous N <sub>2</sub> O (ppmv)	3.0 ± 0.36	3.4 ± 1.1	1.3 ± 0.31	1.1 ± 0.15

**Figure 4-7. Spatial Profile of Gaseous N<sub>2</sub>O Concentrations and Typical Activated Sludge Variables in a Full-Scale Separate-Stage Nitrification-Denitrification Process.**  
 Results are from diurnal sampling over a period of 24 hours at each sampling point. Arrows indicate wastewater flow. Shaded and unshaded boxes represent non-aerated and aerated zones, respectively. The lightly shaded box represents a deoxic transition zone, which is also not aerated.



Species	Aerobic 1 	Aerobic 2 
NH <sub>4</sub> <sup>+</sup> (mg-N/L)	11 ± 2.2	6.2 ± 1.2
NO <sub>2</sub> <sup>-</sup> (mg-N/L)	0.27 ± 0.00	0.31 ± 0.10
NO <sub>3</sub> <sup>-</sup> (mg-N/L)	1.9 ± 0.62	4.3 ± 1.3
DO (mg O <sub>2</sub> /L)	1.7 ± 0.32	4.6 ± 0.82
Aqueous N <sub>2</sub> O (µg/L)	58 ± 6.5	58 ± 5.1
Gaseous N <sub>2</sub> O (ppmv)	3.0 ± 1.7	8.2 ± 4.5

**Figure 4-8. Spatial Profile of Gaseous N<sub>2</sub>O Concentrations and Typical Activated Sludge Variables in a Full-Scale Plug-Flow Process.**  
Results are from diurnal sampling over a period of 24 hours at each sampling point.  
Arrows indicate wastewater flow. All zones were aerated.



Species	Aerobic 1 	Aerobic 2 
$\text{NH}_4^+$ (mg-N/L)	$10 \pm 0.99$	$6.2 \pm 2.2$
$\text{NO}_2^-$ (mg-N/L)	$0.27 \pm 0.10$	$0.22 \pm 0.00$
$\text{NO}_3^-$ (mg-N/L)	$1.2 \pm 0.42$	$2.7 \pm 1.1$
DO (mg $\text{O}_2$ /L)	$0.80 \pm 0.47$	$1.8 \pm 1.0$
Aqueous $\text{N}_2\text{O}$ ( $\mu\text{g/L}$ )	$56 \pm 9.8$	$62 \pm 6.0$
Gaseous $\text{N}_2\text{O}$ (ppmv)	$2.9 \pm 0.73$	$51 \pm 21$

**Figure 4-9. Spatial Profile of Gaseous  $\text{N}_2\text{O}$  Concentrations and Typical Activated Sludge Variables in a Full-Scale Plug-Flow Process.**  
Results are from diurnal sampling over a period of 24 hours at each sampling point.  
Arrows indicate wastewater flow. All zones were aerated.

Species	Influent 	Four-pass step-feed (covered tank, non-BNR) 	Effluent 
NH <sub>4</sub> <sup>+</sup> (mg-N/L)	16 ± 4.2		7.0 ± 0.90
NO <sub>2</sub> <sup>-</sup> (mg-N/L)	0.10 ± 0.00		1.5 ± 0.69
NO <sub>3</sub> <sup>-</sup> (mg-N/L)	0.35 0.56		3.5 ± 1.3
N <sub>2</sub> O (ppmv)		13 ± 13	

**Figure 4-10. Spatial Profile of Gaseous N<sub>2</sub>O Concentrations and Typical Influent and Effluent Variables in a Full-Scale Step-Feed (non-BNR) Activated Sludge Process.**

Results are from diurnal sampling over a period of 24 hours at each sampling point.

Arrows indicate wastewater flow. All zones were aerated.



## CHAPTER 5.0

## RESULTS: MOLECULAR MECHANISMS OF AUTOTROPHIC N<sub>2</sub>O AND NO GENERATION AND EMISSION

### 5.1 Impact of Anoxic Conditions on Nitrification by *Nitrosomonas europaea* 19718

The dominant mode of energy generation by AOB is via aerobic metabolic pathways (Chain et al., 2003) (un-shaded enzymes in Figure 5-1). However, under oxygen limiting and anoxic conditions, AOB including *N. europaea*, *N. eutropha* and several *Nitrosospira* spp. can utilize alternate electron acceptors such as NO<sub>2</sub><sup>-</sup>, dimeric nitrogen dioxide (N<sub>2</sub>O<sub>4</sub>) and produce N<sub>2</sub>O and NO, but not nitrogen gas (N<sub>2</sub>) (Bock, 1995; Hooper et al., 1997; Schmidt and Bock, 1997; Schmidt and Bock, 1998) (enzymes shaded grey in Figure 5-1). The generation of N<sub>2</sub>O and NO by chemolithoautotrophic AOB has been demonstrated widely and is predominantly attributed to nitrite reduction (Anderson and Levine, 1986; Sutka et al., 2006; Beaumont et al., 2002; Poth and Focht, 1985; Beaumont et al., 2004b; Ritchie and Nicholas, 1972; Kester et al., 1997; Jiang and Bakken, 1999; Shaw et al., 2006; Goreau et al., 1980; Wrage et al., 2004). While both NO and N<sub>2</sub>O are produced under aerobic and microaerophilic conditions, only NO is produced under strict anoxic conditions (Kester et al., 1997; Ritchie and Nicholas, 1972), consistent with the results of this study. However, almost all previous pure-culture studies on N<sub>2</sub>O and NO production by AOB have focused just on the transition from aerobic to anoxic conditions and the recovery back to aerobic conditions has not been well characterized. Additionally, information on the molecular mechanisms of N<sub>2</sub>O and NO generation related to gene expression in response to abrupt transitions in metabolic activity (for instance, caused by anoxia) are relatively sparse. The significance of this part of the study lies in the correlation of responses at the gene transcription through whole-cell level of N<sub>2</sub>O and NO generation by *N. europaea* cultures, when subject to cyclic transitions in DO concentrations. Such cycling can be encountered in engineered systems such as biological nitrogen removal wastewater treatment reactors, which are configured as sequential aerobic, anoxic or anaerobic reactors (Grady et al., 1999). Periodic cycling in ammonia and oxygen concentrations can also be prevalent and play a role in mediating autotrophic N<sub>2</sub>O and NO emissions from soils (Wrage et al., 2004), which are especially enhanced after soil wetting events (Davidson et al., 1993).

### 5.2 Impact of Transient Anoxic Conditions on Whole-Cell Responses

At steady-state, the effluent NH<sub>4</sub><sup>+</sup> and NO<sub>2</sub><sup>-</sup> concentrations were 2.2 ± 1.1 mg-N/L and 240 ± 41 mg-N/L, respectively. Cell concentrations were 2.4 ± 0.52 \* 10<sup>8</sup> cells/ml with NH<sub>4</sub><sup>+</sup> oxidation associated sOUR values of 7.5 ± 2.7 \* 10<sup>-10</sup> mg O<sub>2</sub>/cell/min. Gaseous N<sub>2</sub>O concentrations were not detectable and hence calculated liquid-phase N<sub>2</sub>O concentrations were zero. Gaseous NO concentrations were 0.76 ± 0.026 ppm by volume and 21 ± 11% of the total cells contained intracellular NO.

The switch to anoxic conditions resulted in almost complete cessation of  $\text{NH}_4^+$  oxidation (determined via mass balance, data not shown) and consequent  $\text{NH}_4^+$  accumulation (Figure 5-2A). The level of  $\text{NH}_4^+$  accumulation paralleled the influent  $\text{NH}_4^+$  load during the anoxic phase (Figure 5-3B). Although imposition of transient anoxia resulted in a significant decrease in cell concentrations (Figure 5-2D), a substantial increase in the ‘potential’  $\text{NH}_4^+$  oxidation activity (measured as sOUR) was consistently observed towards the end of the anoxic phase, with subsequent reduction to steady-state levels (Figure 5-2D), when aeration was switched on again. The peak sOUR was nearly identical for all experiments conducted and did not vary with the level of  $\text{NH}_4^+$  accumulation (data not shown).

As represented by Figure 5-2B, NO and  $\text{N}_2\text{O}$  generation were not coincident in response to transient anoxia.  $\text{N}_2\text{O}$  generation was primarily restricted to the recovery from anoxic to aerobic conditions. Peak  $\text{N}_2\text{O}$  emission consistently occurred just at the recovery from anoxic to aerobic conditions and correlated positively with the extent of  $\text{NH}_4^+$  accumulation at the end of the anoxic phase. The ratio of ( $q_{\text{ns}}/q_{\text{max,ns}}$ ) peaked at the same time as the gas phase  $\text{N}_2\text{O}$  concentrations but the magnitude of the ratio was irrespective of the peak  $\text{N}_2\text{O}$  concentrations themselves (Figure 5-3A). Calculated liquid phase  $\text{N}_2\text{O}$  contributed minimally to the overall nitrogen oxide inventory uniformly during all experiments, as represented by Figure 5-2C. Distinct from  $\text{N}_2\text{O}$ , NO was primarily generated during the anoxic phase and to a lesser extent during the recovery back to the aerobic phase. No systematic correlation was found between the amplitude of the NO peaks in either the anoxic or aerobic phases and the level of  $\text{NH}_4^+$  accumulation (Figure 5-3B). The peak concentrations of NO and  $\text{N}_2\text{O}$  upon recovery to aerobic conditions were also not correlated, presumably since NO was being continuously converted to  $\text{N}_2\text{O}$  (Figures 5-3A through 5-B). The percentage of NO positive cells consistently increased to a peak during the anoxic phase during all experiments and decreased upon recovery to aerobic conditions (Figure 5-2D).

### 5.3 Impact of Transient Anoxia on Gene Expression

Of the four genes under consideration, *nirK*, which encodes for a copper containing nitrite reductase (Chain et al., 2003) was the most responsive gene to transient anoxic conditions (Figure 5.4). The expression of *nirK* increased upon transition to anoxia, but decreased to steady-state levels upon recovery to aerobic conditions. In direct contrast, the expression of *amoA*, *hao* and *norB* uniformly decreased during the anoxic phase. Irrespective of the extent of  $\text{NH}_4^+$  accumulation during anoxia, the reduction in relative mRNA concentrations of *amoA* was the highest, followed by *norB* and *hao*, respectively, for all experiments conducted (Figure 5.4). Under the two higher levels of  $\text{NH}_4^+$  accumulation tested, significant recovery within the anoxic period itself was observed for *hao* expression but not for *amoA* and *norB* expression. The time period of recovery for relative gene expression also correlated positively with the level of  $\text{NH}_4^+$  accumulated during the anoxic phase. In general, reactor  $\text{NH}_4^+$ ,  $\text{N}_2\text{O}(\text{l})$ ,  $\text{N}_2\text{O}(\text{g})$  and  $\text{NO}(\text{g})$  concentrations recovered to steady-state levels before the relative mRNA concentrations (Figures 5.2 through 5.4) suggesting that steady-state was reached faster at the metabolic level than at the gene transcription level.

### 5.4 Directionality in $\text{N}_2\text{O}$ Generation

Based on the results of this study, a distinct directionality in  $\text{N}_2\text{O}$  generation by *N.*

*europaea* was demonstrated. Transition to anoxia itself did not result in N<sub>2</sub>O generation, either in the absence of NH<sub>4</sub><sup>+</sup> (as occurring during the beginning of the oxygen limited period) or presence of NH<sub>4</sub><sup>+</sup> (as occurring at any given time during the anoxic period). Rather, it was the *recovery* from anoxia coupled with the *presence* of accumulated NH<sub>4</sub><sup>+</sup> and oxygen (both captured using Monod-type functions in Equation 5) that resulted in N<sub>2</sub>O generation. In terms of biokinetics, it has been previously shown for chemoorganoheterotrophic denitrification that the rate of N<sub>2</sub>O production from NO is a second order function of NO concentrations (Girsch and de Vries, 1997). In contrast, the rate of autotrophic N<sub>2</sub>O production in this study varied not as a function of NO concentrations, but as a function of NH<sub>4</sub><sup>+</sup> accumulation during the anoxic phase (Figure 5.3A-B). A similar positive correlation between NO generation and transient spikes of NH<sub>4</sub><sup>+</sup> has also been recently reported by mixed nitrifying cultures (Kampschreur et al., 2008a). The lack of N<sub>2</sub>O production (via reduction of NO) during the anoxic phase possibly resulted in the observed sole accumulation of NO (Figure 5.2B). The generation of NO during anoxia accompanied by concurrent higher expression of *nirK* pointed to a well established anoxic metabolism in *N. europaea*, whereby NO<sub>2</sub><sup>-</sup> could be used as a terminal electron acceptor with hydroxylamine (NH<sub>2</sub>OH) or internal reducing equivalents acting as possible electron donors. Reduction of NO concentrations after the initial peak during the anoxic phase point to the depletion of electron donors or decreased activity of reactions producing these donors (for instance, NH<sub>2</sub>OH oxidation as modeled recently (Chandran and Smets, 2008)).

## 5.5 Mechanisms of Autotrophic Responses to Transient Anoxia

The time-response of changes in expression of the four genes demonstrated the high rapidity with which *N. europaea* exhibited a coordinated response to anoxic conditions. This response enables utilization of NO<sub>2</sub><sup>-</sup> as an alternate electron acceptor accompanied by a reduction in the expression of other pathways (such as NH<sub>4</sub><sup>+</sup> oxidation and NO reduction), presumably to conserve energy and cellular resources. Additionally, the slow recovery of mRNA levels compared to recovery in N-species concentrations (indicating metabolic-level recovery) points to a possible mechanism to counter repeated oxygen transients. A similar behavior in selective *amoA* mRNA retention by *N. europaea* and other AOB to address transient NH<sub>4</sub><sup>+</sup> starvation and sufficiency has been described previously (Bollmann et al., 2002). Additionally, the occurrence of N<sub>2</sub>O generation before recovery in *norB* mRNA concentrations upon return to aerobic conditions also suggests that N<sub>2</sub>O generation was governed more at the enzyme activity and metabolic levels rather than solely at the gene transcription level.

The relative expression patterns of four genes involved in nitrogen transformations in *N. europaea* also suggest differential regulation thereof in response to transient anoxia. The presence of high nitrite concentrations (~20 mM) may have resulted in the strong response of *nirK* during the transition into DO limitation (Figure 6.4). It has indeed been shown previously that NO (and in turn N<sub>2</sub>O) generation by co-cultures of *N. europaea* and *Nitrobacter winogradskyi*, (which consequently resulted in low NO<sub>2</sub><sup>-</sup> culture concentrations), was lower than by pure cultures of *N. europaea* (Kester et al., 1997). The increase in *nirK* expression under anoxic conditions reflected negative control of NO<sub>2</sub><sup>-</sup> reduction by oxygen concentrations and once again, possible use of NO<sub>2</sub><sup>-</sup> by *N. europaea* as an electron acceptor, which was eventually diminished upon return to aerobic conditions. On the other hand, the mutually distinct transcription and expression of *nirK* and *norB* in *N. europaea* is in contrast to the parallel expression of these two genes in chemoorganoheterotrophic denitrification (Zumft, 1997).

Although the specific reason for a more rapid recovery in *hao* relative mRNA levels cannot be conclusively determined from the data obtained in this study, it may be speculated that either the accumulating  $\text{NH}_4^+$  concentrations during anoxia or the postulated supporting role of HAO in nitrite reduction (Kester et al., 1997) may have contributed to this observation. The reduced *hao* recovery at the lowest  $\text{NH}_4^+$  accumulation also points to possible control of *hao* expression by  $\text{NH}_4^+$  concentrations under transient anoxic conditions. The differing expression patterns of *amoA* and *hao* are also singular given the well-established electron based coupling between the AMO and HAO (Chandran and Smets, 2008; Hooper, 1969 (b)). Therefore, in both oxidative (*amoA* and *hao*) and reductive (*nirK* and *norB*) metabolism of *N. europaea*, transcription of enzymatically sequential pathways followed independent directions, indicating a high degree of flexibility and versatility in overall energy transduction of *N. europaea*.

## 5.6 $\text{N}_2\text{O}$ and NO as Indicators of Metabolic Activity in *N. europaea*

The coincident peaking of sOUR, ( $q_{\text{ns}}/q_{\text{max,ns}}$ ) and  $\text{N}_2\text{O}(\text{g})$  concentrations (Figure 5-3A) point to a link between  $\text{N}_2\text{O}$  production with periods of high specific activity ( $q_{\text{max}}$ ) or alternately high metabolic rates during periods of high nitrogen flux through the catabolic pathways. This link is underscored by the significantly lower production of  $\text{N}_2\text{O}$  and NO under steady-state operation with correspondingly lower effluent  $\text{NH}_4^+$  concentrations and consequently  $q \ll q_{\text{max}}$ . Given that  $\text{N}_2\text{O}$  generation is associated with a transition from low levels of specific activity ( $q < q_{\text{max}}$ ) towards higher levels ( $q_{\text{max}}$ ), one strategy to minimize  $\text{N}_2\text{O}$  emissions from nitrifying wastewater treatment plants could be to minimize transient build-up of  $\text{NH}_4^+$ -N especially at the interface from the anoxic to the aerobic zones. Indeed, positive correlation between the actual specific ammonium oxidation rate and  $\text{N}_2\text{O}$  emission as observed in this study has recently been used as the basis to propose the use of  $\text{N}_2\text{O}$  emissions as an indicator of nitrification process upsets (Burgess et al., 2002; Butler et al., 2009).

From an engineering perspective, it is essential for operators of wastewater treatment reactors to be able to predict  $\text{N}_2\text{O}$  emission by nitrification (and denitrification), as the wastewater industry makes a concerted effort to sustainably address both *aqueous* and *gaseous* nitrogen pollution. From this standpoint, the formulation of operational parameters such as the ratio of ( $q_{\text{ns}}/q_{\text{max,ns}}$ ) may be significant from both a process perspective and a fundamental understanding of  $\text{N}_2\text{O}$  generation by AOB in wastewater treatment reactors. Based on full-scale measurement campaigns, as described in Chapter 4.0 and in (Ahn et al., 2009),  $\text{N}_2\text{O}$  emissions from nitrifying wastewater treatment plants are restricted mainly to the transition from the anoxic to aerobic zones or to regions of high  $\text{NH}_4^+$  and oxygen concentrations (which lead to high  $q_{\text{ns}}$  values). Therefore,  $\text{N}_2\text{O}$  emissions from these plants appear to be associated with *recovery* from oxygen limitation or alternately to regions of high  $q_{\text{ns}}/q_{\text{max,ns}}$ , precisely as demonstrated by the results of this study. By extension, process configurations that operate under consistent  $q_{\text{ns}}$  values (such as oxidation ditches with uniform DO concentrations) are expected to produce less  $\text{N}_2\text{O}$  than those that subject AOB to frequent transitions in  $q_{\text{ns}}$  (such as sequencing batch or pre-denitrification processes such as Modified Lüd Zack Ettinger).

## 5.7 Conclusions

Based on the results obtained, our initial hypotheses on the triggers of gene expression and  $\text{N}_2\text{O}$  and NO production by *N. europaea* were rejected. The results implicate *recovery* from

abrupt transient anoxia rather than *imposition* thereof, in the generation and emission of N<sub>2</sub>O by chemostat cultures of *N. europaea* – under concomitant NH<sub>4</sub><sup>+</sup> accumulation. In contrast, NO emission is primarily due to *imposition* of anoxia. The gaseous emissions have distinct underpinnings in rapid changes at the gene expression and metabolic levels and can be correlated to changes in specific AOB activity.

From a more practical perspective, in the mixed-communities of BNR activated sludge, both nitrification and denitrification can contribute to overall N<sub>2</sub>O production. Constant cycling between anoxic and aerobic conditions in BNR reactors are expected to promote N<sub>2</sub>O emissions from not only denitrification (owing to O<sub>2</sub> mediated inhibition), especially in the presence of residual organic carbon and nitrate, but also from nitrification, owing to the directional behavior of AOB metabolism, as discussed in this chapter. A big gap existing in our knowledge of N<sub>2</sub>O emissions from WWTPs is the relative contribution of nitrification and denitrification. Building upon the mechanisms of autotrophic N<sub>2</sub>O generation presented in this chapter and factors promoting denitrification related N<sub>2</sub>O emissions (presented next), in combination with <sup>15</sup>N isotopic studies, it might become possible to overcome this knowledge gap in future research.



**Table 5-1. Endpoint and Real-Time PCR Primers Employed in this Study.**  
 Reprinted with permission from *Environmental Science and Technology*, 2010, American Chemical Society.

Primer	Sequence (5'-3')	Position	Target gene	Reference
Endpoint PCR				
A189	GGHGA CTGGGAYTTCTGG	151-168	<i>amoA</i>	(Holmes et al., 1995, Okano et al., 2004)
amoA2R'	CCTCKGSAAAGCCTTCTTC	802-820		
HAO1F	TCAACATAGGCACGGTTCATCGGA	203-226	<i>hao</i>	This study
HAO1R	ATTTGCCGAACGTGAATCGGAACG	1082-1105		
NirK1F	TGCTTCCGGATCAGCGTCATTAGT	31-54	<i>nirK</i>	This study
NirK1R	AGTTGAAACCGATGTGGCCTACGA	809-832		
NorB1F	CGGCACTGATGTTCTGTTTGCTT	479-502	<i>norB</i>	This study
NorB1R	AGCAACCGCATCCAGTAGAACAGA	1215-1238		
KNO50F	TNANACATGCAAGTCGAICG	49-68	Eubacterial 16S rRNA gene	(Moyer et al., 1994)
KNO51R	GGYTACCTTGTTACGACTT	1492-1510		
Quantitative PCR				
amoAFq	GGA CTTCACGCTGTATCTG	408-426	<i>amoA</i>	(Chandran and Love, 2008)
amoARq	GTGCCTTCTACAACGATTGG	524-543		
HAO1Fq	TGAGCCAGTCCAACGTGCAT	266-285	<i>hao</i>	This study
HAO1Rq	AAGGCAACAACCCTGCCTCA	331-350		
NirK1Fq	TGCAGGGCATACTGGACGTT	182-201	<i>nirK</i>	This study
NirK1Rq	AGGTGAACGGGTGCGCATTT	291-310		
NorB1Fq	ACACAAATCACTGCCGCCCA	958-977	<i>norB</i>	This study
NorB1Rq	TGCAGTACACCGCAAAGGT	1138-1157		
EUBF	TCCTACGGGAGGCAGCAGT	339-357	Eubacterial 16S rRNA gene	(Nadkarni et al., 2002)
EUBR	GGACTACCAGGGTATCTAATCCTGTT	780-805		

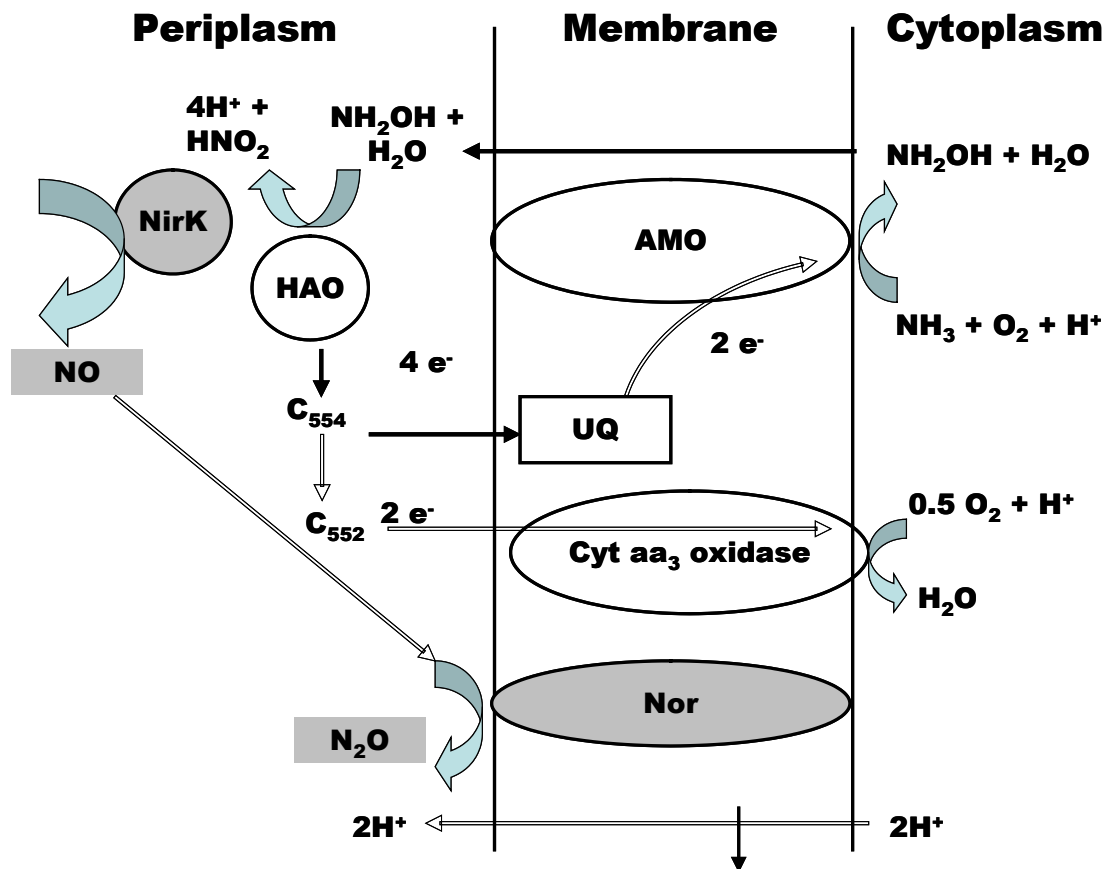

**Figure 5-1. Electron Transport Pathway in *N. europaea*.**  
 Unshaded enzymes (AMO and HAO) represent nitrogen oxidation pathways and shaded enzymes (NirK and Nor) represent nitrogen reduction pathways (after (Hooper et al., 1997))

Reprinted with permission from *Environmental Science and Technology*, 2010, American Chemical Society.

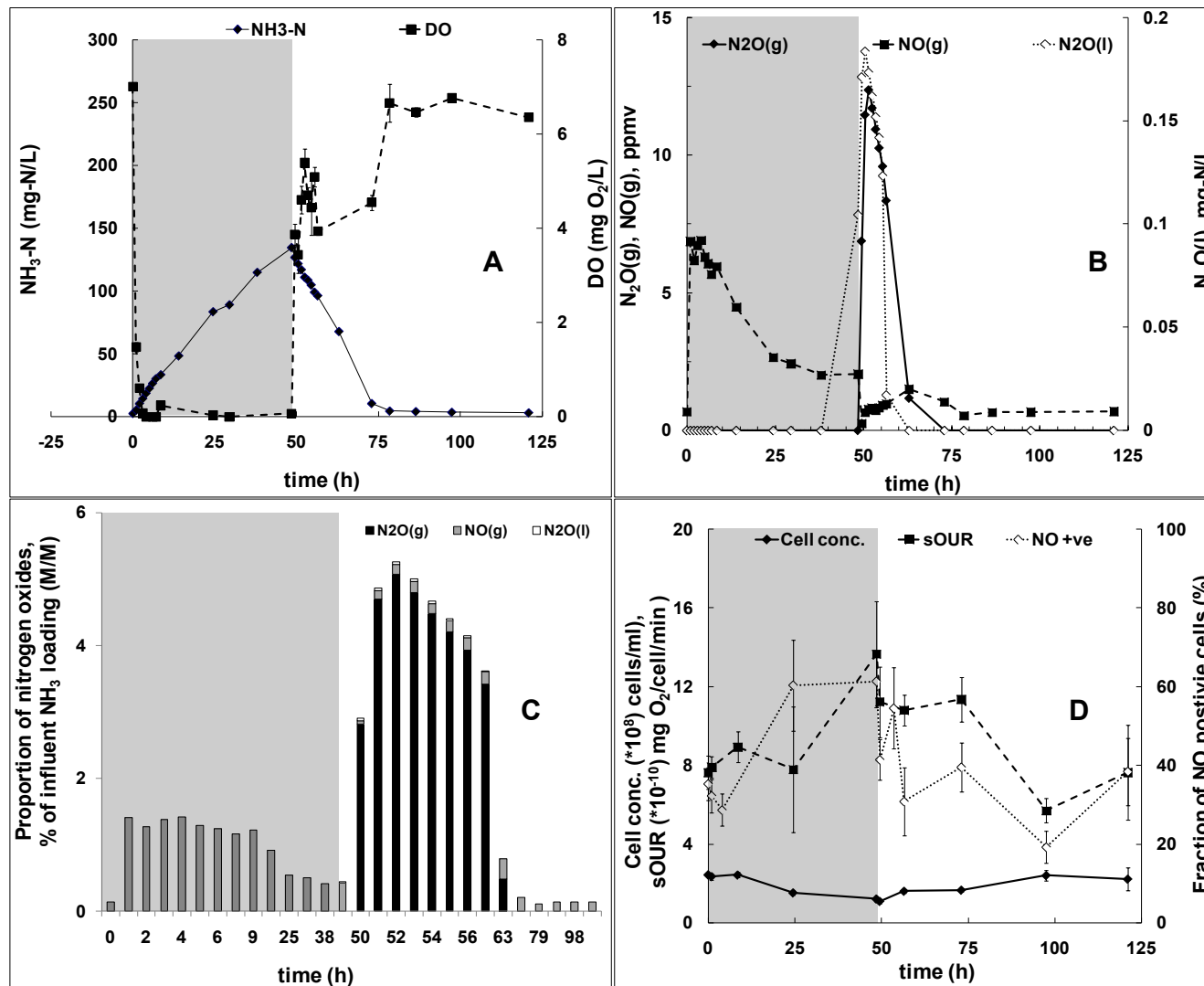

Figure 5-2. Impact of Transient Oxygen Limitation (shown in gray) on  $\text{NH}_4^+$  Accumulation (A), Gaseous  $\text{N}_2\text{O}$ , Gaseous  $\text{NO}$  and Calculated Liquid  $\text{N}_2\text{O}$  (B), Relative Proportion of Influent  $\text{NH}_4^+$  Converted to Gaseous  $\text{N}_2\text{O}$ , Gaseous  $\text{NO}$  and Liquid  $\text{N}_2\text{O}$  (C) and Cell Concentrations, Specific Oxygen Uptake Rate and Proportion of Cells with Intracellular  $\text{NO}$  (D). Reprinted with permission from *Environmental Science and Technology*, 2010, American Chemical Society.

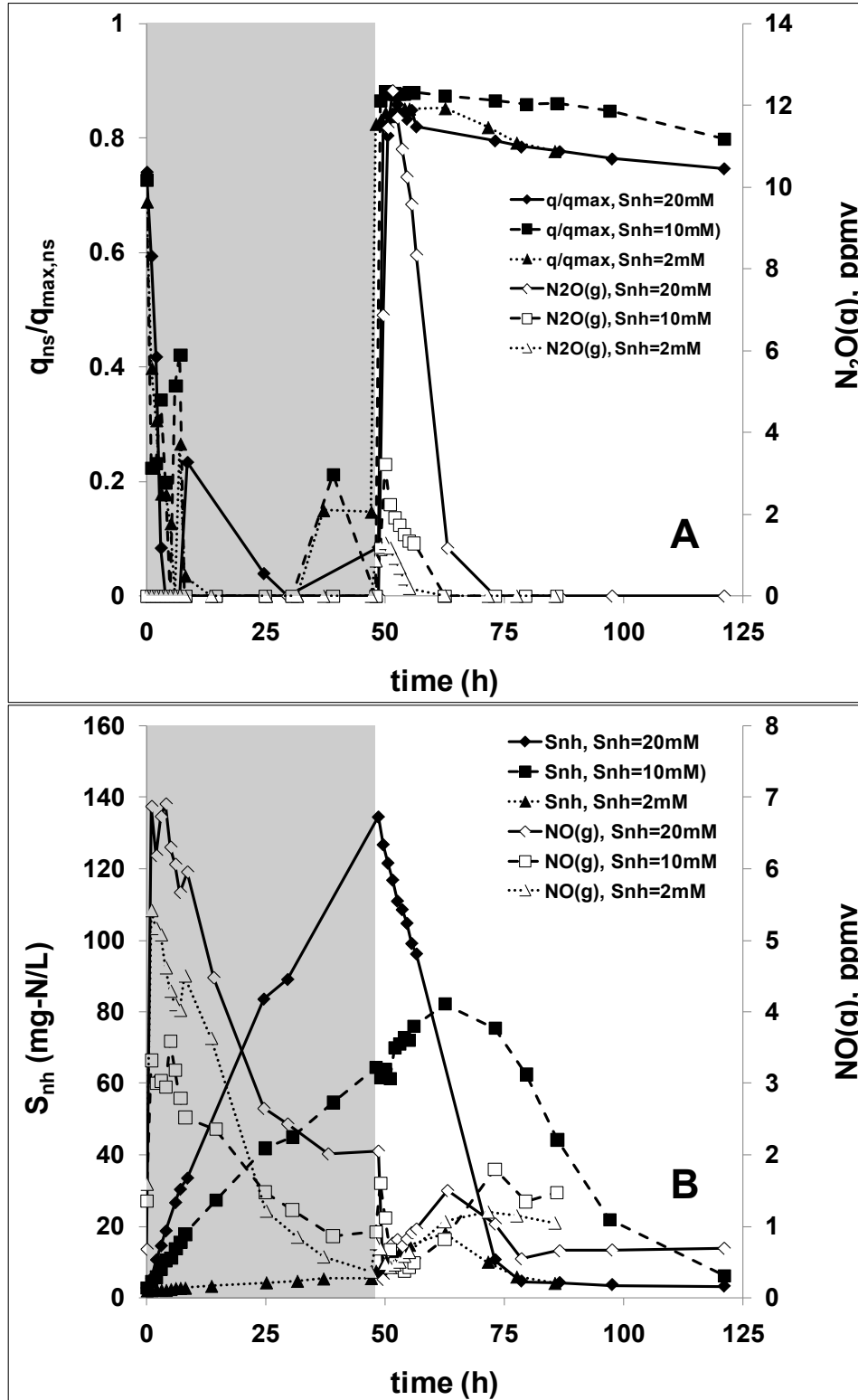

Figure 5-3. Concurrent Peaking of  $q_{ns}/q_{max,ns}$  and Gaseous  $N_2O$  Concentrations Upon Recovery to Aerobic Conditions for Three Different Influent  $NH_4^+$  Concentrations (A), Corresponding Profiles of  $NH_4^+$  and  $NO$  Concentrations during the Same Experiments (B).

Reprinted with permission from *Environmental Science and Technology*, 2010, American Chemical Society.

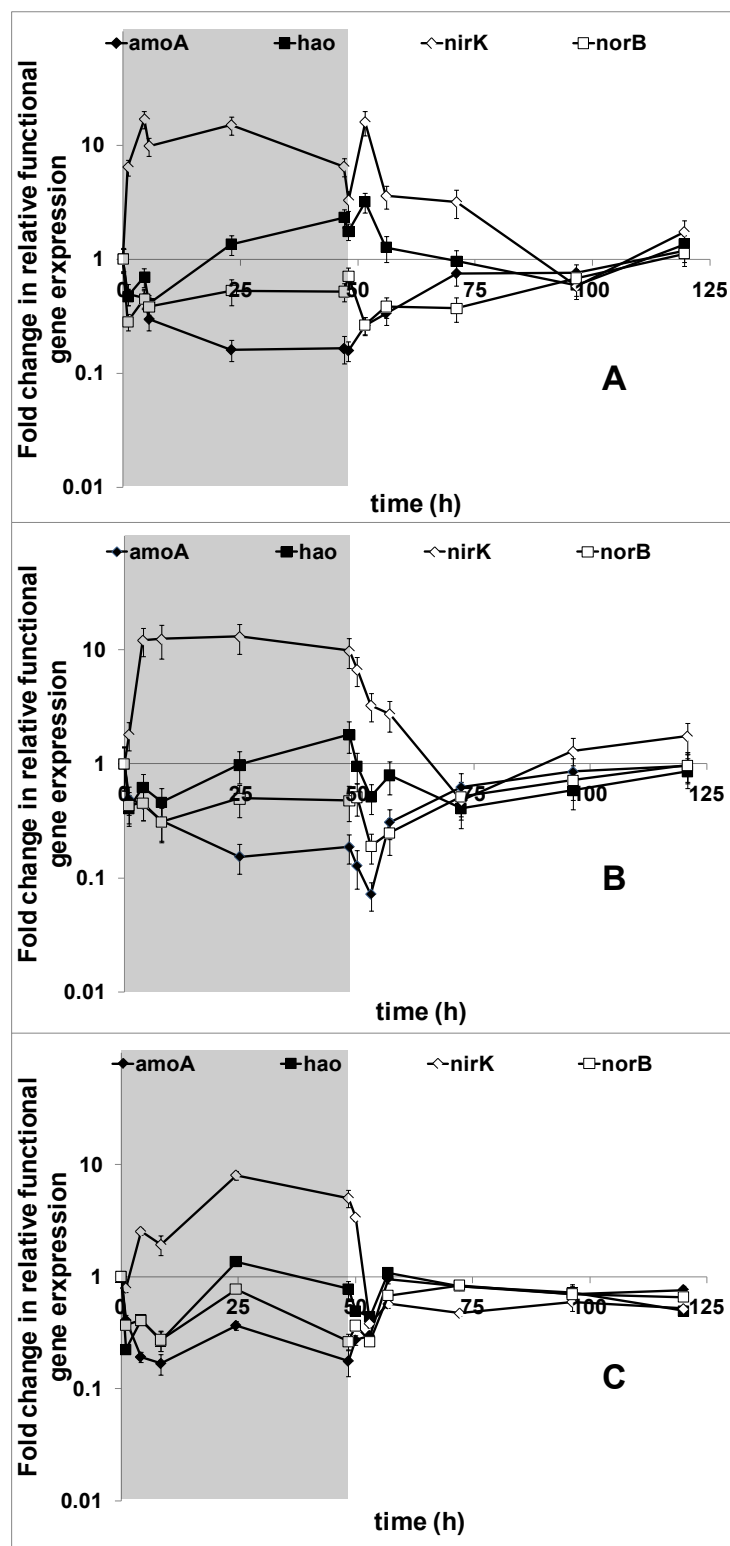

Figure 5-4. Impact of Transient Oxygen Limitation On Select Functional Gene Expression Profiles in *N. europaea* with 20mM (A), 10mM (B) and 2mM (C) Influent NH<sub>4</sub><sup>+</sup> Concentrations during Oxygen Limitation. Influent NH<sub>4</sub><sup>+</sup> Concentrations before and after the Transition Period were 20mM. Reprinted with permission from *Environmental Science and Technology*, 2010, American Chemical Society.

## CHAPTER 6.0

# RESULTS: FACTORS PROMOTING EMISSIONS OF NITROUS OXIDE AND NITRIC OXIDE FROM DENITRIFYING SEQUENCING BATCH REACTORS OPERATED WITH METHANOL AND ETHANOL AS ELECTRON DONORS

## 6.1 Steady State Performance and Emissions of N<sub>2</sub>O and NO during Denitrification using Methanol and Ethanol as Electron Donors

During steady-state operation, near complete nitrate removal was observed in both SBRs (methanol:  $92.5 \pm 11.6$  %, ethanol:  $98.5 \pm 2.5$  %) with minimal nitrite accumulation ( $<1$  mg-N/L). Little N<sub>2</sub>O (methanol:  $0.1 \pm 0.02$  %, ethanol:  $0.1 \pm 0.01$  %) or NO (methanol:  $0.04 \pm 0.01$  %, ethanol:  $0.01 \pm 0.00$  %) was emitted (Figure 1a and 1b). In keeping with the sequential production of the two species during denitrification, NO concentrations peaked before N<sub>2</sub>O concentrations during any given SBR cycle (Figures 6a(1) and b(1)).

Under steady-state operation, factors leading to incomplete denitrification have generally been attributed to N<sub>2</sub>O production. For instance, in a recent study, complete denitrification resulted in 0.1% of the removed nitrate emitted as N<sub>2</sub>O. In contrast, the extent of emissions was substantially higher (1.3%) as nitrate removal dropped to 66% (Tallec et al., 2006). These results are consistent with the low steady-state N<sub>2</sub>O and NO emissions from both SBRs, wherein nitrate removals higher than 90% were observed without concomitant nitrite accumulation. The fraction of influent nitrate removed that was emitted as N<sub>2</sub>O for methanol (0.12%) was comparable with previous results in the range of 0.2-1.3% with methanol (Park et al., 2000). Emissions with ethanol enriched denitrifying bacteria have not been reported previously and thus cannot be directly compared.

## 6.2 Impact of Transient Carbon Limitation

Transient carbon limitation resulted in transient nitrate accumulation for both methanol and ethanol fed SBRs. Relatively lower nitrate accumulation was observed during ethanol

limitation than during methanol limitation (data not shown), which can be explained by faster denitrification biokinetics for ethanol than methanol (Baytshtok et al., 2009). Nitrite accumulation was similar for both COD sources and much lower than nitrate accumulation (data not shown). However, owing to the long react phase and the operating SRT of 10 days, complete nitrate removal was eventually observed by the end of the overall cycle for both reactors. N<sub>2</sub>O and NO emissions during a cycle were statistically lower than steady state control for the methanol fed SBR, but were largely similar in the ethanol fed SBR (Figures 6-1a and b).

The lack of significant N<sub>2</sub>O emissions during carbon limitation are in contrast to some previous reports. It has been postulated that the higher electron affinities of two upstream denitrification enzymes, NaR and NiR, relative to downstream NOR and N<sub>2</sub>OR enzymes could be the reason for N<sub>2</sub>O accumulation during carbon limitation (Betlach and Tiedje, 1981; Knowles, 1982). While specific enzyme affinities were not directly measured in this study, it is possible that the distinct populations fostered by methanol and ethanol (as described previously Baytshtok et al., 2009) might possess more uniform and high affinities across the sequential reductive nitrogen cascade, leading to the lack of N<sub>2</sub>O and NO emissions during carbon limitation.

The possession of high affinities could be due to the high operating SRT of the SBRs for over two years, which could have resulted in long-term enzymatic adaptation to low substrate (carbon and nitrate) concentrations. Indeed, minimal N<sub>2</sub>O emissions were observed from acetate-limited denitrifying reactors operated at high SRT values (10 days) (Hanaki et al., 1992). Additionally, adaptation of *Alcaligenes faecalis* cultures to cycling between feast and famine resulting in lower N<sub>2</sub>O production has also been shown (Otte et al., 1996). Therefore, these results show that the link between carbon limitation and N<sub>2</sub>O emission may not be universal for all carbon sources and operating conditions, and needs to be evaluated more specifically.

### 6.3 Impact of Nitrite Inhibition

Exposure to nitrite led to statistically higher nitrate accumulation at the end of the SBR cycle for both carbon sources, indicating feedback inhibition of nitrate reduction by nitrite (data not shown). However, near complete nitrite reduction was still achieved in the ethanol fed SBR, but not in the methanol fed SBR ( $76.5 \pm 3.2$  %). The nitrite transient also resulted in a slightly elevated secondary peak of NO (Figure 2a(3) and 2b(3)) compared to steady-state (Figure 6-2a(1) and 6-2b(1)) for both SBRs. Nevertheless, N<sub>2</sub>O emissions were not impacted and the resulting fractions of nitrate converted to N<sub>2</sub>O and NO were statistically similar (at the  $\alpha=0.05$  confidence level) to those at steady state (Figure 6-1a).

It has been previously suggested that N<sub>2</sub>OR is more sensitive to nitrite inhibition compared to other enzymes in denitrification, thus leading to N<sub>2</sub>O production under nitrite exposure (Knowles, 1982). Besides the direct impact of nitrite, N<sub>2</sub>OR inhibition can also be due to NO, which is formed from nitrite reduction (Goretski et al., 1990). Indeed, accumulation of N<sub>2</sub>O and NO during denitrification in the presence of nitrite was observed with acetate and yeast extract fed denitrifying cultures, with an inhibitory threshold nitrite concentration of approximately 10 mg-N/L (Hanaki et al., 1992; von Schultess et al., 1995). However, at the same nitrite concentration, little N<sub>2</sub>O production was observed from activated sludge with sucrose as sole carbon source. Another study using pure cultures of *Alcaligenes sp.* and *P. fluorescens* grown on nutrient broth as carbon source also reported no impact of nitrite pulses on N<sub>2</sub>O accumulation (Betlach and Tiedje, 1981). The differences in N<sub>2</sub>O production as a function of nitrite exposure in these different studies possibly could be due to the different carbon sources used or the mode of cultivation used. Therefore, the previous results and this study essentially underscore the lack of generality in the link between nitrite exposure and N<sub>2</sub>O production, from denitrification using different carbon sources.

#### 6.4 Impact of Oxygen Inhibition

In both methanol and ethanol fed SBRs, a rapid initial accumulation of nitrate was observed upon the introduction of air or oxygen (Figure 6-3). Higher inhibition of oxygen on nitrate reduction occurred in the methanol fed SBR. In contrast, a higher (but delayed) nitrate removal occurred in the ethanol fed SBR at all DO concentrations. As expected, there was a positive correlation between DO concentration and the extent of nitrate accumulation for both carbon sources. High nitrite accumulation was also observed in both SBRs, but was more pronounced in the ethanol fed SBR due to ongoing nitrate reduction therein. N<sub>2</sub>O emission was statistically higher than the control in the ethanol fed SBR (Figures 6-4b through d) and the highest emissions were at DO = 9.0 mg/L, where as much as 7.1% of influent nitrate load was emitted as N<sub>2</sub>O (Figure 6-1b). NO emissions were much lower, but displayed a similar positive correlation with increasing DO concentrations. In contrast, methylophilic denitrification did not result in significant N<sub>2</sub>O or NO emissions at any DO concentration tested (Figure 6-3a).

The relative production of N<sub>2</sub>O by the two SBRs could not be entirely described by a reduction in their specific nitrate depletion sDNR values (Figure 6-5). Though the sDNR values for the ethanol SBR were consistently higher than those for the methanol SBR, the extent of reduction due to oxygen inhibition was statistically similar (at the  $\alpha=0.05$  confidence level) and not in correspondence with much higher N<sub>2</sub>O production from the former (Figure 6-4). The inability of nitrate sDNR values to describe the extent of N<sub>2</sub>O emissions is expected and can be



attributed to inhibition of not just NaR but also the other nitrogen reductases by oxygen.

It is reported that  $N_2OR$  is more sensitive to oxygen inhibition than the remaining upstream nitrogen reductase enzymes, thus leading to selective  $N_2O$  production (Knowles, 1982; Korner and Zumft, 1989). Based on the results of this study, differential  $N_2O$  production could also be related to differential NaR inhibition by oxygen. In the methanol-fed SBR, complete cessation of nitrate reduction occurred at the highest oxygen concentration tested (Figure 6-3a(3)). Therefore, the lower level of nitrite,  $N_2O$  or  $NO$  production in the methanol-fed SBR was in fact mainly due to less upstream nitrate reduced than in the ethanol-fed SBR (Figure 6-3a). It should be pointed out that downstream nitrogen reductases (NOR and  $N_2OR$  enzymes) could also have been inhibited in the methanol-fed SBR, but this could not be discerned due to the lack of accumulation of their substrates. On the other hand, the NaR system in the ethanol fed SBR was seemingly more robust, as reflected in near-complete albeit delayed nitrate reduction (Figure 6-3b). However, such ongoing nitrate reduction under oxygen inhibiting conditions resulted in  $N_2O$  production.

## 6.5 Conclusions

This study emphasizes that  $N_2O$  and  $NO$  emissions from denitrification cannot be generalized for all carbon sources, and must be addressed on a case-specific basis. Based on the differences observed, specific mechanisms and pathways of  $N_2O$  and  $NO$  production on different carbon sources also need to be elucidated. Additionally, dosing of ethanol to anoxic zones in BNR processes might need to be strictly controlled not only to minimize ethanol wastage but also to minimize the generation and emission of  $N_2O$  in downstream aerobic zones.

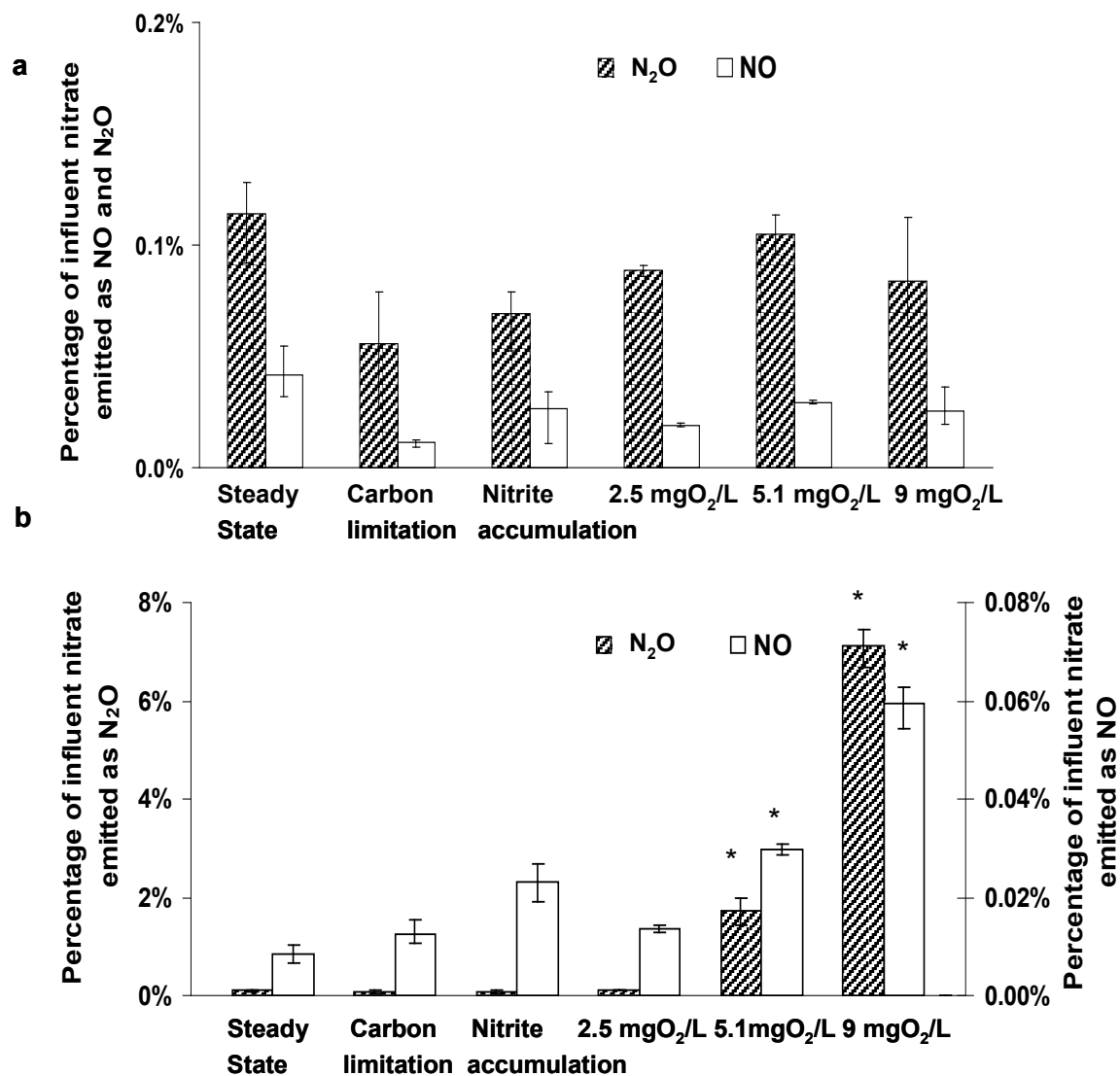

Figure 6-1. Fraction of Influent Nitrate Load Emitted as N<sub>2</sub>O and NO in (a) Methanol Fed SBR and (b) Ethanol Fed SBR Under Steady State, Carbon Limitation, Nitrite and DO Inhibition.

\* indicates results significantly different from steady-state at  $\alpha = 0.05$ .

Reprinted with permission from *Biotechnology and Bioengineering*, 2010, John Wiley and Sons.

■ N<sub>2</sub>O    ◆ NO

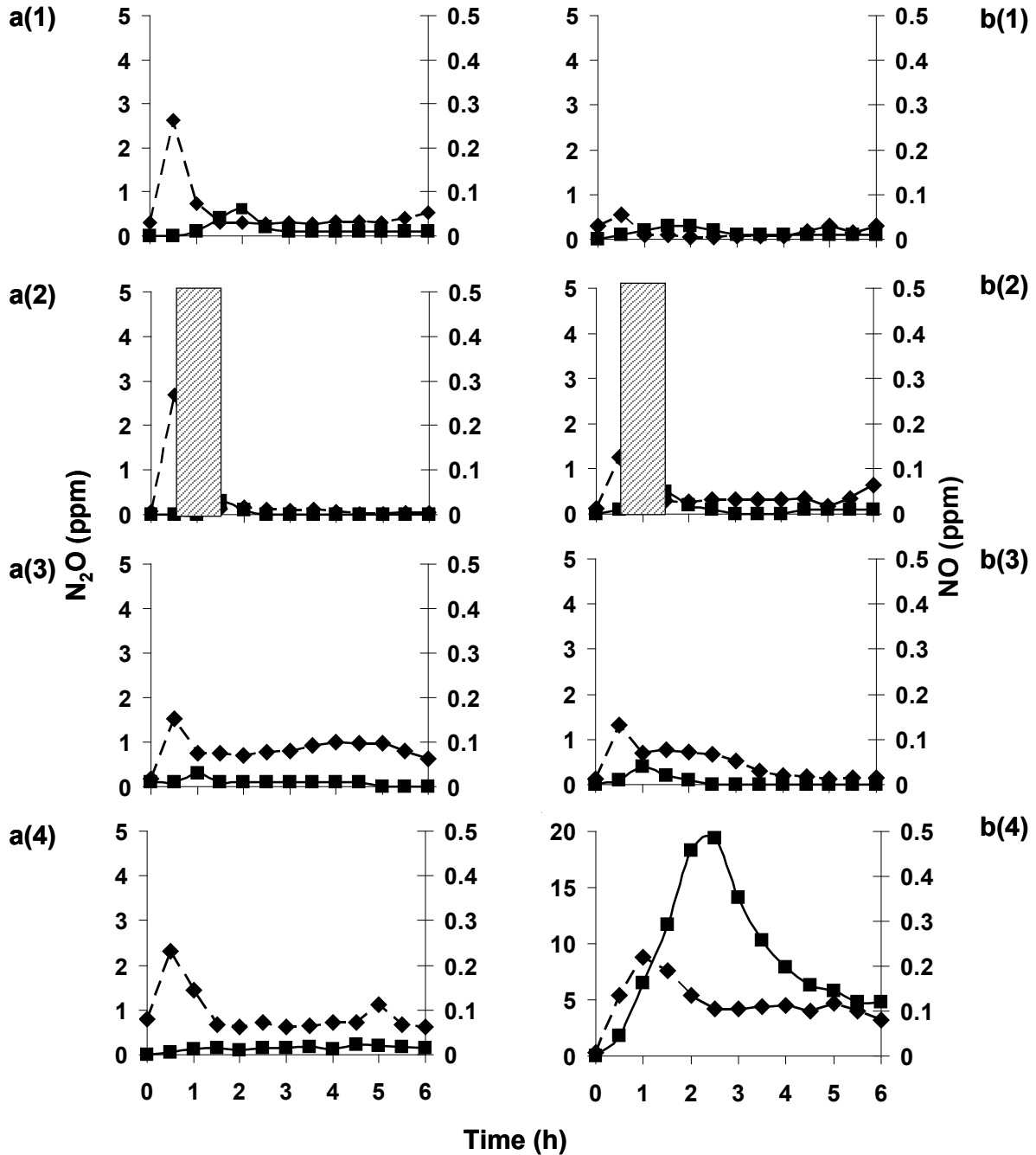

Figure 6-2. Representative N<sub>2</sub>O (primary axis) and NO (secondary axis) Emissions from (a) Methanol Fed SBR and (b) Ethanol Fed SBR Under Steady State (1), Carbon Limitation, Shaded Box (2), Nitrite Inhibition (3), and DO Inhibition at 9.0 mg O<sub>2</sub>/L (4).

Reprinted with permission from *Biotechnology and Bioengineering*, 2010, John Wiley and Sons.

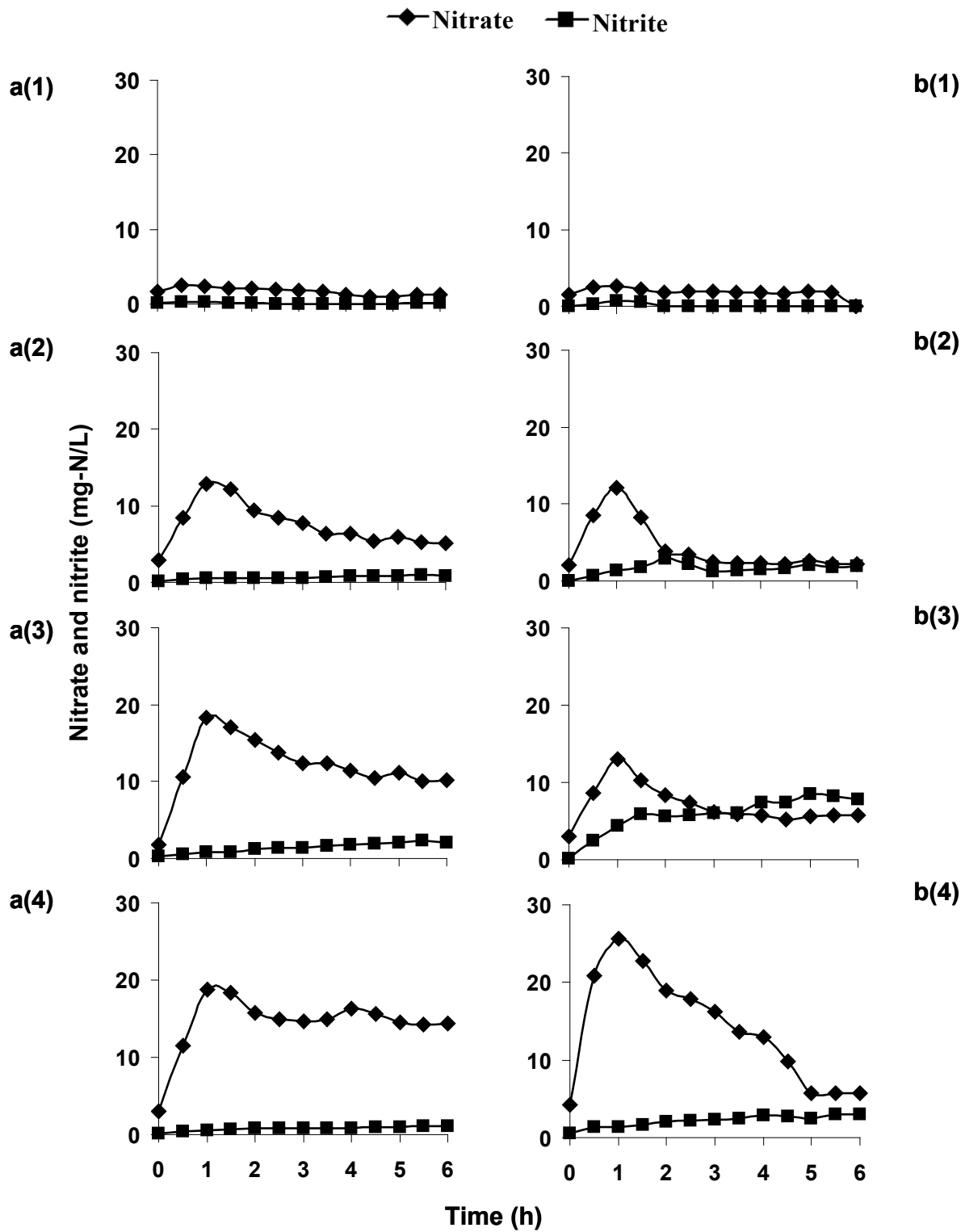

Figure 6-3. Representative Nitrate and Nitrite Concentrations from (a) Methanol Fed SBR and (b) Ethanol Fed SBR Under Steady-State (1) and Different DO Concentrations (2)-(4): DO=2.5, 5.1 and 9.0 mg/L Respectively. The SBR cycle phases were the same as shown in Figure 7-2.

Reprinted with permission from *Biotechnology and Bioengineering*, 2010, John Wiley and Sons.

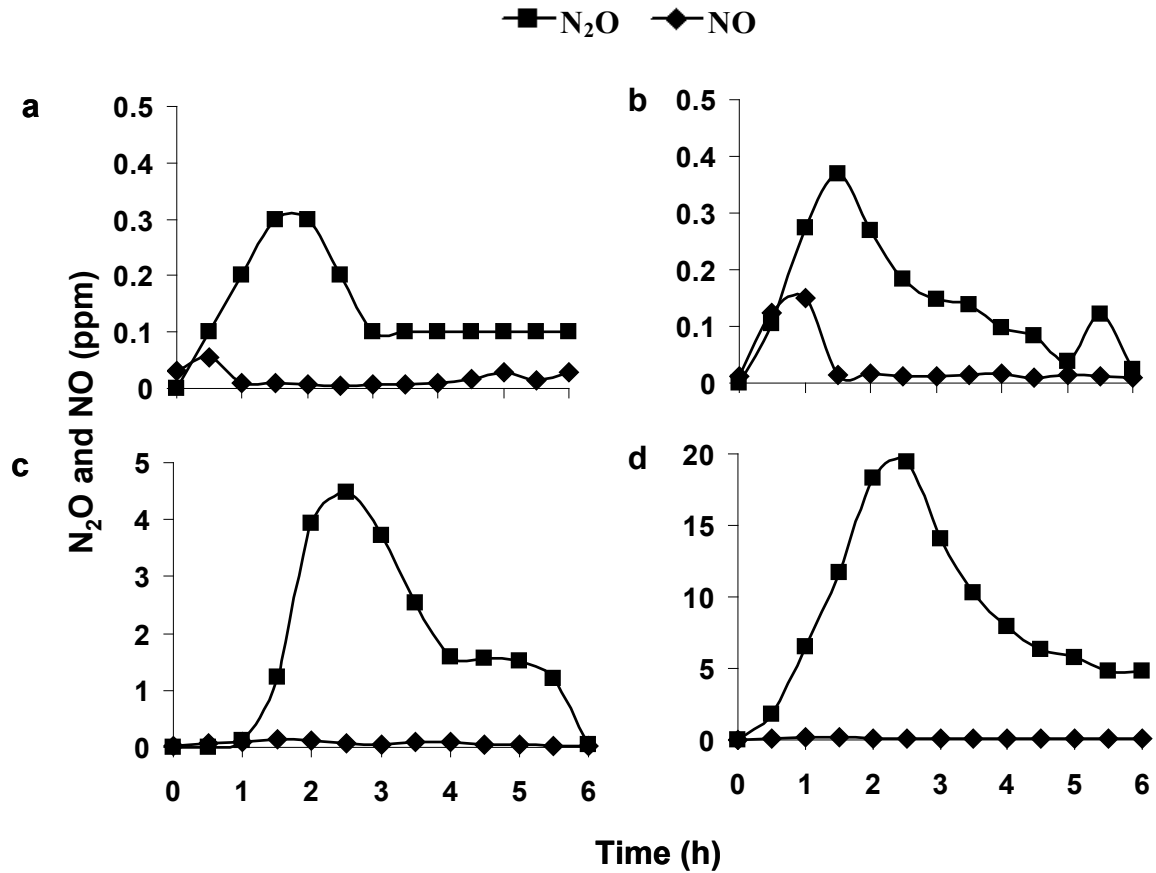

Figure 6-4.  $\text{N}_2\text{O}$  and NO Emissions from Ethanol Fed SBR Under Steady State (a) and Different DO Concentrations (b-d: DO=2.5, 5.1 and 9.0 mg/L Respectively). The corresponding nitrate and nitrite profiles are shown in Figure 7-3-b-1 through 7-3-b-4. Reprinted with permission from *Biotechnology and Bioengineering*, 2010, John Wiley and Sons.

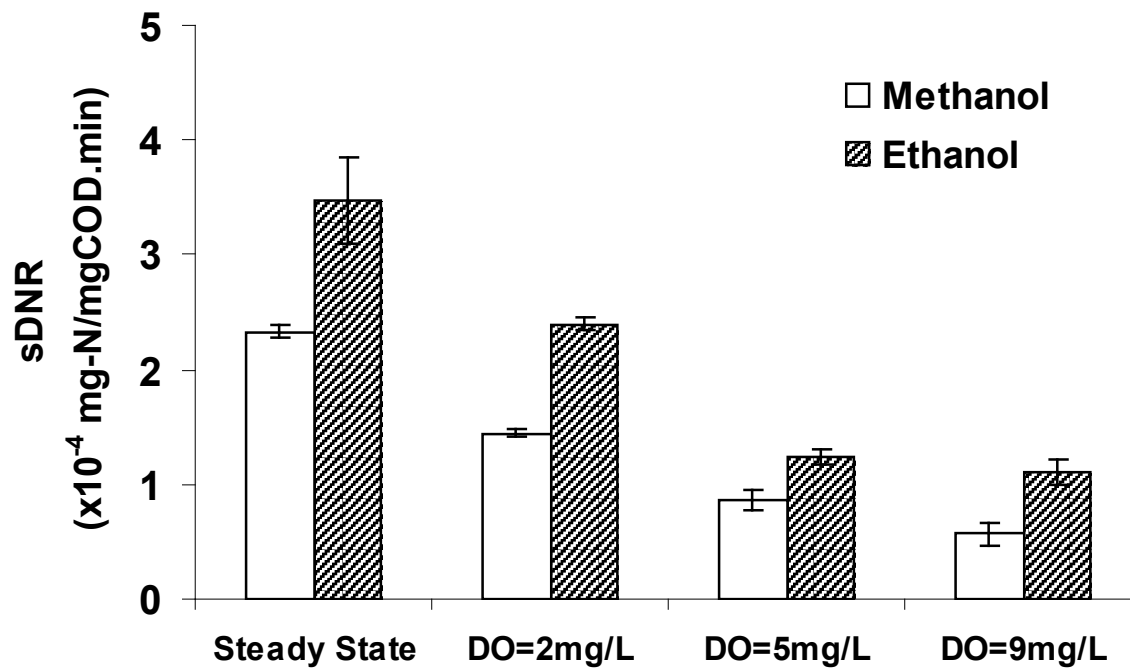

Figure 6-5. Impact of DO Concentrations on Biokinetics of Methanol- and Ethanol-Based Denitrification. Reprinted with permission from *Biotechnology and Bioengineering*, 2010, John Wiley and Sons.



## CHAPTER 7.0

## INTERIM CONCLUSIONS, RECOMMENDATIONS, AND ONGOING STUDIES

### 7.1 N<sub>2</sub>O Emissions from Different WWTP Configurations

The results from this study are important since they involve the first systematic measurement of N<sub>2</sub>O inventories from wastewater treatment processes in the United States with a wide range of process configurations and operating conditions. Based on the results of this study, it should be noted that wastewater plants are not expected to be prime contributors to overall N<sub>2</sub>O fluxes. In the absence of this study, there would continue to be lingering uncertainties regarding the magnitude of N<sub>2</sub>O emission fluxes from wastewater treatment facilities, owing to the limitations of the currently followed ‘estimation’ approach. Indeed, some studies in the Netherlands and Germany have implicated WWTPs to be far more significant contributors to N<sub>2</sub>O emissions than that found in this work. Specifically, N<sub>2</sub>O emissions as high as 7-15% of the TKN load processed have been reported in these previous studies (Kampschreur et al., 2008b; Wicht and Beier, 1995). Such uncertainty could lead to unrealistic regulatory mandates for both *aqueous* and *gaseous* N-discharges from WWTPs. This would be unnecessarily burdensome on WWTPs, some of which are already strained to meet increasingly lower nutrient removal mandates. Therefore, the authors feel that this work represents a significant extension to scientific knowledge in the direction of greenhouse gas emissions from WWTPs.

### 7.2 Estimation of N<sub>2</sub>O Emission Factors

This study has considerably expanded the database of N<sub>2</sub>O emissions obtained from WWTPs (as summarized in Chapter 4.0, Table 4-4). Notably, the information on N<sub>2</sub>O emissions obtained in this study has been predominantly using online measurements. These are necessitated because of the continuously changing emissions, resulting from the dynamic response of nitrifying and denitrifying bacteria to changing influent loads and process conditions (such as DO and local N-species concentrations). Therefore, this study is a big improvement over previous ones that relied on spatially localized or discrete measurements of N<sub>2</sub>O concentration measurements or discontinuous (grab-sample based) N<sub>2</sub>O emissions measurements. As this study and other studies worldwide expand to even more BNR and non-BNR configurations, it is expected that the range of emissions and emission factor estimates will evolve and improve considerably.

### 7.3 N<sub>2</sub>O Emissions from Different WWTP Configurations

When compared to previous such full-scale studies in Europe and Japan, the range of N<sub>2</sub>O emissions observed in this study is relatively smaller, falling mostly in the range 0.03 – 0.60% (Table 4.IV). The only other study in the United States was from a single non-BNR facility in Durham, NH and reported that 0.035 % of the influent TKN load was emitted as N<sub>2</sub>O



(Czepiel et al., 1995). The emissions measured in the present study, which are all from activated sludge reactors treating primary effluent are notably lower than those in separate anaerobic digestion reject water treatment measured recently in the Netherlands (Kampschreur et al., 2008b). Additional processes/configurations yet to be sampled are expected to provide more information on the relative range of N<sub>2</sub>O emissions. Based on full-scale data gathered to date and lab-scale observations, it is expected that the specific sequence of anoxic- and aerobic- zones and the extent of loading to a process govern the overall N<sub>2</sub>O emissions from a given activated sludge process. Since the configurations and loadings were widely different (Table 4-1), no generalizations can be made at this point regarding the efficacy of one process configuration over another in limiting N<sub>2</sub>O emissions.

A specific correlation between operating temperature and N<sub>2</sub>O emissions cannot be inferred at this stage. Additional sampling campaigns at different temperatures are being conducted at each WWTP to determine the impact of temperature on measured N<sub>2</sub>O emissions.

#### **7.4 Implications of Variability in N<sub>2</sub>O Emissions on Inventory Calculations**

Given the substantial spatial and diurnal variability and the broad range of emission fractions obtained from the different WWTPs in this study, the concept of a ‘single lumped’ emission factor to describe dynamic nitrification or denitrification related N<sub>2</sub>O generation and emission, as followed by the U.S. EPA and the IPCC, is inadequate. Normalization of emission factors to wastewater flow rate may not be appropriate owing to different global water use patterns (Tchobanoglous et al., 2003) or to internally generated high-strength, low flow rate reject water or centrate streams. Additionally, given the high degree of spatial and temporal variability of measured N<sub>2</sub>O emissions, the development, calibration and validation of dynamic mechanistic process models that capture such variability would be more appropriate.

#### **7.5 Mechanisms of N<sub>2</sub>O Emissions by Nitrification and Denitrification**

Based on the lab-scale studies presented in Chapter 4.0 and 5.0, new insights have been developed into the mechanisms of N<sub>2</sub>O emissions specifically from nitrification and from denitrification using different external electron donors. From the viewpoint of nitrification, the predominant factors implicated in N<sub>2</sub>O production have been oxygen limitation or anoxia and high nitrite concentrations (as discussed in (Yu et al., 2010)). Based on recent results ((Yu et al., 2010) and shown in Chapter 4.0), N<sub>2</sub>O generation from nitrification can also occur under completely aerobic conditions, in the presence of non-limiting NH<sub>4</sub><sup>+</sup>-N and DO concentrations. Although not conclusively proven at full-scale, this mechanism could be potentially involved in N<sub>2</sub>O emissions observed just at the transition between primary anoxic zones and aerobic zones or at the effluent end of plug-flow systems in the presence of non-limiting NH<sub>4</sub><sup>+</sup>-N and DO concentrations (as discussed in Chapter 4.0).

As discussed in (Lu and Chandran, 2010) and in Chapter 6.0, the type of external carbon source used for denitrification can also have an impact on N<sub>2</sub>O and NO emissions. In a direct comparison between methanol and ethanol, N<sub>2</sub>O emissions from the latter were statistically higher during oxygen mediation denitrification inhibition. Therefore, from a practical perspective, it is important for anoxic zones to be adequately sized to minimize the break-through of the electron donor (like ethanol) and nitrate into succeeding aerobic zones and consequently production of N<sub>2</sub>O and NO.

## 7.6 N<sub>2</sub>O Emissions from WWTPs and Sustainable BNR Design and Operations

The sustainable management of nitrogenous pollution is one of the grand challenges of the National Academy of Engineering (<http://www.engineeringchallenges.org/>). Thus, from an engineering perspective, it would be beneficial to develop sound engineering strategies for BNR design and operation that minimize both *aqueous* and *gaseous* nitrogen emissions. Based on this study, the measured emissions from some BNR processes were at least one order of magnitude higher than estimates derived from U.S. EPA emission factors (U.S. EPA, 2009). However, given that the emissions from other processes were clearly lower than current emission factor estimates (Table 4-1), the prospect of engineering-based minimization of N<sub>2</sub>O emissions from WWTPs appears to be feasible.

Based on regression modeling results, BNR processes that avoid high NH<sub>4</sub><sup>+</sup>-N, NO<sub>2</sub><sup>-</sup>-N and DO concentrations and transients thereof are expected to generate less N<sub>2</sub>O, from both nitrification and denitrification. High NH<sub>4</sub><sup>+</sup>-N, DO and NO<sub>2</sub><sup>-</sup>-N concentrations are typically encountered in under-designed and over-aerated nitrification reactors (Grady et al., 1999). Therefore, aerobic processes that avoid incomplete or intermittent nitrification and over-aeration are expected to have lower N<sub>2</sub>O emissions. Additionally, processes that rely on more uniform spatial DO profiles to promote simultaneous nitrification and denitrification such as the oxidation ditch, are likely to have low N<sub>2</sub>O emissions. Such processes avoid repeated switching between aerobic and anoxic conditions, which in conjunction with high NH<sub>4</sub><sup>+</sup>-N and DO concentrations are a prime cause for nitrification driven N<sub>2</sub>O emissions (Yu et al., 2010). An additional strategy to minimize N<sub>2</sub>O emissions could be to minimize the peaking factor of influent nitrogen loading to activated sludge via flow equalization (Ahn et al., 2009). While flow equalization of primary effluent may be difficult because of the high flow rates, it might be possible in select WWTPs to blend high nitrogen containing centrate with primary effluent to equalize influent nitrogen loads.

These observations lead directly to future research that will be conducted during the next phase of this study.

## 7.7 Ongoing Studies and Future Perspectives

The next phase of this study will build upon the results obtained. Specifically, two directions have been selected for more detailed study. The first direction involves the implementation of process engineering measures to minimize N<sub>2</sub>O emissions during BNR operation. Substantial insights have been gained during the course of the full-scale monitoring studies (Ahn et al., 2010), discussed in Chapter 4.0 and lab-scale studies (Yu et al., 2010; Lu and Chandran, 2010), discussed in Chapters 5.0 and 6.0 relating to factors that promote N<sub>2</sub>O emissions in BNR processes. Using this information, the operation of a full-scale BNR process will be controlled to simultaneously minimize effluent total nitrogen concentrations and N<sub>2</sub>O emissions fluxes. The study will be conducted in two parts, beginning with quantifying TN removal performance and N<sub>2</sub>O emissions using the full-scale protocol developed for this study. Based on the data obtained, inferences will be made on factors contributing to N<sub>2</sub>O emissions. Subsequently, process operation will be modified to achieve a balance between *liquid-phase* and *gaseous phase* nitrogen releases.

The second direction is to study emissions at a BNR or non-BNR facility that

employs biofilm processes. Based on the full-scale monitoring results (Ahn et al., 2010), discussed in Chapter 4.0, the concerted action of both nitrification and denitrification can result in minimization of N<sub>2</sub>O emissions during nitrogen cycling. Biofilm processes represent a prime example of nitrification and denitrification occurring in close spatial correspondence (rather than spatially distinct aerobic and anoxic zones, respectively). Therefore, the focus of this part of the study will be to examine the N-removal performance and N<sub>2</sub>O generation potential of select biofilm-based systems and correlate once-again *liquid-phase* and *gaseous phase* nitrogen concentrations and contributors thereof.

APPENDIX A

FIELD PROTOCOL WITH  
QUALITY ASSURANCE PLAN

## 1.0 PROJECT DESCRIPTION AND OBJECTIVES

### 1.1 Problem Definition/Background

The push to achieve greater nitrogen removal from wastewater treatment plants, while minimizing infrastructure investments and operating costs, has resulted in the development of a wide range of innovative biological nitrogen removal (BNR) processes. However, BNR strategies could be a significant contributor to atmospheric N<sub>2</sub>O and NO depending upon the reactor configurations and operating conditions. In the future, as BNR is implemented at wastewater treatment plants around the nation, the flux of these gases to the atmosphere could significantly increase. Such increased releases would be a major concern since the greenhouse impact of nitrous oxide is about three hundred times that of carbon dioxide. Furthermore, nitric oxide is converted to nitrogen dioxide in the atmosphere, which is a precursor to photochemical smog (ozone).

### 1.2 Project Description

The goal of this WERF project is to characterize nitrogenous emissions from the activated sludge portion (only) of wastewater treatment plants. This project represents one of the first attempts at characterizing nitrogenous GHG emissions from wastewater treatment plants, and developing a methodology for collection of full scale plant data from a range of nutrient removal facilities in the United States. Building on previous work by the project team, this information will be integrated into an activated sludge model 1 (ASM 1) based mechanistic process model, which will be refined through this project through the addition of autotrophic pathways for N<sub>2</sub>O and NO emission. The refined mechanistic model will allow the industry to codify the results of this research, and develop a tool that will aid in the prediction and therefore mitigation of N<sub>2</sub>O, NO and NO<sub>2</sub> emissions from WWTPs utilizing a range of wastewater treatment processes. Ultimately, this could allow the wastewater sector to engineer strategies for wastewater treatment that minimize gaseous nitrogen oxide emissions.

### 1.3 Project Objectives

According to the guidance on Quality Assurance project planning provided by USEPA National Risk Management Research Laboratory (NRMRL), projects can be divided into four categories:

- ◆ Category 1 is a study intended to generate data for enforcement activities,
- ◆ Category 2 is a study to generate data in support of the development of environmental regulations.
- ◆ Category 3 is a applied research project to demonstrate the performance of accepted processes under defined conditions.
- ◆ Category 4 is a study to generate data to evaluate unproven theories or to develop potential processes.

This research project is a Category 3 study. The objectives of this project will be to:

1. Identify principal aqueous and gaseous intermediates in activated sludge tanks under different configurations, nitrogen loads, and operating conditions (i.e. extant dissolved oxygen concentrations)

2. Determine the relative mechanisms and contributions of oxidative and reductive pathways in gaseous nitrogen oxide production by activated sludge bacteria
3. Develop a tool based on ASM algorithms augmented to allow the results of this research to be codified and available for use. The tool will facilitate optimization of nutrient removal processes to minimize both aqueous and gaseous nitrogen GHG emissions.

These project objectives will be accomplished in part by direct data collection during three inter-related components: bench-scale reactors experiments conducted entirely by Columbia University under the direction of Dr. Kartik Chandran, Principal Investigator; characterization of nitrogen greenhouse gas emissions from full scale wastewater treatment operations (nitrification/ denitrification process tanks) also under the direction of Dr. Chandran; and collection of conventional wastewater parameters in conjunction with the full-scale gas emissions monitoring by participating wastewater treatment facilities under collaboration with Dr. Chandran. All of the participating wastewater treatment facilities have laboratory capabilities that are in compliance with their respective plant permits.

## 2.0 PROJECT ORGANIZATION

### 2.1 QA Management

WERF is a leader in research for the Clean Water sector (wastewater and stormwater utilities regulated under the Clean Water Act). WERF research also includes our volunteer advisory committees (Project Steering Committee), a group of highly-qualified subscriber practitioners, academics, and technology leaders, who provide oversight and technical direction to each research program to complement the WERF Program Director and the research teams. WERF actively abides by the applicable regulations established by U.S. EPA at 40 CFR Parts 30 and 31, as well as all applicable reporting, auditing, and financial management requirements. WERF will utilize its existing organizational management structure, systems, and processes already in place to support timely implementation of quality assurance (QA). WERF has instituted a quality management system in conformance with ANSI/E4 standards, and has adopted a highly-effective Quality Management Plan, which is reviewed and updated regularly.

### 2.2 Documentation and Records

A printed copy (MS Word<sup>®</sup>) of the most recently updated version of the QAPP will be present in the offices of the principal investigator, the Program Director and QA Project Officer. A printed master copy of the current QAPP will be maintained in a dedicated binder in the Environmental Biotechnology Laboratory, Columbia University (Mudd Building, Room 1041) for ready reference to laboratory personnel. In addition, the binder will contain hard copies of routinely generated calibration curves, audit reports, detailed standard operating procedures for each analytical method or instrument used in the project and copies of chain of custody forms.

A printed copy (MS Word<sup>®</sup>) of the most recently updated version of the QAPP will also be provided to the contact person identified at each participating and TCR facility. Detailed records of sampling and analytical procedures and the measured results will be maintained in the laboratory notebooks of the respective laboratory personnel. Laboratory notebooks at Columbia University will be maintained per Kanare, 1985 (2). Difficulties encountered during sampling and analysis will be documented in the laboratory notebooks. Documented sampling and analysis problems will be discussed and resolved during weekly meetings held at Columbia University under the supervision of Dr. Chandran and during monthly PSC conference calls.

Problems during sampling and analysis may also be resolved by contacting the Project QA Officer, if necessary. Additionally, the manufacturer of the monitoring and laboratory equipment being used may be contacted directly.

### 2.3 Responsibilities of Project Participants

The organization of responsibilities to ensure efficient functioning of various tasks associated with the project is per Figure P1. Dr. Kartik Chandran will serve as Principal Investigator and overall Project Manager. The research team will consist of Prof. Krishna Pagilla from the Illinois Institute of Technology, Dr. Dimitri Katehis from CH2M Hill, Dr. Sungpyo Kim, Research Scientist, Columbia University and Joon Ho Ahn, Doctoral Candidate Columbia University.

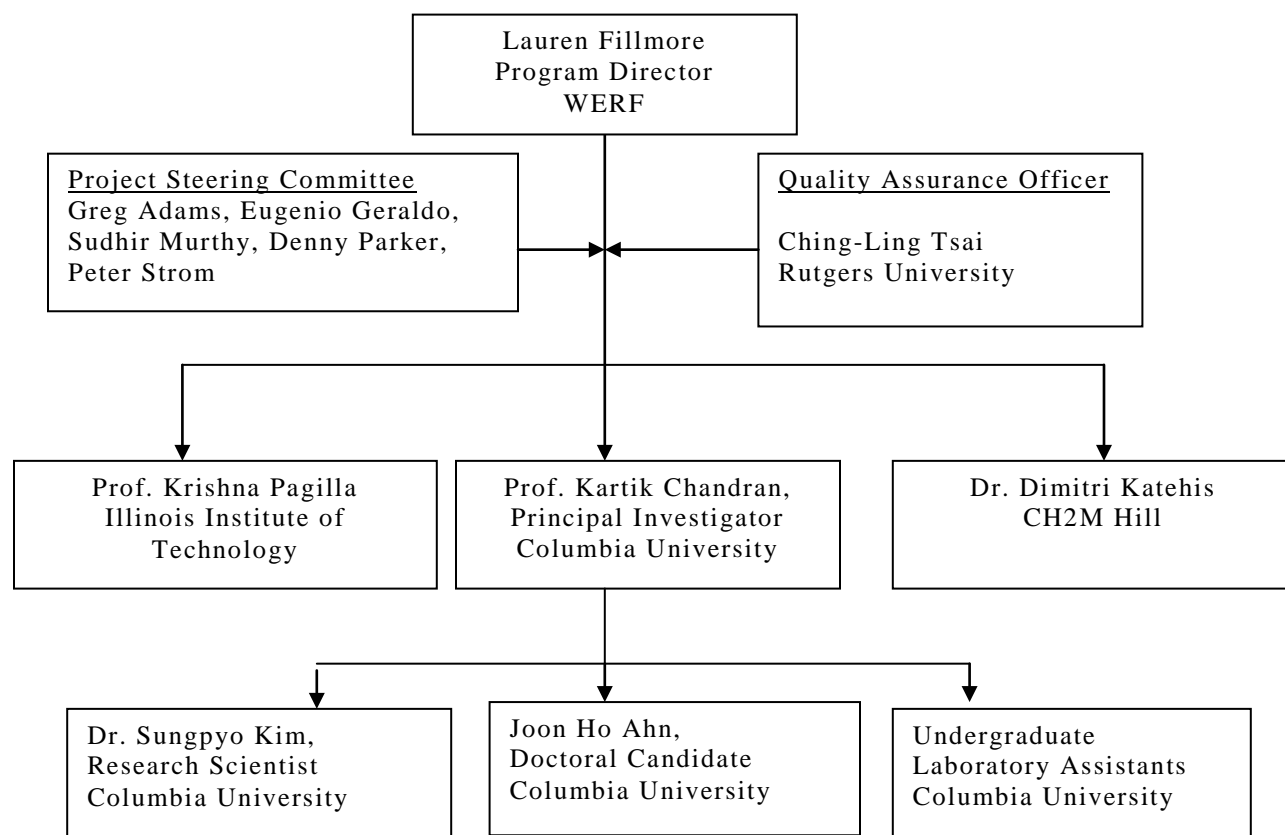

Figure A-1. Project Organization Chart.

### 2.4 Research Team Special Training Requirements/Certification

All laboratory personnel in the Columbia University Biomolecular Environmental Sciences (CUBES) Laboratories have undergone prior training on using different analytical instruments or methods. Additional training will be provided during new personnel initiation by respective equipment custodians.

All field and laboratory personnel from Columbia University will undergo a mandatory Chemical and Biological Safety Training Course before routine monitoring commences and at least once every year, thereafter.

Each analytical instrument in the Environmental Biotechnology Laboratory at the Columbia University has a designated Custodian. The equipment custodians are expected to be fully cognizant of the standard operating procedures of their respective equipment. In addition,



the custodians are responsible for training new users in the proper operation of the instrument. Operator competence will be checked (after operator training) by evaluating single operator precision on five replicate analyses of an independently prepared check sample. The concentration of the check sample will be from 5 to 50 times the method detection limit for a given analysis (3)

## 3.0 EXPERIMENTAL APPROACH

### 3.1 Sampling Design for Bench-scale Reactors

To complement full-scale monitoring, lab-scale reactors will be run in different BNR configurations (full-nitrification, partial nitrification, denitrification with different carbon sources) and gaseous N emissions from these reactors will be quantified. In addition, reactor performance, biokinetics, microbial abundance and gene expression will be examined via chemical specific analysis, extant respirometry, light microscopy, and real-time RT-PCR, respectively. Such detailed analysis will allow us to determine the extent to which reactor operating conditions (DO, COD:N, L/W) impact release of gaseous nitrogen oxides via nitrification and denitrification. The Kartik Chandran Laboratories have optimized and applied nearly all molecular methods protocols required for this study for successful quantification of select bacteria in mixed microbial communities. Performance of the bench-scale nitrifying reactors operated at Columbia University will be monitored by sampling reactor mixed-liquor and effluent twice every week (Monday and Thursday) and measuring the concentration of analytes listed in Table A-1. Headspace gas analysis will be conducted once a week (Thursday). Initially, all samples will be analyzed within 24 h (preservation by storage at 4°C (3)).

However, periods of more frequent sampling (e.g., during a toxic shock load) may necessitate storage of samples for a longer period of time and analysis of larger batches of samples. In such case, samples will be stored for a maximum of 28 d at 4°C and pH < 2 (2 ml/L conc. sulfuric acid) or at -20°C without acid addition (3) (See Table A-1) pending subsequent analysis. Representativeness of collected samples will be ensured by sampling at specified times and locations (i.e aerated zone, clarifiers, influent/effluent of reactors). Sample containers will be labeled with indelible ink identifying the date and time of sampling, sampling personnel, sample volume collected and analytes to be measured. Initially, all samples will be collected in 100% volumetric excess to permit quality control analysis or re-analysis for satisfying DQOs (See Table A-6). Sample containers will be washed and decontaminated as per standard protocols (3). Disposal of decontamination by-products that are classified as hazardous will be performed by the Department of Environmental Health and Safety, Columbia University or by wastewater treatment facility staff.

#### 3.1.1 Sample Handling and Custody Requirements

Sampling handling and custody will be recorded in detail as per Figure P3 for analyses conducted in Environmental Biotechnology Laboratories at Columbia University. The chain of custody form will be filled out for each sampling and analysis exercise by the respective personnel performing sampling and analysis. Completed chain of custody forms will be stored in a dedicated Log Binder (See Section 9.3).

#### 3.1.2 Measurements Performed during Bench-scale Testing

Measurements of typical wastewater parameters and state variables will be performed per methods approved by the U.S. EPA as provided in Table A-1.

Table A-1. Methods for Measurement and Analysis.

Name of Chemical or Method	Method	Method Detection Limit (per US EPA 40 CFR 136, App. B)	Standard Method (3)
pH		Not applicable	4500 H <sup>+</sup>
Chemical Oxygen Demand : Colorimetric	EPA 0410.4 <sup>=</sup>	12 mg COD /L	5220C
NH <sub>3</sub> -N Potentiometric : (ISE),	EPA 0350.3 <sup>=</sup>	0.15 mg-N/L	4500-NH <sub>3</sub> B 4500-NH <sub>3</sub> D
NO <sub>2</sub> <sup>-</sup> -N : Spectrophotometric,	EPA 0354.1 <sup>=</sup>	0.002 mg-N/L	4500-NO <sub>2</sub> <sup>-</sup> B
NO <sub>3</sub> <sup>-</sup> -N : Potentiometric : (ISE),	Standard Method	0.2 mg-N /L	4500-NO <sub>3</sub> <sup>-</sup> D
Dissolved Oxygen (DO) : Membrane Electrode (Probe)	EPA 0360.1 <sup>=</sup>	Not applicable	4500-O G
NO <sub>x</sub>	Chemiluminescence	NA	
N <sub>2</sub> O	Infra-red	NA	
Automated data acquisition of DO measurements	Analog output	0.009* mg /L	

Note : All above analyses performed at the Environmental Biotechnology Laboratory, Columbia University

<sup>=</sup> : (4).

\* : based on least count of the instrument used for measurement

**Sample source:** Bench-scale Nitrification-Denitrification Reactors

**Location:** Columbia University, New York, NY

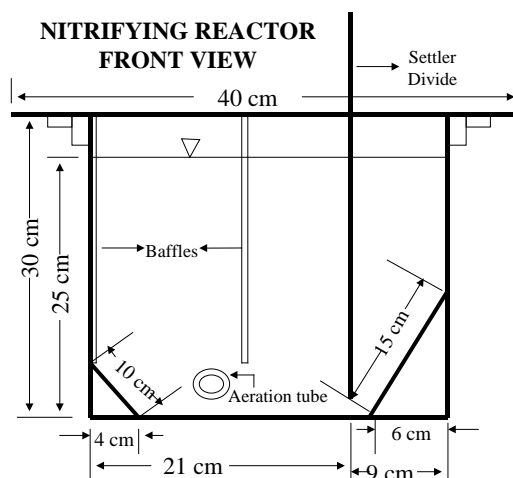

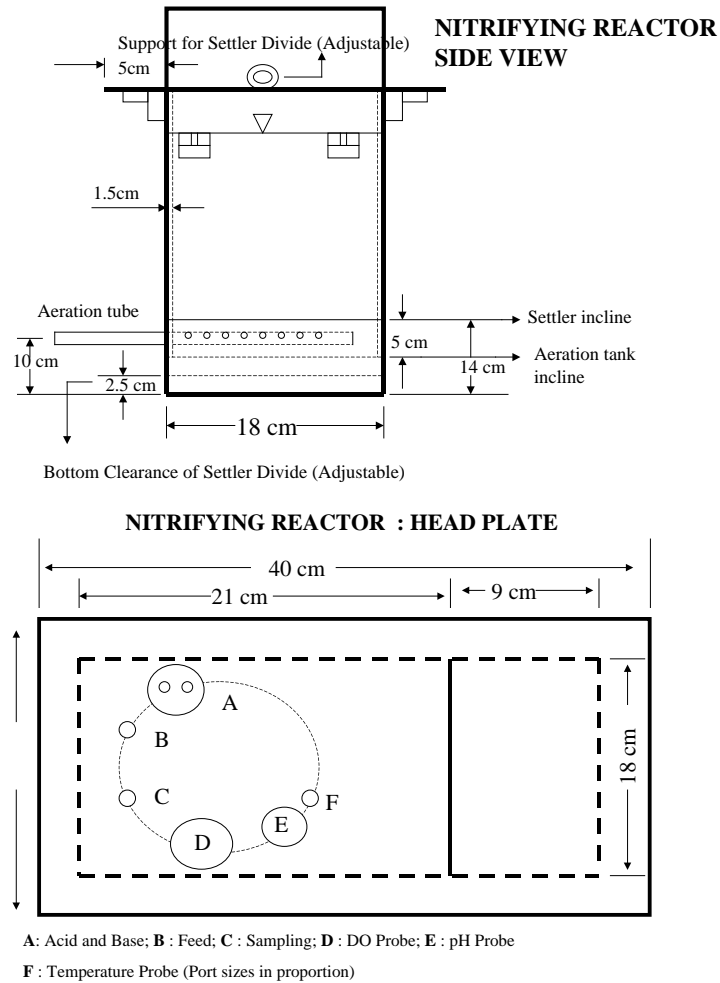

Figure A-2. Design Specifications of Benchscale Nitrifying Reactor.



## 4.0 SAMPLING PROCEDURES – NITROGEN GHG EMISSIONS

**Sample source:** Treatment train from full scale wastewater treatment facilities

**Location:** Several BNR and non BNR plants around the country as outlined in the list in the list of participating facilities (Page 2)

### 4.1 Sampling Design

The overall procedure for measuring N<sub>2</sub>O, NO and NO<sub>2</sub> fluxes from the head-space of activated sludge tanks involves a variant of the EPA/600/8-86/008 and the South Coast Air Quality Management District (SCAQMD) tracer methods. This variant has been developed to measure those sources that have a relatively high surface flux rate when compared to diffusion which facilitates increased sampling at of composting and wastewater treatment plants across the country. A detailed description of the procedure is provided in Appendix A - Protocol.

Commercially available replicas of the US EPA surface emission isolation flux chamber (SEIFC) will be used to measure gaseous N fluxes from activated sludge reactors. The SEIFC consists of a floating enclosed space from which exhaust gas is collected in a real-time or discrete fashion. Since the surface area under the SEIFC can be measured, the specific flux of the gaseous compound of interest can be indirectly determined. The SEIFC ‘floats’ on the activated sludge tank surface and several replicate measurements can be taken at different locations in a single tank as well as from different tanks (nitrification, denitrification) along a treatment train.

The SEIFC is also equipped with mixing (physical mixer or via sweep gas circulation) to ensure adequate gas and in some cases, an online temperature probe. The SEIFC is currently one of the few devices accepted by the USEPA for measuring gaseous fluxes (*I*) and as such will be employed for this study. Gas-phase analyses will be conducted via infra-red (N<sub>2</sub>O) and chemiluminescence (NO<sub>x</sub>) methods. Detailed description of the analyzer equipment is provided in Appendix A- protocol.

In general, sampling will be conducted at multiple locations of the activated sludge train in each wastewater treatment facility. These locations the aerobic, anoxic and anaerobic zones, depending upon the configuration of the given facility.

Full-scale measurement of gas fluxes will be conducted at different locations along the activated sludge train at each full-scale wastewater treatment facility. Based on a fundamental understanding of the biological pathways that contribute to N<sub>2</sub>O fluxes from activated sludge, the transition between the aerobic and anoxic zones is expected to be point contributing most to these fluxes.

Nevertheless, at each plant, N<sub>2</sub>O, NO and NO<sub>2</sub> emissions will be monitored from anoxic and aerobic zones. Typically, we anticipate sampling at one point in each anoxic zone and each aerobic zone with active nitrification along the treatment train.

During the course of the gas phase sampling, liquid phase samples will be collected adjacent to the hood location. The samples will be filtered immediately upon collection in the field and analyzed by host plant personnel for ammonia, nitrite and nitrate concentration,

utilizing readily available field methods (i.e. a Hach Kit). As the primary purpose of these measurements is to ensure the presence of the targeted nitrogen species, without consideration to accuracy in the concentration measurements, the simplest available field method will be used for these preliminary measurements. Profiles of the nitrogen species along the aeration tank will be collected using the plants standard sampling and analysis procedures as outlined in Section 6.

## 4.2 Sampling Methods for Nitrogen GHG Emissions

### 4.2.1 Gas Phase Sampling Method in Aerobic Zones

- ◆ Seal all but one vent in the flux chamber and connect high sensitivity pressure gauge to the one open vent.
- ◆ Lower flux chamber into aerobic zone (bottom of rim should be below the surface of the water by 1-2 inches minimum).
- ◆ Wait for N<sub>2</sub>O analyzer to equilibrate based on stability indicator (<0.03)
- ◆ Pull the flux chamber up. Open two vents and connect the N<sub>2</sub>O analyzer, NO<sub>x</sub> analyzer. The other vents should be left open to atmosphere.
- ◆ Record temperature of the gas in the flux chamber using a digital temperature gauge (Fisher Scientific number 15-077-8 or suitable alternate)
- ◆ Care must be taken not to have the flow going to the two analyzers exceed the gas-flow rate from the flux-chamber. Otherwise, atmospheric air will be drawn in through the vents in the flux chamber.

### 4.2.2 Determination of Gas Flow Rate from the Flux Chamber in Aerobic Zones

- ◆ Disconnect N<sub>2</sub>O and NO<sub>x</sub> analyzers and connect one outlet vent to the inlet line of a field gas chromatograph equipped with a thermal conductivity detector. Close the other vent.
- ◆ Introduce tracer gas (10% He, 90% zero air) through an inlet vent into the flux chamber at a known flow rate (for instance 1L/min).
- ◆ Measure the concentration of He gas exiting the flux chamber (protocol in appendix A).
- ◆ Based on the measured He concentrations, calculate via linear algebra the flow rate of aeration tank headspace gas entering the flux chamber (equation 1 provided in Appendix).

### 4.2.3 Gas Phase Sampling Method in Anoxic Zones

- ◆ Seal all but one vent in the flux chamber and connect high sensitivity pressure gauge to the one open vent.
- ◆ Lower flux chamber into anoxic zone with a (1-2 inch minimum submergence, into the liquid surface)
- ◆ Wait for N<sub>2</sub>O analyzer to equilibrate based on stability indicator (<0.03)
- ◆ Pull the flux chamber up. Open two vents and connect the N<sub>2</sub>O analyzer, NO<sub>x</sub> analyzer and the **sweep gas pump (Note: sweep gas only used during anoxic zone sampling)**. The other vents should be left open to atmosphere.
- ◆ Record temperature of the gas in the flux chamber using a digital temperature gauge (Fisher Scientific number 15-077-8 or suitable alternate).
- ◆ Care must be taken never to have the flow going to the two analyzers exceed the sweep gas rate or dilution air will be drawn in through an opening in the chamber.

#### 4.2.4 Determination of gas flow rate from the flux chamber in Anoxic Zones

- ◆ Disconnect N<sub>2</sub>O and NO<sub>x</sub> analyzers and connect one outlet vent to the inlet line of a field gas chromatograph equipped with a thermal conductivity detector. Close the other vent.
- ◆ Introduce sweep gas to the chamber at a flow rate of 4L/min and wait 6 min for steady-state.
- ◆ Introduce tracer gas (10% He, 90% zero air) through an inlet vent into the flux chamber at a known flow rate (for instance 1L/min).
- ◆ Measure the concentration of He gas exiting the flux chamber (protocol in appendix A).
- ◆ Based on the measured He concentrations, calculate via linear algebra the flow rate of aeration tank headspace gas entering the flux chamber (equation 2 provided in Appendix).

Table A-2 summarizes the data recording requirement checklist that needs to be followed for flux-chamber set up and operation. Additional analytes can be added by sampling teams based on a case specific basis.

Table A-2. Checklist for Flux Chamber Set-up and Operation in Field.

Measurement	Sampling Location 1	Sampling Location 2	Sampling Location 3
Gas flow rate from flux chamber			
Gas temperature in flux chamber			
Wastewater temperature			

#### 4.3 Continuous and Real-Time N<sub>2</sub>O Measurement

1. Turn on the power by pressing the on/off switch on the front panel. The display should turn on and green (sample) status LED should be energized. The green LED should blink indicating the instrument has entered the HOLD-OFF mode. Sample mode can be entered immediately by pressing the EXIT button on the front panel. The red "fault" light will also be on until the flows, temperatures and voltages are within operating limits. Clear the fault messages. After the warm-up, review the TEST function values in the front panel display by pushing the left most keyboard button labeled TEST.
2. Activate the instrument DAS data acquisition and set the sampling frequency for 1 sample per minute
3. Start data acquisition.
4. Connect the inlet tubing of the analyzer to the outlet tubing from the SEIFC securely using a standard 1/4" compression fitting connector.
5. Acquire data for about 20 min in anoxic zones and about 10 min in aerobic zones **after** stable readings are obtained- as indicated by the stability indicator on the N<sub>2</sub>O analyzer.
6. Terminate the DAS software and immediately save the acquired data.
7. Repeat steps 2-5 for each sampling point and sampling locations (individual tanks).

#### Measurement Range

0-1000 ppm



### Calibration

At the beginning and end of each sampling event, the instrument will be calibrated using “zero gas” and N<sub>2</sub>O standard gas as per manufacturer’s instructions.

#### 4.4 Continuous and Real-time NO and NO<sub>2</sub> Measurement

1. Turn on the power by pressing the Power switch on the front panel and the external vacuum pump and wait till the display reads “MEAS” (this should typically take less than thirty minutes).
2. Activate the instrument data acquisition software and set the sampling and data save frequency for 1 sample per minute and 10 minutes, respectively. Start data acquisition.
3. Connect the inlet tubing of the analyzer to the outlet tubing from the SEIFC securely using a standard 1/4” compression fitting connector.
4. Acquire data for about 20 min in anoxic zones and about 10 min in aerobic zones **after** stable readings are obtained- as indicated by the stability indicator on the N<sub>2</sub>O analyzer.
5. Terminate the CLD software and immediately save the acquired data.
6. Repeat steps 2-5 for each sampling point and sampling locations (individual tanks).

### Measurement Range

Adjustable, 0-100 ppm

### Calibration

At the beginning and at the end of each sampling day, the instrument will be calibrated using “zero gas” and NO standard gas as per manufacturer’s instructions.

#### 4.5 Measurement of Liquid-Phase N<sub>2</sub>O Concentrations

In addition to measuring gaseous phase N<sub>2</sub>O concentrations in the headspace of aerobic and anoxic zones, the liquid-phase N<sub>2</sub>O concentrations will be measured to discriminate between N<sub>2</sub>O generation in the liquid phase and N<sub>2</sub>O emission in the gas phase. Liquid-phase N<sub>2</sub>O concentrations will be measured using a polarographic Clark type electrode (Unisense, Aarhus, Denmark). For additional details of the liquid phase measurements summarized in this section, please refer to the Appendix.

1. Withdraw about 20 ml sample from test reactors in 50 ml conical centrifuge tubes or alternate similar containers (plastic or glass beakers are acceptable).
2. Take out the microsensor from the calibration chamber (containing deionized water), rinse out with deionized water, and mop dry with a tissue.
3. Immerse the microsensor into the samples. **Proceed as rapidly as possible after acquiring the sample.**
4. Record the numbers from the display on the picoammeter. The measurement numbers should be stable within one minute.
5. Pull out the microsensor, rinse out and place it back into the calibration chamber.
6. Repeat steps (1) ~ (5) for each sampling point and location.

#### 4.6 Sample Collection Responsibilities

The measurement of nitrogen GHG emissions and collection of samples using the flux chamber will be done by Columbia University researchers and field technicians under the direct

supervision of Dr. Kartik Chandran. As the measurement of these parameters will be conducted by real-time analyzers or *in-situ* liquid probes, there is no need for sample handling and preservation. The real-time data from the analyzers or probes will be automatically downloaded on to a field computer or recorded in laboratory notebooks under the control of the Columbia University researchers. All electronic data will be backed up immediately upon return to New York to a duplicate location in the Environmental Biotechnology Laboratories at Columbia University. Additionally, where feasible electronic data will be stored on a temporary disk drive (in addition to the PC hard drive) during the field testing events.

## 5.0 SAMPLING PROCEDURES – WASTEWATER CHARACTERIZATION DATA

**Sample source:** Treatment train from full scale wastewater treatment facilities

**Location:** Several BNR and non BNR plants around the country

### 5.1 Sampling Design

Facilities that are selected to participate in an initial sampling effort will need to characterize influent flow, organics and nitrogen concentrations to the facility, in preparation for the detailed liquid and air measurement campaign. For the initial sampling the following parameters will be monitored from the secondary process:

- ◆ Influent Flowrates (minimum of once per hour)
- ◆ Influent and Effluent Ammonia (up to 8 times per day)
- ◆ Influent and Effluent Nitrite and Nitrate
- ◆ Influent and Effluent COD (assume once per hour, can be reduced depending on variability at site)

Additionally, diurnal performance and in-tank profiles will be gathered at the time of the N GHG phase sampling. To the degree feasible, all liquid phase analyses will be according to approved methods and protocols that are used to gather data for regulatory NPDES or SPDES permits at the participating facilities.

**Note:** To the extent possible, the sampling team will work with the laboratory personnel of the participating facilities to include data from online analyzers present at a given test site to avoid duplication of data gathering efforts.

### 5.2 Sampling Methods

Sampling will be conducted in accordance with the host WWTP's standard operating procedures, after review of said procedures by the project team. Sampling will involve use of autosamplers and manual sampling devices, as appropriate to support the sampling.

### 5.3 Sample Collection Responsibilities

The collection of conventional wastewater samples for analysis of parameters in Table A-3 will be conducted by facility personnel who usually collect operational and compliance samples for each participating facility. In advance of each sampling event, the Columbia University researchers will consult with laboratory personnel to ensure that samples for the conventional parameters are collected during the GHG monitoring event to meet the requirements of both the research design and the host facility's laboratory operating procedures.

### 5.4 Sample Handling and Custody Requirements

To the extent possible, the host utility's sample handling and custody requirements will be utilized for each field sampling campaign. To confirm adequacy of procedures, approximately two weeks prior to the full scale testing the

host utility's procedures for field sample handling and chain of custody will be reviewed with the project team. At that time, if modifications are deemed necessary by the project team, they will be defined and documented in the Site Specific Sampling Protocol.

## 6.0 TESTING AND MEASUREMENT PROTOCOLS

### 6.1 Analytical Methods Requirements for Wastewater Characterization Data

Table A-3 provides the sample location, the chemical parameter, sample container, preservative and holding time for samples to be collected during the operation of the bench scale reactors at the Columbia University Laboratory. For the full scale field testing, each host utility's laboratory will follow their specific laboratory standard operating procedures for each parameter. Standard Operating Procedures from participating laboratories will be included in the site specific protocol.

Table A-3. Sampling Specifications: Columbia University.

Name of Chemical or Method	Measurement Classification		Sample Location	Sample Volume* (ml)	Sample Preservation	Maximum Holding Time	
	Type	Frequency					Sample Equipment
<b><u>Bench Scale Nitrifying Reactors</u></b>							
pH (Bench scale reactor)	C	NA	Bench scale reactor	Reactor	NA	None, online	
	I, C	2/7 d	35 ml glass vial	Reactor, Effluent	8	4°C	1 d
Chemical Oxygen Demand – Colorimetric							
NH <sub>3</sub> -N Potentiometric (ISE)	I, C	2/7 d	200 ml glass bottle	Effluent	80	4°C <sup>ψ</sup>	1 d
NO <sub>2</sub> <sup>-</sup> -N Spectrophotometric	I, C	2/7 d	200 ml glass bottle	Effluent	40	4°C <sup>ψ</sup>	2 d
NO <sub>3</sub> <sup>-</sup> -N Potentiometric (ISE)	I, C	2/7 d	200 ml glass bottle	Effluent	40	H <sub>2</sub> SO <sub>4</sub> , pH < 2	28 d
Dissolved oxygen (Extant Respirometry)	C	4 Hz	100 ml respirometric vessel	Reactor	200	NA	NA
N <sub>2</sub> O	C	1/7 d	Gas sampling assembly**	Reactor headspace	NA	NA	NA
NO <sub>x</sub>	C	1/7 d	Gas sampling assembly**	Reactor headspace	NA	NA	NA
Dissolved oxygen (Bench scale Reactor)	C	NA	Bench scale reactor	Reactor	NA	NA	None, online

\*: The tabulated sample volume is twice that required for routine duplicate analysis and is apportioned into two sample containers. The additional volume is collected to determine quality control measures such as accuracy (analysis of spiked samples), precision (duplicate analysis) and to account for potential sample loss while handling or analysis. (Also see section 1.6)

C : continuous measurement I : intermittent measurement

Frequency of measurement applies only to continuous measurements

<sup>ψ</sup> : Storage at 4°C. However, the biomass is removed from the sample via centrifugation at 3500 g for 10 minutes. Biomass removal arrests further biochemical oxidation of NH<sub>4</sub><sup>+</sup>-N and NO<sub>2</sub><sup>-</sup>-N. NA : Not applicable \*\*: See protocol

## 6.2 Standardization of overall N-GHG Measurement Methodology

The overall procedure for measuring N<sub>2</sub>O, NO and NO<sub>2</sub> fluxes from the head-space of activated sludge tanks involves a variant of the EPA/600/8-86/008 and the SCAQMD tracer methods. Gas-phase analyses will be conducted via infra-red (N<sub>2</sub>O) and chemiluminescence (NO<sub>x</sub>) analyzers.

In the absence of an approved (USEPA or ASTM) method for N<sub>2</sub>O in air or water, method modification was necessary to meet project objectives and measure N<sub>2</sub>O emissions. To evaluate the performance of the measurement of N<sub>2</sub>O, NO and NO<sub>2</sub> fluxes using the procedure developed by the researchers, three side-by-side monitoring events were conducted along with the research procedure during the first sampling event at a step feed BNR facility. In addition to the research protocol performed by Columbia University staff, two additional side-by-side monitoring events were conducted as follows:

- ◆ Plant wastewater research engineers measured fluxes using the EPA isolation flux chamber and SCAQMD tracer method (confirm) but with a photo acoustic analyzer to directly determine N<sub>2</sub>O.
- ◆ Chuck Schmidt, Ph.D. used the textbook EPA isolation flux chamber and SCAQMD tracer dilution method to measure the flux and the following analytical methods to measure ozone precursors and GHGs.

Table A-4. Summary of Analytical Methodology by C. Schmidt.

Method/Species	Technique	Application
<b>ASTM Method 1946- Permanent Gas Analysis</b>	GC/TCD	Relevant Fixed Gases: CH <sub>4</sub> , CO, CO <sub>2</sub> , and Helium as a separate analysis
<b>NIOSH 6600</b>	FTIR	N <sub>2</sub> O, NO, NO <sub>2</sub>

These side-by-side tests using the NIOSH 6600 method were not designed to validate the modified analytical approach to establish an approved methodology; however, they provided an independent verification that the approach followed as part of this WERF project accurately measured N GHG emissions to meet the objectives of this research, for zones where concurrent side-by-side measurement was conducted.

Based on this side-by-side comparison, it was further recommended that the WERF project should consider the He tracer method (based on ASTM D1946) to measure gas flow rate from the flux chamber. This recommendation has since been incorporated in this protocol

## 7.0 QUALITY CONTROL REQUIREMENTS AND CORRECTIVE MEASURES

### 7.1 Quality Control (QC) of Laboratory Samples

**Unless explicitly stated, these are applicable solely for the bench-scale portion of the study. Since established QC procedures are already in place at field test facilities, they will supersede the QC procedures outlined in this QAPP.**

Approximately 20% of the samples will be designated as QC samples: Recovery of known additions: 5%; split samples: 5% (bench-scale testing only); samples for duplicate analysis: 10%. The acceptance criteria for different QC measures are listed in Table A-5. Note that known spikes are not feasible in the field for gas phase measurements due to transport limitation of hazardous gas cylinders.

Table A-5. Quality Control Indicators of Analytical Data.

Quality Control Indicator	Sample Type	Frequency	Parameter	Acceptance criterion (%)
Precision	Check standard	1 per 10	RPD	± 25
	Field Duplicate	1 per 10	RPD	± 25
	Lab Duplicate	1 per 10	RPD	± 25
Accuracy	Known spike	1 per 20	% recovery	75 – 125
Completeness	All	Annual	% missing	To be determined
Performance audit	Known sample	≥4/Year	RPD	± 10

RPD : Relative Percent Deviation (see Equation 4 below)

Data Quality Objectives (DQOs) will be expressed in terms of the following data quality indicators. The developed DQOs will be used to accept or reject data obtained during this study.

#### 7.1.1 Precision

Precision is a measure of the closeness with which multiple analyses of a given sample agree with each other. Precision will be expressed as relative percent difference (RPD) of duplicate measurements ( $X_1$  and  $X_2$ ).

$$RPD = \frac{(X_1 - X_2) * 100}{((X_1 + X_2) / 2)} \quad (4)$$

Instrument or method precision will be determined by duplicate analysis of stable standards. Overall precision of the study will be determined from duplicate samples subjected to identical sampling, sample preparation and analyses. Overall precision measures will reflect



random errors in sampling, and variations in sample preparation and analysis. The precision of both field and lab duplicates will be measured (5).

### 7.1.2 Accuracy

Accuracy reflects the degree of confidence in a measurement. The accuracy of measurement techniques and analytical instruments will be checked by examining the percent recovery of sample spikes of a known composition. The percent recovery is defined as :

$$\% \text{ recovery} = \left( \frac{C_s - C}{s} \right) \times 100 \quad (5)$$

where :

$C_s$  : spiked sample concentration

$C$  : sample background concentration

$s$  = concentration equivalent of analyte added to sample

Note : The total concentration after the sample spike should be within the linear calibration range of the method. Further, the volume change due to the spike should be negligible (3)

### 7.1.3 Representativeness

Representativeness is the extent to which measurements actually depict the true environmental condition or population being evaluated. For lab-scale reactors operated with constant influent loading, grab samples will be collected to ensure spatial (aerobic or anoxic zone, settling chamber) and temporal (consistent time and day of sampling during the week for a continuous flow reactor or consistent point along a sequencing batch reactor cycle) representativeness. This metric applies only to the lab-scale reactor element of the study.

### 7.1.4 Completeness

Completeness is a measure of the number of samples needed to provide useful information describing the system under investigation, compared to the total number of samples collected. Initially, for bench-scale reactors, all samples will be collected in 100% excess to permit quality control analysis or re-analysis owing to sample loss or data not complying with set DQOs. For instance, four samples will be collected, although only duplicate analysis will be performed routinely. Quality control analysis will be performed on 20% of the total samples routinely analyzed. Completeness will be expressed as the percentage of the total number of measurements that are judged valid according to data quality objectives standards.

### 7.1.5 Comparability

Comparability is the extent to which data from one study can be compared directly to past data. The influent dynamics of aqueous and gaseous nitrogen species from the lab-scale reactors will be compared to those from similar operating conditions based on past records maintained in the lab.

### 7.1.6 Recovery of Known Additions

The accuracy of an analysis will be assessed by measuring the recovery of a sample spiked with a known concentration of a given analyte. 10% of the total samples collected will be used for the recovery of known additions. The analyte spike concentration will be between 5 and

50 times the MDL or between 1 and 10 times of the ambient concentration, whichever is higher (3). Again, this analysis is restricted to liquid-phase samples.

### **7.1.7 Analysis of Externally Supplied Standards**

Externally supplied standards will be analyzed whenever analysis of known additions does not result in acceptable 25% recovery or once every day, whichever is more frequent (3). The concentrations of the standards will be between 5 and 50 times the MDL or near ambient sample levels (3). External standards will either be certified laboratory control standards or laboratory standards prepared independently from calibration standards (3).

### **7.1.8 Calibration with Standards**

The electrical response of all analytical instruments will be linearly correlated to at least three analyte concentrations before each analysis. Typically, laboratory measurements that are within the linear calibration range will be reported. If the entire calibration range is not covered during a certain measurement, concentrations above the highest standard will be reported only if the following conditions are satisfied (3):

Past evidence from earlier calibration curves obtained at identical instrument settings  
Measured value is less than 1.5 times the highest calibration standard.

On the lower end, the lowest reported value will be the MDL, provided that the lowest calibration standard is less than 10 times the MDL. If a method requires the response of blanks to be subtracted from the response of test samples, negative results will be reported as such or as below the limit of detection (3).

### **7.1.9 Analysis of Duplicates**

10% of the total samples or one per analytical batch (whichever is more frequent) will be analyzed in duplicate. Using duplicate measurements, the precision of analytical technique (lab duplicate) or precision for the entire project (field duplicate) will be evaluated.

## **7.2 Performance Audits**

### **7.2.1 Monitoring Lab Analysis (Bench-scale Testing)**

Performance audits to monitor lab performance will entail analysis of unknown samples obtained from a lab supply company (e.g., Fisher Scientific Co., NJ). Performance audit samples will be analyzed at Columbia University before analysis of actual samples. Prior analysis of performance audit samples will ensure that the laboratory is well equipped in terms of (a) instruments, (b) standard operating procedures and (c) competent personnel for the continuous monitoring operation. A list of the audit activities and results will be present in the office of the principal investigator. If analysis of performance audit samples is not satisfactory (measured average outside  $\pm 10\%$  of the actual audit sample value), errant data between two consecutive audits may be discarded and re-sampling or re-analysis may be warranted.

### **7.2.2 Monitoring Standard Operating Procedures**

One unscheduled performance audit will be performed by the QA project officer. The audits will be conducted using a checklist made to document the protocol followed by the sampling crew and analysts while sampling, sample handling and storage, analysis, reporting of

results (Table A-6). Any deviations from the standard operating procedures maintained will be recorded in the laboratory notebooks of sampling personnel and corrective action will be taken to minimize future discrepancies. Further, in such case, the results obtained via non-standard protocols will be reviewed. If necessary, the results will be discarded and the stored samples will be re-analyzed as appropriate and if available. If the modification in the standard operating procedure improves the existing method, changes will be incorporated in the standard

Table A-6. Sample Performance Audit for Sampling Nitrifying Bench-Scale Reactors.

Standard Procedure	Performed	Remarks
Sample point from well mixed region (below aeration tube)	Yes	Tube cleaned thoroughly before introducing into reactor
Sample labeled and particulars entered in logbook	Yes	Date and time of sample Sampling personnel Sample volume Analyte to measure : NH <sub>4</sub> <sup>+</sup> -N, NO <sub>3</sub> <sup>-</sup> -N, tCOD
Sample split evenly	No	Sample not well mixed during split
Sample acidified	Yes	Conc. H <sub>2</sub> SO <sub>4</sub> , (2ml/L)
Sample storage	Yes	4°C, 28d holding time

### 7.3 Corrective Measures

Unsatisfactory data (not meeting DQO specifications) could result from flaws in the instrument or poor analyst skills. In case of unsatisfactory data quality, corrective measures will include a thorough trouble-shooting of analytical instruments as recommended by the manufacturer and re-calibration of instruments using fresh reagents and standards. Further, the Standard Operating Procedure performance audits will also be checked to ensure competence of analysts and to conduct re-training, if necessary. In any case, deviant data will be discarded and re-sampling or re-analysis of stored samples will be performed.

### 7.4 Instrument Calibration, Maintenance and Quality Control Checks

Equipment used in continuous reactor operation such as pumps (Cole-Parmer, IL), DO controllers (Cole-Parmer, IL) or pH controllers (Cole-Parmer, IL) will be checked daily as part of routine reactor maintenance. In case of malfunction, the instrument will be disconnected from the reactor and re-calibrated, or replaced. The reactors will be temporarily shut down only if necessary. Currently, we have an extra set of reactor accessories in our laboratory for emergency repair measures.

The filling solution of the HNU ammonia gas sensing electrode will be changed once every three weeks, and the electrode membrane cap will be changed once every three months (HNU systems, MA). When not in use for short periods, the electrode will be stored in a 140

mg/l  $\text{NH}_4^+$ -N solution. The manufacturer of the  $\text{NO}_3^-$ -N ISE (Hach Co., CO) recommends that the electrode membrane tip should be changed whenever a low slope of the calibration is observed ( $< 55$  mV/decade). During continuous use, the electrode will be stored in a 100 mg  $\text{NO}_3^-$ -N/L solution without ionic strength adjustor (ISA) added.

For  $\text{NH}_4^+$ -N and  $\text{NO}_3^-$ -N measurement using potentiometric methods and  $\text{NH}_4^+$ -N measurement using the phenate method, a fresh calibration curve (at least three points, e.g., 10, 100, 1000 mg/l, encompassing the concentrations to be measured) will be constructed for every analytical batch. From past experience and current analysis, the variability in calibration curves for colorimetric COD and  $\text{NO}_2^-$ -N measurement is small and therefore these calibration curves will be updated once every month. The individual points of the calibration curve will be generated from duplicate measurements. Calibration standards will be purchased from commercial vendors (e.g., from HACH Co. for COD standards) or prepared according to Standard Methods (e.g., for  $\text{NH}_4^+$ -N,  $\text{NO}_2^-$ -N and  $\text{NO}_3^-$ -N) (3). All calibration curves will be stored on a personal computer to compare time-dependent variation in instrument characteristics or degradation of standards. After analysis of ten samples, a single-point calibration will be performed (preferably at the midpoint of the multi-point calibration. If the single-point continuing calibration deviates by more than 25% from that of the multi-point curve, the analytical run will be terminated. A new multi-point calibration will be performed and all samples analyzed after the last satisfactory single-point calibration curve will be re-analyzed. Weighing devices such as balances or scales will be checked with class S weights once every month.

For continuous reactor operation, the feed pumps will be calibrated manually once every week. The pH and DO meters used for continuous monitoring and control will be respectively calibrated by using standard pH solution or saturated DI water at reactor operating temperature ( $25^\circ\text{C}$ ) once every month. All pipettes will be calibrated according to manufacturers' instructions once every six months.

The  $\text{N}_2\text{O}$  and  $\text{NO}_x$  analyzers will be calibrated at least once every six months (as per manufacturers' instructions and past measure of their stability) and before and after each sampling campaign using zero gas and  $\text{N}_2\text{O}$  (500 ppm) and  $\text{NO}$  (10 ppm) gas standards.

## **7.5 Inspection/Acceptance Requirements for Supplies and Consumables**

All reagents used in reactor operation and chemical or biological assays will be of highest purity necessary (typically ACS grade). Appropriate tubing and hoses will be used for specific applications (e.g., nontoxic Pharmed<sup>®</sup> tubing will be used to supply feed solution to reactors, Masterflex<sup>®</sup> corrosion-resistant tubing will be used for intermittent acid or base addition to reactors for pH control). Reactor tubing will be routinely checked visually for microbial growth and cleaned using DI water, once every two weeks or more frequently, if necessary. Fresh tubing will be installed every two months. Newly purchased supplies (e.g., Sample containers) will be washed using standard methods (3) before use. Evaluation of possible measurement artifacts due to sampling or storage equipment will be part of QC analysis (Section 7.1).

## 8.0 DATA REPORTING, DATA REDUCTION, AND DATA VALIDATION

Periodic data generated during the course of this study will be compiled weekly by the individual personnel conducting the respective experiments and analyses. The compiled data will be presented during weekly progress meetings held under the supervision of Dr. Chandran at Columbia University and monthly PSC conference calls.

### 8.1 Data Verification

The process of data verification determines whether data has been collected in accordance with specifications outlined in the QAPP. The four criteria for data verification are compliance, correctness, consistency and completeness.

**Compliance:** Compliance of data acquired during this project will be evaluated in terms of adherence to SOPs and satisfying QC criteria outlined in this QAPP. Examples of data compliance evaluation tasks include:

<b>Data Compliance Evaluation Task</b>	<b>Performed by</b>
Staff Training and Certification	Project Manager
Sample Custodian Assignment	Project Manager
Field Data Collection Audit	Project QA Officer
Calibration of Instruments	Sampling Personnel
Confirming Verification of Calibration	Sampling Team Leader
Calibration Corrective Action Audit	Sampling Team Leader and Project QA Officer
Sample Preservation and Handling	Sampling Personnel

**Correctness:** Correctness of acquired data will be determined by checking if data analysis calculations were performed in accordance with properly documented and properly applied algorithms. Examples of data correctness evaluation tasks include:

<b>Data Correctness Evaluation Task</b>	<b>Performed by</b>
Instrument Inspection and Maintenance Audit	Sampling Team Leader
Instrument Calibration Review	Sampling Team Leader
Data Recording Audit	Project QA Officer
Data Reduction Audit	Project QA Officer
Data Transformation Audit	Project QA Officer
Raw Data Audit	Sampling Team Leader

**Consistency:** Consistency refers to the extent to which data collection and data reporting procedures were done in a reproducible manner. Consistency ensures that reported values of any given parameter or state variable are identical, when used at different times or locations in the Project. Examples of data consistency evaluation tasks include:

<b>Data Consistency Evaluation Task</b>	<b>Performed by</b>
Data Handling Audit	Project QA Officer
Data Transmittal Review	Project QA Officer

**Completeness:** Completeness is the extent to which all data necessary to perform validation analysis were actually collected. Completeness is based on DQOs outlined in the QAPP. Examples of data completeness evaluation tasks include:

<b>Data Completeness Evaluation Task</b>	<b>Performed by</b>
Documentation of Sampling Corrective Action	Sampling Team Leader, Sampling Personnel
Sample Records Documentation and Audit	Sampling Personnel
Sample Transport Documentation and Audit	Sampling Team Leader

Data Management audit	Project QA Officer
Chain of Custody Documentation	Sample Custodian
Sample Identification Audit	Project QA Officer
Instrument Inspection and Maintenance Documentation	Sampling Personnel
Traceability of Standards Review	Sampling Team Leader
Documentation of Calibration Corrective Action	Sampling Personnel

---

The results of data verification will be presented to the Project Manager by the Project QA Officer.

## 8.2 Data Validation for Bench-Scale Testing

Data validation is an evaluation of the technical usability of the verified data with respect to the planned objectives of the project. Data validation is performed following data verification. Data validation consists of the following:

1. Determine and ensure that data provide necessary information to make decisions or address project objectives
2. Assign qualifiers to individual data values. The assigned qualifiers indicate the degree to which the data can be used when drawing conclusions based on the entire data set. Examples of data qualification may include :
  - Analyte not detected above MDL
  - Concentration of analyte is approximate due to interference
  - Identification of analyte is uncertain due to interference
  - Concentration of analyte is confirmed
3. Assess applicability of certain performance criteria (e.g., DQOs) used to make decisions on measured data, based on data gathered during the course of the Project. For instance, information on the magnitude of analytical error for a certain method may result in re-evaluation of precision criteria.
4. Determine whether DQOs were satisfied and whether data can proceed to Quality Assessment (Data Quality Assessment consists of reviewing DOQs and sampling design, preliminary data review, selecting statistical tests, verifying assumptions and hypotheses and drawing conclusions).

Data validation will be conducted by the Project QA Officer. In addition, all data gathered will be reviewed by Project QA Officer every quarter. If the data quality indicators do not meet the criteria outlined in the QAPP, data may be discarded or flagged with data qualifiers. Bench-scale test re-sampling or re-analysis may be conducted. If failure to meet DQOs is due to equipment failure, then calibration and maintenance of analytical instruments will be made more

stringent. If failure to meet DQOs is due to inadequate expertise of sampling and analysis personnel, then they will be retrained in bench-scale testing methods.

### **8.3 Reconciliation with User Requirements**

The principal investigators and the QA Officer will make decisions to either reject or qualify data based on criteria outlined in the Data Quality Objectives. (Also, see Corrective measures). Modifications may be warranted at various levels based on obtained results. Potential problems with data quality and any modifications to initial DQOs will be transmitted to the WERF Program Director via routinely held project conference calls.

**Note on Data Verification and Validation:** Based on results of data verification and validation, sampling and analysis may be repeated before achieving data that can successfully proceed to data assessment. If exhaustive corrective measures do not improve data quality, such data may not be used. However, if the requirements set forth in the QAPP are followed, most acquired data may be consistent with Project requirements and data rejection may be minimal.



## 9.0 ASSESSMENT AND OVERSIGHT

### 9.1 Assessments

Weekly meetings will be conducted at Columbia University to oversee the progress of the study, involving Prof. Kartik Chandran, Dr. Sungpyo Kim and Mr. Joon Ho Ahn. Monthly meetings involving the Project Managers, teams and the PSC will be conducted via conference calls to ensure efficient coordination between the activities at the sites around the country.

### 9.2 Reports to Management

The results of continuous monitoring of the full-scale reactors will be compiled within sixty days after a sampling event. Bench-scale monitoring reports will be submitted once a year following a review during the routine meetings held between the project team and the PSC.

### 9.3 Documentation and Records – Columbia University

A printed copy (MS Word®) of the most recently updated version of the QAPP will be present in the offices of the principal investigators. A printed master copy of the current QAPP will be maintained in a dedicated Binder in the Environmental Biotechnology Laboratory, Columbia University (Mudd Building, Room 1041) for ready reference to laboratory personnel. In addition, the Binder will contain hard copies of routinely generated calibration curves, audit reports, detailed standard operating procedures for each analytical method or instrument used in the Project and copies of Chain of Custody forms. Detailed records of sampling and analytical procedures and the measured results will be maintained in the laboratory notebooks of the respective laboratory personnel. Laboratories notebooks will be maintained per Kanare, 1985 (2). Difficulties encountered during sampling and analysis will be documented in the laboratory notebooks. Documented sampling and analysis problems will be discussed and resolved during monthly PSC conference calls. Problems during sampling and analysis may also be resolved by contacting the Project Quality Officer, if necessary. Additionally, the manufacturer of the equipment being used may be contacted directly.

### 9.4 Documentation and Records – Participating and TCR WWTP Facilities

Each participating or TCR facility will receive a printed copy (MS Word®) of the most recently updated version of the QAPP which they will retain in the offices of the principal contact during the period of performance of this study.

Each laboratory conducting the analysis of wastewater samples for conventional parameters will follow their Standard Operating Procedures for records retention. Given the significant implications of the data generated from this study in the development of gaseous nitrogen emission factors from the wastewater treatment industry, the data sets will be stored for as long as feasible in both hardcopy and electronic format. Each participating WWTP facility will turn over the wastewater characterization data to the Columbia University research team, including QC results collected during each sampling event.

## 10.0 REFERENCES

1. P. Tata, J. Witherspoon, C. Lue-Hing, Eds., *VOC Emissions from Wastewater Treatment Plants* (Lewis Publishers, Boca Raton, FL, 2003).
2. H. M. Kanare, *Writing the Laboratory Notebook* (American Chemical Society, Washington, D.C, 1985).
3. A. D. Eaton, L. S. Clesceri, A. E. Greenberg, Eds., *Standard methods for the examination of water and wastewater* (APHA, AWWA and WEF, Washington DC, ed. 21, 2005).
4. P. Nelson, *Introduction to EPA Test Methods. EPA Region I* (U.S. EPA, Boston, MA., 1998).
5. D. A. Skoog, D. M. West, F. J. Holler, *Fundamentals of Analytical Chemistry* (Saunders, New York, ed. 7th, 1996).
6. M. Kienbusch. (United States Environmental Protection Agency, 1986).
7. H. Melcer, "Methods for Wastewater Characterization in Activated Sludge Modelling" (Water Environment Research Foundation, 1999).

## PROTOCOL FOR MEASURING THE SURFACE FLUX OF NITROUS OXIDE (N<sub>2</sub>O) AND NITRIC OXIDE (NO) FROM ACTIVATED SLUDGE TANKS

Prepared by: K. Chandran

Last edit: K. Chandran July 22<sup>nd</sup>, 2008

Filename: GaseousNProtocol.doc

### INTRODUCTION

The following protocol, which has been prepared as part of this project, is intended to provide utilities and field sampling teams with a detailed description of the data collection methodology and analysis requirements to enable calculation of gaseous nitrogen fluxes from different zones of activated sludge trains in a wastewater treatment facility.

### EQUIPMENT, MATERIALS, and SUPPLIES NEEDED

1. Surface emission isolation flux chamber (commercially available from vendors, for instance, [http://www.fivesenses.com/Prod\\_Emission.cfm](http://www.fivesenses.com/Prod_Emission.cfm) or custom built based on specifications from the United States Environmental Protection Agency (6).
2. Teledyne API N<sub>2</sub>O Monitor Model 320E (Teledyne API, San Diego, CA)
3. EcoPhysics NO<sub>x</sub> Analyzer Model CLD64 (EcoPhysics, Ann Arbor, MI)
4. Zero gas (containing zero ppm N<sub>2</sub>O and NO), and N<sub>2</sub>O and NO gas standards (Tech Air, White Plains, NY)
5. Dwyer series 475 Mark III digital manometers to measure flux chamber pressure from 0 to 1" (high sensitivity) and 0 to 100" (low sensitivity) of water column (Dwyer Instruments Inc., Michigan City, IN)
6. Rotameter to measure influent sweep gas flow rate, 0 - 30 L/min, (Fisher Scientific, Fairlawn, NJ)
7. Adjustable air pump, 0-10 L/min (Fisher Scientific, Fairlawn, NJ) to provide sweep gas flow into the flux chamber
8. Vacuum pump, 0-30 L/min (Fisher Scientific, Fairlawn, NJ) for active pumping of gas from the flux-chamber (never required based on sampling campaigns conducted to date)
9. 0.2 µm cartridge filters, set of 10 (Millipore, Ann Arbor, MI) to prevent fine particulates from entering the gas analyzers
10. Silica Gel column for capturing moisture (Fisher Scientific, Fairlawn, NJ)
11. Glass water trap consisting of a 100 ml glass bottle placed in ice within a Styrofoam<sup>®</sup> box
12. Teflon<sup>®</sup> tubing (approximately 0.5") and fittings
13. 100-300' extension cord and power strip
14. Laptop personal computer (with at least 512 MB RAM) with data acquisition programs for N<sub>2</sub>O and NO<sub>x</sub> analyzers pre-installed
15. Set of miscellaneous hand-tools including adjustable wrenches, different size screw drivers and adjustable pliers.

## EXPERIMENTAL PROCEDURE

The overall procedure for measuring  $\text{N}_2\text{O}$ ,  $\text{NO}$  and  $\text{NO}_2$  fluxes from the head-space of activated sludge tanks involves a variant of the EPA/600/8-86/008 and the SCAQMD tracer methods, which allow sampling of gaseous emissions from high surface flux rate operations.

Commercially available replicas of the United States Environmental Protection Agency surface emission isolation flux chamber (SEIFC) will be used to measure gaseous N fluxes from activated sludge reactors. The USEPA SEIFC essentially consists of a floating enclosed space through which, carrier gas (typically nitrogen or argon) is fed at a fixed flow rate and exhaust gas is collected in a real-time or discrete fashion. Since the surface area under the SEIFC can be calculated or measured, the specific flux of the

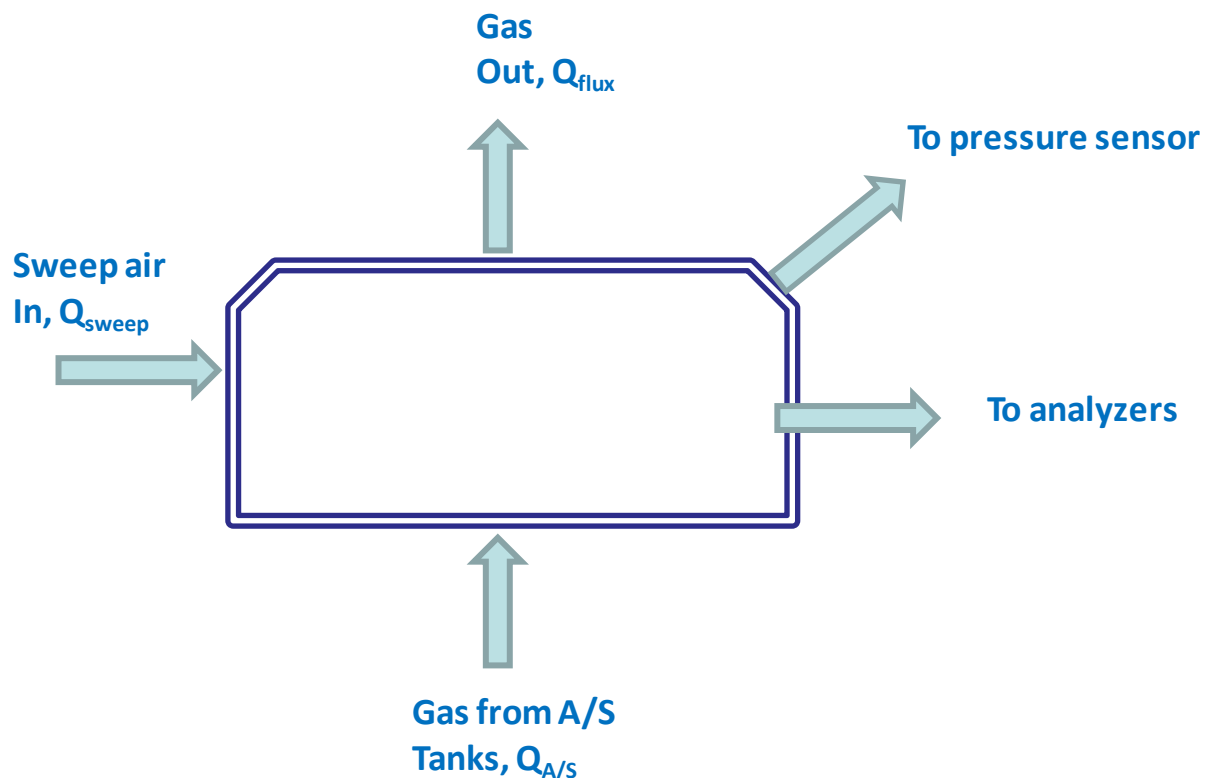

Figure A-4. Full-scale measurement of nitrogen gases will be done using the U.S. EPA surface emission isolation flux chamber (modified from (1)).

gaseous compound of interest can thus be determined. Since the SEIFC ‘floats’ on the activated sludge tank surface, several replicate measurements can be taken at different locations in a single tank as well as from different tanks (nitrification, denitrification) along a treatment train. The SEIFC is also equipped with mixing (physical mixer or via sweep gas circulation) to ensure adequate gas and in some cases, an online temperature probe. The SEIFC is currently one of the few devices accepted by the U.S. EPA for measuring gaseous fluxes (1) and as such will be employed for this study.

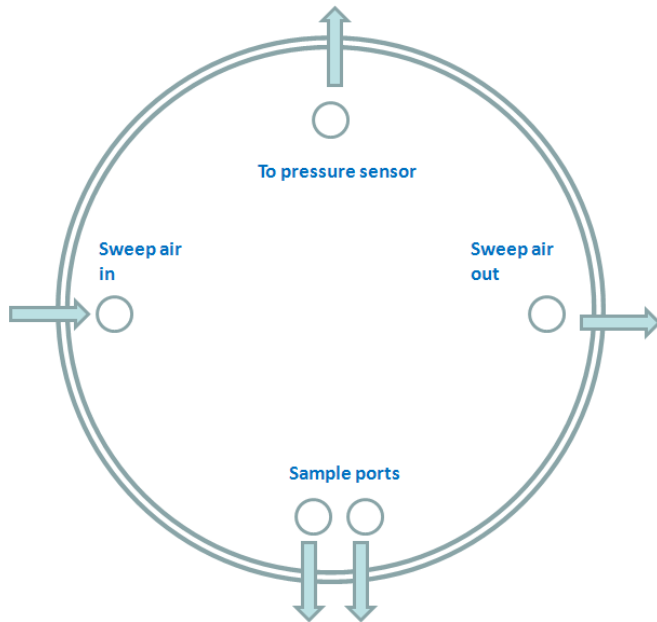

Figure A-5. Modified schematic of the flux chamber.

In general, sampling will be conducted at multiple locations of the activated sludge train in each wastewater treatment facility. These locations the aerobic, anoxic and anaerobic zones, depending upon the configuration of the given facility. Additionally, within each zone, multiple points (approximately three, but not less than two) will be sampled to address any variability in gas fluxes that may result due to variations in mixing or flow patterns therein.

Pressure build up can be minimized by equipping the flux chamber with multiple vents or a variable size vent and continuously monitoring the pressure drop across the hood using a

sensitive pressure gauge. In this study, the latter approach (pressure gauge) will be followed to monitor the pressure across the flux chamber. In all field locations, gas flow rate will be measured using the tracer gas technique and pressure will be passively monitored if necessary. Alternately, the aeration rate from plant records (available as a order of magnitude verification) have also been used to estimate VOC fluxes from aeration tanks and a similar approach could be used in this study (Dr. Chuck Schmidt, personal communication). The modified set up of the flux chamber used in this study is depicted in Figures A4 through A6.

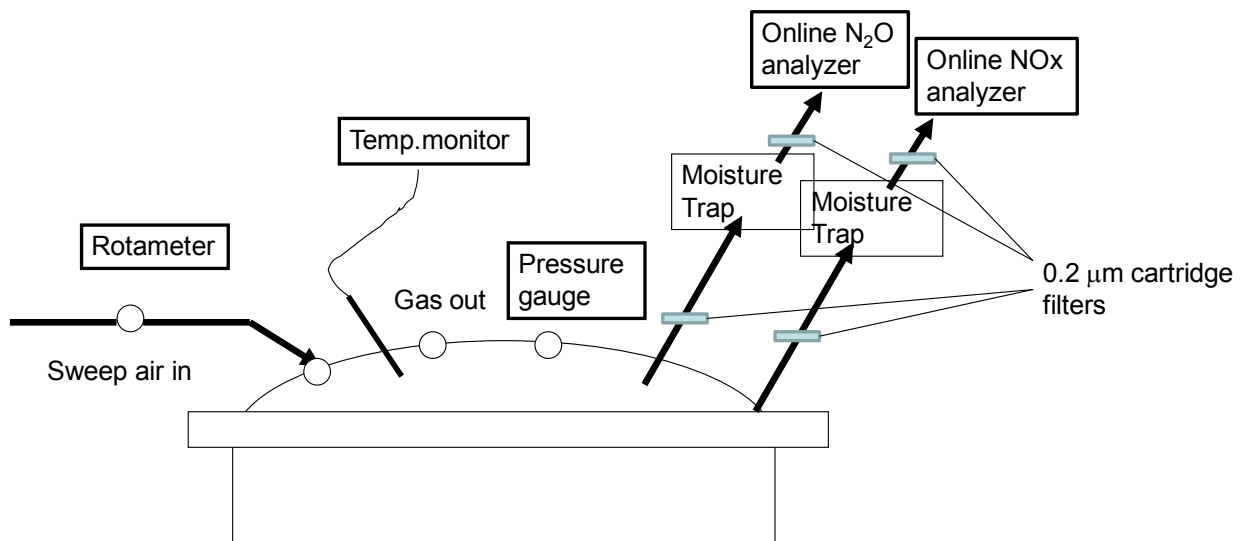

Figure A-6. Schematic of flux-chamber set-up for  $N_2$  and  $NO_x$  flux measurements.

### Gas Phase Sampling Method in Aerobic Zones

1. Seal all but one vent in the flux chamber and connect high sensitivity pressure gauge to the one open vent.
2. Lower flux chamber into aerobic zone (bottom of rim should be below the surface of the water by 1-2 inches minimum).
3. Wait for N<sub>2</sub>O analyzer to equilibrate based on stability indicator (<0.03)
4. Pull the flux chamber up. Open two vents and connect the N<sub>2</sub>O analyzer, NO<sub>x</sub> analyzer. The other vents should be left open to atmosphere.
5. Record temperature of the gas in the flux chamber using a digital temperature gauge (Fisher Scientific number 15-077-8 or suitable alternate)
6. Care must be taken not to have the flow going to the two analyzers exceed the gas-flow rate from the flux-chamber. Otherwise, atmospheric air will be drawn in through the vents in the flux chamber.

### Gas Phase Sampling Method in Anoxic Zones

1. Seal all but one vent in the flux chamber and connect high sensitivity pressure gauge to the one open vent.
2. Lower flux chamber into anoxic zone with a (1-2 inch minimum submergence, into the liquid surface)
3. Wait for N<sub>2</sub>O analyzer to equilibrate based on stability indicator (<0.03)
4. Pull the flux chamber up. Open two vents and connect the N<sub>2</sub>O analyzer, NO<sub>x</sub> analyzer and the **sweep gas pump (Note: sweep gas only used during anoxic zone sampling)**. The other vents should be left open to atmosphere.
5. Record temperature of the gas in the flux chamber using a digital temperature gauge (Fisher Scientific number 15-077-8 or suitable alternate).
6. Care must be taken never to have the flow going to the two analyzers exceed the sweep gas rate or dilution air will be drawn in through an opening in the chamber.

Figure A-7 summarizes the data recording requirement checklist that needs to be followed for flux-chamber set up and operation. Additional analytes can be added by sampling teams based on a case specific basis.

Measurement	Sampling Location 1	Sampling Location 2	Sampling Location 3
Pressure in flux chamber			
Gas flow rate from flux chamber			
Gas temperature in flux chamber			
Wastewater temperature			
Air-pump flow rates			

Figure A-7. Checklist for flux-chamber set-up and operation in field.

### Continuous and Real-Time N<sub>2</sub>O Measurement

#### Measurement

1. Turn on the power by pressing the on/off switch on the front panel. The display should turn on and green (sample) status LED should be energized. The green LED should blink indicating the instrument has entered the HOLD-OFF mode. Sample mode can be entered immediately by pressing the EXIT button on the front panel. The red "fault" light will also be on until the flows, temperatures and voltages are within operating limits. Clear the fault messages. After the warm-up, review the TEST function values in the front panel display by pushing the left most keyboard button labeled TEST.
2. Activate the DAS data acquisition software and set the sampling frequency for 1 sample per minute.
3. Start data acquisition.
4. Connect the inlet tubing of the analyzer to the outlet tubing from the SEIFC securely using a standard 1/4" compression fitting connector.
5. Acquire data for about 20 min in anoxic zones and about 10 min in aerobic zones **after** stable readings are obtained- as indicated by the stability indicator on the N<sub>2</sub>O analyzer.
6. Terminate the DAS software and immediately save the acquired data.
7. Repeat steps 2-5 for each sampling point and sampling locations (individual tanks).

#### Measurement Range

0-1000 ppm

#### Calibration

Before each sampling event, the instrument will be calibrated using "zero gas" and N<sub>2</sub>O standard gas as per manufacturer's instructions

### Continuous and Real-Time NO and NO<sub>2</sub> Measurement

1. Turn on the power by pressing the Power switch on the front panel and the external vacuum pump and wait till the display reads “MEAS” (this should typically take less than thirty minutes).
2. Activate the CLD data acquisition software and set the sampling and data save frequency for 1 sample per minute and 10 minutes, respectively. Start data acquisition.
3. Connect the inlet tubing of the analyzer to the outlet tubing from the SEIFC securely using a standard 1/4” compression fitting connector.
4. Acquire data for about 20 min in anoxic zones and about 10 min in aerobic zones **after** stable readings are obtained- as indicated by the stability indicator on the N<sub>2</sub>O analyzer.
5. Terminate the CLD software and immediately save the acquired data.
6. Repeat steps 2-5 for each sampling point and sampling locations (individual tanks).

### Measurement Range

Adjustable, 0-100 ppm

### Calibration

Before each sampling event, the instrument will be calibrated using “zero gas” and NO standard gas as per manufacturer’s instructions

### Principles of Real-Time N<sub>2</sub>O, NO and NO<sub>2</sub> Measurements

#### Principles of N<sub>2</sub>O Measurement

Continuous N<sub>2</sub>O measurements will be performed via infra-red (IR) gas-filter correlation, which is based on the absorption of IR radiation by N<sub>2</sub>O molecules at wavelengths near 4.5 μm. As part of the measurement process, a broad wavelength IR beam is generated inside the instrument and passed through a rotating Gas Filter Wheel, which causes the beam to alternately pass through a gas cell filled with Nitrogen, (Measure Cell) and a cell filled with N<sub>2</sub>O/N<sub>2</sub> Mixture (Reference Cell) at a frequency of 30cycles/sec. N<sub>2</sub>O concentrations are inferred based on the amount of IR absorption at wavelengths close of 4.5 μm. Ultimately, the ‘stripped’ beam strikes the detector which is a thermoelectrically cooled solid-state photo-conductor. This detector, along with its pre-amplifier converts the light signal into a modulated voltage signal.

#### Principles of NO and NO<sub>2</sub> Measurement

The chemiluminescence approach is based on the gas-phase reaction of NO with excess ozone (O<sub>3</sub>), which produces a characteristic near-infrared luminescence (broad-band radiation from 500 to 3,000 nm, with a maximum intensity at approximately 1,100 nm) with an intensity that is proportional to the concentration of NO. **It should be noted that this is the same reaction via which NO causes the depletion of the ozone layer.**

#### Reaction chemistry involved in measurement of NO concentrations

1.  $\text{NO} + \text{O}_3 \rightarrow \text{NO}_2 + \text{NO}_2^* + \text{O}_2$       **Formation of stable and excited NO<sub>2</sub> by reaction of NO with O<sub>3</sub>**



2.  $\text{NO}_2^* \rightarrow \text{NO}_2 + h\nu$                       **Conversion of excited  $\text{NO}_2$  to stable  $\text{NO}_2$  with release of luminescent radiation**

Reaction chemistry involved in measurement of  $\text{NO}_2$  concentrations

3.  $\text{NO}_2 + \text{reducing agent} \rightarrow \text{NO} + \text{oxidized reducing agent}$                       **Reduction of  $\text{NO}_2$  to NO**  
4. **NO measurement by chemiluminescence (Reactions 1 and 2)**

To determine the concentration of NO by chemiluminescence, the sample gas flow from the nitrifying reactors is mixed with  $\text{O}_3$  in a reaction chamber operated under negative pressure (vacuum). The chemiluminescence that results from these reactions is monitored by an optically filtered high sensitivity photomultiplier, that responds to  $\text{NO}_2$  chemiluminescence emission at wavelengths longer than 600 nm. The electronic signal produced in the photomultiplier is proportional to the NO concentration in the sample gas. Measurement of  $\text{NO}_2$  is achieved by means of a heated converter that reduces  $\text{NO}_2$  to NO.

## PROTOCOL FOR MEASURING LIQUID-PHASE NITROUS OXIDE

Prepared by: J-H. Ahn

Last edit: K. Chandran November 8<sup>th</sup>, 2008

Filename: Liquid Phase N<sub>2</sub>O Protocol.doc

### EQUIPMENT NEEDED

1. Nitrous Oxide Microsensor N2O25 (Unisense, Aarhus, Denmark)
2. 2 Channel picoammeter PA2000 (Unisense, Aarhus, Denmark)
3. Calibration Chamber CAL300 (Unisense, Aarhus, Denmark)
4. Zero air and N<sub>2</sub>O gas standard (Tech Air, White Plains, NY)
5. Teflon<sup>®</sup> tubing, Silicone tubing and fittings
6. Squeezer with deionized water
7. Kimwipes
8. BD Falcon 50 ml conical tubes

### EXPERIMENTAL PROCEDURE

#### Principles

The Unisense nitrous oxide microsensor is a miniaturized Clark-type sensor with an internal reference and a guard cathode. In addition, the sensor is equipped with an oxygen front guard, which prevents oxygen from interfering with the nitrous oxide measurements. The sensor is connected to a high-sensitivity picoammeter and the cathode is polarized against the internal reference. Driven by the external partial pressure, nitrous oxide from the environment will penetrate through the sensor tip membranes and be reduced at the metal cathode surface. The picoammeter converts the resulting reduction current to a signal. The internal guard cathode is also polarized and scavenges oxygen in the electrolyte, thus minimizing zero-current and pre-polarization time.

#### Measurement Steps

1. Turn on the power switch located on the front panel of picoammeter.
2. Check the 'Gain' screw for channel 1 is turned fully counter-clockwise.
3. Turn the display switch, located on the center of the panel, to 'Signal 1' and check that the display reads zero. If not, adjust the offset, as per the manufacturer's instructions.
4. Turn the display switch to 'Pol. 1'. Check if the polarization voltage shows -0.8 V. If not, adjust volt and polarity switch.
5. Connect the "pre-polarized" microsensor leads to the meter in the following order: (1) Signal wire (black) to 'Input' of channel 1 on the front panel. (2) Guard wire (yellow) to 'Guard' of channel 1.
6. Rinse out the sensor with deionized water and absorb the moisture with kimwipes.
7. Place the sensor into the calibration chamber which contains deionized water.
8. Select the 'Normal' setting for the 'Mode' switch on the front panel, unless you need the extremely fast response.

9. Select the appropriate measuring range using the 'Range' switch on the panel. Usually 200 pA is selected, but if not suitable, select an alternate range available.
10. Withdraw about 20 ml sample from test reactors in 50 ml conical centrifuge tubes or alternate similar containers (plastic or glass beakers are acceptable).
11. Take out the microsensor from the calibration chamber (containing deionized water), rinse out with deionized water, and mop dry with a tissue.
- 12. Immerse the microsensor into the samples. For (10) and (12), proceed rapidly as possible after acquiring the sample.**
13. Record the numbers from the display on the picoammeter. The measurement numbers should be stable within one minute.
14. Pull out the microsensor, rinse out and place it back into the calibration chamber.
15. Repeat (x) ~ (xiv) for each sampling point and location.
16. When the measurements are complete, disconnect the sensor leads in the reverse order to which they were connected.

### Measurement Range

**Adjustable, 0- 0.616 ppmv-N<sub>2</sub>O (with 500 ppm N<sub>2</sub>O gas standard)**

### Pre-polarization Steps

If the sensor is new or has not been operated for several days, then it must be polarized for at least 2 hours and up to 12 hours before it can be calibrated and/or used.

1. Secure the nitrous oxide sensor with its tip, immersed in nitrous oxide free water.
2. Turn the display switch to 'Pol.1' and adjust the polarization to -1.30 V.
3. Turn the display switch to 'Signal 1' and adjust the 'Gain' screw completely counter-clockwise. Adjust the display to zero on the 'Offset' dial, if needed.
4. Connect the signal wire (black) of the microsensor to 'Input' terminal.
5. After 5 minutes, adjust the polarization to -0.8 V and then connect the guard wire (yellow) to 'Guard' terminal.
6. Prepolarize for as possible up to 12 hours to get the maximum stability.

### Calibration

After the sensor has been polarized, it must be calibrated with zero air and N<sub>2</sub>O gas standards. Typically, we have used 500 ppm N<sub>2</sub>O gas standards for calibration. **Note 1:** N<sub>2</sub>O gas standards are specialty items and can be purchased from vendors such as TechAir.

**Note 2:** To be consistent in terms of units for liquid and gas phase N<sub>2</sub>O, the results of this study are expressed in terms of N<sub>2</sub>O. Alternately, liquid and gas phase N<sub>2</sub>O concentrations can also be expressed as "N" to estimate the fraction of influent nitrogen discharged as N<sub>2</sub>O.

## PROTOCOL FOR MEASURING EMISSION GAS FLOWRATE USING HELIUM TRACER GAS METHOD (after ASTM Method D1946)

Prepared by: S. Kim

Reviewed by: D. Katehis, M. Ward, K. Chandran

Last edit: K. Chandran January 14<sup>th</sup>, 2009

Filename: He Tracer Protocol.doc

### **In Aerated or Aerobic Zones**

1. Activate the field gas-chromatograph approximately prior to the actual helium (He) measurements to allow for the thermal conductivity detector (TCD) and GC column to attain the desired temperatures.
2. After measuring gas-phase N<sub>2</sub>O and NO<sub>x</sub>, disconnect the N<sub>2</sub>O and NO<sub>x</sub> analyzers and connect one outlet vent to the inlet line of the field GC. Close the other vent.
3. Introduce tracer gas (10% He, 90% zero air) through an inlet vent into the flux chamber at a known flow rate (for instance 1L/min).
4. Measure the concentration of He gas exiting the flux chamber ( as per ASTM method D1946).
5. Based on the measured He concentrations, calculate via linear algebra the flow rate of aeration tank headspace gas entering the flux chamber (equation 1).

$$Q_{tracer} * C_{helium-tracer} = (Q_{tracer} + Q_{emission}) * C_{helium-GC}$$

$$Q_{emission} = \frac{Q_{tracer} * (C_{helium-tracer} - C_{helium-GC})}{C_{helium-GC}} \quad (1)$$

6. For each sampling location, conduct steps 2-5 at least three times

### **In Un-Aerated or Anoxic Zones**

1. The only modification to the protocol for adaptation to measuring the emission flow rate from anoxic zones is the introduction of sweep gas.
2. Introduce sweep gas to the chamber at a flow rate of 4L/min and wait 6 min for steady-state.
3. Follow steps 2-6 as described above for determination of emission flow rate from aerobic zones.
4. Calculate the emission flow rate from the anoxic zone using equation 2

$$Q_{tracer} * C_{helium-tracer} = (Q_{tracer} + Q_{sweep} + Q_{emission}) * C_{helium-GC}$$

$$Q_{emission} = \frac{Q_{tracer} * (C_{helium-tracer} - C_{helium-GC})}{C_{helium-GC}} - Q_{sweep} \quad (2)$$

**Note:** Each sampling campaign consists of discrete and continuous N<sub>2</sub>O measurements. During the discrete N<sub>2</sub>O measurements, Q<sub>emission</sub> will be determined at each location in the treatment plant where N<sub>2</sub>O is measured. During continuous N<sub>2</sub>O measurements, Q<sub>emission</sub> will be determined several times a day in correspondence with liquid-phase measurements.

## DATA ANALYSIS AND PROCESSING

### Liquid-phase Sampling in Aerobic and Anoxic Zones

**Preliminary Data Gathering and Steady State Process Analysis.** The integral dependence of  $N_2O$  and  $NO$  emissions on the process operating conditions make the development of a steady state analysis crucial. The following background information will need to be collected from candidate evaluation sites:

**Overall Plant Description.** Obtain general treatment plant configuration, liquid and solids process flow diagrams, design criteria, major mechanical process equipment, etc from the plant's design reports and/or O&M manuals. In addition, gather the following secondary process operating data:

- Secondary Process Configuration, including: Zone Configuration, operating set points, basins in services, aeration system (equipment, controls, monitoring capabilities), typical range of aeration rates, mixers (types, location, HP)
- Plant Operating Data. Summary of a minimum of three months plant data applicable to the treatment process to allow for characterization of the process influent, target and actual operating setpoints for key operational parameters (DO, SRT), effluent concentrations. Table A-7 provides an outline of typical data requirements.

Analyze the data collected using conventional techniques such as development of solids and nitrogen balances as well as through the use of the secondary process model. For the sake of brevity, details of model based evaluation are not presented in their entirety, since we expect to largely follow the procedure described in (7).

### Intensive On-Site Sampling and Analysis

For facilities that are selected to participate an initial diurnal sampling effort will be conducted to characterize influent flow, organics and nitrogen concentrations to the facility, in preparation for the detailed liquid and air measurement campaign. For the initial diurnal sampling conventional parameters will be monitored from the secondary process as detailed in Table A-8, including:

- ◆ Influent Flowrate (minimum of once per hour)
- ◆ Influent and Effluent Ammonia (8 times per day)
- ◆ Influent and Effluent Nitrite & Nitrate (8 times per day, may substitute  $(NO_2^- + NO_3^-)$  with subset  $NO_2^-N$  measurement)
- ◆ Influent and Effluent COD (assume once per hour, can be reduced depending on site)

Additionally, the following diurnal performance and in-tank profiles will be gathered according to Table A-8.

Table A-7. Data Requirements for Plant Screening.

Sample Location	Analyte												
	TSS	VSS	Total cBOD <sub>5</sub> <sup>1</sup>	Sol. cBOD <sub>5</sub>	Total COD <sup>1</sup>	Sol. COD <b>0.45u</b>	ff COD	Temp	TKN <sup>1</sup>	Sol. TKN <b>0.45u</b>	NH <sub>3</sub> -N <b>0.45u</b>	NO <sub>3</sub> -N	NO <sub>2</sub> -N
Primary Effluent	1/wk	1/wk	1/wk	1/wk	1/wk	1/wk	1/wk		1/wk	1/wk	1/wk	1/wk	1/wk
Secondary Effluent	1/wk	1/wk	1/wk	1/wk	1/wk	1/wk <sup>2</sup>	1/wk <sup>2</sup>		1/wk	1/wk	1/wk	1/wk	1/wk
Reactor MLSS	1/wk	1/wk						1/wk					
RAS MLSS	1/wk												
WAS MLSS	1/wk <sup>3</sup>												
Clarifier	Blanket TSS (use sludge judge- 1/day and average once per week)												
Flow split and flow rate	<b>Different measurements possible</b> <ul style="list-style-type: none"> <li>• Approximate- set PE gate and allow natural hydraulics (no info on range)</li> <li>• Confirm flow split by doing mass balance and MLSS concentrations</li> <li>• Alternately: take a measurement of MLSS at each pass:</li> <li>• Use Royce meter to get each pass TSS every 2-3 hours to get running average</li> </ul>												
Anoxic Zone Mixing	Mechanical or aerator driven												
<b>Operating Data</b>													
Influent Flow	Diurnal Flow Pattern at Appropriate Time Intervals (15 minutes for periods of rapid diurnal increase, 1 hour for stable periods)												
RAS Flow	Average weekly RAS Flow, Indicate location and type of flow measurement and variability of flow												
WAS Flow	Average weekly WAS Flow, Indicate location and type of flow measurement, times of WAS wasting if not continuous												
Dissolved Oxygen	1/day (then average weekly), indicate location of DO measurement along basin length and time of measurement												
Aeration Rate	Daily average, indicate location of Air Flow Measurement and variability over the course of the day. SCADA output at short time intervals would be best												
Pickle Liquor Consumption	Daily, indicate Ferric Chloride equivalent strength, dosing points and dose at each point												

<sup>1</sup> Homogenize subsample prior to “total” measurement. Discard remaining sample – **DO NOT** use for “filtrate” or “soluble” determinations

<sup>2</sup>: soluble COD can be used instead of ffCOD on the secondary effluent

<sup>3</sup>: when RAS and WAS are from the same stream, TSS measurement on one of these streams is sufficient

Table A-8. Data Requirements for Model Calibration.

Sample Location	Analyte													
	TSS	VSS	Total cBOD <sub>5</sub> <sup>1</sup>	Soluble cBOD <sub>5</sub>	Total COD <sup>1</sup>	Sol. COD	ff COD	TKN <sup>1</sup>	Sol. TKN	pH	Alk	NH <sub>3</sub> -N	NO <sub>3</sub> -N	NO <sub>2</sub> -N
Primary Effluent	8/d	2/d	8/d	8/d	8/d	8/d	8/d	8/d	8/d	8/d	8/d	8/d	8/d	8/d
Secondary Effluent	8/d	-	8/d	8/d	8/d	8/d <sup>2</sup>	8/d <sup>2</sup>	8/d	8/d	8/d	8/d	8/d	8/d	8/d
RAS MLSS	8/d													
WAS MLSS	8/d <sup>3</sup>													
<b>Operating Data</b>														
Influent Flow	Diurnal Flow Pattern at Appropriate Time Intervals (15 minutes for periods of rapid diurnal increase, 1 hour for stable periods)													
RAS Flow	Average Daily RAS Flow, Indicate location and type of flow measurement and variability of flow													
WAS Flow	Average Daily WAS Flow, Indicate location and type of flow measurement, times of WAS wasting if not continuous													
Dissolved Oxygen	1/hr, indicate location of DO measurement along basin length and time of measurement													
Aeration Rate	Daily average, indicate location of Air Flow Measurement and variability over the course of the day. SCADA output at short time intervals would be best													
<b>In-tank Profiles</b>	TSS	VSS	pH	DO	ORP	Temp.	ff COD	Alk.	NH <sub>3</sub> -N	NO <sub>3</sub> -N	NO <sub>2</sub> -N			
	8/d	2/d	8/d	8/d	8/d	8/d	8/d	8/d	8/d	8/d	8/d	8/d	8/d	8/d

**Determination of Fluxes**

Calculate the net flux of gaseous N species ( $\text{mg}/\text{min}\cdot\text{m}^2$ ) based on the gas flow rate out of the flux chamber ( $Q_{\text{emission}}$ , L/min), gas concentration (parts per million) and the cross-sectional area of the SEIFC ( $\text{m}^2$ ) (Equation 3).

$$\text{Flux} = \frac{Q_{\text{emission}} * C}{A} \quad (3)$$

Correct the calculated flux reflect standard temperature ( $20^\circ\text{C}$ ) and pressure (1 atm.).

**Determination of Lumped Emission Factors**

Lumped  $\text{N}_2\text{O}$  emission factors for each facility will be computed based on the measured flux from each zone in the facility normalized to the daily influent total Kjeldahl nitrogen (TKN) loading (mass/mass) according to equation 4.

$$\text{Emission - factor} = \frac{\sum_{i=1}^n \text{Flux}_i * \text{Area}_i - (\text{kg} - \text{N}_2\text{O} - \text{N})}{\text{Daily - inf luent - TKN - load} - (\text{kg} - \text{N})} \quad (4)$$

Where:

$\text{Flux}_i$  =  $\text{N}_2\text{O}$  emission flux calculated from the  $i^{\text{th}}$  zone ( $\text{kg} \text{N}_2\text{O}\text{-N}/\text{m}^2\text{-d}$ )

$\text{Area}_i$  = Surface area of the  $i^{\text{th}}$  zone ( $\text{m}^2$ )

$n$  = number of zones in a given facility from which  $\text{N}_2\text{O}$  fluxes are captured

It should be noted that the above calculations reflect the emission factor calculated from discrete  $\text{N}_2\text{O}$  measurements. In plants where significant diurnal variability exists, such variability will be accounted for by a combination of explicit measurements in select zones and mathematical modeling output of  $\text{N}_2\text{O}$  fluxes from remaining zones.





APPENDIX B

DATA FILES

(Available on CD Rom by Request)



APPENDIX C

PROCESS SCHEMATICS OF WWTPS SAMPLED

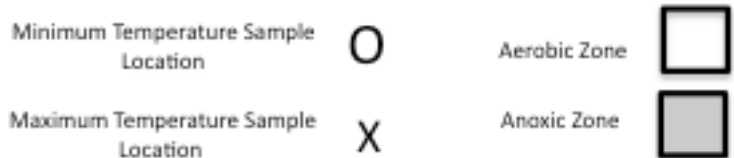

Separate-stage BNR

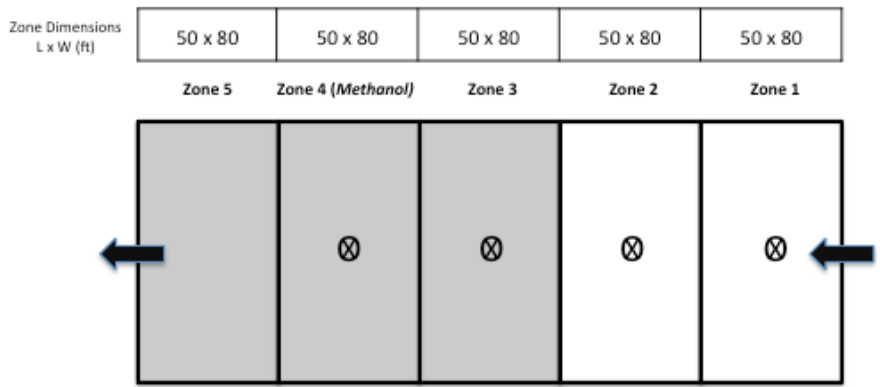

Four-stage Bardenpho

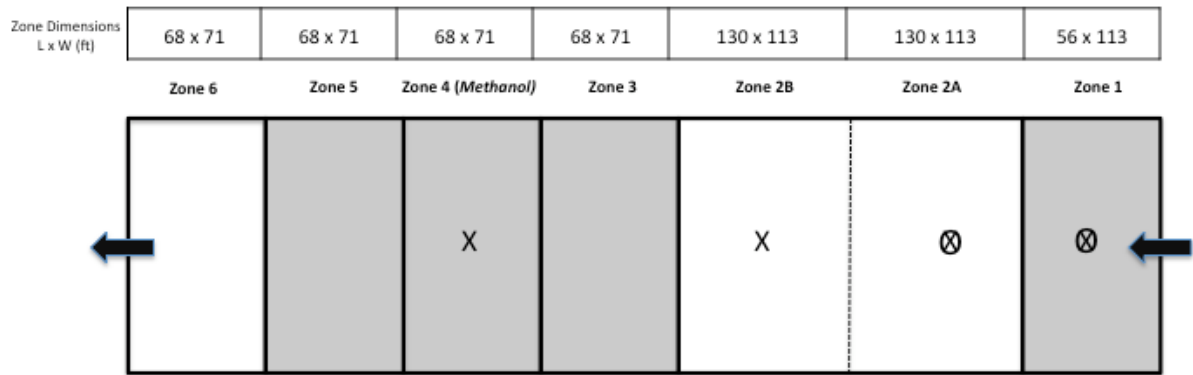

Attachment B

Step-feed BNR 1

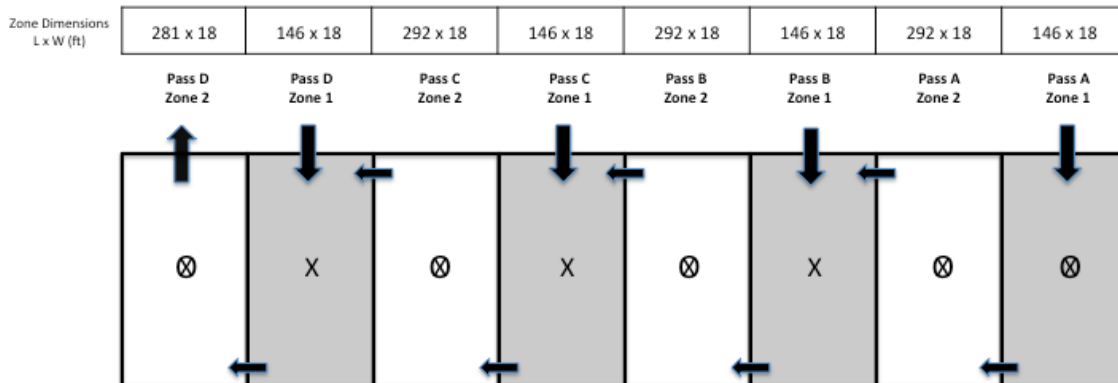

Step-feed non-BNR \*

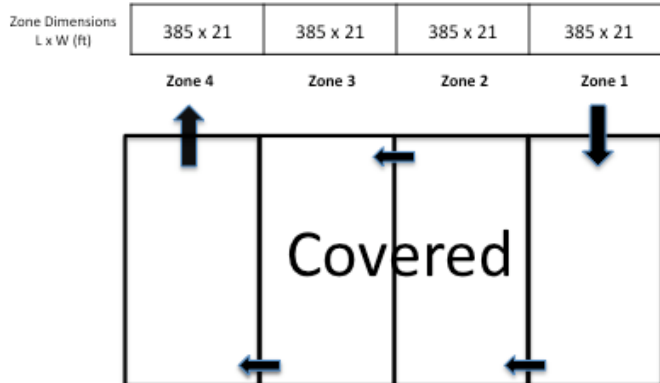

Separate centrate

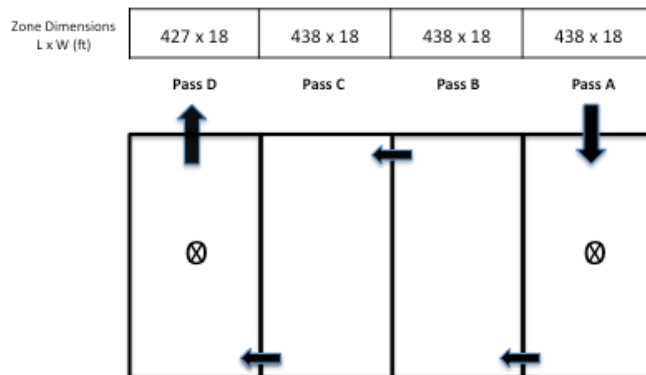

# Attachment B

## Plug flow 1

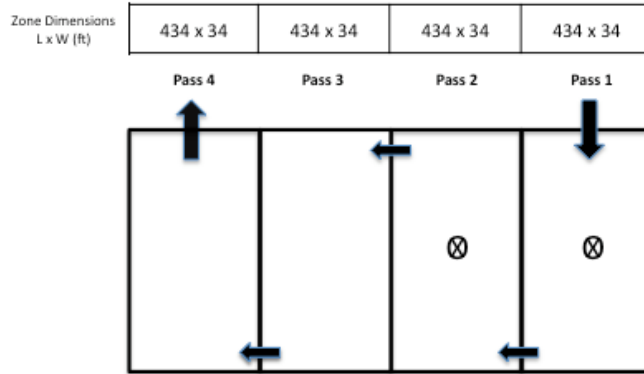

## Plug flow 2

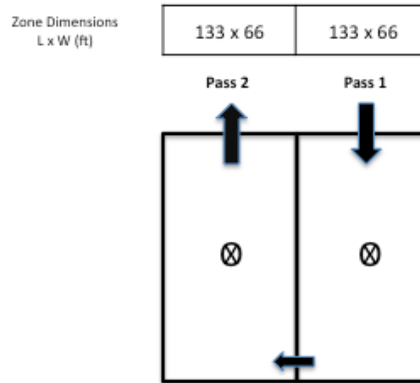

## MLE 1

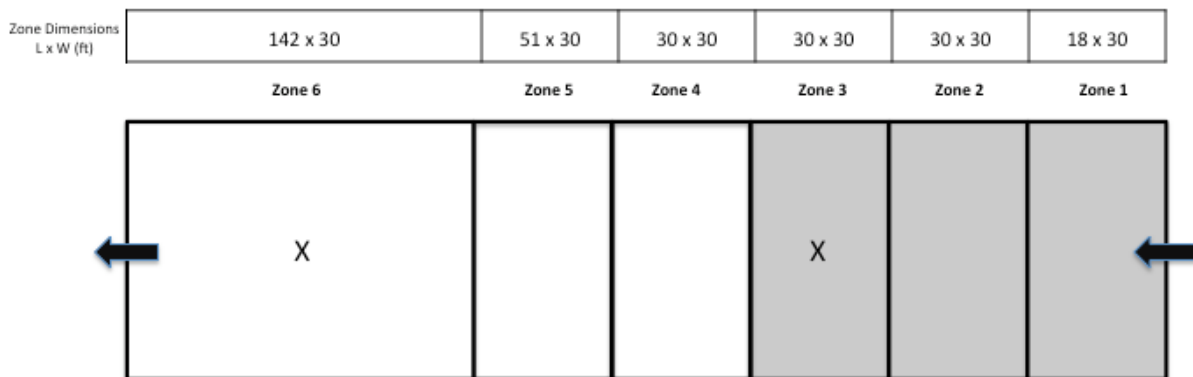

MLE 2

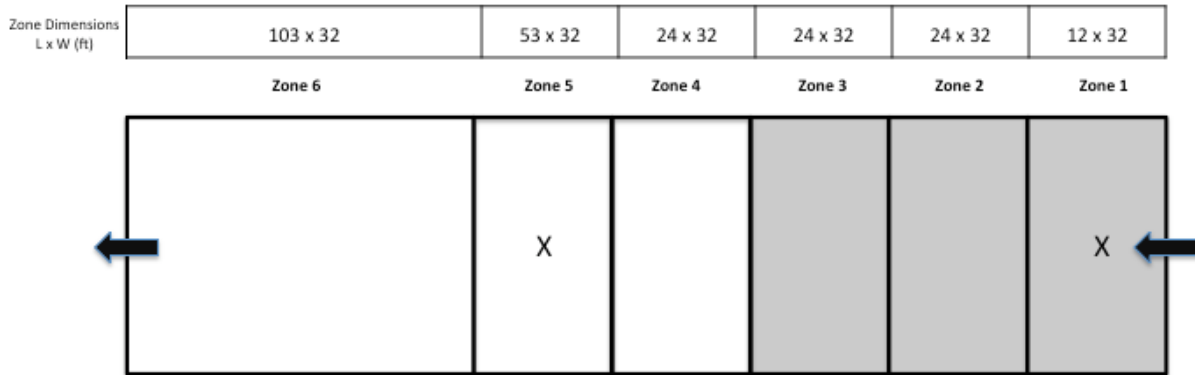

Step-feed BNR 2

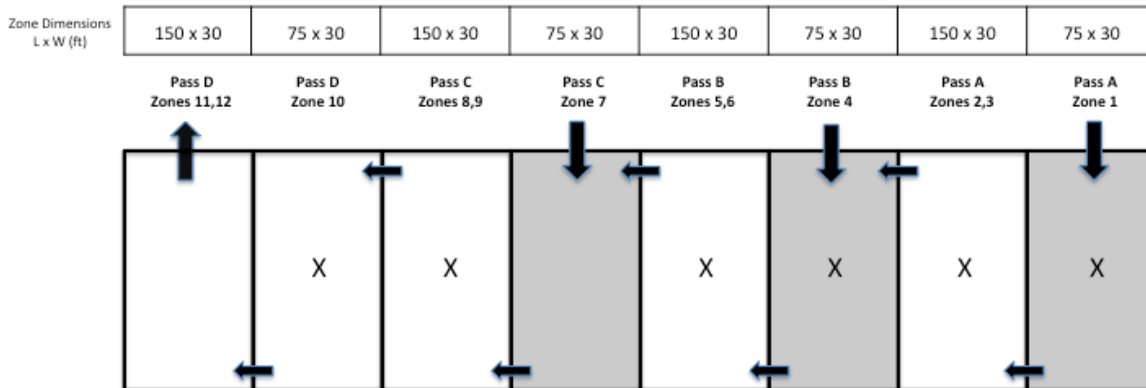

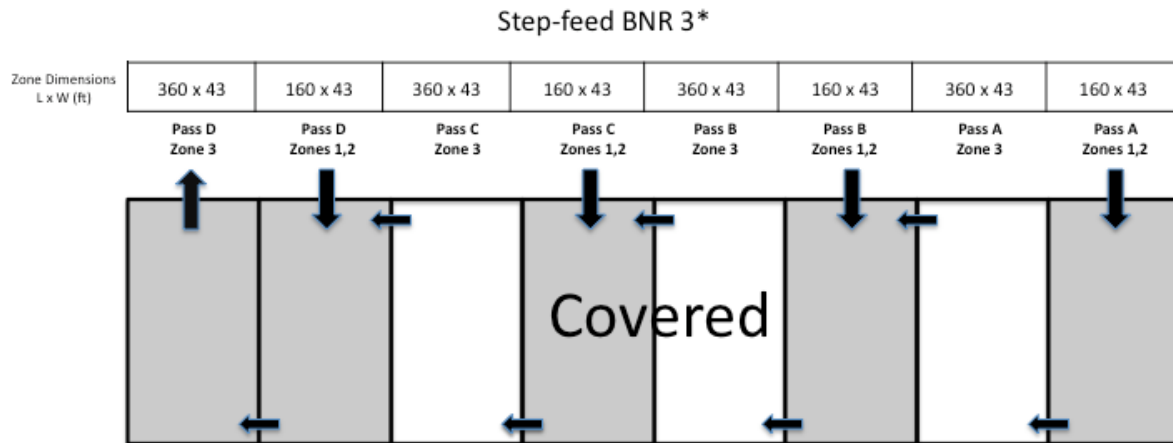
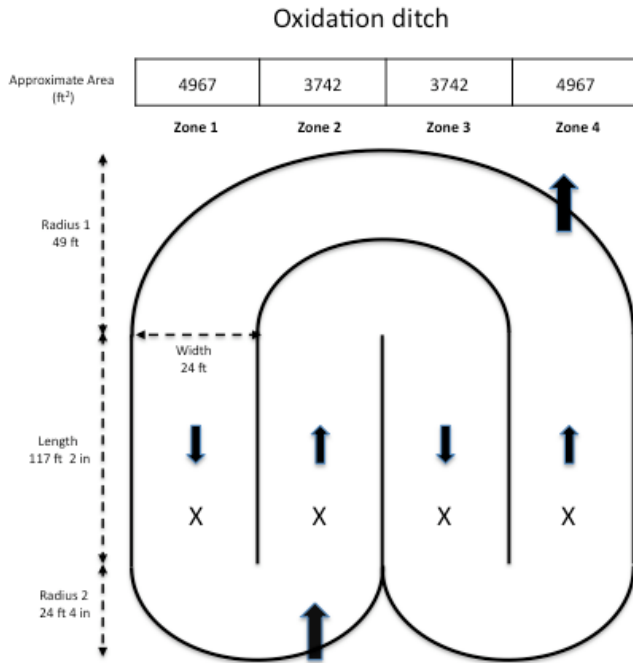





## REFERENCES

- Ahn, J.-H., Kim, S., Pagilla, K., Katehis, D., Chandran, K. (2009) Spatial and temporal variability in N<sub>2</sub>O generation and emission from wastewater treatment plants. Nutrient Removal Conference. Washington D.C., Water Environment Federation.
- Ahn, J.H., Kim, S., Park, H., Rahm, B., Pagilla, K., Chandran, K. (2010) N<sub>2</sub>O Emissions from Activated Sludge Processes, 2008a-2009: Results of a National Monitoring Survey in the United States. Environ. Sci. Technol.
- Anderson, I.C., Levine, J.S. (1986) Relative rates of nitric oxide and nitrous oxide production by nitrifiers, denitrifiers and nitrate respirers. Appl. Environ. Microbiol., 51, 938-945.
- Anderson, I.C., Poth, M., Homstead, J., Burdige, D. (1993) A comparison of NO and N<sub>2</sub>O production by the autotrophic nitrifier *Nitrosomonas europaea* and the heterotrophic nitrifier *Alcaligenes faecalis*. Appl. Environ. Microbiol., 59, 3525-3533.
- Arp, D.J., Stein, L.Y. (2003) Metabolism of Inorganic N Compounds by Ammonia-Oxidizing Bacteria. Crit. Rev. Biochem. Mol. Biol., 38, 471-495.
- Baytshtok, V., Kim, S., Yu, R., Park, H., Chandran, K. (2008) Molecular and biokinetic characterization of methylotrophic denitrification using nitrate and nitrite as terminal electron acceptors. Water Sci. Technol., 58, 359-365.
- Baytshtok, V., Lu, H., Park, H., Kim, S., Yu, R., Chandran, K. (2009) Impact of varying electron donors on the molecular microbial ecology and biokinetics of methylotrophic denitrifying bacteria. Biotechnol. Bioeng., 102, 1527-1536.
- Beaumont, H.J.E., Hommes, N.G., Sayavedra-Soto, L.A., Arp, D.J., Arciero, D.M., Hooper, A.B., Westerhoff, H.V., Van Spanning, R.J.M. (2002) Nitrite Reductase of *Nitrosomonas europaea* Is Not Essential for Production of Gaseous Nitrogen Oxides and Confers Tolerance to Nitrite. J. Bacteriol., 184, 2557-2560.
- Beaumont, H.J.E., Lens, S.I., Reijnders, W.N.M., Westerhoff, H.V., Van Spanning, R.J.M. (2004a) Expression of nitrite reductase in *Nitrosomonas europaea* involves NsrR, a novel nitrite-sensitive transcription repressor. Mol. Microbiol., 54, 148-158.
- Beaumont, H.J.E., Lens, S.I., Westerhoff, H.V., Van Spanning, R.J.M. (2005) Novel *nirK* cluster genes in *Nitrosomonas europaea* are required for NirK-dependent tolerance to nitrite. J. Bacteriol., 187, 6849-6851.
- Beaumont, H.J.E., Van Schooten, B., Lens, S.I., Westerhoff, H.V., Van Spanning, R.J.M.

- (2004b) *Nitrosomonas europaea* Expresses a Nitric Oxide Reductase during Nitrification. *J. Bacteriol.*, 186, 4417-4421.
- Betlach, M.R., Tiedje, J.M. (1981) Kinetic explanation for accumulation of nitrite, nitric oxide and nitrous oxide during bacterial denitrification. *Appl. Environ. Microbiol.*, 42, 1074-1084.
- Bock, E. (1995) Nitrogen loss caused by denitrifying *Nitrosomonas* cells using ammonium or hydrogen as electron donors and nitrite as electron acceptor. *Arch. Microbiol.*, 163, 16-20.
- Bollmann, A., Bar-Gilissen, M.-J., Laanbroek, H.J. (2002) Growth at Low Ammonium Concentrations and Starvation Response as Potential Factors Involved in Niche Differentiation among Ammonia-Oxidizing Bacteria. *Appl. Environ. Microbiol.*, 68, 4751-4757.
- Burgess, J.E., Stuetz, R.M., Morton, S., Stephenson, T. (2002) Dinitrogen oxide detection for process failure early warning systems. *Water Sci. Technol.*, 45, 247-254.
- Butler, M.D., Wang, Y.Y., Cartmell, E., Stephenson, T. (2009) Nitrous oxide emissions for early warning of biological nitrification failure in activated sludge. *Wat. Res.*, 43, 1265-1272.
- Chain, P., Lamerdin, J., Larimer, F., Regala, W., Lao, V., Land, M., Hauser, L., Hooper, A., Klotz, M., Norton, J., Sayavedra-Soto, L., Arciero, D., Hommes, N., Whittaker, M., Arp, D. (2003) Complete genome sequence of the ammonia-oxidizing bacterium and obligate chemolithoautotroph *Nitrosomonas europaea*. *J. Bacteriol.*, 185, 2759-2773.
- Chandran, K. (2009) Characterization of nitrogen greenhouse gas emissions from wastewater treatment BNR operations: Field protocol with quality assurance plan. Alexandria, VA, Water Environment Research Foundation.
- Chandran, K., Love, N.G. (2008) Physiological state, growth mode, and oxidative stress play a role in Cd(II)-mediated inhibition of *Nitrosomonas europaea* 19718. *Appl. Environ. Microbiol.*, 74, 2447-2453.
- Chandran, K., Smets, B.F. (2008) Biokinetic characterization of the acceleration phase in autotrophic ammonia oxidation. *Wat. Environ. Res.*, 80, 732-739.
- Colliver, B.B., Stephenson, T. (2000) Production of nitrogen oxide and dinitrogen oxide by autotrophic nitrifiers. *Biotechnology Advances*, 18, 219-232.
- Czepiel, P., Crill, P., Harriss, R. (1995) Nitrous Oxide Emissions from Municipal Wastewater Treatment. *Environ. Sci. Technol.*, 29, 2352-2356.
- Davidson, E.A., Matson, P.A., Vitousek, P.M., Riley, R., Dunkin, K., Garcia-Mendez, G., Maass, J.M. (1993) Processes Regulating Soil Emissions of NO and N<sup>2</sup>O in a Seasonally

Dry Tropical Forest. *Ecology*, 74, 130-139.

Dean, J.A. (Ed.) (1985) *Lange's Handbook of Chemistry*, New York, NY, McGraw-Hill Book Company.

Eaton, A.D., Clesceri, L.S., Greenberg, A.E. (Eds.) (2005) *Standard methods for the examination of water and wastewater*, Washington, DC, APHA, AWWA and WEF.

Focht, D.D. (1974) The effect of temperature, pH and aeration on the production of nitrous oxide and gaseous nitrogen - A zero order kinetic model. *Soil Sci.*, 118, 173-179.

Frear, D.S., Burrell, R.C. (1955) Spectrophotometric method for determining hydroxylamine reductase activity in higher plants. *Analytical Chemistry*, 27, 1664-1665.

Ginige, M.P., Hugenholtz, P., Daims, H., Wagner, M., Keller, J., Blackall, L.L. (2004) Use of Stable-Isotope Probing, Full-Cycle rRNA Analysis, and Fluorescence In Situ Hybridization-Microautoradiography To Study a Methanol-Fed Denitrifying Microbial Community. *Appl. Environ. Microbiol.*, 70, 588-596.

Girsch, P., De Vries, S. (1997) Purification and initial kinetic and spectroscopic characterization of NO reductase from *Paracoccus denitrificans*. *Biochimica et Biophysica Acta (BBA) - Bioenergetics*, 1318, 202-216.

Goreau, T.J., Kaplan, W.A., Wofsy, S.C., Mcelroy, M.B., Valois, F.W., Watson, S.W. (1980) Production of NO<sub>2</sub>- and N<sub>2</sub>O by Nitrifying Bacteria at Reduced Concentrations of Oxygen. *Appl. Environ. Microbiol.*, 40, 526-532.

Goretski, J., Zafiriou, O.C., Hollocher, T.C. (1990) Steady-state nitric oxide concentrations during denitrification. *Journal of Biological Chemistry*, 265, 11535-11538.

Grady, C.P.L.J., Daigger, G.T., Lim, H.C. (1999) *Biological wastewater treatment.*, New York, Marcel Dekker.

Guisasola, A., Jubany, I., Baeza, J.A., Carrera, J., Lafuente, J. (2005) Respirometric estimation of the oxygen affinity constants for biological ammonium and nitrite oxidation. *J. Chem. Technol. Biotechnol.*, 80, 388-396.

Hanaki, K., Hong, Z., Matsuo, T. (1992) Production of nitrous oxide gas during denitrification of wastewater. *Water Sci. Technol.*, 26, 1027-1036.

Holmes, A.J., Costello, A., Lidstrom, M.E., Murrell, J.C. (1995) Evidence that particulate methane monooxygenase and ammonia monooxygenase may be evolutionarily related. *FEMS Microbiol. Lett.*, 132, 203-208.

Hooper, A.B. (1969 (b)) Lag phase of ammonia oxidation by resting cells of *Nitrosomonas europaea*. *J. Bacteriol.*, 97, 968-969.

- Hooper, A.B., Vannelli, T., Bergmann, D.J., Arciero, D.M. (1997) Enzymology of the oxidation of ammonia to nitrite by bacteria. *Antonie van Leeuwenhoek*, 71, 59-67.
- Jiang, Q.-Q., Bakken, L.R. (1999) Nitrous Oxide Production and Methane Oxidation by Different Ammonia-Oxidizing Bacteria. *Appl. Environ. Microbiol.*, 65, 2679-2684.
- Kampschreur, M.J., Tan, N.C.G., Kleerebezem, R., Picioreanu, C., Jetten, M.S.M., Loosdrecht, M.C.M.V. (2008a) Effect of Dynamic Process Conditions on Nitrogen Oxides Emission from a Nitrifying Culture. *Environ. Sci. Technol.*, 42, 429-435.
- Kampschreur, M.J., Van Der Star, W.R.L., Wienders, H.A., Mulder, J.W., Jetten, M.S.M., Van Loosdrecht, M. C. M. (2008b) Dynamics of nitric oxide and nitrous oxide emission during full-scale reject water treatment. *Wat. Res.*, 42, 812-826.
- Kester, R.A., De Boer, W., Laanbroek, H.J. (1997) Production of NO and N<sub>2</sub>O by pure cultures of nitrifying and denitrifying bacteria during changes in aeration. *Appl. Environ. Microbiol.*, 63, 3872-3877.
- Kimochi, Y., Inamori, Y., Mizuochi, M., Xu, K.-Q., Matsumura, M. (1998) Nitrogen removal and N<sub>2</sub>O emission in a full-scale domestic wastewater treatment plant with intermittent aeration. *J. Ferment. Bioeng.*, 86, 202-206.
- Knowles, R. (1982) Denitrification. *Microbiol. Rev.*, 46, 43-70.
- Korner, H., Zumft, W.G. (1989) Expression of denitrification enzymes in response to the dissolved oxygen level and respiratory substrate in continuous culture of *Pseudomonas stutzeri*. *Appl. Environ. Microbiol.*, 55, 1670-1676.
- Lu, H., Chandran, K. (2010) Factors promoting emissions of nitrous oxide and nitric oxide from denitrifying sequencing batch reactors operated with methanol and ethanol as electron donors. *Biotechnol. Bioeng.*, 106, 390-398.
- Madigan, M.T., Martinko, J.M. (2006) *Brock Biology of Microorganisms*, Upper Saddle River, NJ, Prentice Hall.
- Moyer, C.L., Dobbs, F.C., Karl, D.M. (1994) Estimation of diversity and community structure through restriction fragment length polymorphism distribution analysis of bacterial 16S rRNA genes from a microbial mat at an active, hydrothermal vent system, Loihi Seamount, Hawaii. *Appl. Environ. Microbiol.*, 60, 871-879.
- Nadkarni, M.A., Martin, F.E., Jacques, N.A., Hunter, N. (2002) Determination of bacterial load by real-time PCR using a broad-range (universal) probe and primers set. *Microbiol.*, 148, 257-266.
- Okano, Y., Hristova, K.R., Leutenegger, C.M., Jackson, L.E., Denison, R.F., Gebreyesus, B., Lebauer, D., Scow, K.M. (2004) Application of real-time PCR to study effects of ammonium

on population size of ammonia-oxidizing bacteria in soil. *Appl. Environ. Microbiol.*, 70, 1008-1016.

Osaka, T., Ebie, Y., Tsuneda, S., Inamori, Y. (2008) Identification of the bacterial community involved in methane-dependent denitrification in activated sludge using DNA stable-isotope probing. *FEMS Microbiol. Ecol.*, 64, 494-506.

Otte, S., Grobden, N.G., Robertson, L.A., Jetten, M.S., Kuenen, J.G. (1996) Nitrous oxide production by *Alcaligenes faecalis* under transient and dynamic aerobic and anaerobic conditions. *Appl. Environ. Microbiol.*, 62, 2421-2426.

Park, K.Y., Inamori, Y., Mizuochi, M., Ahn, K.H. (2000) Emission and Control of Nitrous Oxide from a Biological Wastewater Treatment System with Intermittent Aeration. *The Society for Biotechnology, Japan*, 90, 247-252.

Poth, M. (1985) Dinitrogen production from nitrite by a *Nitrosomonas* isolate. *Appl. Environ. Microbiol.*, 52, 957-959.

Poth, M., Focht, D.D. (1985) <sup>15</sup>N Kinetic Analysis of N<sub>2</sub>O Production by *Nitrosomonas europaea*: an Examination of Nitrifier Denitrification. *Appl. Environ. Microbiol.*, 49, 1134-1141.

Ravishankara, A.R., Daniel, J.S., Portmann, R.W. (2009) Nitrous Oxide (N<sub>2</sub>O): The Dominant Ozone-Depleting Substance Emitted in the 21st Century. *Science*, 1176985.

Ritchie, G.A.F., Nicholas, D.J.D. (1972) Identification of the sources of nitrous oxide produced by oxidative and reductive processes in *Nitrosomonas europaea*. *Biochem. J.*, 126, 1181-1191.

Rittmann, B.E., Mccarty, P.L. (2001) *Environmental Biotechnology\_ Principles and Applications*, New York, McGraw Hill.

Schmidt, I., Bock, E. (1997) Anaerobic ammonia oxidation with nitrogen dioxide by *Nitrosomonas eutropha*. *Arch. Microbiol.*, 167, 106-111.

Schmidt, I., Bock, E. (1998) Anaerobic ammonia oxidation by cell-free extracts of *Nitrosomonas eutropha*. *Antonie van Leeuwenhoek*, 73, 271-278.

Schmidt, I., Van Spanning, R.J.M., Jetten, M.S.M. (2004) Denitrification and ammonia oxidation by *Nitrosomonas europaea* wild-type, and NirK- and NorB-deficient mutants. *Microbiol.*, 150, 4107-4114.

Shaw, L.J., Nicol, G.W., Smith, Z., Fear, J., Prosser, J.I., Baggs, E.M. (2006) *Nitrosospira* spp. can produce nitrous oxide via a nitrifier denitrification pathway. *Environ. Microbiol.*, 8, 214-222.

Sommer, J., Ciplak, A., Sumer, E., Benckiser, G., Ottow, J.C.G. (1998) Quantification of emitted and retained N<sub>2</sub>O in a municipal wastewater treatment plant with activated sludge and nitrification-denitrification units. *Agrobiological Research*, 51, 59-73.

Stuven, R., Vollmer, M., Bock, E. (1992) The impact of organic matter on nitric oxide formation by *Nitrosomonas europaea*. *Arch. Microbiol.*, 158, 439-443.

Sümer, E., Weiske, A., Benckiser, G., Ottow, J.C.G. (1995) Influence of environmental conditions on the amount of N<sub>2</sub>O released from activated sludge in a domestic waste water treatment plant. *Cell. Mol. Life Sci.*, 51, 419-422.

Sutka, R.L., Ostrom, N.E., Ostrom, P.H., Breznak, J.A., Gandhi, H., Pitt, A.J., Li, F. (2006) Distinguishing Nitrous Oxide Production from Nitrification and Denitrification on the Basis of Isotopomer Abundances. *Appl. Environ. Microbiol.*, 72, 638-644.

Tallec, G., Garnier, J., Billen, G., Gousailles, M. (2006) Nitrous oxide emissions from secondary activated sludge in nitrifying conditions of urban wastewater treatment plants: Effect of oxygenation level. *Wat. Res.*, 40, 2972-2980.

Tallec, G., Garnier, J., Billen, G., Gousailles, M. (2008) Nitrous oxide emissions from denitrifying activated sludge of urban wastewater treatment plants, under anoxia and low oxygenation. *Bioresour. Technol.*, 99, 2200-2209.

Tata, P., Witherspoon, J., Lue-Hing, C. (Eds.) (2003) *VOC Emissions from Wastewater Treatment Plants*, Boca Raton, FL, Lewis Publishers.

Tchobanoglous, G., Burton, F.L., Stensel, H.D. (2003) *Metcalf and Eddy Wastewater Engineering: Treatment and Reuse*, New York, NY, McGraw Hill.

U.S. EPA (2009) *Inventory of U.S. Greenhouse Gas Emissions and Sinks: 1990-2006*, EPA 430-R-08-005. Washington, D.C.

Vadivelu, V.M., Keller, N., Yuan, Z. (2007) Free ammonia and free nitrous acid inhibition on the anabolic and catabolic processes of *Nitrosomonas* and *Nitrobacter*. *Water Sci. Technol.*, 56, 89-97.

Von Schultess, R., Kuhni, M., Gujer, W. (1995) Release of nitric and nitrous oxides from denitrifying activated sludge. *Wat. Res.*, 29, 215-226.

Von Schultess, R., Wild, D., Gujer, W. (1994) Nitric and nitrous oxides from denitrifying activated sludge at low oxygen concentration. *Water Sci. Technol.*, 30, 123-132.

Wicht, H., Beier, M. (1995) N<sub>2</sub>O emission aus nitrifizierenden und denitrifizierenden Klaranlagen. *Korrespondenz Abwasser*, 42, 404-406, 411-413.

Wrage, N., Velthof, G.L., Laanbroek, H.J., Oenema, O. (2004) Nitrous oxide production in

grassland soils: assessing the contribution of nitrifier denitrification. *Soil Biology and Biochemistry*, 36, 229-236.

Yu, R., Kampschreur, M.J., Loosdrecht, M.C.M.V., Chandran, K. (2010) Mechanisms and Specific Directionality of Autotrophic Nitrous Oxide and Nitric Oxide Generation during Transient Anoxia. *Environ. Sci. Technol.*, 44, 1313-1319.

Zhou, Y., Pijuan, M., Zeng, R.J., Yuan, Z. (2008) Free Nitrous Acid Inhibition on Nitrous Oxide Reduction by a Denitrifying-Enhanced Biological Phosphorus Removal Sludge. *Environ. Sci. Technol.*, 42, 8260-8265.

Zumft, W.G. (1992) The denitrifying prokaryotes. In Balows, A., H.G. Truper, M. Dworkin, W. Harder and K. H. Schleifer (Ed.) *The Prokaryotes*. 2nd ed. Berlin, Springer-Verlag.

Zumft, W.G. (1997) Cell biology and molecular basis of denitrification. *Microbiol. Mol. Biol. Rev.*, 61, 533-616.





**WASTEWATER UTILITY****Alabama**

Montgomery Water Works & Sanitary Sewer Board

**Alaska**

Anchorage Water & Wastewater Utility

**Arizona**

Avondale, City of  
Glendale, City of, Utilities Department  
Mesa, City of  
Peoria, City of  
Phoenix Water Services Dept.  
Pima County Wastewater Management  
Safford, City of  
Tempe, City of

**Arkansas**

Little Rock Wastewater Utility

**California**

Central Contra Costa Sanitary District  
Corona, City of  
Crestline Sanitation District  
Delta Diablo Sanitation District  
Dublin San Ramon Services District  
East Bay Dischargers Authority  
East Bay Municipal Utility District  
El Dorado Irrigation District  
Fairfield-Suisun Sewer District  
Fresno Department of Public Utilities  
Inland Empire Utilities Agency  
Irvine Ranch Water District  
Las Gallinas Valley Sanitary District  
Las Virgenes Municipal Water District  
Livermore, City of  
Los Angeles, City of  
Los Angeles County, Sanitation Districts of  
Napa Sanitation District  
Novato Sanitary District  
Orange County Sanitation District  
Palo Alto, City of  
Riverside, City of  
Sacramento Regional County Sanitation District  
San Diego Metropolitan Wastewater Department, City of  
San Francisco, City & County of  
San Jose, City of  
Santa Barbara, City of  
Santa Cruz, City of  
Santa Rosa, City of  
South Bayside System Authority  
South Coast Water District

South Orange County Wastewater Authority  
South Tahoe Public Utility District

Steger Sanitary District  
Sunnyvale, City of  
Union Sanitary District  
West Valley Sanitation District

**Colorado**

Aurora, City of  
Boulder, City of  
Greeley, City of  
Littleton/Englewood Water Pollution Control Plant  
Metro Wastewater Reclamation District, Denver

**Connecticut**

Greater New Haven WPCA  
Stamford, City of

**District of Columbia**

District of Columbia Water & Sewer Authority

**Florida**

Broward, County of  
Fort Lauderdale, City of  
Jacksonville Electric Authority (JEA)  
Miami-Dade Water & Sewer Authority  
Orange County Utilities Department  
Pinellas, County of  
Reedy Creek Improvement District  
Seminole County Environmental Services  
St. Petersburg, City of  
Tallahassee, City of  
Toho Water Authority  
West Palm Beach, City of

**Georgia**

Atlanta Department of Watershed Management  
Augusta, City of  
Clayton County Water Authority  
Cobb County Water System  
Columbus Water Works  
Fulton County  
Gwinnett County Department of Public Utilities  
Savannah, City of

**Hawaii**

Honolulu, City & County of

**Idaho**

Boise, City of

**Illinois**

Decatur, Sanitary District of  
Greater Peoria Sanitary District  
Kankakee River Metropolitan Agency  
Metropolitan Water Reclamation District of Greater Chicago  
Wheaton Sanitary District

**Indiana**

Jeffersonville, City of

**Iowa**

Ames, City of  
Cedar Rapids Wastewater Facility  
Des Moines, City of  
Iowa City

**Kansas**

Johnson County Wastewater Unified Government of Wyandotte County/  
Kansas City, City of

**Kentucky**

Louisville & Jefferson County Metropolitan Sewer District  
Sanitation District No. 1

**Louisiana**

Sewerage & Water Board of New Orleans

**Maine**

Bangor, City of  
Portland Water District

**Maryland**

Anne Arundel County Bureau of Utility Operations  
Howard County Bureau of Utilities  
Washington Suburban Sanitary Commission

**Massachusetts**

Boston Water & Sewer Commission  
Massachusetts Water Resources Authority (MWRA)  
Upper Blackstone Water Pollution Abatement District

**Michigan**

Ann Arbor, City of  
Detroit, City of  
Holland Board of Public Works  
Saginaw, City of  
Wayne County Department of Environment  
Wyoming, City of

**Minnesota**

Rochester, City of  
Western Lake Superior Sanitary District

**Missouri**

Independence, City of  
Kansas City Missouri Water Services Department  
Little Blue Valley Sewer District  
Metropolitan St. Louis Sewer District

**Nebraska**

Lincoln Wastewater & Solid Waste System

**Nevada**

Henderson, City of  
Las Vegas, City of  
Reno, City of

**New Jersey**

Bergen County Utilities Authority  
Ocean County Utilities Authority

**New York**

New York City Department of Environmental Protection

**North Carolina**

Charlotte/Mecklenburg Utilities  
Durham, City of  
Metropolitan Sewerage District of Buncombe County  
Orange Water & Sewer Authority  
University of North Carolina, Chapel Hill

**Ohio**

Akron, City of  
Butler County Department of Environmental Services  
Columbus, City of  
Metropolitan Sewer District of Greater Cincinnati  
Montgomery, County of  
Northeast Ohio Regional Sewer District  
Summit, County of

**Oklahoma**

Oklahoma City Water & Wastewater Utility Department  
Tulsa, City of

**Oregon**

Albany, City of  
Clean Water Services  
Eugene, City of  
Gresham, City of  
Portland, City of Bureau of Environmental Services  
Lake Oswego, City of  
Oak Lodge Sanitary District  
Water Environment Services

**Pennsylvania**

Hemlock Municipal Sewer Cooperative (HMSC)  
Philadelphia, City of  
University Area Joint Authority

**South Carolina**

Charleston Water System  
Mount Pleasant Waterworks & Sewer Commission  
Spartanburg Water

**Tennessee**

Cleveland Utilities  
Murfreesboro Water & Sewer Department  
Nashville Metro Water Services

**Texas**

Austin, City of  
Dallas Water Utilities  
Denton, City of  
El Paso Water Utilities

Fort Worth, City of  
Houston, City of  
San Antonio Water System  
Trinity River Authority

**Utah**

Salt Lake City Corporation

**Virginia**

Alexandria Sanitation Authority  
Arlington, County of  
Fairfax, County of  
Hampton Roads Sanitation District  
Hanover, County of  
Henrico, County of  
Hopewell Regional Wastewater Treatment Facility

Loudoun Water

Lynchburg Regional Wastewater Treatment Plant

Prince William County Service Authority

Richmond, City of

Rivanna Water & Sewer Authority

**Washington**

Everett, City of  
King County Department of Natural Resources

Seattle Public Utilities

Sunnyside, Port of

Yakima, City of

**Wisconsin**

Green Bay Metro Sewerage District

Kenosha Water Utility

Madison Metropolitan Sewerage District

Milwaukee Metropolitan Sewerage District

Racine, City of

Sheboygan Regional Wastewater Treatment

Wausau Water Works

**Water Services Association of Australia**

ACTEW Corporation

Barwon Water

Central Highlands Water

City West Water

Coliban Water Corporation

Cradle Mountain Water

Gippsland Water

Gladstone Area Water Board

Gold Coast Water

Gosford City Council

Hunter Water Corporation

Logan Water

Melbourne Water

Moreton Bay Water

Onstream

Power & Water Corporation

Queensland Urban Utilities

SEQ Water

South Australia Water Corporation

Sunshine Coast Water  
Sydney Catchment Authority  
Sydney Water  
Unity Water

Wannon Regional Water Corporation

Watercare Services Limited (NZ) Water Corporation

Western Water

Yarra Valley Water

**Canada**

Edmonton, City of/Edmonton Waste Management Centre of Excellence

Lethbridge, City of

Regina, City of, Saskatchewan

Toronto, City of, Ontario

Winnipeg, City of, Manitoba

**STORMWATER UTILITY****California**

Fresno Metropolitan Flood Control District

Los Angeles, City of, Department of Public Works

Monterey, City of

San Francisco, City & County of

Santa Rosa, City of

Sunnyvale, City of

**Colorado**

Aurora, City of

Boulder, City of

**Florida**

Orlando, City of

**Iowa**

Cedar Rapids Wastewater Facility

Des Moines, City of

**Kansas**

Lenexa, City of

Overland Park, City of

**Kentucky**

Louisville & Jefferson County Metropolitan Sewer District

**Maine**

Portland Water District

**North Carolina**

Charlotte, City of, Stormwater Services

**Pennsylvania**

Philadelphia, City of

**Tennessee**

Chattanooga Stormwater Management

**Texas**

Harris County Flood Control District, Texas

**Washington**

Bellevue Utilities Department  
Seattle Public Utilities

**STATE**

Connecticut Department of Environmental Protection

Kansas Department of Health & Environment

New England Interstate Water Pollution Control Commission (NEIWPCC)

Ohio Environmental Protection Agency

Ohio River Valley Sanitation Commission

Urban Drainage & Flood Control District, CO

**CORPORATE**

ADS LLC

Advanced Data Mining International

AECOM

Alan Plummer & Associates

Alpine Technology Inc.

Aqua-Aerobic Systems Inc.

Aquateam-Norwegian Water Technology Centre A/S

ARCADIS

Associated Engineering  
Bernardin Lochmueller & Associates

Black & Veatch

Blue Water Technologies, Inc.

Brown & Caldwell

Burgess & Niple, Ltd.

Burns & McDonnell

CABE Associates Inc.

The Cadmus Group

Camp Dresser & McKee Inc.

Carollo Engineers Inc.

Carpenter Environmental Associates Inc.

CET Engineering Services

CH2M HILL

CRA Infrastructure & Engineering

CONTECH Stormwater Solutions

D&B/Guarino Engineers, LLC

Damon S. Williams Associates, LLC

Ecovation

EMA Inc.

Environmental Operating Solutions, Inc.

Environ International Corporation

Fay, Spofford, & Thorndike Inc.

Freese & Nichols, Inc.

ftn Associates Inc.

Gannett Fleming Inc.

Garden & Associates, Ltd.

Geosyntec Consultants

GHD Inc.

Global Water Associates

Greeley and Hansen LLC

Hazen & Sawyer, P.C.

HDR Engineering Inc.

HNTB Corporation

Hydromantis Inc.

HydroQual Inc.

Infilco Degremont Inc.

Jason Consultants LLC Inc.

Jordan, Jones, & Goulding Inc.

KCI Technologies Inc.

Kelly & Weaver, P.C.

Kennedy/Jenks Consultants

Larry Walker Associates

LimnoTech Inc.

Lombardo Associates, Inc.

The Low Impact Development Center Inc.

Malcolm Pirnie Inc.

Material Matters, Inc.

McKim & Creed

MWH

NTL Alaska, Inc.

O'Brien & Gere Engineers Inc.

Odor & Corrosion Technology Consultants Inc.

Parametrix Inc.

Parsons

Post, Buckley, Schuh & Jernigan Praxair, Inc.

RMC Water & Environment

Ross & Associates Ltd.

SAIC

Siemens Water Technologies

The Soap & Detergent Association

Smith & Loveless, Inc.

Southeast Environmental Engineering, LLC

Stone Environmental Inc.

Stratus Consulting Inc.

Synagro Technologies Inc.

Tetra Tech Inc.

Trojan Technologies Inc.

Trussell Technologies, Inc.

URS Corporation

Wallingford Software

Westin Engineering Inc.

Wright Water Engineers

Zoeller Pump Company

**INDUSTRY**

American Electric Power

American Water

Anglian Water Services, Ltd.

Chevron Energy Technology

The Coca-Cola Company

Dow Chemical Company

DuPont Company

Eastman Chemical Company

Eli Lilly & Company

InsinkErator

Johnson & Johnson

Merck & Company Inc.

Procter & Gamble Company

Suez Environment

United Utilities North West (UUNW)

United Water Services LLC

Veolia Water North America

**Note: List as of 4/20/10**

## WERF Board of Directors

---

<b>Chair</b> Alan H. Vicory, Jr., P.E., BCEE Ohio River Valley Water Sanitation Co	Patricia J. Anderson, P.E. Florida Department of Health  Jeanette A. Brown, P.E., BCEE, D.WRE Stamford Water Pollution Control Authority  Catherine R. Gerali Metro Wastewater Reclamation District  Charles N. Haas, Ph.D., BCEEM Drexel University  Stephen R. Maquin Sanitation Districts of Los Angeles County	Karen L. Pallansch, P.E., BCEE Alexandria Sanitation Authority  Robert A. Reich, P.E. DuPont Company  R. Rhodes Trussell, Ph.D., P.E. Trussell Technologies Inc.  Rebecca F. West Spartanburg Water  Brian L. Wheeler Toho Water Authority  Joseph E. Zuback Global Water Advisors, Inc.	<b>Executive Director</b> Glenn Reinhardt
<b>Vice-Chair</b> William P. Dee, P.E., BCEE Malcolm Pirnie, Inc.			
<b>Secretary</b> William J. Bertera Water Environment Federation			
<b>Treasurer</b> Jeff Taylor Freese and Nichols, Inc.			

## WERF Research Council

---

<b>Chair</b> Karen L. Pallansch, P.E., BCEE Alexandria Sanitation Authority	William J. Cooper, Ph.D. University of California- Irvine  Ann Farrell, P.E. Central Contra Costa Sanitary District (CCCSD)	James A. Hanlon U.S. Environmental Protection Agency  James A. Hodges, CPEng. Watercare Services Limited	Terry L. Johnson, Ph.D., P.E., BCEE Black & Veatch Corporation  Beverley M. Stinson, Ph.D. AECOM  Susan J. Sullivan New England Interstate Water Pollution Control Commission (NEIWPC)
<b>Vice-Chair</b> John B. Barber, Ph.D. Eastman Chemical Company	Robbin W. Finch Boise, City of  Thomas Granato, Ph.D. Metropolitan Water Reclamation District of Greater Chicago	David Jenkins, Ph.D. University of California at Berkeley  Lloyd W. Johnson, M.P.D., P.E. Aqua-Aerobic Systems, Inc.	

Attachment B

# WERF Product Order Form

As a benefit of joining the Water Environment Research Foundation, subscribers are entitled to receive one complimentary copy of all final reports and other products. Additional copies are available at cost (usually \$10). To order your complimentary copy of a report, please write "free" in the unit price column. WERF keeps track of all orders. If the charge differs from what is shown here, we will call to confirm the total before processing.

Name	Title		
Organization			
Address			
City	State	Zip Code	Country
Phone	Fax	Email	

Stock #	Product	Quantity	Unit Price	Total

### Method of Payment:

 (All orders must be prepaid.)

- C check or Money Order Enclosed  
 Visa       Mastercard       American Express

Account No.	Exp. Date
Signature	

Postage & Handling  
 VA Residents Add  
 5% Sales Tax  
 Canadian Residents  
 Add 7% GST

**TOTAL**

### Shipping & Handling:

Amount of Order	United States	Canada & Mexico	All Others
Up to but not more than:	Add:	Add:	Add:
\$20.00	\$7.50*	\$9.50	50% of amount
30.00	8.00	9.50	40% of amount
40.00	8.50	9.50	
50.00	9.00	18.00	
60.00	10.00	18.00	
80.00	11.00	18.00	
100.00	13.00	24.00	
150.00	15.00	35.00	
200.00	18.00	40.00	
More than \$200.00	Add 20% of order	Add 20% of order	
* minimum amount for all orders			

### To Order (Subscribers Only):

Log on to [www.werf.org](http://www.werf.org) and click on "Publications."

Phone: 571-384-2100  
 Fax : 703-299-0742

WERF  
 Attn: Subscriber Services  
 635 Slaters Lane  
 Alexandria, VA 22314-1177

### To Order (Non-Subscribers):

Non-subscribers may order WERF publications either through WERF or IWAP ([www.iwapublishing.com](http://www.iwapublishing.com)). Visit WERF's website at [www.werf.org](http://www.werf.org) for details.

Make checks payable to the Water Environment Research Foundation.

Attachment B



Water Environment Research Foundation

635 Slaters Lane, Suite G-110 ■ Alexandria, VA 22314-1177

Phone: 571-384-2100 ■ Fax: 703-299-0742 ■ Email: [werf@werf.org](mailto:werf@werf.org)

[www.werf.org](http://www.werf.org)

WERF Stock No U4R07a





# Attachment C



Water Environment Research Foundation  
*Collaboration. Innovation. Results.*

Decentralized



**FINAL  
REPORT**

# Evaluation of Greenhouse Gas Emissions from Septic Systems

Co-published by



**DEC1R09**

**EVALUATION OF  
GREENHOUSE GAS EMISSIONS  
FROM SEPTIC SYSTEMS**

by:

**Harold L. Leverenz, P.E., Ph.D.  
George Tchobanoglous, P.E., Ph.D.  
Jeannie L. Darby, P.E., Ph.D.**  
University of California, Davis

***2010***



## Attachment C

The Water Environment Research Foundation, a not-for-profit organization, funds and manages water quality research for its subscribers through a diverse public-private partnership between municipal utilities, corporations, academia, industry, and the federal government. WERF subscribers include municipal and regional water and wastewater utilities, industrial corporations, environmental engineering firms, and others that share a commitment to cost-effective water quality solutions. WERF is dedicated to advancing science and technology addressing water quality issues as they impact water resources, the atmosphere, the lands, and quality of life.

For more information, contact:  
Water Environment Research Foundation  
635 Slaters Lane, Suite G-110  
Alexandria, VA 22314-1177  
Tel: (571) 384-2100  
Fax: (703) 299-0742  
[www.werf.org](http://www.werf.org)  
[werf@werf.org](mailto:werf@werf.org)

This report was co-published by the following organization.

IWA Publishing  
Alliance House, 12 Caxton Street  
London SW1H 0QS, United Kingdom  
Tel: +44 (0) 20 7654 5500  
Fax: +44 (0) 20 7654 5555  
[www.iwapublishing.com](http://www.iwapublishing.com)  
[publications@iwap.co.uk](mailto:publications@iwap.co.uk)

© Copyright 2010 by the Water Environment Research Foundation. All rights reserved. Permission to copy must be obtained from the Water Environment Research Foundation.

Library of Congress Catalog Card Number: 2010903239

Printed in the United States of America

IWAP ISBN: 978-1-84339-616-1/1-84339-616-5

This report was prepared by the organization(s) named below as an account of work sponsored by the Water Environment Research Foundation (WERF). Neither WERF, members of WERF, the organization(s) named below, nor any person acting on their behalf: (a) makes any warranty, express or implied, with respect to the use of any information, apparatus, method, or process disclosed in this report or that such use may not infringe on privately owned rights; or (b) assumes any liabilities with respect to the use of, or for damages resulting from the use of, any information, apparatus, method, or process disclosed in this report.

University of California, Davis

The research on which this report is based was developed, in part, by the United States Environmental Protection Agency (EPA) through Cooperative Agreement No. X-830851-01 with the Water Environment Research Foundation (WERF). However, the views expressed in this document are not necessarily those of the EPA and EPA does not endorse any products or commercial services mentioned in this publication. This report is a publication of WERF, not EPA. Funds awarded under the Cooperative Agreement cited above were not used for editorial services, reproduction, printing, or distribution.

This document was reviewed by a panel of independent experts selected by WERF. Mention of trade names or commercial products or services does not constitute endorsement or recommendations for use. Similarly, omission of products or trade names indicates nothing concerning WERF's or EPA's positions regarding product effectiveness or applicability.

## ACKNOWLEDGMENTS

The assistance and feedback from the WERF Program Directors and Project Subcommittee on this project are acknowledged gratefully. Special appreciation is extended to Rebecca Siren, Darrell Creeks, and Jeff Pulfer at the Georgetown Divide Public Utility District and the Auburn Lake Trails community. Assistance and support from Orenco Systems, Rodney Ruskin at Geoflow, Pete Munoz at Natural Systems International, and Barton Kirk at SEEDS was invaluable. At UC Davis, the assistance of Yacov Assa, Heather Dang, Cynthia Kallenbach, and Ugo Eke in the laboratory and field testing, their contribution to this project is greatly appreciated.

### Research Team

#### Co-Principal Investigators:

Harold L. Leverenz, P.E, Ph.D.  
George Tchobanoglous, P.E, Ph.D.  
Jeannie L. Darby, P.E, Ph.D.  
*University of California, Davis*

#### Project Team:

Libia R. Diaz-Valbuena, M.S.  
Christopher D. Cappa, Ph.D.  
William R. Horwath, Ph.D.  
*University of California, Davis*

### WERF Project Subcommittee

Kartik Chandran, Ph.D.  
*Assistant Professor, Columbia University*

James Kreissl  
*Environmental Consultant*

Dick Otis, P.E., Ph.D.  
*Otis Environmental Consultants, LLC*

Jim Pyne  
*Hampton Roads Sanitary District*

James E. Smith, D.Sc.  
*United States Environmental Protection Agency*

### Water Environment Research Foundation Staff

**Director of Research:** Daniel M. Woltering, Ph.D.  
**Senior Program Director:** Lauren Fillmore, M.Sc.

## ABSTRACT AND BENEFITS

### Abstract:

This study determined the emission rates of greenhouse gases (GHGs) from individual onsite septic systems used for the management of domestic wastewater. A static flux chamber method was used to measure the emission rates of methane, carbon dioxide, and nitrous oxide gases from eight septic tanks and two soil dispersal systems. A technique developed for the measurement of gas flow and concentration at clean-out ports was used to determine the mass flow of gases moving through the household drainage and vent system. There was general agreement in the methane emission rates for the flux chamber and vent system methods. Several sources of variability in the emission rates were also identified.

The septic tank was the primary source of methane, whereas the soil dispersal system was the principal source of carbon dioxide and nitrous oxide emissions. Methane concentrations from the soil dispersal system were found to be near ambient concentrations, similarly negligible amounts of nitrous oxide were found in the septic tank. All emissions originating in the soil dispersal system were discharged through the building vent as a result of natural, wind-induced flow. The gaseous emission rate data were determined to be geometrically distributed. The geometric mean and standard deviation ( $s_g$ ) of the total atmospheric emission rates for methane, carbon dioxide, and nitrous oxide based on samples from the vent system were estimated to be 10.7 ( $s_g = 1.65$ ), 335 ( $s_g = 2.13$ ), and 0.20 ( $s_g = 3.62$ ) g/capita·d, respectively. The corresponding total anthropogenic CO<sub>2</sub> equivalence (CO<sub>2</sub>e) of the GHG emissions to the atmosphere, is about 0.1 tonne CO<sub>2</sub>e/capita·yr.

### Benefits:

- ◆ Provides methods to determine the GHG emission rates from septic tanks, venting systems, and soil dispersal systems.
- ◆ Improves upon the estimation of GHG emission rates from septic tank systems.
- ◆ Provides the atmospheric emission rate values for future GHG inventories from septic tank systems in California.
- ◆ Examines the GHG generation pathways in typical septic tank system.
- ◆ Identifies sources of variability in the GHG emission rates that can be used as a basis for future studies.

**Keywords:** Onsite wastewater treatment system, anaerobic, flux chambers, greenhouse gases, methane, carbon dioxide, nitrous oxide, septic tank, vent system, soil dispersal system.

# TABLE OF CONTENTS

Acknowledgments.....	iii
Abstract and Benefits.....	iv
List of Tables.....	viii
List of Figures.....	ix
List of Acronyms.....	xi
Executive Summary.....	ES-1
<b>1.0 Introduction.....</b>	<b>1-1</b>
1.1 Background and Motivation.....	1-1
1.2 Project Objectives.....	1-1
1.3 Project Approach.....	1-2
1.4 Report Organization.....	1-2
<b>2.0 Literature Review.....</b>	<b>2-1</b>
2.1 Overview of Septic Tank Systems.....	2-1
2.1.1 Historical Background.....	2-1
2.1.2 Onsite Wastewater Treatment Systems.....	2-1
2.1.3 Gas Emission from Septic Tanks.....	2-3
2.1.4 Venting Systems.....	2-3
2.1.5 Effluent Dispersal.....	2-3
2.2 Septic Tank Characteristics.....	2-4
2.2.1 Process Configuration.....	2-4
2.2.2 Tank Hydraulics.....	2-5
2.2.3 General Conversion Processes Occurring in Septic Tanks.....	2-6
2.2.4 Invertebrate Communities in Septic Tanks.....	2-7
2.2.5 Operation and Maintenance.....	2-7
2.3 Anaerobic Processes.....	2-10
2.3.1 Anaerobic Oxidation.....	2-10
2.3.2 Operational Parameters in Anaerobic Reactors.....	2-12
2.3.3 Toxic Compounds in Anaerobic Reactors.....	2-15
2.4 Gas Emissions from Septic Systems.....	2-18
2.4.1 Gas Formation and Temperature Influence in Septic Tanks.....	2-18
2.4.2 Gas Collection Techniques and Chamber Systems.....	2-19
2.4.3 Results from Previous Gas Measurement Studies.....	2-20
2.4.4 Estimates of Methane Production.....	2-21
2.4.5 Gases in Effluent Dispersal Systems.....	2-24
2.5 Summary of GHG Emissions from Wastewater Systems.....	2-24
2.5.1 Observations of GHG Emissions from Wastewater Treatment Plants.....	2-24
2.5.2 Relative Importance of the Septic Tank Gas Emissions.....	2-25
<b>3.0 Materials and Methods.....</b>	<b>3-1</b>
3.1 Design of Sampling Devices.....	3-1
3.1.1 Flux Chamber Designed for Use in Septic Tanks.....	3-1

3.1.2	Flux Chamber Inserts for Septic Tanks .....	3-2
3.1.3	Flux Chamber Design for Use in Soil.....	3-4
3.1.4	Flux Chamber Inserts for the Soil.....	3-4
3.1.5	Vent Sampling Device .....	3-4
3.2	Sampling Protocols.....	3-6
3.2.1	Sampling Method for Liquid Surfaces.....	3-6
3.2.2	Sampling Method for Soil Systems .....	3-7
3.2.3	Sampling Method for Vent System.....	3-8
3.2.4	Sampling Method for Aqueous Methane.....	3-8
3.2.5	Sampling Method for Water Temperature.....	3-9
3.2.6	Sampling Method for Water Quality .....	3-9
3.2.7	Sludge and Scum Thickness .....	3-9
3.2.8	General Observations.....	3-9
3.3	Gas Analysis .....	3-10
3.4	Quality Control for the Samples .....	3-10
3.5	Data Analysis.....	3-11
3.5.1	Data from Septic Tanks .....	3-11
3.5.2	Data from the Soil Dispersal System .....	3-11
3.5.3	Data from the Vent System.....	3-12
<b>4.0</b>	<b>Description of Field Sites.....</b>	<b>4-1</b>
4.1	Site and Septic Tank Selection .....	4-1
4.2	General Site Characteristics.....	4-1
4.3	Description of Individual Site Characteristics .....	4-2
4.4	Sampling Schedule.....	4-5
4.5	Preparation for Field Sampling.....	4-6
<b>5.0</b>	<b>Results and Discussion.....</b>	<b>5-1</b>
5.1	GHG Emissions from Septic Systems .....	5-1
5.1.1	GHG Emissions from Septic Tanks as Measured Using Flux Chambers..	5-1
5.1.2	GHG Emissions Measured Using the Vent Method .....	5-3
5.1.3	Gas Concentrations in the Septic Tank Liquid Samples.....	5-3
5.1.4	Gas Emissions from Soil Dispersal Systems .....	5-4
5.2	Mass Balance Analysis .....	5-4
5.2.1	Mass Balance on the Septic Tank .....	5- 5
5.2.2	Mass Balance on the Septic System.....	5-7
5.2.3	Mass Balance in the Soil Dispersal System.....	5-9
5.2.4	Percentage of Methane and Carbon Dioxide in the Overall Emissions ...	5-10
5.3	Sources of Variability in Gas Emissions .....	5-11
5.3.1	Water Hardness Influence on Carbon Dioxide Emissions.....	5-11
5.3.2	Influence of Scum Layer on Gas Emissions .....	5-11
5.3.3	Emissions from the Recently Cleaned Tank.....	5-11
5.3.4	Influence of Turnover Event on Septic Tank Gas Emissions.....	5-13
5.3.5	Variability in Daily GHG Emissions .....	5-13
5.3.6	Relation between Invertebrates and Scum Layer.....	5-14
5.3.7	Temperature Influence on Gas Emissions .....	5-14
5.3.8	Influence of the Effluent Filter in the Venting System.....	5-15



<b>6.0</b>	<b>Implication of Results</b> .....	6-1
6.1	Comparison of Gas Emissions to Literature Values and Models .....	6-1
6.2	CO <sub>2</sub> Equivalent of Gas Emission Values.....	6-2
<b>7.0</b>	<b>Findings and Recommendations</b> .....	7-1
7.1	Major Findings.....	7-1
7.2	Other Findings .....	7-1
7.3	Recommendations.....	7-2
Appendix A: COD Loading per Cubic Meter Calculation in Septic Tanks.....		A-1
Appendix B: Estimate of Methane Emissions from Septic Tank System Based on VSS and COD Loading .....		B-1
Appendix C: Estimate of Methane Emissions from Septic Tank System Based on IPCC Methodology .....		C-1
Appendix D: Estimate of Methane Emissions from Septic Tank System Based on Sasse (1998)....		D-1
Appendix E: Vial Vacuuming Procedure .....		E-1
Appendix F: Sampling Forms for the Different Components of the Septic System .....		F-1
Appendix G: Sample of Linear Fit for Methane and Carbon Dioxide Fluxes .....		G-1
Appendix H: Field Data .....		H-1
Appendix I: Calculation of COD in Terms of CO <sub>2</sub> for Mass Balance on the Soil Dispersal System....		I-1
References.....		R-1

## LIST OF TABLES

ES-1	Summary of Methane Emission Rates Including the Flux Chamber Method .....	ES-2
ES-2	Comparison of GHG Emission Rates as CO <sub>2</sub> e from the Septic Tank and Vent Average Measurements.....	ES-2
2-1	Recommended Hydraulic Retention Time in Septic Tanks.....	2-5
2-2	Summary of Factors Affecting the Accumulation of Sludge and Scum in Septic Tanks.....	2-8
2-3	Summary of Septic Tank Pumping Guidelines Reported in the Literature .....	2-10
2-4	Optimum Conditions for Anaerobic Treatment.....	2-13
2-5	Common Electron Acceptors, Products, and Redox Potentials.....	2-13
2-6	Typical Operating Parameters for Single-Stage Complete Mix Anaerobic Digester and Septic Tank .....	2-15
2-7	Cation Concentrations that Cause Inhibitory and Stimulatory Effects on Anaerobic Processes .....	2-16
2-8	Inhibitory Sulfate Concentrations for Anaerobic Processes .....	2-16
2-9	Estimates of Methane Emission Rates from Septic Tank Liquid Surface .....	2-22
2-10	Summary of Dissolved Methane Measured at Three WWTPs in Australia .....	2-25
3-1	Chamber Size Used in Each Site by Septic Tank Compartment .....	3-2
4-1	General Characteristics of the Septic Tanks in the Study Group.....	4-2
4-2	Physical Characteristics of the Eight Septic Tanks Systems Used in the GHG Emissions Study .....	4-3
4-3	Sampling Time, Locations, and Frequency. ....	4-5
5-1	Comparison between Mass Balance Values and Actual Flux Measurements for Site ....	5-7
5-2	Results of the Mass Balance Analysis on the Emission Rates from Septic Systems .....	5-9
6-1	Summary of Methane Emission Rates Including the Flux Chamber Method .....	6-1
6-2	Summary of Emission Rates as CO <sub>2</sub> e from the Septic Tank and Vent Average Measurements.....	6-2

## LIST OF FIGURES

2-1	Illustration of the Mouras Automatic Scavenger .....	2-2
2-2	Onsite Wastewater Treatment System Consisting of a Septic Tank and Soil Dispersal System.....	2-2
2-3	Sectional View of Dual Compartment Septic Tank.....	2-4
2-4	Sludge and Scum Accumulation Rates from Different Studies.....	2-9
2-5	The Stages of Anaerobic Decomposition, Waste Conversion Followed by Waste Stabilization .....	2-11
2-6	The Intermediate Steps of Anaerobic Reactions, with Percentages Based on COD Conversion.....	2-12
2-7	Sulfate Reaction with Metals in a Septic Tank.....	2-17
2-8	Average Monthly Temperature in Septic Tanks Located in (a) San Francisco Bay Area, U.S., (b) Quebec, Canada, and (c) Kansas.....	2-18
2-9	Flux Chamber Designed by the USDA-ARS GRACEnet to Measure Gas Fluxes from Soil Systems. Note the Venting Tube and PVC Materials are Common Features in Flux Chambers .....	2-20
2-10	Relationship between Methane Emissions Rates From Liquid Surface of Community Septic Tank and Water Temperature .....	2-23
2-11	Monthly Methane Emission Rate from Liquid Surface of Community Septic Tank.....	2-23
3-1	Flux Chamber Developed to Sample Gases from Liquid Surfaces: (a) Side View of the Flux Chamber and (b) Internal View of the Flux Chamber Where the Fan and Internal Vent are Visible .....	3-1
3-2	Example of Insert Used for Gas Sampling from Septic Tanks with Scum Layer (a) View of 6 and 12 Inch Insert and (b) Close-up View of 12-inch Insert.....	3-3
3-3	Sampling Device Used to Obtain Gas Samples Through Scum note the Placement of the Flux Chambers and Inserts.....	3-3
3-4	Flux Chamber Designed for Testing Gases from the Leach Field.....	3-4
3-5	Device Developed to Sample Gases from the Cleanout Vent (a) Main Body of the Device and Anemometer and (b) View of the PVC Pipes Sleeves, (c) Profile and (d) Plant of the Vent Sampling Device. Not at Sacle, and (e) Illustration of Technique Developed to Sample Vent Gases .....	3-5
3-6	Use of Flux Chamber for Gas Sampling from Septic Tank Located in Cool, CA (a) Deployment of Flux Chamber Into First Compartment of 1200 Gallon Septic Tank and (b) Extraction of Headspace Sample From Flux Chamber Using Syringe.....	3-6

Attachment C

3-7	Use of Flux Chamber in the Soil Dispersal System (a) Permanent Insert and (b) Extraction of the Headspace Sample from the Flux Chamber .....	3-7
3-8	Sampling of Gases from the Venting System .....	3-8
3-9	Sludge Measurement Taken at Site 4. The Red Marks are Located Every Foot .....	3-10
5-1	Emissions Rate Values Measured Using Flux Chambers in Septic Tanks for (a) Methane from Sites 1 to 7, Excluding Site 4, and from Site 8 and (b) Carbon Dioxide at Sites 1 to 7, Excluding 4 and from Site 8 .....	5-2
5-2	Comparison of Methane Emissions Rates Using the Flux Chamber and Vent Method for Sites 1, 2 and 7 .....	5-3
5-3	Comparison of Gas Emission Rates from Septic Tanks and from Dissolved Gases in the Septic Tank Effluent: (a) Methane and (b) Carbon Dioxide.....	5-5
5-4	Definition Sketch for Mass Balance for Gases Moving Through the Septic Tank .....	5-6
5-5	Comparison of Methane Emission Rates from the Venting System.....	5-7
5-6	Definition Sketch for Mass Balance for Total Gas Emission Rate from the Septic System.....	5-8
5-7	Mass Balance on the Soil Dispersal System .....	5-9
5-8	Percent Methane in the Gas Mixture at All the Sites.....	5-10
5-9	Gas Emission Rates Results Grouped Based on Presence of Scum (a) Methane (b) Carbon Dioxide .....	5-12
5-10	Views of Tank at Site 1 (a) Just Before and (b) During a Turnover Event .....	5-13
5-11	Emission Rates from Site 8 During the Two 24-hour Sampling Events for Methane and Carbon Dioxide .....	5-14
5-12	Comparison of the Average Gas Emission Rates and the Liquid Temperature: (a) Methane and (b) Carbon Dioxide Emission Rates at Sites 1 to 7, (c) Methane and (d) and Carbon Dioxide Emission Rates at Site 1 to 8 .....	5-15
5-13	Views of the Effluent Filters: (a) Filter in Effluent Tee and (b) Comparison of Two Types of Filters. Internal Elements of the Filter are Removed for Viewing .....	5-16

## LIST OF ACRONYMS

AB	Assembly Bill
ALT	Auburn Lake Trails
BOD <sub>u</sub>	Ultimate carbonaceous oxygen demand
COD	Chemical oxygen demand
ECD	Electron capture detector
FC	Flux chamber
FTIR	Fourier transform infrared
GC	Gas chromatograph
GDPUD	Georgetown Divide Public Utility District
GHG	Greenhouse gas
GWP	Global warming potential
HRT	Hydraulic residence time
IPCC	Intergovernmental Panel on Climate Change
LCA	Life cycle assessment
MB	Mass balance
M <sub>g</sub>	Geometric mean
mg/L	Milligrams per liter
OD	Oxygen demand
OLR	Organic loading rate
ppb	Parts per billion
ppm	Parts per million
SRB	Sulfate reducing bacteria
s <sub>g</sub>	Geometric standard deviation
SRT	Solids retention time
TDLSS	Tunable diode laser spectroscopy
UASB	Upflow anaerobic sludge blanket
UPC	Uniform plumbing code
USDA	United States Department of Agriculture
U.S. EPA	United States Environmental Protection Agency
VFA	Volatile fatty acid
VSS	Volatile suspended solid
WWTP	Wastewater treatment plant



## EXECUTIVE SUMMARY

Methane has been identified as a potent greenhouse gas (GHG), with an equivalent effect 25 times that of carbon dioxide (IPCC, 2007). Based on the IPCC methodology, the U.S. EPA (2009) has determined that a significant amount of the methane emissions associated with wastewater originate from onsite septic tank systems due to the large number of individual septic systems now in use and the high methane emission rates predicted using the IPCC method. However, the actual data currently available on the emission of methane from septic tank systems are insufficient to produce an accurate greenhouse gas inventory for these systems. Thus, the principal objective of this research was to obtain more accurate data on GHG emissions from conventional septic tank systems, with a focus on methane emissions. To accomplish the objective, this project consisted of a literature review, construction of flux chambers, development of sampling techniques and protocols for gas sampling from septic tank system and ventilation systems, identification and selection of field sites, collection of gas samples, data analysis, and estimation of the GHG emission rate values.

### Methodology

For this study, flux chambers and a corresponding sampling methodology were used to measure the GHG emission rates from conventional septic tank systems. The flux chamber method was also used for gas sampling of soil dispersal systems. In addition, a sampling device and methodology were developed to measure the mass flow of GHGs through drainage and ventilation systems. Based on the flux chamber and vent sampling data, emission rates of methane, carbon dioxide, and nitrous oxide from septic tank systems were estimated.

### Results

In total, eight septic tanks were sampled for the production of gases from the tank contents using flux chambers. While methane production is attributed to anaerobic reactions occurring primarily in the sludge layer, carbon dioxide emissions result from anaerobic, facultative, and aerobic reactions. Methane and carbon dioxide were the primary GHGs found in emissions from the septic tank, while carbon dioxide and nitrous oxide were the primary GHGs from the soil dispersal system.

The septic tank methane flux values determined by the flux chamber method were found to be log-normally distributed, with a geometric mean ( $M_g$ ) of 11.0 g/capita·d and geometric standard deviation ( $s_g$ ) of 2.50. The geometric mean of the methane flux values from individual septic tanks was found to range from 6.3 ( $s_g = 1.40$ ) to 17.9 ( $s_g = 1.94$ ) g/capita·d, excluding results from one site that had the septic tank pumped recently. A summary of the methane emission rate values found in the literature and measured values using the flux chamber from this study are presented in Table ES-1.

The average rate of methane emission measured with the flux chamber is not in agreement with the IPCC (2007), Winneberger (1984), and Sasse (1998) models. One reason for the difference between the measurements presented here and those determined from the IPCC (2007) model is that the IPCC (2007) model assumes that half of the influent COD to the septic

tank is converted anaerobically. Further, the fate of organic matter present in septage and septic tank effluent is not accounted for clearly. It is likely that the measurements made by Winneberger (1984) are high because not enough samples were obtained to establish a statistical distribution. The values used in the Sasse (1998) model were based on statistics from septic tanks located in developing countries, which operate at higher temperatures and loading rates, resulting in higher methane emissions.

**Table ES-1. Summary of Methane Emission Rates Including the Flux Chamber Method.**

Method	Year	Methane estimate (g CH <sub>4</sub> /capita·d)
Kinnicutt et al.	1910	10.1 <sup>a</sup>
Winneberger	1984	14 to 18 <sup>a</sup>
COD loading	2009	11 <sup>b</sup>
IPCC	2007	25.5 <sup>c</sup>
Sasse	1998	18 <sup>d</sup>
This study	2009	11.0 (s <sub>g</sub> = 2.50) <sup>a,e</sup>

<sup>a</sup> Measured value.

<sup>b</sup> Calculated value assuming that 40 % of solids are removed as septage.

<sup>c</sup> Calculated value assuming that half of the influent COD is converted anaerobically.

<sup>d</sup> Calculated value assuming 25 % CH<sub>4</sub> dissolved.

<sup>e</sup> Geometric mean and standard deviation as determined using flux chamber method, this study.

The estimated septic tank emission rates reported in terms of CO<sub>2</sub>-equivalent (CO<sub>2</sub>e) emissions are summarized in Table ES-2.

**Table ES-2. Comparison of GHG Emission Rates as CO<sub>2</sub>e from the Septic Tank and Vent Average Measurements.**

Compound	Geometric mean emission rate value (g/capita·d)		GWP <sup>a</sup>	Carbon dioxide equivalent emissions (tonne CO <sub>2</sub> e/capita·year)	
	Septic tank	Septic system <sup>b</sup>		Septic tank	Septic system <sup>b</sup>
Methane	11.0	10.7	21	0.084	0.082
Nitrous oxide	0.005	0.20	310	0.00057	0.023
Carbon dioxide	33.3	335	1	0.012	0.12
Total GHG emissions				0.096	0.23
Total anthropogenic emissions <sup>c</sup>				0.085	0.10

<sup>a</sup> GWP for a 100 year horizon IPCC (1996).

<sup>b</sup> As determined from vent system sampling.

<sup>c</sup> Biogenic carbon dioxide is not included in GHG inventories (U.S. EPA, 2009).



## Major Findings

The principal findings from this research are:

- ◆ The geometric mean of the total emission rates for methane, carbon dioxide, and nitrous oxide based on samples from the vent system were 10.7 ( $s_g = 1.65$ ), 335 ( $s_g = 2.13$ ), and 0.20 ( $s_g = 3.62$ ) g/capita·d, respectively.
- ◆ The CO<sub>2</sub>e of the methane emission rates to the atmosphere, as determined from the vent system data in this study, is about 0.10 tonne/capita·yr. Based on the current estimated per capita CO<sub>2</sub>e emission rate for the United States (i.e., 23 tonne CO<sub>2</sub>e/capita·yr; U.S. EPA, 2010), the septic tank accounts for about 0.5 percent of the total per capita emission.
- ◆ The septic tank methane flux values determined by the flux chamber method were found to be log-normally distributed, with a geometric mean ( $M_g$ ) of 11.0 g/capita·d and geometric standard deviation ( $s_g$ ) of 2.50. Similarly, the values of  $M_g$  for carbon dioxide and nitrous oxide were 33.3 ( $s_g = 2.73$ ) and 0.005 ( $s_g = 4.35$ ) g/capita·d, respectively.

## Other Findings

Other findings from this research are:

- ◆ There was general agreement for methane gas emission rates determined with theoretical models and measured with the flux chamber and vent methods.
- ◆ There is considerable variability in the methane gas fluxes from tank to tank and sample to sample.
- ◆ The hardness of the water supply appears to influence the overall flux of carbon dioxide, with soft water systems having higher carbon dioxide gas fluxes.
- ◆ A correlation between the GHG emission rates from the septic tank and the liquid temperature was not observed, perhaps as a result of the limited duration of the study.
- ◆ The presence or absence of a scum layer had no discernable influence on emission rates of methane and carbon dioxide.
- ◆ The carbon (measured as COD) in the septic tank effluent discharged to the soil dispersal system was approximately equal to the amount of carbon being vented (measured as carbon dioxide) from the soil dispersal system.
- ◆ Methane generated during the anaerobic digestion process was found in both gaseous and aqueous forms but no relation was found between the gas and liquid phase concentrations.
- ◆ Nitrous oxide emission rates from septic tanks were found to be negligible; however nitrous oxide was detected in the gases vented from the soil dispersal system.
- ◆ Essentially no gas emissions from the soil surface were measured using flux chambers placed above the soil dispersal system trenches.
- ◆ Using the mean methane emission value measured for the septic tanks from this project, an MCF value of 0.22 was calculated.

## **Recommendations**

Based on the findings of this research, the following recommendations are proposed for future studies of greenhouse gas emissions from septic tank systems:

- ◆ Due to the uncertainty in several operational parameters, such as temperature and water hardness, and their influence on the production of septic tank gases, further study in other regions of the country is recommended.
- ◆ In this study, only direct GHG emissions from operational septic systems were evaluated. A follow up study quantifying the GHG emissions associated with various septage management practices is needed.
- ◆ The soil dispersal systems in this study were well drained and did not have any ponding. The evaluation of soil dispersal systems in other soil types and at different stages of ponding is needed. In addition, studies on alternative soil dispersal systems, such as pressure and drip irrigation systems, are needed.
- ◆ Only conventional septic tank systems were evaluated in this study. Additional research is needed to quantify gas emissions from alternative onsite wastewater systems, such as natural treatment systems, packed bed filters, and other aerobic treatment processes.
- ◆ A study is needed to evaluate the development of methanogenesis in septic tanks from the time of start-up, with and without inoculation.
- ◆ The methods for sampling of gases from ventilation systems should be further developed and refined.
- ◆ Further study is needed to develop technologies for the control of GHG emissions from wastewater systems is needed, including soil-based filtration and stand-alone biofiltration processes. Integration of these types of control systems may require slight modifications to the aspects of the building code related to septic tank ventilation systems.
- ◆ A study is needed to determine the correlation between the GHG emissions and the septic tank influent quality and loading.
- ◆ Further work should be conducted to quantify GHG emissions from all types of wastewater management systems so that accurate models can be developed.

## CHAPTER 1.0

# INTRODUCTION

This study was conducted to determine the emission of greenhouse gases (GHGs) from conventional septic tank systems used for the management of domestic wastewater. The project background, objectives, approach, and report organization are discussed below.

### 1.1 Background

Concerns with climate change have led to an effort to reduce the emission of GHGs, especially in the state of California, which has enacted regulations related to GHG inventory and mitigation (i.e., AB 32). Methane has been identified as a potent greenhouse gas; equivalent to 25 times that of carbon dioxide. Similarly, nitrous oxide has a reported potency factor of 298 times that of carbon dioxide (IPCC, 2007). Using the IPCC methodology, the U.S. EPA (2009) has determined that a majority of the methane emissions associated with wastewater originate from conventional septic tank systems, due to the large number of individual septic systems now in use. However, the actual data currently available on the emission of methane from septic systems are insufficient to produce an accurate GHG inventory for these systems.

In the IPCC (2007) method used currently to compute GHG emissions from septic tank system it is assumed that half of the influent organic matter is converted to methane. Using the IPCC model, the carbon dioxide equivalent ( $\text{CO}_2\text{e}$ ) of the methane released from individual domestic septic tanks is about 0.24 tonne  $\text{CO}_2\text{e}/\text{capita}\cdot\text{yr}$ . However, based on historical studies of methane emissions from septic tank systems, the value is estimated to range from about 0.09 to 0.16 tonne  $\text{CO}_2\text{e}/\text{capita}\cdot\text{yr}$ . In addition, these estimates only consider emissions from the septic tank and do not account for emissions from the soil dispersal systems. Thus, there is a need to develop a more detailed model of the production of GHGs from septic tank systems.

### 1.2 Objectives

The principal objective of the research was to obtain more accurate data on GHG emissions from septic tank systems, focusing on methane emissions from conventional septic systems. To achieve the proposed objective the following activities were performed:

- ◆ Extensive literature review on septic tanks and gas formation pathways.
- ◆ Construction of flux chambers and development of a method for gas sampling from septic tanks.
- ◆ Development of sampling techniques and a protocol for gas sampling from septic system drainage and ventilation piping.
- ◆ Identification and selection of appropriate field sites for collection of study data.

- ◆ Collection of gas samples from the septic tank liquid surface, vent system, and soil dispersal system over a six-month period.
- ◆ Analysis of results and determination of estimated GHG emission rate values.

### **1.3 Project Approach**

Methods for the measurement of GHG emissions from soil-plant ecosystems using flux chambers are well established; however, little information is available on gas flux measurements from the liquid/solid surface of septic tanks. Hence, for this research a flux chamber design, based on the design used for soil-based measurements, was constructed and tested, along with the development of a corresponding sampling methodology. The flux chamber method was also used for gas sampling of the soil dispersal system. In addition, a sampling device and methodology were developed to measure the mass flow of GHGs through the vent system. Methane, carbon dioxide, and nitrous oxide emission rates were measured in this study.

### **1.4 Report Organization**

This report is organized into seven chapters. The first chapter provides an introduction and purpose for this project. A detailed literature review on septic tank systems, characteristics, processes, and GHG emissions is presented in Chapter 2.0. The methods employed during and in support of field monitoring are described in Chapter 3.0. A description of the field sites is presented in Chapter 4.0. The results of the gas flux measurements in the septic tank, venting system and soil dispersal system, a mass balance analysis, and the sources of variability in the gas emission rates are discussed in Chapter 5.0. The implications of the results from the research study are presented in Chapter 6.0. Findings and recommendations for further study are summarized in Chapter 7.0. Calculations and support materials are presented in the appendixes.

## CHAPTER 2.0

# LITERATURE REVIEW

To assess the potential for the release of greenhouse gases from septic tanks, the characteristics of onsite systems are reviewed in this chapter. The subjects considered in this review include an overview of the development of septic tank systems, the physical characteristics and operation of septic tanks, the fundamentals of the anaerobic processes occurring in septic tanks, and the information that exists on the emissions from septic tanks and other wastewater sources.

### 2.1 Overview of Septic Tank Systems

The septic tank is one of the oldest units available for the primary treatment of wastewater from decentralized sources. The historical background of the septic tank and its importance in decentralized wastewater treatment systems are discussed in this section. An introductory overview of gaseous emissions from septic tanks is also presented along with a brief description of venting systems and the soil absorption field.

#### 2.1.1 Historical Background

Wastewater from individual buildings and small communities is often managed using onsite wastewater systems when a centralized wastewater collection system is not available. Nearly all onsite wastewater systems incorporate a septic tank for primary treatment of influent wastewater (Crites and Tchobanoglous, 1998). A septic tank is a buried, watertight tank designed and constructed to receive and partially treat raw wastewater (U.S. PHS, 1957; U.S. EPA, 2009). It is estimated that about 25 million septic tanks are currently in use in the United States (U.S. EPA, 2002).

Septic tanks were first reported as wastewater treatment systems in the 1860s in France. The Fosse Mouras automatic scavenger was patented in 1881, based on the work of Abbe Moigno and Louis M. Mouras (Dunbar, 1908; Winneberger, 1984). An illustration of the Fosse Mouras septic treatment process is presented on Figure 2-1. The process configuration since that time remains almost unchanged when compared to modern septic systems (Crites and Tchobanoglous, 1998).

#### 2.1.2 Onsite Wastewater Treatment Systems

The key functions of the septic tank are to separate and retain settleable solids (sludge) and floatables (scum) from the incoming wastewater. Subsequently, the treated wastewater is discharged typically into a soil dispersal system, also known as a leach field. The captured solids are retained in the septic tank and undergo a passive (naturally occurring and uncontrolled) anaerobic digestion (Tchobanoglous and Schroeder, 1985). The combination of septic tank and leach field, shown on Figure 2-2, is the most commonly used onsite wastewater treatment system. Other types of primary treatment processes used in decentralized wastewater systems

include Imhoff tanks, anaerobic baffled reactors, and upflow anaerobic sludge blanket reactors (Crites and Tchobanoglous, 1998; U.S. EPA, 1999). However, these alternative primary treatment processes are not used commonly due to their more complex construction and operation. As shown on Figure 2-2, the septic tank is connected to a building through subsurface drainage pipes and the treated wastewater (septic tank effluent) is discharged to the soil dispersal system (U.S. EPA, 2000).

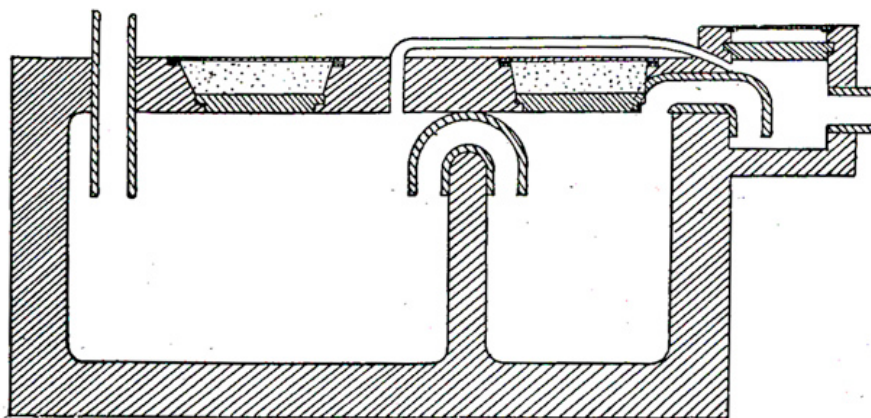

Figure 2-1. Illustration of the Mouras Automatic Scavenger. Adapted from Dunbar, 1908.

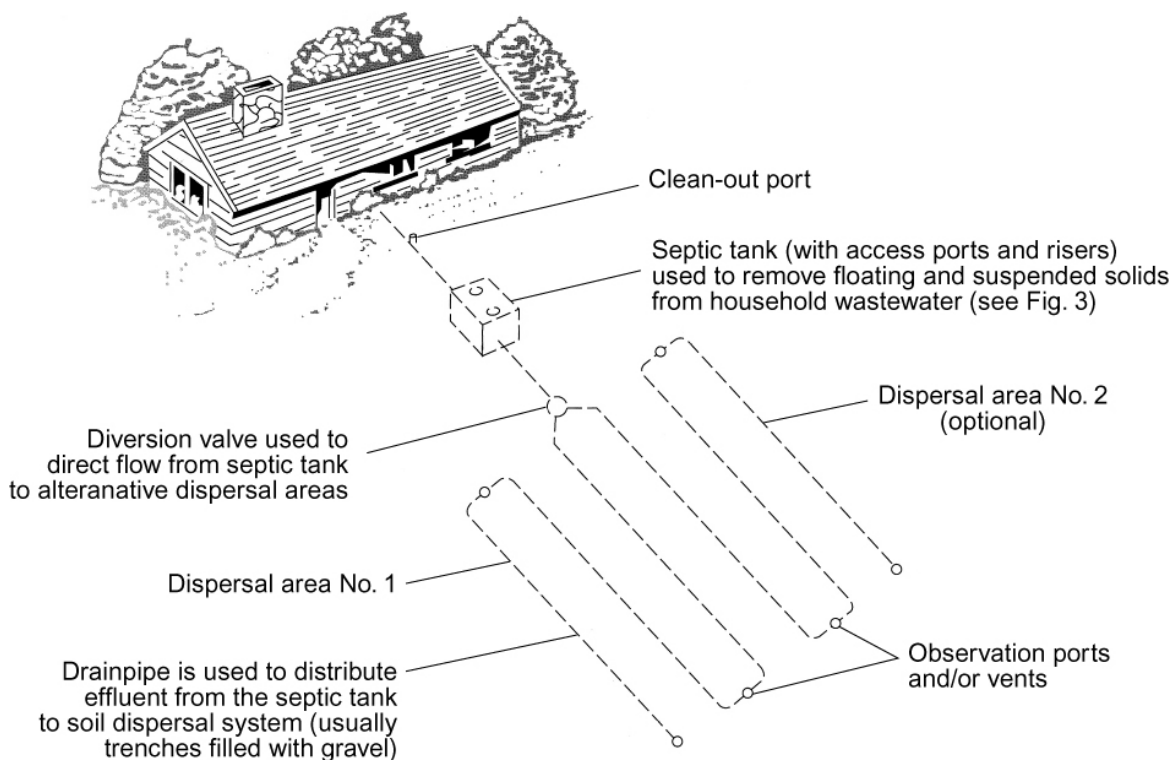

Figure 2-2. Onsite Wastewater Treatment System Consisting of a Septic Tank and Soil Dispersal System. Adapted From Tchobanoglous, G. and F.L. Burton, 1991.

### 2.1.3 Gas Emissions from Septic Tanks

Anaerobic degradation, occurring within the sludge layer of the septic tank, results in the production of gases composed primarily of methane and carbon dioxide. When sulfate compounds are present in the influent wastewater, hydrogen sulfide and other sulfur containing gases may also be formed. Gases formed in the septic tank are evacuated typically from the system through the building drainage plumbing and vent system. Gas emissions are discussed in more detail in Section 2.4.

### 2.1.4 Venting Systems

Building codes require that gases formed inside the septic tank be evacuated by means of a vent system. Household plumbing vents are used generally as vents for the septic tanks. Less commonly, gases may also be vented through the leach field or through screened atmospheric pipes located inside the tank (D'Amato et al., 2008). The two main purposes of tank vents are to avoid wastewater backflow due to a vacuum created inside the house plumbing fixtures and to let toxic, odorous (e.g., hydrogen sulfide, mercaptans), and explosive (e.g., methane) gases formed during the anaerobic degradation escape and be diluted in the atmosphere (Kaplan, 1991).

Gases such as hydrogen sulfide often generate concern due to odor generation, potential human toxicity, and ignition properties (D'Amato et al., 2008; EPA-IRIS, 2009). Nevertheless, based on measurements reported by Winneberger (1984), the hydrogen sulfide concentration from vented tanks are below detection limits and, therefore, gas evacuation throughout venting systems does not represent a fire risk for the household residents. It has been shown that gases in the headspace of the tank escape through the inlet and outlet tees and eventually to the house vents (Winneberger, 1984).

### 2.1.5 Effluent Dispersal

In a conventional septic system, clarified effluent is discharged typically to a soil dispersal system (see Figure 2-2). The soil dispersal system receives the treated wastewater and distributes it into the soil through a perforated pipe system located in gravel filled excavated trenches (U.S. EPA, 2003). The soil operates as a biofilter, where biological, physical, and chemical processes take place. Inorganic and organic compounds may be transformed to various degrees in the soil while pathogens die off.

Operationally, problems can occur in the soil dispersal system when the application of septic tank effluent exceeds the infiltration capacity of the soil. The infiltration capacity of the soil is a function of the soil properties and characteristics of the septic tank effluent. In general, loading of dissolved organic matter supports the growth of biomass that restricts soil pore space, while the loading of particulate matter fills and blocks soil pores (Leverenz et al., 2009). Thus, a high loading of both dissolved and particulate organic matter will result in a reduced infiltration rate. In the extreme case, effluent can surface above the soil dispersal field, which is an indication that the hydraulic loading rate has exceeded the soil infiltration rate for the given loading scenario (Crites and Tchobanoglous, 1998). Proper septic tank design, along with regular monitoring and maintenance, can be used to control the discharge of constituents that will reduce the infiltration capacity. The discharge of chemical and biological constituents to groundwater is also a concern associated with onsite wastewater systems.

## 2.2 Septic Tank Characteristics

Septic tanks are considered simple and effective primary treatment systems; however, there are several important processes that must occur to achieve a satisfactory level of treatment. General system configurations, hydraulics, processes occurring within septic tanks, impacts of invertebrate animals, and a description of the tank operation and maintenance, with a focus on sludge accumulation and solids extraction frequency, are described in this section.

### 2.2.1 Process Configuration

The general configuration of a septic tank is shown on Figure 2-3. The tank liquid capacity varies between 2.8 and 5.6 m<sup>3</sup> (750 and 1500 gal) when used for a single house (Tchobanoglous and Schroeder, 1985), with specific tank sizing based on parameters such as the number of inhabitants, the home maximum occupant capacity, and use of water-saving fixtures (U.S. EPA, 2000). Septic tanks are constructed typically of concrete or fiberglass, but can also be made of polyethylene (Crites and Tchobanoglous, 1998; U.S. EPA, 2000).

As shown on Figure 2-3, most modern septic tanks have access ports or risers at grade for inspection and cleaning activities. Riser lids should be secured or locked to prevent unauthorized access. Septic tanks are generally buried in the ground and must be watertight and structurally sound to prevent leakage and eventual failure (U.S. EPA, 2000). Other components are the inlet tee, effluent filter (optional), and outlet tee, which are designed to retain solids in the tank while allowing the clarified water and gases to move through the tank. Ribbed risers are sometimes not recommended in cold climates where the soil freezing can uplift and displace the risers from the septic tank.

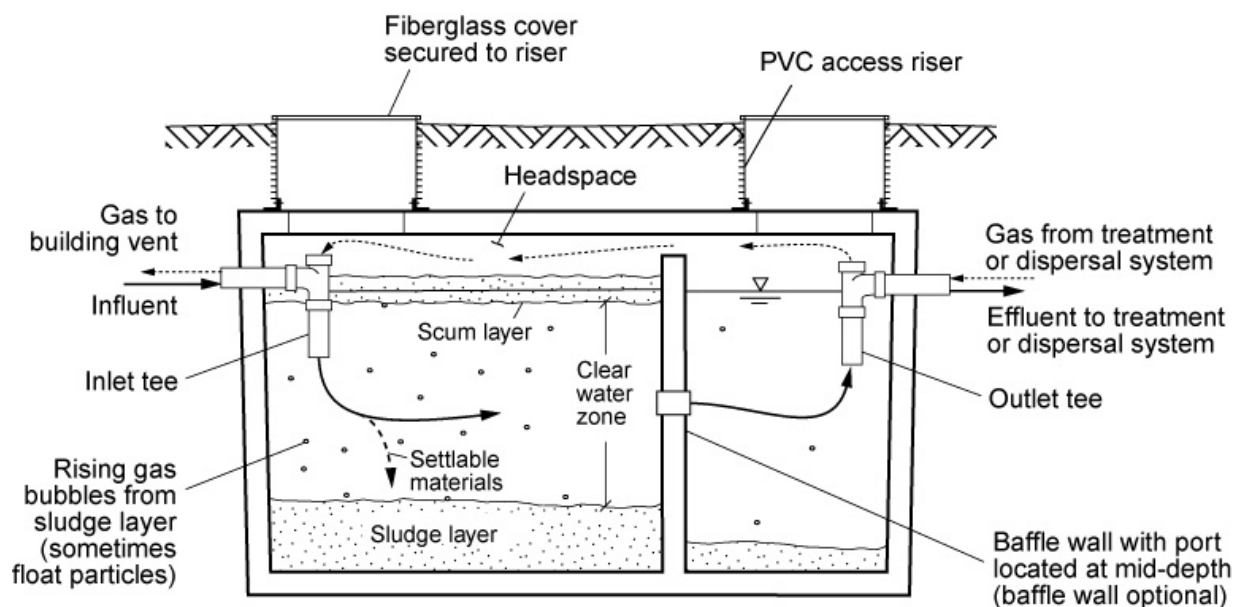

Figure 2-3. Sectional View of Dual Compartment Septic Tank.  
Adapted from Crites and Tchobanoglous, 1998.



### 2.2.2 Tank Hydraulics

A septic tank can have one or two compartments (Crites and Tchobanoglous, 1998). The two-compartment tank is recommended by the uniform plumbing code (UPC) to aid in the retention of solids (Perkins, 1989; D'Amato et al., 2008); however, Winneberger (1984) found that a single compartment tank performed as well, with respect to effluent quality, as a two-compartment model with the same capacity. One explanation is that a single compartment tank has a larger surface area available, and therefore the settling may be more efficient (Crites and Tchobanoglous, 1998). In general, the results of the septic tank compartment findings have been ambiguous due to the lack of long term studies (Bounds, 1997). Different baffle configurations can be used to improve tank hydraulics and facilitate sludge removal.

In general, the tees control the flow of liquids and solids in the tank and act as a pathway for gases to leave the tank into the house vent system. Tees also help to avoid short-circuiting of the wastewater through the tank to the outlet and prevent mixing between the scum and the incoming liquid (Bounds, 1997; U.S. EPA, 2002). The invert elevation of the outlet tee is generally located 2 to 3 inch below the invert elevation of the inlet tee to keep the inlet pipe above the water level. The rising leg of the inlet tee should extend up in length at least 6 inch over the liquid level to prevent the scum layer from clogging the inlet (U.S. EPA, 2000).

The inlet tee (see Figure 2-3) allows the incoming wastewater to be introduced without disturbing the clarification process that is taking place inside the tank (Winneberger, 1984; Perkins, 1989). Further, the tee minimizes short-circuiting (U.S. EPA, 2002) and enhances sedimentation and detention time (Bounds, 1997). The outlet tee prevents scum and floating sludge from passing through and clogging the soil dispersal system (Winneberger 1984; Perkins, 1989).

The hydraulic retention time (HRT) in a septic tank is directly related to the tank geometry. Of tanks with similar volumes, shallow tanks with greater surface area have lower overflow rates and as a result more efficient capture of solids, while deep tanks can store more settled solids (U.S. EPA, 2000; D'Amato et al., 2008). The typical theoretical HRT for septic tanks varies from 24 to 72 hr (D'Amato et al., 2008); higher values of HRT ranging from 60 to 80 hr have also been reported (Walker and Driftmier, 1929). Other studies recommend values ranging from 6 to 24 hr (Winneberger, 1984; Bounds, 1997). A summary of HRT recommendations is presented in Table 2-1.

**Table 2-1. Recommended Hydraulic Retention Time in Septic Tanks.**

Range (hr)	Reference
6 – 24	Winneberger (1984) Bounds (1994)
24 – 72	D'Amato et al. (2008)
60 – 72	Walker and Driftmier (1929)

The actual HRT depends on the geometry, depth, number of compartments, solids volume, and inlet and outlet designs of the septic tank and thus varies greatly from tank to tank (U.S. EPA, 2002). When hydraulic overloading occurs, the usual retention time of the septic tank might not be long enough to allow for effective settling, resulting in solids flow through the tank outlet and obstruction of the effluent dispersal system or downstream process.

### 2.2.3 General Conversion Processes Occurring in Septic Tanks

In a simplistic view, the septic tank operates as a settling basin allowing the influent wastewater particles to settle to the bottom and form a solids layer known as sludge (U.S. EPA, 2003). Greases, oils, and other buoyant particles rise to the water surface and form a scum layer composed of accumulated floating materials (Crites and Tchobanoglous, 1998; U.S. EPA, 2005). As depicted on Figure 2-3, a septic tank would generally have three characteristic layers: scum at the top, a clear zone in the middle, and the sludge layer at the bottom. The clarified water flows between the scum and sludge layers and leaves the septic tank for further treatment (if present) or soil dispersal.

The major mechanism of oxygen demand (OD) removal from septic tank effluent results from the settling of suspended solids from the influent wastewater to the bottom of the tank. While the liquid remains in the tank one or two days (see Table 2-1), the settled solids remain in the tank and undergo anaerobic decomposition over a long period of time, for example 5 to 15 yr (Rittman and McCarty, 2001). The biochemical oxygen demand (BOD) of the septic tank effluent is typically 25-50% less than the BOD of the influent (Crites and Tchobanoglous, 1998; U.S. EPA, 2005).

The proper operation of a septic tank is based, in part, on the development of a facultative and anaerobic environment in which microorganisms perform complex biochemical reactions. The bottom portion of the septic tank behaves, for the most part, as an anaerobic reactor; however, at or near the water surface, the presence of oxygen results in facultative as well as aerobic reactions (D'Amato et al., 2008). Wastewater characteristics such as temperature, organic loading, hydraulic loading, detergents, chemicals, and cleaning products can encourage or inhibit microbial development (Bounds, 1997). For example, it has been reported that gas production and digestion activity in sludge is temporarily inhibited by discharge of water softener brine to septic tanks (Seabloom et al., 2005).

Organic material entering the sludge layer of the septic tank undergoes hydrolysis, where bacteria partially transform complex organic molecules into simple molecules, a process also known as liquefaction (Crites and Tchobanoglous, 1998; D'Amato et al., 2008). Simple organic molecules are then converted to short chain length volatile fatty acids (VFAs) by acid-forming bacteria in a process known as acidogenesis, resulting in a decrease in the water pH. At this point, methanogens begin to convert the VFAs into carbon dioxide and methane in a process called methanogenesis (Crites and Tchobanoglous, 1998; D'Amato et al., 2008). A more detailed description of the methanogenesis process is presented in Section 2.3.

Methanogenesis occurs spontaneously in septic tanks, but the conditions that determine the start of anaerobic digestion have not been elucidated fully. It has been reported that, based on observations of gas production, the methanogenesis activity inside community septic tanks is readily established (Kinnicutt et al., 1910) perhaps due to the high organic loading rate (OLR), but may not reach a peak until two years of operation in a septic tank for an individual home (Philip et al., 1993), which are usually operated at a lower OLR. Weibel et al. (1949) determined that the use of a seed inoculum (anaerobic sludge from an Imhoff tank) added at startup at a rate of about 23 L/capita·d resulted in the rapid development of anaerobic digestion. It should be noted that tank seeding is not practiced commonly.

In studies on septic tanks carried out by Weibel et al. (1955), it was reported that for a small capacity tank started in the winter, a five month lag phase was observed. The lag phase was characterized by low pH and offensive odors, which are associated with hydrolysis and acidification. Methanogenesis began to occur gradually as the temperature increased during summer. The onset of methanogenesis was characterized by increased pH, reduced effluent volatile suspended solids, and a reduction in odor. For the same tank, cleaned out and restarted in the spring, there was a shorter lag phase, which was not accompanied by low pH or offensive odors. Weibel et al. (1955) suggested that the effects of process startup may be less extreme in larger tanks and that a seed inoculum be considered for starting tanks in the winter to avoid odor generation.

Methane can also be consumed by methanotrophic bacteria under aerobic conditions, converting the methane to carbon dioxide. Methane consumption has been observed in some anaerobic/aerobic environments, but has not been measured in septic tank systems. It is reasonable to assume that methanotrophic activity could exist in septic tanks at the air-water or air-scum interface where oxygen and methane are present together (Knowles, 1993).

#### **2.2.4 Invertebrate Communities in Septic Tanks**

Invertebrate communities are commonly found within septic tanks; however the role of the individual species on degradation processes occurring in the tank is not clear. Dunbar (1907) observed that thick scum layers were composed of condensed plant remains, paper, hair, and other residual matter. According to Dunbar, this condensed material was transformed by fungi action (e.g., *Peziza omphalodes*) into a mass, where a variety of invertebrates such as worms, earthworms, and larvae of some insects (in particular, *Psychoda phalloenoides*) were encountered. Nevertheless, a clear relation between the action of invertebrate animals and the scum thickness was not entirely demonstrated.

In a study carried out at Novato, California, it was found that Diptera, Collembola, Acarina, Nematoda, Isopoda, and Oligochaeta are the dominant species living within the septic tanks (Dale, 1982). Dale reported that the thickness of the scum layer was directly related to the number of organisms present. A larger number of organisms corresponded to a thicker layer of scum.

The visual characteristics of the scum depend, in part, on the type of invertebrate animal species present. For example, Dale observed that scum layers had a humus look when *Lumbricidae* were present. Winneberger (1984) also reported that the scum upper layers were usually dark brown to black and had the appearance of “crumbly earth” or humus, and were frequently populated by earthworms. Thus, it appears that the configuration of the scum layers involves more than buoyant solids rising to the liquid surface; some invertebrate animals may also participate in its development, degradation, and thickness.

#### **2.2.5 Operation and Maintenance**

As stated previously, incoming solids accumulate in the tank forming a sludge and scum layer. Sludge and scum accumulation depend on several factors including tank design, the use of garbage grinders, user diet, season of the year, and temperature. These factors and their influence on the sludge accumulation are summarized in Table 2-2. Both scum and sludge layers will

increase in thickness with daily solids additions and eventually the removal of all of the accumulated solids from the tank is necessary to avoid malfunctioning of the system.

Based on a number of studies, it has been found that the sludge and scum accumulation rates are highly influenced by the temperature and season of the year. Walker and Driftmier (1929) reported that the thickest scum measurements were obtained during early summer when increasing temperatures were recorded. Walker and Driftmier (1929) also reported an increase in sludge accumulation during the winter months, when bacterial degradation is hindered by the lower temperatures. These observations also support the concept of the ‘spring boil’, where high rates of gas bubble release are observed (see also Section 2.4.1). During the winter months, when the temperature in the septic tank cools, the rate of digestion slows and solids begin to accumulate, increasing the thickness of the sludge layer. Microbial activity in the sludge layer increases when the tank contents warm during the spring and early summer, resulting in an increase in gas production. Also, the solubility of dissolved gases decreases as the contents of the tank become warmer, also increasing the release of gases. The gas bubbles may rise to the surface individually, but also float solids to the surface. The buoyant solids then become part of the scum layer, thus increasing the thickness of the scum layer, or are discharged with the effluent.

**Table 2-2. Summary of Factors Affecting the Accumulation of Sludge and Scum in Septic Tanks.**

Factor	Summary	Reference
Food waste grinder	A total increase of 77% (210% increase in scum and 31 % increase in sludge) in the amount of sludge and scum from households using food waste grinders.	Weibel et al. (1955)
	The use of food waste grinders enhanced the buildup of scum by 34%, while sludge accumulation increased by 2%.	Bounds (1997)
	Homes with food waste grinders had an increase of total suspended solids in the septic tank of 25 - 40 % compared to houses without them.	U.S. EPA (2002)
	Houses with food waste grinders have been reported to accumulate sludge and scum at a higher rate.	D’Amato et al. (2008)
House occupant diet	It was observed during routine inspections that tanks from household occupants with preferences for vegetarian diets developed thin or no scum layers.	Ball (2009)
	It was observed that the tank for a vegetarian family did not develop a scum layer compared to households with a conventional meat-based diet.	Winneberger (1984)
Season and temperature	Scum thickness increased during highest recorded temperatures of the year (early summer). During winter, when bacterial activity decreased, a thick layer of sludge was noticed.	Walker and Driftmier (1929)
	In cold months (winter season) solids built up rapidly in the bottom of the tank.	Winneberger (1984)
	Solids accumulation rate increased during the winter months.	D’Amato et al. (2008)

Solids accumulation rates are also related to the maintenance of the septic system. Based on these rates, the cleaning frequency of the tank can be determined. Other factors that influence the solids accumulation and pumping frequency are the size of the tank, specific design, number of people in the home, water usage, and household water fixtures (Weibel et al., 1955; Bounds, 1997; U.S. EPA, 2002; D'Amato et al., 2008).

Data on the average rates of sludge and scum accumulation in septic tanks from various studies are summarized on Figure 2-4 (Bounds, 1997; Crites and Tchobanoglous, 1998). The different sludge accumulation values in septic tanks reported in the literature are shown on Figure. 2-4.

Reported sludge pumping intervals differ from study to study, and sometimes are not even reported (U.S. EPA, 2002). Other pumping intervals recommended are based on the percentage of solids accumulation inside the tank. A summary of sludge extraction periods recommended in various studies is presented in Table 2-3.

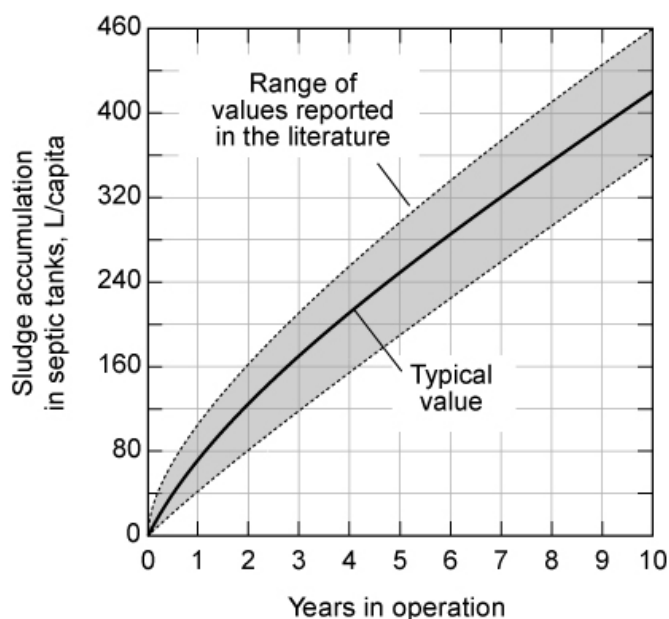

**Figure 2-4. Sludge and Scum Accumulation Rates from Different Studies.**  
Adapted from Crites and Tchobanoglous, 1998.

As reported in Table 2-3, there is little agreement on the appropriate sludge withdrawal frequency; thus, the reported intervals can only be considered to be a guideline for pumping protocols. In some studies, equations have been given that can be used to predict the septage (i.e., entire tank contents) pump intervals based on different variables such as loading, tank size, house occupants, and use of a garbage disposal (Weibel et al., 1955; Bounds, 1997). However, regular inspection and an improved understanding of the bacterial activity in the different layers of the tank and the carbon degradation pathways are needed.

Although septic tanks are presumed to require little maintenance, periodic inspection of the scum and sludge layers, watertightness, and structural soundness are recommended to avoid

environmental damage and/or health risks (Crites and Tchobanoglous, 1998; U.S. EPA, 2002). Operation and inspection guidelines have been published for septic tank owners to encourage routine inspections to protect the system from failure (U.S. EPA, 2005).

**Table 2-3. Summary of Septic Tank Pumping Guidelines Reported in the Literature.**

Guideline reported	Reference
Scum layer within 3 inch of the outlet elevation or the sludge layer within 6 inch of the outlet elevation	U.S. PHS (1957)
Sludge plus scum greater than $\frac{1}{2}$ to $\frac{2}{3}$ of tank depth	U.S. EPA (2002)
Sludge plus scum equal to $\frac{1}{3}$ of tank volume	U.S. EPA (2002)
Sludge plus scum equal $\frac{1}{4}$ of the tank volume	GDPUD (2009) <sup>c</sup>
Every 2 years	U.S. EPA (2002)
Every 3 to 5 years <sup>a</sup>	U.S. EPA (2002) <sup>b</sup>
Every 5 years or more	Phillip et al. (1993)
Every 10 years	SLOC (2008)
Floating sludge and scum flowing through the outlet tee	U.S. EPA (2002)

<sup>a</sup> Range applied when regular inspections have not been done during those years.

<sup>b</sup> U.S. EPA recommends monitoring of the sludge and scum layers every two years and then using the natural accumulation rate for that area or that tank as the guide to determination of pumping frequency.

<sup>c</sup> Specific example of regulatory standards applied to the community based on site characteristics.

## 2.3 Anaerobic Processes

Because sludge accumulating in the bottom of a septic tank undergoes anaerobic decomposition, it is important to review the fundamental principles underlying anaerobic processes to develop a more comprehensive view of the chemical and biological reactions occurring inside a septic tank. The essential reactions that occur during anaerobic decomposition, the key operational parameters, and toxic conditions that affect the process are presented and discussed in this section

### 2.3.1 Anaerobic Oxidation

The anaerobic oxidation process can be described as a two-stage process (see Figure 2-5); the first stage is identified as *waste conversion (acetogenesis, acidogenesis)*, in which complex organics are first hydrolyzed and then fermented into simple organic compounds (e.g., hydrogen and carbon dioxide) and VFAs (e.g., acetate) by facultative bacteria known as acetogens and acidogens (McCarty, 1964; Speece, 1996; Bitton 2005). After the organic matter has been converted to simpler compounds, *waste stabilization (methanogenesis)* takes place, where the acids are synthesized by methanogens into methane and carbon dioxide (McCarty, 1964). It should be noted that in some references anaerobic oxidation is considered to be a three-stage process in which the hydrolysis of the organic material to simple acids is considered to be a separate step (see Figure 2-6).

A key factor in the anaerobic oxidation process is the balance between the microorganisms responsible for each step. When the system is in equilibrium, the methanogens transform the acids at the same rate that acids are formed (McCarty, 1964). Therefore, when high acid concentrations are found, it is an indication that the acid forming bacteria and the methanogens are not in balance.

The two major mechanisms of methane formation are the breakdown of acetic acid, which is the most prevalent volatile acid produced in the fermentation of carbohydrates, proteins, and fats, and the reduction of carbon dioxide (McCarty, 1964; Bitton, 2005). The chemical reactions of methane formation are as follow:

1. Utilization of acetic acid:



2. Reduction of carbon dioxide:



Growth and acid utilization rates of methane formers are slow, and are usually limiting factors in anaerobic treatment (Speece, 1996, Duncan and Horan, 2003). Methanogens are known to be different from the typical bacteria and are classified in a separate kingdom, the Archaea (Duncan and Horan, 2003). The methane forming microorganisms are strict anaerobes and even small amounts of oxygen can be toxic. Methanogens are also sensitive to any environmental change including temperature, organic loading, waste composition, and other factors (McCarty, 1964). The microorganisms involved in the anaerobic process need sufficient concentrations of nutrients to operate properly. Nitrogen and phosphorus comprise about 11% and 2% of the dry weight of biological solids, respectively (McCarty, 1964).

The methanogenic organisms are restricted in the number of reactions and substrates they can utilize. Moreover, according to their substrate specificity, methanogens are classified in two groups, 1) the *Acetoclastic Methanogens*, which in general are able to utilize acetate (e.g., *Methanosaeta* spp. and *Methanosarchina* spp.) and in some cases are capable of using

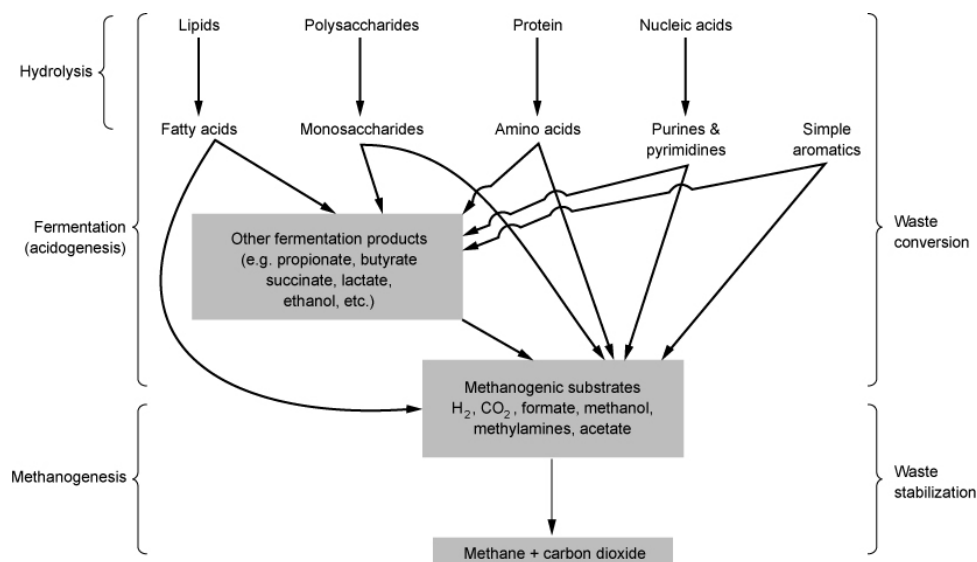
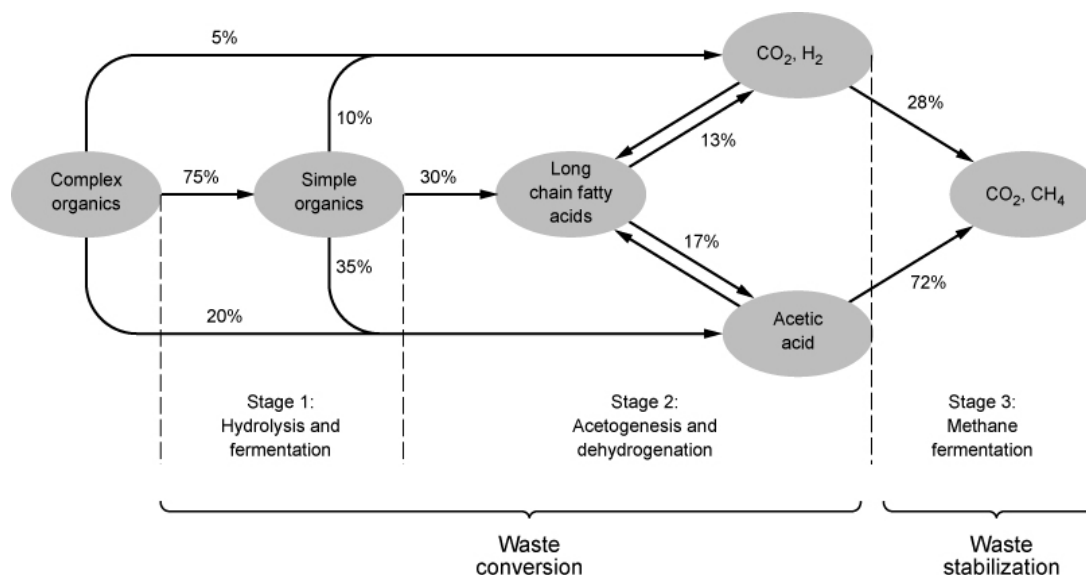

Figure 2-5. The Stages of Anaerobic Decomposition, Waste Conversion Followed by Waste Stabilization.

Adapted from McCarty, 1964 and Tchobanoglous et al., 2003.



**Figure 2-6. The Intermediate Steps of Anaerobic Reactions, with Percentages Based on COD Conversion.**  
Adapted from Speece, 1996 and Tchobanoglous et al., 2003.

methanol and methylamines (e.g., *Methanosarcina* spp.), and 2) the *hydrogen-utilizing methanogens* that reduce carbon dioxide, formate, methanol, and methylamines, using the hydrogen produced previously during the hydrolysis and acid formation processes (Duncan and Horan, 2003). In anaerobic digesters, 70% of the methane gas is originated from acetate reduction and 30% is attributed to the substrates reduced by the hydrogen-utilizing methanogens (Duncan and Horan, 2003).

A COD balance can be used to estimate the theoretical methane production during anaerobic fermentation. The COD of the methane produced during anaerobic decomposition of organic matter is approximately equal to the COD of the converted organic matter (Tchobanoglous et al., 2003). The oxygen demand of methane is determined as follows (McCarty, 1964):



From Eq. 2-3, it can be derived that each mol of methane is oxidized with two mol of oxygen. Therefore, 0.35 L of methane is equal to one g COD stabilized (5.62 ft<sup>3</sup> CH<sub>4</sub> / lb COD) (McCarty, 1964; Speece, 1996; Tchobanoglous et al., 2003).

### 2.3.2 Operational Parameters in Anaerobic Reactors

Parameters such as the appropriate concentration of nutrients, pH, redox potential, alkalinity, volatile suspended solids loading, temperature, and solids retention time are important for successful anaerobic digestion.

In anaerobic reactors, the recommended nutrient loading is 5 to 15 mg N/g COD and 0.8 to 2.5 mg P/g COD. Nutrients must be supplied in this range as a preventive measure to avoid inhibiting effects (Speece, 1996). Sulfur is also required by methanogens, but in relatively lower concentrations, for optimal growth and maximum methanogenesis activity (Speece, 1996; Tchobanoglous et al., 2003). For comparison, typical nitrogen and phosphorus concentrations in untreated wastewater from individual residences are 13.3 and 3.28 g/capita·d, respectively



(Crites and Tchobanoglus, 1998). Based on typical operation, the estimated loading of nitrogen and phosphorus in the septic tank sludge is approximately 11 and 6.2 mg/g COD, respectively (see Table 2-6).

The pH is another important factor, which should be in the range of 6.5 to 8.2, with an optimum range of about 7.0 to 7.2 (McCarty, 1964; Speece, 1996). Outside of these ranges, the efficiency of the treatment decreases rapidly, and acid conditions can dominate the reactor environment resulting in toxic conditions for methanogens (McCarty, 1964). Therefore, controlling the reactor pH at the optimum levels is essential for efficient methanogenesis.

Microbial respiration requires an electron acceptor, which can be an organic compound or some inorganic electron acceptors, as shown in Table 2-5. Some of the most common electron acceptors in decreasing order of reduction potential are nitrate, manganese, iron, sulfate (all under anoxic conditions) and finally carbon dioxide, under anaerobic conditions (Maier et al., 2009). As reported in Table 2-5, aerobic reactions using oxygen as a terminal electron acceptor provides the most energy for cell growth, while methanogenesis provides the least. Thus, on the basis of energetics, other electron acceptors must be exhausted before methanogenesis can take place. Based on the relationships shown in Table 2-5, measurements of redox potential can be used to assess the types of reactions likely to be occurring within a septic tank.

**Table 2-4. Optimum Conditions for Anaerobic Treatment.**

Adapted from McCarty, 1964.

Parameter	Unit	Optimum condition
Temperature	°C	30 - 38 <sup>a</sup> 50 - 57 <sup>b</sup>
Environment	-	Anaerobic
Biological nutrients available	-	Nitrogen, phosphorous, and sulfur
pH	unitless	7.0 to 7.2
Toxic materials	-	Total absence
Alkalinity	mg/L as CaCO <sub>3</sub>	2,500 to 5,000

<sup>a</sup> Mesophilic conditions.

<sup>b</sup> Thermophilic conditions.

**Table 2-5. Common Electron Acceptors, Products, and Redox Potentials.**

Adapted from Maier et al., 2009.

Type of respiration	Reduction reaction electron acceptor → product	Reduction potential (V)	Difference <sup>a,b</sup> (V)
Aerobic	O <sub>2</sub> - H <sub>2</sub> O	+ 0.81	- 1.28
Denitrification	NO <sub>3</sub> <sup>-</sup> - N <sub>2</sub>	+ 0.75	- 1.22
Manganese reduction	Mn <sup>4+</sup> - Mn <sup>2+</sup>	+ 0.55	- 1.02
Nitrate reduction	NO <sub>3</sub> <sup>-</sup> - NH <sub>4</sub> <sup>+</sup>	+ 0.36	- 0.83
Sulfate reduction	SO <sub>4</sub> <sup>2-</sup> - HS <sup>-</sup> , H <sub>2</sub> S	- 0.22	- 0.25
Methanogenesis	CO <sub>2</sub> - CH <sub>4</sub>	- 0.25	- 0.22

<sup>a</sup> CH<sub>2</sub>O-CO<sub>2</sub> was used as electron donor in each case, with an oxidation potential equal to - 0.47 V.

<sup>b</sup> Reduction - oxidation potential of CH<sub>2</sub>-CO<sub>2</sub>.

In anaerobic reactors, the alkalinity is controlled by the bicarbonate ion concentration, associated with the production of carbon dioxide gas. Optimum levels of alkalinity in a complete-mix high-rate anaerobic digester vary from 2,500 to 5,000 mg/L as CaCO<sub>3</sub>, with a minimum of 1,000 mg/L as CaCO<sub>3</sub> to provide enough buffer capacity (McCarty, 1964). When the levels of alkalinity are less than 1,000 mg/L as CaCO<sub>3</sub>, the pH will drop and the methanogenesis rate will be reduced (McCarty, 1964; Speece, 1996).

Similar to anaerobic digesters, the anaerobic sludge layer in the septic tank requires enough alkalinity to buffer against pH change due to the production of volatile fatty acids (VFAs). However, the formation of VFAs depends directly on the incoming organic loading rate (OLR), with a higher OLR resulting in a higher concentration of VFAs in the septic tank. The OLR in anaerobic reactors is usually high (3.2 to 32 kg COD/m<sup>3</sup>·d) as compared to 0.07 kg COD/m<sup>3</sup>·d in septic tanks (see Appendix A for calculation). While high alkalinity concentrations (e.g., 2,500 to 5,000 mg/L as CaCO<sub>3</sub>) are not required to buffer acidic conditions inside the septic tank, the estimated alkalinity in the septic tank sludge layer is on the order of 5,000 mg/L (calculated using septage values from U.S. EPA, 1994).

Temperature is also a relevant parameter affecting the rate of anaerobic digestion. Thermophilic temperatures are ideal in anaerobic reactors because the reaction rates increase and the process is more efficient (McCarty, 1964). Temperature also affects ionization fractions, the solubility of substrates, and iron bioavailability (Speece, 1996). In the anaerobic consortium, methanogens are more sensitive to small changes in temperature compared to acid-forming bacteria. As temperature reduces, acidogens produce VFAs faster than methanogens can convert the VFAs to methane, creating an unbalanced metabolism during the anaerobic process (Speece, 1996; Bitton, 2005). The two temperature ranges specified for anaerobic treatments are reported in Table 2-4. Nevertheless, keeping the temperature at thermophilic ranges can be challenging, especially when the incoming waste is diluted, because the methane production might not be sufficient to heat the process using gas combustion (McCarty, 1964; Speece, 1996). In anaerobic digesters, a supplemental external heat source is often used. The liquid temperature in a septic tank is basically uncontrolled and related to hot and cold water use, as well as mean annual temperature. It should be noted that low temperatures in septic tanks are compensated by long SRT, as discussed below. Additional information on temperature in septic tanks is discussed in Section 2.4.1.

Solids retention time (SRT) in anaerobic reactors is around 20 days for processes occurring at mesophilic temperatures (i.e., 30°C). The suggested SRT can be as high as 28 days at temperatures of 18°C, and as low as 10 d for processes occurring at 40°C (McCarty, 1964; Tchobanoglous et al., 2003). In a complete-mix digester (i.e., typical anaerobic digester) the SRT is the same as the HRT (Tchobanoglous et al., 2003). However, a septic tank is not a complete mix-reactor because sedimentation and solids accumulation processes are involved and result in a phase separation. It should be noted that limited intermittent mixing does occur in the sludge layer in a septic tank due to bubble formation and release.

Sludge accumulates in the septic tank for years between tank cleaning events, resulting in an extended SRT, while the design HRT in the tank is only 1 to 2 d (U.S. EPA, 2002). In a complete-mix anaerobic reactor, 60% of volatile suspended solids (VSS) are destroyed in 20 d (Tchobanoglous et al., 2003). Therefore, the VSS destruction in a septic tank is expected to be relatively high (e.g., 50%) due to the long SRT (see Appendix B).

Solids are removed from the tank periodically, usually in response to poor performance or when the volume of solids in the tank reaches a certain limit (see Table 2-3). At the time of cleaning, it is common to have the septic tank emptied fully without leaving sludge in the tank for seeding purposes (U.S. EPA, 2002). The material that is removed from the tank is known as septage. It should be noted that the solids contained in the septage range from old material accumulated since the previous tank cleaning event to material deposited immediately prior to cleaning. Thus, the SRT is approximately equal to one half of the time between tank cleaning events. A comparison of the operational parameters for a typical anaerobic digestion process and a septic tank is shown in Table 2-6.

### 2.3.3 Toxic Compounds in Anaerobic Reactors

There are many inorganic and organic compounds that at certain concentrations become inhibitory or toxic in anaerobic reactors. Toxic compounds can range from inorganic ions such as potassium, magnesium, or calcium, to metals such as copper, zinc, or lead (McCarty, 1964). In general, a toxic effect occurs at high concentrations. Conversely, at low concentrations, the effect of these compounds might be stimulatory and favorable to the anaerobic process (McCarty, 1964). Moreover, anaerobic conditions must be maintained in the reactor as even small amounts of oxygen inhibit methane forming microorganisms.

Earth metal salts commonly found in industrial wastes, such as sodium, potassium, calcium, or magnesium, are highly toxic, causing failure or low treatment efficiency (McCarty, 1964; Speece, 1996). It has also been reported that toxicity is related directly to the cation of the salt

**Table 2-6. Typical Operating Parameters for Single-Stage Complete Mix Anaerobic Digester and Septic Tank.**

Parameter	Units	Single-stage complete	
		mix digester	Septic tank
COD	kg/m <sup>3</sup> ·d	3.2 - 32	0.07 – 0.106 <sup>a</sup>
SRT	d	20	574 – 730 <sup>b,c</sup>
HRT	d	20	1 – 2
Temperature	°C	30 - 38	7 – 30
Nitrogen	mg/g COD	5 – 15 <sup>d</sup>	11 <sup>e</sup>
Phosphorus	mg/g COD	0.8 – 2.5 <sup>d</sup>	6.8 <sup>e</sup>
Alkalinity	mg/L as CaCO <sub>3</sub>	2,500 to 5,000	4,500
Mixing	-	Complete	Intermittent by bubble activity

<sup>a</sup> Calculated values, see Appendix A.

<sup>b</sup> Approximately equal to one half of the time between tank cleaning events.

<sup>c</sup> Cleaning event assumed every three to five years (D'Amato et al., 2008).

<sup>d</sup> Rittman and McCarty (2001).

<sup>e</sup> Based on typical raw residential wastewater values (Crites and Tchobanoglous, 1998; Höglund, 2001).

(i.e., Na<sup>+</sup>) instead of the anion (McCarty, 1964). For example, in a septic tank study, Weibel et al. (1955) reported that a 1.2 % (12,000 mg/L) mixed salt brine representative of a water softener backwash cycle inhibited a non-acclimated anaerobic digestion process for 9.5 d. Weibel et al., (1955) also reported that digestion activity in acclimated sludge was not inhibited at

representative concentrations. Inhibitory as well as stimulatory concentrations of selected compounds are shown in Table 2-7.

**Table 2-7. Cation Concentrations that Cause Inhibitory and Stimulatory Effects on Anaerobic Processes<sup>a</sup>.**

Cation	Concentration, mg/L		
	Strong inhibition <sup>b</sup>	Moderate inhibition <sup>c</sup>	Stimulatory
Na <sup>+</sup>	8,000	3,500 - 5,500	100-200
K <sup>+</sup>	12,000	2,500 - 4,500	200-400
Ca <sup>2+</sup>	8,000	2,500 - 4,500	100-200
Mg <sup>2+</sup>	3,000	1,000 - 1,500	75-150

<sup>a</sup> Adapted from McCarty, 1964.

<sup>b</sup> Concentration that slows down the anaerobic treatment resulting in low efficiency.

<sup>c</sup> Concentration that can be accepted with some microbial acclimation.

Ammonia and ammonium ion are also toxic compounds found in anaerobic reactors produced normally during the anaerobic degradation of proteins or urea, which are present in some industrial wastes and in concentrated municipal sludge (McCarty, 1964; Speece, 1996). The ammonia concentration depends on the pH and can be present as mostly as the ammonium ion (NH<sub>4</sub><sup>+</sup>) at pH values below 7.25, or mostly as dissolved ammonia gas (NH<sub>3</sub>) at higher pH values (McCarty, 1964). Concentrations reported as inhibitory vary from 1500 to 3000 mg/L (NH<sub>3</sub> + NH<sub>4</sub><sup>+</sup>) and completely toxic at concentrations above 3,000 mg/L (Rittman and McCarty, 1964).

High sulfate concentrations can be problematic during anaerobic digestion processes because sulfate reducing bacteria (SRB) compete with methanogens for substrate (i.e., acetate) within the reactor. The activity of SRB can inhibit methanogens and increase the concentration of hydrogen sulfide (H<sub>2</sub>S), which is toxic to the majority of the biomass. Hydrogen sulfide is a corrosive gas and its removal from the biogas is expensive (Winfrey and Zeikus, 1977; Schönheit et al., 1982; Isa et al., 1986; Parkin, 1990; Speece, 1996). Ranges of sulfate inhibitory concentrations reported in the literature are presented in Table 2-8.

**Table 2-8. Inhibitory Sulfate Concentrations for Anaerobic Processes Reported in the Literature.**

Sulfate concentration, mg/L	Reference
>100 <sup>a</sup>	Winfrey and Zeikus, 1977
>200 <sup>b</sup>	Patel et al., 1978
>50 <sup>c</sup>	Parkin and Speece, 1982
>800 <sup>d</sup>	Parkin and Speece, 1982
>145 <sup>e</sup>	Parkin et al., 1990

<sup>a</sup> Analysis performed in freshwater sediments.

<sup>b</sup> Pure cultures of methanogens were grown in synthetic media.

<sup>c</sup> Value found in an unacclimated batch digester.

<sup>d</sup> Value found in a submerged anaerobic filter.

<sup>e</sup> Value found in an anaerobic chemostats for acetate systems.

In some cases, sulfate can also be favorable for anaerobic treatment. When sulfate is reduced to sulfide by microbial action, it can combine with and precipitate metals such as

copper, nickel, or zinc as non-toxic materials, resulting in an effective approach to control metal toxicity (McCarty, 1964; Isa et al., 1986). McCarty (1964) reported that concentrations below 200 mg/L are not toxic to anaerobic digestion reactors. In septic tanks, the sulfide produced during anaerobic degradation follows common metal precipitation pathways, forming insoluble metallic sulfides (Crites and Tchobanoglous, 1998) as depicted on Figure 2-7. It should be noted that sulfate reduction in septic tanks is typically incomplete; thus, sulfate is commonly detected in septic tank effluent. The increased sulfate concentration of wastewater in septic tanks resulting from water usage ranges from 30 to 60 mg/L (Crites and Tchobanoglous, 1998).

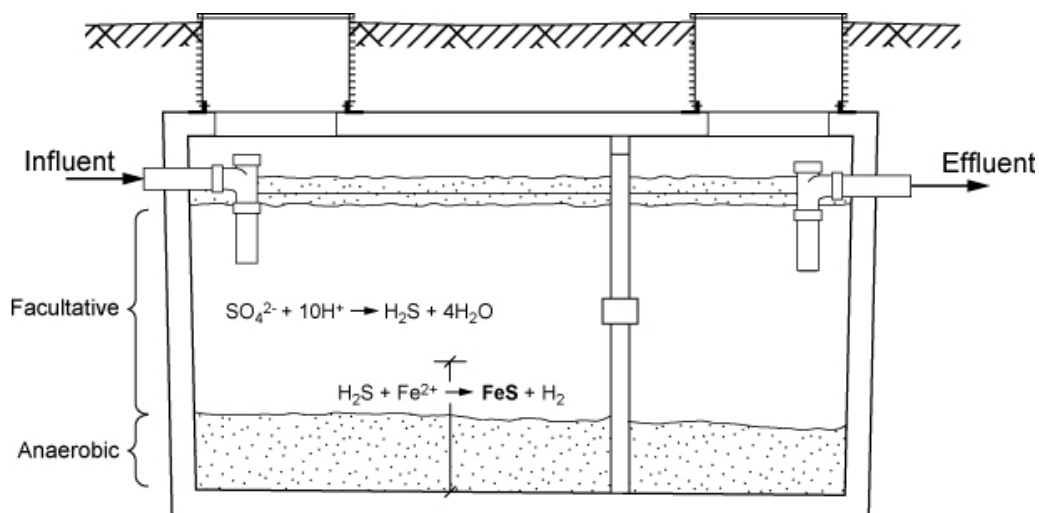

Figure 2-7. Sulfate Reaction with Metals in a Septic Tank.

Parkin et al. (1990), reported that sulfide is toxic in a range between 50 to 430 mg/L, with the toxic effects noticeable at the lower range. Moreover, Parkin et al. (1990) found that irreversible failure in anaerobic chemostats was noted at 62 mg/L for acetate systems and 60 mg/L for propionate systems. Conversely, Maillacheruvu and Parkin (1996) concluded that despite the sulfide toxicity, methanogenesis can still occur even in the presence of  $H_2S$  under specific conditions, such as high pH. Thus, it seems that sulfide dynamics and its effects on methanogenesis depend on microbial reduction, combination with metals, and pH levels within the anaerobic reactor. It is estimated that 1 mg/L of a sulfide salt such as sodium sulfide ( $Na_2S$ ) is enough to precipitate soluble metals (McCarty, 1964). The weak sulfide complexes formed (i.e., FeS, highlighted on Figure 2-7) are not harmful to the microorganisms present in the sludge.

Finally, organic compounds such as alcohols and fatty acids can be toxic when fed to anaerobic reactors at high concentrations (McCarty, 1964). This situation is common when industrial wastewater is being treated; however, when the organic material is fed continuously, the anaerobic reactor acclimates and is able to handle the organic compound degradation (McCarty, 1964). Septic tanks used for the treatment of domestic wastewater are typically not subject to loading with concentrations of organic compounds sufficient to cause toxicity. In addition, the anaerobic reactions occurring in the sludge layer are buffered from toxicity associated with the liquid flowing through the tank.

## 2.4 Gas Emissions from Septic Systems

Even in the earliest literature on septic tanks, gas emissions have been a topic of interest. The formation of gases such as methane and carbon dioxide inside the tank are due to complex biological reactions, which are influenced by different factors such as temperature, loading, and season of the year. The focus of this section is on the factors affecting gas production, different techniques used to measure gas fluxes, and methane estimates from several sources that have reported septic tank gas emissions.

### 2.4.1 Gas Formation and Temperature Influence in Septic Tanks

The temperature inside a septic tank depends on the water use activities in the house and follows seasonal temperature changes according to geographic location. As shown on Figure 2-8a, in tanks located in the San Francisco Bay area, which has a temperate climate and little seasonal variation, the temperature follows the ambient temperature patterns, varying about 6 - 8°C throughout the year. However, as shown on Figure 2-8b and 2-8c for Quebec (Canada) and Kansas (U.S.), the temperature in septic tanks in more extreme climates is subject to higher seasonal variation than San Francisco.

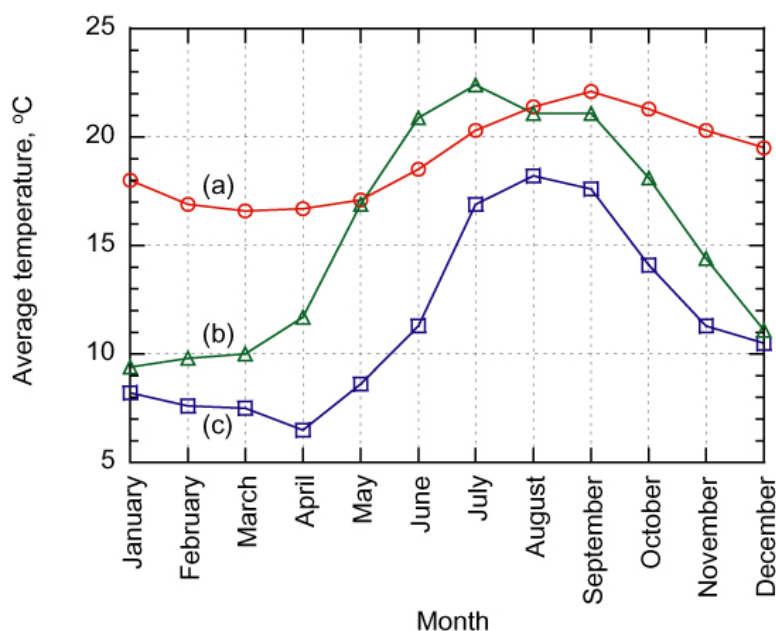

Figure 2-8. Average Monthly Temperature in Septic Tanks located in (a) San Francisco Bay Area, U.S. (Adapted from Winneberger, 1984); (b) Quebec, Canada (Adapted from Roy and Dubé, 1994) and (c) Kansas, U.S. (Adapted from Walker and Driftmier, 1929).

The gases formed during the anaerobic digestion process occurring within the sludge layer in the septic tank rise to the liquid surface or to the scum layer (if present). Settled solids accumulated on the bottom of the tank to which gas bubbles attach eventually become buoyant and rise to the surface to become part of the scum layer (Walker and Driftmier, 1929; Perking, 1989; Crites and Tchobanoglous, 1998).

The rate of gas formation inside the tank is related to temperature (Walker and Driftmier, 1929; Winneberger, 1984; D'Amato et al., 2008). Winneberger (1984) pointed out that septic tanks developed a temperature gradient from top to bottom. In the study, it was determined that

warmer temperatures were located in the bottom and colder temperatures were found on the top. Based on the analysis and observations, temperature variation was correlated with hot water use in the house. In addition to the septic tank inner thermal stratification, seasonal temperature variation has also been reported (Walker and Driftmier, 1929; Winneberger, 1984; D'Amato et al., 2008), as shown previously on Figure 2-8. During cold months (winter), the rate of solids decomposition is reduced and the amount of solids build up in the bottom of the tank increases.

Conversely, in warmer months (spring) the degradation rate increases due to the elevated temperature in the accumulated solids. A sudden increase in the rate of anaerobic activity can result in a condition known as the spring turnover or spring boil (Winneberger, 1984; D'Amato et al., 2008). The increased gas production and the change in the solubility of the dissolved gases during the spring turnover results in a decrease in the solids removal efficiency due to the resuspension and discharge of settled solids. The gases also disturb the incoming solids and therefore inhibit their ability to settle (D'Amato et al., 2008).

#### **2.4.2 Gas Collection Techniques and Chamber Systems**

Theoretical estimates of gas fluxes from septic systems can be determined from the organic loading of the system or by models developed for this purpose (e.g., IPCC, 2006). Direct techniques to measure gas fluxes from septic tanks have rarely been reported in the literature (Walker and Driftmier, 1929; Winneberger, 1984). However, devices designed to measure gas fluxes from environmental systems (e.g., anaerobic ponds, wetlands, and agricultural soils) have been in use for a number of years.

Winneberger (1984) collected gas samples from septic tanks using submerged inverted bowls, which were placed inside seven tanks for several days. Subsequently, gas samples were taken and analyzed for methane, carbon dioxide, hydrogen sulfide, and other air components using standard techniques such as mass spectrometry and iodometry. One potential issue with this study is the long contact time between the collected gases and the liquid, potentially allowing for some of the gases to partition into the liquid following Henry's Law, and thus impact the relative concentration of the gases analyzed.

Measurements of gases using floating platforms with gas-collection domes or chambers have been used to determine methane fluxes in anaerobic lagoons and wetlands (Moore and Roulet, 1991; DeSutter and Ham, 2005; Aneja et al., 2006). An example of a flux chamber design to measure gas fluxes from soil-plant systems is depicted on Figure 2-9.

The method used in each study depends on the particular conditions of the systems analyzed and the research objectives. While the gas sampling methodology is highly specific to the particular system under assessment, the chamber configuration and design have certain parameters in common. Typically, non-reactive materials are used to fabricate the body of the chamber, with stainless steel and PVC being used most frequently. Teflon tubing is recommended for vents and sampling lines to minimize chemical reaction and temperature rise. Moreover, the incorporation of a small fan to mix the headspace of the chamber is seen in almost all the flux measurement devices. For those devices located in outdoor environments, an insulated cover is used to diminish temperature alteration inside the chamber headspace (Moore and Roulet, 1991; Hutchinson and Livingston, 1993; USDA-ARS, 2003; DeSutter and Ham, 2005; Aneja et al., 2006).

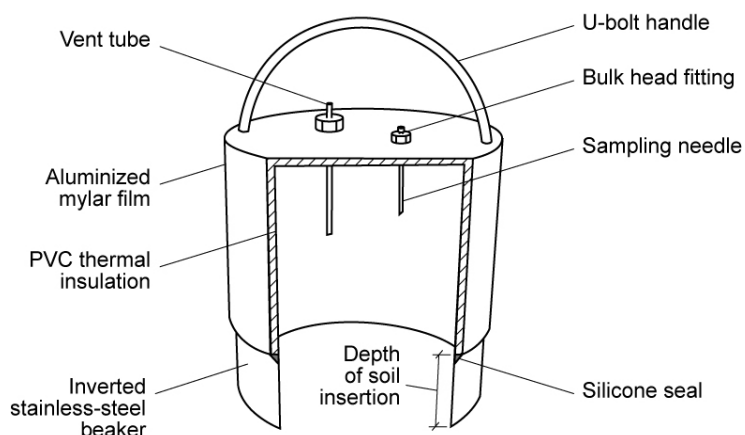

**Figure 2-9. Flux Chamber Designed by the USDA-ARS GRACEnet to Measure Gas Fluxes from Soil Systems.**  
**Note the Venting Tube and PVC Materials are Common Features in Flux Chambers.**

Adapted from Chamber-Based Trace Gas Flux Measurement Protocol. USDA-ARS GRACEnet, 2003.

Moore and Roulet (1991) used both open (dynamic, forced flow-through air circulation) and closed (static, no forced air exchange) flux chambers; methane fluxes were determined by means of gas chromatography (GC). From a comparison between the two types of chambers it was found that the methane fluxes may be underestimated using the static chamber by 20%. Nevertheless, the researchers suggested that statistically, the difference in performance is relatively small. The static chambers were recommended for measuring regional estimates of methane fluxes because they can be economical and low-maintenance compared with the dynamic chambers.

Hutchison and Livingston (1993) discussed that both types of chamber systems (dynamic and static) are subject to bias from physical and biological factors during the measurement process; and suggested some corrective actions according to the source of the bias. For example, to minimize pressure effects, Hutchison and Livingston (1993) recommended the use of an open tube to evacuate the air from the chamber when it is first installed. According to Hutchison and Livingston (1993), there is not a preference to use one chamber system or the other. However, it was noted that the chamber used should be adapted to the particular environment and sampling conditions, taking into account factors such as temperature, season, atmospheric pressure, soil type, irrigation frequency, and wind.

Based on comparisons between open and closed flux chambers and spectroscopic techniques such as fourier transform infrared (FTIR) spectroscopy and tunable diode laser spectroscopy (TDLSS) to measure nitrous oxide fluxes from two soil-plant systems, it was concluded that there was a good agreement and no bias in the data was obtained with the different methodologies (Christensen et al., 1996).

### 2.4.3 Results from Previous Gas Measurement Studies

Gas fluxes from septic tanks have rarely been measured. Winneberger (1984) studied seven septic tanks for a ten month period. Gas samples were collected and analyzed for carbon dioxide, hydrogen sulfide, and methane, as well as other atmospheric components such as argon, oxygen, nitrogen, and hydrogen. Winneberger (1984) determined that gas measurements of



carbon dioxide and hydrogen sulfide varied greatly from tank to tank. However, it was reported that methane values were more consistent, ranging from 66.3 to 88.7% by volume, with a mean of 72.9%. The highest methane value reported was in the hottest month, therefore, it is possible that the amount of gas increased due to the enhanced sludge degradation. Some important observations reported in the Winneberger (1984) study were:

- ◆ Gases formed by the sludge degradation over the tank bottom were uniformly produced.
- ◆ Gases filled up the headspace of the chamber collector apparatus in two days.
- ◆ The gas flux estimated per capita in one tank was 28 L/capita·d.

In a study conducted by Philip et al. (1993), an attempt was made to measure methane production from 50 septic tanks during a three yr period in Southern France. To analyze the methane production potential from the sludge, samples were withdrawn and placed at 20°C for three weeks. In this case, the gases were not collected directly from the septic tank by means of flux chambers or similar devices. During the third year of the study, methane production was found to have increased by a factor of five compared to the first two years. The authors concluded that the degradation of VFA and hydrolysed compounds increases after the second year due to the decline of COD. Unfortunately, the study does not go into detail on the causes of the change in gas production and no data are provided on individual septic tank gas fluxes.

Globally, it is believed that nitrous oxide (N<sub>2</sub>O) emissions also come from various types of solid waste and wastewater management practices, including pit latrines, composting toilets, septic tanks, and engineered systems, including activated sludge, trickling filters, anaerobic or facultative lagoons (Bogner et al., 2007). These N<sub>2</sub>O emission rates are expected to be reduced through implementation of mitigation technologies such as landfill gas recovery, improved landfill practices, engineered wastewater management, controlled composting and expanded sanitation coverage in countries under the Kyoto Protocol, especially in Asia, Africa, South America and the Caribbean (Bogner, 2007). Moreover, in an N<sub>2</sub>O emission study developed by U.S. EPA (1999) on septic tanks and latrines in developing countries around the world, it was concluded that nitrous oxide contributions from these types of systems are probably not a significant source.

In the United States, a majority of nitrous oxide (N<sub>2</sub>O) emissions are generated as a result of agricultural practices (U.S. EPA, 2009). While considered to be a relatively minor source, N<sub>2</sub>O emissions are also generated in wastewater treatment as an intermediate product during nitrification and denitrification processes. Nitrous oxide formation is promoted by conditions of reduced aeration, high moisture, and abundant nitrogen in the form of urea, ammonia, or proteins (Bogner et al., 2007; U.S. EPA, 2009). Little specific data on emissions from septic systems have been reported in the literature, however, it is expected that nitrification and denitrification of septic tank effluent in soil-based dispersal systems could potentially result in some N<sub>2</sub>O emissions.

#### **2.4.4 Estimates of Methane Production**

To address the lack of studies on direct measurements of GHG emissions from septic tanks, it is necessary to calculate emission values that might represent a baseline for comparison when empirical values are obtained. Estimates of methane emissions can be developed based on an organic loading approach, where it is assumed that in the United States, one person discharges 200 g/d of COD (Crites and Tchobanoglous, 1998) and that 60% of the influent COD is reduced

due to settling and anaerobic digestion inside the septic tank. Based on this calculation approach, the theoretical methane production is 11.0 g CH<sub>4</sub>/capita·d (see Appendix B for calculations). It should be noted that this calculation approach accounts for the COD that is eventually removed from the system as septage.

Kinnicutt et al. (1910) reported methane measurements from community septic tanks in Lawrence, MA in the early 1900's. Studies from Kinnicutt et al. (1910) describe the significant relation that exists between the methane emissions from septic tanks and the temperature. As shown on Figure 2-10, values around 8-12°C have corresponding methane emission rates in the range of 0.1 to 2 g CH<sub>4</sub>/capita·d. Alternately, temperatures values ranging from 16-20°C, have reported methane emission rates ranging from 3-6 g CH<sub>4</sub>/capita·d. Thus, the reduction of gas emissions in the cold months was clearly observed. Conversely, as shown on Figure 2-11, in hot months an increase in gas release was observed. Kinnicutt also observed that gas production from septic tanks started almost immediately during warm months, while in cold months gas production was delayed until the tank contents warmed in the spring and summer. Thus, tanks that were emptied in the winter had the anaerobic digestion process inhibited by temperature.

Winneberger (1984) estimated 22- 28 L/capita·d of gas from a single septic system. Assuming that, as reported, the gas was 70% methane and a methane density of 0.67 g/L CH<sub>4</sub> results in an emission rate range from 14- 18 g CH<sub>4</sub>/capita·d. Similarly, based on the method developed by the IPCC (1996, 2006), methane emissions from a domestic septic tank are approximately 25.5 g/capita·d (see Appendix C for calculations). However, as noted in Appendix C, the IPCC method uses an assumed methane conversion factor (MCF) of 0.5 to represent the conversion of organic matter to methane. A summary of the different methane emission rates estimates is presented in Table 2-9.

**Table 2-9. Estimates of Methane Emission Rates from Septic Tank Liquid Surface.**

Method	Year	Methane estimate (g CH <sub>4</sub> /capita·d)
Kinnicutt et al.	1910	10.1 <sup>a</sup>
Winneberger	1984	14 to 18 <sup>a</sup>
COD loading	2009	11 <sup>b</sup>
IPCC	2007	25.5 <sup>c</sup>
Sasse	1998	18 <sup>d</sup>

<sup>a</sup> Measured value.

<sup>b</sup> Calculated value assuming that 40 % of solids are removed as septage (see Appendix B).

<sup>c</sup> Calculated value assuming that half of the influent COD is converted anaerobically (see Appendix C).

<sup>d</sup> Calculated value assuming 25 % CH<sub>4</sub> dissolved (see Appendix D).

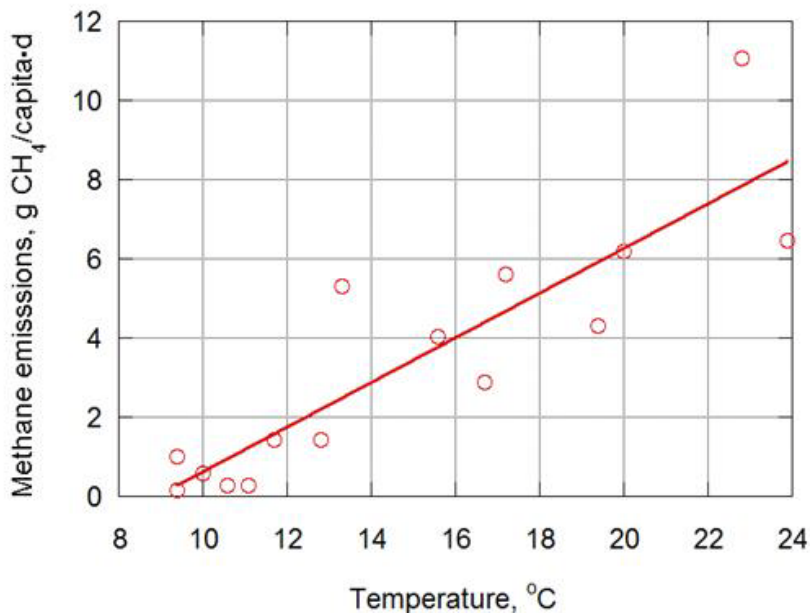

Figure 2-10. Relationship between Methane Emission Rates from Liquid Surface of Community Septic Tank and Water Temperature.  
Kinnicutt et al., 1910.

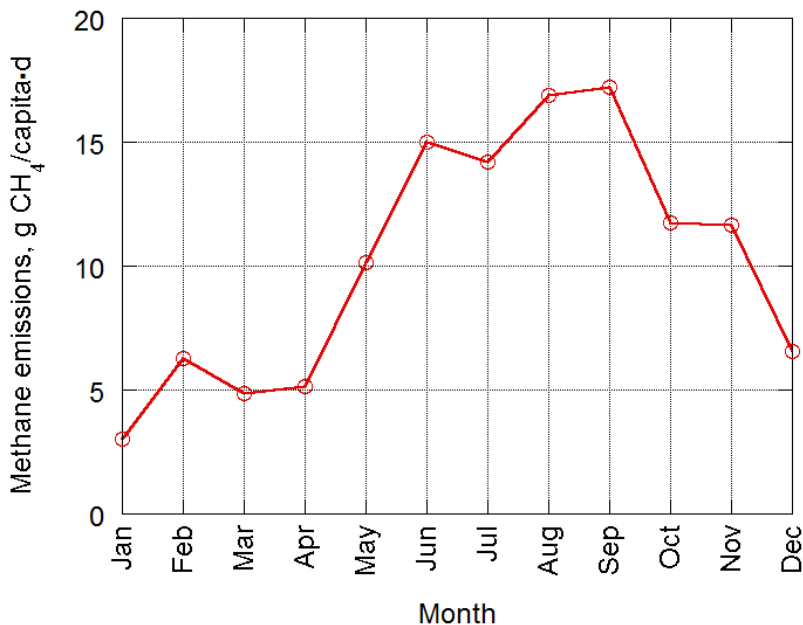

Figure 2-11. Monthly Methane Emission Rate from Liquid Surface of Community Septic Tank.  
Kinnicutt et al., 1910

Sasse (1998) presented a model for estimating gas production from a septic tank system based on tank configuration, loading, temperature, and other variables. Using the Sasse (1998) model and typical values for North American septic tank design, loading, and configuration, a

total methane production value of 18 g CH<sub>4</sub>/capita·d is calculated (see Appendix D). The Sasse model also accounts for methane that leaves the tank in the effluent. For purposes of the calculation, it was assumed that 25% of the methane produced leaves the tank dissolved in the effluent.

#### **2.4.5 Gases in Effluent Dispersal Systems**

In soil-based effluent dispersal systems, wastewater is applied typically using a system of perforated pipes. At the point where septic tank effluent is applied to the soil, a clogging zone occurs as a result of high moisture content and excess organic matter. The clogging zone is composed of various materials, including wastewater particulate matter, microbial biomass, and inorganic precipitates. Based on oxygen diffusion rates alone, it has been determined that the supply of atmospheric oxygen is a limiting factor (Janna, 2007; Erickson and Tyler, 2001). Thus, the development of anaerobic conditions and clogging zones in conventional soil dispersal systems is an expected phenomenon.

### **2.5 Summary of GHG Emissions from Wastewater Systems**

The increase in carbon dioxide and other gases in the atmosphere have motivated entities, such as the IPCC, to build GHG inventories to determine critical emitting sources. The published studies on GHG emissions from wastewater treatment plants and the relative importance of septic tanks gas emissions are summarized in this section.

#### **2.5.1 Observations of GHG Emissions from Wastewater Treatment Plants**

Concern about climate change has resulted in increased research on the emission of GHGs to the atmosphere (IPCC, 1996; U.S. EPA, 2006; Sahelli, 2006; Chandran, 2009; Foley and Lant, 2009). In general, onsite wastewater treatment systems have received less attention compared to full-scale wastewater treatment plants when accounting for GHG releases. However, it is important to have an understanding of the GHG estimated in these studies and the different approaches used to obtain them. Sahely (2006) used a life cycle assessment methodology to quantify GHG emissions from municipal wastewater treatment facilities in Canada, reporting carbon dioxide as the major gas contributing to GHG emissions, due to the predominance of aerobic treatment processes. It should be noted that life cycle assessment (LCA) studies are highly influenced by the boundary conditions and individual assumptions; consequently the findings should be considered only as a baseline for emissions inventories.

Foley and Lant (2009) published an experimental approach to evaluate gas fluxes from WWTPs in Australia. The study focused on the estimation of methane and nitrous oxide emissions from four full-scale treatment systems. The researchers pointed out that the estimated methane emissions from wastewater collection systems are underestimated and suggested that models should be developed to address this situation. Liquid methane measured at the inlet and outlet of various WWTPs are summarized in Table 2-10.

Cakir and Stenstrom (2005) developed a mass balance model to compare methane and carbon dioxide gases from aerobic and anaerobic wastewater treatment systems. The aerobic technology studied was a conventional activated sludge process and the anaerobic technology was an upflow anaerobic sludge blanket (UASB) reactor. It was reported in the study that aerobic processes release less GHG than anaerobic treatment processes for low strength (~300 g/L) influent BOD<sub>u</sub> (ultimate carbonaceous oxygen demand or 20 d BOD). According to the model,

for a BOD<sub>u</sub> concentration of 100 mg/L, the dissolved methane in the effluent of the UASB was around 84 mg CH<sub>4</sub>/L, while it was just 0.26 mg CH<sub>4</sub>/L at the effluent of the aerobic process. The authors suggested that capturing the liquid methane produced after the UASB treatment was an alternative to reduce the total GHG emissions from the anaerobic treatment.

**Table 2-10. Summary of Dissolved Methane Measured at Three WWTPs in Australia (Foley and Lant, 2009).**

Wastewater system	Location	Flow m <sup>3</sup> /d	Inlet, mg CH <sub>4</sub> /d	Outlet, mg CH <sub>4</sub> /d
Lagoons <sup>a</sup>	Adelaide Hills, South Australia	1,200	3.2 – 7.2 <sup>d</sup>	0.3 ± 0.2
CAL <sup>b</sup>	Melbourne, Victoria	230,000	0.5 - 1.5 <sup>e</sup>	0.7 ± 0.4
PST <sup>c</sup>	Sydney, New South Wales	275,000	0.5 – 1.5 <sup>e</sup>	0.6 ± 0.1

<sup>a</sup> Uncovered anaerobic/facultative lagoons.

<sup>b</sup> Covered anaerobic lagoon.

<sup>c</sup> Primary sedimentation tank.

<sup>d</sup> Raw wastewater received via a rising main.

<sup>e</sup> Raw wastewater received by gravity.

### 2.5.2 Relative Importance of the Septic Tank Gas Emissions

Wastewater treatment systems are estimated to account for about 4% of the total methane emissions in the U.S. and are also a source of nitrous oxide, another GHG with an equivalent effect of more than 296 times that of carbon dioxide (IPCC, 2007; U.S. EPA, 2009). Using the IPCC methodology, the U.S. EPA (2009) has determined that a majority of the methane emissions associated with wastewater originate from onsite septic systems, due to the uncontrolled release of methane to the atmosphere and the large numbers of individual septic systems in use. According to the U.S. EPA (2010), methane and nitrous oxide emissions from all domestic wastewater systems are 15.7 and 4.9 Tg CO<sub>2</sub>e/year, respectively. Using the U.S. EPA (2010) approach, the total methane emissions from septic systems is about 12.8 Tg CO<sub>2</sub>e/year and nitrous oxide emissions are not accounted for. Methane and nitrous oxide emissions attributed to centralized wastewater treatment are about 2.9 and 4.9 Tg CO<sub>2</sub>e/year, respectively. It should be noted that energy and chemicals used in collection and treatment, as well as gas emissions associated with wastewater collection, are not accounted for in the U.S. EPA (2010) emissions model.

Given the data presented in Table 2-9, there is a significant difference in the previously measured methane emission values compared to the IPCC model estimates; thus, there is reasonable justification to conduct additional studies to quantify the amount of gases released to the atmosphere from septic tanks. The U.S. EPA (2010) model used to determine GHG emissions from septic systems applies the same methane correction factor, MCF (see Appendix C) used in the IPCC model, therefore both models result in the same estimate of methane emissions (see Table 2-9). Again, the MCF value of 0.5 used in the U.S. EPA (2010) model is based on the assumption that half of the influent organic matter is converted to methane.



## CHAPTER 3.0

## MATERIALS AND METHODS

The topics presented in this section include the design of the devices and protocols used for sampling at the (a) septic tank liquid surface, (b) venting system, and (c) soil dispersal system; GHG laboratory analysis methods and procedures; factors taken into account for data quality control and data acquisition; and equations used for data analysis.

### 3.1 Design of Sampling Devices

This section presents a description of the flux chamber designed for use in the septic tanks, the modifications made to the flux chamber for use in the soil dispersal systems, and the device designed to obtain gas samples from the venting system.

#### 3.1.1 Flux Chamber Design for Use in Septic Tanks

Measurements of GHG emissions from soil-plant systems using flux chambers and the corresponding sampling techniques are well established (Hutchinson and Livingston, 1993). However, little information is available on gas flux measurements from the liquid/solid surface of septic tanks. Thus for this research, a flux chamber design based on the soil-plant system was modified, constructed, and tested, along with the development of a corresponding sampling methodology. The flux chamber is shown on Figure 3-1.

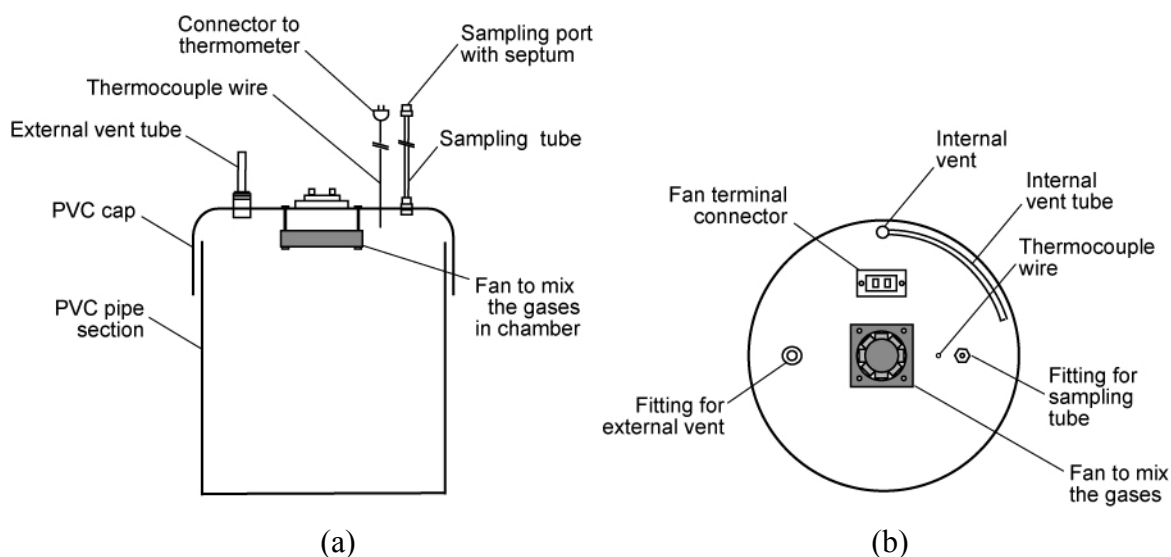

**Figure 3-1. Flux Chamber Developed to Sample Gases from Liquid Surfaces: (a) Side View of the Flux Chamber and (b) Internal View of the Flux Chamber Where the Fan and Internal Vent are Visible**

The main body of the flux chamber was constructed from a PVC pipe section (12" diameter, 12" length), inserted into a 12" diameter PVC cap. A 12-volt fan was installed inside of the cap to ensure that the gases were well mixed in the chamber. A 3/16" brass Swagelok fitting was inserted into the PVC cap to hold 4' of Teflon tubing (3/16" external diameter). A second brass piece at the end of the tubing was fitted with a septum to comprise the sampling port used to withdraw the gas samples. Two additional vinyl tubing vents were installed, one being a 1/4" internal vent that extended 8" inside of the cap and one a 1/2" diameter external vent of 6' in length with a valve at the end as seen on Figure 3-1b.

The purpose of the vents was to maintain atmospheric pressure inside the chamber. The larger vent was only used while initially submerging the flux chamber into the liquid to account for the large amount of air that needed to be displaced. The larger vent was closed after the flux chamber was in position for sampling. The total gas volume inside of the flux chamber during sampling was determined using a scale fixed to the side of the chamber; the scale was used to measure the depth of the chamber submergence. The chamber was suspended in the tank from an above ground tripod using chains attached to the cap.

### 3.1.2 Flux Chamber Inserts for Septic Tanks

A tank insert designed and used to prevent disturbance of the septic tank contents and to support the flux chamber when measurements were being taken is shown on Figures 3-2 and 3-3. This insert was necessary when there was a scum layer present on the liquid surface. The insert was composed of a 10" diameter PVC pipe section with a length of 8" with a channel at the top. The insert was supported with PVC legs going to the bottom of the tank, such that the insert was submerged about 6" into the liquid in the tank. The channel was filled with water prior to sampling. The flux chamber was lowered into the water filled channel to seal the contents of the chamber. The tank inserts were left in place for the duration of the experiment. Some tanks had limited access and it was not possible to fit the 12" flux chambers inside the risers; therefore a 6" diameter flux chamber and inserts of the same diameter were built to address this situation. A summary of the chamber size use per site and compartment is shown in Table 3-1.

**Table 3-1. Chamber Size Used in Each Site by Septic Tank Compartment.**

Septic tank compartment	Diameter of flux chamber used at each site (inch)							
	1	2	3	4	5	6	7	8
First	6	6	6	6	12	6	6	6
Second	6	6	12	12	12	6	6	6



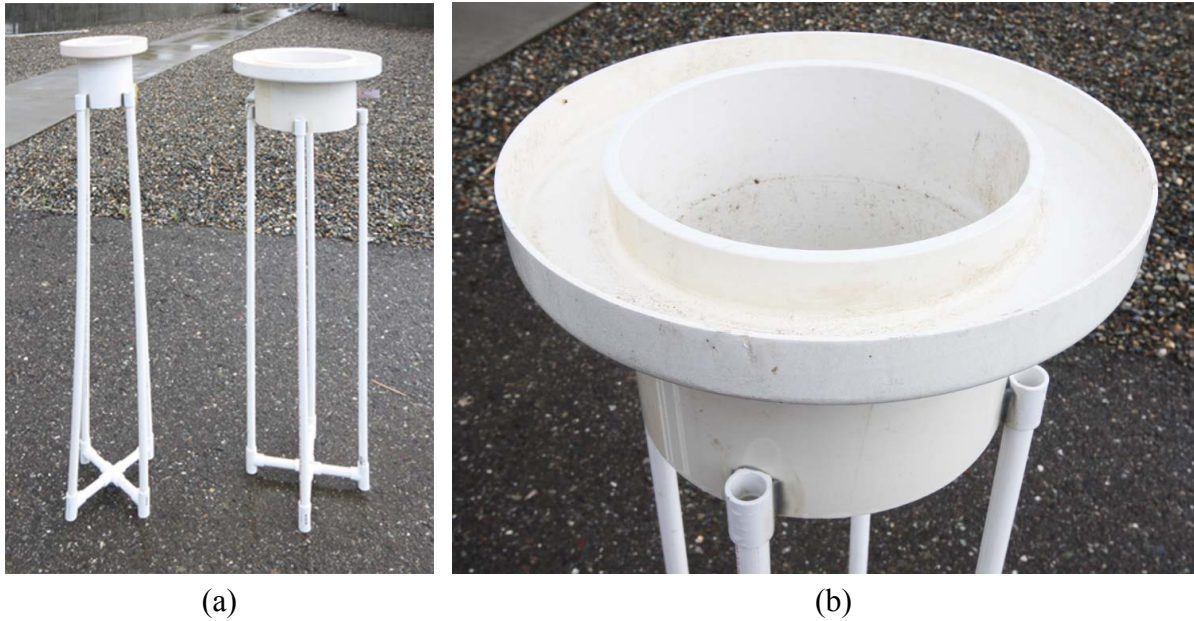

Figure 3-2. Example of Insert Used for Gas Sampling from Septic Tanks with Scum Layer:  
 (a) View of 6 and 12 inch Inserts and (b) Close-up View of the 12 inch Insert.

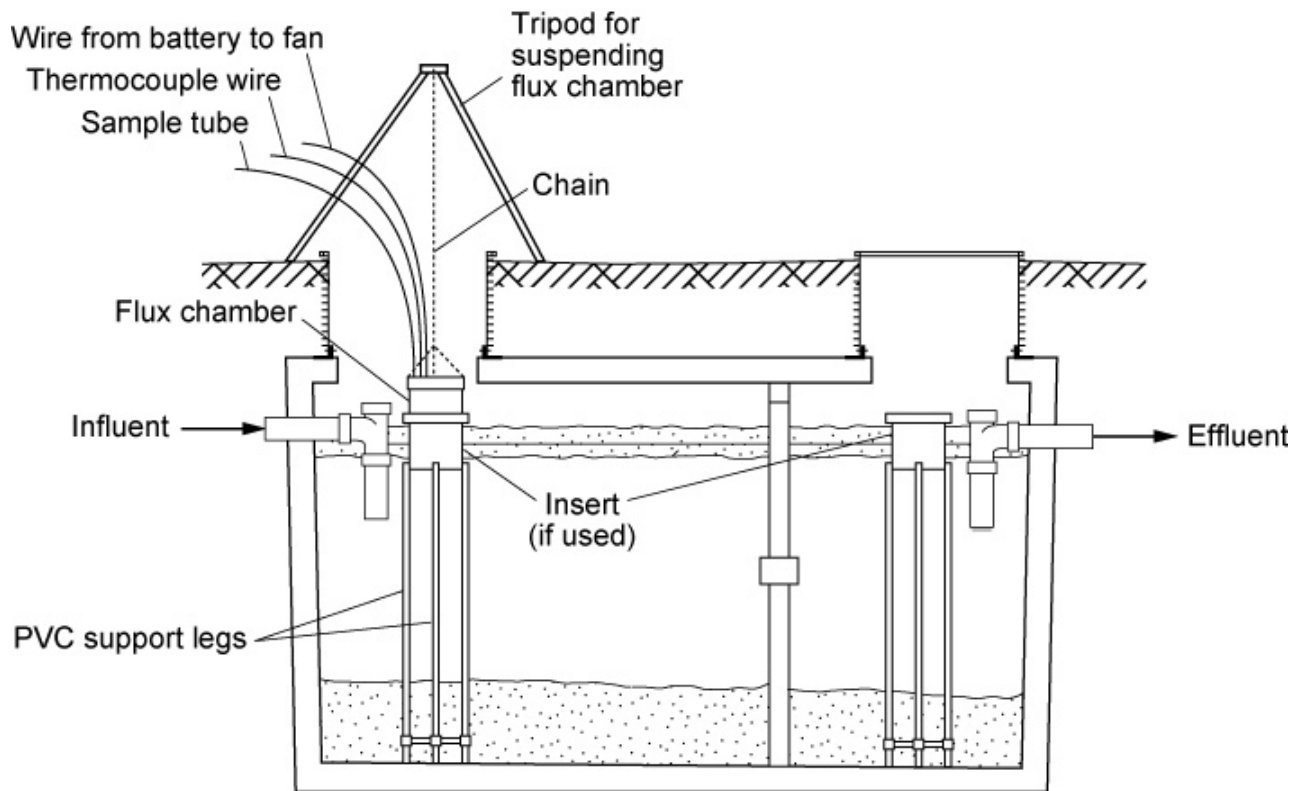

Figure 3-3. Sampling Device Used to Obtain Gas Samples Through Scum Layer.  
 Note the Placement of the Flux Chambers and Inserts.

### 3.1.3 Flux Chamber Design for Use in Soil

A chamber similar to that described in Section 3.1.1 was constructed to take samples from the leach field (Hutchinson and Livingston, 1993, USDA-ARS, 2003). The key difference between the leach field and septic tank flux chambers is that the leach field chamber did not include the external vent and it had an additional covering of reflective insulation (as seen on Figure. 3-4) to decrease the sensitivity of the measurements to radiant heating.



Figure 3-4. Flux Chamber Designed for Testing Gases from the Leach Field.

### 3.1.4 Flux Chamber Inserts for the Soil

The inserts for the soil dispersal system were made of PVC pipe (12" diameter and 4" length). The soil inserts were functionally similar to the scum layer inserts described above. Six inserts were installed above each soil dispersal system a week in advance to the first sampling event in the soil. The insert pieces were left in the soil over the entire sampling period to minimize disturbances of the soil when the flux chambers were set and the samples taken (USDA-ARS, 2003).

### 3.1.5 Vent Sampling Device

An apparatus was built to sample vented gases from the septic system cleanout port. As shown in Figure 3-5, the sampling device consisted of a 3 or 4" PVC slip cap and threaded ABS adapter as needed to fit the cleanout port. Teflon tubing and a hot wire anemometer with a telescoping handle were mounted on the cap. A 3/16" brass Swagelok fitting was used to hold the Teflon tubing in place. A second brass piece at the end of the tubing was fitted with a septum for extraction of the gas samples with a syringe. A 1/2" cord-grip connector was attached to the cap to hold the hot wire anemometer (See Figure 3-5). Lengths of 1/2" PVC pipe sleeves were attached to the bottom of the cap with threaded adapters and used as guides for the sampling tube and the hotwire anemometer. The length of the PVC pipe sleeves varied depending on the depth to the same location at the centerline of the drain line as seen in Figure. 3-5. The device fit tightly in the clean out port, creating a tight seal. Because the cleanout was completely sealed when the gas sampling apparatus was in place, gases were constantly moving through the drain line of the house and exiting the building vent as would occur under normal conditions. The

sample tubing and anemometer were small relative to the cross-sectional area of the drain line and therefore not expected to impact the gas flow.



(a)



(b)

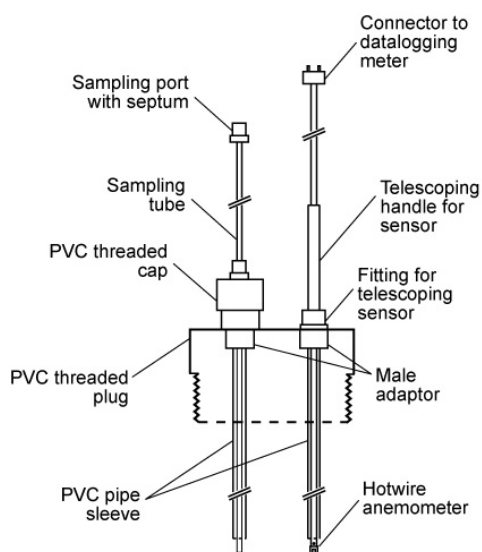

(c)

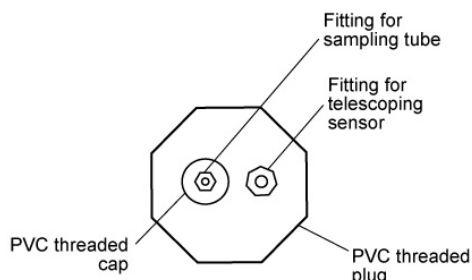

(d)

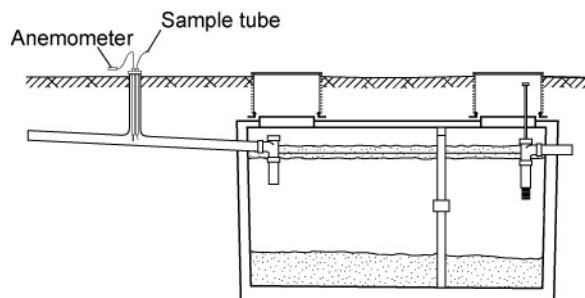

(e)

**Figure 3-5. Device Developed to Sample Gases from the Cleanout Vent (a) Main Body of the Device and Anemometer (b) View of the PVC Pipes Sleeves, (c) Profile and (d) Plant of the Vent Sampling Device. Not at Scale, and (e) Illustration of Technique Developed to Sample Vent Gases.**



## 3.2 Sampling Protocols

The three principal components of an onsite wastewater treatment system were individually sampled to determine the GHG emissions. Each component had specific characteristics requiring a different sampling method. The following section contains descriptions of the sampling method developed for the septic tank liquid surface, the venting system, and the soil dispersal system. In addition, the technique used to obtain samples of dissolved methane is described.

### 3.2.1 Sampling Method for Liquid Surfaces

To sample at the liquid surface, the septic tank access port was opened and a tripod was set up to suspend the flux chamber (see Figure 3-6). The sample was obtained by submerging the chamber in the liquid. If a scum layer was present, an insert was installed prior to obtaining samples (see Section 3.1.2, Figure 3-2 and Figure 3-3).

1. The flux chamber was slowly submerged partially into the water. The chamber depth was recorded in every sampling event to allow later calculation of chamber volume. A complete water seal around the chamber was maintained to ensure accurate flux measurements. When the chamber was put into the water, the timer was started.

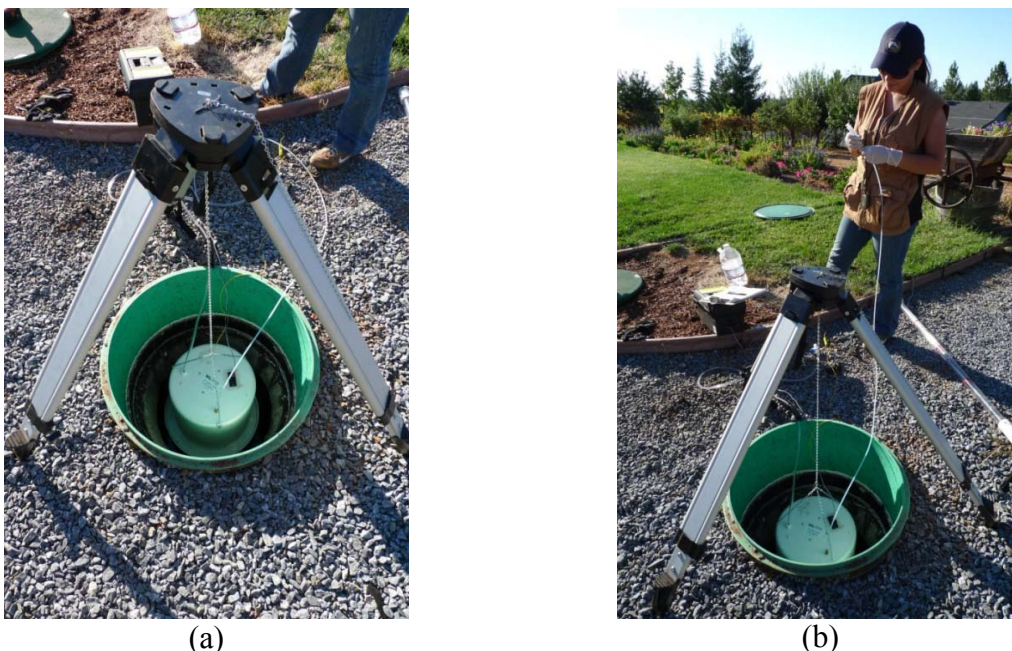

**Figure 3-6. Use of Flux Chamber for Gas Sampling from Septic Tank Located in Cool, CA**  
**(a) Deployment of Flux Chamber Into First Compartment of 1200 Gallon Septic Tank and**  
**(b) Extraction of Headspace Sample from Flux Chamber Using Syringe.**

2. A 12 mL syringe was inserted into the sampling tube septum and 6 mL of volume was taken and discharged into the air (see Figure 3-6). This step was used to purge the accumulated gases in the sample line, which had a volume of 6 mL. Simultaneously, a temperature reading was obtained.
3. After purging the sample line, two 12-mL samples were collected and put into one of the previously evacuated vials to obtain a total sample volume of 24 mL (vial evacuation

procedure is shown in Appendix E). The vial was labeled and protected from the sun. For the initial ( $t = 0$ ) sample, the fan was not needed because a concentration gradient had not developed.

4. The time interval between samples was 10 min. Before withdrawing further samples, the fan was energized briefly (5 sec) to mix the contents of the flux chamber. At time 10 min, the fan was turned off and the second sample was collected after purging the sample line again. Again the temperature inside the chamber was recorded.
5. Step 4 was repeated for the third sample. The flux chamber was then taken out of the water and the access port closed and secured.

### 3.2.2 Sampling Method for Soil Systems

1. Five 12 inch PVC permanent inserts were inserted at different locations in the leach field area and another one was placed outside the leach field to use as a control site. The permanent inserts were used to hold the flux chambers while gas measurements were taken; the inserts remained in place for the duration of the study. These pieces have a similar design to the insert used for sampling through the scum layer (Figure 3-7); however they were shorter (6 or 4" in length). As with the scum layer sampling, a water seal was applied, creating a complete seal between the insert and the flux chamber.



(a)



(b)

**Figure 3-7. Use of Flux Chamber in the Soil Dispersal System (a) Permanent Insert and (b) Extraction of the Headspace Sample from the Flux Chamber.**

2. The flux chamber was placed on the inserts sealing them together and avoiding any gas leakage during sampling.
3. The 12 mL syringe was inserted into the sampling septum and used twice to withdraw a total sample volume of 24 mL at time zero; the overall process was similar to the liquid surface measurements described above. After discharging the samples into a previously evacuated vial, a temperature reading was obtained.
4. The time interval between samples was 10 min. Before withdrawing the next samples, the fan was energized briefly (5 sec) to mix the contents of the flux chamber. At time 10 min, the fan was turned off and the second sample was collected. Again the temperature inside the chamber was recorded.
5. Step 4 was repeated for the third sample after which the flux chamber was taken out of the insert piece.

### 3.2.3 Sampling Method for Vent System

1. The cap of the cleanout port located before the septic tank was removed to verify that there was no water flowing through the pipe to avoid damaging the hot wire anemometer.
2. The length of the anemometer as well as the sampling line was adjusted to make sure that it was placed exactly in the middle of the pipe (see Figure 3-5).
3. The sampling device was installed in the cleanout port and the anemometer was turned on.
4. The 12 mL syringe was inserted into the sampling septum (Figure 3-8) and used twice to withdraw a total sample volume of 24 mL into an evacuated vial, as above. An air velocity reading was made each time a sample was taken.
5. Two more samples were taken following step four with a sampling interval of two min between them. Finally, the sampling device was removed and the cleanout cap was replaced.



Figure 3-8. Sampling of Gases from the Venting System.

### 3.2.4 Sampling Method for Aqueous Methane

1. Plastic tubing attached to a 12 mL syringe was inserted to approximately the middle of the liquid column in the first compartment of the tank.
2. Two full syringes of wastewater were withdrawn to purge the tube line. A final 12 mL sample was taken. Five mL of this sample were inserted into an evacuated vial. Then the syringe was pulled out leaving the hypodermic needle inside the septum for 30 sec to equilibrate the sample to ambient pressure (Alberto et al., 2000). A second 5 mL sample was drawn.
3. The plastic tubing was then inserted in the middle of the liquid column of the second compartment and step two was repeated.
4. After returning the samples to the laboratory, all the samples were shaken for 24 hours (Guisasola et al., 2008) to let the methane equilibrate between the liquid and gas phases.



5. The headspace gases were extracted from the vial using a syringe with a needle and placed in an evacuated tube for later GC analysis.

### **3.2.5 Sampling Method for Water Temperature**

Thermocouples were attached at 12" intervals to a PVC pipe (1" external diameter with a total length of 7'). After the gas samples from the liquid surface were taken the following steps were performed.

1. The pipe was carefully inserted in the first compartment of the septic tank.
2. The thermocouple connectors were plugged to a thermometer reader and the temperature readings were recorded.
3. Steps 1 and 2 were repeated for the second compartment.
4. The pipe was pulled out from the second compartment and rinsed with water.

### **3.2.6 Sampling Method for Water Quality**

A Myron L Ultrameter II™ was used to measure dissolved solids, pH and redox potential. The water quality measurement procedure for these three parameters was as follows:

1. Vinyl tubing attached to a 20 mL syringe was inserted into the middle of the water column in the first compartment of the septic tank.
2. The syringe was purged with liquid from the tank twice. The liquid was returned to the septic tank.
3. The syringe was used to place liquid into the Ultrameter II™ cup cell after which the reading was recorded. The liquid was poured back into the septic tank.
4. The syringe was filled again and 10 mL of wastewater was poured into a 12 mL plastic vial taken back to the laboratory for COD analysis. A HACH DR-890 colorimeter was used for the COD analysis, applying a COD digestion method. (U.S. EPA, 1993)
5. Steps 1 to 4 were repeated for the second compartment of the septic tank.

### **3.2.7 Sludge and Scum Thickness**

1. A Sludge Judge sampling device (Nasco Equipment, Inc., Fort Atkinson, WI) was inserted until it reached the bottom of the septic tank.
2. The sampling device was pulled back from the tank bottom and the sludge thickness was recorded (see Figure 3-9).
3. The scum thickness was estimated using the same sampling device and feeling the scum thickness using the end of the probe. The measurement was recorded.
4. The sampling device was rinsed with water.

### **3.2.8 General Observations**

Field observations were recorded during every sampling event on previously prepared forms (see Appendix F) designed for each system component. General observations on the septic tank scum appearance, presence of invertebrates, changes in the wastewater color and distinctive episodes such as turnover events and laundry water discharges were the most common aspects observed.

### 3.3 Gas Analysis

The gas samples were analyzed by a Shimadzu gas chromatograph (Model GC- 2014) with a  $^{63}\text{Ni}$  electron capture detector (ECD) linked to a Shimadzu auto sampler (Model AOC-5000). The samples were analyzed for  $\text{CH}_4$ ,  $\text{CO}_2$  and  $\text{N}_2\text{O}$ . The autosampler uses a gas-tight syringe to remove 5 mL gas from a sample vial and inject it into the GC port. The instrument was operated by experienced technicians with specialized training using a well established analytical protocol at the geochemistry laboratory of the UC Davis Plant and Environmental Science Department.



Figure 3-9. Sludge Measurement Taken at Site 4. The Red Marks are Located Every Foot.

### 3.4 Quality Control for the Samples

Before each sample event, one person from the research team was in charge of evacuating the vials and placing a mark on the vial's cap each time the vial was evacuated. After three subsequent evacuations, the septum inside the cap was replaced. All vials were labeled with the date and a code for each site prior to the sampling event (i.e., Septic Tank 1, inlet, time = 0 was labeled ST1 in 0).

During each sampling event one person from the research team was designated to be in charge of handling the samples taken on that particular day including protecting them from sun exposure, breakage or damage and delivering them to the laboratory for analysis.



The laboratory technicians were provided with three days of advance notice of the sampling event via e-mail to ensure that the GC was available and working properly. The laboratory technicians were responsible for measuring the CO<sub>2</sub>, CH<sub>4</sub>, and N<sub>2</sub>O concentrations in the samples as well as the gas standards (two standards of each concentration per 24 samples) and submitting the results to the project manager. The system was calibrated daily using analytical grade standards (Airgas Inc., Sacramento CA). The quality of the samples was insured by using controls treated (age and storage conditions) the same as the field samples. Sample collection in the field and analysis of samples by GC was performed according to clearly established protocols.

### 3.5 Data Analysis

To calculate the gas fluxes from each component of the septic system, the data generated in the GC was analyzed based on different approaches. The calculation approach used in the septic tank, soil dispersal system and venting system is presented in this section.

#### 3.5.1 Data from Septic Tank Analysis

The septic tank data were analyzed based on an algebraic linear model describing the gas flux rate coming into the headspace of the flux chamber. The gas flux was calculated using the slope of the trace gas accumulation curve from the measurements taken at each compartment of the septic tank during the sampling event. A sample plot for methane and carbon dioxide showing the linear fit for one flux measurement is presented in Appendix G. The equations used to calculate the septic tank flux values are shown below in Eq. 3-1 and Eq. 3-2. As shown in Eq. 3-1 the concentration in ppm (raw data from laboratory) were first converted to concentration in mg/m<sup>3</sup>.

$$\text{Gas concentration (mg / m}^3\text{)} = \frac{(C_{\text{ppm}} / 10^6)(MW)(1000 \text{ mg / g})}{\left(\frac{RT}{P}\right)} \quad (\text{Eq. 3-1})$$

Where  $C_{\text{ppm}}$  is equal to concentration in ppm, MW is the molecular weight of the gas under consideration (g/mol), R is the gas constant (0.000082057 atm·m<sup>3</sup>/mol·K), T is the absolute temperature (K), and P is the absolute pressure of the gas (atm). The concentration values (in mg/m<sup>3</sup>) from individual measurement events (typically 4 to 5 consecutive samples) were then plotted as a function of time (See Appendix G). The slope  $m$ , in units of mg/m<sup>3</sup>·sec derived from a linear fit of the data is then used to compute the flux using Eq. 3-2.

$$\text{Flux (g / capita} \cdot \text{d)} = \frac{(m)(V_{\text{FC}})(A_{\text{comp}})(86400 \text{ sec / d})}{(1000 \text{ mg / g})(SA_{\text{FC}})(\text{capita})} \quad (\text{Eq. 3-2})$$

Where  $m$  is the slope of a linear fit to the gas concentration data (mg/m<sup>3</sup>·sec),  $V_{\text{FC}}$  is the volume of the flux chamber (m<sup>3</sup>),  $A_{\text{comp}}$  is the liquid surface area of the compartment of the septic tank where the sample was taken (m<sup>2</sup>),  $SA_{\text{FC}}$  is the liquid surface area occupied by the flux chamber (m<sup>2</sup>), and capita is the number of occupants in the house.

#### 3.5.2 Data from the Soil Dispersal System

A non-linear model (Hutchison and Livingston, 1993) was applied to account for gas production and consumption in the soil based on diffusion theory. The concentration values in

ppm (raw data from laboratory) were first converted to concentration in  $\text{mg}/\text{m}^3$  using Eq. 3-1. Equation 3-3 was then used to determine the gas flux rate from the soil dispersal system.

$$\text{Flux}(\text{mg} / \text{m}^2 \cdot \text{d}) = \frac{V(C_1 - C_0)^2}{A \cdot t(2C_1 - C_2 - C_0)} \ln\left(\frac{C_1 - C_0}{C_2 - C_1}\right) \text{ for } t_2 = 2t_1 \text{ and } \frac{C_1 - C_0}{C_2 - C_1} > 1 \quad (\text{Eq. 3-3})$$

Where  $V$  is the volume of the chamber ( $\text{m}^3$ ),  $A$  is the soil surface area occupied by the flux chamber ( $\text{m}^2$ ),  $C_0$ ,  $C_1$  and  $C_2$  are the gas concentrations ( $\text{mg}/\text{m}^3$ ) at times  $t_0$ ,  $t_1$ , and  $t_2$ , and  $t$  is the time interval between  $t_0$  and  $t_1$ , and  $t_1$  and  $t_2$  (d). In this case, the concentrations were measured three times during the same interval length  $t$  (i.e., every 10 min).

### 3.5.3 Data from the Vent System

The concentration values in ppm (raw data from laboratory) were converted to concentration in  $\text{mg}/\text{m}^3$  using Eq. 3-1. The air velocity inside the pipe was measured using a hot wire anemometer. The air flow rate was calculated using Eq. 3-4.

$$\text{Flow rate} (\text{m}^3 / \text{d}) = \pi r^2 \cdot v \quad (\text{Eq. 3-4})$$

Where,  $r$  is the radius of the pipe (m) and  $v$  is the velocity inside the pipe (m/d). The mass flow of gas constituents was estimated as the product of the measured gas concentration ( $\text{mg}/\text{m}^3$ ) and the measured flow rate.

## CHAPTER 4.0

# DESCRIPTION OF FIELD SITES

The selection criteria for the sites and septic tanks, the general characteristics of the sites chosen, a detailed description of each site septic system, the experimental approach for sampling at the septic tank, venting, and soil dispersal system and the preparation for field sampling are presented in this section.

### 4.1 Site and Septic Tank Selection

The Georgetown Divide Public Utility District (GDPUD) is the entity in charge of the wastewater management in the Auburn Lake Trails (ALT) development. The development is located in El Dorado County, next to highways 49 and 193, one mile from the town of Cool. ALT has development rights for the construction of 1,100 parcels; at present 999 lots have been developed (GDPUD, 2010). The GDPUD has a detailed inventory of the septic tanks located in Auburn Lake Trails development (38° 54' 51.48"N, 120° 57' 08.85"W) as well as records related to septic tank capacity, date of installation, pump out intervals, and maintenance. Based on the GDPUD information, a preliminary inspection of the septic tanks was conducted; seven tanks met the selection criteria for this study. An eighth tank, located in Davis, California, was also included in the study to perform 24-hour sampling events to capture the variability of GHG emissions throughout the day. The criteria used to select the eight septic tanks are described below:

- ◆ Site was readily accessible
- ◆ Tank access lids were easy to open/close
- ◆ Tanks were structurally sound, water-tight, and gas-tight
- ◆ The flow inside the vent system pipe was measurable
- ◆ The soil dispersal systems had appropriate land inclination for setting up sampling equipment

Following a series of preliminary gas emission measurements from all sites included in the study, several sites were selected for further evaluation based on accessibility and performance characteristics similar to a typical system, as discussed below.

### 4.2 General Site Characteristics

Sites 1 to 7 were located in the ALT development in Cool, CA, and Site 8 was located in Davis, CA. Gas samples from the septic tank liquid surface were taken at all the sites. Sites 1, 2, and 7 were selected for a more detailed study at the venting and soil dispersal systems and at Site 8, two 24 hour sampling events were performed.

All the systems were less than 15 years old, except for the septic tank at Site 8, which was built in the 1940s. All the septic systems were gravity flow systems, comprised of a septic tank and soil dispersal system, with no other advanced treatment. It should be noted that the onsite system at Site 8 also included a graywater system for the laundry water. All the septic tanks were double compartment concrete tanks and their capacity ranged between 1000 and 1250

gal. Sites 5, 6, and 7 were the only sites with effluent filters. It was noticed that the septic tank lids at Sites 1 and 7 did not seal as well as the other septic tanks. The first compartments of the septic tanks at Sites 2, 3, and 7 had well developed scum layers that ranged from 1 to 5". The first compartment of the septic tanks at Sites 1, 4, 5, 6, and 8 had only patchy or thin scum layers. A scum layer was never present in the second compartment of the septic tanks.

### 4.3 Description of the Individual Site Characteristics

A survey was given to each household, which included general questions such as number of occupants, water saving fixtures in the house, number of bathrooms, use of garbage grinder, and questions related to the septic systems such as pumping intervals and age of the system. More detailed information such as monthly water consumption, inspections, and maintenance records were provided by the GDPUD. The results of the survey and the information provided by the GDPUD are presented in Table 4-1.

**Table 4-1. General Characteristics of the Septic Tanks in the Study Group.**

Characteristic	Septic tank number							
	1	2	3	4	5	6	7	8
Location	ALT Development, Cool, CA							Davis, CA
Number of occupants	2	2	2	2	2	2	3	4
Water saving fixtures	LFS, LFT <sup>a</sup>	LFS, LFT	None	None	LFS, LFT	LFT	LFS, LFT	Greywater <sup>b</sup>
Number of bathrooms	2.5	3	3	2	2	2	4	4
Use of garbage grinder	Occasional	Rarely	Rarely	Rarely	Almost never	Almost never	Once/wk	No
Years since septic tank pumped	3	Never	Never	0.5	12	Never	3	>12
Date built	unknown	2005	1989	unknown	unknown	2002	unknown	1940s
Water consumption (L/capita-d) <sup>c</sup>	243	604	461	1345	411	84	170	180

<sup>a</sup> LFS = low flow shower, LFT = low flow toilet.

<sup>b</sup> Laundry water diverted to greywater system.

<sup>c</sup> Average water usage based on winter season (November through February) 2008 - 2010.

A plan view of the septic system including the septic tank, cleanout vent, and soil dispersal inserts along with a detailed description of the physical characteristics of the septic tanks such as the tank volume, capacity, and the inserts installed at each compartment to support the gas flux chambers during the sampling events are presented in Table 4-2.

**Table 4-2. Physical Characteristics of the Eight Septic Tank Systems Used in the GHG Emissions Study.**  
**All Site Plans are not to Scale and Oriented with North Towards Top of Page.**

Site	Site plan	System description
1		<p>The septic tank, located in a shady area, has a capacity of 1200 gal. An insert was deployed in the first compartment of the septic tank to support the 6" flux chamber used to obtain the gas samples. It was not necessary to use an insert in the second compartment; the flux chamber was always deployed directly on the liquid surface.</p>
2		<p>The septic tank, located in a sunny area, has a capacity of 1200 gal. An insert was installed in the first compartment of the septic tank to hold a 6" flux chamber. It was not necessary to install an insert in the second compartment; the flux chamber was always deployed directly on the liquid surface.</p>
3		<p>The septic tank, located in the shade, has a capacity of 1250 gal. In the first compartment an insert to support a 6" flux chamber was installed. It should be noted that in the second compartment a 12" flux chamber was used to take the gas samples and it was deployed directly on the liquid surface.</p>
4		<p>The septic tank, located in a sunny area, has a capacity of 1000 gal. Inserts were not installed in this tank because it did not have a scum layer formation and therefore the 6 and 12" flux chambers used for the first and second compartment, respectively were always deployed directly on the liquid surface.</p>

Continued on following page

Table 4-2. Continued from previous page.

Site	Site plan	System description
5	<p>Soil dispersal system 70 ft Septic tank (S-5) Diversion valve House</p>	<p>The septic tank, located in a sunny area, has a capacity of 1250 gal. Inserts to hold 12" flux chambers were installed in both compartments of the septic tank.</p>
6	<p>Soil dispersal system 82 ft Septic tank (S-6) Diversion valve House</p>	<p>The septic tank, located in a partially shaded area, has a capacity of 1200 gal. Inserts to support 6" flux chambers were installed in both compartments.</p>
7	<p>Soil flux control 120 ft Soil dispersal system flux (SD-7, typ.) Diversion valve House 90 ft Septic tank (S-7) Clean out (V-7)</p>	<p>The septic tank, located partially in the sun, has a capacity of 1200 gal. Inserts to support 6" flux chambers were installed in both compartments.</p>
8	<p>Soil dispersal system 60 ft Septic tank (S-8) House 2 House 1</p>	<p>The septic tank, located in a partially shaded area, has a capacity of 1200 gal. Inserts to support 6" flux chambers were installed in both compartments of the septic tank. Site 8 was the only septic tank located in Davis, CA and it was selected to perform two 24-hr sampling events. A sanitary tee was not installed in the inlet.</p>

#### 4.4 Sampling Schedule

Gas flux measurements from all eight tanks were taken at various times over a four month period (September to December 2009) to attempt to capture the temperature effect on the GHG emissions. Due to external time constraints placed on this project, sampling could not be continued after December. The flux measurements and gas samples were taken in the septic tank, venting system and soil dispersal system. Each event included measurement of the gas flux and concentration of CH<sub>4</sub>, CO<sub>2</sub> and N<sub>2</sub>O. In addition, several water quality parameters (pH, dissolved solids, redox potential, COD, and aqueous methane concentration) were also measured in the inlet and outlet chambers of the septic tank. A summary of the sampling events, detailing the date, frequency, location and the parameters measured is provided in Table 4-3.

**Table 4-3. Sampling Type, Location, and Frequency.**

Date	Site <sup>a,b</sup>							
	1	2	3	4	5	6	7	8 <sup>c</sup>
9/24	S,U,T	S,U,T	S,U,T	S,U,T	S,U,T	S,U,T	-	-
10/07	S,T	S,T	S,T	S,T	S,T	-	S,U,T	-
10/21	-	-	-	-	-	-	-	S,U,T
11/05	S,T,W	S,T,W	S,T,W	S,T,W	S,T,W	S,T,W	S,T,W	-
11/10	S,V,T	-	-	-	-	-	-	-
11/12	S,V,D,T, M	-	-	-	-	-	-	-
11/17	-	-	-	-	-	-	S,V,D,T, M	-
11/19	S,V,T,W, C,M	S,V,T,M	-	-	-	-	-	-
12/01	-	-	-	-	-	-	S,V,D,T, W,C,M	-
12/03	S,V,D,T, W,C,M	-	-	-	-	-	-	-
12/08	-	S,V,T,W, C,M	-	-	-	-	-	-
12/10	-	-	-	-	-	-	-	S,T,W, C,M
1/5	V, W							

<sup>a</sup> At each sampling event, three to six gas samples were taken from the septic tank (at each compartment), venting system (before and after the septic tank when possible), and soil dispersal system, identified as S,V and D, respectively. Each sample included measurement of the gas flux and concentration of CH<sub>4</sub>, CO<sub>2</sub> and N<sub>2</sub>O.

Sludge and scum thickness measurements are identified as U.

Water temperature measurements are identified as T.

Water quality measurements of pH, dissolved solids and redox potential are identified as W.

Dissolved methane measurements are identified as M.

COD measurements are identified as C.

<sup>b</sup> Sites 1 to 7 located in Cool, CA.

<sup>c</sup> Site located in Davis, CA.

Three of the septic tanks that appeared to have similar average gas emission rates (i.e., Sites 1, 2, and 7), and had accessible venting and soil dispersal systems were selected for additional gas flux measurements from the venting and soil dispersal system (see Table 4-2). This additional sampling was done with the intent of developing a mass balance on the overall methane emission rates from the system. The mass balance analysis, presented in Chap. 5, is based on data from Sites 1 and 7, where flux values from the septic tank, soil dispersal system, and vent system were obtained. The vent samples from Site 2 were used in developing the overall atmospheric emissions; however, because soil dispersal system flux was not determined at this site, it was not used in the mass balance analysis.

Flux chambers were designed and built to obtain flux measurements at the liquid surface and above the soil dispersal system. A special device was constructed to obtain flux measurements from the venting systems. The experimental apparatus and methods developed to sample from the three components (liquid surface, gas vent, and soil dispersal system) are described in Sections 3.1 and 3.2, respectively.

#### **4.5 Preparation for Field Sampling**

Preparations for each sampling day were made at least one day in advance. Before sampling, the use of personal protection equipment (PPE) was verified for all participants to avoid direct contact with the wastewater. PPE consisted of glasses, gloves and closed toe shoes. To assure a smooth and accurate sampling process, two to three people were required at each sampling event. Parameters measured in the field, comments and a full description of each site were recorded on sampling forms (see Appendix F) designed according to the component of the septic system (i.e., septic tank, soil dispersal system or vent system) analyzed.

Sampling vials (24 mL) were evacuated no later than one day prior to sampling. Two control vials with methane concentrations of 10 and 100 ppm, two controls with carbon dioxide concentrations of 1,000 and 10,000 ppm and two controls with nitrous oxide concentrations of 1.12 and 5.02 ppm were prepared in vacuumed vials to be taken to the field and analyzed along with the samples collected in the field.



## CHAPTER 5.0

## RESULTS AND DISCUSSION

The results from the field studies of the gas emissions from septic tanks are presented and discussed in this section. The specific topics include: 1) the GHG emission rates from septic systems, 2) mass balance analysis and 3) the sources of variability in gas emission rates. A summary of all data collected in the study is presented in Appendix H.

### 5.1 GHG Emission Rates from Septic Systems

Gas emissions from septic systems may be composed of gases produced in the septic tank, soil dispersal system, and drain piping. The items discussed below include: (a) specific gas emission rates from the septic tank measured with flux chambers, (b) composite gas emission rates estimated from sampling of the venting system, (c) gases present in septic tank liquid samples, (d) gas emission rates from the soil dispersal systems measured using flux chambers, and (e) comparison of methane emissions models

#### 5.1.1 GHG Emission Rates from Septic Tanks as Measured Using Flux Chambers

The GHG emissions that were measured in this study include methane, carbon dioxide, and nitrous oxide. Eight septic tanks were sampled using 6 and 12" flux chambers. The gas bubble pattern in the septic tank is assumed to be random. Therefore, with a sufficient number of samples the statistical distribution of gas flux values should be identical, independent of whether the 6 or 12" flux chamber size was used.

While methane fluxes are attributed to anaerobic reactions occurring primarily in the sludge layer, carbon dioxide emissions result from anaerobic, facultative, and aerobic reactions. Similarly, nitrous oxide may be formed in the soil adsorption system as an intermediate product during nitrification and denitrification processes under low oxygen conditions, with high moisture and abundant nitrogen in the forms of urea, ammonia, or proteins (Bogner et al., 2007; U.S. EPA, 2009).

The flux of methane (geometric mean,  $M_g$ , and standard deviation,  $s_g$ ) measured directly from individual septic tanks (excluding Site 4) was found to range from 6.3 ( $s_g = 1.6$ ) to 17.9 ( $s_g = 1.9$ ) g/capita·d. Site 4 was excluded from most of the analysis because it had been pumped out two months prior to the study and was found to be producing only small amounts of gas. Further discussion about the Site 4 septic tank and its GHG emission rates is presented in Section 5.3.3.

The geometric mean of methane flux values based on all flux chamber measurements (Sites 1 through 8, excluding Site 4) is approximately 11.0 ( $s_g = 2.2$ ) g/capita·d. A plot of the data for Sites 1 through 7 (excluding Site 4) and Site 8 are plotted on Figure 5-1. Site 8 was plotted separately because it is in an area with a hard water supply and the values were collected over a 24-hr period. As shown on Figure 5-1, the slope of the curve fit for the Site 8 data is

steeper than that for the rest of the sites. The steeper curve fit may be an indication of greater system instability as Site 8 was found to have excess solids beyond the amount recommended for tank cleaning. Another possibility is that the sampling from Sites 1 through 7 took place during the middle of the day, while the sampling from Site 8 took place over two all day sampling events.

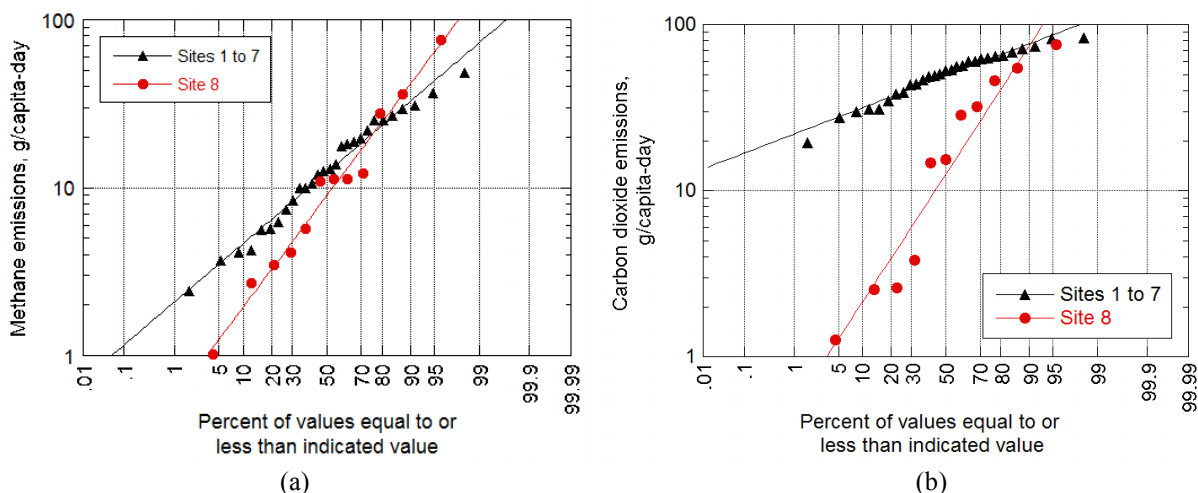

**Figure 5-1. Emission Rate Values Measured Using Flux Chambers in Septic Tanks for (a) Methane from Sites 1 to 7, Excluding Site 4 ( $R^2 = 0.96$ ), and from Site 8 ( $R^2 = 0.98$ ) and (b) Carbon Dioxide at Sites 1 to 7, Excluding Site 4 ( $R^2 = 0.94$ ) and from Site 8 ( $R^2 = 0.84$ ).**

As mentioned previously, carbon dioxide emission rates from septic tanks can be attributed to various metabolic processes taking place in the tank, including the anaerobic degradation of organic matter in the sludge layer and facultative activity occurring in aerobic and anoxic zones throughout the tank. The geometric mean of carbon dioxide flux values based on all flux chamber measurements (Sites 1 through 8, excluding Site 4) is 33.3 ( $s_g = 2.7$ ) g/capita·d. The flux of carbon dioxide from individual tanks was found to range from a geometric mean of 30 ( $s_g = 1.4$ ) to 59 ( $s_g = 1.3$ ) g/capita·d. As shown on Figure 5-2, the carbon dioxide emission rates direct from septic tanks at Sites 1 through 7 (excluding Site 4) had less variability than the methane emission rates. It was observed that the carbon dioxide emission rates from Site 8 had a different distribution than the other septic tanks, and, therefore, it was plotted separately as shown on Figure 5-2.

The mean carbon dioxide flux from the septic tank at Site 8 was about a quarter of the value measured from the other sites. One possible explanation for the low carbon dioxide flux is attributed to a reaction with calcium carbonate likely present in high levels in the water supply at Site 8, discussed further in Section 5.3.1. By comparison, Sites 1 through 7 had a relatively soft water supply.

Septic tanks were not found to be a significant source of nitrous oxide. Nitrous oxide emission rates from septic tanks were found to be negligible using the flux chambers when sampling directly from septic tanks. The measured nitrous oxide concentrations were around 0.31 ppm, which corresponds to ambient concentrations. When considering all sites, the flux of

nitrous oxide ranged from 0 to 0.03 g/capita·d, with a geometric mean of 0.005 ( $s_g = 4.35$ ) g/capita·d.

### 5.1.2 GHG Emission Rates Measured Using the Vent Method

It was found that the air movement in the household drainage system originates in the soil dispersal system and flows back through the septic tank headspace and out of the building vent. Based on this finding, it was proposed that the gas emissions from septic systems could be assessed by sampling from the vented gases in the household drainage system because the gases measured in the vent system integrate the emission rates from both the septic tank and the soil dispersal system and, therefore, may be a good representation of the overall emissions of a septic tank system.

Average emission rates of methane, carbon dioxide, and nitrous oxide, measured using the vent method (i.e., combined emission rate from septic tank and soil dispersal system), were 10.7 ( $s_g = 1.65$ ), 335 ( $s_g = 2.1$ ), and 0.2 ( $s_g = 3.6$ ) g/capita·d, respectively. There was general agreement between the flux chamber and vent method for methane, indicating that the primary source of methane gas was the septic tank itself (see Figure 5-2). In contrast, the carbon dioxide emission rates using the vent method greatly exceeded the amount produced in the septic tank, indicating that there is significant carbon dioxide production in the soil dispersal system. A detailed comparison of the vent sampling and flux chamber methods is presented in Section 5.2.1.

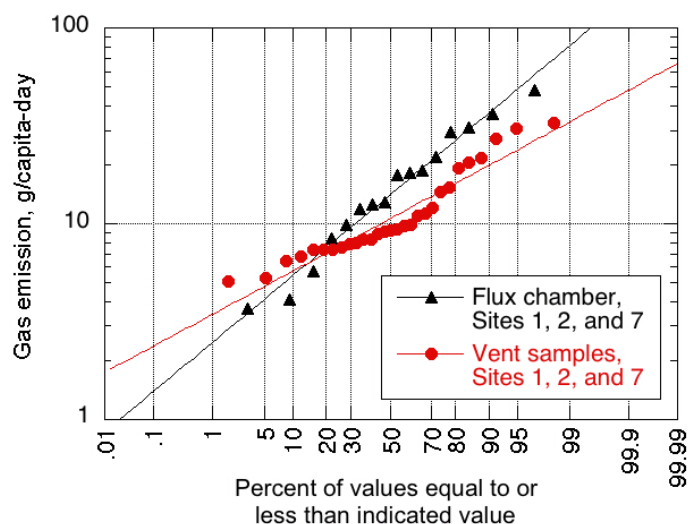

Figure 5-2. Comparison of Methane Emission Rates Using the Flux Chamber and Vent Method for Sites 1, 2, and 7.

### 5.1.3 Gas Concentrations in Septic Tank Liquid Samples

Gases were extracted from septic tank liquid samples to determine the amount of dissolved and entrained gases present. Nitrous oxide was not present in the liquid samples above the detection limit. The theoretical solubility values for methane, carbon dioxide and nitrous oxide in mg/L are 0.0004, 0.66 and 0.34, respectively. The methane and carbon dioxide concentrations in the liquid were measured at Sites 1, 2, and 7. The average carbon dioxide concentrations in the septic tank first and second compartment were 15.6 and 6.3 mg/L,

respectively, and for methane were 4.0 and 1.3 mg/L, respectively. The measured concentrations for carbon dioxide and methane in the septic tank liquid samples at these sites were high in relation to the theoretical solubility limits. One possible explanation for the high liquid phase concentrations of these gases is that they are present as small bubbles that do not effervesce readily due to their small size.

Based on these measurements, it is estimated that the methane discharged with the effluent from the septic tank varies from 0-1.4 g/capita-d, or 0-11% of the total methane generated (flux chamber emission rate value plus gases discharged with liquid). The liquid methane values are lower than those given by Sasse (1998). Sasse (1998) suggested that dissolved methane generated in a septic tank could range from 25-50%. While Sasse (1998) does not go into detail on the origins of the percentages for dissolved methane, all the values used in the Sasse (1998) model were based on statistics from septic operated at higher temperatures and loading rates. As shown on Figure 5-3, there was not a clear correlation between the gas emission flux and the effluent aqueous methane.

At Site 8, the dissolved methane concentrations in the first and second compartment were 2.6 and 1.9 mg/L and for carbon dioxide 12.1 and 10.0 mg/L, respectively. Compared to the other sites, these dissolved methane concentrations were low in the first compartment and similar in the second compartment. The carbon dioxide concentrations had a low value in the first compartment compared to the other sites and a high value in the second compartment. Dissolved nitrous oxide was not detected in the effluent liquid at Site 8.

#### **5.1.4 Gas Emission Rates from the Soil Dispersal System**

Flux chambers placed directly above the effluent pipes in the soil dispersal system were used to estimate the GHG emissions to the atmosphere resulting from diffusion of gases through the soil. However, it was found that the GHG concentrations obtained from flux chambers located above the soil dispersal system were similar to concentrations in ambient atmosphere samples. As discussed previously, the flow of air from the soil dispersal system back through the building vent system is a likely explanation for the lack of soil-based gas emissions. It is proposed that the semi-constant negative pressure in the soil dispersal system acts to pull off-gases from metabolic processes in the soil through the effluent dispersal pipes and building vents. For example, during the first sampling event at Site 1, gas flux was found to be zero above the soil dispersal system, however, a methane emission rate of 0.8 g/capita-d was detected for the control sample. During the next sampling event at Site 1, only one of the six samples from above the soil dispersal system had measurable emission rates of carbon dioxide and nitrous oxide, however both values were similar to the control. For Site 7, carbon dioxide and nitrous oxide emission rates were measured at similar concentrations in the control and in two of the samples from above the soil dispersal system.

## **5.2 Mass Balance Analysis**

A mass balance analysis was used to determine and compare gas emission rates from the emission sources (septic tank and soil dispersal system) identified in the previous section. The analysis presented below includes mass balances on (a) the septic tank only for a comparison of the flux chamber and vent sampling methods, (b) the septic system to determine the overall atmospheric emissions of GHG, and (c) the soil dispersal system to assess the fate of carbon. The

percentage of methane and carbon dioxide in the measured emission rates is also presented in this section.

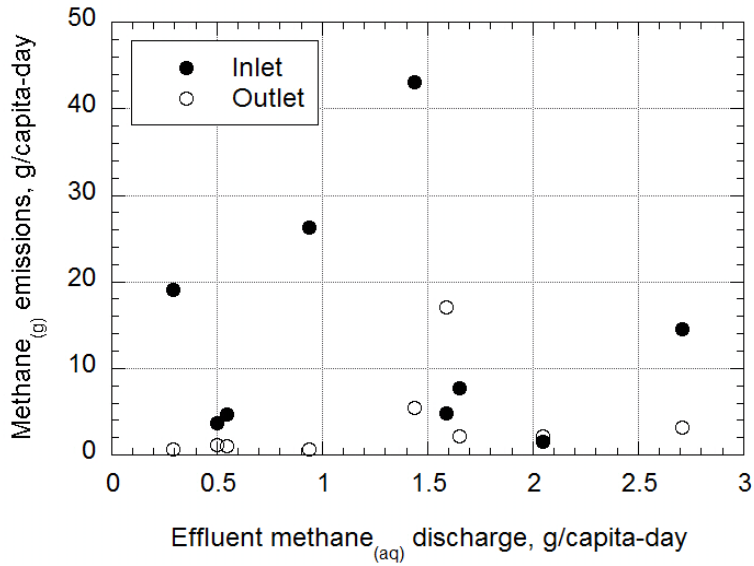

(a)

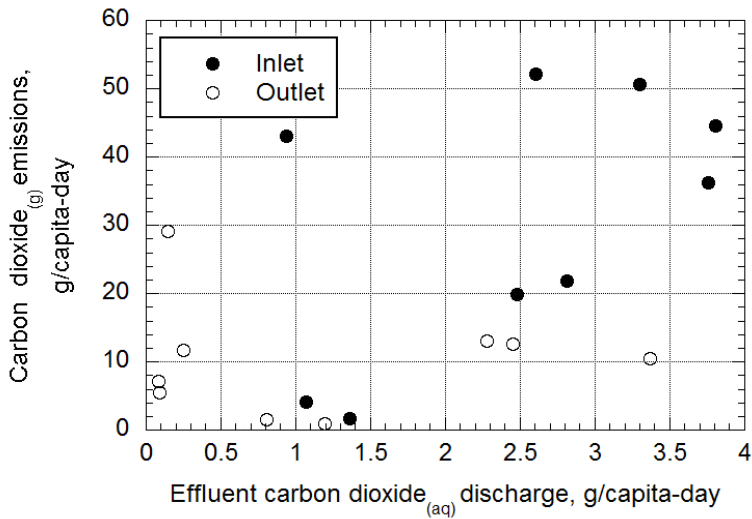

(b)

Figure 5-3. Comparison of Gas Emission Rates from Septic Tanks and from Dissolved Gases in the Septic Tank Effluent: (a) Methane and (b) Carbon Dioxide.

### 5.2.1 Mass Balance on the Septic Tank

A mass balance around the septic tank can be made to compare the results of the gas emission rates measured with the flux chamber and with the vent method for Site 1. Only Site 1 is used for this analysis because cleanout ports that could be used for gas sampling were located

both before and after the septic tank, allowing for differentiation of the tank and soil system emission rates. As shown in Figure 5-4, the gases coming from the soil dispersal system were measured at the cleanout port located in the pipe after the septic tank (vent sample point V-1-2) and the composite gases leaving the tank (soil dispersal system + septic tank) were those measured at the cleanout located before the septic tank (Vent sample point V-1-1). The net emission from the septic tank is obtained by subtracting the gas emission rates value measured at V-1-2 from that at V-1-1. The results from the mass balance, in g/capita-d for methane, carbon dioxide and nitrous oxide are 8.4, 423.4, and 0.29, respectively. These can be compared with values of 17.9, 54.4, and zero as measured using the flux chamber in the septic tank.

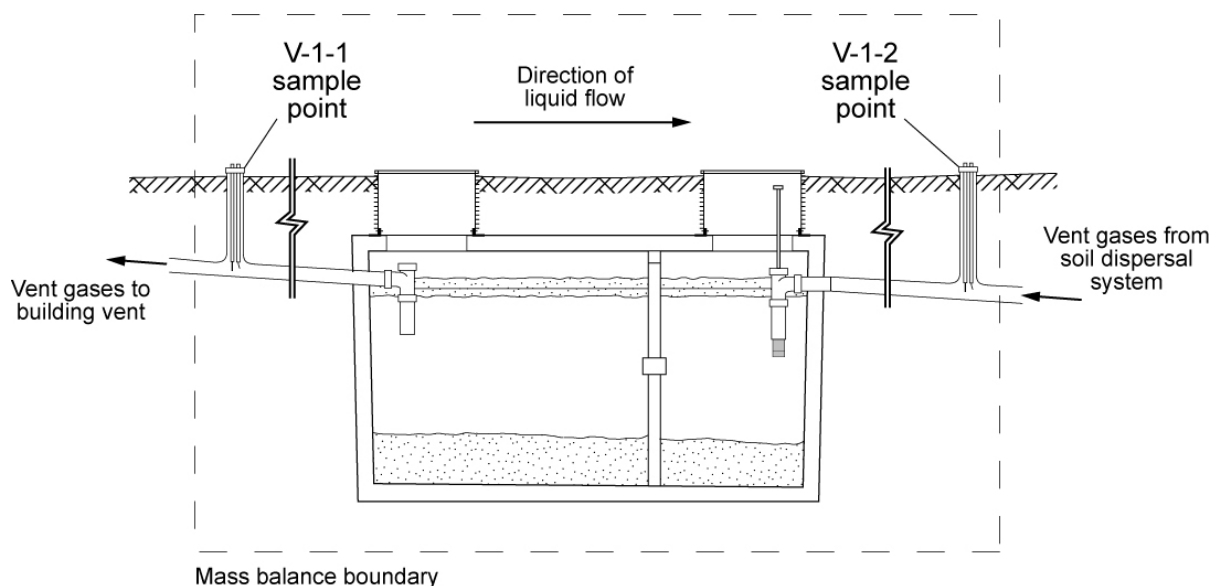

**Figure 5-4. Definition Sketch for Mass Balance for Gases Moving Through the Septic Tank.**

As presented in Table 5-1, the mass balance value for methane using the values measured with the flux chamber was higher than that measured with the vent method. Potential reasons for the positive bias in the flux chamber measurements compared to the vent measurements are (a) the flux chamber method draws samples from near inlet where wastewater enters the tank and possibly results in increased microbial activity, (b) wastewater discharges into the tank cause some mixing in the tank that dislodges gas bubbles from the sludge layer near the inlet, (c) the gas velocity measured in the vent system using the anemometer was lower than the actual mean velocity, and (d) insufficient samples were obtained to characterize the distribution. However, further work is necessary to determine which of these reasons (if any) is the actual cause of the discrepancy. It should be noted that if (a) or (b) is occurring, the value measured using the vent system may be more representative of the actual emission rates, whereas an incorrect velocity measurement (c) would suggest that the flux chamber measurements may be more accurate. Additional sampling should be conducted to eliminate item (d) as a possibility.

Note that methane was not detected above the ambient background in the gas samples taken at sample point V-1-2. However, a relatively high flux of carbon dioxide and nitrous oxide

was determined at sample point V-1-2, resulting from the aerobic degradation of septic tank effluent in the soil. The measured results for all of the GHG's are shown in Table 5-1.

**Table 5-1. Comparison between Mass Balance Values and Actual Measurements for Site 1.**

Site	Gas emission rate, g/capita·d					
	CH <sub>4</sub>		CO <sub>2</sub>		N <sub>2</sub> O	
	MB <sup>a</sup>	FC <sup>b</sup>	MB	FC	MB	FC
1	8.4	17.9	423.4	54.4	0.29	0.0

<sup>a</sup> MB = Result from the mass balance based on subtracting the emission rates measured at V-1-2 from those measured at V-1-1.

<sup>b</sup> FC = Value measured with the flux chamber.

A comparison of the methane emission rates obtained with the flux chamber and the vent method is shown on Figure 5-5. The vent data have less variability than the flux chamber data, as indicated by the shallower slope of the trend line fit through the data. The reduced variability from the vent system data is likely to be the result of the composite nature of the vent sample (flux values averaged over the whole system), compared to the instantaneous measurement obtained with the flux chambers (flux value extrapolated based on emission rate measured for a small area).

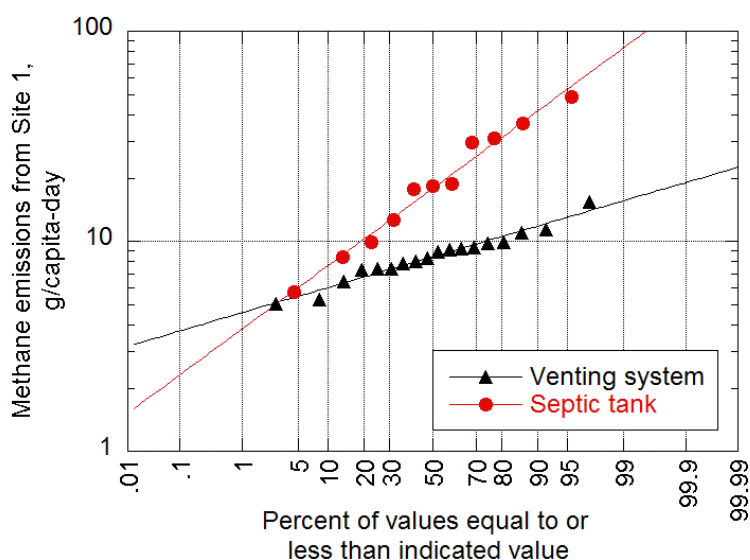

**Figure 5-5. Comparison of Methane Emission Rates from the Venting System ( $R^2=0.96$ ) and the Septic Tank at Site 1 ( $R^2=0.96$ ).**

### 5.2.2 Mass Balance on the Septic System

A mass balance on the septic system was performed to determine the overall atmospheric emissions from the system. As shown in Figure 5-6 the emissions from the entire system consist of atmospheric emissions from the building vent to the air, atmospheric emissions from the soil dispersal system to the air, and gases discharged with the effluent to ground water. It should be

noted that in this approach it is assumed that there are no gases escaping elsewhere in the system. Sites 1 and 7 were used for this analysis because measurements were made from both the vent and above the leach fields. In all cases the discharge of gases to the groundwater was assumed to be negligible.

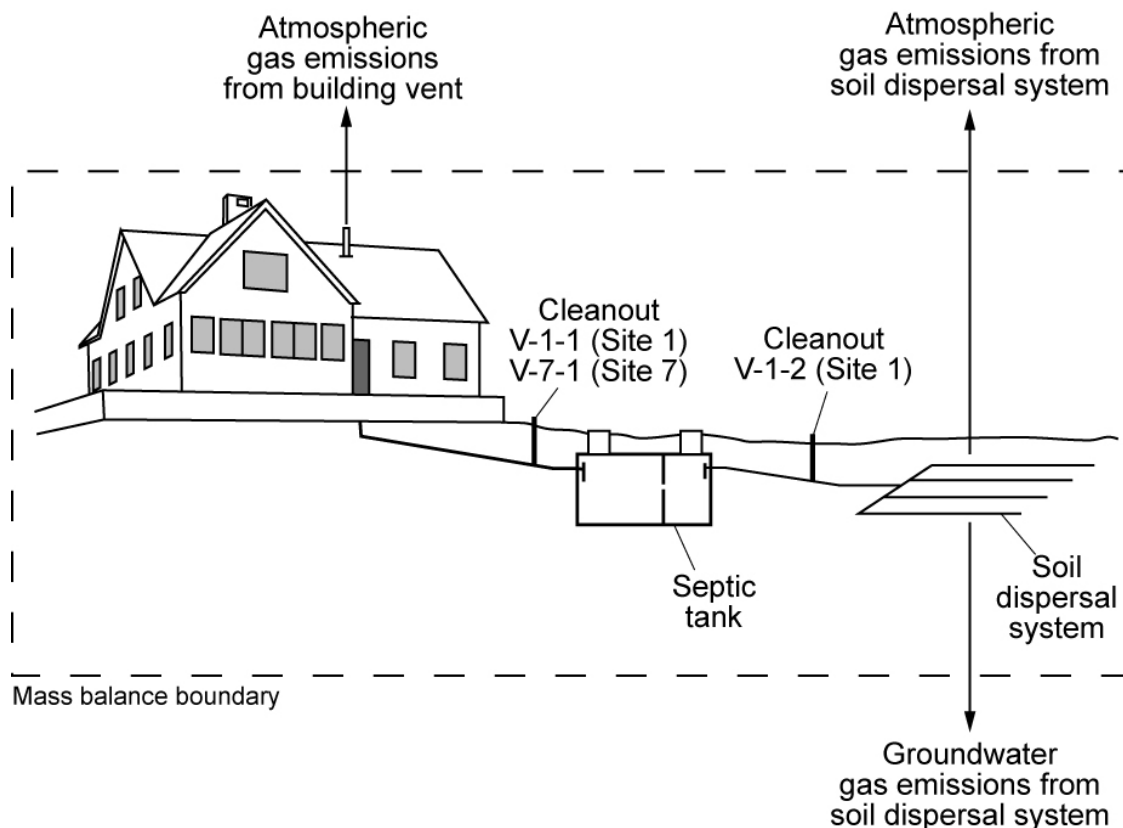

Figure 5-6. Definition Sketch for Mass Balance for Total Gas Emission Rate from the Septic System.

As discussed in Section 5.1.4, the gas emission rates from the soil dispersal system were not significantly different from the experimental control, possibly because the gases are being withdrawn through the ventilation system. Therefore, the overall atmospheric emissions from the septic system can be estimated entirely from the samples taken from the vent system located before the septic tank.

Based on the measurements at V-1-1 the overall geometric mean of the emission rates at Site 1 for methane, carbon dioxide, and nitrous oxide are 8.4, 527.0, and 0.37 g/capita·d, respectively. For Site 7, the emission rate values for methane, carbon dioxide, and nitrous oxide were 13.4, 93.0, and 0.04 g/capita·d, respectively. Note that these values are unadjusted for potential errors in the gas velocity measurement, as noted above. A summary of the mass balance results is presented in Table 5-2.



**Table 5-2. Results of the Mass Balance Analysis on the Emission Rates from Septic Systems.**  
**Note: All of the Atmospheric Gas Emission Rates from These Two Systems were from the Building Vent.**

Site	Gas emission rate, g/capita·day <sup>a</sup>		
	CH <sub>4</sub>	CO <sub>2</sub>	N <sub>2</sub> O
1	8.4	527.0	0.37
7	13.4	93.5	0.04
Average	11.2	310.2	0.20

<sup>a</sup>The reported values correspond to averages from all the vent measurements at each site and can be found in the Appendix H.

### 5.2.3 Mass Balance in the Soil Dispersal System

To determine the fate of carbon present in the septic tank effluent, a mass balance analysis in the soil dispersal system was performed. The input of carbon to the system can be estimated from the COD of the septic tank effluent. The carbon dioxide equivalent of COD was determined using a stoichiometric approach where domestic wastewater is represented by the compound C<sub>10</sub>H<sub>19</sub>O<sub>3</sub>N (Metcalf and Eddy, 2003). The calculation of CO<sub>2</sub> production from COD oxidation is shown in Appendix I.

As discussed previously, direct atmospheric emissions of GHGs from the soil dispersal were determined to be insignificant. The discharge of carbon to the groundwater is assumed to be insignificant. The amount of carbon leaving the soil dispersal system can therefore be estimated by the vent samples obtained from V-1-2 as shown in Figure 5-7. Based on the system carbon balance, the carbon dioxide equivalent of the COD should be approximately equal to the CO<sub>2</sub> leaving the soil dispersal system through the ventilation system.

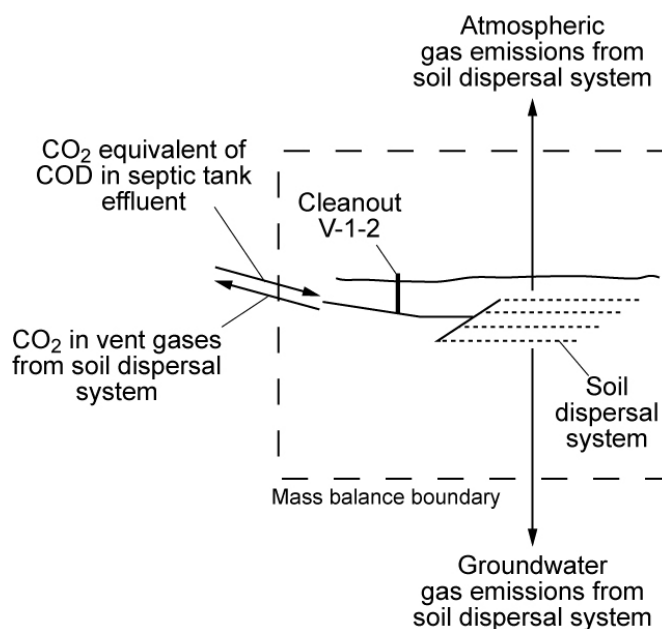

**Figure 5-7. Mass Balance on the Soil Dispersal System.**

The septic tank effluent CO<sub>2</sub> equivalent of the COD is calculated to range from 45-133 g/capita·d, depending on flowrate (see Appendix I), and the average CO<sub>2</sub> emission rates measured at V-1-2 is 104 g/capita·d. The approximate agreement between these values is an indication that the carbon that enters the soil dispersal system is mostly oxidized in the soil to CO<sub>2</sub> and this CO<sub>2</sub> flows back through the drainage pipes and escapes to the atmosphere through the building vent.

#### 5.2.4 Percentage of Methane and Carbon Dioxide in the Overall Emissions

The majority of the gases expected from anaerobic degradation are methane and carbon dioxide. Therefore, the percent of each gas per sample was calculated assuming these were the only two gases present. It was found that at Sites 1 to 7 the average methane content was approximately 35% (by volume) and 65% carbon dioxide (see Figure 5-8). The high carbon dioxide percentage may indicate that there are other microbial processes occurring in the septic tank, such as aerobic or facultative bacterial activity, in addition to methanogenesis. The large amount of air moving through the venting system and headspace of the tank removes methane and carbon dioxide gases and supplies oxygen to the liquid or scum surface, potentially creating an environment for aerobic degradation to take place. Gas emission rates from Site 8 had a higher average methane content, around 65% and therefore 35% for carbon dioxide (see Figure 5-8), which agrees with the results of Winneberger (1984), where a gas mixture composition of approximately 70% methane in a septic tank was reported.

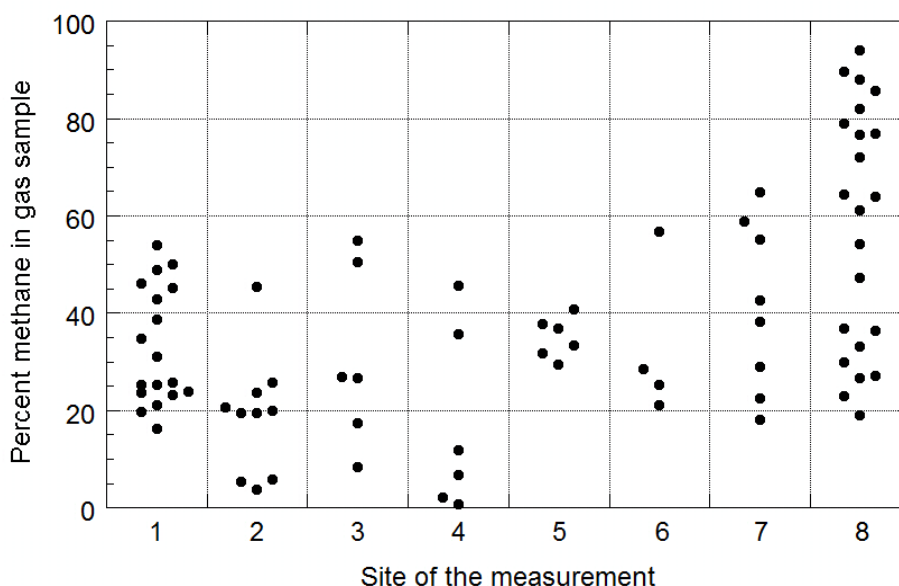

Figure 5-8. Percent Methane in the Gas Mixture at All the Sites.

The mixture that would be expected typically in an anaerobic digester is 65% methane and 35% carbon dioxide (Metcalf and Eddy, 2001). Site 8 has a similar gas mixture composition to the anaerobic digester, which may be an indication that this tank had a higher anaerobic activity than the other tanks. Another reason for the lower average carbon dioxide emission rate at Site 8 is related to the possible reaction of carbon dioxide with the high calcium carbonate content of the water supply, which is discussed in Section 5.3.1.

### 5.3 Sources of Variability in Gas Emissions

A number of factors contributed to the wide variability in the gas emission measurements recorded for the septic systems included in this study. The influence of factors such as water hardness, presence of scum layer, pumping intervals, turnover events, presence of invertebrates, temperature, and the septic tank effluent filter are discussed in this section.

#### 5.3.1 Water Hardness Influence on Carbon Dioxide Emissions

As mentioned previously, the water supply for the Auburn Lakes Trails (ALT) development, encompassing Sites 1 through 7, originates in the Sierra and flows into the Strumpy Meadows Reservoir; it has an average hardness content of 9 mg/L as CaCO<sub>3</sub> (GDPUD, 2009) which indicates a soft water supply. In contrast, the water that serves the tank located in Davis is pumped out from a groundwater well and has an average hardness of 212 mg/L as CaCO<sub>3</sub> (CDPW, 2009) indicating a hard water supply.

A comparison of the carbon dioxide emission rates data between the sites located in ALT and the tank for Site 8 (Figure 5-2) indicates different distributions. It is hypothesized that the hardness content of the water supply in each area may be a reason for this differing behavior. In addition to the difference in source water, Site 8 had other distinguishing characteristics that potentially impacted emissions. Unique aspects at Site 8 include the diversion of laundry water to a gray water system, a higher number of occupants per tank volume, and the vegetarian diet of the house occupants. It is conceivable that these aspects may also influence the overall anaerobic and facultative processes occurring in the tank and hence the carbon dioxide emission rates.

#### 5.3.2 Influence of Scum Layer on Gas Emissions

Two different groups of sites were compared to determine the influence of the scum layer in the overall emissions from the septic tank. The first group was composed of the tanks from Sites 2, 3, and 7 that share as a common characteristic a thick scum layer varying from 3 to 5 inch in depth, with similar appearance, black color, humus like texture and usually covered the liquid surface of the septic tank. The septic tanks at Sites 1, 5, and 6 formed the second group; these tanks were characterized by patchy, light scum (less than 1"), with a light brownish color. As shown on Figure 5-9, the average methane and carbon dioxide emission rates from the sites that have a thick scum layer are similar to the sites without scum and the slopes are also similar. The data from the septic tank at Site 8 (light scum, hard water) was plotted separately for comparison.

#### 5.3.3 Emissions from Recently Cleaned Tank

The septic tank located at Site 4 was not a typical septic tank. It did not have any scum formation; the sludge was less than 14" in depth, with a light brown coloration and a particular pine odor was emitted when the tank lids were opened. The tank was last pumped out in late July of 2009 (measurements took place during September 2009). The methane and carbon dioxide gas emission rates from the tank at Site 4 in g/capita-d, averaged 0.2 and 3.2, respectively. Nitrous oxide emission rates were negligible. From the results of the overall GHG emission rate and the characteristics of the tank discussed above, it can be assumed that methanogenesis was not occurring in this tank, which is consistent with results reported by Weibel et al. (1955) for recently pumped septic tanks, which had a lag phase in the gas production.

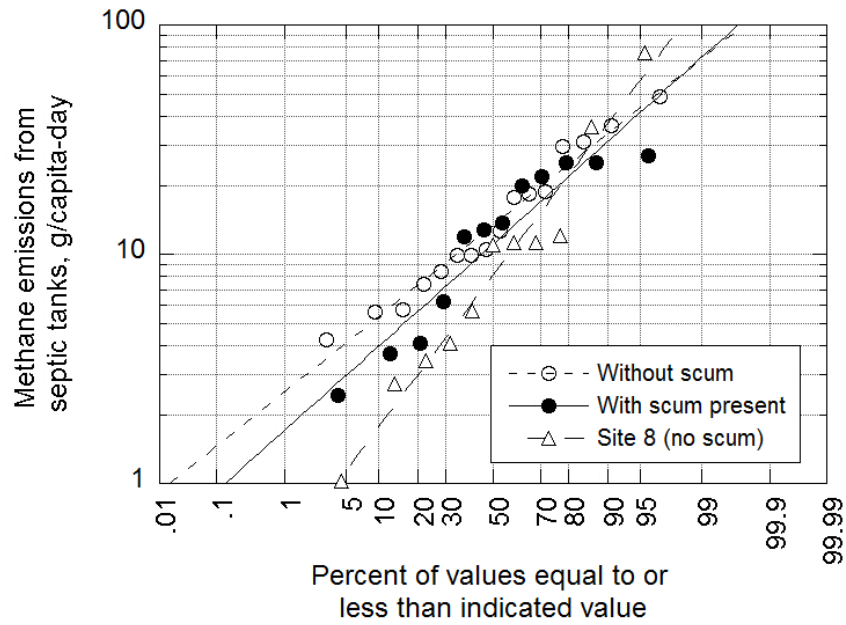

(a)

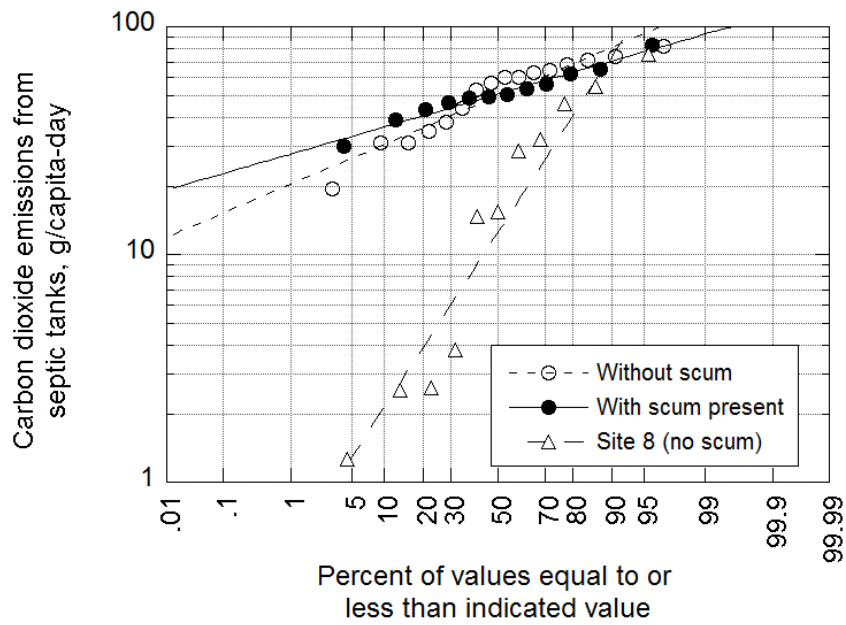

(b)

Figure 5-9. Gas Emission Rates Results Grouped Based on Presence of Scum: (a) Methane and (b) Carbon Dioxide.

### 5.3.4 Influence of Turnover Event on Septic Tank Gas Emissions

Several turnover episodes were observed in the septic tank at Site 1 during the course of the study. As shown in Figure 5-10, during the turnover event, a large number of bubbles and sludge came to the surface, causing the tank contents to mix with subsequent gas release to the atmosphere. A gas sample taken using the flux chamber before the turnover event had a flux of methane of 43 g/capita·d while the methane flux after the turnover event was 18 g/capita·d. The reduction in the emission rates indicates that the tank released the methane gas trapped in the sludge during the turnover events. It was surprising to observe these episodes during fall and early winter in light of the observations of Winneberger (1984) and D'Amato et al. (2008) that these events (will) happen more frequently during the spring and summer months when anaerobic activity increases due to the rise of temperature..



Figure 5-10. Views of Tank at Site 1 (a) Just Before and (b) During a Turnover Event.

### 5.3.5 Variability in Daily GHG Emissions

High variability was observed in the methane emission rates from tank to tank and from sample to sample for a given tank, highlighting the danger of generalizing on the basis of single measurements or single sites. A good example is Site 8, where the 24-hour sampling events took place. As shown in Figure 5-11, two particular periods with comparably high methane emission rates were observed, one at 7:00 am and another at 11:00 pm.

These high emission periods correlated with activities that were taking place in the house at the time of sampling, bathing during the 7:00 am sample and manual dishwashing at the 11:00 pm sample, indicating that the high methane emission rate values may be related to the water usage in the house. It is proposed that the sludge at the bottom of the tank may be disturbed when water is discharged to the septic tank, resulting in the release of gas bubbles that have accumulated in the sludge layer. The flux of carbon dioxide does not appear to follow the same trend as methane, which may be related to the reactions of carbon dioxide in the water. The cause of the low emission rate of carbon dioxide on the 12/10/09 sample event has not been determined.

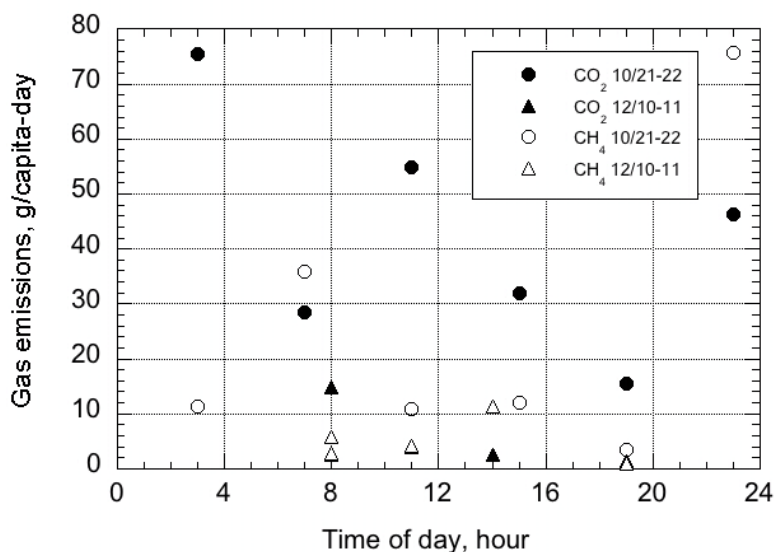

Figure 5-11. Emission Rates from Site 8 During the Two 24-Hour Sampling Events for Methane and Carbon Dioxide.

### 5.3.6 Relation between Invertebrates and Scum Layer

Sites 2, 3 and 7 had a thick scum layer and the presence of invertebrates such as red worms and small flies. It was confirmed that a thick scum layer with dark brown to black coloration and with the appearance of “crumbly earth” or humus were populated by earthworms as reported by Winneberger (1984). It was observed at the time that small flies and its larva were also living on the upper layers of the scum, as previously reported by Dale (1982). However, a larger number of organisms were not found to correspond to a thicker layer of scum as was observed by Dale (1982). Small black larvae were observed at Sites 6 and 8 in where the scum layer was thin (less than 3 cm).

### 5.3.7 Temperature Influence on Gas Emissions

The average liquid temperature inside the tanks ranged from 12-27°C during the four months of sampling. Kinnicutt et al. (1910) and Winneberger (1986) reported a reduction in gas emissions during cold months, however, no correlation between the average liquid temperature inside the septic tanks and the overall methane and carbon dioxide emissions was observed in this study (Figure 5-12). The sites with the largest number of measurements (Sites 1 and 8) were also plotted separately to identify a possible trend with temperature; none is apparent (Figure 5-12 c and d). While it is possible that the sampling duration and range of temperatures in this study were insufficient to characterize the seasonal temperature variation, the more likely reason is that factors other than temperature play a more important role in determining the measured emission rates at any given time/location (for example, the diurnal measurements presented on Figure 5-12).



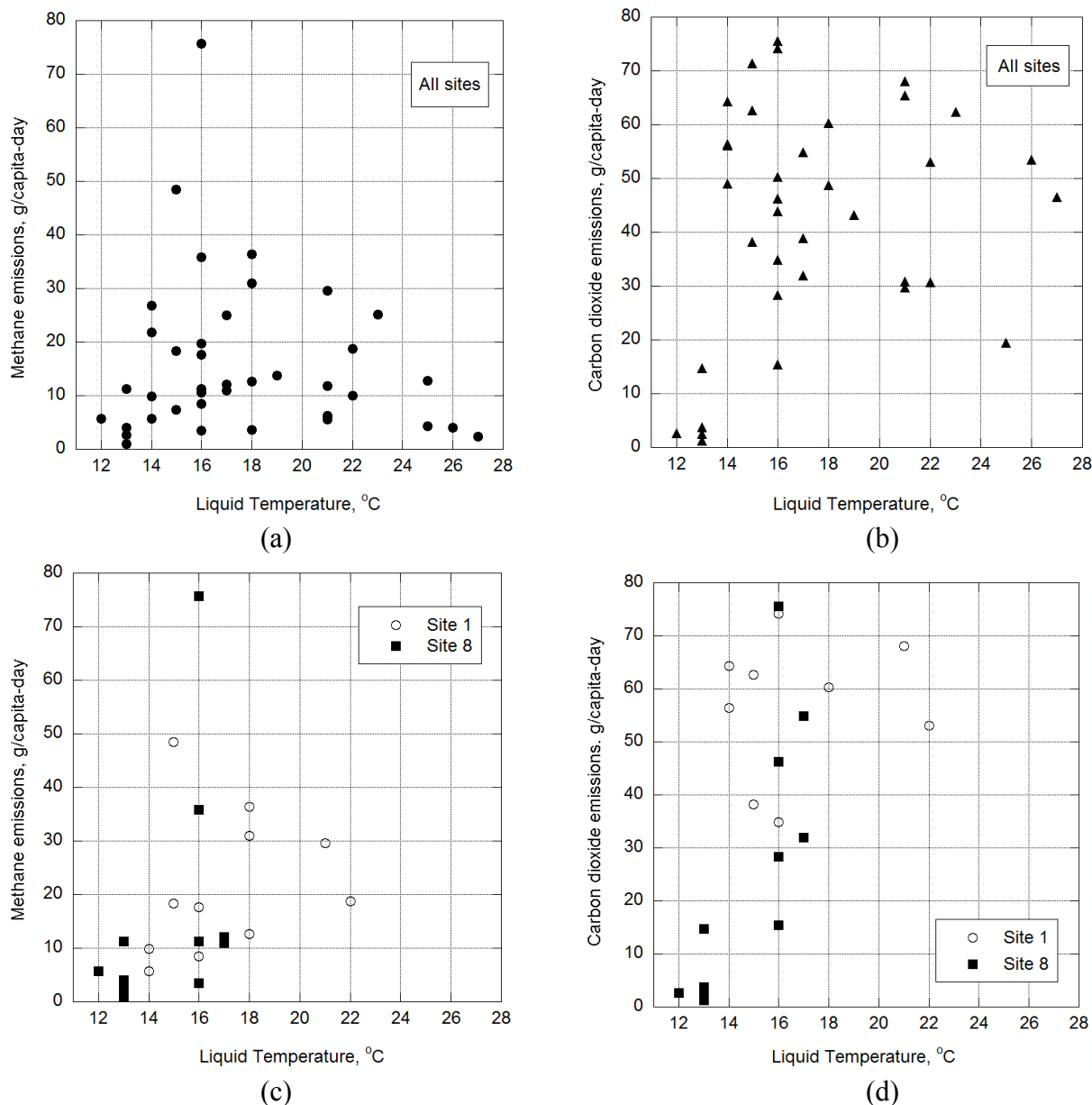

Figure 5-12. Comparison of the Average Gas Emission Rates and the Liquid Temperature: (a) Methane and (b) Carbon Dioxide Emission Rates at Sites 1 to 7, (c) Methane and (d) and Carbon Dioxide Emission Rates at Sites 1 and 8.

### 5.3.8 Influence of the Effluent Filter in the Venting System

The influence of the effluent filter on the air flow from the septic tank through the vent system was evaluated at Sites 1 and 7. It was found that gas flow rates in the passive house venting systems ranged from 150 to 400 m<sup>3</sup>/d when an effluent filter was not present. Effluent filters reduced the air flow through the vent system to a range of 10 to 70 m<sup>3</sup>/d, depending on the type of filter (see Figure 5-13). Thus, it was found that effluent filters may obstruct the natural flow of air through the tank headspace. Flow of air through the tank headspace is important for the evacuation of methane (an explosive gas) and odor causing compounds. Thus, improved designs for effluent filters may be needed to prevent the accumulation of these gases in the tank headspace, particularly under calm weather conditions when flow in the vent systems is reduced.



(a)



(b)

**Figure 5-13. Views of the Effluent Filters: (a) Filter in Effluent Tee and (b) Comparison of Two Types of Filters. Internal Elements of the Filter are Removed for Viewing.**



## CHAPTER 6.0

## IMPLICATION OF RESULTS

An important part of this research is to provide field data that can be used as a basis for comparison with previous studies and for calibration of GHG emission inventory models. In the following discussion, the emissions findings from this study are: 1) compared to values found in the literature review and model values and 2) evaluated in terms of their global warming potential.

### 6.1 Comparison of Gas Emissions to Literature Values and Models

A summary of the literature emission values and those measured using the flux chamber is presented in Table 6-1. The average methane emission rate obtained using flux chambers in the septic tanks were in general agreement with the estimates of methane emission rates based on the COD loading and Kinnicutt et al. (1910) models. However, these averages are somewhat lower than the estimates from Winneberger (1984) and Sasse (1998) and much lower than the IPCC (2007) model for methane emission rate in septic tanks.

**Table 6-1. Summary of Methane Emission Rates, Including this Study.**

Method	Year	Methane estimate (g CH <sub>4</sub> /capita·d)
Kinnicutt et al.	1910	10.1 <sup>a</sup>
Winneberger	1984	14 to 18 <sup>a</sup>
COD loading	2010	11 <sup>b</sup>
IPCC	2007	25.5 <sup>c</sup>
Sasse	1998	18 <sup>d</sup>
This study	2010	11.0 (s <sub>g</sub> = 2.50) <sup>a,e</sup>

<sup>a</sup> Measured value from community septic tanks.

<sup>b</sup> Calculated value assuming that 40% of solids are removed as septage (see Appendix B).

<sup>c</sup> Calculated value assuming that half of the influent BOD is converted anaerobically (see Appendix C).

<sup>d</sup> Calculated value assuming 25% CH<sub>4</sub> dissolved (see Appendix D).

<sup>e</sup> Geometric mean and standard deviation as determined using flux chamber method, this study.

One reason for the difference between the measurements presented here and those determined from the IPCC (2007) model is that the IPCC (2007) model assumes that half of the influent BOD to the septic tank is converted anaerobically. Further, the fate of organic matter present in septage and septic tank effluent is not accounted for clearly. It is likely that the measurements made by Winneberger (1984) are high because not enough samples were obtained to establish a statistical distribution. The values used in the Sasse (1998) model were based on statistics from septic tanks located in developing countries, which may operate at higher temperatures and loading rates, resulting in higher methane emission rates.

It is important to note that the U.S. EPA (2010) GHG emissions model for septic systems uses an approach similar to the IPCC (2007) model; using a methane correction factor (MCF) of 0.5 (see Section 2.5.2). However, this value does not specifically account for the fate of the sludge when the tank is cleaned out or for effluent BOD oxidation in the soil dispersal system. Based on the mean methane emission value measured in this study (11 g CH<sub>4</sub>/capita·d), an MCF value of about 0.22 would be applicable for the systems evaluated in this research project.

## 6.2 CO<sub>2</sub> Equivalent of Gas Emissions Values

The septic tank emission rates for methane and nitrous oxide have been converted to CO<sub>2</sub>-equivalent (CO<sub>2</sub>e) emissions using the global warming potential for a 100 year horizon based on the IPCC (1996) values. The CO<sub>2</sub>e is calculated by multiplying the measured emission rates by the GWP, as summarized in Table 6-2.

**Table 6-2. Summary of Emission Rates as CO<sub>2</sub>e from the Septic Tank and Vent Average Measurements.**

Compound	Geometric mean emission rate value (g/capita·d)		GWP <sup>a</sup>	Carbon dioxide equivalent emissions (tonne CO <sub>2</sub> e/capita·year)	
	Septic tank	Septic system <sup>b</sup>		Septic tank	Septic system <sup>b</sup>
Methane	11.0	10.7	21	0.084	0.082
Nitrous oxide	0.005	0.20	310	0.00057	0.023
Carbon dioxide	33.3	335	1	0.012	0.12
Total GHG emissions				0.096	0.23
Total anthropogenic emissions <sup>c</sup>				0.085	0.10

<sup>a</sup> GWP for a 100 year horizon IPCC (1996).

<sup>b</sup> As determined from vent system sampling.

<sup>c</sup> Biogenic carbon dioxide is not included in GHG inventories (U.S. EPA, 2009).

As shown in Table 6-2, methane generation from the septic tank is the primary source of anthropogenic GHG emissions. The CO<sub>2</sub>e GHG emission rates from septic tank systems determined using either the flux chamber or mass balance methods are relatively low compared to those for a citizen of an industrialized country (about 23 tonne CO<sub>2</sub>e/capita·year; U.S. EPA, 2010). Using the total emission values reported in U.S. EPA (2010), the per capita GHG emissions associated with wastewater treatment are 0.13 and 0.92% for centralized and decentralized (i.e., systems with onsite septic tanks), respectively. However, using the adjusted emission values as determined in this study, the GHG emissions associated with septic tank type systems are about 0.47% of the average per capita GHG emissions, resulting in an estimated total emission of about 6.5 Tg CO<sub>2</sub>e/year from septic tank systems. It should be noted that these GHG inventories do not account for the embodied GHG emissions associated with construction or maintenance of infrastructure, process chemical and energy inputs, or downstream environmental impacts. Thus, this type of GHG emissions comparison is limited in that it is based solely on fugitive methane and nitrous oxide emissions.

## CHAPTER 7.0

## FINDINGS AND RECOMMENDATIONS

The major findings of this research study, other findings, and recommendations for future studies are presented in this section.

### 7.1 Major Findings

The principal findings from this research are:

- ◆ The geometric mean of the total emission rates for methane, carbon dioxide, and nitrous oxide based on samples from the vent system were 10.7 ( $s_g = 1.65$ ), 335 ( $s_g = 2.13$ ), and 0.20 ( $s_g = 3.62$ ) g/capita·d, respectively.
- ◆ The CO<sub>2</sub>e of the methane emission rate to the atmosphere, as determined from the vent system data in this study, is about 0.10 tonne CO<sub>2</sub>e/capita·yr. Based on the current estimated per capita CO<sub>2</sub>e emission rate for the United States (i.e., 23 tonne CO<sub>2</sub>e/capita·yr; U.S. EPA, 2010), the septic tank system accounts for about 0.5% of the total per capita emission.
- ◆ The septic tank methane flux values determined by the flux chamber method were found to have a log-normal distribution, with a geometric mean ( $M_g$ ) of 11.0 g/capita·d and geometric standard deviation ( $s_g$ ) of 2.50. Similarly, the values of  $M_g$  for carbon dioxide and nitrous oxide were 33.3 ( $s_g = 2.73$ ) and 0.005 ( $s_g = 4.35$ ) g/capita·d, respectively.

### 7.2 Other Findings

Other findings from this research are:

- ◆ There was general agreement for methane gas emission rates determined with theoretical models and measured with the flux chamber and vent methods.
- ◆ There is considerable variability in the methane gas fluxes from tank to tank and sample to sample.
- ◆ The hardness of the water supply appears to influence the overall flux of carbon dioxide, with soft water systems having higher carbon dioxide gas fluxes.
- ◆ A correlation between the GHG emission rates from the septic tank and the liquid temperature was not observed, perhaps as a result of the limited duration of the study.
- ◆ The presence or absence of a scum layer had no discernable influence on emission rates of methane and carbon dioxide.
- ◆ The carbon (measured as COD) in the septic tank effluent discharged to the soil dispersal system was approximately equal to the amount of carbon being vented (measured as carbon dioxide) from the soil dispersal system.

- ◆ Methane generated during the anaerobic digestion process was found in both gaseous and aqueous forms but no relation was found between the gas and liquid phase concentrations.
- ◆ Nitrous oxide emission rates from septic tanks were found to be negligible; however nitrous oxide was detected in the gases vented from the soil dispersal system.
- ◆ Essentially no gas emissions from the soil surface were measured using flux chambers placed above the soil dispersal system trenches.
- ◆ Using the mean methane emission value measured for the septic tanks from this project, an MCF value of 0.22 was calculated.

### 7.3 Recommendations

Based on the findings of this research, the following recommendations are proposed for future studies of greenhouse gas emissions from septic tank systems:

- ◆ Due to the uncertainty in several operational parameters, such as temperature and water hardness, and their influence on the production of septic tank gases, further study in other regions of the country is recommended.
- ◆ In this study, only direct GHG emissions from operational septic systems were evaluated. A follow up study quantifying the GHG emissions associated with various septage management practices is needed.
- ◆ The soil dispersal systems in this study were well drained and did not have any ponding. The evaluation of soil dispersal systems in other soil types and at different stages of ponding is needed. In addition, studies on alternative soil dispersal systems, such as pressure and drip irrigation systems, are needed.
- ◆ Only conventional septic tank systems were evaluated in this study. Additional research is needed to quantify gas emissions from alternative onsite wastewater systems, such as natural treatment systems, packed bed filters, and other aerobic treatment processes.
- ◆ A study is needed to evaluate the development of methanogenesis in septic tanks from the time of start-up, with and without inoculation.
- ◆ The methods for sampling of gases from ventilation systems should be further developed and refined.
- ◆ Further study is needed to develop technologies for the control of GHG emissions from wastewater systems is needed, including soil-based filtration and stand-alone biofiltration processes. Integration of these types of control systems may require slight modifications to the aspects of the building code related to septic tank ventilation systems.
- ◆ A study is needed to determine the correlation between the GHG emissions and the septic tank influent quality and loading.
- ◆ Further work should be conducted to quantify GHG emissions from all types of wastewater management systems so that accurate models can be developed.

## APPENDIX A

# COD LOADING PER CUBIC METER CALCULATION IN SEPTIC TANKS

The COD loading into a septic tank was calculated assuming two people per residence and two different tank sizes: 1,000 and 1,500 gallons.

1. Determine the total COD loading per day  
The quantity of COD discharged per person is assumed to be 200 g/capita·d (Crites and Tchobanoglous, 1998):  
Total COD loading is 400 g/d (for two people)
2. Assuming a tank volume of 1,000 gallons  
(400 g/d) / (3.78 m<sup>3</sup>) is equal to 106 g COD/m<sup>3</sup>·d
3. Assuming a tank volume of 1,500 gallons  
(400 g/d) / (5.68 m<sup>3</sup>) is equal to 70 g COD/m<sup>3</sup>·d
4. COD loading ranges between 70 and 106 g/m<sup>3</sup>·d

It should be noted that in the above computation the 200 g/capita·d represents the total COD and it is not differentiated between soluble and particulate COD. Particulate COD is expected to primarily settle out in the septic tank while dissolved COD will primarily leave the septic tank with the effluent flow. The referenced values used in the computations presented in Appendixes A and B are based on typical septic tank systems.



## APPENDIX B

## ESTIMATE OF METHANE EMISSIONS FROM SEPTIC TANK SYSTEM BASED ON VSS AND COD LOADING

Determine the theoretical amount of methane released per day per person discharging wastewater to a septic tank, which is pumped on a 6 yr interval. Note that for a new tank, there may be a lag in methane production, for example methane production may not occur until spring if the tank is pumped in the winter. Also, some people recommend leaving some sludge in the tank for inoculation to promote methanogenesis.

### A. Based on VSS Loading

1. Determine the total VSS loading per day

The quantity of VSS discharged per person is 35 g/capita·d (Crites and Tchobanoglous, 1998). The total VSS loading over the 6 yr operational period is 154 kg VSS for 2 people.

2. Determine the effluent VSS discharged from the septic tank

Effluent VSS can be estimated from the effluent TSS. Typical effluent TSS is 85 mg/L (Crites and Tchobanoglous, 1998), and assuming an effluent VSS to TSS ratio of 0.5, the effluent VSS is 42.5 mg/L. The total VSS loading in the effluent over the 6 yr operational period is 41 kg VSS for 2 people.

3. Estimate the total VSS removed as septage after 6 yr (U.S. EPA, 1994)

Assume the septage removed has a VSS of 9 g/L and a volume of 4,000 L

The VSS removed as septage is equal to 36 kg VSS after the 6 yr operational period.

4. Estimate the VSS converted to gas

The VSS converted to gas is determined by subtracting the effluent VSS loading (41 kg) and the septage VSS (36 kg) remaining in the tank from the influent VSS daily loading (154 kg). The resulting VSS converted to gas is  $154 \text{ kg} - 41 \text{ kg} - 36 \text{ kg} = 77 \text{ kg}$  (over the 6 yr operational period). Thus, the overall VSS destruction rate in the septic tank is estimated to be 50 percent.

5. Determine the methane produced each day per capita

Assuming gas production rates of  $1 \text{ m}^3/\text{kg}$  VSS converted, gas composition of 60 percent methane (Tchobanoglous et al., 2003), the methane emission rate is determined to be:

$$\begin{aligned} \text{Methane production} &= [(77 \text{ kg VSS} \times 1,000 \text{ g/kg} \times 0.6) / (6 \text{ yr} \times 365 \text{ d/yr} \times 2 \text{ capita})] \\ &= 10.6 \text{ g/capita}\cdot\text{d} \end{aligned}$$

**B. Based on COD Loading**

1. Determine the total COD loading per day  
The quantity of COD discharged per person is 200 g/capita·d (Crites and Tchobanoglous, 1998):
2. Determine the amount of COD retained in septic tank per day  
Assume 60 percent of the influent COD is retained in the septic tank  
The COD remaining in the tank each day is equal to 120 g/d (200 g/d x 0.6)
3. Estimate the total COD removed as septage after 6 yr  
Assume the septage removed has a COD of 40 g/L (U.S. EPA, 1994) and volume of 4,000 L  
The COD removed as septage is equal to 160,000 g (40 g/L x 4,000 L)
4. Convert total COD in septage to equivalent daily value  
For 6 yr time period, the daily COD value in the septage is equal to 73 g/d [160,000 g/(6 yr x 365 d/yr)]
5. Estimate the COD converted to methane (CH<sub>4</sub>)  
The COD converted to gas is the difference of daily loading (120 g/d) and the daily equivalent of COD of the removed septage (73 g/d)  
The COD converted to gas is 47 g/d (120g/d – 73 g/d)
6. Conversion of COD to methane at standard conditions (Tchobanoglous et al., 2003).  
COD of CH<sub>4</sub> is the amount of O<sub>2</sub> needed to oxidize CH<sub>4</sub> to CO<sub>2</sub> and H<sub>2</sub>O  

$$\text{CH}_4 + 2\text{O}_2 = \text{CO}_2 + \text{H}_2\text{O}$$

$$2(32\text{g O}_2/\text{mole}) = 64\text{ g O}_2/\text{mole CH}_4$$
The volume per mole of CH<sub>4</sub> at standard conditions is 22.4 L. Therefore, the CH<sub>4</sub> equivalent of COD converted under anaerobic conditions is (22.4 L/64 g)  
The conversion of COD to methane is equal to 0.35 L CH<sub>4</sub>/ g COD
7. Determine the volume of gas produced each day per capita  
Assume the following conversion factors apply  
Density of CH<sub>4</sub> is equal to 0.67 g/L (Density at 20 °C)  
Methane volume produced is equal to 16.45 L/d [(47 g COD/d)·(0.35 g/L CH<sub>4</sub>/ g COD)]  
Mass of CH<sub>4</sub> is 11.0 g/d [(16.45 L/d) (0.67 g/L)]  
The contribution of CH<sub>4</sub> per person is equal to 11.0 g/capita·d



## APPENDIX C

## ESTIMATE OF METHANE EMISSIONS FROM SEPTIC TANK SYSTEM BASED ON IPCC METHODOLOGY (1996, 2007)

The following estimate was based on the methodology developed in the IPCC guidelines for National Greenhouse Gas Inventories, Chapter 6, Methane Emission from Wastewater. Calculations will be based on per-capita basis.

1. Estimate organically degradable carbon in wastewater (TOW)

$TOW = P \times BOD \times I \times 365$ , where:

Where TOW = total organics in wastewater in kg BOD/yr

P = population

BOD = U.S. per capita BOD in inventory year (value taken from Table 6.4, Estimated BOD<sub>5</sub> values in domestic wastewater for selected regions and countries. The values are an assessment of the literature. Chapter 6, IPCC, 2006)

I = correction factor, default value 1.0

$TOW = 1 \text{ person} \times 85 \text{ g BOD/capita}\cdot\text{d} \times 1.0 \times 0.001 \text{ kg/g} \times 365 \text{ d/yr}$

$TOW = 31.03 \text{ kg BOD/capita}\cdot\text{yr}$

2. Calculate the methane CH<sub>4</sub> emission factor (EF<sub>j</sub>)

$EF_j = B_0 \times MCF_j$ , in kg CH<sub>4</sub>/kg BOD

Where B<sub>0</sub> = maximum CH<sub>4</sub> producing capacity in kg CH<sub>4</sub>/kg BOD (value taken from Table 6.2, Default maximum methane producing capacity for domestic wastewater. Chapter 6, IPCC 2006)

MCF<sub>j</sub> = methane correction factor for septic tanks (value taken from Table 6.3, Default methane conversion values for domestic wastewater. Chapter 6, IPCC 2006)

$EF_j = 0.6 \text{ kg CH}_4/\text{kg BOD} \times 0.5$

$EF_j = 0.3 \text{ kg CH}_4/\text{kg BOD}$

3. Estimate the per capita CH<sub>4</sub> emission

Methane emission = TOW x EF<sub>j</sub> in g CH<sub>4</sub>/capita·d

CH<sub>4</sub> = (31.03 kg BOD/ capita·yr) (0.3 kg CH<sub>4</sub> /kg BOD)

9.3 kg CH<sub>4</sub>/capita·yr = 25.5 g CH<sub>4</sub>/capita·d

Comment:

It should be noted that in the above computation it is assumed that half of all influent BOD is converted anaerobically.



## APPENDIX D

## ESTIMATE OF METHANE EMISSIONS FROM SEPTIC TANK SYSTEM BASED ON SASSE (1998)

The model presented below was developed by Sasse (1998) based on observations of septic tank operation primarily from developing countries. The model parameters, including BOD<sub>5</sub>, water consumption per capita, COD/BOD ratio, septic tank dimensions, and dissolved methane content in water were adjusted to be consistent with typical septic tank design parameters in the U.S.

1. Table 22 from Sasse (1998), wastewater production per capita. The highlighted values in the table were calculated using the following assumptions:
  - Population: 1
  - BOD: 85 g/capita-d (Table 4.12, Crites and Tchobanoglous, 1998)
  - Water consumption: 300 L/capita (Average water used in individual residences, Crites and Tchobanoglous, 1998)
  - COD/BOD: 2.33 (COD and BOD values taken from Table 4.12, Crites and Tchobanoglous, 1998)

**Table D-1. Wastewater Production Per Capita.**

User	BOD <sub>5</sub> per user	Water consumption per user	COD /BOD <sub>5</sub> ratio	Daily flow of wastewater	BOD <sub>5</sub> conc.	COD conc.
(1)	(2)	(3)	(4)	(5)	(6)	(7)
Given	Given	Given	Given	Calc.	Calc.	Approx.
Number	g/d	L/d	mg/L / mg/L	m <sup>3</sup> /d	mg/L	mg/L
1	85	300	2.33	<b>0.3</b>	<b>283</b>	<b>660</b>

- 1.1 Calculation of daily flow of wastewater, m<sup>3</sup>/d – Column (5)  
 Daily Flow of wastewater = number of users x water consumption per user  
 Daily Flow of wastewater = 1 x 300 L/d x 10<sup>-3</sup> m<sup>3</sup>/L = 0.3 m<sup>3</sup>/d
- 1.2 Calculation of BOD<sub>5</sub> concentration, mg/L – Column (6)  
 BOD<sub>5</sub> = BOD<sub>5</sub> / Daily Flow of wastewater  
 BOD<sub>5</sub> = (85 g/d) / (0.3 m<sup>3</sup>/d) = 283 mg/L
- 1.3 Calculation of the approximate COD concentration, mg/L – Column (7)  
 COD = COD / BOD<sub>5</sub> x BOD<sub>5</sub>  
 COD = 2.33 x 283 mg/L = 660 mg/L

2. First row of Table 23 from Sasse (1998), general spread sheet for septic tank, input and treatment data. The highlighted values on the table were calculated using the previous values from Step 1 and assuming 12 hours as the time of most wastewater flow and SS/COD ratio equal to 0.42 mg/L.

**Table D-2a. General Spread Sheet for Septic Tank, Input and Treatment Data.**

Daily waste water flow	Time of most waste water flow	Max flow at peak hours	COD inflow	BOD <sub>5</sub> inflow
(1)	(2)	(3)	(4)	(5)
Given m <sup>3</sup> /d	Given h	Calc. m <sup>3</sup> /h	Given mg/L	Given mg/L
0.3	12	<b>0.025</b>	660	283
COD/BOD <sub>5</sub>				2.33

**Table D-2b. General Spread Sheet for Septic Tank, Input and Treatment Data (Continued).**

HRT inside tank	Settleable SS/COD ratio	COD removal	COD outflow	BOD <sub>5</sub> outflow
(6)	(7)	(8)	(9)	(10)
Chosen h	Given mg/L / mg/L	Calc. %	Calc. mg/L	Calc. mg/L
24	0.42	<b>36%</b>	<b>421</b>	<b>175</b>

- 2.1 Calculation of maximum flow at peak hours, m<sup>3</sup>/h – Column (3)  
 Maximum daily flow = Daily wastewater flow, m<sup>3</sup>/d / time of most wastewater flow, hr/d  
 Maximum daily flow = 0.3 m<sup>3</sup>/d / 12 h/d = 0.025 m<sup>3</sup>/h
- 2.2 Calculation of the COD removal, % – Column (8)  
 To calculate the COD removal, Sasse (1998) propose a factor of 0.6. This factor takes into account that in a septic tank the COD removal rate depends on the amount of settleable solids, their COD content, and the intensity of inoculation of fresh inflow. The COD removal is calculated based on the chosen HRT (24 hr).  

$$\text{COD removal} = (\text{SS} / \text{COD}) / 0.6 \times \{[(\text{HRT} - 3) \times (0.15 / 27)] + 0.4\}$$

$$\text{COD removal} = 0.42 / 0.6 \times \{[24 - 3] \times (0.15 / 27)] + 0.4\} = 36\%$$
- 2.3 Calculation of the COD outflow, mg/L – Column (9)  

$$\text{COD outflow} = (1 - \text{COD removal rate}) \times \text{COD inflow}$$

$$\text{COD outflow} = (1 - 0.36) \times 660 \text{ mg/L} = 421 \text{ mg/L}$$
- 2.4 Calculation of the BOD removal, %  
 The equation to calculate the BOD removal is related to Fig. 65 in Sasse (1998), the simplified curve of change in the COD/BOD ratio during anaerobic treatment. The BOD removal is based on the COD removal rate (36%).  
 For a COD removal less than 0.5, the COD/BOD removal ratio is 1.06  
 Therefore, BOD removal is (0.36)(1.06) = 0.38 or 38%
- 2.5 Calculation of the BOD outflow, mg/L – Column (10)  

$$\text{BOD outflow} = [1 - (\text{BOD removal})] \times \text{BOD}$$

$$\text{BOD outflow} = [1 - (0.38)] \times 283 \text{ mg/L} = 175 \text{ mg/L}$$

3. Second row of Table 23 from Sasse (1998), dimensions of septic tank. The highlighted values on the table were calculated using the following assumptions:
- Desludging interval: 72 months, corresponding to 6 yr pump out interval
  - Typical septic tank dimensions:
    - Inner width of 1.25 m
    - Inner length of first chamber of 1.5 m
    - Water depth at outlet point of 1.25 m
    - Length of second chamber of 1 m
  - Dissolved methane: 25 percent

Table D-3a. Dimensions of Septic Tank.

Desludging interval	Inner width of septic tank	Minimum water depth at outlet point	inner length of first chamber	
(1)	(2)	(3)	(4)	(5)
Chosen	Chosen	Chosen	Required	Chosen
mo	m	m	m	m
72	1.25	1.25	0.48	1.5

Table D-3b. Dimensions of Septic Tank (Continued) and Biogas Production.

Length of second chamber		Volume including sludge	Actual volume of septic tank	Biogas 70% CH <sub>4</sub> (25% dissolved)
(6)	(7)	(8)	(9)	(10)
Required	Chosen	Required	Check	Calc.
m	m	m <sup>3</sup>	m <sup>3</sup>	m <sup>3</sup> /d
0.24	1	<b>1.13</b>	<b>3.90</b>	<b>0.03</b>
Sludge L/g BOD rem -->		<b>0.0021</b>		

- 3.1 Calculation of sludge volume (Sasse, 1998), sludge L/g BOD remaining  
The sludge removal BOD depends on the desludging interval, for this case 72 months. Sludge removed as BOD = if desludging interval < 120 → 0.005 x 0.5 - [(desludging interval - 36) x 0.002]
- Sludge volume = 0.005 x 0.5 - [(72-36) x 0.002] = 0.0021 sludge L/g BOD remaining
- 3.2 Tank volume required including sludge storage, m<sup>3</sup> – Column (8)  
Volume required including sludge storage = 2 x daily flow, m<sup>3</sup>/d x HRT, h / 24 h/d x inner width of septic tank chosen, m x inner length of first chamber chosen, m  
Volume including sludge = 2 x 0.3 m<sup>3</sup>/d x 24 hr / 24 hr/d x 1.25 m x 1.5 m = 1.13 m<sup>3</sup>
- 3.3 Calculation of actual volume of septic tank, m<sup>3</sup> – Column (9)  
Actual volume of septic tank = (inner length chosen, m + length of second chamber chosen, m) x (minimum water depth at outlet point chosen, m) x (inner width of septic tanks chosen, m)  
Actual volume of septic tank = (1.5 m + 1 m) x 1.25 m x 1.25 m = 3.9 m<sup>3</sup>
- 3.4 Calculation of biogas production, m<sup>3</sup>/d –Column (10)  
A ratio of COD to methane equal to 0.35 L/g COD at standard conditions was used in the equation proposed by Sasse (1998) to calculate the biogas production.

Biogas production =  $(\text{COD}_{\text{inflow}} - \text{COD}_{\text{outflow}}, \text{mg/L}) \times \text{daily flow, m}^3/\text{d} \times 0.35 \text{ L}/1000 \text{ mg}$   
 $\times 70\% \text{ CH}_4 \times (100 - 25\% \text{ dissolved CH}_4)$

Biogas production =  $(660 \text{ mg/L} - 421 \text{ mg/L}) \times 0.3 \text{ m}^3/\text{d} \times 0.35 \text{ L}/1000 \text{ mg} \times 0.7 \times (1 - 0.25) = 0.03 \text{ m}^3/\text{d}$

4. Calculation of methane production (g/capita·d) using density of methane equal to 0.67 g/L (density at 20°C)

Methane production = biogas production,  $\text{m}^3/\text{d} \times 10^3 \text{ L}/\text{m}^3 / 1 \text{ person}$

Methane production =  $0.03 \text{ m}^3/\text{d} \times 10^3 \text{ L}/\text{m}^3 / 1 \text{ person} = 26.9 \text{ L}/\text{capita}\cdot\text{d} \times 0.67 \text{ g/L} =$

Methane production = 18 g/capita·d

## APPENDIX E

# VIAL VACUUMING PROCEDURES

(see Figure E-1)

1. Turn on the pump and then the pressure gauge.
2. Let the pressure stabilize at 12 millitorr (approximate  $2.32 \times 10^{-4}$  psi).
3. Take off the caps on the needles and close all the vials.
4. Insert one vial into each needle.
5. Open the extraction valves and wait approximately 30 sec until the pressure is again at 12 millitorr.
6. Remove the vials from the needles.
7. Repeat steps 4 - 6 for all the vials needed in the sampling event.
8. Turn off the pressure gauge and then the pump.
9. Put the caps back on the needles.



Figure E-1. View of Apparatus Used to Evacuate Vials.





APPENDIX F

# SAMPLING FORMS FOR THE DIFFERENT COMPONENTS OF THE SEPTIC SYSTEM

SAMPLING FROM LIQUID SURFACE						
<b>Date:</b>				<b>Hour:</b>		
<b>SITE NUMBER</b>						
<b>Sample Volume</b>	24	ml	<b>Time interval</b>	2	min	
<b>CHARACTERISTIC</b>	<b>INLET</b>		<b>OUTLET</b>			
Scum						
<b>Water temperature</b>	0ft _____	1ft _____	2ft _____	3ft _____	4ft _____	
<b>Water temperature</b>	0ft _____	1ft _____	2ft _____	3ft _____	4ft _____	
Inlet (in) outlet (out) Duplicate (D)	Sample (number)	Time	Start time (min:sec)	Final time (min:sec)	Temperature °C	
		0				
		1				
		2				
		3				
		4				
		0				
		1				
		2				
		3				
		4				
Water Quality	pH	Dissolved solids (mg/L)	Redox (mV)			
Inlet						
Outlet						
<b>Comments:</b>						

**SAMPLING FROM SOIL SURFACE**



<b>Date:</b>			<b>Hour:</b>		
<b>SITE NUMBER</b>					
<b>Sample Volume</b>	24	ml	<b>Time interval</b>	10	min
<b>Insert number</b>	<b>Sample (number)</b>	<b>Time</b>	<b>Start time (min:sec)</b>	<b>Final time (min:sec)</b>	<b>Temperature °C</b>
1		0			
		1			
		2			
		3			
2		0			
		1			
		2			
		3			
3		0			
		1			
		2			
		3			
4		0			
		1			
		2			
		3			
5		0			
		1			
		2			
		3			
6		0			
		1			
		2			
		3			
<b>Comments:</b>					

**SAMPLING FROM VENT SYSTEM**



<b>Date:</b>						<b>Hour:</b>									
<b>SITE NUMBER</b>															
<b>Sample Volume</b>				24		ml		<b>Time interval</b>				2		min	
<b>Vent number</b>		<b>Sample (number)</b>		<b>Start time (min:sec)</b>		<b>Final time (min:sec)</b>		<b>Air Velocity (m/s)</b>		<b>Temperature °C</b>					
1															
2															
<b>Sample (number)</b>		<b>Pressure (Hpa)</b>		<b>Wind Velocity (m/s)</b>		<b>Outdoor Temperature °C</b>									
1															
2															
3															
4															
5															
6															
<b>Comments:</b>															



APPENDIX G

SAMPLE OF LINEAR FIT FOR METHANE AND CARBON DIOXIDE FLUXES

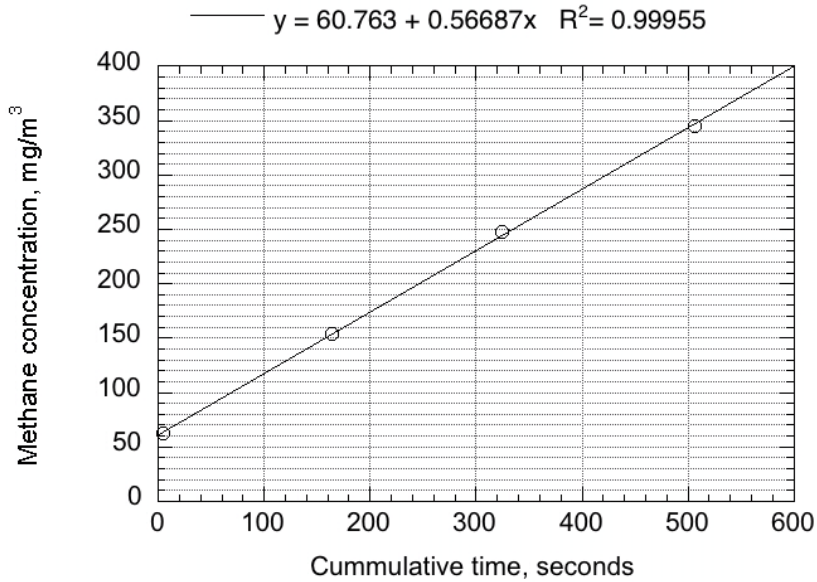

(a)

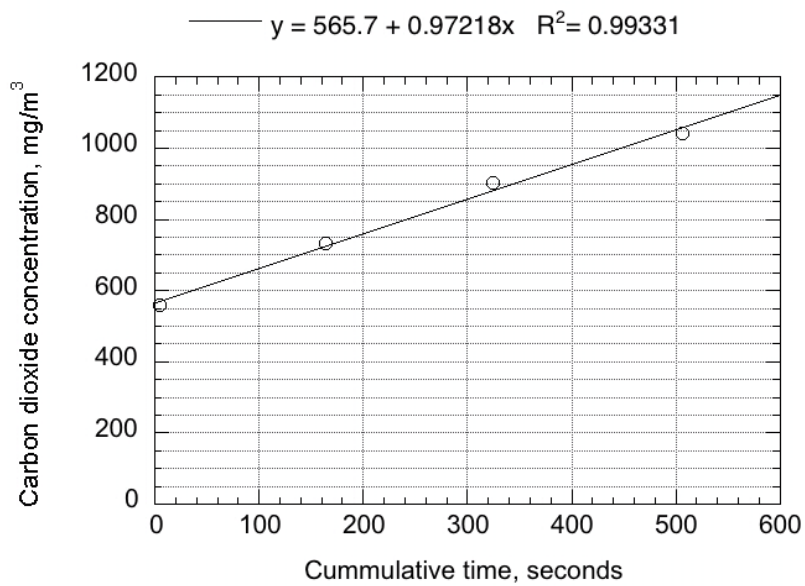

(b)

Figure G-1. Sample of Linear Fit for Methane and Carbon Dioxide Fluxes:(a) Methane and (b) Carbon Dioxide Concentration in mg/m<sup>3</sup> Linear Fit.



## APPENDIX H

## FIELD DATA

**H-1 Site 1**

This site was characterized for a thin patchy scum layer, less than one inch. Invertebrates were not present on the scum layer. The sludge depth in the first and second compartment was 15 and 8", respectively. The sludge in the first compartment was compacted, very black, while in the second compartment was light and brownish. It was very common to observed turnover episodes. A sampling event was performed after one of the turnover events to determine the influence of these episodes in the gas emissions. The summary of the average GHG emission rates from the septic tank calculated in this site are presented in Table H-1.

**Table H-1. Average of GHG Emission Rates From the Septic Tank Liquid Surface.**

Date	Sample location	Gas measurement (g/capita·d)			Average liquid temperature (°C)
		CH <sub>4</sub>	CO <sub>2</sub>	N <sub>2</sub> O	
9/24/09	ST1-1-A <sup>a</sup>	12.00	37.85	0.0	21
	ST1-2-S <sup>b</sup>	6.75	15.25	0.0	22
	ST1-TE <sup>c</sup>	18.75	53.10	0.0	
10/07/09	ST1-1-A	20.71	55.33	0.0	21
	ST1-2-S	8.91	12.68	0.01	21
	ST1-TE	29.62	68.01	0.01	
11/05/09	ST1-1-A	9.17	67.54	0.03	18
	ST1-1-S <sup>d</sup>	27.54	46.09	0.0	18
	ST1-2-S	3.44	14.17	0.0	17
	ST1-TE	12.61	81.71	0.03	
	ST1-TE-1S <sup>e</sup>	30.98	60.26	0.0	
11/10/09	ST1-1-A	32.47	56.33	0.01	17
	ST1-2-S	3.89	17.88	0.0	20
	ST1-TE	36.36	74.21	0.01	

## Attachment C

Date	Sample location	Gas measurement (g/capita·d)			Average liquid temperature (°C)
		CH <sub>4</sub>	CO <sub>2</sub>	N <sub>2</sub> O	
11/12/09	ST1-1-A	14.61	21.87	0.02	16
	ST1-1-S	5.30	25.14	0.0	16
	ST1-2-S	3.11	13.05	0.0	16
	ST1-TE	17.72	34.92	0.02	
	ST1-TE-1S	8.41	38.19	0.0	
11/19/09	ST1-1-A	43.09	52.19	0.01	15
	ST1-1-A-E <sup>f</sup>	12.84	53.89	0.0	15
	ST1-2-S	5.48	10.43	0.0	15
	ST1-TE	48.56	62.62	0.01	
	ST1-TE-1E <sup>g</sup>	18.32	64.32	0.0	
12/03/09	ST1-1-A	7.74	44.60	0.0	14
	ST1-1-S	3.50	15.89	0.0	14
	ST1-2-S	2.21	11.76	0.0	14
	ST1-TE	9.94	56.36	0.0	
	ST1-TE-1S	5.71	27.64	0.0	
Mean value <sup>h</sup>		17.87	57.80	0.00	
Standard deviation <sup>h</sup>		1.94	1.29	5.06	

<sup>a</sup> Septic tank first compartment using insert.

<sup>b</sup> Septic tank second compartment surface. The sample was always taken directly to the liquid surface.

<sup>c</sup> Septic tank total of gas emission rates from both compartments.

<sup>d</sup> Septic tank first compartment surface. The sample was taken directly to the liquid surface.

<sup>e</sup> Septic tank total of gas emission rates using values taken directly to the liquid surface.

<sup>f</sup> Septic tank first compartment using insert after a turnover event.

<sup>g</sup> Septic tank total gas emission rates using the value measured after a turnover event.

<sup>h</sup> Geometric mean and standard deviation values were calculated using the total emission rate value in each date.



Additionally to the gas measurements, several water quality parameters were also measured in both inlet and outlet chambers of the septic tank. The parameters measured included COD, dissolved solids, pH and redox potential. The results of the measurements obtained are summarized in Table H-2.

**Table H-2. Summary of the Water Quality Results From Site 1.**

Date	Sample location	Parameter			
		COD (mg/L)	pH	Redox potential (mV)	Dissolved solids (mg/L)
11/05/09	ST1-1-M <sup>a</sup>	-	6.69	- 150	465
	ST1-2-M <sup>b</sup>	-	-	-	-
11/12/09	ST1-1-M	-	6.69	- 210	455
	ST1-2-M	-	6.79	- 211	463
11/19/09	ST1-1-M	225	6.80	-170	449
	ST1-2-M	170	6.85	-180	450
12/03/09	ST1-1-M	289	6.83	- 185	473
	ST1-2-M	241	6.82	-206	480
Mean value <sup>c</sup>		257	6.75	-188	459
Standard deviation <sup>c</sup>		45	0.07	20	12
Mean value <sup>d</sup>		206	6.82	-199	464
Standard deviation <sup>d</sup>		-	0.03	17	15

<sup>a</sup> Septic tank first compartment. The samples were taken one foot below the liquid surface.

<sup>b</sup> Septic tanks second compartment. The samples were taken one foot below the liquid surface.

<sup>c</sup> Mean value and standard deviation from the values in the first compartment.

<sup>d</sup> Mean value and standard deviation from the values in the second compartment

Water samples were also collected at both compartments of the septic tank to determine the amount of methane, carbon dioxide and nitrous oxide present in solution. A summary each of the dissolved gases calculated per compartment are presented in Table H-3.

**Table H-3. Summary of Dissolved Methane Measured in Each Compartment of the Septic Tank.**

Date	Sample	Gas measurement (g/capita·d)		
		Methane	Carbon dioxide	Nitrous oxide
11/12/09	ST1-1-L <sup>a</sup>	2.71	5.63	0.0
	ST1-2-L <sup>b</sup>	1.12	4.55	0.0
11/19/09	ST1-1-L	1.44	5.21	0.02
	ST1-2-L	1.14	6.74	0.02
12/03/09	ST1-1-L	1.65	7.61	0.02
	ST1-2-L	0.06	0.50	0.02
Mean value <sup>a</sup>		1.93	6.15	0.01
Mean value <sup>b</sup>		0.77	3.93	0.01

<sup>a</sup> Septic tank first compartment.

<sup>b</sup> Septic tank second compartment.

After the initial inspections, Site 1 was selected for venting and soil dispersal system sampling. Samples from the vent system were taken at two different cleanout vents located before and after the septic tank. An anemometer was used to determine the air flow inside the vent pipe to calculate the flow rate and therefore the GHG emission rates. The air velocity in the venting pipes ranged from 35 to 100 ft/min. A summary of the average GHG emission rates from the vent system are presented in Table H-4.

**Table H-4. Average of GHG Emission Rates From the Vent System.**

Date	Sample location	Gas measurement (g/capita·d)			Average Temperature (°C)
		CH <sub>4</sub>	CO <sub>2</sub>	N <sub>2</sub> O	
11/10/09	V-1-1 <sup>a</sup>	12.11	710.65	0.49	17
11/12/09	V-1-1	8.43	744.30	0.95	15
	V-1-2 <sup>b</sup>	0.03	637.43	0.52	16
11/19/09	V-1-1	9.72	393.03	0.42	15
	V-1-2	0.03	10.93	0.02	14
12/03/09	V-1-1	9.17	533.10	0.42	13
	V-1-2	0.0	69.21	0.09	14
02/05/10	V-1-1	6.49	446.01	0.18	11
	V-1-2	0.06	432.79	0.18	10
Mean value <sup>c</sup>		8.44	527.00	0.37	
Standard deviation <sup>c</sup>		0.01	103.62	0.08	
Mean value <sup>d</sup>		1.27	1.31	1.82	
Standard deviation <sup>d</sup>		6.60	0.97	6.09	

<sup>a</sup> Cleanout vent located before the septic tank.

<sup>b</sup> Cleanout vent located before the soil dispersal system

<sup>c</sup> Geometric mean value and standard deviation calculated to the cleanout vent located before the septic tank

<sup>d</sup> Geometric mean value and standard deviation calculated to the cleanout vent located before the soil dispersal system.

The main soil dispersal system characteristics are summarized in Table H-5. Six 12" inserts were installed to sample from the soil dispersal system. Five were distributed above the system and one was inserted outside the system for control purposes.

**Table H-5. General Characteristics of the Soil Dispersal System.**

Characteristic	Value	Unit
Area	205	m <sup>2</sup>
Slope	20	%
Number of trenches	3	-
Rings installed	6 <sup>a</sup>	-

<sup>a</sup> Five distributed on the trenches and one located 10 ft away from the dispersal system area for control purposes.

Gas samples were taken using the flux chamber and were analyzed for methane, carbon dioxide and nitrous oxide. The system was sampled twice to verify the results obtained in the first set of measurements. On the second trial, emission rates of the three GHGs were detected in the control ring and also in two of rings located above the dispersal system. However, the values calculated were similar or less than the control value as seen in Table H-6.

**Table H-6. GHG Emission Rates From the Soil Dispersal System.**

Date <sup>a</sup>	Sample location	Gas measurement (g/capita·d)			Average Temperature (°C)
		CH <sub>4</sub>	CO <sub>2</sub>	N <sub>2</sub> O	
12/03/09	SD1-R1C <sup>b</sup>	0.004	485	0.04	12
	SD1-R2 <sup>c</sup>	ND <sup>d</sup>	ND	ND	11
	SD1-R3	ND	ND	0.00	11
	SD1-R4	ND	236	ND	9
	SD1-R5	ND	ND	ND	10
	SD1-R6	ND	671	0.1	10

<sup>a</sup> On 11/12/09 a sampling event was performed at this site. However, fluxes of CH<sub>4</sub>, CO<sub>2</sub> and N<sub>2</sub>O were not detected in the 5 sampling rings. Control values for CH<sub>4</sub>, CO<sub>2</sub> and N<sub>2</sub>O in g/capita·d were 0.8, 0 and 0 respectively.

<sup>b</sup> Control ring located on the soil dispersal system.

<sup>c</sup> Sampling ring located on the soil dispersal system.

<sup>d</sup> Flux of gas was not detected.

**H-2 Site 2**

The scum layer in the first compartment of this septic tank was thick and compacted approximately 4".

**Table H-7. Average of GHG Emission Rates From the Septic Tank Liquid Surface.**

Date	Sample location	Gas measurement (g/capita·d)			Average liquid temperature (°C)
		CH <sub>4</sub>	CO <sub>2</sub>	N <sub>2</sub> O	
9/24/09	ST2-1-A <sup>a</sup>	1.04	39.31	0.03	26
	ST2-2-S <sup>b</sup>	3.07	14.18	0.0	26
	ST2-TE <sup>c</sup>	4.11	53.50	0.03	
10/07/09	ST2-1-A	12.34	70.51	0.0	25
	ST2-2-S	0.51	12.71	0.0	24
	ST2-TE	12.85	83.23	0.0	
11/05/09	ST2-1-A	10.77	58.86	0.0	22
	ST2-2-S	1.11	6.53	0.0	20
	ST2-TE	11.88	65.39	0.0	
11/19/09	ST2-1-A	1.56	36.24	0.02	18
	ST2-2-S	2.11	12.52	0.01	18
	ST2-TE	3.67	48.75	0.02	
12/08/09	ST2-1-A	4.81	19.90	0.0	14
	ST2-2-S	17.06	29.16	0.0	14
	ST2-TE	21.87	49.06	0.0	
Mean value <sup>d</sup>		8.72	58.69	0.01	
Standard deviation <sup>d</sup>		2.17	1.26	3.25	

<sup>a</sup> Septic tank first compartment using insert.

<sup>b</sup> Septic tank second compartment using insert.

<sup>c</sup> Septic tank total gas emission rates from both compartments.

<sup>d</sup> Geometric mean value and standard deviation calculated using the total of gas emission rates from both compartments.

It was black with humus like appearance, with larvae and small flies present on the top. The sludge depth in the first and second compartment was 12 and 6", respectively. The summary of the GHG emission rates from the septic tank in this site is presented in Table H-7

Water quality parameters were also measured in both inlet and outlet chambers of the septic tank. The parameters measured included COD, dissolved solids, pH and redox potential. The results of the measurements obtained are summarized in Table H-8.

Table H-8. Summary of the Water Quality Results from Site 2.

Date	Sample location	Parameter			
		COD (mg/L)	pH	Redox potential (mV)	Dissolved solids (mg/L)
11/05/09	ST2-1-M <sup>a</sup>	-	7.24	-241	636
	ST2-2-M <sup>b</sup>	-	7.20	-222	652
11/19/09	ST2-1-M	254	6.87	-195	620
	ST2-2-M	173	7.06	-230	612
12/08/09	ST2-1-M	240	7.02	-190	612
	ST2-2-M	175	7.17	-220	632
Mean value <sup>c</sup>		247	7.04	-209	623
Standard deviation <sup>c</sup>		-	0.19	28.11	12.22
Mean value <sup>d</sup>		174	7.14	-224	632
Standar deviation <sup>d</sup>		-	0.07	5.29	20

<sup>a</sup> Septic tank first compartment. The samples were taken one foot below the liquid surface.

<sup>b</sup> Septic tanks second compartment. The samples were taken one foot below the liquid surface.

<sup>c</sup> Mean value and standard deviation from the values in the first compartment.

<sup>d</sup> Mean value and standard deviation from the values in the second compartment.

Water samples were also collected at both compartments of the septic tank to determine the amount of methane, carbon dioxide and nitrous oxide present in solution. A summary of the dissolved gases calculated per compartment are presented in Table H-9.

Table H-9. Summary of Dissolved Methane Measured in Each Compartment of the Septic Tank.

Date	Sample	Gas measurement (g/capita-d)		
		Methane	Carbon dioxide	Nitrous oxide
11/19/09	ST2-1-L <sup>a</sup>	2.05	7.51	0.02
	ST2-2-L <sup>b</sup>	1.42	4.90	0.02
12/08/09	ST2-1-L	1.59	4.46	0.0
	ST2-2-L	0.004	0.29	0.0
Mean value <sup>a</sup>		1.82	6.23	0.01
Mean value <sup>b</sup>		0.71	2.60	0.01

<sup>a</sup>Septic tank first compartment.

<sup>b</sup> Septic tank second compartment

Site 2 was also selected to be sampled in detail. However, the soil infiltration system was not a good candidate for gas sampling due to the dense vegetation above it. Therefore, gas samples were just taken at the septic tank and vent system. Samples from the vent system were taken at a cleanout vent located before the septic tank. The air velocity of the air in the venting pipes varied from 30 to 80 ft.min. A summary of the GHG emission rates from the vent system is presented in Table H-10.

Table H-10. GHG Emission Rates From the Vent System<sup>a</sup>.

Date	Sample location	Gas measurement (g/capita·d)			Average Temperature (°C)
		CH <sub>4</sub>	CO <sub>2</sub>	N <sub>2</sub> O	
9/24/09	V-2-1	18.58	249.03	0.16	19

<sup>a</sup>The vent system was sampled twice. However, during the second trial on December 8<sup>th</sup>, the vent pipe was frozen (ambient temperature was 6 °C) and the velocity inside the pipe was zero.

### H-3 Site 3

In this site gas samples were only taken at the septic tank liquid surface. The scum layer in this site was thick between 3 and 4", but it was not as compacted as the scum layer at Sites 1 and 2. Contrary, this scum layer has a crumbly earth appearance and it was populated by earthworms. The sludge depth in the first and second compartment was 12 and 15", respectively. The summary of the average GHG emission rates from the septic tank calculated in this site is presented in Table H-11.

Table H-11. Average of GHG Emission Rates From the Septic Tank Liquid Surface.

Date	Sample location	Gas measurement (g/capita·d)			Average liquid Temperature (°C)
		CH <sub>4</sub>	CO <sub>2</sub>	N <sub>2</sub> O	
9/24/09	ST3-1-A <sup>a</sup>	0.87	26.06	0.04	27
	ST3-2-A <sup>b</sup>	1.55	20.47	0.0	26
	ST3-TE <sup>c</sup>	2.43	46.53	0.04	
10/07/09	ST3-1-A	24.06	54.66	0.0	23
	ST3-2-A	1.03	7.77	0.01	22
	ST3-TE	25.09	62.43	0.01	
11/05/09	ST3-1-A	12.39	33.39	0.06	19
	ST3-2-A	1.31	9.75	0.01	19
	ST3-TE	13.70	43.14	0.07	
Mean value <sup>d</sup>		9.42	50.04	0.03	
Standard deviation <sup>d</sup>		3.36	1.22	2.38	

<sup>a</sup> Septic tank first compartment using insert.

<sup>b</sup> Septic tank second compartment using insert.

<sup>c</sup> Septic tank total gas emission rates from both compartments.

<sup>d</sup> Geometric mean value and standard deviation calculated using the total gas emission rates from both compartments.

Water quality parameters were also measured in both inlet and outlet chambers of the septic tank. The results of the measurements obtained are summarized in Table H-12.

**Table H-12. Summary of the Water Quality Results from Site 3.**

Date	Sample location	pH	Parameter	
			Redox potential (mV)	Dissolved solids (mg/L)
11/05/09	ST3-1-M <sup>a</sup>	6.82	-215	499
	ST3-2-M <sup>b</sup>	7.20	-272	755

<sup>a</sup> Septic tank first compartment. The sample was taken one foot below the liquid surface.

<sup>b</sup> Septic tanks second compartment. The sample was taken one foot below the liquid surface.

## H-4 Site 4

As soon as the tank lids were opened, a pine odor was detected. The sludge depth in the tank was 14", it had a brownish color and it was very light. The summary of the average GHG emission rates from the septic tank calculated in this site are presented in Table H-13.

**Table H-13. Average of GHG Emission Rates from the Septic Tank Liquid Surface.**

Date	Sample location	Gas measurement (g/capita·d)			Average liquid Temperature (°C)
		CH <sub>4</sub>	CO <sub>2</sub>	N <sub>2</sub> O	
9/24/09	ST4-1-S <sup>a</sup>	0.55	2.70	0.0	22
	ST4-2-S <sup>b</sup>	0.09	3.39	0.0	22
	ST4-TE <sup>c</sup>	0.63	6.09	0.0	
10/07/09	ST4-1-S	0.17	3.42	0.0	18
	ST4-2-S	0.01	1.87	0.0	19
	ST4-TE	0.17	5.30	0.0	
11/05/09	ST4-1-S	0.06	0.21	0.0	15
	ST4-2-S	0.01	0.89	0.0	15
	ST4-TE	0.07	1.09	0.0	
Mean value <sup>d</sup>		0.20	3.28	0.0	
Standard deviation <sup>d</sup>		3.03	2.60	0.0	

<sup>a</sup> Septic tank first compartment. It was not necessary to install an insert to sample from the first compartment.

<sup>b</sup> Septic tank second compartment. It was not necessary to install an insert to sample from the second compartment.

<sup>c</sup> Septic tank total gas emission rates from both compartments.

<sup>d</sup> Geometric mean value and standard deviation calculated using the total gas emission rates from both compartments.

Water quality parameters were also measured in both inlet and outlet chambers of the septic tank. Measurements were also made to the water supply of the house. The results of the measurements obtained are summarized in Table H-14.

**Table H-14. Summary of the Water Quality Results from Site 4.**

Date	Sample location	Parameter		
		pH	Redox potential (mV)	Dissolved solids (mg/L)
11/05/09	ST4-1-M <sup>a</sup>	6.70	+131	46
	ST4-2-M <sup>b</sup>	6.26	+216	79
	WSH <sup>c</sup>	8.3	+530	29

<sup>a</sup> Septic tank first compartment. The sample was taken one foot below the liquid surface.

<sup>b</sup> Septic tanks second compartment. The sample was taken one foot below the liquid surface.

<sup>c</sup> Sample taken to the water supply of the house.

## H-5 Site 5

The scum layer was black, very thin, around 1 inch, and populated with larvae. Floating toilet paper was very common in this septic tank. The sludge was brownish and very light with a depth of 8 and 6" in the first and second compartment, respectively. The average GHG emission rates from the septic tank calculated in this site are presented in Table H-15.

**Table H-15. Average of GHG Emission Rates from the Septic Tank Liquid Surface.**

Date	Sample location	Gas measurement (g/capita·d)			Average liquid temperature (°C)
		CH <sub>4</sub>	CO <sub>2</sub>	N <sub>2</sub> O	
9/24/09	ST5-1-A <sup>a</sup>	3.01	13.65	0.0	25
	ST5-2-S <sup>b</sup>	1.23	5.79	0.0	24
	ST5-TE <sup>c</sup>	4.25	19.44	0.0	
10/07/09	ST5-1-A	4.94	27.02	0.0	21
	ST5-2-S	0.66	3.86	0.0	21
	ST5-TE	5.59	30.88	0.0	
11/05/09	ST5-1-A	9.88	39.66	0.0	17
	ST5-2-S	0.64	4.23	0.02	16
	ST5-TE	10.52	43.89	0.02	
Mean value <sup>d</sup>		6.30	29.76	0.01	
Standard deviation <sup>d</sup>		1.59	1.40	1.59	

<sup>a</sup> Septic tank first compartment using insert.

<sup>b</sup> Septic tank second compartment. It was not necessary to install an insert to sample in the second compartment.

<sup>c</sup> Septic tank total gas emission rates from both compartments.

<sup>d</sup> Geometric mean value and standard deviation calculated using the total gas emission rates from both compartments.

Water quality parameters were also measured in both inlet and outlet chambers of the septic tank. The results of the measurements obtained are summarized in Table H-16.



**Table H-16. Summary of the Water Quality Results from Site 5.**

Date	Sample location	pH	Parameter	
			Redox potential (mV)	Dissolved solids (mg/L)
11/05/09	ST5-1-M <sup>a</sup>	7.05	-205	690
	ST5-2-M <sup>b</sup>	7.42	-223	749

<sup>a</sup> Septic tank first compartment. The sample was taken one foot below the liquid surface.

<sup>b</sup> Septic tanks second compartment. The sample was taken one foot below the liquid surface.

## H-6 Site 6

A thick scum layer of around 3" was observed in the liquid close the inlet tee; however the rest of the tank had a patchy brownish scum layer. The outlet water surface had a thin oily layer. The sludge depth measured in the first and second compartment was 6 and 20", respectively. The summary of the average GHG emission rates from the septic tank calculated in this site are presented in Table H-17.

**Table H-17. Average of GHG Emission Rates from the Septic Tank Liquid Surface.**

Date	Sample location	Gas measurement (g/capita·d)			Average liquid temperature (°C)
		CH <sub>4</sub>	CO <sub>2</sub>	N <sub>2</sub> O	
9/24/09	ST6-1-A <sup>a</sup>	8.31	17.37	0.01	22
	ST6-2-A <sup>b</sup>	1.64	13.39	0.0	22
	ST6-TE <sup>c</sup>	9.95	30.76	0.01	
11/05/09	ST6-1-A	5.79	60.02	0.0	16
	ST6-2-A	1.64	11.40	0.0	15
	ST6-TE	7.43	71.42	0.0	
Mean value <sup>d</sup>		8.60	46.87	0.0	
Standard deviation <sup>e</sup>		1.23	1.82	1.48	

<sup>a</sup> Septic tank first compartment using insert.

<sup>b</sup> Septic tank second compartment using insert.

<sup>c</sup> Septic tank total gas emission rates from both compartments.

<sup>d</sup> Geometric mean value calculated using the total gas emission rates from both compartments.

<sup>e</sup> Geometric standard deviation calculated using the total gas emission rates from both compartments.

Water quality parameters were also measured in both inlet and outlet chambers of the septic tank. The results of the measurements obtained are summarized in Table H-18.

**Table H-18. Summary of the Water Quality Results from Site 6.**

Date	Sample location	Parameter		
		pH	Redox potential (mV)	Dissolved solids (mg/L)
11/05/09	ST6-1-M <sup>a</sup>	6.93	-212	673
	ST6-2-M <sup>b</sup>	6.98	-197	691

<sup>a</sup> Septic tank first compartment. The sample was taken one foot below the liquid surface.

<sup>b</sup> Septic tanks second compartment. The sample was taken one foot below the liquid surface

## H-7 Site 7

The scum layer had an approximate thickness of 3", and it tend to accumulates in the around the inlet tee. The scum was black, had a crumbly earth appearance in some spots and it was populated by larvae and small flies. The sludge depth in the first and second compartment was 14 and 6 ", respectively. The summary of the average GHG emission rates from the septic tank calculated in this site are presented in Table H-19.

Water quality parameters were also measured in both inlet and outlet chambers of the septic tank. The parameters measured included COD, dissolved solids, pH and redox potential. The results of the measurements obtained are summarized in Table H-20.

**Table H-19. Average of GHG Emission Rates from the Septic Tank Liquid Surface.**

Date	Sample location	Gas measurement (g/capita·d)			Average liquid temperature (°C)
		CH <sub>4</sub>	CO <sub>2</sub>	N <sub>2</sub> O	
10/07/09	ST7-1-A <sup>a</sup>	5.35	23.75	0.0	21
	ST7-2-A <sup>b</sup>	0.89	6.0	0.0	20
	ST7-TE <sup>c</sup>	6.24	29.75	0.0	
11/05/09	ST7-1-A	24.23	36.01	0.0	16
	ST7-2-A	0.79	2.92	0.0	17
	ST7-TE	25.01	38.93	0.0	
11/17/09	ST7-1-A	19.20	43.09	0.0	17
	ST7-2-A	0.58	7.19	0.0	16
	ST7-TE	19.78	50.28	0.0	
12/01/09	ST7-1-A	26.25	50.56	0.02	15
	ST7-2-A	0.58	5.52	0.0	14
	ST7-TE	26.83	56.07	0.02	
	Mean value <sup>d</sup>	16.97	42.51	0.0	
	Standard deviation <sup>d</sup>	1.86	1.33	-	

<sup>a</sup> Septic tank first compartment using insert.

<sup>b</sup> Septic tank second compartment using insert.

<sup>c</sup> Septic tank total gas emission rates from both compartments.

<sup>d</sup> Geometric mean value and standard deviation calculated using the total gas emission rates from both compartments.

**Table H-20. Summary of the Water Quality Results from Site 7.**

Date	Sample location	Parameter			
		COD (mg/L)	pH	Redox potential (mV)	Dissolved solids (mg/L)
11/05/09	ST7-1-M <sup>a</sup>	-	6.61	-201	649
	ST7-2-M <sup>b</sup>	-	6.89	-180	682
11/17/09	ST7-1-M	-	6.52	-170	560
	ST7-2-M	-	6.74	-220	590
12/01/09	ST7-1-M	408	6.56	-196	607
	ST7-2-M	306	6.69	-195	604
Mean value <sup>c</sup>		-	6.56	-189	605
Standard deviation <sup>c</sup>		-	0.05	17	45
Mean value <sup>d</sup>		-	6.77	-198	625
Standard deviation <sup>d</sup>		-	0.10	20	50

<sup>a</sup> Septic tank first compartment. The sample was taken one foot below the liquid surface.

<sup>b</sup> Septic tanks second compartment. The sample was taken one foot below the liquid surface.

<sup>c</sup> Mean value and standard deviation from the values in the first compartment.

<sup>d</sup> Mean value and standard deviation from the values in the second compartment.

Water samples were also collected at both compartments of the septic tank to determine the amount of methane, carbon dioxide and nitrous oxide present in solution. A summary of the dissolved gases calculated per compartment are presented in Table H-21.

**Table H-21. Summary of Dissolved Methane Measured in Each Compartment of the Septic Tank.**

Date	Sample	Gas measurement (g/capita·d)		
		Methane	Carbon dioxide	Nitrous oxide
11/17/09	ST7-1-L <sup>a</sup>	0.29	1.88	0.01
	ST7-2-L <sup>b</sup>	0.0	0.17	0.01
12/01/09	ST7-1-L	0.94	6.6	0.0
	ST7-2-L	0.0	0.18	0.0
Mean value <sup>a</sup>		0.61	4.24	0.005
Mean value <sup>b</sup>		0.0	0.17	0.0

<sup>a</sup> Septic tank first compartment.

<sup>b</sup> Septic tank second compartment

Site 7 was selected to be sampled in more detailed. Therefore, gas samples were taken at the septic tank, vent and soil dispersal systems. Samples from the vent system were taken at the cleanout vent located before the septic tank. Air velocity measured in the passive house venting systems ranged from 40 to 100 ft/min when an effluent filter was not present. Effluent filters reduced the air flow through the vent system to a range of 0 to 0.1 m/s (0 to 10 ft/min). The results from the vent systems measurements are summarized in Table H-22.

**Table H-22. GHG Emission Rates from the Vent System.**

Date	Sample location	Gas measurement (g/capita·d)			Average Temperature (°C)
		CH <sub>4</sub>	CO <sub>2</sub>	N <sub>2</sub> O	
11/17/09	V7-1EF <sup>a</sup>	31.73	192.56	0.21	14
12/01/09	V7-1EF	7.53	57.73	0.01	17
	V7-1OF <sup>b</sup>	5.51	36.18	0.0	13
	V7-1WEF <sup>c</sup>	14.89	115.75	0.02	12
Mean value <sup>a</sup>		13.39	93.47	0.04	

<sup>a</sup> The vent system samples were typically taken without opening the tank lids and with the installed effluent filter. The mean was calculated using the results from the two sampling events performed in this conditions.

<sup>b</sup> Vent sample taken using a biotube effluent filter model FTi0418-S from Orenco Systems, Inc.

<sup>c</sup> Vent sample taken without the effluent filter and tank lids off.

The main soil dispersal system characteristics are summarized in Table H-23. Six 12" inserts were installed to sample from the soil dispersal system. Five were distributed above the system and one was inserted outside the system for control purposes.

**Table H-23. General Characteristics of the Soil Dispersal System.**

Characteristic	Value	Unit
Area	650	m <sup>2</sup>
Slope	8.5	%
Number of trenches	3	-
Rings installed	6 <sup>a</sup>	-

<sup>a</sup> Five distributed on the trenches and one located 6 ft away from the dispersal system area for control purposes.

Gas samples were taken and analyzed for methane, carbon dioxide and nitrous oxide. During the first set of measurements, methane gas was detected once in one of the rings but not in the control one. In the second sampling date, the carbon dioxide emission rates values were similar or less than the control value and nitrous oxide emission rates were double than the control value but the amount is not significant. A summary of the results from the soil dispersal system at Site 7 are found in Table H-24.

Table H-24. GHG Emission Rates from the Soil Dispersal System.

Date	Sample location	Gas measurement (g/capita·d)			Average Temperature (°C)
		CH <sub>4</sub>	CO <sub>2</sub>	N <sub>2</sub> O	
11/17/09	SD7-R1 <sup>a</sup>	ND <sup>c</sup>	ND	ND	16.8
	SD7-R2C <sup>b</sup>	ND	619	0.19	14.8
	SD7-R3	ND	ND	ND	17.2
	SD7-R4	ND	110	0.11	19.4
	SD7-R5	ND	ND	ND	19.1
	SD7-R6	0.0	ND	0.10	16.5
12/01/09	SD7-R1	ND	842	0.07	16.8
	SD7-R2C	ND	843	0.04	14.8
	SD7-R3	0.09	469	0.11	17.2
	SD7-R4	ND	ND	ND	19.4
	SD7-R5	ND	ND	0.5	19.1
	SD7-R6	ND	851	0.16	16.5

<sup>a</sup> Sampling ring located on the soil dispersal system.

<sup>b</sup> Control ring located on the soil dispersal system.

<sup>c</sup> Flux of gas was not detected.

## H-8 Site 8

The scum layer in this septic tank was thin, less than one inch, it was black and small larvae were observed in both compartments. The sludge depth both compartments of the septic tank was 3' and it had a very thick consistency. The total water depth was 5'. therefore the clear zone of the tank was reduced to 2'. The tank has a strong odor compared to the tanks in ALT. A summary of the GHG emission rates from the septic tank calculated in this site are shown in Table H-25.

Table H-25. Average of GHG Emission Rates from the Septic Tank Liquid Surface.

Date	Hour	Sample location	Gas measurement (g/capita·d)			Average liquid Temperature (°C)
			CH <sub>4</sub>	CO <sub>2</sub>	N <sub>2</sub> O	
10/21/09	11:00 am	ST8-1-A <sup>a</sup>	9.88	46.58	0.0	17
		ST8-2-A <sup>b</sup>	1.10	8.31	0.0	17
		ST8-TE <sup>c</sup>	10.98	54.89	0.0	
	3:00pm	ST8-1-A	10.96	25.59	0.0	17
		ST8-2-A	1.14	6.36	0.0	17
		ST-8-TE	12.10	31.94	0.0	
	7:00pm	ST8-1-A	1.14	13.51	0.0	16
		ST8-2-A	2.80	1.97	0.0	16
		ST8-TE	3.44	15.48	0.0	
11:00pm	ST8-1-A	73.72	33.54	0.0	16	
	ST8-2-A	1.95	12.57	0.0	16	
	ST8-TE	75.68	46.21	0.0		
10/22/09	3:00 am	ST8-1-A	10.06	74.54	0.0	16
		ST8-2-A	1.21	1.00	0.0	16

## Attachment C

Date	Hour	Sample location	Gas measurement (g/capita·d)			Average liquid Temperature (°C)	
			CH <sub>4</sub>	CO <sub>2</sub>	N <sub>2</sub> O		
12/10/09	7:00 am	ST8-TE	11.27	75.54	0.0		
		ST8-1-A	34.41	10.92	0.0	16	
		ST8-2-A	1.48	17.45	0.0	16	
	11:00am	ST8-TE	35.89	28.37	0.0		
		ST8-1-A	ND <sup>d</sup>	ND	ND	17	
		ST8-2-A	4.05	5.52	0.02	17	
	7:30 am	ST8-TE	4.05	5.52	0.02		
		ST8-1-A	1.33	12.35	0.01	13	
		ST8-2-A	1.38	2.43	0.0	13	
		11:00 am	ST8-TE	2.72	14.77	0.01	
			ST8-1-A	2.70	1.62	0.01	13
			ST8-2-A	1.42	2.17	0.0	13
		2:00pm	ST8-TE	4.11	3.79	0.01	
			ST8-1-A	10.24	1.80	0.0	13
			ST8-2-A	0.98	0.72	0.01	13
	7:00pm	ST8-TE	11.23	2.53	0.01		
		ST8-1-A	0.34	0.54	0.0	13	
		ST8-2-A	0.68	0.73	0.01	13	
12/11/09	8:00am	ST8-TE	1.02	1.26	0.01		
		ST8-1-A	4.63	1.74	0.0	12	
		ST8-2-A	1.03	0.86	0.0	12	
		ST8-TE	5.66	2.60	0.0		
		Mean value <sup>e</sup>	8.99	12.58	0.01		
		Standard deviation <sup>e</sup>	3.33	3.9	4.42		

<sup>a</sup> Septic tank first compartment using insert.

<sup>b</sup> Septic tank second compartment. The flux chamber was installed directly to the liquid surface.

<sup>c</sup> Septic tank total gas emission rates from both compartments.

<sup>d</sup> Not detected.

<sup>e</sup> Geometric mean value and standard deviation calculated using the total gas emission rates.

Water quality parameters were also measured in both inlet and outlet chambers of the septic tank. The parameters measured included COD, dissolved solids, pH and redox potential. The results of the measurements obtained are summarized in Table H-26.

**Table H-26. Summary of the Water Quality Results from Site 5<sup>a</sup>.**

Date	Sample location	Parameter			
		COD (mg/L)	pH	Redox potential (mV)	Dissolved solids (mg/L)
12/10/09	ST7-1-M <sup>a</sup>	164	7.66	-	1113
	ST7-2-M <sup>b</sup>	108	7.57	-212	1200
12/11/09	ST7-1-M	168	-	-	-
	ST7-2-M	112	-	-	-

<sup>a</sup> Septic tank first compartment. The sample was taken one foot below the liquid surface.

<sup>b</sup> Septic tanks second compartment. The sample was taken one foot below the liquid surface.

Water samples were also collected at both compartments of the septic tank to determine the amount of methane present in solution. A summary of the dissolved methane calculated per compartment are shown in Table H-27.

**Table H-27. Summary of Dissolved Methane Measured in Each Compartment of the Septic Tank.**

Date	Sample	Gas measurement (g/capita·d)		
		Methane	Carbon dioxide	Nitrous oxide
12/10/09	ST8-1-L <sup>a</sup>	0.50	2.14	0.002
	ST8-2-L <sup>b</sup>	0.33	1.61	0.001
12/11/09	ST8-1-L	0.55	2.72	0.002
	ST8-2-L	0.42	2.39	0.001
	Mean value <sup>a</sup>	0.52	2.43	0.002
	Mean value <sup>b</sup>	0.38	2.00	0.001

<sup>a</sup> Septic tank first compartment.

<sup>b</sup> Septic tank second compartment.

## H-9 Summary of Results

A summary of the sampling dates, calculated average GHG emission rates value and the standard deviation from the different septic tanks studied is presented in Table H-28.

**Table H-28. Summary of GHG Emission Rates from the Eight Septic Tanks Used in the Study.**

Septic tank number	Gas Measurement (g/capita-d)					
	CH <sub>4</sub>		CO <sub>2</sub>		N <sub>2</sub> O	
	TGE <sup>a</sup>	SD <sup>b</sup>	TGE	SD	TGE	SD
1	17.87	1.94	57.80	1.29	0.0	5.06
2	8.72	2.17	58.69	1.26	0.01	3.25
3	9.42	3.36	50.04	1.22	0.03	2.38
4	0.20	3.03	3.28	2.60	0.0	0.0
5	6.30	1.59	29.76	1.40	0.01	1.59
6	8.60	1.23	46.87	1.82	0.0	1.48
7	16.97	1.86	42.51	1.33	0.0	-
8	8.99	3.33	12.58	3.90	0.01	4.42

<sup>a</sup> Mean value of total gas emission rates from both compartments.

<sup>b</sup> Standard deviation calculated to the total gas emission rates from both compartments.



## APPENDIX I

## CALCULATION OF COD IN TERMS OF CO<sub>2</sub> FOR MASS BALANCE ON THE SOIL DISPERSAL SYSTEM

1. Balanced oxidation equation for wastewater
 
$$2\text{C}_{10}\text{H}_{19}\text{O}_3\text{N} + 25\text{O}_2 = 20\text{CO}_2 + 16\text{H}_2\text{O} + 2\text{NH}_3$$

(221 g/mol)            (32 g/mol)            (44g /mol)
2. Theoretical (chemical) oxygen demand for C<sub>10</sub>H<sub>19</sub>O<sub>3</sub>N
 
$$(25 \times 32)/(2 \times 221) = 1.81 \text{ g O}_2/\text{g C}_{10}\text{H}_{19}\text{O}_3\text{N} = 1.81 \text{ g COD}/\text{g C}_{10}\text{H}_{19}\text{O}_3\text{N}$$
3. Carbon dioxide equivalent for C<sub>10</sub>H<sub>19</sub>O<sub>3</sub>N
 
$$(20 \times 44)/(2 \times 221) = 1.99 \text{ g CO}_2/\text{g C}_{10}\text{H}_{19}\text{O}_3\text{N}$$
4. Carbon dioxide produced from COD
 
$$(1.99 \text{ g CO}_2/\text{g C}_{10}\text{H}_{19}\text{O}_3\text{N}) / (1.81 \text{ g COD}/\text{g C}_{10}\text{H}_{19}\text{O}_3\text{N}) = 1.1 \text{ g CO}_2/\text{g COD}$$
5. COD value measured at the effluent equal to 206 mg/L, assuming that the flow coming to the septic tank ranges from 200 to 590 L/capita·d (Crites and Tchobanoglous, 1998; GDPUD, 2010), the COD in terms of CO<sub>2</sub> is calculated.
 
$$(206 \text{ mg COD/L}) / (1 \text{ g}/1000 \text{ mg}) \times (200 \text{ L/d}) \times (1.1 \text{ g CO}_2/\text{g COD})$$

$$= 45.3 \text{ g CO}_2/\text{capita}\cdot\text{d}$$

$$(206 \text{ mg COD/L}) / (1 \text{ g}/1000 \text{ mg}) \times (590 \text{ L/d}) \times (1.1 \text{ g CO}_2/\text{g COD})$$

$$= 133.7 \text{ g CO}_2/\text{capita}\cdot\text{d}$$

Thus, the CO<sub>2</sub> equivalent of the COD loading to the soil dispersal system is expected to range 45.3 to 133.7 g CO<sub>2</sub>/capita·d.



## REFERENCES

- Aneja, V.P., J. Blunden, C.S. Clairborn, and H.H. Rogers (2006) "Dynamic Chamber System to Measure Gaseous Compounds Emissions and Atmospheric-Biospheric Interactions," I. Barnes and K.J. Rudzinski (eds.), *Environmental Simulation Chambers: Application to Atmospheric Chemical Processes*, 97-109, Netherlands.
- Ball, H. (2009) Personal communication.
- Bogner, J., R. Pipatti, S. Hashimoto, C. Diaz, K. Mareckova, L. Diaz, P. Kjeldsen, S. Monnis, A. Faaij, Q. Gao, T. Zhang, M.S. Ahmed, R.T.M. Sutarnihardja, and R. Gregory (2008) "Mitigation of Global Greenhouse Gas Emissions from Waste: Conclusions and Strategies from the Intergovernmental Panel on Climate Change (IPCC). Fourth Assessment Report. Working Group III (Mitigation)," *J. Waste Management and Research.*, **26**, 11-32.
- Bounds, T.R. (1997) "Design and Performance of Septic Tanks," in M.S. Bedinger, J.S. Fleming, and A.I. Johanson (eds.), *Site Characterization and Design of On-Site Septic Systems*, ASTM STP 11324, American Society for Testing and Materials.
- Bitton, G. (2005) *Wastewater Microbiology*, 3rd ed., Jhon Wiley & Sons, Inc., Hoboken, New Jersey.
- California Plumbing Code (2007) IAPMO. *Chapter Nine, Vents*. Ontario, CA.
- Cakir, F.Y. and M.K. Stenstrom (2005) "Greenhouse Gas Production: A Comparison Between Aerobic and Anaerobic Wastewater Treatment Technology," *Water Res.*, **39**, 4197-4203.
- Chandran, K. (2009) "Characterization of Nitrogen Greenhouse Gas Emissions from Wastewater Treatment BNR Operations," *Field Protocol with Quality Assurance Plan*, Water Environment Research Foundation, Alexandria, VA.
- Christensen, S., P. Ambus, J.R.M. Arah, H. Clayton, B. Galle, D.W.T. Griffith, K.J. Hargreaves, K.A. Smith, M. Welling, and F.G. Wienholds (1996) "Nitrous Oxide Emissions from an Agricultural Field: Comparison Between Measurements by Flux Chamber and Micrometeorological Techniques," *Atmospheric Environment*, **30**,24, 4183-4190.
- Crites, R. and G. Tchobanoglous (1998) *Small and Decentralized Wastewater Management Systems*, McGraw-Hill, New York.
- Dale, R. (1982) "The Arthropod and Related Fauna of Septic Tanks in Novato, Marin County, California," Master thesis, Department of Biology, California State University, Hayward, CA.
- D'Amato, V.A., A. Bahe, T.R. Bounds, B. Comstock, T. Konsler, S.K. Liehr, S.C. Long, K. Ratanaphuks, C.A. Rock, and K. Sherma (2008) "Factors Affecting the Performance of Primary

Treatment in Decentralized Wastewater Treatment Systems," Water Environment Research Foundation, Alexandria, VA.

DeSutter, T.M. and J.M. Ham (2005) "Emissions and Carbon Balance Estimates of a Swine Production Facility," *J. Environ. Qual.* **34**,198-206.

Dunbar, W.P. (1908) *Principles of Sewage Treatment*, Translated by H.T. Calvert. Charles Griffin and Co., Ltd., England.

Duncan, M. and N. Horan (2003) *Handbook of Water and Wastewater Microbiology*, Academic Press, ELSEVIER, San Diego, CA.

Erickson, J. and E.J. Tyler (2000) *A Model for Soil Oxygen Delivery to Wastewater Infiltration Surfaces*, NOWRA 2000 Conference Proceedings. National Onsite Wastewater Recycling Association, pp. 91-96.

Foley, J. and P. Lant (2009) *Direct Methane and Nitrous Oxide Emissions from Full-Scale Wastewater Treatment Systems*, The University of Queensland, Australia. Water Services Association of Australia (WSAA) Occasional Paper, No. 24.

GDPUD (2009) Georgetown Divide Public Utility District, Personal communication with D. Creeks.

GDPUD (2010) Georgetown Divide Public Utility District, Personal communication with B. Siren.

Höglund, C. (2001). "Evaluation of Microbial Health Risks Associated with the Reuse of Source Separated Human Urine," Ph.D. thesis, Department of Biotechnology, Royal Institute of Technology, Stockholm, Sweden.

Hutchinson, G.L. and G.P. Livingston (1993) "Use of Chamber Systems to Measure Trace Gas Fluxes," in L.A. Harper, A.R. Moiser, J.M. Duxbury, and D.E. Rolston (eds.) *Agricultural Ecosystem Effects on Trace Gases and Global Climate Change*, ASA Spec. Publ. 55. ASA, Madison, WI.

IPCC (1996) *Climate Change 1995: The Science of Climate Change*. Intergovernmental Panel on Climate Change, J.T. Houghton, L.G. Meira Filho, B.A. Callander, N. Harris, A. Kattenberg, and K. Maskell (eds.), Cambridge University Press, Cambridge, United Kingdom.

IPCC (2007) *Climate Change (2007) Synthesis Report*. Contribution of Working Groups I, II and III to the Fourth Assessment Report of the Intergovernmental Panel on Climate Change [Core Writing Team, R.K. Pachauri, and A. Reisinger (eds.)]. IPCC, Geneva, Switzerland.

Isa, Z., S. Grusenmeyer, and W. Verstraete (1986) "Sulfate Reductions Relative to Methane Production in High-Rate Anaerobic Digestion: Technical Aspects," *J. Applied and Environmental Microbiology.*, **51**,3, 572-579.

Janna, W.S. (2007) *Conduction Shape Factor Method Applied to the Modeling of Oxygen Diffusion Through Soil*, Eleventh Individual and Small Community Sewage Systems Conference Proceedings, 20-24 October 2007, Warwick, Rhode Island, USA, ASAE, St. Josephs, MI.

Kinnicutt, L.P., C.E.A. Winslow, and R.W. Pratt (1910) *Sewage Disposal*, John Wiley and Sons. New York.

Knowles, R. (1993) "Methane: Processes of Production and Consumption," in L.A. Harper, A.R. Moiser, J.M. Duxbury, and D.E. Rolston (eds.) *Agricultural Ecosystem Effects on Trace Gases and Global Climate Change*, ASA Spec. Publ. 55. ASA, Madison, WI.

Leverenz, H., G. Tchobanoglous, and J.L. Darby (2009) "Clogging in Intermittently Dosed Sand Filters Used For Wastewater Treatment," *Water Research*, **43**, 3, 695-705.

Maier, R.M., I.L. Pepper, and C.P. Gerba (2009) *Environmental Microbiology*, 2nd ed., academic Press, ELSEVIER Inc., London.

Maillacheruvu, K.Y. and G.F. Parkin (1996) "Kinetics of Growth, Substrate Utilization, and Sulfide Toxicity for Propionate, Acetate and Hydrogen Utilizers in Anaerobic Systems," *Water Environmental Research*, **68**, 7, 1099-1106.

McCarty, P.L. (1964) "Anaerobic Waste Treatment Fundamental," *Public Works*, **95**, 9, 107-112, 10, 123-126, 11, 91-94, 12, 95-99.

McCarty, P.L. (2001) "The Development of Anaerobic Treatment and Its Future," *Water Sci. Tech.*, **44**, 8, 149-155.

Moore, T.R. and N.T. Roulet (1991) "A Comparison of Dynamic and Static Chambers for Methane Emissions Measurements From Subarctic Fens," *Atmos. Ocean*, **29**, 1, 102-109.

Patel, G.B., A.W. Khan, and L.A. Roth (1978) "Optimum Levels of Sulfate and Iron for the Cultivations of Pure Cultures of Methanogens in Synthetic Media," *J. Applied Microbiology*, **45**, 347-356.

Parkin, G.F. and R.E. Speece, (1982) "Modeling Toxicity in Methane Fermentation Systems," *J. Environmental Engineering Division*, **108**, 515-531.

Parkin, G.F., N.A. Lynch, W.C. Kuo, E.L. Van Keuren, and S.K., Bhattacharya (1990) "Interactions between Sulfate Reducers and Methanogens Fed Acetate and Propionate," *J. Water Pollution Control Federation*, **62**, 6, 780-788

Perkins, R.J. (1989) *Onsite Wastewater Disposal*, National Environmental Health Association, Lewis Publishers Inc., Ann Arbor, MI.

Philip, H., S. Maunoir, A. Rambaud, and S. Philippi (1993) "Septic Tank Sludge: Accumulation Rate Biochemical Characteristics," Proceedings of the Second International Specialized Conference on Design and Operation of Small Wastewater Treatment Plants, Norway.

Rittmann, B.E. and P.L. McCarty (2001) *Environmental Biotechnology: Principles and Applications*, McGraw-Hill, Inc. New York.

Roy, C. and J.-P. Dubé (1994) "A Recirculating Gravel Filter for Cold Climates," Proceedings of the Seventh International Symposium on Individual and Small Community Systems, American Society of Agricultural Engineers, St. Joseph, MI.

Sahely, H.R., H.L. Maclean, H.D. Monteith, and D.M. Bagley (2006) "Comparison of On-site and Upstream Greenhouse Gas Emissions from Canadian municipal wastewater treatment facilities," *J. Environ. Engr. Sci.*, **5**, 405-415.

San Luis Obispo County (2008) *Technical Memorandum, Septage Receiving Station Options*, Los Osos Wastewater Project Development. Los Osos, CA.

Sasse, L. (1998) DEWATS, Decentralized Wastewater Treatment in Developing Countries, Borda, Delhi, India.

Schönheit, P., J.K. Kristjansson, and R.K. Thauer (1982) "Kinetic Mechanism for the Ability of Sulfate Reducers to Out-Compete Methanogens for Acetate," *Arch. Microbiol.*, **132**, 285-288.

Seabloom, R.W., T.R. Bounds, and T.L. Loudon. (2005). Septic Tanks Text. in (M.A. Gross and N.E. Deal, eds.) "University Curriculum Development for Decentralized Wastewater Management," National Decentralized Water Resources Capacity Development Project. University of Arkansas, Fayetteville, AR.

SLOC (2008) San Luis Obispo County septic tank regulation.

Speece, R.E. (1996) *Anaerobic Biotechnology for Industrial Wastewaters*. Archae Press, Nashville, TN.

Tabachow, R.M., P.A. Roelle, J. Peirce, and V.P. Aneja (2002). "Soil Nitric Oxide Emissions: Lab and Field Measurements Comparison," *Environ. Engr. Sci.*, **19**, 4.

Tchobanoglous, G. and E.D. Schroeder (1985) *Water Quality: Characteristics, Modeling and Modification*. Addison-Wesley Company, Inc., Menlo Park, CA.

Tchobanoglous, G. and F.L. Burton (1991) *Wastewater Engineering: Treatment, Disposal, and Reuse*, 3rd ed., McGraw-Hill, Inc., New York.

Tchobanoglous, G., F.L. Burton, and H.D. Stensel (2003) *Wastewater Engineering: Treatment and Reuse*, 4th ed., Metcalf and Eddy, Inc., McGraw-Hill Book Company, New York.

U.S. EPA (1993), *The Determination of Chemical Oxygen Demand by Semi-Automated Colorimetry*, EPA Method 410.4, Cincinnati, OH.

U.S. EPA (1994) *Guide to Septage Treatment and Disposal*, EPA/625/R-94/002. Washington, D.C.

U.S. EPA (1999) *Quantification of Methane Emissions and Discussion of Nitrous Oxide and Ammonia Emissions from Septic Tanks, Latrines and Stagnant Sewers in the World*, EPA-600/R-99-089. Springfield, VA.

U.S. EPA (2000) *Decentralized Systems Technology Fact Sheet. Septic System Tank*, EPA-832-F-00-040. Washington, D.C. September, 2000.

U.S. EPA (2002) *Onsite Wastewater Treatment Systems Manual*, EPA-625/R-00/008, February, 2002.

U.S. EPA (2005) *A Homeowner's Guide to Septic Systems*, EPA-832-B-02-005. U.S. Environmental Protection Agency, Washington, D.C.

U.S. EPA (2009) *Inventory of U.S. Greenhouse Gas Emissions and Sinks: 1990-2007*, EPA 430-R-09-004, U.S. Environmental Protection Agency, Washington, D.C.

U.S. EPA (2010) *Inventory of U.S. Greenhouse Gas Emissions and Sinks: 1990-2008*, EPA 430-R-10-006, U.S. Environmental Protection Agency, Washington, D.C.

U.S. EPA Region 9 (2003) California Wastewater Training and Research Center, 2003. Status Report, Onsite Wastewater Treatment Systems in California. California State University, Chico, CA.

U.S. PHS (1957) *Manual of Septic Tank Practice*, U.S. Public Health Service, Washington, DC.

Walker, H.B. and R.H. Driftmier (1929) "Studies of the Septic Tank Method of Sewage Disposal for Isolated Homes," *J. Ag. Engr.*, **10**, 8, 9, and 10.

Weibel, S.R., C.P. Straub, and S.A. Thoman (1949) *Studies on Household Sewage Disposal Systems*, Part I. US Public Health Service, Cincinnati, OH.

Weibel, S.R., C.P. Straub, and S.A. Thoman (1955) *Studies on Household Sewage Disposal Systems*, Part III. US Public Health Service, Cincinnati, OH.

Wilhelm, S.R., S.L. Schiff, and J.A. Cherry (1994) "Biogeochemical Evolution of Domestic Wastewater in Septic Systems: 1. Conceptual Model," *J. Ground Water*, **32**, 6, 905-916.

Winfrey, M.R. and J.G. Zeikus (1977) "Effect of Sulfate on Carbon and Electron Flow During Microbial Methanogenesis in Freshwater Sediments," *J. Applied and Environmental Microbiology*, **33**, 2, 275-281.

Winneberger, J.H.T. (1984) *Septic-tank Systems A Consultant's Toolkit. Volume II- The Septic Tank*. The Butterworth Group, Ann Arbor, MI.

<http://cfpub.epa.gov/owm/septic/search.cfm#glossary>. Accessed on 08/04/09.

<http://www.epa.gov/ncea/iris/subst/0061.htm>, Last updated on Thursday, July 9th, 2009. Accessed on 08/19/09.

<http://www.epa.gov/nitrousoxide/sources.html>, Last updated on Thursday, July 20th, 2009. Accessed on 11/02/09.



**WASTEWATER UTILITY****Alabama**

Montgomery Water Works &  
Sanitary Sewer Board

**Alaska**

Anchorage Water &  
Wastewater Utility

**Arizona**

Avondale, City of  
Glendale, City of,  
Utilities Department  
Mesa, City of  
Peoria, City of  
Phoenix Water Services Dept.  
Pima County Wastewater  
Management  
Safford, City of  
Tempe, City of

**Arkansas**

Little Rock Wastewater Utility

**California**

Central Contra Costa  
Sanitary District  
Corona, City of  
Crestline Sanitation District  
Delta Diablo  
Sanitation District  
Dublin San Ramon Services  
District  
East Bay Dischargers  
Authority  
East Bay Municipal  
Utility District  
El Dorado Irrigation District  
Fairfield-Suisun Sewer District  
Fresno Department of Public  
Utilities  
Inland Empire Utilities Agency  
Irvine Ranch Water District  
Las Gallinas Valley Sanitary  
District  
Las Virgenes Municipal  
Water District  
Livermore, City of  
Los Angeles, City of  
Los Angeles County,  
Sanitation Districts of  
Napa Sanitation District  
Novato Sanitary District  
Orange County Sanitation  
District  
Palo Alto, City of  
Riverside, City of  
Sacramento Regional County  
Sanitation District  
San Diego Metropolitan  
Wastewater Department,  
City of  
San Francisco,  
City & County of  
San Jose, City of  
Santa Barbara, City of  
Santa Cruz, City of  
Santa Rosa, City of  
South Bayside System Authority  
South Coast Water District

South Orange County  
Wastewater Authority  
South Tahoe Public Utility  
District

Steger Sanitary District  
Sunnyvale, City of  
Union Sanitary District  
West Valley Sanitation District

**Colorado**

Aurora, City of  
Boulder, City of  
Greeley, City of  
Littleton/Englewood Water  
Pollution Control Plant  
Metro Wastewater  
Reclamation District, Denver

**Connecticut**

Greater New Haven WPCA  
Stamford, City of

**District of Columbia**

District of Columbia Water &  
Sewer Authority

**Florida**

Broward, County of  
Fort Lauderdale, City of  
Jacksonville Electric Authority  
(JEA)  
Miami-Dade Water &  
Sewer Authority  
Orange County Utilities  
Department  
Pinellas, County of  
Reedy Creek Improvement  
District  
Seminole County  
Environmental Services  
St. Petersburg, City of  
Tallahassee, City of  
Toho Water Authority  
West Palm Beach, City of

**Georgia**

Atlanta Department of  
Watershed Management  
Augusta, City of  
Clayton County Water  
Authority  
Cobb County Water System  
Columbus Water Works  
Fulton County  
Gwinnett County Department  
of Public Utilities  
Savannah, City of

**Hawaii**

Honolulu, City & County of

**Idaho**

Boise, City of

**Illinois**

Decatur, Sanitary District of  
Greater Peoria  
Sanitary District  
Kankakee River Metropolitan  
Agency  
Metropolitan Water  
Reclamation District of  
Greater Chicago  
Wheaton Sanitary District

**Indiana**

Jeffersonville, City of

**Iowa**

Ames, City of  
Cedar Rapids Wastewater  
Facility  
Des Moines, City of  
Iowa City

**Kansas**

Johnson County Wastewater  
Unified Government of  
Wyandotte County/  
Kansas City, City of

**Kentucky**

Louisville & Jefferson County  
Metropolitan Sewer District  
Sanitation District No. 1

**Louisiana**

Sewerage & Water Board  
of New Orleans

**Maine**

Bangor, City of  
Portland Water District

**Maryland**

Anne Arundel County Bureau  
of Utility Operations  
Howard County Bureau of  
Utilities  
Washington Suburban  
Sanitary Commission

**Massachusetts**

Boston Water & Sewer  
Commission  
Massachusetts Water  
Resources Authority (MWRA)  
Upper Blackstone Water  
Pollution Abatement District

**Michigan**

Ann Arbor, City of  
Detroit, City of  
Holland Board of  
Public Works  
Saginaw, City of  
Wayne County Department of  
Environment  
Wyoming, City of

**Minnesota**

Rochester, City of  
Western Lake Superior  
Sanitary District

**Missouri**

Independence, City of  
Kansas City Missouri Water  
Services Department  
Little Blue Valley Sewer District  
Metropolitan St. Louis  
Sewer District

**Nebraska**

Lincoln Wastewater &  
Solid Waste System

**Nevada**

Henderson, City of  
Las Vegas, City of  
Reno, City of

**New Jersey**

Bergen County Utilities  
Authority  
Ocean County Utilities Authority

**New York**

New York City Department of  
Environmental Protection

**North Carolina**

Charlotte/Mecklenburg  
Utilities  
Durham, City of  
Metropolitan Sewerage  
District of Buncombe County  
Orange Water & Sewer  
Authority  
University of North Carolina,  
Chapel Hill

**Ohio**

Akron, City of  
Butler County Department of  
Environmental Services  
Columbus, City of  
Metropolitan Sewer District of  
Greater Cincinnati  
Montgomery, County of  
Northeast Ohio Regional  
Sewer District  
Summit, County of

**Oklahoma**

Oklahoma City Water &  
Wastewater Utility  
Department  
Tulsa, City of

**Oregon**

Albany, City of  
Clean Water Services  
Eugene, City of  
Gresham, City of  
Portland, City of  
Bureau of Environmental  
Services  
Lake Oswego, City of  
Oak Lodge Sanitary District  
Water Environment Services

**Pennsylvania**

Hemlock Municipal Sewer  
Cooperative (HMSC)  
Philadelphia, City of  
University Area Joint Authority

**South Carolina**

Charleston Water System  
Mount Pleasant Waterworks &  
Sewer Commission  
Spartanburg Water

**Tennessee**

Cleveland Utilities  
Murfreesboro Water & Sewer  
Department  
Nashville Metro Water  
Services

**Texas**

Austin, City of  
Dallas Water Utilities  
Denton, City of  
El Paso Water Utilities

Fort Worth, City of  
Houston, City of  
San Antonio Water System  
Trinity River Authority

**Utah**

Salt Lake City Corporation

**Virginia**

Alexandria Sanitation Authority  
Arlington, County of  
Fairfax, County of  
Hampton Roads Sanitation District  
Hanover, County of  
Henrico, County of  
Hopewell Regional Wastewater Treatment Facility

Loudoun Water

Lynchburg Regional Wastewater Treatment Plant

Prince William County Service Authority

Richmond, City of

Rivanna Water & Sewer Authority

**Washington**

Everett, City of  
King County Department of Natural Resources

Seattle Public Utilities

Sunnyside, Port of

Yakima, City of

**Wisconsin**

Green Bay Metro Sewerage District

Kenosha Water Utility

Madison Metropolitan Sewerage District

Milwaukee Metropolitan Sewerage District

Racine, City of

Sheboygan Regional Wastewater Treatment

Wausau Water Works

**Water Services Association of Australia**

ACTEW Corporation

Barwon Water

Central Highlands Water

City West Water

Coliban Water Corporation

Cradle Mountain Water

Gippsland Water

Gladstone Area Water Board

Gold Coast Water

Gosford City Council

Hunter Water Corporation

Logan Water

Melbourne Water

Moreton Bay Water

Onstream

Power & Water Corporation

Queensland Urban Utilities

SEQ Water

South Australia Water Corporation

Sunshine Coast Water  
Sydney Catchment Authority  
Sydney Water  
Unity Water  
Wannon Regional Water Corporation  
Watercare Services Limited (NZ)  
Water Corporation  
Western Water  
Yarra Valley Water

**Canada**

Edmonton, City of/Edmonton Waste Management Centre of Excellence

Lethbridge, City of

Regina, City of,  
Saskatchewan

Toronto, City of, Ontario

Winnipeg, City of, Manitoba

**STORMWATER UTILITY****California**

Fresno Metropolitan Flood Control District

Los Angeles, City of,  
Department of Public Works

Monterey, City of

San Francisco, City & County of

Santa Rosa, City of

Sunnyvale, City of

**Colorado**

Aurora, City of

Boulder, City of

**Florida**

Orlando, City of

**Iowa**

Cedar Rapids Wastewater Facility

Des Moines, City of

**Kansas**

Lenexa, City of

Overland Park, City of

**Kentucky**

Louisville & Jefferson County Metropolitan Sewer District

**Maine**

Portland Water District

**North Carolina**

Charlotte, City of,  
Stormwater Services

**Pennsylvania**

Philadelphia, City of

**Tennessee**

Chattanooga Stormwater Management

**Texas**

Harris County Flood Control District, Texas

**Washington**

Bellevue Utilities Department  
Seattle Public Utilities

**STATE**

Connecticut Department of Environmental Protection

Kansas Department of Health & Environment  
New England Interstate Water Pollution Control Commission (NEIWPCC)  
Ohio Environmental Protection Agency  
Ohio River Valley Sanitation Commission  
Urban Drainage & Flood Control District, CO

**CORPORATE**

ADS LLC

Advanced Data Mining International

AECOM

Alan Plummer & Associates

Alpine Technology Inc.

Aqua-Aerobic Systems Inc.

Aquateam-Norwegian Water Technology Centre A/S

ARCADIS

Associated Engineering

Bernardin Lochmueller & Associates

Black & Veatch

Blue Water Technologies, Inc.

Brown & Caldwell

Burgess & Niple, Ltd.

Burns & McDonnell

CABE Associates Inc.

The Cadmus Group

Camp Dresser & McKee Inc.

Carollo Engineers Inc.

Carpenter Environmental Associates Inc.

CET Engineering Services

CH2M HILL

CRA Infrastructure & Engineering

CONTECH Stormwater Solutions

D&B/Guarino Engineers, LLC

Damon S. Williams Associates, LLC

Ecovation

EMA Inc.

Environmental Operating Solutions, Inc.

Environ International Corporation

Fay, Spofford, & Thorndike Inc.

Freese & Nichols, Inc.

ftn Associates Inc.

Gannett Fleming Inc.

Garden & Associates, Ltd.

Geosyntec Consultants

GHD Inc.

Global Water Associates

Greeley and Hansen LLC

Hazen & Sawyer, P.C.

HDR Engineering Inc.

HNTB Corporation

Hydromantis Inc.

HydroQual Inc.

Infilco Degremont Inc.  
Jason Consultants LLC Inc.  
Jordan, Jones, & Goulding Inc.  
KCI Technologies Inc.  
Kelly & Weaver, P.C.  
Kennedy/Jenks Consultants  
Larry Walker Associates  
LimnoTech Inc.  
Lombardo Associates, Inc.  
The Low Impact Development Center Inc.

Malcolm Pirnie Inc.

Material Matters, Inc.

McKim & Creed

MWH

NTL Alaska, Inc.

O'Brien & Gere Engineers Inc.

Odor & Corrosion Technology Consultants Inc.

Parametrix Inc.

Parsons

Post, Buckley, Schuh & Jernigan

Praxair, Inc.

RMC Water & Environment

Ross & Associates Ltd.

SAIC

Siemens Water Technologies

The Soap & Detergent Association

Smith & Loveless, Inc.

Southeast Environmental Engineering, LLC

Stone Environmental Inc.

Stratus Consulting Inc.

Synagro Technologies Inc.

Tetra Tech Inc.

Trojan Technologies Inc.

Trussell Technologies, Inc.

URS Corporation

Wallingford Software

Westin Engineering Inc.

Wright Water Engineers

Zoeller Pump Company

**INDUSTRY**

American Electric Power

American Water

Anglian Water Services, Ltd.

Chevron Energy Technology

The Coca-Cola Company

Dow Chemical Company

DuPont Company

Eastman Chemical Company

Eli Lilly & Company

InsinkErator

Johnson & Johnson

Merck & Company Inc.

Procter & Gamble Company

Suez Environment

United Utilities North West

(UUNW)

United Water Services LLC

Veolia Water North America

**Note: List as of 4/20/10**

## WERF Board of Directors

---

<b>Chair</b> Alan H. Vicory, Jr., P.E., BCEE Ohio River Valley Water Sanitation Co	Patricia J. Anderson, P.E. Florida Department of Health  Jeanette A. Brown, P.E., BCEE, D.WRE Stamford Water Pollution Control Authority  Catherine R. Gerali Metro Wastewater Reclamation District  Charles N. Haas, Ph.D., BCEEM Drexel University  Stephen R. Maquin Sanitation Districts of Los Angeles County	Karen L. Pallansch, P.E., BCEE Alexandria Sanitation Authority  Robert A. Reich, P.E. DuPont Company  R. Rhodes Trussell, Ph.D., P.E. Trussell Technologies Inc.  Rebecca F. West Spartanburg Water  Brian L. Wheeler Toho Water Authority  Joseph E. Zuback Global Water Advisors, Inc.	<b>Executive Director</b> Glenn Reinhardt
<b>Vice-Chair</b> William P. Dee, P.E., BCEE Malcolm Pirnie, Inc.			
<b>Secretary</b> William J. Bertera Water Environment Federation			
<b>Treasurer</b> Jeff Taylor Freese and Nichols, Inc.			

## WERF Research Council

---

<b>Chair</b> Karen L. Pallansch, P.E., BCEE Alexandria Sanitation Authority	William J. Cooper, Ph.D. University of California- Irvine  Ann Farrell, P.E. Central Contra Costa Sanitary District (CCCSD)	James A. Hanlon U.S. Environmental Protection Agency  James A. Hodges, CPEng. Watercare Services Limited  David Jenkins, Ph.D. University of California at Berkeley  Lloyd W. Johnson, M.P.D., P.E. Aqua-Aerobic Systems, Inc.	Terry L. Johnson, Ph.D., P.E., BCEE Black & Veatch Corporation  Beverley M. Stinson, Ph.D. AECOM  Susan J. Sullivan New England Interstate Water Pollution Control Commission (NEIWPC)
<b>Vice-Chair</b> John B. Barber, Ph.D. Eastman Chemical Company	Robbin W. Finch Boise, City of  Thomas Granato, Ph.D. Metropolitan Water Reclamation District of Greater Chicago		



# WERF Product Order Form

As a benefit of joining the Water Environment Research Foundation, subscribers are entitled to receive one complimentary copy of all final reports and other products. Additional copies are available at cost (usually \$10). To order your complimentary copy of a report, please write "free" in the unit price column. WERF keeps track of all orders. If the charge differs from what is shown here, we will call to confirm the total before processing.

Name	Title		
Organization			
Address			
City	State	Zip Code	Country
Phone	Fax	Email	

Stock #	Product	Quantity	Unit Price	Total

### Method of Payment: (All orders must be prepaid.)

- C check or Money Order Enclosed  
 Visa       Mastercard       American Express

Account No.	Exp. Date
Signature	

Postage & Handling  
 VA Residents Add  
 5% Sales Tax  
 Canadian Residents  
 Add 7% GST

**TOTAL**

### Shipping & Handling:

Amount of Order	United States	Canada & Mexico	All Others
Up to but not more than:	Add:	Add:	Add:
\$20.00	\$7.50*	\$9.50	50% of amount
30.00	8.00	9.50	40% of amount
40.00	8.50	9.50	
50.00	9.00	18.00	
60.00	10.00	18.00	
80.00	11.00	18.00	
100.00	13.00	24.00	
150.00	15.00	35.00	
200.00	18.00	40.00	
More than \$200.00	Add 20% of order	Add 20% of order	
* minimum amount for all orders			

### To Order (Subscribers Only):

 Log on to [www.werf.org](http://www.werf.org) and click on "Publications."

 Phone: 571-384-2100  
 Fax : 703-299-0742

 WERF  
 Attn: Subscriber Services  
 635 Slaters Lane  
 Alexandria, VA 22314-1177

### To Order (Non-Subscribers):

Non-subscribers may order WERF publications either through WERF or IWAP ([www.iwapublishing.com](http://www.iwapublishing.com)). Visit WERF's website at [www.werf.org](http://www.werf.org) for details.

Make checks payable to the Water Environment Research Foundation.





Water Environment Research Foundation

635 Slaters Lane, Suite G-110 ■ Alexandria, VA 22314-1177

Phone: 571-384-2100 ■ Fax: 703-299-0742 ■ Email: [werf@werf.org](mailto:werf@werf.org)

[www.werf.org](http://www.werf.org)

WERF Stock No. DEC1R09

Co-published by

IWA Publishing

Alliance House, 12 Caxton Street

London SW1H 0QS

United Kingdom

Phone: +44 (0)20 7654 5500

Fax: +44 (0)20 7654 5555

Email: [publications@iwap.co.uk](mailto:publications@iwap.co.uk)

Web: [www.iwapublishing.co](http://www.iwapublishing.co)

IWAP ISBN: 978-1-84339-616-1/1-84339-616-5



July 2010