

Optimal Stormwater Management Plan Alternatives: A Demonstration Project in Three Upper Charles River Communities

Final Report

December 2009

Prepared for:

**United States Environmental Protection Agency – New England
One Congress Street, Suite 1100
Boston, MA 02114**

and

**Massachusetts Department of Environmental Protection
One Winter Street
Boston, MA 02108**

Prepared by:

**Tetra Tech, Inc.
10306 Eaton Place, Suite 340
Fairfax, VA 22030**



Contents

Executive Summary	v
1 Introduction	1
2 Data for Developing HRUs and Management Categories	3
2.1 Land Data	3
2.2 Rainfall Data	6
2.3 Design Specifications of BMPs	7
2.3.1 Infiltration Systems	7
2.3.2 Biofiltration and Bioinfiltration	8
2.3.3 Water Quality Swales	9
2.3.4 Porous Pavement	10
2.3.5 Gravel Wetland	11
2.3.6 Retention/Detention Ponds	12
2.4 Costs of BMPs	12
3 Developing Hydrologic Response Units (HRUs)	14
3.1 Generating HRU Maps	14
3.2 Estimating HRU Loading Rates	16
3.3 Generating HRU Time Series	16
4 Developing Management Categories	17
4.1 Design Requirements for BMPs	17
4.1.1 Porous Pavement	17
4.1.2 Infiltration System	17
4.1.3 Bioretention Area	17
4.1.4 Gravel Wetland	17
4.1.5 Water Quality Swales (Wet)	18
4.1.6 Wet Pond	18
4.1.7 Dry Pond	18
4.2 Developing Management Categories	19
5 Optimizing BMP Implementation Alternatives	21
5.1 Tabulating HRUs into Management Categories	21
5.2 BMP Setup without Optimization	22
5.3 The Optimization Problem	23
5.3.1 Refined Optimization Setup	23
5.4 BMP Optimization Scenario I	24
5.4.1 Scenario I Setup	24
5.4.2 Scenario I Results	30
5.4.3 Required Level of Treatment for Scenario I	32
5.5 BMP Optimization Setup Scenario II	36
5.5.1 Neighborhood BMPs	36
5.5.2 Scenario II Setup	38
5.5.3 Scenario II Results	44
5.5.4 Required Level of Treatment for Scenario II	46
5.6 BMP Optimization Setup Scenario III	50
5.6.1 Scenario III Setup	52
5.6.2 Scenario III Results	52
5.6.3 Required Level of Treatment for Scenario III	54

5.7 Summary and Conclusions 58
 Acknowledgments..... 60
 6 References..... 61
 Appendix A. HRU Maps in the Three Charles River Communities..... 63
 Appendix B. Management Category Maps in the Three Upper Charles River
 Communities 66

Tables

Table 2-1. Summary of area and imperviousness of the three communities (Charles River
 portion) selected for the pilot project..... 3
 Table 2-2. Design parameters for infiltration type BMPs..... 7
 Table 2-3. Design parameters for biofiltration 8
 Table 2-4. Design parameters for water quality swales 9
 Table 2-5. The design parameters for porous pavement..... 10
 Table 2-6. The design parameters for the gravel wetland..... 11
 Table 2-7. Design parameters for a wet retention pond..... 12
 Table 2-8. Construction cost information for several BMPs 13
 Table 3-1. Summary of HRU groups to be generated for the three Upper Charles River
 communities 15
 Table 3-2. Phosphorus load export rates for Bellingham, Franklin, and Milford..... 16
 Table 4-1. Site restrictions for potential BMPs 19
 Table 4-2. Categorizing management categories on the basis of site conditions 20
 Table 5-1. Summary of phosphorus removal for various BMP sizing schemes in
 Bellingham..... 22
 Table 5-2. Summary of phosphorus removal for various BMP sizing schemes in Franklin
 22
 Table 5-3. Summary of phosphorus removal for various BMP sizing schemes in Milford
 23
 Table 5-4. Tabulation of impervious HRUs into management categories in Bellingham
 for Scenario I setup (Unit: acres)..... 27
 Table 5-5. Tabulation of impervious HRUs into management categories in Franklin for
 Scenario I setup (Unit: acres)..... 28
 Table 5-6. Tabulation of impervious HRUs into management categories in Milford for
 Scenario I setup (Unit: acres)..... 29
 Table 5-7. Summary of optimal solutions identified for Scenario I in the three
 communities 32
 Table 5-8. The level of treatment needed in Bellingham for Scenario I..... 33
 Table 5-9. The level of treatment needed in Franklin for Scenario I..... 34
 Table 5-10. The level of treatment needed in Milford for Scenario I..... 35
 Table 5-11. Tabulation of impervious HRUs into onsite and neighborhood management
 categories in Bellingham for Scenario II setup (Unit: acres)..... 41
 Table 5-12. Tabulation of impervious HRUs into onsite and neighborhood management
 categories in Franklin for Scenario II setup (Unit: acres)..... 42
 Table 5-13. Tabulation of impervious HRUs into onsite and neighborhood management
 categories in Milford for Scenario II setup (Unit: acres)..... 43

Table 5-14. Summary of optimal solutions identified for Scenario II in all three communities.....	46
Table 5-15. The level of treatment needed in Bellingham for Scenario II.....	47
Table 5-16. The level of treatment needed in Franklin for Scenario II.....	48
Table 5-17. The level of treatment needed in Milford for Scenario II.....	49
Table 5-18. Near-optimal solutions identified for Scenario III as compared to those for Scenario II in the three communities.....	54
Table 5-19. The level of treatment needed in Bellingham for Scenario III.....	55
Table 5-20. The level of treatment needed in Franklin for Scenario III.....	56
Table 5-21. The level of treatment needed in Milford for Scenario III.....	57
Table 5-22. Summary of scenario setups in the three Upper Charles River communities.....	58
Table 5-23. Summary of total costs for the BMP scenarios.....	59

Figures

Figure 1-1. The general concept of the pilot project.....	2
Figure 2-1. Imperviousness in the three Upper Charles River communities of Bellingham, Franklin, and Milford.....	4
Figure 2-2. Land uses in the three Upper Charles River communities of Bellingham, Franklin, and Milford.....	5
Figure 2-3. Soils in the three Upper Charles River communities of Bellingham, Franklin, and Milford.....	6
Figure 2-4. Typical cross sections for infiltration type of BMPs.....	7
Figure 2-5. Typical cross sections for biofiltration.....	8
Figure 2-6. Typical designs for the water quality swale.....	9
Figure 2-7. Typical cross-sectional design for porous pavement.....	10
Figure 2-8. Cross-sectional design for the gravel wetland.....	11
Figure 2-9. The design for a wet retention pond.....	12
Figure 5-1. Routing of HRU to management category and Scenario I setup in the Upper Charles River communities.....	26
Figure 5-2. BMPDSS optimization results for Scenario I setup in Bellingham.....	30
Figure 5-3. BMPDSS optimization results for Scenario I setup in Franklin.....	31
Figure 5-4. BMPDSS optimization results for Scenario I setup in Milford.....	31
Figure 5-5. The HMU subbasins in the communities of Bellingham, Franklin, and Milford.....	37
Figure 5-6. Scenario II setup in the three Upper Charles River communities.....	39
Figure 5-7. BMPDSS optimization results for Scenario II setup in Bellingham.....	44
Figure 5-8. BMPDSS optimization results for Scenario II setup in Franklin.....	45
Figure 5-9. BMPDSS optimization results for Scenario II setup in Milford.....	45
Figure 5-10. Schematic for Scenario III setup in the three Upper Charles River communities.....	51
Figure 5-11. BMPDSS optimization results for Scenario III setup in Bellingham.....	52
Figure 5-12. BMPDSS optimization results for Scenario III setup in Franklin.....	53
Figure 5-13. BMPDSS optimization results for Scenario III setup in Milford.....	53

Executive Summary

The *Lower Charles River Phosphorus Total Maximum Daily Load* (TMDL) sets stormwater phosphorus load reduction targets for communities in the Charles River watershed, Massachusetts. With the upcoming renewal of the National Pollutant Discharge Elimination System (NPDES) permits for municipal separate storm sewer systems (MS4 permits), it is anticipated that each community will need to develop stormwater management plans to meet its respective stormwater phosphorus load reduction requirements. Managing stormwater runoff from large urban/suburban landscapes is a complex process in which managers must consider numerous factors, including site conditions, source areas, space limitations, and the widely varying pollutant removal efficiencies of available best management practices (BMPs). One way to systematically consider the many important factors when developing a stormwater management plan is by using optimization techniques. This project is a demonstration study of using optimization techniques to help identify cost-effective solutions to meet the phosphorus TMDL reduction targets in three Upper Charles River communities: Bellingham, Franklin, and Milford.

The project involved extensive geographic information system data analysis and regular interaction with representatives from the three communities. Hydrologic response units (HRUs) were generated to derive runoff and water quality time series from a variety of source areas that represent different land use and soil conditions. Runoff time series were routed to management categories, which correspond to BMPs that are applicable to certain estimated site conditions. The communities provided valuable insights into the probability of locating *neighborhood* BMPs and better understanding of locally known site constraints. Three scenarios were developed in conjunction with local officials to make the scenarios as real world as possible for each community. Such efforts included quality checking of land use data, site constraints, management concepts, hydrologic management units, and scenario setup. The Best Management Practices Decision Support System (BMPDSS) program was used to set up and optimize three BMP implementation alternatives. In Scenario I, runoff from all impervious HRUs was completely treated by onsite BMPs. In Scenario II, runoff from the public right-of-way and highly constrained parcels deemed unlikely for onsite BMPs was treated by neighborhood BMPs, and runoff from the remaining impervious areas was still treated by onsite BMPs. In Scenario III, runoff from the public right-of-way was treated by neighborhood BMPs, and runoff from both pervious and impervious HRUs was treated by onsite BMPs. For comparison purposes, a benchmark scenario with no optimization was also set up, and all BMPs in that scenario were sized to provide a fixed level of treatment to the inflow (called the uniform sizing strategy). Overall the scenarios made no differentiation between regulatory mechanisms, and phosphorus loadings from both the MS4 and the privately owned sources were taken into account. In addition, only structural BMPs were used for the analysis in this project.

The optimization processes helped identify the most cost-effective BMP implementation alternative for each of the three BMP setup scenarios in each community. The BMP construction costs were used during the optimization process. For all three communities, the near-optimal BMP implementation alternative identified through the optimization

process was able to significantly reduce the total project cost for meeting the TMDL reduction targets when compared to the uniform sizing strategy. This was consistently observed for all three BMP setup scenarios in each community. For example, the uniform-sizing-strategy-estimated costs for the three communities were about two to three times those of the Scenario III near-optimal BMP implementation alternative total costs. Overall, the results demonstrate that the optimization techniques are able to help identify more cost-effective BMP implementation alternatives in a community, and there could be significant reductions in project costs by adopting the optimization techniques during TMDL implementation. The optimization results also show that BMPs with higher efficiencies in phosphorus removal, placed in areas of high phosphorus loads, tend to have larger sizes in the near-optimal BMP implementation scenario. The resulting sizes of the different BMPs identified in the near-optimal BMP implementation scenario also provides a starting point for developing a trading framework for phosphorus-reduction credits.

1 Introduction

The *Lower Charles River Phosphorus Total Maximum Daily Load (TMDL)* (MassDEP and USEPA 2007) was developed for reducing algae levels in the Lower Charles River and for attaining Massachusetts Surface Water Quality Standards. The TMDL implementation plan provides estimations of existing phosphorus loads and necessary load reductions by land use categories, as well as the overall reduction needed by each community in the Charles River watershed. When implementing the TMDL, each community is faced with the key question of how to achieve the needed reductions with available best management practice (BMP) technologies given the distribution of land use, impervious cover, and soil type within the community. Developing an answer to that question requires analysis of land characteristics, source areas, site constraints, BMP effectiveness, and BMP costs, the combinations of which would be difficult to numerate. For example, phosphorus loadings from different source areas and the pollutant-removal effectiveness of different BMPs are known to vary considerably. Meanwhile, the optimization techniques can account for the many aforementioned variables in a community and efficiently search through the TMDL implementation plan alternatives, resulting in more cost-effective choices.

The goal of this project was to investigate cost-effective stormwater management alternatives for a community to achieve needed phosphorus reductions. The communities need insight into what is the optimal mix of BMP technologies and level of control for their portion of the Charles River watershed. As a demonstration study, the project objectives were to develop optimized, planning-level-scale stormwater management alternatives for the communities of Bellingham, Franklin, and Milford, Massachusetts, and to identify the overall level of stormwater control in each community for meeting the Lower Charles River Phosphorus TMDL targets. The primary tools employed in this project include the ArcGIS geographic information system (GIS); the U.S. Environmental Protection Agency's (EPA's) Stormwater Management Model (SWMM) (Rossman 2007); and the Prince George's County, Maryland's Best Management Practice Decision Support System (BMPDSS) model (Tetra Tech 2005). The BMPDSS model had been previously calibrated and validated using monitored data from the University of New Hampshire Stormwater Center (Tetra Tech 2008).

A general concept of the project is presented in Figure 1-1. As shown, in each community, the watershed data of land use, imperviousness, and soils information are used to categorize the community into various hydrologic response units (HRUs). Each HRU has its unique flow and water quality time series, which was generated using the SWMM. Management categories were developed in each community on the basis of BMP design specifications and the watershed data of imperviousness, soil type, depth to bedrock, depth to water table, and available space to install a BMP. Each management category corresponds to one unique type of BMP, which is most suitable for implementation on sites with the combination of constraints that define the management category. In each community, BMPDSS identifies the appropriate size of management categories (i.e., BMPs) for treating runoff from respective source areas (HRUs) to meet the TMDL reduction goals during the optimization process.

This project was conducted at a planning level-scale, and that was because a parcel level representation and routing of BMPs would be too detailed and would require resources far beyond what was available. In the planning level analysis, the unique combinations of HRUs and management categories (BMPs) were first aggregated across each community. The runoff from each HRU was then routed to the respective management category for carrying out the optimization process.

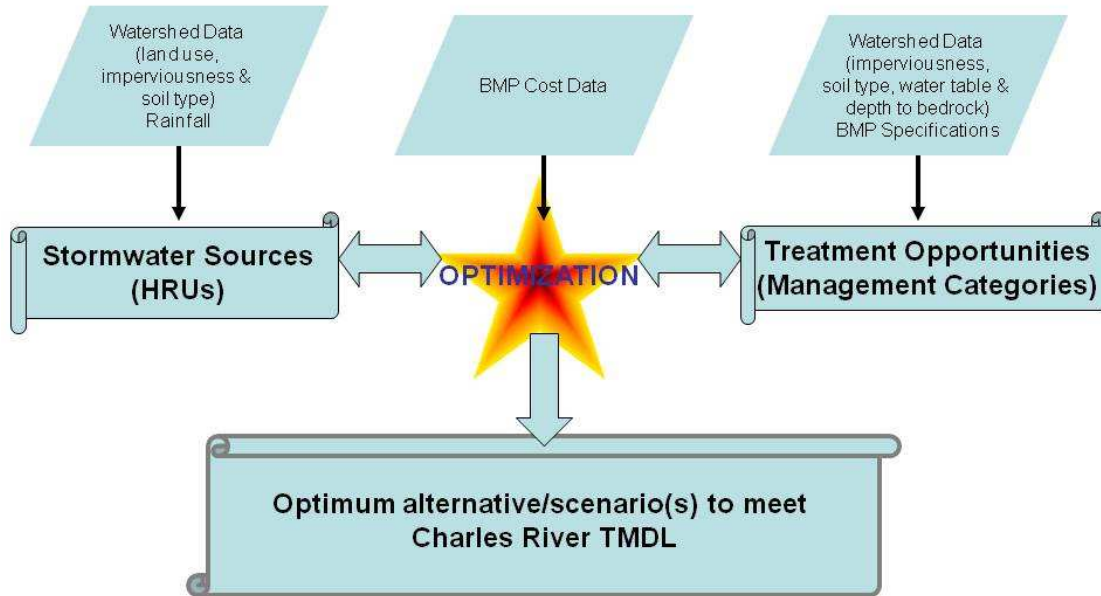

Figure 1-1. The general concept of the pilot project.

In this report, Chapter 2 presents the watershed data used for HRU and management category development, as well as the costs for BMPs, Chapter 3 presents the development of HRUs, and Chapter 4 presents the development of management categories. The setup and optimization of three BMP scenarios in the three communities are presented in Chapter 5. HRU and management category maps for the communities are included in the Appendices.

2 Data for Developing HRUs and Management Categories

2.1 Land Data

Land data are the basis for characterizing HRU runoff conditions in the three Upper Charles River communities. The land data used for HRU flow and water quality time series generation include the impervious cover, land use category, and soils data. Impervious cover data came from MassGIS and were derived from the 2005 orthophotography using techniques such as image interpretation. The land use data were also from MassGIS and were based on the 2005 orthophotography. The data were quality checked by local officials and were supplemented where possible with assessors' data. The Natural Resources Conservation Service (NRCS) of Amherst, Massachusetts, provided soils data. The Massachusetts Department of Environmental Protection (MassDEP) GIS Program performed much of the data preparation and preliminary analysis.

The impervious surfaces in the Upper Charles River communities are illustrated in Figure 2-1. A summary of the community areas and imperviousness in the three communities is shown in Table 2-1, along with the TMDL target for total phosphorus (TP) removal. The impervious areas are composed of buildings, parking lots, and roads. Both the area and imperviousness assessments in Table 2-1 are limited to the Charles River portion of each community.

Table 2-1. Summary of area and imperviousness of the three communities (Charles River portion) selected for the pilot project

Community	Total area (ac)	Imperviousness		TMDL TP load reduction target
		Area (ac)	Percentage	
Bellingham	6,278	918	15%	52%
Franklin	16,420	2,364	14%	52%
Milford	8,183	1,662	20%	57%

Land uses in the three communities are illustrated in Figure 2-2. As shown, there are 10 categories of land uses (excluding water). Except for agriculture, all the land use categories consist of both pervious and impervious surfaces. The Society of Soil Scientists of Southern New England (<http://nesoil.com/ssssne/>) provided soils conditions in the three communities, and the conditions are illustrated in Figure 2-3.

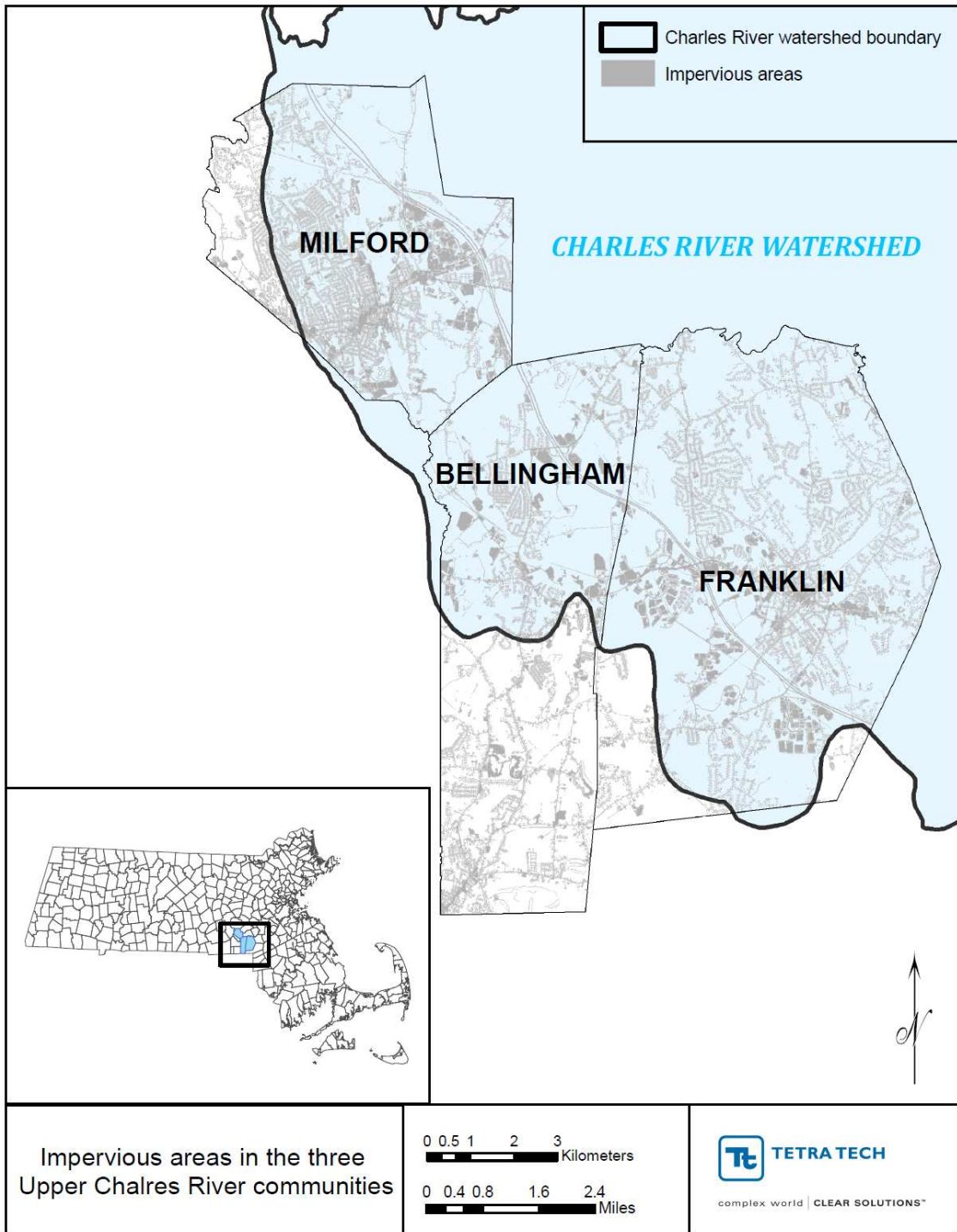

Figure 2-1. Imperviousness in the three Upper Charles River communities of Bellingham, Franklin, and Milford.

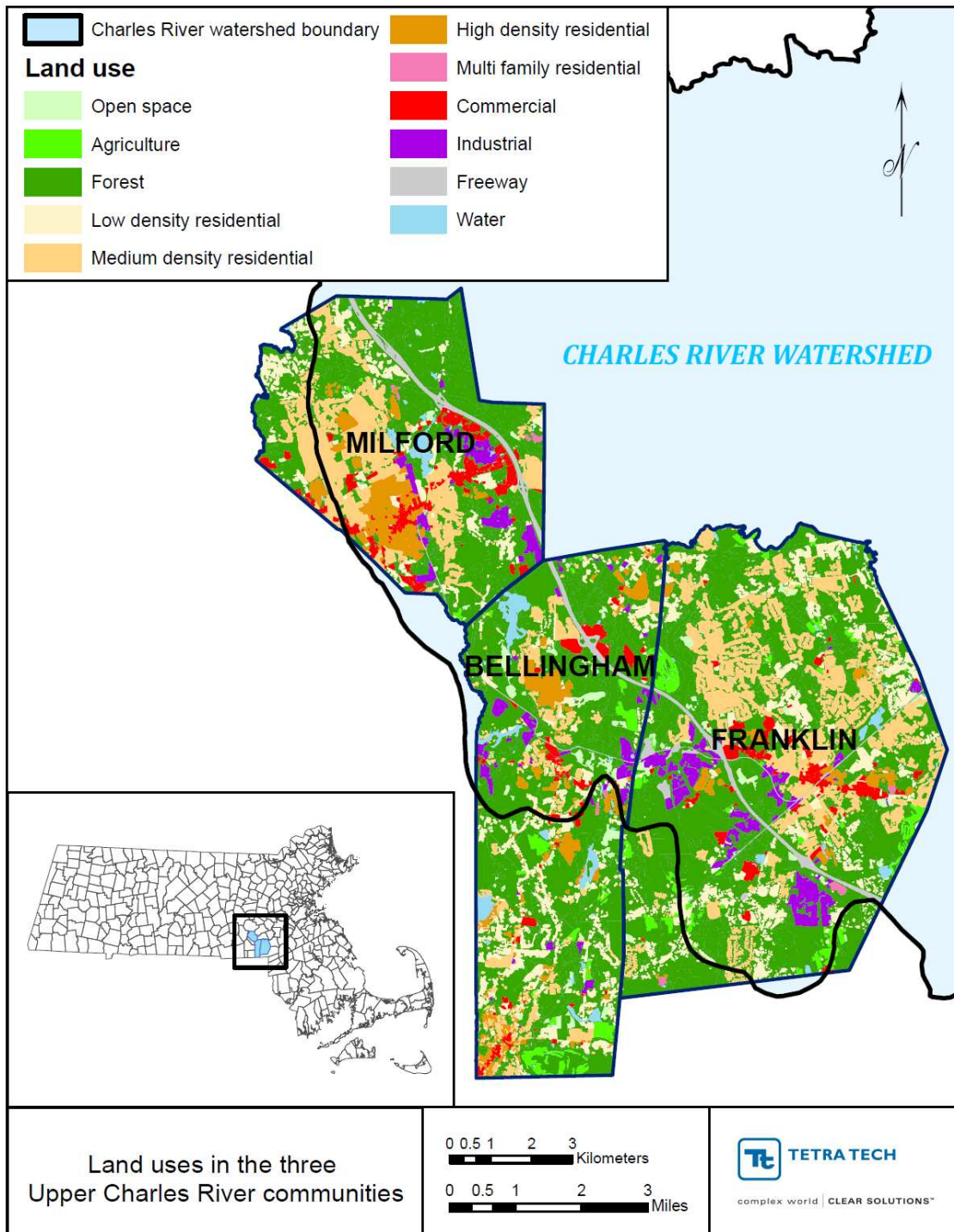

Figure 2-2. Land uses in the three Upper Charles River communities of Bellingham, Franklin, and Milford.

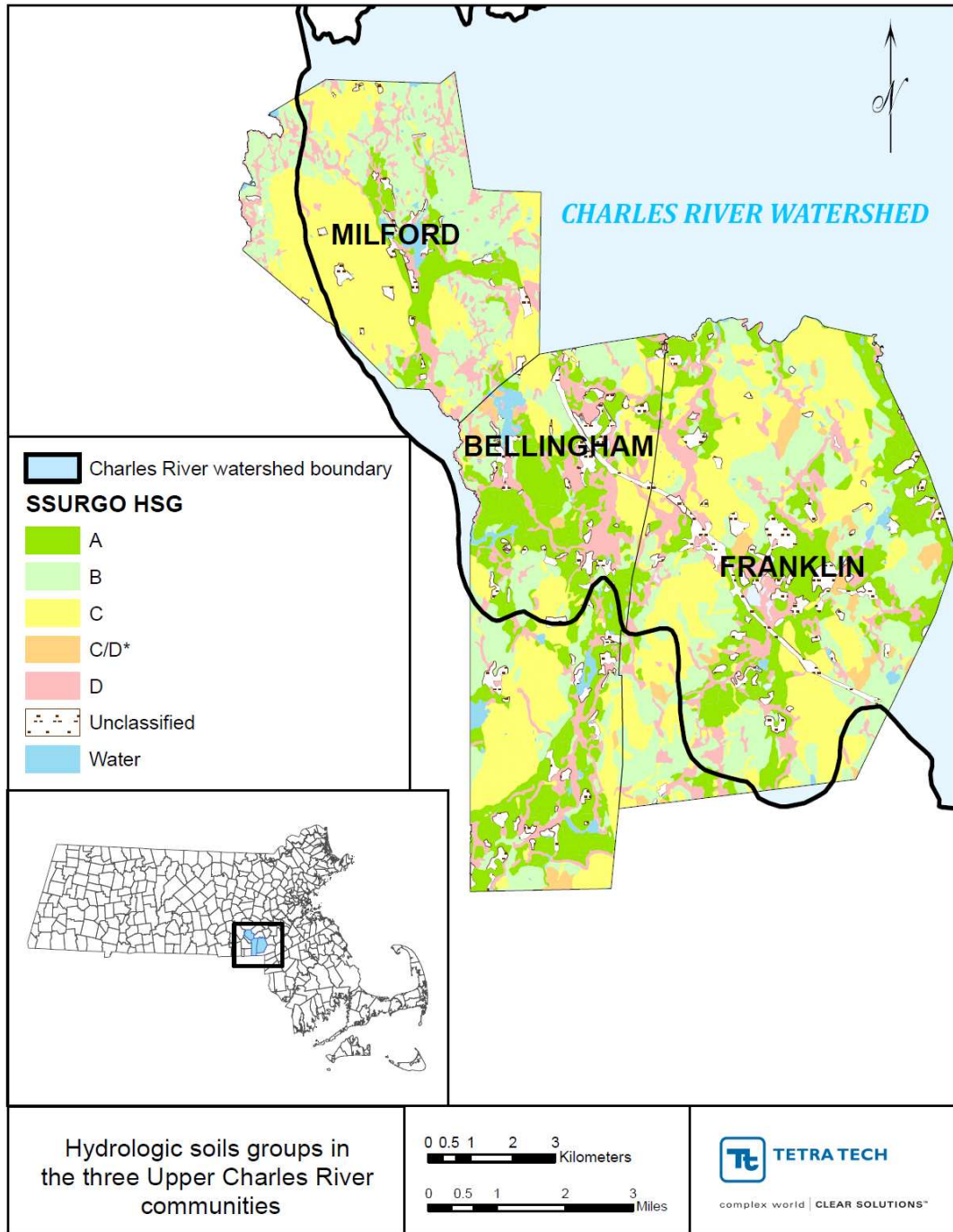

Figure 2-3. Soils in the three Upper Charles River communities of Bellingham, Franklin, and Milford.

2.2 Rainfall Data

Ten-year (01/01/1992-12/31/2001) hourly rainfall data from the Boston International Airport (MA0770) were used to generate the HRU time series for this study. The Boston station has an average annual precipitation of 42.66 inches and is in the *Coastal* climate

region of eastern Massachusetts. The precipitation frequency distribution for the Boston station indicates that 49 percent of the rainfall events are less than 0.1 inch, 44 percent of the rainfall events are between 0.1 to 1 inch, and 7 percent falls in storms of more than 1 inch (Tetra Tech 2008).

2.3 Design Specifications of BMPs

Five types of BMPs that are applicable for individual sites in the three communities are introduced below. The BMPs are infiltration systems, bioinfiltration, biofiltration, water quality swales, and porous pavement. Also, other BMPs that might be used as regional or neighborhood BMPs, such as the gravel wetland and retention/detention ponds, are discussed below as well. Typical cross sections and design and construction specifications for the BMPs were obtained from the *Massachusetts Stormwater Handbook* (MassDEP 2008) and are summarized below.

2.3.1 Infiltration Systems

Infiltration types of BMPs are often used in areas with a high infiltration rate and a low groundwater table. A typical cross section for the infiltration type of BMPs is shown in Figure 2-4, and the typical designs are summarized in Table 2-2.

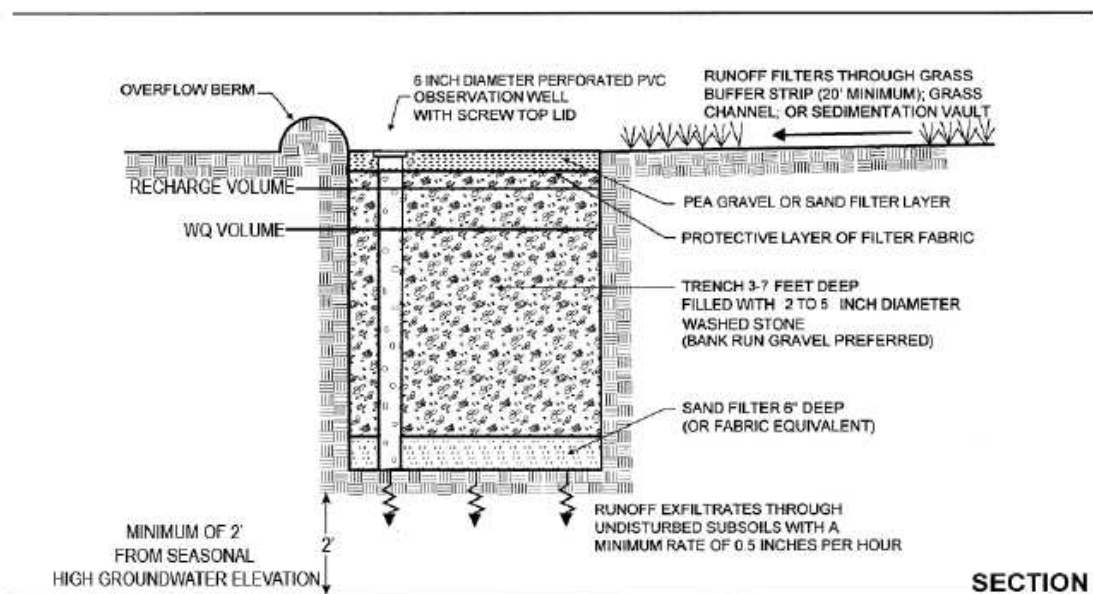

Source: MassDEP 2008

Figure 2-4. Typical cross sections for infiltration type of BMPs.

Table 2-2. Design parameters for infiltration type BMPs

Components of representation		Design parameters	Value
Infiltration Unit	Sand filter	Porosity	40%
		Depth	6 in
	Stone layer	Depth	6 feet
		Porosity	45%

Source: MassDEP 2008

2.3.2 Biofiltration and Bioinfiltration

A typical cross section for the biofiltration facility is shown in Figure 2-5. The representation can also be used for a bioretention facility. When the optional underdrain shown in Figure 2-5 is turned off, the system becomes a bioinfiltration facility. The typical design for the biofiltration (bioinfiltration) facility is summarized in Table 2-3.

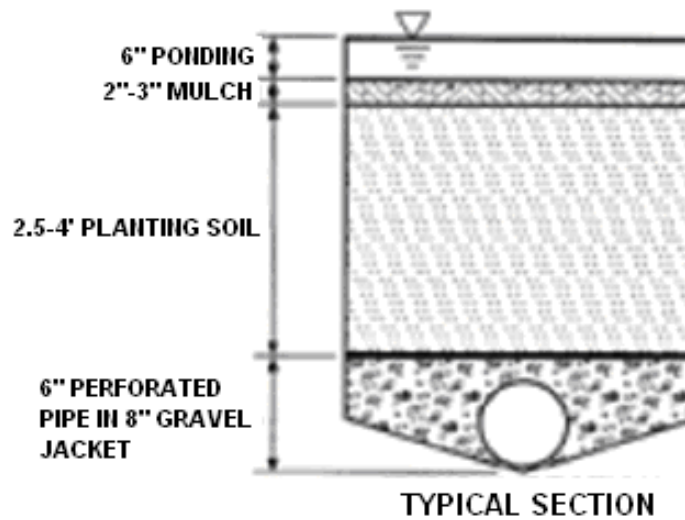

Source: MassDEP 2008

Figure 2-5. Typical cross sections for biofiltration.

Table 2-3. Design parameters for biofiltration

Components of representation	Parameters	Value
Ponding	Maximum depth	6 in
	Surface area	Varies with runoff depth treated
	Vegetative parameter	85%–95%
Soil mix	Depth	30 in
	Porosity	40%
	Hydraulic conductivity	4 in/hr
Gravel layer	Depth	8 in
	Porosity	40%
	Hydraulic conductivity	14 in/hr
Orifice #1	Diameter	6 in

Source: MassDEP 2008

Note: in = inches; in/hr = inches per hour

2.3.3 Water Quality Swales

The typical design for a water quality swale is shown in Figure 2-6. The design parameters for water quality swales are summarized in Table 2-4.

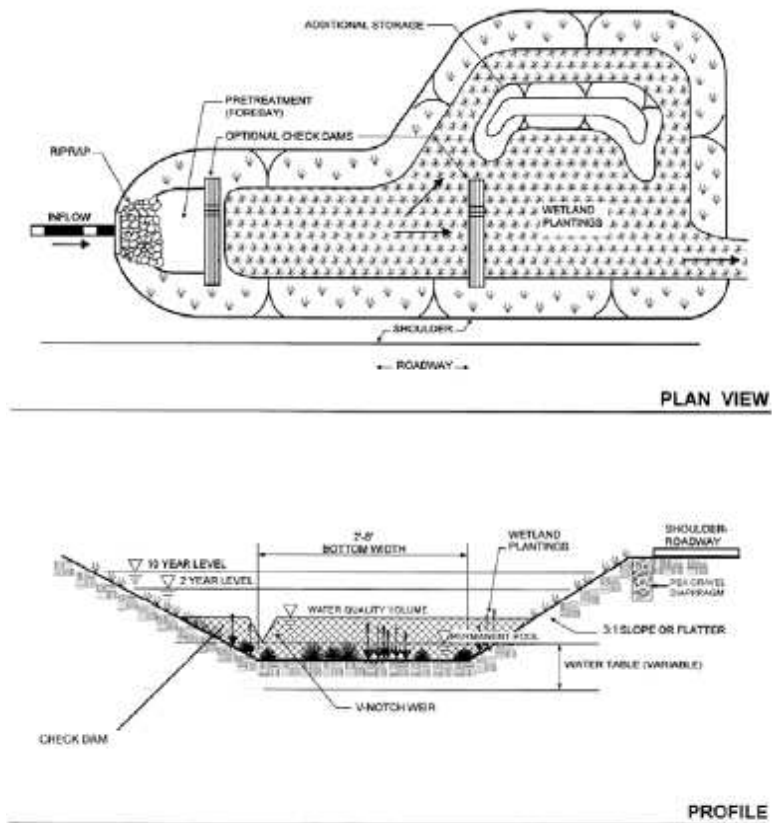

Source: MassDEP 2008

Figure 2-6. Typical designs for the water quality swale.

Table 2-4. Design parameters for water quality swales

Components of representation	Design parameters	Value
Swale channel	Bottom width	2–8 feet
	Maximum depth	4 feet
	Side slope	4:1
	Longitudinal slope	1%
	Length	Variable
	Manning's roughness	0.25
	Vegetative parameter	80%

Source: MassDEP 2008

2.3.4 Porous Pavement

The cross section for porous pavement is shown in Figure 2-7. As shown, the design has a five-layer design. The design parameters are summarized in Table 2-5, in which the 3-inch filter blanket layer is neglected.

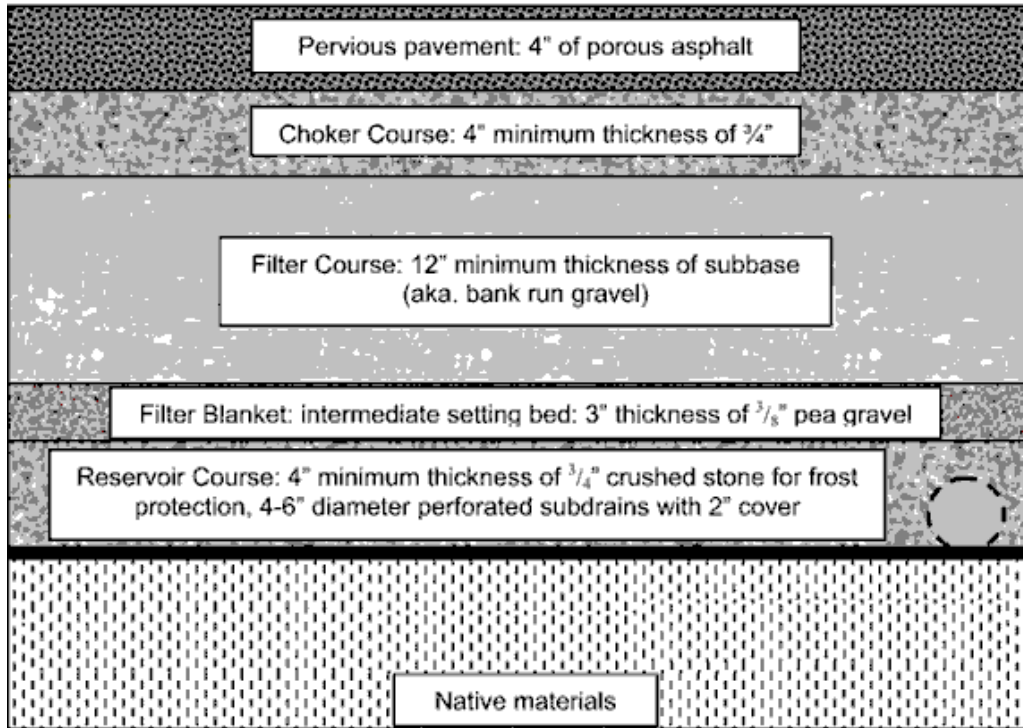

Source: MassDEP 2008

Figure 2-7. Typical cross-sectional design for porous pavement.

Table 2-5. The design parameters for porous pavement

Components of representation		Design parameters	Value
Composite layer	Porous asphalt	Depth	4 in
		Porosity	18%–20%
		Hydraulic conductivity	750 in/hr
	Chocker course	Depth	4 in
		Porosity	40%
		Hydraulic conductivity	14 in/hr
Filter course	Depth	12 in–32 in	
	Porosity	25%	
	Hydraulic conductivity	1.4 in/hr	
Gravel layer	Depth	8 in	
	Porosity	40%	
	Hydraulic conductivity	14 in/hr	

Source: MassDEP 2008

2.3.5 Gravel Wetland

The typical cross section for a gravel wetland is shown in Figure 2-8. The design is from the University of New Hampshire Stormwater Center. The design parameters for the gravel wetland are summarized in Table 2-6.

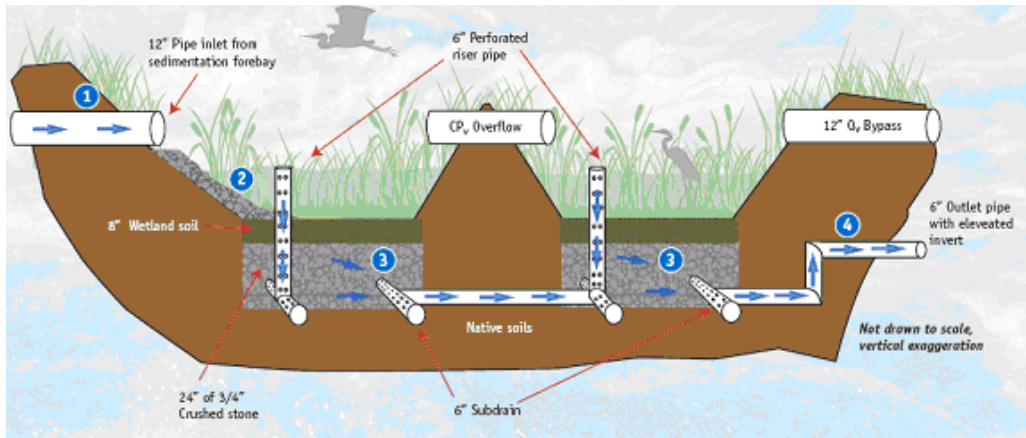

Source: UNHSC 2007

Figure 2-8. Cross-sectional design for the gravel wetland.

Table 2-6. The design parameters for the gravel wetland

Components of representation		Design parameters	Value
Sediment Forebay (10% of treatment volume)		Depth	1.3 feet
		Surface area	Variable
Wetland Cell #1 (45% of treatment volume)	Ponding area	Surface area	Variable
		Depth	2.2 feet
	Gravel layer	Depth	24 in
Wetland Cell #2 (45% of treatment volume)	Ponding area	Surface area	Variable
		Maximum depth	2.2 feet
	Gravel layer	Depth	24 in

Source: UNHSC 2007

2.3.6 Retention/Detention Ponds

The design of a typical retention/detention pond is shown in Figure 2-9. As shown, the design has a sediment forebay, the volume of which is 25 percent of the permanent pool. The design parameters are summarized in Table 2-7.

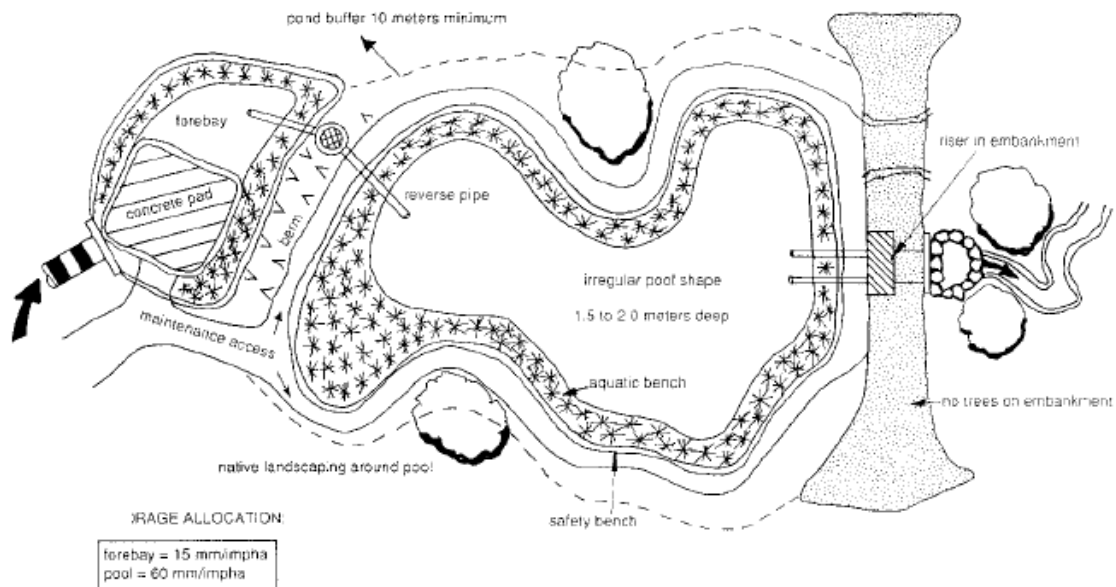

Source: MassDEP 2008

Figure 2-9. The design for a wet retention pond.

Table 2-7. Design parameters for a wet retention pond

Components of representation	Design parameters	Value
Sediment forebay (Volume = 0.25 x Permanent Pool & Slope 4:1)	Bottom area	Variable
	Maximum depth	2 feet
	Surface area	Variable
Permanent Pool (Volume = Runoff Depth Treated x Area Treated & Slope 4:1)	Bottom area	Variable
	Maximum depth	6 feet
	Surface area	Variable

Source: MassDEP 2008

2.4 Costs of BMPs

Cost is another critical component when optimizing various BMP setup scenarios. For this study, cost estimates were primarily developed for making relative comparisons among the various BMP alternatives in each community. Capital costs of a BMP is a sum of the land cost, engineering planning and design costs, construction cost, and the costs for environmental mitigation. The construction cost is typically used to represent the capital cost for planning level analysis purposes because the land cost, engineering costs,

and the costs for environmental mitigation are site specific (Sample et al. 2003). Therefore, cost estimates for this study are based on construction cost data.

The construction cost information for several BMPs was compiled and evaluated on the basis of several sources and is summarized in Table 2-8. The original information has varying unit costs for different BMP size ranges, and here the cost information is simplified as a linear function to the BMP size.

Table 2-8. Construction cost information for several BMPs

BMP	Cost
Bioretention area	\$3.20 (per ft ³ treated)
Constructed wetland	\$1.77 (per ft ³ treated)
Grass swale	\$0.45 (per ft ²)
Infiltration trench	\$2.88 (per ft ³ treated)
Porous pavement	\$1.52 (per ft ²)
Retention/Detention basins	\$1.57 (per ft ³ treated)
Sand filter	\$3.48 (per ft ³ treated)

Source: USEPA 1999; NCSU 2003; CWP 2007

ft³ = cubic feet

The construction cost information for this study was mainly intended to help compare different BMP implementation alternatives. That is, the optimization process was based on relative costs, and the cost values should not be taken literally. When added together the resulting totals were total relative costs. Actual costs could be higher, though economies of scale are hard to predict. Unless explicitly specified otherwise, all the costs hereafter in this report are construction costs.

3 Developing Hydrologic Response Units (HRUs)

The concept of HRUs was used in this project for generating runoff from various source areas. The HRU runoff time series were then routed to respective BMPs or management categories for assessing phosphorus load reductions. This section presents the development of HRUs in the three communities, the estimation of HRU loading rates, and the generation of HRU time series.

3.1 Generating HRU Maps

As defined by Flügel (1997), the HRUs are “distributed, heterogeneously structured model entities comprising common land use and pedo-topo-geological associates generating and controlling their homogeneous hydrological dynamics.” In other words, each HRU is a subunit that has uniform characteristics of land use, soil, and slope, and subsequently exhibits similar hydrologic responses. HRUs are developed so that the variation of hydrological dynamics within each HRU is small compared to the hydrologic characteristics of a neighboring HRU. Collectively, HRUs retain and represent the complex and distributed basin hydrology (Bongartz 2003).

Impervious surfaces serve as the major source of runoff volume and consequently phosphorus load. For Bellingham, Franklin, and Milford, local knowledge and visual checking of the imperviousness to the contour map suggest that most of the impervious surfaces are in relatively flat areas. Under such conditions, the inclusion of slope in the HRU development would significantly increase the analysis effort with limited improvement in accuracy. Thus, slope was not used as a factor in the HRU development for the three Upper Charles River communities, and the HRU development was based on the land use conditions and the soils data.

An overlay of the land use map to the imperviousness map can help identify the impervious and pervious surfaces in the developed land uses. For example, for an area with commercial land use, the imperviousness map (Figure 2-1) has the information of buildings, parking lots, and roadways in that area. When that area is overlaid with the land use map (Figure 2-2), areas that are outside the impervious cover delineations are pervious surfaces (*Commercial_Pervious*). Using GIS tools, such analysis can be carried out efficiently in a batch fashion, and the pervious and impervious surfaces can be identified for all the developed land uses.

For the three Upper Charles River communities, the overlay of land use data, imperviousness information, and soils data generated a total of 44 HRU groups. A complete list of the 44 HRUs is summarized in Table 3-1. As shown, the developed HRUs contain information of land use, imperviousness, and the hydrologic soils group (HSG). The developed HRU maps for the three communities are included in Appendix A.

Table 3-1. Summary of HRU groups to be generated for the three Upper Charles River communities

Land use	Imperviousness	HSG	HRU group
Agriculture	Pervious	A	Agriculture_Perv_A
		B	Agriculture_Perv_B
		C	Agriculture_Perv_C
		D	Agriculture_Perv_D
Commercial	Impervious	--	Commercial_Imp
	Pervious	A	Commercial_Perv_A
		B	Commercial_Perv_B
		C	Commercial_Perv_C
		D	Commercial_Perv_D
Forest	Impervious	--	Forest_Imp.
	Pervious	A	Forest_Perv_A
		B	Forest_Perv_B
		C	Forest_Perv_C
		D	Forest_Perv_D
Freeway	Impervious	--	Freeway_Imp
	Pervious	A	Freeway_Perv_A
		B	Freeway_Perv_B
		C	Freeway_Perv_C
		D	Freeway_Perv_D
High-density residential	Impervious	--	HDR_Imp
	Pervious	A	HDR_Perv_A
		B	HDR_Perv_B
		C	HDR_Perv_C
		D	HDR_Perv_D
Industrial	Impervious	--	Industrial_Imp
	Pervious	A	Industrial_Perv_A
		B	Industrial_Perv_B
		C	Industrial_Perv_C
		D	Industrial_Perv_D
Low-density residential	Impervious	--	LDR_Imp
	Pervious	A	LDR_Perv_A
		B	LDR_Perv_B
		C	LDR_Perv_C
		D	LDR_Perv_D
Medium-density residential	Impervious	--	MDR_Imp
	Pervious	A	MDR_Perv_A
		B	MDR_Perv_B
		C	MDR_Perv_C
		D	MDR_Perv_D
Open space	Impervious	--	OpenSpace_Imperv
	Pervious	A	OpenSpace_Perv_A
		B	OpenSpace_Perv_B
		C	OpenSpace_Perv_C
		D	OpenSpace_Perv_D

Note: LDR = low-density residential; MDR = medium-density residential; HDR = high-density residential

3.2 Estimating HRU Loading Rates

Phosphorus loading rates for the land use groups are summarized in Table 3-2. For the pervious surfaces in both the developed and undeveloped land uses, the four HSG categories are assumed to have the same phosphorus loading rate.

Table 3-2. Phosphorus load export rates for Bellingham, Franklin, and Milford

Land use	TP load export rate (kg/ha/yr)	Land surface cover	P load (kg/ha/yr)	Source of export rate
Agriculture *	0.5	Pervious	0.5	1
Commercial **	1.679	Impervious	2.5	2
		Pervious	0.3	
Forest	0.13	Impervious	1	3
		Pervious	0.1	
Freeway	0.9	Impervious	1.5	2
		Pervious	0.3	
High-density residential	1.119	Impervious	2.5	2
		Pervious	0.3	
Industrial	1.455	Impervious	2	2
		Pervious	0.3	
Low-density residential (rural)	0.30	Impervious	1	3
		Pervious	0.15	
Medium-density residential	0.560	Impervious	1.5	2
		Pervious	0.3	
Open space	0.30	Impervious	1	3
		Pervious	0.25	

Sources: (1) Budd and Meals 1994; (2) Shaver et al. 2007; (3) Mattson and Isaac 1999

Notes:

* Agriculture includes row crops, actively managed hay fields and pasture land.

** Institutional type land uses such as government properties, hospitals, and schools are included in the commercial land use category for the purpose of calculating phosphorus loadings.

3.3 Generating HRU Time Series

After the HRUs were defined and developed, each HRU was represented in EPA's SWMM (Version 5.0) as a unit parcel (1 acre). The SWMM representation was then calibrated to the annual average phosphorus loading rates shown in Table 3-2. Ten-year rainfall data (01/01/1992–12/31/2001) from the nearby Boston International Airport (MA0770) were used for the SWMM simulations, and the calibration focused on the buildup and washoff parameters in the SWMM water quality processes. On the basis of previously validated SWMM buildup and washoff coefficients (Behera et al. 2006), the HRU water quality parameters were adjusted until the annual average phosphorus loadings were close to those presented in Table 3-2. For each HRU, the hourly output of both flow rate and phosphorus loadings from the calibrated 10-year SWMM then became the runoff time series.

4 Developing Management Categories

Assessments of overall BMP effectiveness in a community require routing HRU runoff to BMPs, of which the applicability and types are decided by various site conditions. For a community-wide analysis, the representation and routing of BMPs in each parcel would be too detailed and time-consuming and far beyond the resources available for this project. Thus, the concept of management categories was used to aggregate the areas that share the same site conditions and that are suitable for implementing the same type of BMPs. This section of the report presents the development of management categories in the three Upper Charles River communities.

4.1 Design Requirements for BMPs

Categorizing management categories needs to strike the balance between BMP design specifications and site conditions on the ground. A parcel could become an application site for a certain BMP only when the site conditions meet the design requirements for that BMP. In the following sections, the site condition requirements for each BMP are introduced with a description of how the requirements are used to screen each parcel for potential BMP implementation. All the BMP site condition requirements below are from the *Massachusetts Stormwater Handbook* (MassDEP 2008).

4.1.1 Porous Pavement

For a potential porous pavement implementation site, the natural soil must have an infiltration rate of 0.17 inch/hour (in/hr) or higher, with a void space higher than 40 percent. The site cannot be a high-speed traffic area. Appropriate vacuuming practices need to be planned because of concerns of clogging. Slope for the site needs to be gentle (< 5 percent). For a typical design of porous pavement with 4-foot (ft) depth of porous layers, the bedrock depth must be 6 ft or deeper, and the seasonal high water table needs to be 7 ft or deeper below the surface. Finally, the porous pavement site must be at least 50 ft away from septic systems, 100 ft from private wells, 100 ft from surface water, and outside Zone 1 from public wells and Zone A of public reservoirs.

4.1.2 Infiltration System

A candidate infiltration system site will have a seasonal high water table of 8 ft or deeper below the surface, given that a typical infiltration system has 6 ft of excavation (BMP bottom is 2 ft above groundwater). An infiltration system is not suitable for areas with steep slopes.

4.1.3 Bioretention Area

As a source control BMP, a bioretention area should not be designed to treat large drainage areas. The bioretention area is not recommended for areas with steep slope and should not be implemented on areas with slope > 20 percent. Soil media for the bioretention area should be between 2 and 4 ft deep.

4.1.4 Gravel Wetland

The typical excavation depth for a gravel wetland is 6 ft. When the gravel wetland is not lined at the bottom, the site seasonal high groundwater table needs to be 8 ft or deeper

below the surface to maintain the 2-ft distance. A gravel wetland is not suitable for areas with steep slopes.

4.1.5 Water Quality Swales (Wet)

Water quality wet swales are suitable for areas with poor drainage and high seasonal groundwater table. To maintain the conveyance and treatment of runoff at the same time, the longitudinal slope of the swale should be as close to zero as possible and not more than 5 percent. The water quality wet swale is not suitable for residential application because of mosquitoes' attraction to standing water.

4.1.6 Wet Pond

A wet pond is used more often as a regional practice, treating drainage areas from 20 acres up to 1 square mile. For maintaining the permanent pool of water, wet ponds are not recommended for sites with good permeability (HSG of A and B) because additional lining might be necessary. The maximum depth of permanent pool of water in a wet pond is 8 ft. A wet pond is suitable for residential, commercial, and industrial sites but must not be implemented in wetland resources other than isolated land subject to flooding, bordering land subject to flooding, land subject to coastal storm flowage, and riverfront areas.

4.1.7 Dry Pond

Dry ponds are used as a regional practice, and the drainage area is often larger than 10 acres. Because of the space required in treating large volume of runoff, a dry pond is not suitable for areas where land cost is high and space is limited. Dry ponds are not suitable for sites with relatively impermeable soils (D) because of concerns regarding standing water. Also they are not suitable for well-drained sandy/gravelly soils (A) because of the difficulty of establishing shallow marsh. The site's seasonal high groundwater table needs to be at least 2 ft from the bottom of the pond to avoid standing water. A dry pond is not suitable for sites with steep slopes. While recommended for residential, commercial, and industrial sites, dry ponds are not suitable for low-density residential (LDR) sites when applied alone.

In general, site conditions that determine the applicable BMP types are seasonal high ground water table, the HSG, impervious surface area (contributing area), slope, depth to bedrock, and the parcel land use. The combination of those site conditions are used as a screening tool to identify the potential BMPs that can be applied to a parcel. The site restrictions for the BMPs are summarized in Table 4-1.

Table 4-1. Site restrictions for potential BMPs

BMP	Depth to water table (ft)	Depth to bedrock (ft)	Slope	Other requirements
Porous pavement	> 7	> 6	< 5%	Infiltration rate > 0.17 in/hr; porosity > 40%
Infiltration system	> 8	--	< 15%	--
Bioretention area	> 6	--	< 15%	--
Gravel wetland	> 8	--	--	--
Water quality swale (wet)	--	--	< 5%	C and D soils; not applicable to residential
Wet pond	> 8	--	--	C and D soils; drainage area 20 acres~1 mile ²
Dry pond	> 8	--	< 15%	B and C soils; drainage area >10 acres; not applicable to low-density residential

Source: MassDEP 2008

4.2 Developing Management Categories

As discussed previously, common site conditions that influence BMP selections include depth to bedrock, depth to water table, slope, soils, land use, and imperviousness. A union of those six layers results in polygons that can be used for management category assignments. When determining the management category for a polygon, the infiltration BMPs always have the highest preference because infiltration practices are known to have the highest phosphorus-removal efficiencies among stormwater BMPs. Additionally, infiltration practices provide several other benefits including groundwater and stream baseflow recharge, as well as the removal of other stormwater pollutants such as bacteria.

The management category classifications resulting from various site conditions are summarized in Table 4-2. As shown, the HSG information is also integrated into the management categories to determine whether infiltration practices are suitable for the various site conditions. The HSG information can help account for differences in phosphorus removal by infiltration practices as a result of different soil infiltration rates (e.g., HSG A soils have higher infiltration rates than HSG B soils; thus, an infiltration system in HSG A soils will achieve greater phosphorus removal than an equally sized system in HSG B soils).

Table 4-2. Categorizing management categories on the basis of site conditions

Condition	Depth to water table (ft)	Depth to bedrock (ft)	Slope	HSG	Land use	Management category		
1	> 6.6	< 2.5	<= 5	C or D	Non-Res.	WQ swale/wetland		
2			<= 15	A/B/C/D	--	Shallow filtration-A/B/C/D		
3			> 15	-	--	Less likely for onsite BMP		
4		2.5 ~ 6.6	<= 15	<= 5	C or D	Non-Res.	WQ swale/wetland	
5				A/B/C	--	Biofiltration/infiltration-A/B/C		
6				D	--	Biofiltration-D		
7				> 15	--	--	Less likely for onsite BMP	
8		> 6.6	<= 15	A	--	--	Infiltration-high-A	
9							B	Infiltration-high-B
10							C	Infiltration-likely
11							D	Biofiltration
12				> 15	--	--	Less likely for onsite BMP	
13	2.5 ~ 6.6	< 2.5	<= 5	C or D	Non-Res.	WQ swale/wetland		
14			<= 15	A/B/C/D	--	Shallow filtration-A/B/C/D		
15			> 15	--	--	Less likely for onsite BMP		
16		2.5 ~ 6.6	<= 15	<= 5	C or D	Non-Res.	WQ swale/wetland	
17				A/B/C	-	Biofiltration/infiltration-A/B/C		
18				D	--	Biofiltration-D		
19				> 15	--	--	Less likely for onsite BMP	
20		> 6.6	<= 15	<= 5	C or D	Non-Res.	WQ swale/wetland	
21				A/B/C	--	Biofiltration/infiltration-A/B/C		
22				D	--	Biofiltration-D		
23				> 15	--	-	Less likely for onsite BMP	
24		< 2.5	--	<= 5	C or D	Non-Res.	WQ swale/wetland	
25	<= 15			A/B/C/D	--	Shallow filtration-A/B/C/D		
26	> 15			--	--	Less likely for onsite BMP		
For impervious surfaces								
27	> 6.6	> 6	<= 5	A or B or C	Non-Res; Non-PROW	Impervious; possible porous pavement		
28	All else					Less likely for onsite BMP		

The union of data layers for depth to bedrock, depth to water table, slope, soils, land use, and imperviousness is used to develop a composite map that identifies polygons that are assigned to one of the management categories. The management category maps for the three communities are included in Appendix B.

5 Optimizing BMP Implementation Alternatives

With the classification of HRUs and BMP types (management categories) in a community, the runoff from HRUs can be routed to respective BMPs for setting up the phosphorus reduction optimization framework in BMPDSS. The optimization framework needs to be developed to accommodate different HRU to BMP routing scenarios. This chapter presents the set up and optimization of three such routing scenarios using BMPDSS.

In the discussions below, a *Scenario* refers to the overall routing scheme for an optimization setup. For example, in Scenario I, the runoff from impervious surfaces in a parcel is routed to the applicable BMP identified in that parcel. Meanwhile, in each routing scenario, there could be many BMP *implementation alternatives*, each of which refers to a combination of BMPs with particular sizes in a community. For each routing scenario, the goal of the optimization process is to identify the most cost-effective BMP implementation alternative to meet a certain phosphorus reduction target.

5.1 Tabulating HRUs into Management Categories

Setting up a BMP optimization framework requires the quantification of surface runoff and pollutant load that will drain to each BMP (management category). That requires overlaying the HRU layer onto the management category layer and tabulating HRUs to each of the management categories. For onsite treatments, it was assumed that the runoff from the impervious HRUs within a parcel is treated by the dominant management category (i.e., the management category with the greatest area) within that parcel. Thus, the first step in the tabulation was to identify the dominant management category within a parcel. The HRUs were then tabulated to the parcel layer and the dominant management category. The tabulation yields the area of HRUs draining to various management categories. The tabulation process is illustrated along with the BMP setup Scenario I later in Figure 5-1 (on page 26).

One additional refinement to the above described process was carried out for those parcels where the dominant management category for a parcel was *Less likely for onsite BMPs* (no. 28 in Table 4-2). Unless the parcel had 100 percent coverage for *Less likely for onsite BMPs*, the next dominant management category (i.e., the management category with the second greatest amount of area within the parcel) was assigned to the parcel. The rationale for selecting the next dominant management category in these cases was that a smaller portion of the parcel that was suitable for a BMP could be sufficient to treat runoff from most of the parcel area. For example, for a parcel that had 80 percent of *Less likely for onsite BMPs*, 15 percent of *Infiltration high*, and 5 percent of *Biofiltration*, the management category assigned to the parcel would be *infiltration high*. This refinement was consistent with the objective of the project, which was to identify the overall treatment needed for various source areas (regardless of the available space constraints in certain scenario setups).

5.2 BMP Setup without Optimization

Before optimizing BMP implementation alternatives, it is necessary to carry out an investigation of BMP sizing schemes without optimization. That helps establish a benchmark for later assessment of total costs and treatment that BMPs can provide at various sizing levels.

During the investigation, the minimum BMP areas (i.e., dimensions of the BMPs) were set to be 5 percent of the contributing impervious HRU areas. That was consistent with the results from the previously developed BMP performance curves (Tetra Tech 2008), which demonstrated that a BMP in general treats one inch of the impervious runoff when the BMP was sized to be 5 percent of the contributing impervious area. Capturing and treating a one-inch depth of runoff provides a high level of phosphorus control for several BMPs and is the required level for water quality treatment in many state stormwater regulations. For the benchmark scenario, the sizes of the BMPs were increased incrementally up to 100 percent of the impervious area. In other words, the maximum physical dimensions of the BMPs were set equal in area to the specified percentage of impervious area. A summary of the phosphorus removal percentages as a result of varying BMP sizing schemes in the three communities is shown in Tables 5-1 through 5-3.

Table 5-1. Summary of phosphorus removal for various BMP sizing schemes in Bellingham

Scheme	Annual TP load (lbs)	Reduction (%)	Total cost (\$)
No BMP	1,988	--	--
BMP = 5% of Impv.	919	54%	\$22 million
BMP = 10% of Impv.	770	61%	\$44 million
BMP = 15% of Impv.	690	65%	\$65 million
BMP = 20% of Impv.	642	68%	\$87 million
BMP = 50% of Impv.	562	71%	\$218 million
BMP = 100% of Impv.	553	72%	\$436 million

Table 5-2. Summary of phosphorus removal for various BMP sizing schemes in Franklin

Scheme	Annual TP load (lbs)	Reduction (%)	Total cost (\$)
No BMP	5,355	--	--
BMP = 5% of Impv.	2,456	54%	\$71 million
BMP = 10% of Impv.	2,204	59%	\$141 million
BMP = 15% of Impv.	2,076	61%	\$212 million
BMP = 20% of Impv.	1,995	63%	\$283 million
BMP = 50% of Impv.	1,853	65%	\$706 million
BMP = 100% of Impv.	1,837	66%	\$1,413 million

Table 5-3. Summary of phosphorus removal for various BMP sizing schemes in Milford

Scheme	Annual TP load (lbs)	Reduction (%)	Total cost (\$)
No BMP	3,870	--	--
BMP = 5% of Impv.	1,858	52%	\$30 million
BMP = 10% of Impv.	1,625	58%	\$60 million
BMP = 15% of Impv.	1,432	63%	\$90 million
BMP = 20% of Impv.	1,238	68%	\$120 million
BMP = 50% of Impv.	1,045	73%	\$301 million
BMP = 100% of Impv.	1,006	74%	\$602 million

5.3 The Optimization Problem

When setting up the BMPDSS optimization framework for a community, the optimization target was to identify the near-optimal BMP implementation alternative that has the lowest cost while meeting the TMDL phosphorus reduction target. In each BMP implementation alternative, the BMP types were determined by the management categories, and the decision variable (parameter to be optimized) was the size of each BMP. Because the cross sections of the BMPs were fixed (Chapter 2), the decision variables were the surface areas of the BMPs.

Mathematically, the optimization problem in the community of Milford can be stated as

Objective

$$Min: \sum_{i=1}^N A_i \times C_i \quad (5.1)$$

Subject to

$$TP_r \geq TP_{target} \quad (5.2)$$

where N is the total number of BMP locations (HRU-BMP combinations), A_i is the size of BMP at location i and is the decision variable, C_i is the unit cost of BMP at location i and is a constant, TP_r is the phosphorus reduction in percentage from the BMP implementation, and TP_{target} is the TMDL target for phosphorus reduction percentage.

Theoretically, the optimization process can search through an infinite number of BMP sizing possibilities and identify the best implementation alternative, and that can be a very time-consuming process. To make the search process efficient and computationally affordable, the decision space (range of BMP surface areas) must be reduced to a manageable level. One approach to reduce the decision space is to enforce a smaller upper threshold for each decision variable (BMP surface area).

5.3.1 Refined Optimization Setup

As indicated in Tables 5-1, when the BMPs were sized to be 5 percent of the impervious area in the community of Bellingham, the phosphorus removal was 54 percent, while the

TMDL target for the community was 52 percent. Similarly, when the BMPs were sized to be 5 percent of the impervious area in Franklin and 10 percent in Milford, the resulting phosphorus reductions were 54 percent and 58 percent, respectively. Meanwhile, the TMDL targets of phosphorus reduction in the two communities were 52 percent and 57 percent, respectively. On the basis of those observations, the upper threshold of BMP sizes were set to be 15 percent of the contributing impervious area, allowing some room for flexibility during the optimization process. Each BMP was assigned with 20 size steps for the optimization.

With 15 percent of the contributing impervious surface area being set as the upper limit of BMP at each location, the initial optimization problem was refined. In the refined optimization setup, the problem definition became

Objective

$$\text{Min: } \sum_{i=1}^N A_i \times C_i \quad (5.3)$$

Subject to

$$TP_r \geq TP_{target} \quad (5.4)$$

$$A_i \leq Impv_i \times 0.15 \quad \text{for any } i \quad (5.5)$$

where N , A_i , C_i , TP_r , and TP_{target} are as previously noted, and $Impv_i$ is the area of impervious HRU that drains to the BMP at location i .

The problem stated in Equations 5.3 through 5.5 is a multi-objective optimization problem because the optimizer must search for solutions satisfying the non-combinatorial objectives of cost and phosphorus reduction simultaneously. Final solutions to such multi-objective problems are *nondominated*, which means that there are no other solutions that can be better than the final solutions on all objectives. The final solutions themselves, in the meantime, have tradeoffs from one another for the objectives being optimized, which means the gain in one dimension is associated with the loss in another (i.e., increase in phosphorus removal is associated with higher total cost, and vice versa). The final solutions in the optimization problem form a tradeoff (*Pareto*) front, the solutions behind which are dominated by the final solutions.

5.4 BMP Optimization Scenario I

In the Scenario I setup, runoff from impervious HRUs in a parcel was routed to the BMP (management category) in that parcel, and the overflow from all BMPs were combined at the community outlet. Runoff from the pervious HRUs was not treated and was directly routed to the community outlet.

5.4.1 Scenario I Setup

The overall schematic for BMPDSS Scenario I setup is shown in Figure 5-1, along with the tabulation of HRUs into management categories. As shown, in the tabulation process, the areas of the impervious HRUs were first identified, and the impervious HRUs were

then linked to respective BMPs (management categories). The HRU-BMP combinations were then aggregated for the whole community. In setting up Scenario I, the impervious HRU time series were routed to the corresponding BMPs, the outflow from which was routed to a community-wide virtual outlet. For impervious HRUs that drain to the management category of *Less likely for onsite BMP*, no BMP is implemented, and the runoff was directly routed to the virtual outlet. Runoff from all pervious HRUs was directly routed to the virtual outlet as well. The target of the BMPDSS model was to meet the phosphorus reduction as required by the Upper Charles River TMDL for each community while minimizing the total cost.

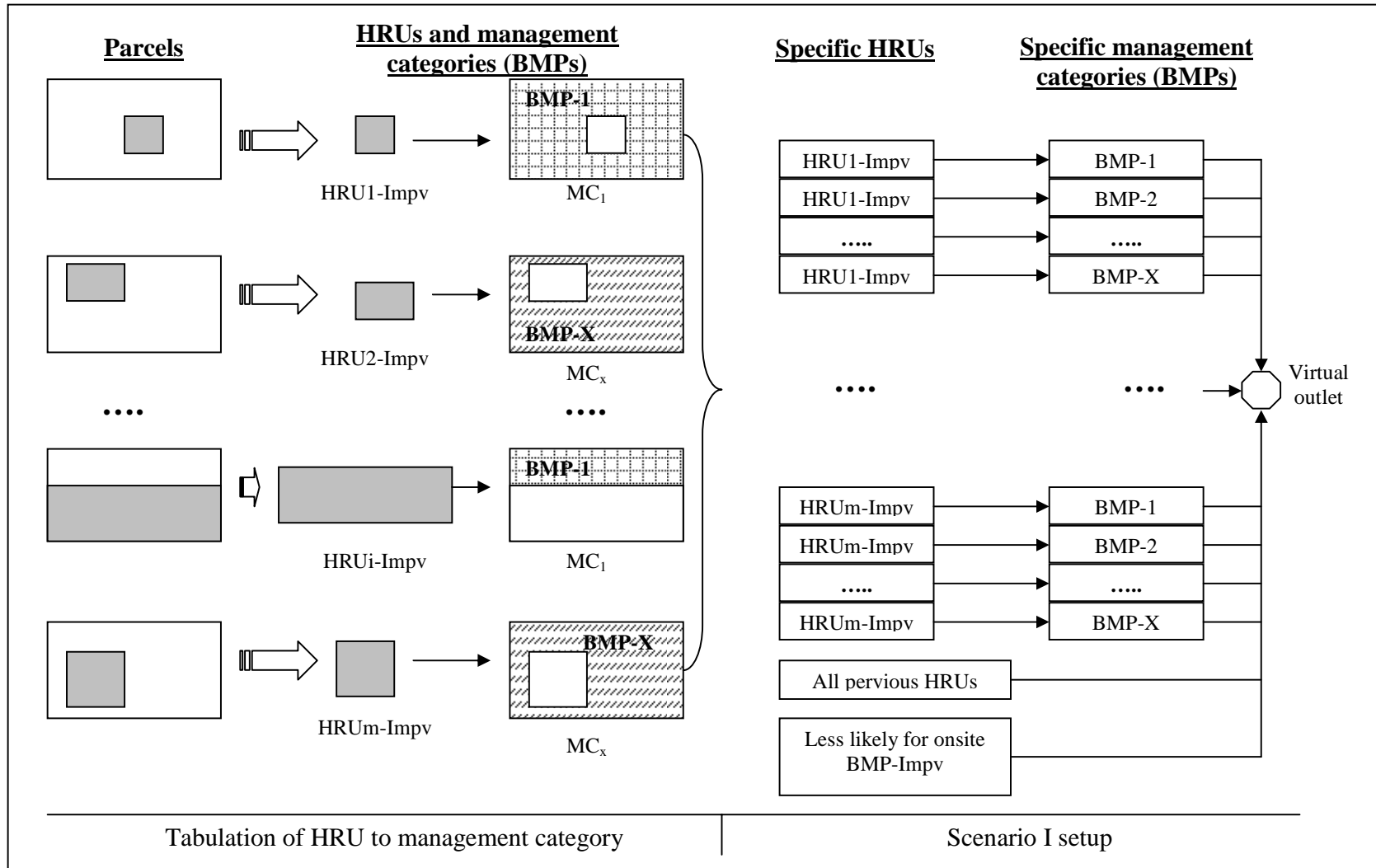

Figure 5-1. Routing of HRU to management category and Scenario I setup in the Upper Charles River communities.

The tabulation results of impervious HRUs into management categories are summarized in Tables 5-4 through 5-6. As shown, each community has eight categories of impervious HRUs, draining to 15 possible categories of BMPs. Thus, the BMP site layout in one community consists of 120 BMP-HRU combinations. Additionally, 36 pervious HRUs directly drain to the outlet of the conceptual watershed and receive no treatment.

Table 5-4. Tabulation of impervious HRUs into management categories in Bellingham for Scenario I setup (Unit: acres)

BMP	Commercial	High-density residential	Industrial	Medium-density residential	Freeway	Low-density residential	Open space	Forest
Infiltration high-A	43.23	32.82	90.36	30.08	1.46	24.51	41.84	13.96
Infiltration high-B	7.26	16.61	10.33	14.86	48.41	10.86	14.17	7.83
Infiltration likely	2.33	2.02	6.94	1.16	0.00	2.18	0.00	0.67
Biofiltration	4.39	0.59	4.77	0.45	0.00	0.68	0.00	0.34
Biofiltration/infiltration-A	0.00	0.00	0.00	0.00	0.00	0.00	0.00	0.00
Biofiltration/infiltration-B	0.00	0.00	0.00	0.00	0.00	0.00	0.00	0.00
Biofiltration/infiltration-C	0.00	0.00	0.00	0.00	0.00	0.00	0.00	0.00
Biofiltration-D	0.00	0.00	0.00	0.00	0.00	0.00	0.00	0.00
Shallow filtration-A	0.00	0.00	0.00	0.00	0.00	0.00	0.00	0.00
Shallow filtration-B	0.00	0.78	0.00	0.95	0.00	0.05	0.00	0.01
Shallow filtration-C	20.76	42.35	32.31	56.36	0.37	26.75	1.23	38.03
Shallow filtration-D	29.36	1.27	18.19	4.17	0.00	2.75	28.76	3.81
Impervious, possible PP	44.88	10.93	35.59	4.27	0.07	14.23	1.54	12.61
WQ swale, wetland	12.59	14.23	0.86	1.03	0.00	4.03	0.07	4.13
Less likely for onsite BMP	1.76	0.37	0.22	3.06	6.60	1.16	0.00	0.78
Total	166.56	121.98	199.58	116.38	56.92	87.22	87.60	82.15

Table 5-5. Tabulation of impervious HRUs into management categories in Franklin for Scenario I setup (Unit: acres)

BMP	Commercial	High-density residential	Industrial	Medium-density residential	Freeway	Low-density residential	Open space	Forest
Infiltration high-A	103.87	28.41	82.75	416.91	22.52	164.83	9.34	71.42
Infiltration high-B	54.58	24.93	45.44	145.24	87.82	64.54	4.89	41.52
Infiltration likely	1.15	0.36	6.38	8.50	5.63	4.93	0.98	5.97
Biofiltration	39.10	4.55	11.68	2.88	1.26	3.57	0.17	2.03
Biofiltration/infiltration-A	0.00	0.00	0.00	0.00	0.00	0.00	0.00	0.00
Biofiltration/infiltration-B	0.00	0.00	0.00	0.00	0.00	0.00	0.00	0.00
Biofiltration/infiltration-C	0.00	0.00	0.00	0.00	0.00	0.00	0.00	0.00
Biofiltration-D	0.00	0.00	0.00	0.00	0.00	0.00	0.00	0.00
Shallow filtration-A	0.00	0.00	0.00	0.00	0.00	0.00	0.00	0.00
Shallow filtration-B	3.98	0.00	1.86	8.04	0.00	4.72	0.63	0.27
Shallow filtration-C	11.85	29.00	156.13	152.32	16.22	84.32	4.09	80.21
Shallow filtration-D	10.94	12.20	16.46	22.07	0.00	13.98	3.41	5.31
Impervious, possible PP	39.65	0.00	49.26	0.43	4.65	0.81	0.86	4.11
WQ swale, wetland	10.82	1.35	65.25	13.46	0.02	9.31	0.29	5.92
Less likely for onsite BMP	3.34	1.21	2.57	13.40	15.11	9.34	0.16	6.08
Total	279.28	102.00	437.77	783.27	153.24	360.36	24.81	222.84

Table 5-6. Tabulation of impervious HRUs into management categories in Milford for Scenario I setup (Unit: acres)

BMP	Commercial	High-density residential	Industrial	Medium-density residential	Freeway	Low-density residential	Open space	Forest
Infiltration high-A	31.77	16.41	6.49	37.47	6.38	9.22	0.00	14.29
Infiltration high-B	5.02	4.48	2.67	19.39	0.00	30.43	4.38	8.81
Infiltration likely	0.00	0.00	0.00	0.00	0.00	0.00	0.00	0.00
Biofiltration	13.55	1.62	9.03	0.77	13.41	5.80	0.67	0.54
Biofiltration/infiltration-A	0.00	0.00	0.00	0.00	0.00	0.00	0.00	0.00
Biofiltration/infiltration-B	83.25	6.15	96.36	39.45	30.88	27.50	2.88	36.65
Biofiltration/infiltration-C	0.00	0.00	0.00	0.00	0.00	0.00	0.00	0.00
Biofiltration-D	0.00	0.00	0.00	0.00	0.00	0.00	0.00	0.00
Shallow filtration-A	0.00	0.00	0.00	0.00	0.00	0.00	0.00	0.00
Shallow filtration-B	0.71	0.00	2.23	0.48	0.00	1.59	1.13	0.75
Shallow filtration-C	33.07	115.70	27.71	221.68	0.52	34.45	0.80	14.92
Shallow filtration-D	14.45	3.64	0.93	12.91	2.15	12.39	0.00	7.47
Impervious, possible PP	89.10	0.12	49.10	0.40	1.56	0.17	0.03	1.14
WQ swale, wetland	96.06	65.58	19.47	129.68	2.03	27.17	2.32	34.14
Less likely for onsite BMP	16.99	2.46	2.74	10.64	24.32	5.58	1.86	3.66
Total	383.97	216.16	216.72	472.86	81.26	154.31	14.08	122.37

5.4.2 Scenario I Results

The tabulated HRU sizes in Tables 5-4 to 5-6 were represented in BMPDSS to set up the optimization framework. At the end of the optimization process, all BMP implementation scenarios evaluated by BMPDSS were plotted. The BMP implementation scenario that had the lowest cost and met the TP load reduction target at the same time was selected as the near-optimal solution for each community, which is illustrated in Figures 5-2 to 5-4.

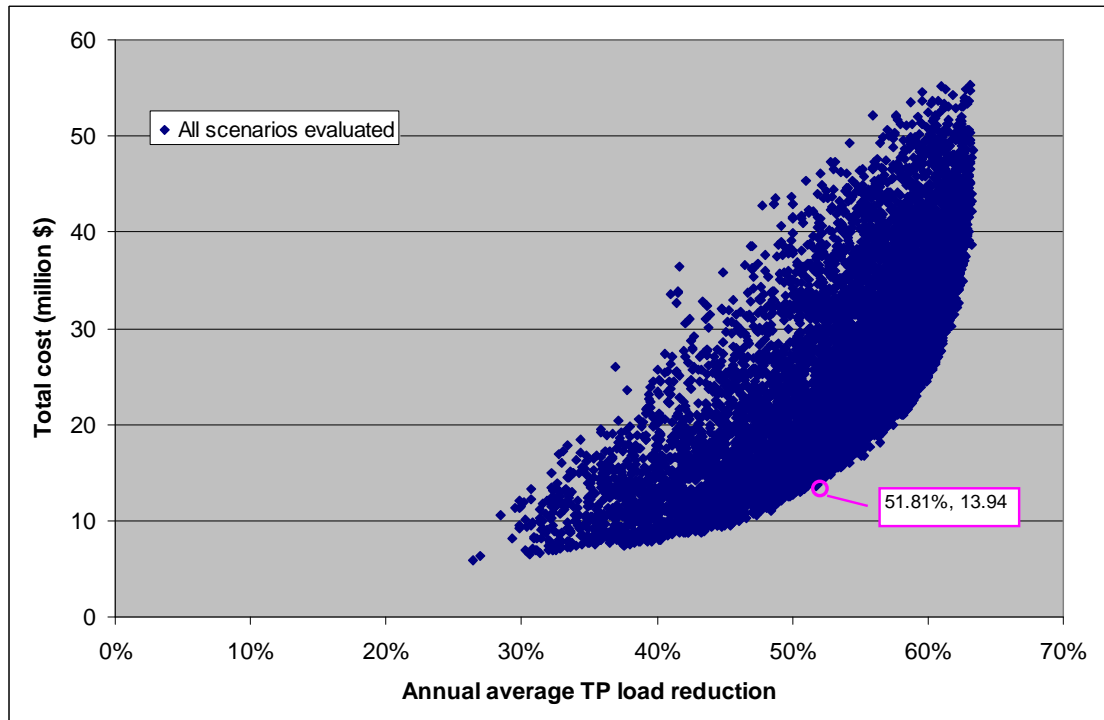

Figure 5-2. BMPDSS optimization results for Scenario I setup in Bellingham.

As shown in Figure 5-2, the identified near-optimal solution meets the Bellingham TMDL reduction target of 52 percent, and the total cost of the BMP implementation alternative is around \$14 million. When compared to the benchmark scenarios (no optimization) listed in Table 5-1, the advantage of using the optimization technique is clearly demonstrated. For example, when a uniform 5 percent sizing ratio of the BMP area to the contributing impervious area was used, the benchmark scenario results in a phosphorus reduction of 54 percent. But the total cost is \$22 million. When optimization is employed through BMPDSS, a BMP solution that still meets the TMDL target but costs \$14 million (or 36 percent less) can be identified.

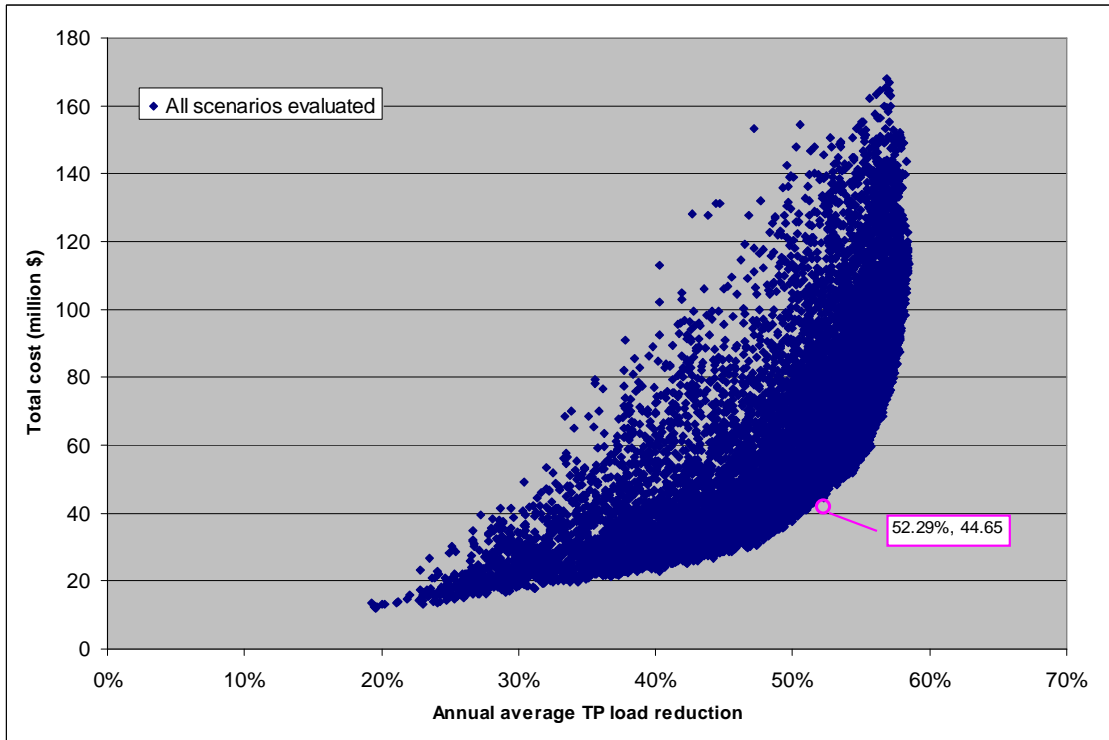

Figure 5-3. BMPDSS optimization results for Scenario I setup in Franklin.

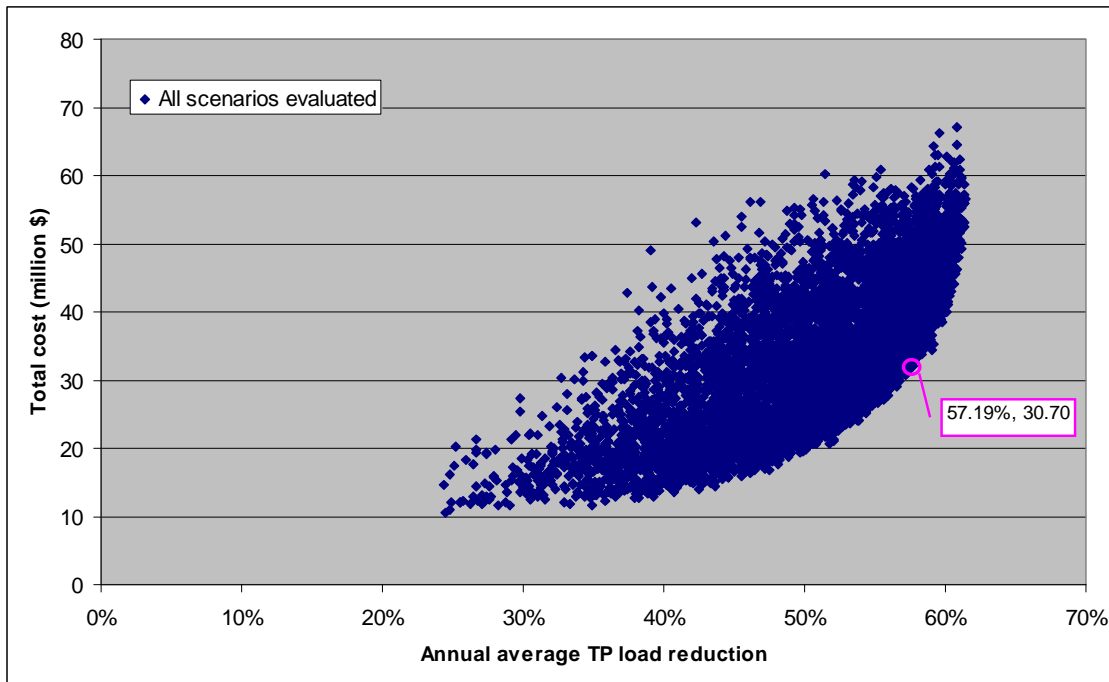

Figure 5-4. BMPDSS optimization results for Scenario I setup in Milford.

Figures 5-3 and 5-4 show a similar trend in Franklin and Milford as is observed in Bellingham. That is, when compared to the uniform BMP sizing schemes in Tables 5-2 and 5-3, the near-optimal solutions identified through the optimization process in the two communities show significant total cost reductions while still meeting the TMDL target. For example, in Franklin, a uniform BMP sizing of 5 percent of the impervious area costs \$71 million (with the TP reduction of 54 percent), and the near-optimal solution identified by BMPDSS costs about \$45 million (or 37 percent less). As for Milford, a uniform BMP sizing of 10 percent of the impervious area costs \$60 million (with the TP reduction of 58 percent), and the near-optimal solution identified by BMPDSS costs about \$31 million (or 48 percent less). A summary of the optimization results for the three communities regarding the unit cost of control is shown in Table 5-7.

Table 5-7. Summary of optimal solutions identified for Scenario I in the three communities

Community	Total impv. area (acres)	Percent reduction goal	Total cost (million \$)	Cost per acre	Cost per lb of TP removal
Bellingham	918	52%	\$14	\$15,200	\$13,300
Franklin	2,364	52%	\$45	\$18,900	\$15,900
Milford	1,662	57%	\$31	\$18,500	\$13,900

While the optimization results and the related analysis above are presented in the terms of total costs, it needs to be noted that the costs are more intended to illustrate the relative changes from the uniform sizing strategy, and the values should not be taken literally. The costs are a reflection of BMP sizes, which are the decision variables during the optimization process. The treatment mechanism or the subsequent sizing of BMPs is the basis of any cost estimations. Functions for estimating BMP unit costs can vary, but the sizing of BMPs ultimately decides the final total cost values for a BMP implementation alternative. The corresponding sizes of BMPs for the optimal solutions identified in the three communities for Scenario I are introduced in the next section.

5.4.3 Required Level of Treatment for Scenario I

Using the near-optimal BMP sizing alternative identified through the optimization process, the level of treatment needed for each HRU can be back-calculated. The level of treatment (total area of BMP and depth of runoff to be treated for each source area) required in each community is summarized in Tables 5-8 to 5-10, and the corresponding percentages of reduction for TP are also included alongside the calculated depths. The percentages of reductions were retrieved from previous BMP performance curve project (Tetra Tech 2008). No percentage of reduction calculations was made to the forest, freeway, and open space source areas because of the lack of performance curves.

Table 5-8. The level of treatment needed in Bellingham for Scenario I

BMP	Commercial		High-density residential		Industrial		Medium-density residential		Low-density residential		Forest		Open space		Freeway	
	BMP area (ac)	Depth of runoff treated (in)	BMP area (ac)	Depth of runoff treated (in)	BMP area (ac)	Depth of runoff treated (in)	BMP area (ac)	Depth of runoff treated (in)	BMP area (ac)	Depth of runoff treated (in)	BMP area (ac)	Depth of runoff treated (in)	BMP area (ac)	Depth of runoff treated (in)	BMP area (ac)	Depth of runoff treated (in)
Infiltration high-A	1.30	1.21 (99%)	0.98	1.21 (99%)	1.36	0.60 (92%)	0.45	0.60 (90%)	0.74	1.21 (98%)	0.42	1.21	0.63	0.60	0.02	0.60
Infiltration high-B	0.22	1.21 (97%)	0.25	0.60 (86%)	0.15	0.60 (86%)	0.22	0.60 (85%)	0.16	0.60 (84%)	0.12	0.60	0.43	1.21	0.73	0.60
Infiltration likely	0.07	1.20 (96%)	0.03	0.60 (82%)	0.21	1.21 (96%)	0.03	1.21 (95%)	0.03	0.60 (80%)	0.03	1.20	0.00	0.00	0.00	0.00
Biofiltration [§]	0.20	1.20 (79%-92%)	0.04	1.20 (79%-92%)	0.14	1.21 (79%-93%)	0.00	0.00	0.08	1.20 (76%-90%)	0.02	1.20	0.00	0.00	0.00	0.00
Shallow filtration-C	0.93	0.74 (69%)	3.81	1.48 (84%)	1.45	0.74 (69%)	1.69	0.49 (58%)	0.00	0.00	1.71	0.74	0.09	1.21	0.00	0.00
Shallow filtration-D	0.88	0.49 (58%)	0.11	1.20 (79%)	0.82	0.74 (69%)	0.13	0.49 (58%)	0.08	0.49 (56%)	0.11	0.49	0.00	0.00	0.00	0.00
Impervious, possible PP	1.35	0.40 (74%)	0.16	0.20 (74%)	2.67	1.00 (75%)	0.00	0.00	0.43	0.40 (71%)	0.57	0.60	0.02	0.20	0.00	0.00
WQ swale, wetland ^{&}	1.13	4.32	1.49	5.04	0.08	4.31	0.05	2.17	0.60	5.60	0.50	5.76	0.00	0.00	0.00	0.00

[§] No direct curve data for biofiltration; range was an estimation based on bioretention (lower bound) and infiltration trench (higher bound).

[&] TP removal percentages for depths larger than 2.0" were not available because of a lack of corresponding curve data.

Table 5-9. The level of treatment needed in Franklin for Scenario I

BMP	Commercial		High-density residential		Industrial		Medium-density residential		Low-density residential		Forest		Open space		Freeway	
	BMP area (ac)	Depth of runoff treated (in)	BMP area (ac)	Depth of runoff treated (in)	BMP area (ac)	Depth of runoff treated (in)	BMP area (ac)	Depth of runoff treated (in)	BMP area (ac)	Depth of runoff treated (in)	BMP area (ac)	Depth of runoff treated (in)	BMP area (ac)	Depth of runoff treated (in)	BMP area (ac)	Depth of runoff treated (in)
Infiltration high-A	3.28	1.21 (99%)	0.45	0.60 (91%)	2.61	1.21 (99%)	6.58	0.60 (90%)	5.21	0.60 (90%)	2.26	1.21	0.29	1.21	0.36	0.60
Infiltration high-B	1.72	1.21 (97%)	1.18	1.20 (98%)	1.43	1.21 (97%)	4.59	1.00 (95%)	1.02	1.00 (94%)	0.66	0.60	0.31	1.21	1.39	0.60
Infiltration likely	0.09	1.00 (94%)	0.02	1.00 (94%)	0.10	0.60 (82%)	0.27	1.21 (95%)	0.31	1.00 (92%)	0.66	1.00	0.14	1.20	0.09	0.60
Biofiltration [§]	0.62	1.00 (76%-89%)	0.07	0.60 (64%-73%)	0.37	1.21 (79%-93%)	0.14	1.00 (75%-88%)	0.11	1.00 (73%-87%)	0.22	1.00	0.02	1.20	0.04	1.20
Shallow filtration-B	0.06	0.25 (38%)	0.00	0.00	0.15	1.23 (80%)	1.02	1.00 (75%)	0.74	1.00 (73%)	0.02	1.24	0.04	0.98	0.00	0.00
Shallow filtration-C	0.19	1.00 (76%)	1.83	0.99 (76%)	9.86	0.98 (76%)	4.81	0.49 (58%)	5.33	0.49 (58%)	5.07	0.98	0.19	0.74	0.77	0.74
Shallow filtration-D	0.69	0.98 (76%)	0.39	1.00 (76%)	1.56	1.00 (76%)	0.70	0.49 (58%)	0.22	0.25 (39%)	0.5	1.00	0.22	0.98	0.00	0.00
Impervious, possible PP	3.13	1.00 (74%)	0.00	0.00	1.56	0.40 (75%)	0.01	0.20 (73%)	0.10	1.00 (71%)	0.06	0.20	0.04	0.60	0.15	0.40
WQ swale, wetland ^{&}	1.37	5.76	0.19	5.76	6.18	4.32	1.70	5.76	1.18	5.76	0.75	5.76	0.03	1.20	0.00	0.00

[§] No direct curve data for biofiltration; range was an estimation based on bioretention (lower bound) and infiltration trench (higher bound).

[&] TP removal percentages for depths larger than 2.0" were not available because of a lack of corresponding curve data.

Table 5-10. The level of treatment needed in Milford for Scenario I

BMP	Commercial		High-density residential		Industrial		Medium-density residential		Low-density residential		Forest		Open space		Freeway	
	BMP area (ac)	Depth of runoff treated (in)	BMP area (ac)	Depth of runoff treated (in)	BMP area (ac)	Depth of runoff treated (in)	BMP area (ac)	Depth of runoff treated (in)	BMP area (ac)	Depth of runoff treated (in)	BMP area (ac)	Depth of runoff treated (in)	BMP area (ac)	Depth of runoff treated (in)	BMP area (ac)	Depth of runoff treated (in)
Infiltration high-A	1.12	1.21 (99%)	0.58	1.21 (99%)	0.34	1.21 (99%)	0.66	0.60 (90%)	0.33	1.21 (98%)	0.25	0.60	0.00	0.00	0.11	0.60
Infiltration high-B	0.09	0.60 (85%)	0.63	1.21 (97%)	0.00	0.00	0.34	0.60 (85%)	1.07	1.21 (96%)	0.31	1.21	0.23	1.20	0.00	0.00
Biofiltration [§]	0.48	1.21 (79%-92%)	0.09	1.21 (79%-92%)	0.32	1.21 (79%-93%)	0.04	1.21 (78%-91%)	0.10	0.60 (62%-72%)	0.02	1.21	0.06	1.20	0.24	0.60
Biofiltration/infiltration-B	5.88	1.27 (85%)	0.65	1.21 (84%)	6.8	1.27 (85%)	0.70	0.32 (50%)	0.97	0.64 (68%)	1.94	0.95	0.36	1.20	1.63	0.95
Shallow filtration-B	0.10	1.27 (80%)	0.00	0.00	0.12	0.74 (69%)	0.02	0.49 (58%)	0.11	0.98 (72%)	0.07	1.23	0.04	0.50	0.00	0.00
Shallow filtration-C	2.33	0.99 (76%)	10.21	1.23 (80%)	4.89	1.20 (79%)	7.82	0.49 (58%)	1.22	0.49 (56%)	0.53	0.49	0.10	1.20	0.06	1.20
Shallow filtration-D	2.04	1.27 (80%)	0.51	1.27 (80%)	0.00	0.00	1.14	1.23 (79%)	0.22	0.25 (39%)	0.53	0.99	0.00	0.00	0.34	1.20
Impervious, possible PP	14.15	1.20 (74%)	0.00	0.00	2.60	0.60 (75%)	0.04	0.99 (73%)	0.02	1.39 (71%)	0.04	0.40	0.00	0.00	0.06	0.40
WQ swale, wetland ^{&}	13.56	5.76	8.10	5.04	2.41	5.04	16.02	5.04	4.32	5.76	4.82	5.76	0.37	5.76	0.21	4.32

[§]No direct curve data for biofiltration; range was an estimation based on bioretention (lower bound) and infiltration trench (higher bound).

[&]TP removal percentages for depths larger than 2.0" were not available because of a lack of corresponding curve data.

5.5 BMP Optimization Setup Scenario II

Scenario II of the BMPDSS setup is different from Scenario I mainly in treating runoff from the public right-of-way (PROW) parcels. In Scenario II, the runoff from the PROW parcels is treated at downstream centralized treatment facilities that are referred to as neighborhood BMPs. The PROW parcels are treated separately in Scenario II because those parcels typically have limited space for treating runoff onsite.

5.5.1 Neighborhood BMPs

Neighborhood BMPs are used to treat runoff when site conditions make it very difficult and expensive to treat stormwater onsite. A neighborhood BMP is anticipated to be installed at or near existing stormwater outfalls with the primary goal of treating stormwater generated along PROWs. Maps showing potential locations for neighborhood BMPs in each community were developed with input from the communities. That was an attempt to realistically consider feasible locations without going through an extensive site-level analysis. The map showing the potential likelihood of neighborhood BMP placement, or hydrologic management units (HMUs), in the three communities are shown in Figure 5-5. As shown, neighborhoods HMUs were broken up into five categories to reflect the likelihood of finding space for a neighborhood BMP at the end of existing pipes.

Neighborhood HMU maps were developed using the best professional judgment of experienced analysts and checked by local officials to arrive at a professional consensus. Maps showing roads, streams, wetlands, contour lines and existing watershed divides were factored into the delineations. It was assumed that stormwater would flow downhill along existing roads toward the nearest stream. One major consideration was the amount of upland area available to construct a BMP near the end of existing pipes, compared to the area of PROWs generating runoff. Secondary considerations include the presence of steep slopes in the area of expected outfalls and dense downtown areas.

Areas were rated *Yes* if an end-of-pipe BMP was assured according to site condition information to treat all the stormwater from the PROW. Very few areas were so designated. Neighborhoods were rated *Likely* if it was expected that about 75 percent of the stormwater generated on PROW could be treated by a neighborhood BMP. The remaining 25 percent would directly discharge to the stream. The rating of *Possible* was used to indicate an area where 50 percent of the stormwater generated on PROWs would be treated by a neighborhood BMP. For areas rated *Rare* it was anticipated that only 25 percent of the stormwater generated on PROWs would be treated in neighborhood BMPs. In a few instances, the rating of *No* indicates that no end of pipe BMP was anticipated. Those were restricted to a few lake shore neighborhoods.

Using descriptive ratings allows the ratios of treated to untreated stormwater runoff to be adjusted to accommodate different opinions or different management priorities. For the purpose of this pilot, it was assumed that most neighborhood BMPs placed at or near the end of existing stormwater infrastructure would consist mostly of constructed wetlands. Most outfalls are near streams, where high groundwater tables are anticipated.

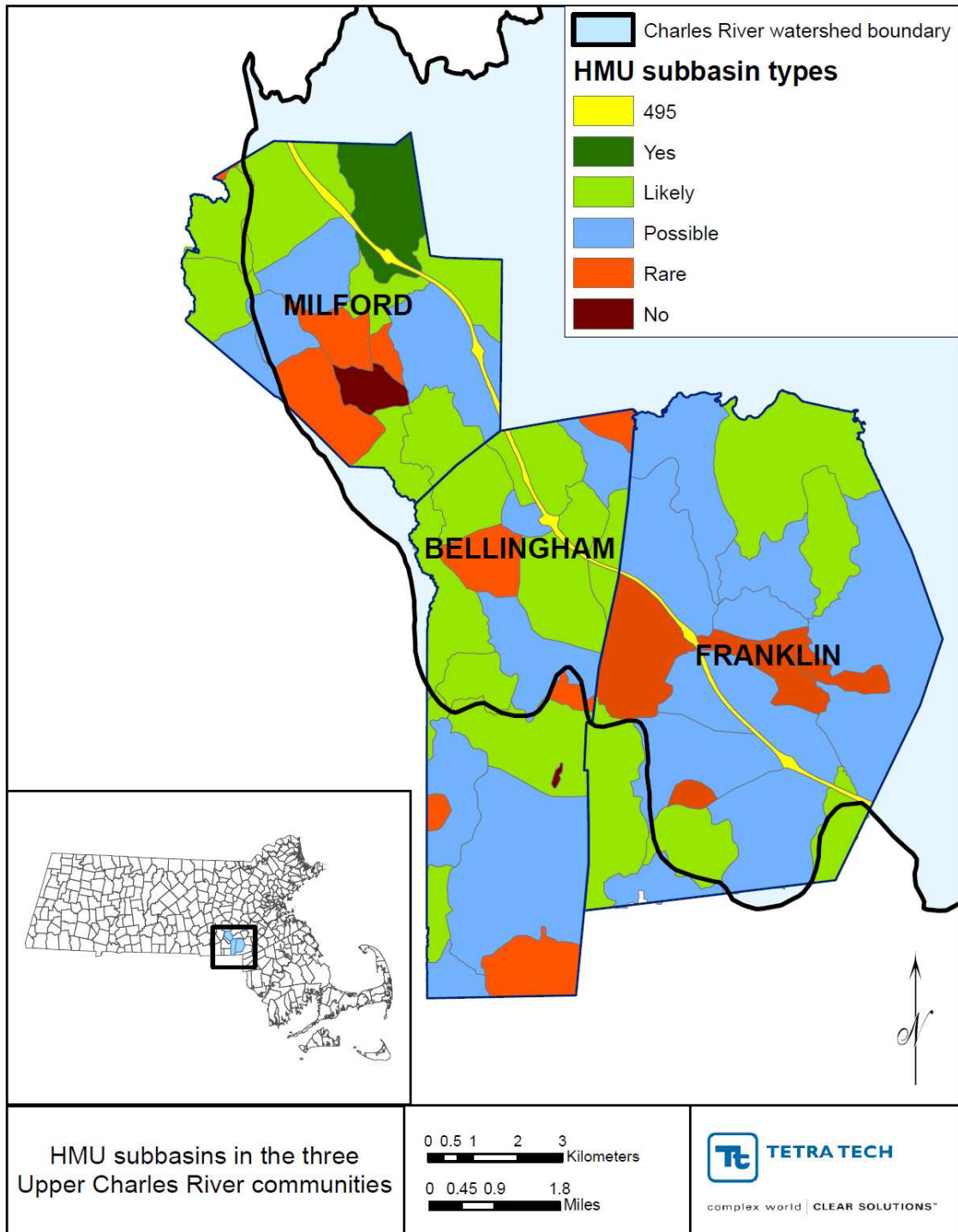

Figure 5-5. The HMU subbasins in the communities of Bellingham, Franklin, and Milford.

5.5.2 Scenario II Setup

In the Scenario II setup, runoff from the impervious HRUs in parcels other than PROWs was still routed to their respective management categories as in Scenario I. The runoff from pervious and impervious HRUs in the PROW parcels was routed to the neighborhood BMPs. Also, runoff from HRUs that drain to *Less likely for onsite BMPs* management categories was routed to the neighborhood BMPs. A schematic for the Scenario II setup is shown in Figure 5-6.

As shown, runoff from impervious HRUs (at parcels other than PROW) was routed to onsite BMPs, runoff from PROW HRUs and HRUs previously draining to *Less likely for onsite BMP* categories (LLOB-HRU) was routed to neighborhood BMPs, and the runoff from pervious HRUs was directly routed to the community outlet. The sizes of the neighborhood BMPs were determined by the HMU category and the contributing size of PROW parcels and LLOB-HRUs, following the rule specified previously.

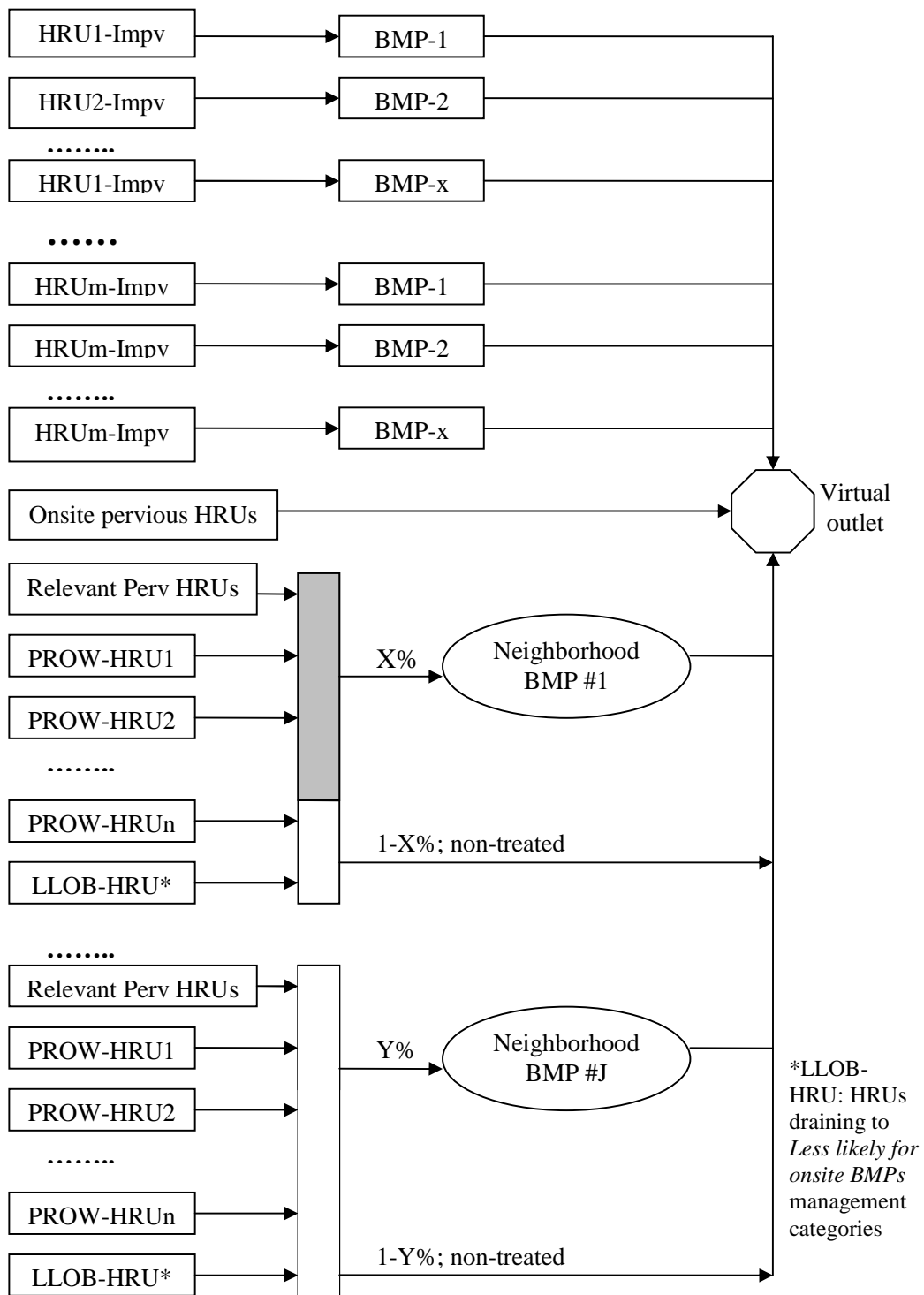

Figure 5-6. Scenario II setup in the three Upper Charles River communities.

When preparing the data for the Scenario II setup, HRUs in the PROW parcels were first separated from the rest of the watershed parcels and were tabulated into the HMU categories shown in Figure 5-5. Following the approach used in the Scenario I setup, the

impervious HRUs were tabulated according to management categories for the rest of the areas in a community. The tabulated HRUs draining to *Less likely for onsite BMPs* management categories, along with the previously tabulated PROW parcels, were routed to neighborhood BMPs. The tabulation results of impervious HRUs to the onsite and to the neighborhood management categories in the three communities are summarized in Tables 5-11 to 5-13.

**Table 5-11. Tabulation of impervious HRUs into onsite and neighborhood management categories in Bellingham for Scenario II setup
(Unit: acres)**

BMP	Commercial	High-density residential	Industrial	Medium-density residential	Freeway	Low-density residential	Open space	Forest
Infiltration high-A	45.72	33.47	87.66	29.63	1.46	24.85	41.91	14.33
Infiltration high-B	5.26	16.61	9.75	14.89	48.41	10.30	14.17	7.64
Infiltration likely	2.33	2.02	6.94	1.16	0.00	2.07	0.00	0.67
Biofiltration	4.39	0.59	4.43	0.45	0.00	0.14	0.00	0.33
Biofiltration/infiltration-A	0.00	0.00	0.00	0.00	0.00	0.00	0.00	0.00
Biofiltration/infiltration-B	0.00	0.00	0.00	0.00	0.00	0.00	0.00	0.00
Biofiltration/infiltration-C	0.00	0.00	0.00	0.00	0.00	0.00	0.00	0.00
Biofiltration-D	0.00	0.00	0.00	0.00	0.00	0.00	0.00	0.00
Shallow filtration-A	0.00	0.00	0.00	0.00	0.00	0.00	0.00	0.00
Shallow filtration-B	0.00	0.78	0.00	0.95	0.00	0.05	0.00	0.01
Shallow filtration-C	8.42	12.64	22.86	8.42	0.00	10.76	0.01	3.80
Shallow filtration-D	29.36	0.63	18.19	4.11	0.00	2.64	28.70	3.41
Impervious, possible PP	41.58	0.04	38.26	0.00	0.07	0.17	1.54	1.76
WQ swale, wetland	12.59	14.29	0.84	1.03	0.00	4.28	0.07	4.17
Less likely for onsite BMP	1.66	0.31	0.00	2.71	0.00	1.27	0.00	0.53
Neighborhood-Yes	0.00	0.00	0.00	0.00	0.00	0.00	0.00	0.00
Neighborhood-Likely	4.09	5.23	4.34	17.92	2.85	12.67	0.29	27.33
Neighborhood-Possible	10.59	11.72	5.66	25.81	3.50	14.53	0.19	12.07
Neighborhood-Rare	0.57	23.66	0.64	9.30	0.63	3.47	0.73	6.11
Neighborhood-No	0.00	0.00	0.00	0.00	0.00	0.00	0.00	0.00
Total	166.56	121.98	199.58	116.38	56.92	87.22	87.60	82.15

Table 5-12. Tabulation of impervious HRUs into onsite and neighborhood management categories in Franklin for Scenario II setup (Unit: acres)

BMP	Commercial	High-density residential	Industrial	Medium-density residential	Freeway	Low-density residential	Open space	Forest
Infiltration high-A	75.80	19.01	77.41	132.08	22.01	99.42	8.09	20.35
Infiltration high-B	54.52	24.93	42.97	143.49	87.51	63.08	4.89	38.95
Infiltration likely	1.15	0.36	6.38	8.50	5.63	4.93	0.98	5.97
Biofiltration	39.10	4.55	11.68	2.88	1.26	3.57	0.17	2.03
Biofiltration/infiltration-A	0.00	0.00	0.00	0.00	0.00	0.00	0.00	0.00
Biofiltration/infiltration-B	0.00	0.00	0.00	0.00	0.00	0.00	0.00	0.00
Biofiltration/infiltration-C	0.00	0.00	0.00	0.00	0.00	0.00	0.00	0.00
Biofiltration-D	0.00	0.00	0.00	0.00	0.00	0.00	0.00	0.00
Shallow filtration-A	0.00	0.00	0.00	0.02	0.00	0.03	0.00	0.00
Shallow filtration-B	3.98	0.00	1.86	8.04	0.00	3.29	0.63	0.27
Shallow filtration-C	9.57	28.18	139.96	116.75	14.65	45.36	2.45	19.10
Shallow filtration-D	10.94	12.20	16.46	19.88	0.00	13.98	3.41	5.14
Impervious, possible PP	39.51	0.00	46.68	0.43	4.65	0.42	0.86	2.78
WQ swale, wetland	10.82	1.35	65.25	13.46	0.02	9.31	0.29	5.92
Less likely for onsite BMP	3.34	1.21	2.57	13.40	15.11	9.34	0.16	6.08
Neighborhood-Yes	0.00	0.00	0.00	0.00	0.00	0.00	0.00	0.00
Neighborhood-Likely	0.85	1.18	0.00	80.83	0.01	31.00	0.39	39.97
Neighborhood-Possible	7.47	4.37	12.93	199.17	0.67	71.18	1.27	66.60
Neighborhood-Rare	22.23	4.68	13.64	44.34	1.62	5.46	1.22	9.67
Neighborhood-No	0.00	0.00	0.00	0.00	0.00	0.00	0.00	0.00
Total	279.28	102.00	437.77	783.27	153.24	360.36	24.81	222.84

Table 5-13. Tabulation of impervious HRUs into onsite and neighborhood management categories in Milford for Scenario II setup (Unit: acres)

BMP	Commercial	High-density residential	Industrial	Medium-density residential	Freeway	Low-density residential	Open space	Forest
Infiltration high-A	32.56	17.21	7.92	34.32	0.82	8.21	0.00	10.59
Infiltration high-B	5.02	4.48	2.67	10.12	0.00	19.85	4.38	5.25
Infiltration likely	0.00	0.00	0.00	0.00	0.00	0.00	0.00	0.00
Biofiltration	31.26	1.32	12.80	0.59	13.41	7.38	0.23	1.48
Biofiltration/infiltration-A	0.00	0.00	0.00	0.00	0.00	0.00	0.00	0.00
Biofiltration/infiltration-B	70.56	4.82	90.37	23.91	30.87	18.19	2.76	27.80
Biofiltration/infiltration-C	0.00	0.00	0.00	0.00	0.00	0.00	0.00	0.00
Biofiltration-D	0.00	0.00	0.00	0.00	0.00	0.00	0.00	0.00
Shallow filtration-A	0.00	0.00	0.00	0.00	0.00	0.00	0.00	0.00
Shallow filtration-B	1.19	0.00	2.23	0.46	0.00	1.62	0.87	0.76
Shallow filtration-C	43.07	112.94	28.25	180.40	0.52	25.99	1.02	5.64
Shallow filtration-D	13.40	3.61	1.39	11.13	0.00	9.89	0.19	6.30
Impervious, possible PP	84.59	0.12	46.39	0.54	1.11	0.18	0.03	1.21
WQ swale, wetland	30.23	0.74	10.80	4.12	0.01	9.27	1.73	3.75
Less likely for onsite BMP	17.07	2.60	2.74	12.90	30.33	6.18	1.50	3.77
Neighborhood-Yes	1.29	0.00	0.37	0.00	0.12	0.71	0.03	6.32
Neighborhood-Likely	4.64	0.00	1.41	62.01	1.62	28.61	0.27	30.37
Neighborhood-Possible	21.39	14.12	4.77	78.31	0.55	13.01	0.39	15.15
Neighborhood-Rare	16.65	44.81	2.04	43.89	0.40	4.61	0.69	3.38
Neighborhood-No	11.02	9.38	2.58	9.83	0.34	0.60	0.00	0.62
Total	383.97	216.16	216.72	472.86	81.26	154.31	14.08	122.37

The goal of optimization in Scenario II was to meet the TMDL target for TP reduction in each community while minimizing the total cost. The decision variables (parameters to optimize) in Scenario II were the areas of both onsite BMPs and regional BMPs.

5.5.3 Scenario II Results

The Scenario II optimization results for the three communities are shown in Figures 5-7 to 5-9 below. As shown, overall the near-optimal Scenario II costs are lower than the respective Scenario I costs for meeting the phosphorus reduction target in all three communities. That is mainly because the unit costs for neighborhood BMPs tend to decrease as the sizes of the neighborhood BMPs increase, which in turn makes the neighborhood BMP a preferred choice during the optimization process and results in less total costs.

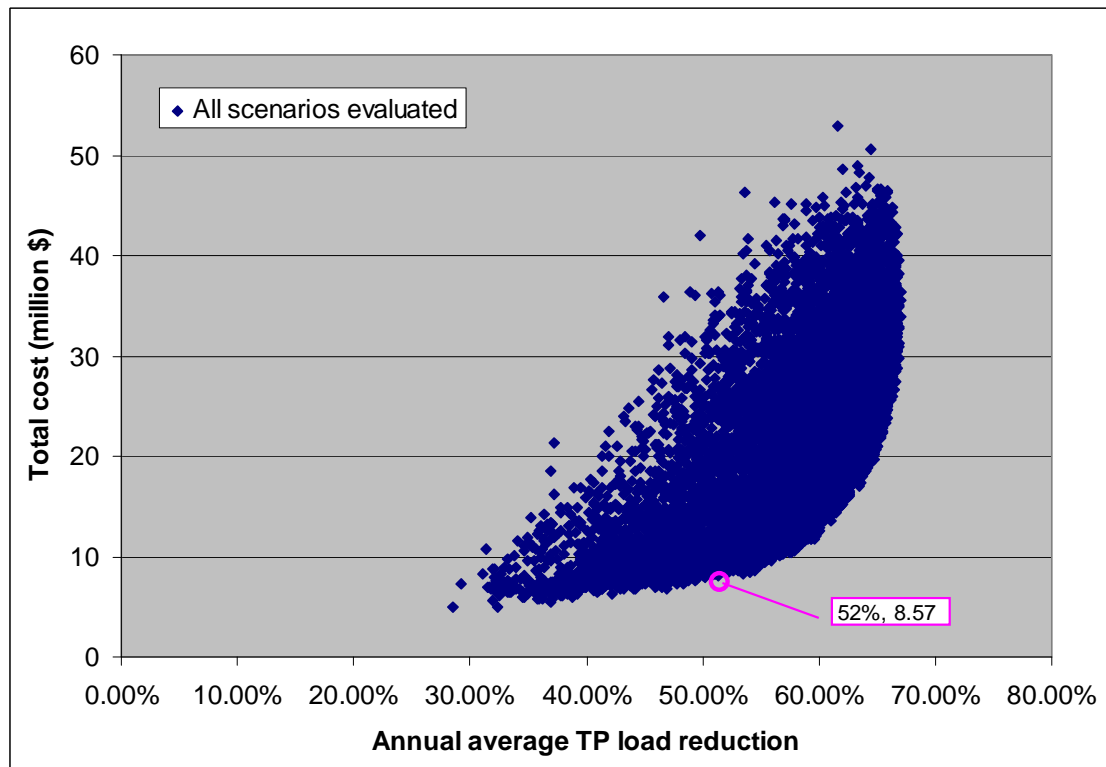

Figure 5-7. BMPDSS optimization results for Scenario II setup in Bellingham.

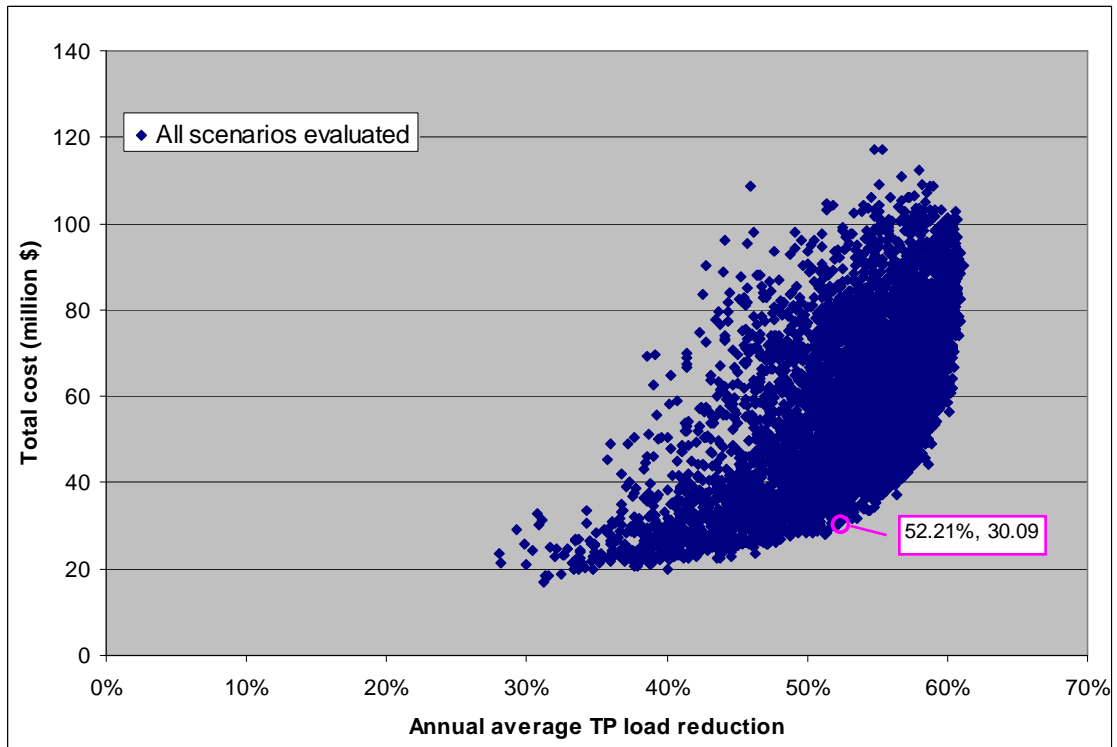

Figure 5-8. BMPDSS optimization results for Scenario II setup in Franklin.

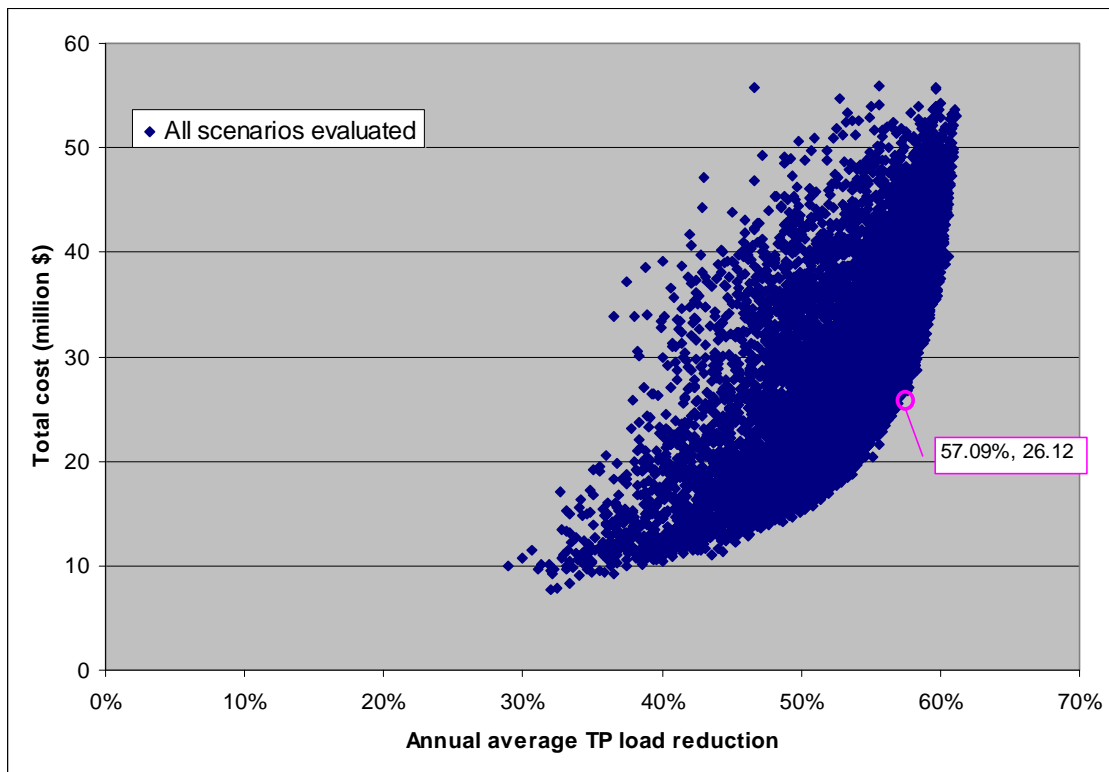

Figure 5-9. BMPDSS optimization results for Scenario II setup in Milford.

A summary of the Scenario II optimization results regarding unit cost of control is shown in Table 5-14.

Table 5-14. Summary of optimal solutions identified for Scenario II in all three communities

Community	Total impv. Area (acres)	Percent reduction goal	Total cost (million \$)	Cost per acre	Cost per lb of TP removal
Bellingham	918	52%	\$9	\$9,800	\$8,700
Franklin	2,364	52%	\$30	\$12,700	\$10,700
Milford	1,662	57%	\$26	\$15,700	\$11,800

5.5.4 Required Level of Treatment for Scenario II

Using the near-optimal BMP sizing alternative identified through the optimization process, the level of treatment needed for each HRU can be back-calculated. The level of treatment (depth of runoff to be treated) required in each community is summarized in Tables 5-15 to 5-17, and the corresponding percentages of reduction for TP are also included alongside the calculated depths.

Table 5-15. The level of treatment needed in Bellingham for Scenario II

BMP	Commercial		High-density residential		Industrial		Medium-density residential		Low-density residential		Forest		Open space		Freeway	
	BMP area (ac)	Depth of runoff treated (in)	BMP area (ac)	Depth of runoff treated (in)	BMP area (ac)	Depth of runoff treated (in)	BMP area (ac)	Depth of runoff treated (in)	BMP area (ac)	Depth of runoff treated (in)	BMP area (ac)	Depth of runoff treated (in)	BMP area (ac)	Depth of runoff treated (in)	BMP area (ac)	Depth of runoff treated (in)
Infiltration high-A	0.69	0.60 (91%)	0.50	0.60 (91%)	1.31	0.60 (92%)	0.44	0.60 (90%)	0.37	0.60 (90%)	0.43	1.20	0.00	0.00	0.02	0.60
Infiltration high-B	0.16	1.20 (97%)	0.25	0.60 (86%)	0.15	0.60 (86%)	0.22	0.60 (85%)	0.15	0.60 (84%)	0.00	0.00	0.64	1.20	0.73	0.60
Infiltration likely	0.14	1.20 (96%)	0.06	1.20 (96%)	0.00	0.00	0.02	0.60 (81%)	0.16	1.20 (94%)	0.03	1.20	0.00	0.00	0.00	0.00
Biofiltration [§]	0.13	1.20 (79%-92%)	0.04	1.20 (79%-92%)	0.20	1.20 (79%-93%)	0.04	1.20 (78%-91%)	0.01	1.20 (76%-90%)	0.03	1.20	0.00	0.00	0.00	0.00
Shallow filtration-C	0.25	0.50 (58%)	0.19	0.25 (39%)	0.00	0.00	0.25	0.50 (58%)	0.16	0.25 (39%)	0.11	0.50	0.00	0.00	0.00	0.00
Shallow filtration-D	0.44	0.25 (38%)	0.02	0.50 (58%)	0.27	0.25 (39%)	0.12	0.50 (58%)	0.12	0.74 (66%)	0.00	0.00	0.86	0.50	0.00	0.00
Impervious, possible PP	0.62	0.20 (74%)	0.00	0.00	0.57	0.20 (75%)	0.00	0.00	0.01	0.80 (71%)	0.08	0.60	0.14	1.20	0.00	0.00
WQ swale, wetland ^{&}	1.70	5.76	0.43	1.44 (28%)	0.03	1.44 (28%)	0.05	2.17	0.00	0.00	0.56	5.76	0.00	0.00	0.00	0.00
BMP							BMP area (ac)				Depth of runoff treated (in)					
Neighborhood gravel wetland-Likely							3.34				1.45 (65%)					
Neighborhood gravel wetland-Possible							3.29				1.38 (64%)					
Neighborhood gravel wetland -Rare							1.76				1.38 (64%)					

[§] No direct curve data for biofiltration; range was an estimation based on bioretention (lower bound) and infiltration trench (higher bound).

[&] TP removal percentages for depths larger than 2.0" were not available because of a lack of corresponding curve data.

Table 5-16. The level of treatment needed in Franklin for Scenario II

BMP	Commercial		High-density residential		Industrial		Medium-density residential		Low-density residential		Forest		Open space		Freeway	
	BMP area (ac)	Depth of runoff treated (in)	BMP area (ac)	Depth of runoff treated (in)	BMP area (ac)	Depth of runoff treated (in)	BMP area (ac)	Depth of runoff treated (in)	BMP area (ac)	Depth of runoff treated (in)	BMP area (ac)	Depth of runoff treated (in)	BMP area (ac)	Depth of runoff treated (in)	BMP area (ac)	Depth of runoff treated (in)
Infiltration high-A	3.59	1.20 (99%)	1.20	0.60 (91%)	1.22	1.20 (99%)	2.09	0.60 (90%)	1.57	0.60 (90%)	1.61	1.20	0.38	1.20	1.04	1.20
Infiltration high-B	0.86	1.20 (97%)	1.18	1.50 (99%)	0.68	1.20 (97%)	2.27	0.60 (85%)	0.00	0.00	0.62	0.60	0.46	1.20	1.38	0.60
Infiltration likely	0.07	1.20 (96%)	0.00	0.00	0.1	0.60 (82%)	0.13	0.60 (81%)	0.08	0.60 (80%)	0.19	1.21	0.00	0.00	0.53	1.20
Biofiltration [§]	1.23	1.00 (76%-89%)	0.57	0.60 (64%-73%)	0.74	1.20 (79%-93%)	0.09	1.00 (75%-88%)	0.11	1.00 (73%-87%)	0.06	1.00	0.00	0.00	0.12	1.20
Shallow filtration-B	0.13	0.49 (58%)	0.00	0.00	0.21	1.20 (79%)	0.13	0.25 (39%)	0.31	1.48 (81%)	0.02	1.00	0.08	1.20	0.00	0.00
Shallow filtration-C	0.00	0.00	3.11	1.00 (74%)	2.21	1.00 (76%)	3.69	0.49 (58%)	2.15	0.50 (58%)	2.11	1.00	0.23	1.20	0.46	0.50
Shallow filtration-D	0.52	0.74 (69%)	0.58	0.74 (69%)	0.78	0.74 (69%)	0.31	0.50 (58%)	0.66	0.30 (44%)	0.08	1.00	0.16	0.74	0.00	0.00
Impervious, possible PP	4.37	1.40 (74%)	0.00	0.00	0.00	0.00	0.01	0.20 (73%)	0.05	1.20 (71%)	0.31	0.40	0.07	1.00	0.29	0.80
WQ swale, wetland ^{&}	1.20	5.04	0.06	2.17	9.27	5.76	0.85	2.88	0.29	1.44 (28%)	0.28	2.16	0.00	0.00	0.00	0.00
BMP	BMP area (ac)						Depth of runoff treated (in)									
Neighborhood gravel wetland-Likely	5.82						0.95 (60%)									
Neighborhood gravel wetland-Possible	10.94						1.01 (61%)									
Neighborhood gravel wetland -Rare	3.64						1.18 (62%)									

[§] No direct curve data for biofiltration; range was an estimation based on bioretention (lower bound) and infiltration trench (higher bound).

[&] TP removal percentages for depths larger than 2.0" were not available because of a lack of corresponding curve data.

Table 5-17. The level of treatment needed in Milford for Scenario II

BMP	Commercial		High-density residential		Industrial		Medium-density residential		Low-density residential		Forest		Open space		Freeway	
	BMP area (ac)	Depth of runoff treated (in)	BMP area (ac)	Depth of runoff treated (in)	BMP area (ac)	Depth of runoff treated (in)	BMP area (ac)	Depth of runoff treated (in)	BMP area (ac)	Depth of runoff treated (in)	BMP area (ac)	Depth of runoff treated (in)	BMP area (ac)	Depth of runoff treated (in)	BMP area (ac)	Depth of runoff treated (in)
Infiltration high-A	1.72	1.20 (99%)	0.91	1.20 (99%)	0.28	1.21 (99%)	0.61	0.60 (90%)	0.14	0.60 (90%)	0.37	1.21	0.00	0.00	0.09	1.20
Infiltration high-B	0.44	1.20 (97%)	0.55	1.20 (97%)	0.05	0.60 (86%)	0.54	1.20 (96%)	0.35	0.60 (84%)	0.09	0.60	0.23	1.20	0.00	0.00
Biofiltration [§]	0.55	0.60 (64%-73%)	0.19	1.20 (79%-92%)	0.45	1.21 (79%-93%)	0.00	0.00	0.13	0.60 (62%-71%)	0.18	1.20	0.02	1.20	0.24	0.60
Biofiltration/infiltration-B	4.98	1.27 (85%)	0.17	0.64 (70%)	4.78	0.95 (80%)	0.84	0.64 (69%)	1.93	1.21 (81%)	0.49	0.32	0.05	0.32	2.18	1.20
Shallow filtration-C	4.56	1.48 (84%)	3.99	0.49 (58%)	3.49	1.20 (79%)	9.55	0.74 (68%)	0.46	0.25 (39%)	0.60	1.20	0.18	1.20	0.00	0.00
Shallow filtration-D	0.71	0.74 (69%)	0.25	0.98 (76%)	0.17	1.20 (79%)	0.98	1.23 (79%)	0.17	0.25 (39%)	0.22	0.49	0.00	0.00	0.00	0.00
Impervious, possible PP	13.43	1.20 (74%)	0.01	0.59 (74%)	2.46	0.60 (75%)	0.05	1.00 (73%)	0.00	0.00	0.15	1.40	0.00	0.00	0.16	1.20
WQ swale, wetland ^{&}	4.27	5.76	0.12	5.76	1.14	4.32	0.15	1.44 (28%)	0.98	4.32	0.53	5.76	0.18	4.32	0.00	0.00
BMP							BMP area (ac)				Depth of runoff treated (in)					
Neighborhood gravel wetland-Yes							0.18				0.62 (52%)					
Neighborhood gravel wetland-Likely							9.47				1.38 (64%)					
Neighborhood gravel wetland-Possible							7.01				1.42 (64%)					
Neighborhood gravel wetland -Rare							4.32				1.11 (62%)					

[§] No direct curve data for biofiltration; range was an estimation based on bioretention (lower bound) and infiltration trench (higher bound).

[&] TP removal percentages for depths larger than 2.0" were not available because of a lack of corresponding curve data.

5.6 BMP Optimization Setup Scenario III

The Scenario III setup is different from the Scenario II setup in treating runoff from onsite pervious HRUs. In Scenario III, runoff from both the pervious and impervious non-PROW (onsite) parcels is treated by onsite BMPs, whereas in Scenario II only the impervious runoff from the onsite parcels is treated by onsite BMPs. One exception for that treatment of pervious runoff in Scenario III is the forest parcels, where still only the impervious runoff is treated and the pervious runoff is directly routed to the community virtual outlet (as in Scenario II). The treatment of PROW parcel runoff remains the same in Scenario III as in Scenario II, where impervious and pervious runoff from the PROW parcels is treated by neighborhood BMPs. A schematic of the Scenario III setup is shown in Figure 5-10.

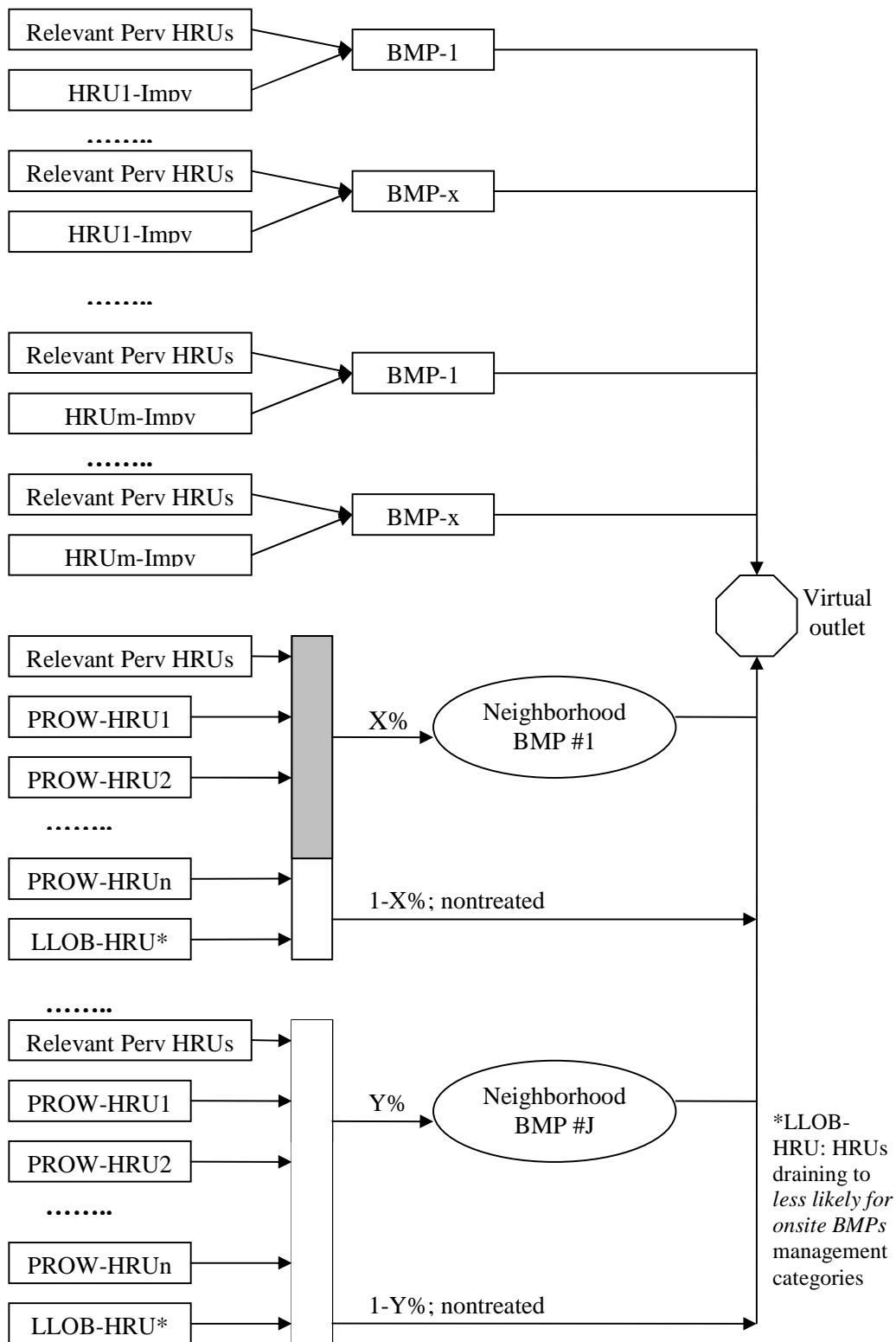

Figure 5-10. Schematic for Scenario III setup in the three Upper Charles River communities.

5.6.1 Scenario III Setup

Following the Scenario III setup schematic, HRUs in each community are tabulated according to the appropriate onsite and neighborhood BMPs. Because the routing of impervious HRUs runoff remains the same in Scenario III as that in Scenario II, the tabulation results of impervious HRUs into the onsite and neighborhood BMPs in the three communities are the same as previously shown in Tables 5-11 to 5-13.

5.6.2 Scenario III Results

The Scenario III setup was represented into BMPDSS, and the optimization process was carried out to identify the tradeoff between total cost and percentage reduction of TP in each community. A plot of the cost and TP reduction for all BMP sizing alternatives evaluated in a community forms a tradeoff front between the two, as shown in Figures 5-11 to 5-13. The BMP implementation alternative that meets the TP reduction target and at the same time has the lowest cost is also highlighted in the figures.

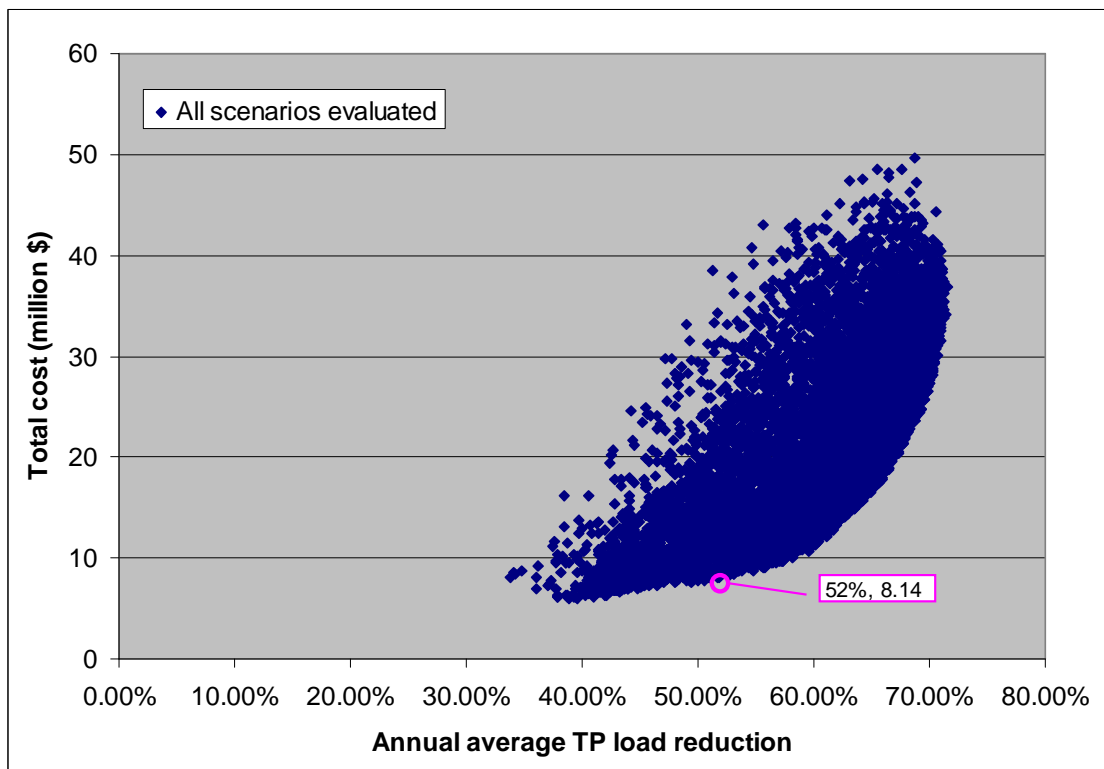

Figure 5-11. BMPDSS optimization results for Scenario III setup in Bellingham.

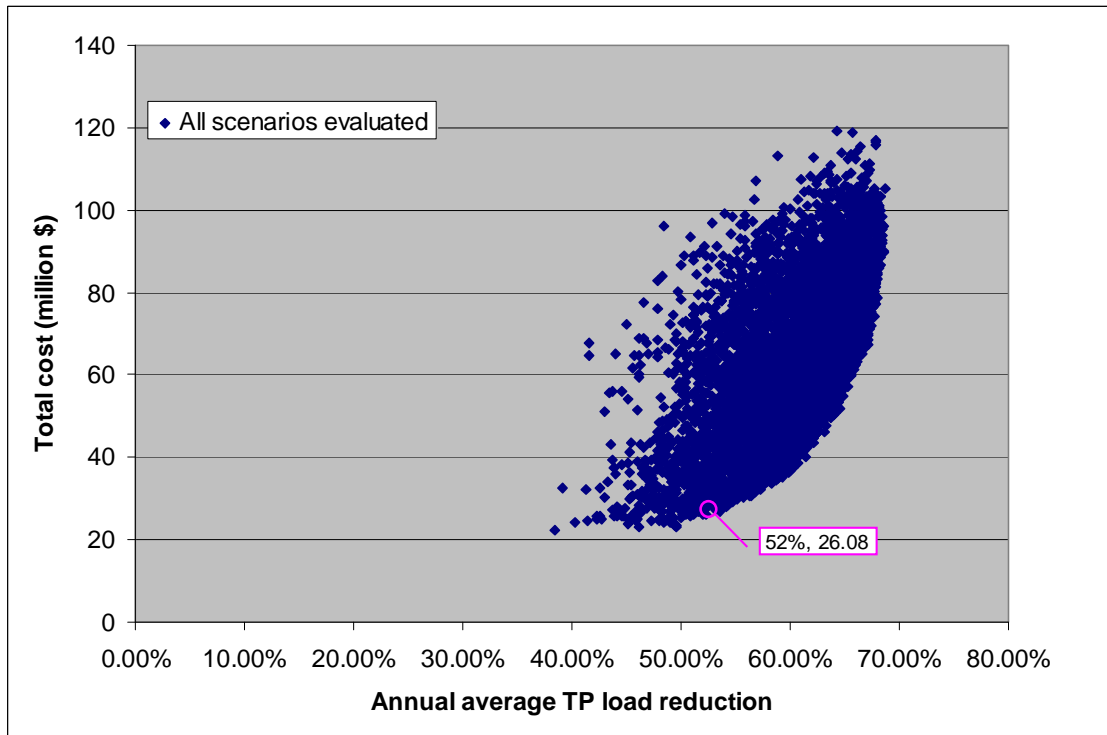

Figure 5-12. BMPDSS optimization results for Scenario III setup in Franklin.

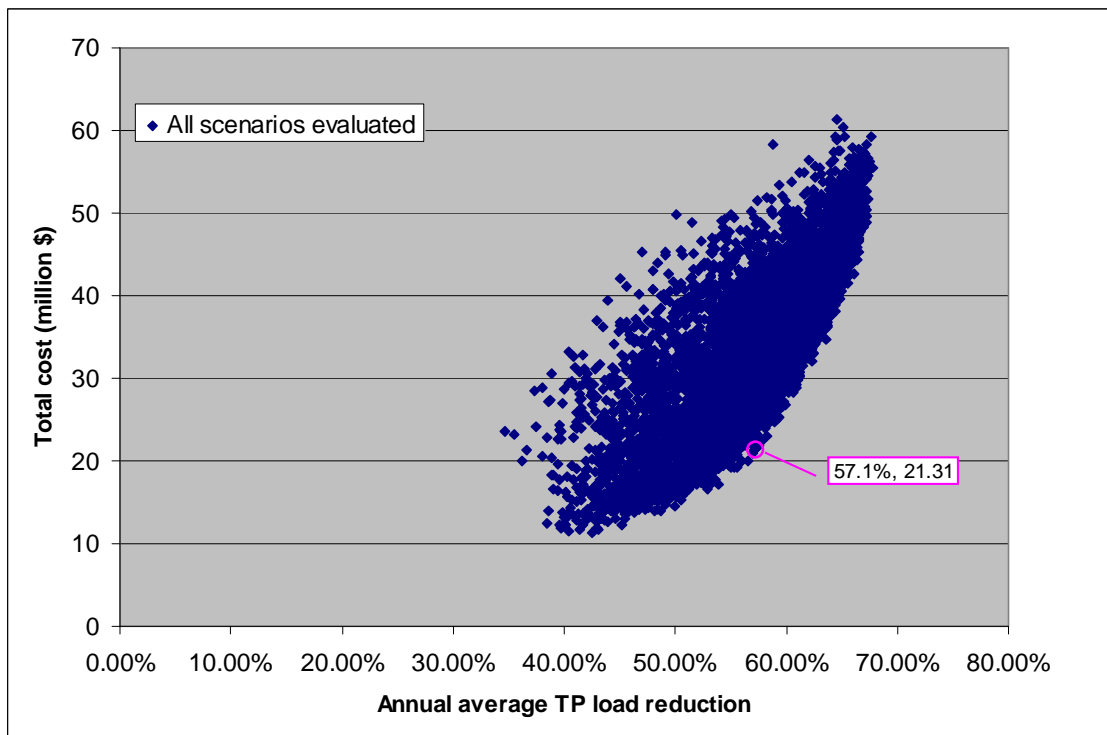

Figure 5-13. BMPDSS optimization results for Scenario III setup in Milford.

The total costs for Scenario III in the three communities are summarized and compared to the Scenario II total costs in Table 5-18. As shown in the table, the Scenario III costs in the three communities are lower than the Scenario II total costs.

Table 5-18. Near-optimal solutions identified for Scenario III as compared to those for Scenario II in the three communities

Community	Total impv. area (acres)	Percentage reduction goal	Total cost (million \$) for scenario		Cost per acre of imperviousness for scenario		Cost per lb of TP removal for scenario	
			II	III	II	III	II	III
Bellingham	918	52%	\$9	\$8	\$9,800	\$8,700	\$8,700	\$7,700
Franklin	2,363	52%	\$30	\$26	\$12,700	\$11,000	\$10,700	\$9,300
Milford	1,662	57%	\$26	\$21	\$15,700	\$12,800	\$11,800	\$9,600

5.6.3 Required Level of Treatment for Scenario III

Using the near-optimal BMP sizing alternative identified through the optimization process, the level of treatment needed for each HRU can be back-calculated. The level of treatment (total BMP area and depth of runoff to be treated for each source area) required in each community is summarized in Tables 5-19 to 5-21, and the corresponding percentages of reduction for TP are also included alongside the calculated depths.

Table 5-19. The level of treatment needed in Bellingham for Scenario III

BMP	Commercial		High-density residential		Industrial		Medium-density residential		Low-density residential		Forest		Open space		Freeway	
	BMP area (ac)	Depth of runoff treated (in)	BMP area (ac)	Depth of runoff treated (in)	BMP area (ac)	Depth of runoff treated (in)	BMP area (ac)	Depth of runoff treated (in)	BMP area (ac)	Depth of runoff treated (in)	BMP area (ac)	Depth of runoff treated (in)	BMP area (ac)	Depth of runoff treated (in)	BMP area (ac)	Depth of runoff treated (in)
Infiltration high-A	0.69	0.60 (91%)	0.50	0.60 (91%)	1.31	0.60 (92%)	0.44	0.60 (90%)	0.37	0.60 (90%)	0.21	0.60	0.00	0.00	0.00	0.00
Infiltration high-B	0.24	1.20 (97%)	0.25	0.60 (86%)	0.15	0.60 (86%)	0.22	0.60 (85%)	0.15	0.60 (84%)	0.23	1.20	0.21	0.60	0.73	0.60
Infiltration likely	0.03	0.60 (82%)	0.18	1.20 (96%)	0.21	1.20 (96%)	0.12	1.20 (95%)	0.03	0.60 (80%)	0.06	1.20	0.00	0.00	0.00	0.00
Biofiltration [§]	0.20	1.20 (79%-92%)	0.06	1.20 (79%-92%)	0.07	0.60 (64%-74%)	0.06	1.20 (78%-91%)	0.00	0.00	0.03	1.20	0.00	0.00	0.00	0.00
Shallow filtration-C	0.63	1.20 (79%)	0.38	0.50 (58%)	0.34	0.25 (39%)	0.38	0.74 (68%)	0.16	0.25 (39%)	0.00	0.00	0.00	0.00	0.00	0.00
Shallow filtration-D	0.00	0.00	0.03	0.74 (69%)	0.27	0.25 (39%)	0.00	0.00	0.20	1.20 (76%)	0.46	1.20	0.00	0.00	0.00	0.00
Impervious, possible PP	0.62	0.20 (74%)	0.00	0.00	0.00	0.00	0.00	0.00	0.02	1.20 (71%)	0.16	1.20	0.14	1.20	0.00	0.00
WQ swale, wetland ^{&}	1.32	5.04	1.07	3.60	0.03	1.44 (28%)	0.12	5.76	0.38	4.32	0.06	0.72	0.00	0.00	0.00	0.00
BMP							BMP area (ac)					Depth of runoff treated (in)				
Neighborhood gravel wetland-Likely							1.13					0.50 (46%)				
Neighborhood gravel wetland-Possible							2.93					1.23 (63%)				
Neighborhood gravel wetland -Rare							1.16					0.90 (59%)				

[§]No direct curve data for biofiltration; range was an estimation based on bioretention (lower bound) and infiltration trench (higher bound).

[&]TP removal percentages for depths larger than 2.0" were not available because of a lack of corresponding curve data.

Table 5-20. The level of treatment needed in Franklin for Scenario III

BMP	Commercial		High-density residential		Industrial		Medium-density residential		Low-density residential		Forest		Open space		Freeway	
	BMP area (ac)	Depth of runoff treated (in)	BMP area (ac)	Depth of runoff treated (in)	BMP area (ac)	Depth of runoff treated (in)	BMP area (ac)	Depth of runoff treated (in)	BMP area (ac)	Depth of runoff treated (in)	BMP area (ac)	Depth of runoff treated (in)	BMP area (ac)	Depth of runoff treated (in)	BMP area (ac)	Depth of runoff treated (in)
Infiltration high-A	1.20	0.60 (91%)	0.90	1.20 (99%)	1.22	0.60 (92%)	2.09	0.60 (90%)	1.57	0.60 (90%)	1.93	1.20	0.38	1.20	0.35	0.60
Infiltration high-B	1.72	1.20 (97%)	1.57	1.21 (97%)	0.68	0.60 (86%)	2.27	0.60 (85%)	1.00	0.60 (84%)	0.00	0.00	0.31	1.20	1.38	0.60
Infiltration likely	0.09	1.21 (96%)	0.01	1.21 (96%)	0.10	0.60 (82%)	0.13	0.60 (81%)	0.31	1.20 (94%)	0.19	1.20	0.06	1.20	0.09	0.60
Biofiltration [§]	1.23	1.20 (79%-92%)	0.43	1.20 (79%-92%)	0.74	1.20 (79%-93%)	0.18	1.20 (78%-91%)	0.11	1.20 (76%-90%)	0.29	1.20	0.00	0.00	0.16	1.20
Shallow filtration-B	0.57	1.20 (79%)	0.00	0.00	0.03	0.33 (44%)	0.25	0.51 (58%)	0.10	0.48 (57%)	0.01	0.80	0.08	1.20	0.00	0.00
Shallow filtration-C	0.30	0.50 (58%)	0.44	0.34 (44%)	2.21	0.31 (44%)	1.84	0.30 (44%)	1.43	0.50 (57%)	1.21	1.00	0.04	0.25	1.62	1.20
Shallow filtration-D	0.69	1.00 (76%)	1.16	1.00 (76%)	0.00	0.00	0.31	0.32 (44%)	0.22	0.28 (44%)	0.24	0.70	0.05	0.25	0.00	0.00
Impervious, possible PP	1.25	0.38 (74%)	0.00	0.00	0.00	0.00	0.05	0.41 (73%)	0.02	0.60 (71%)	0.40	1.80	0.12	1.20	0.51	1.20
WQ swale, wetland ^{&}	0.85	3.62	0.17	5.76	4.12	2.68	0.21	0.72 (15%)	0.44	2.18	0.47	3.60	0.04	5.76	0.00	0.00
BMP							BMP area (ac)					Depth of runoff treated (in)				
Neighborhood gravel wetland-Likely							8.27					0.89 (59%)				
Neighborhood gravel wetland-Possible							9.65					1.35 (64%)				
Neighborhood gravel wetland -Rare							3.91					1.27 (63%)				

[§] No direct curve data for biofiltration; range was an estimation based on bioretention (lower bound) and infiltration trench (higher bound).

[&] TP removal percentages for depths larger than 2.0" were not available because of a lack of corresponding curve data.

Table 5-21. The level of treatment needed in Milford for Scenario III

BMP	Commercial		High-density residential		Industrial		Medium-density residential		Low-density residential		Forest		Open space		Freeway	
	BMP area (ac)	Depth of runoff treated (in)	BMP area (ac)	Depth of runoff treated (in)	BMP area (ac)	Depth of runoff treated (in)	BMP area (ac)	Depth of runoff treated (in)	BMP area (ac)	Depth of runoff treated (in)	BMP area (ac)	Depth of runoff treated (in)	BMP area (ac)	Depth of runoff treated (in)	BMP area (ac)	Depth of runoff treated (in)
Infiltration high-A	0.57	0.60 (91%)	0.30	0.60 (91%)	0.14	0.60 (92%)	0.61	0.60 (90%)	0.58	1.20 (98%)	0.00	0.00	0.00	0.00	0.00	0.00
Infiltration high-B	0.18	1.20 (97%)	0.24	1.20 (97%)	0.09	1.20 (97%)	0.18	0.60 (85%)	0.70	1.20 (96%)	0.28	1.40	0.15	1.21	0.00	0.00
Biofiltration [§]	0.55	0.60 (64%-73%)	0.19	1.20 (79%-92%)	0.45	1.20 (79%-93%)	0.01	0.60 (63%-72%)	0.26	1.20 (76%-90%)	0.03	0.60	0.00	0.00	0.24	0.60
Biofiltration/infiltration-B	2.49	0.64 (75%)	0.26	1.00 (89%)	4.78	1.00 (89%)	1.27	1.00 (88%)	0.64	0.60 (75%)	1.47	1.00	0.10	0.64	1.09	0.64
Shallow filtration-C	0.76	0.25 (43%)	9.96	1.21 (79%)	2.49	1.20 (79%)	12.73	1.00 (75%)	1.38	0.72 (65%)	0.30	0.70	0.16	1.20	0.09	1.20
Shallow filtration-D	0.47	0.50 (57%)	0.06	0.33 (44%)	0.17	1.20 (79%)	0.59	0.72 (65%)	0.35	0.50 (57%)	0.00	0.00	0.00	0.00	0.00	0.00
Impervious, possible PP	1.49	0.24 (74%)	0.00	0.00	0.82	0.15 (75%)	0.08	0.42 (73%)	0.02	0.42 (71%)	0.11	1.00	0.00	0.00	0.04	0.40
WQ swale, wetland ^{&}	4.27	5.76	0.10	5.76	1.33	5.04	0.44	4.32	0.33	1.44 (27%)	0.53	5.80	0.27	5.76	0.00	0.00
BMP							BMP area (ac)				Depth of runoff treated (in)					
Neighborhood gravel wetland-Yes							0.23				0.77 (58%)					
Neighborhood gravel wetland-Likely							6.41				0.93 (59%)					
Neighborhood gravel wetland-Possible							5.62				1.14 (62%)					
Neighborhood gravel wetland -Rare							4.84				1.24 (63%)					

[§] No direct curve data for biofiltration; range was an estimation based on bioretention (lower bound) and infiltration trench (higher bound).

[&] TP removal percentages for depths larger than 2.0" were not available because of a lack of corresponding curve data.

5.7 Summary and Conclusions

Three stormwater management scenarios were set up and optimized using BMPDSS in Bellingham, Franklin, and Milford—the three Upper Charles River communities. The optimization processes accounted for BMP effectiveness, BMP construction costs, land use cover, soil conditions, slope, and, in some cases, the possibility of neighborhood BMPs when developing feasible stormwater management alternatives. The optimization target was to identify the near-optimal BMP implementation alternative, which has the lowest total cost while meeting the phosphorus TMDL reduction target. One benchmark BMP setup with uniform sizing (without optimization) was also established for each community for comparing relative changes in project costs and phosphorus reductions. The setups of the three scenarios and the uniform sizing strategy are summarized in Table 5-22 below. The setup schemes differ in the aspects of runoff routing, implementing regional BMPs, and using optimization techniques.

Table 5-22. Summary of scenario setups in the three Upper Charles River communities

Scenarios	Runoff routing	Regional BMP	Optimization
Uniform sizing strategy	<ul style="list-style-type: none"> Runoff from all impervious HRUs is routed to corresponding management categories 	No	No
Scenario I	<ul style="list-style-type: none"> Runoff from all impervious HRUs is routed to corresponding management categories 	No	Yes
Scenario II	<ul style="list-style-type: none"> Runoff from all impervious PROWs is routed to neighborhood BMPs Runoff from the rest of the impervious HRUs is routed to corresponding management categories 	Yes	Yes
Scenario III	<ul style="list-style-type: none"> Runoff from impervious and pervious PROWs is routed to neighborhood BMPs Runoff from the rest of the impervious and pervious HRUs is routed to corresponding management categories 	Yes	Yes

Table 5-23 has a summary of the total costs for the three scenarios compared against the costs in the uniform sizing strategy. As shown, the Scenarios I, II, and III all have a lower total cost as compared to the cost in the uniform sizing strategy. For example in Milford, the cost of the uniform sizing strategy is about three times, or 286 percent, of the Scenario III total cost. Such significant differences indicate that optimization is essential for rational stormwater management, and the optimization techniques can help achieve considerable savings as compared to the uniform sizing strategy.

The near-optimal BMP implementation scenarios were back-calculated to help identify the level of treatment (total BMP area and depth of runoff) needed for each source area. The back-calculation indicates that BMPs with higher efficiencies in phosphorus removal, located in areas of high phosphorus loads, tend to have larger sizes in the near-optimal BMP implementation scenario. In other words, the optimizer helps to identify the more cost-effective method(s) to meet the phosphorus reduction goal in a community. The back-calculation results indicate that different source areas in a community should implement different levels of treatment according to the near-optimal BMP implementation scenario, and the stormwater management program needs to be flexible enough to allow, and even to encourage, such tradeoffs.

Table 5-23. Summary of total costs for the BMP scenarios

Community	Scenario I cost (million)	Scenario II cost (million)	Scenario III cost (million)	Uniform sizing strategy			
				Cost (million)	Compare to other scenarios		
					I	II	III
Bellingham	\$14	\$9	\$8	\$22	157%	244%	275%
Franklin	\$45	\$30	\$26	\$71	158%	236%	273%
Milford	\$31	\$26	\$21	\$60	194%	231%	286%

The cost estimates in this study are intended only to help illustrate relative differences among various treatment options, and the cost values should not be taken literally. The analysis did not differentiate between impervious surfaces owned by the communities and other government entities and those owned privately. Only the traditional structural BMPs were employed in the analysis. The estimations are likely to be conservative because they are solely based on the construction cost. Given that the optimized costs are still quite high, implementation of a near-optimal solution would take time and could require developing institutions to fund and manage the work.

This study shows that the right-hand side of the cost curves are steep, indicating an upper limit of the phosphorus removal regardless of how much more money is spent on structural BMPs. The limit is about 70 percent for the three communities. The limit is partially a function of the load coming from forest areas for which no treatment is provided, and the forest phosphorus load is about 24 percent of the total nonpoint source load in a community. The steepness of the curve also suggests that there might be considerable savings if nonstructural BMPs and or innovative BMPs (e.g., a phosphorus ban in fertilizers) could be proven effective and, thus, could eliminate the need for more expensive structural projects.

This study does not reflect ongoing research and technologies about practices other than structural BMPs for phosphorus removal. Future changes in BMP costs and designs, as well as in stormwater regulations will necessitate rerunning of the optimization framework, which will likely result in updated total cost values. However, this study lays down the basis for such activities and provides a snapshot of the optimal management options based on the currently available information.

Acknowledgments

The authors of this report, Tham Saravanapavan and Guoshun Zhang, would like to acknowledge the continual guidance, support, and supervision from Brian Brodeur, the GIS Program Director at the Massachusetts Department of Environmental Protection (MassDEP) and Mark Voorhees, the Work Assignment Manager (WAM), of the U.S. Environmental Protection Agency (EPA). The study has been a collaborative effort among Tetra Tech, Inc.; EPA New England; MassDEP; and the three Massachusetts communities of Bellingham, Franklin, and Milford. The authors acknowledge the following individuals for their support during the study.

- Barry Lariviere, Town of Bellingham Conservation Commission
- Denise Zambrowski, Environmental Affairs Coordinator, Franklin
- Donald DiMartino, Public Works Director, Bellingham
- Glenn Hass, Massachusetts Department of Environmental Protection
- James Esterbrook, GIS Manager, Franklin
- Jeffrey Nutting, Town Manager, Franklin
- Jerry Schoen, University of Massachusetts, Amherst
- Larry Dunkin, Town Planner, Milford
- Michael Santora, Town Engineer, Milford
- Paula Rees, University of Massachusetts, Amherst
- Robert A. (Brutus) Cantoregg, Public Works Director, Franklin
- Rosalic Starvish, Baystate Environmental Consultants, Inc.
- Steve Silva, U.S. Environmental Protection Agency, New England

The authors also would like to acknowledge Dr. Mow-Soung Cheng of Prince George's County, Maryland, and Leslie Shoemaker, Greg Mallon, Andrew Parker, Jenny Zhen, Khalid Alvi, and Jeff Strong of Tetra Tech, Inc., for their support in this study.

6 References

- Behera, P.K., B.J. Adams, and J.Y. Li. 2006. Runoff quality analysis of urban catchments with analytical probabilistic models. *Journal of Water Resources Planning and Management* 132(1):4–14.
- Bongartz, K. 2003. Applying different spatial distribution and modeling concepts in three nested mesoscale catchments of Germany. *Physics and Chemistry of the Earth* 28: 1343–1349.
- Budd, L.F., and D.W. Meals. 1994. *Draft Final Report. Lake Champlain Nonpoint Source Pollution Assessment*. LCBP Technical Report No. 6A. Lake Champlain Basin Program, Grand Isle, VT.
- CWP (Center for Watershed Protection). 2007. Manual 3: Urban stormwater retrofit practices, Version 1.0. Appendix E, Derivation of Unit Costs for Stormwater Retrofits and New Stormwater Treatment Construction. Center for Watershed Protection, Ellicott City, MD.
- Flügel, W.A. 1997. Combining GIS with regional hydrological modeling using hydrological response unit (HRUs): An application from Germany. *Mathematics and Computers in Simulation* 43:297–304.
- MassDEP (Massachusetts Department of Environmental Protection), and USEPA (U.S. Environmental Protection Agency). 2007. *Final Total Maximum Daily Load for Nutrients in the Lower Charles River Basin, Massachusetts*. Massachusetts Department of Environmental Protection, Worcester, MA.
- MassDEP (Massachusetts Department of Environmental Protection). 2008. *Structural BMP Specifications for the Massachusetts Stormwater Handbook*. Volume 2, Chapter 2. Massachusetts Department of Environmental Protection, Worcester, MA.
- Mattson, M.D., and R.A. Isaac. 1999. Calibration of phosphorus export coefficients for Total Maximum Daily Loads of Massachusetts's lakes. *Lake Reservoir Management* 15:209–219.
- NCSU (North Carolina State University). 2003. *An Evaluation of Costs and Benefits of Structural Stormwater Best Management Practices in North Carolina*. North Carolina State University, Raleigh, NC.
- Rossman, L.A. 2007. *Stormwater Management Model User's Manual*, Version 5.0. EPA/600/R-05/040. U.S. Environmental Protection Agency, National Risk Management Research Laboratory, Cincinnati, OH.
- Sample, D.J., J.P. Heaney, L.T. Wright, C.Y. Fan, F.H. Lai, and R.F. Field. 2003. Costs of best management practices and associated land for urban stormwater control. *Journal of Water Resources Planning and Management* 129 (1):59–68.
- Shaver, E., R. Horner, J. Skupien, C. May, and G. Ridley. 2007. *Fundamentals of Urban Runoff Management: Technical and Institutional Issues*. North American Lake

- Management Society, Madison, WI, in cooperation with the U.S. Environmental Protection Agency.
- Tetra Tech. 2005. *BMP/LID Decision Support System for Watershed-Based Stormwater Management: User's Guide*. Prepared for Prince George's County, Department of Environmental Resources, by Tetra Tech, Inc., Fairfax, VA.
- Tetra Tech. 2008. *Stormwater best management practices (BMPs) performance analysis*. Prepared for the U.S. Environmental Protection Agency Region 1 by Tetra Tech, Inc., Fairfax, VA.
- UNHSC (University of New Hampshire Stormwater Center). 2007. *2007 Annual Report*. University of New Hampshire Stormwater Center, Durham, NH.
- USEPA (U.S. Environmental Protection Agency). 1999. *Preliminary Data Summary of Urban Stormwater Best Management Practices*. EPA-821-R-99-012. U.S. Environmental Protection Agency, Washington DC.

Appendix A. HRU Maps in the Three Charles River Communities

The HRU maps for the three Upper Charles River communities are shown in Figures A-1 through A-3.

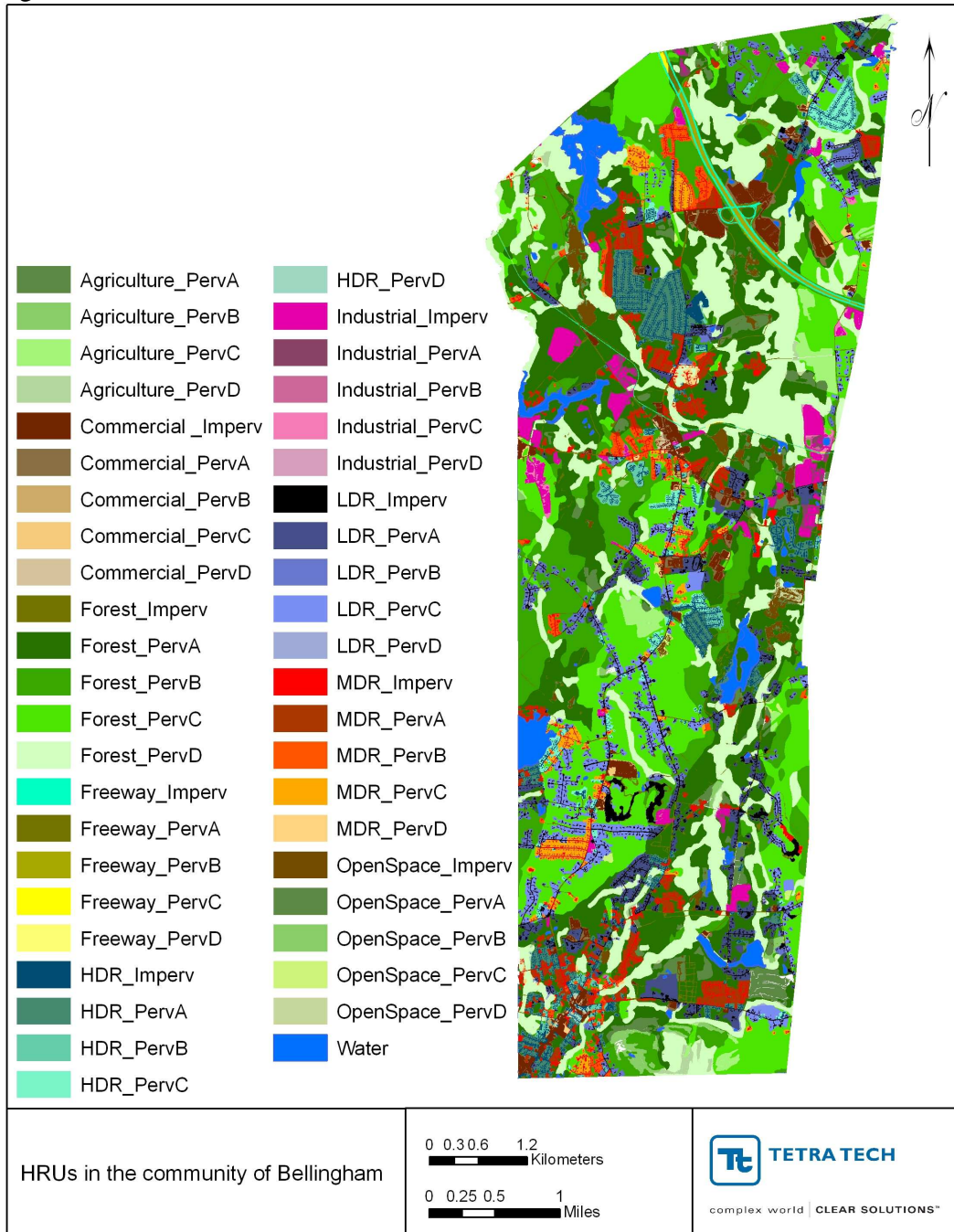

Figure A-1. The HRU map for the community of Bellingham.

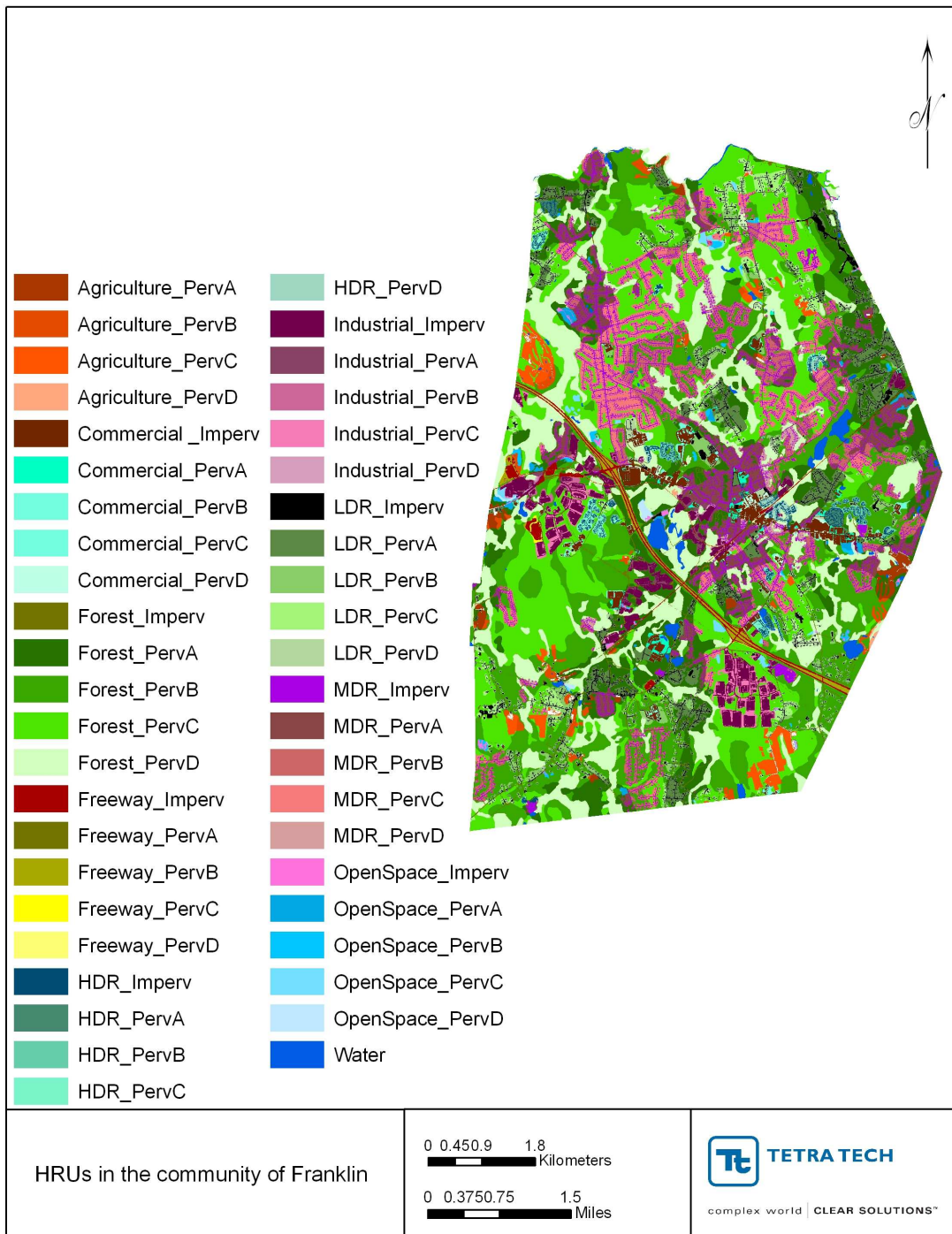

Figure A-2. The HRU map for the community of Franklin.

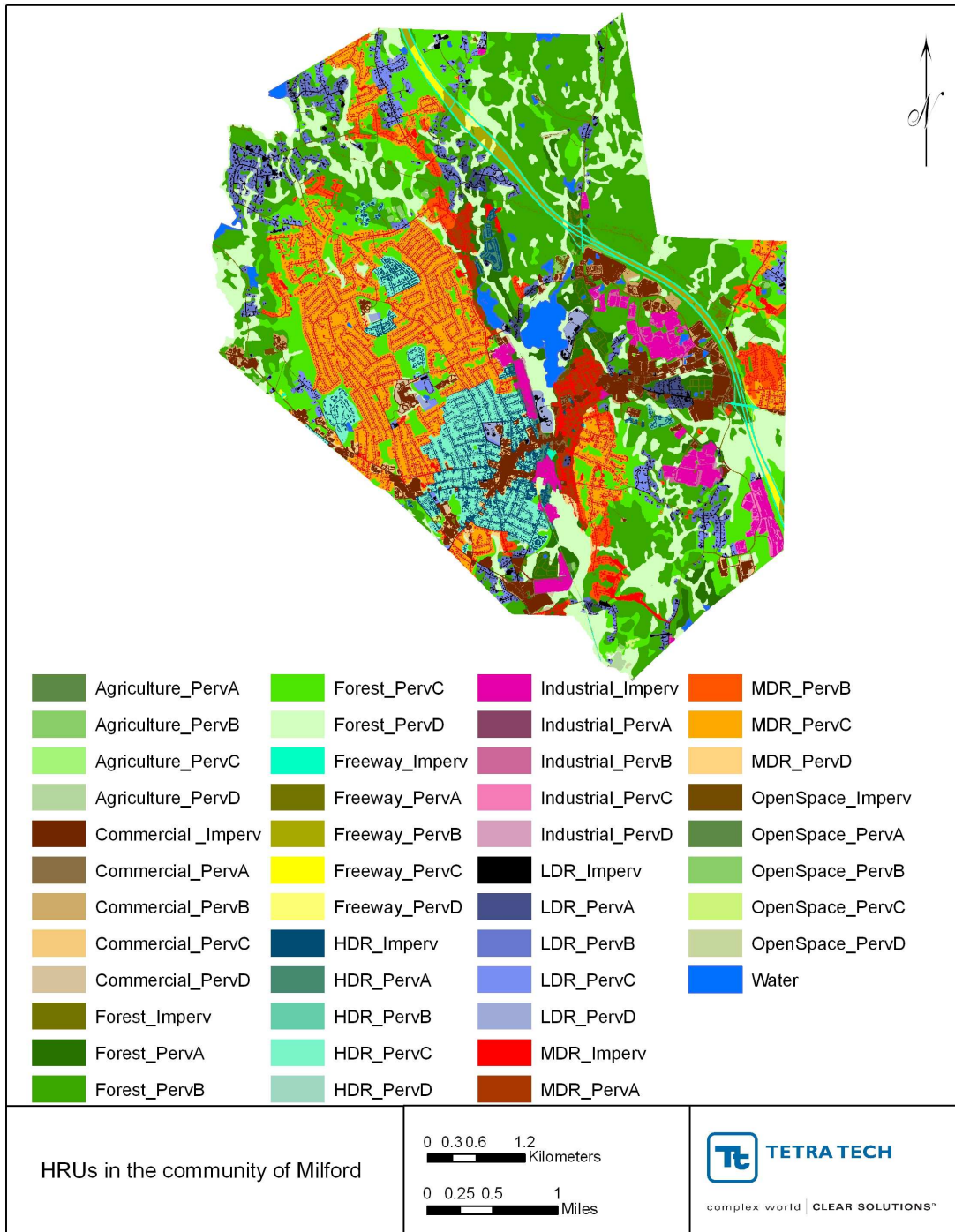

Figure A-3. The HRU map for the community of Milford.

Appendix B. Management Category Maps in the Three Upper Charles River Communities

The management category maps for the communities of Bellingham, Franklin, and Milford, are shown below in Figures B-1 through B-3.

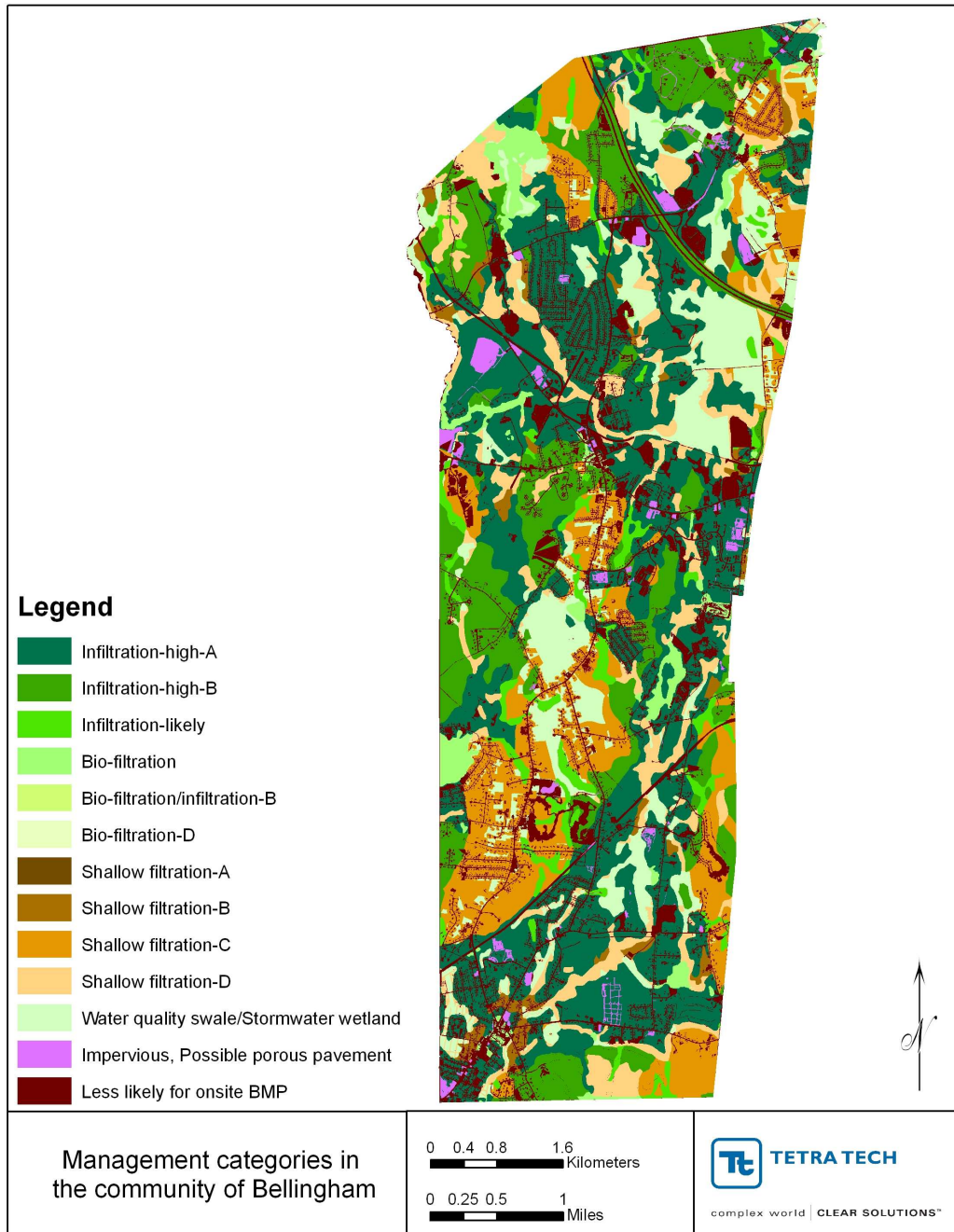

Figure B-1. The management categories in Bellingham.

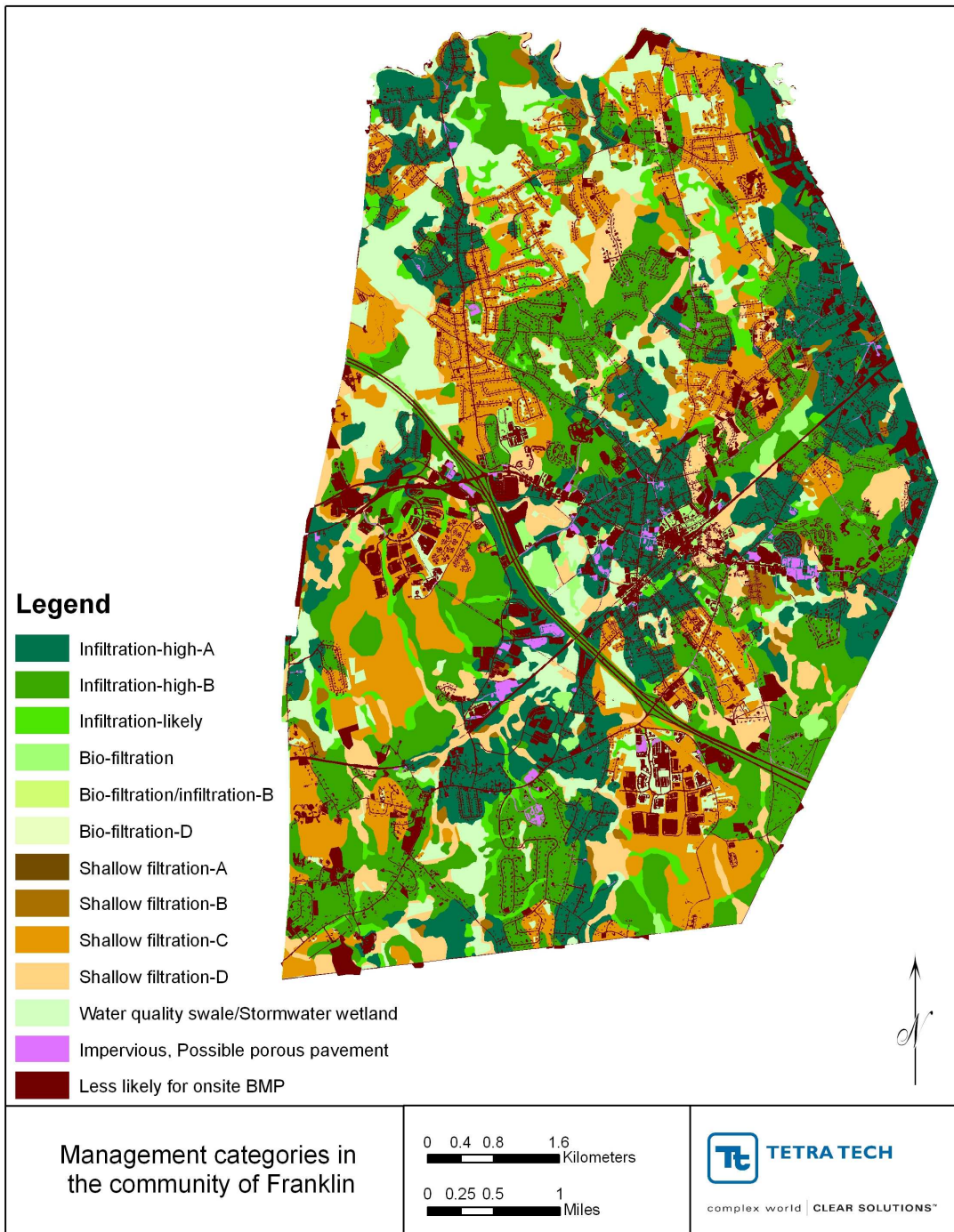

Figure B-2. The management categories in Franklin.

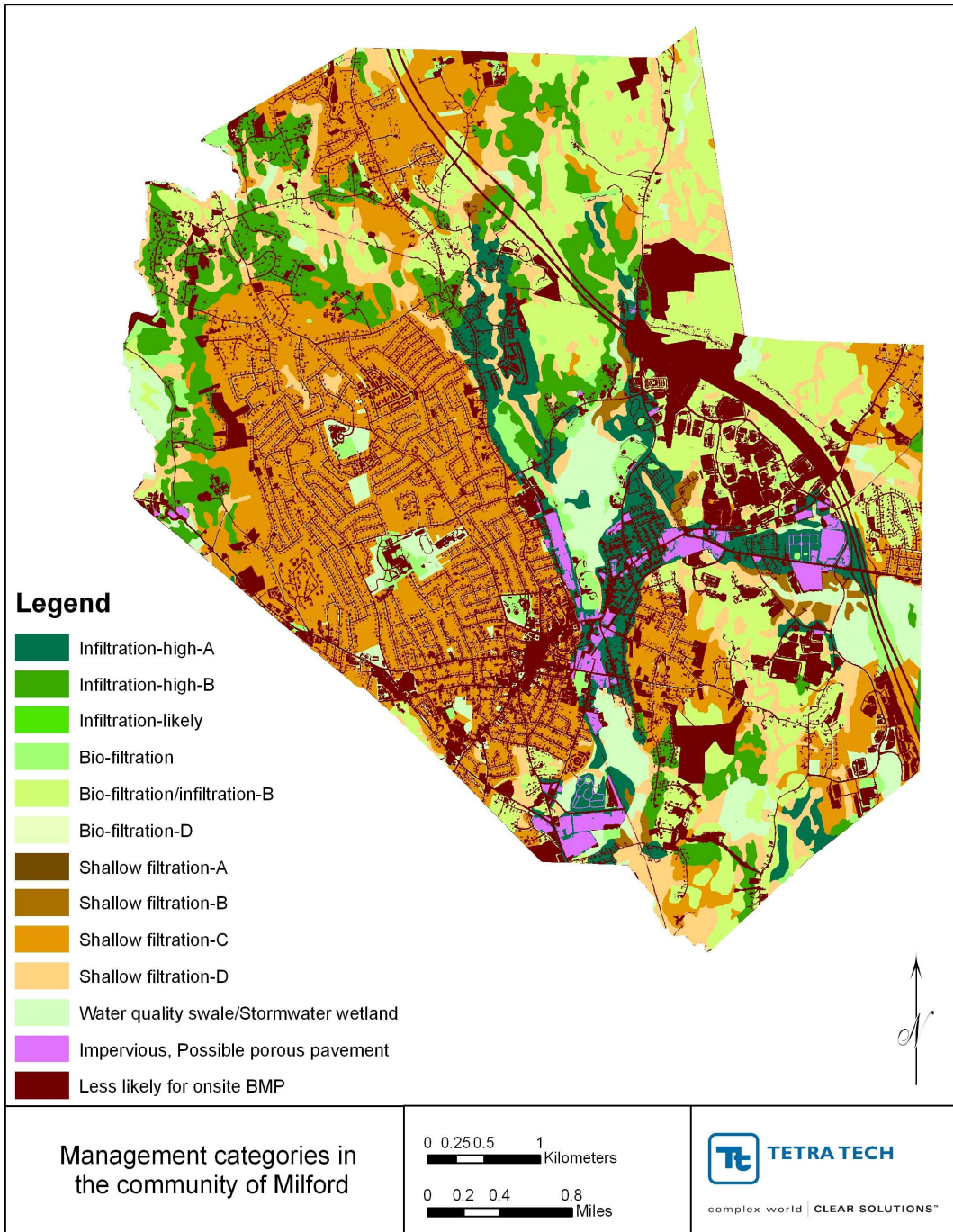

Figure B-3. The management categories in Milford.