

**Laboratory Study of Polychlorinated Biphenyl (PCB) Contamination and  
Mitigation in Buildings**

*Part 1. Emissions from Selected Primary Sources*

Zhishi Guo, Xiaoyu Liu, and Kenneth A. Krebs  
U.S. Environmental Protection Agency  
Office of Research and Development  
National Risk Management Research Laboratory  
Air Pollution Prevention and Control Division  
Research Triangle Park, NC 27711

and

Rayford A. Stinson, Joshua A. Nardin, Robert H. Pope, and Nancy F. Roache  
ARCADIS, US Inc.  
4915 Prospectus Dr., Suite F  
Durham, NC 27709

## **NOTICE**

This document has been reviewed internally and externally in accordance with the U.S. Environmental Protection Agency policy and approved for publication. Mention of trade names or commercial products does not constitute endorsement or recommendation for use.

## **Forward**

The U.S. Environmental Protection Agency (EPA) is charged by Congress with protecting the Nation's land, air, and water resources. Under a mandate of national environmental laws, the Agency strives to formulate and implement actions leading to a compatible balance between human activities and the ability of natural systems to support and nurture life. To meet this mandate, EPA's research program is providing data and technical support for solving environmental problems today and building a science knowledge base necessary to manage our ecological resources wisely, understand how pollutants affect our health, and prevent or reduce environmental risks in the future.

The National Risk Management Research Laboratory (NRMRL) is the Agency's center for investigation of technological and management approaches for preventing and reducing risks from pollution that threaten human health and the environment. The focus of the Laboratory's research program is on methods and their cost-effectiveness for prevention and control of pollution to air, land, water, and subsurface resources; protection of water quality in public water systems; remediation of contaminated sites, sediments and ground water; prevention and control of indoor air pollution; and restoration of ecosystems. NRMRL collaborates with both public and private sector partners to foster technologies that reduce the cost of compliance and to anticipate emerging problems. NRMRL's research provides solutions to environmental problems by: developing and promoting technologies that protect and improve the environment; advancing scientific and engineering information to support regulatory and policy decisions; and providing the technical support and information transfer to ensure implementation of environmental regulations and strategies at the national, state, and community levels.

This publication has been produced as a continued effort to support the EPA's mission of protecting human health and the environment. It is published and made available by EPA's Office of Research and Development to assist the user community and to link researchers with their clients.

Cynthia Sonich-Mullin, Director  
National Risk Management Research Laboratory

## Executive Summary

### Background

In recent years, EPA has learned that caulking materials containing potentially harmful polychlorinated biphenyls (PCBs) were used in many buildings, including schools, in the 1950s through the 1970s. On September 25, 2009, EPA announced new guidance for school administrators and building managers with important information about managing PCBs in caulk and tools to help minimize possible exposure. EPA also announced additional research into this issue to address several unresolved scientific questions that must be better understood to assess the magnitude of the problem and identify the best long-term solutions. For example, the link between the concentrations of PCBs in caulking materials and PCBs in the air or dust is not well understood. The Agency is also conducting research to determine the sources and levels of PCBs in schools and to evaluate different strategies to reduce exposures. The results of this research will be used to provide further guidance to schools and building owners as they develop and implement long-term solutions (U.S. EPA, 2009). The EPA research on PCBs in schools is designed to identify and evaluate potential sources of PCBs in order to better understand exposures to children, teachers, and other school workers, and to improve risk management decisions. Specific research areas include characterization of potential sources of PCB exposures in schools (caulk, coatings, light ballasts, etc.), investigation of the relationship of these sources to PCB concentrations in air, dust, and soil, and evaluation of methods to reduce exposures to PCBs in caulk and other sources (U.S. EPA, 2010).

As part of the EPA research effort, this report summarizes the test results for PCB emissions from primary indoor sources, with emphasis on PCB-containing caulking materials and light ballasts, and the factors that may affect the emissions. Subsequent reports will discuss the research results on PCB transport in buildings and evaluation of selected mitigation methods.

### Objectives

The main objectives of this study were to seek a general understanding of the behaviors of the primary PCB sources in buildings, especially caulking materials and light ballasts, to support risk management decision making by providing new data and models for ranking the primary sources of PCBs, and to support the development and refinement of exposure assessment models for PCBs, such as the Stochastic Human Exposure and Dose Simulation (SHEDS) model (Zartarian et al., 2008), by reducing uncertainty in the models.

### Methods

The rates of PCB congener emissions from caulking materials and light ballast were determined according to the principles described in ASTM Standard Guide 5116 — Standard Guide for Small-Scale Environmental Chamber Determinations of Organic Emissions from Indoor Materials/Products (ASTM, 2010). Caulk samples were tested in a micro-chamber system consisting of six 44-mL Silicosteel® coated stainless steel chambers (Figure E.1). Light ballasts were tested in 53-liter environmental chambers (Figure E.2). During the test, clean air passed through the chamber at a constant rate. Air samples were collected

from the outlet of the chamber. To test the ballasts with electrical load, one 53-liter chamber was modified to allow the ballast inside the chamber to be connected to the lamps located outside the chamber.



**Figure E.1. The micro chamber system with air sampling cartridges**



**Figure E.2. Two 53-liter environmental chambers in the temperature-controlled incubator**

## **Findings**

In this report, the word “caulk” is used as a generic term for all types of caulking materials and sealants found in buildings. Among the thirteen caulk samples tested, twelve were from PCB contaminated buildings and the remaining one was made in the laboratory. Eleven out of the 12 field caulk samples were determined

to contain Aroclor 1254 and the remaining sample was determined to contain Aroclor 1260. The Aroclor concentrations in the caulk ranged from <10 to 136000  $\mu\text{g/g}$  with a mean of 50300  $\mu\text{g/g}$  and a median of 42600  $\mu\text{g/g}$ .

The experimentally determined emission factors (i.e., the emission rate per unit area) showed that, for a given PCB congener, there is a linear correlation between the emission factor and the concentration of the congener in the source (Figure E.3 and Equation E.1). Furthermore, the coefficient ( $a_i$ ) in Equation E.1 is related to the vapor pressure of the congener (Equation E.2).

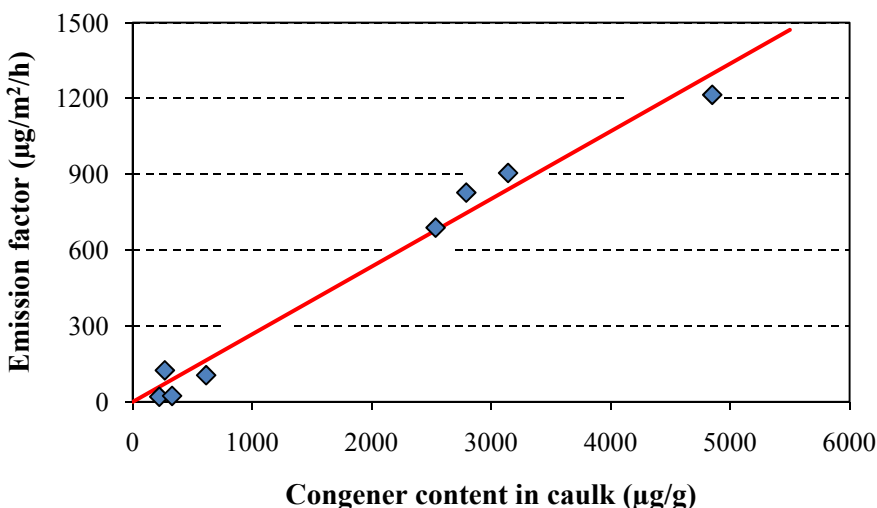

**Figure E.3. Emission factor for congener #52 as a function of congener content in caulk ( $r^2 = 0.9816$ ;  $n = 8$ )**

$$E_i = a_i x_i \tag{E.1}$$

$$a_i = 1805 P_i \tag{E.2}$$

where  $E_i$  = emission factor for congener  $i$  ( $\mu\text{g/m}^2/\text{h}$ )  
 $x_i$  = content of congener  $i$  in caulk sample ( $\mu\text{g/g}$ )  
 $a_i$  = a constant specific to congener  $i$  [ $(\mu\text{g/m}^2/\text{h}) / (\mu\text{g/g})$ ]  
 $P_i$  = vapor pressure of congener  $i$  (torr)

When compared to the congener profiles of caulk samples, the congener profiles of air samples are skewed toward the congeners that are more volatile. A log-linear correlation exists between the vapor pressure of the congener and the normalized emission factor (Equation E.3, Figure E.4), which is defined as the emission factor for a congener when its concentration in the caulk is 1000  $\mu\text{g/g}$ .

$$\ln N_{Ei} = 14.02 + 0.976 \ln P_i \tag{E.3}$$

where  $N_{Ei}$  = normalized emissions factor for congener  $i$  ( $\mu\text{g}/\text{m}^2/\text{h}$ )  
 $P_i$  = vapor pressure for congener  $i$  (torr)

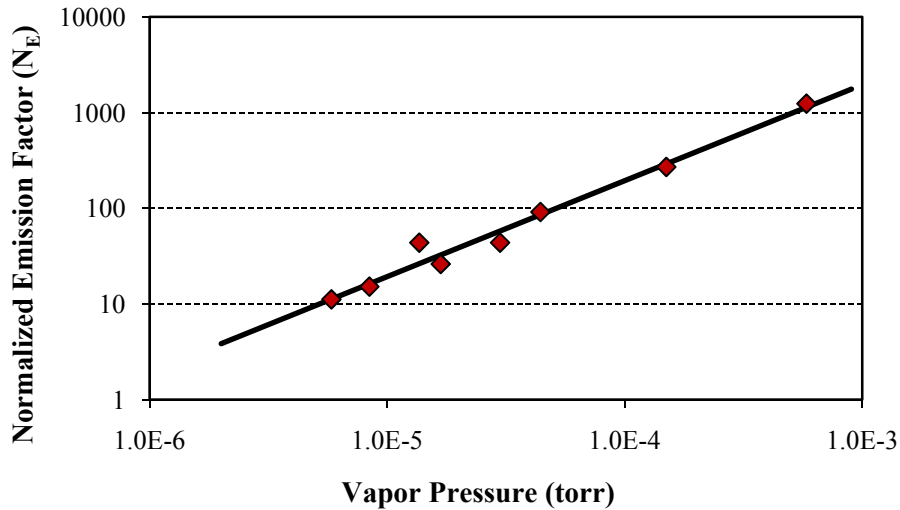

**Figure E.4. Normalized emission factor as a function of vapor pressure for eight target congeners in a caulk sample ( $r^2 = 0.9748$ )**

These correlations (Equations E1 to E3) provide a tool for predicting the congener emissions from caulk once the congener concentrations in the caulk are determined. This tool can be used to rank the PCB sources and to estimate the PCB concentration in air due to the contribution from PCB-containing caulk.

PCB fluids, such as Aroclor 1242, were once used as dielectric heat transferring liquids in the capacitor of light ballasts for fluorescent lamps. Thus, PCB-containing light ballasts are a potential source of PCBs in buildings. Nineteen light ballasts were tested. None of them were marked “PCB Free”, “No PCBs”, or “Non PCB”, and none of them had visible fluid leakage. These samples represent thirteen different models from five manufacturers. Some of them are shown in Figure E.5. Three light ballasts were opened after the emission test to collect the fluids in the capacitor. All three fluids were identified as Aroclor 1242. The PCB emissions from light ballasts were relatively low with or without electrical load at or near room temperature. However, the PCB emission rate increased significantly as the temperature increased. Given that most light ballasts are located in enclosures and may operate at elevated temperature, the emission rate can be higher. One ballast unit failed during a chamber test with electrical load, causing the release of the PCB fluid from the capacitor (Figure E.6) and leaking of the potting material (Figure E.7). Such an event could cause severe indoor environmental contamination. MacLeod (1981) reported that the concentrations of PCBs in the room where a light ballast burned out were more than 50 times higher than normal (11600 versus 200  $\text{ng}/\text{m}^3$ ) on the day of burnout and that the concentrations remained elevated for three to four months afterward. According to the literature, the failure rate for light ballasts increases drastically when they approach the end of their designed life span (Philips, undated). Thus, the presence of PCB-containing light ballasts in buildings may pose a potential risk to the occupants because most existing PCB-containing light

ballasts have approached or exceeded their designed service life and because the decontamination process is both difficult and costly.



**Figure E.5. Part of the light ballasts tested; for comparison, a modern light ballast, marked “PCB-free”, is shown on the far right**

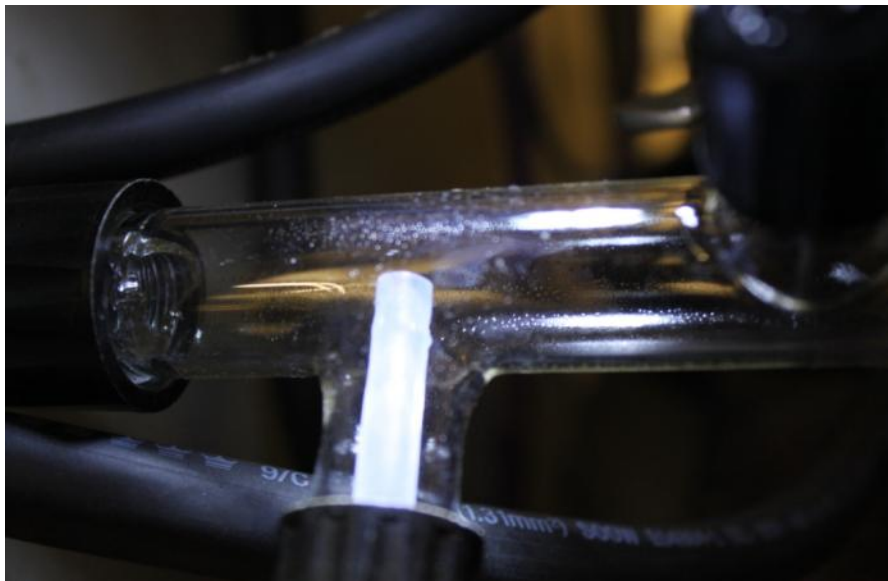

**Figure E.6. Condensation of fluids in the chamber outlet manifold after the failure of the light ballast**





**Figure E.7. The light ballast that burst during the emission test with electrical load**

### **Study Limitations**

This study was conducted in a relatively short period of time and only a few samples were tested. It was not our intention to collect and test samples that are statistically representative of the primary sources in U.S. building stock or to link the test results to the buildings from which the samples were collected. Over a dozen types of primary sources have been identified in PCB-contaminated buildings. Only caulk, light ballasts, and ceiling tiles were tested in this study because of the unavailability of other types of samples and time constraints.

### **References**

ASTM (2010). ASTM D5116-10 Standard guide for small-scale environmental chamber determinations of organic emissions from indoor materials/products, ASTM International, West Conshohocken, PA.

MacLeod, K. (1981). Polychlorinated biphenyls in indoor air, *Environmental Science & Technology*, 15: 926-928.

Philips (undated). Ballast life calculations, Technical note TN 005, Philips.  
[http://www.lighting.philips.com/gl\\_en/global\\_sites/fluor-gear/dimming/download/pdf/technical-notes/tn005.pdf](http://www.lighting.philips.com/gl_en/global_sites/fluor-gear/dimming/download/pdf/technical-notes/tn005.pdf)

U.S. EPA (2009). EPA news release — EPA announces guidance to communities on PCBs in caulk of buildings constructed or renovated between 1950 and 1978 / EPA to gather latest science on PCBs in caulk. <http://yosemite.epa.gov/opa/admpress.nsf/6fa790d452bcd7f58525750100565efa/28c8384eea0e67ed8525763c0059342f!OpenDocument>

U.S. EPA (2010). Research on PCBs in caulk, <http://www.epa.gov/pcbsincaulk/caulkresearch.htm>

Zartarian, V., Glen, G., Smith, L., and Xue, J. (2008). Stochastic human exposure and dose simulation model for multimedia, multipathway chemicals, SHEDS-multimedia model, Version 3 technical manual, U.S. Environmental Protection Agency, EPA 600/R-08/118. [http://www.epa.gov/heads/products/sheds\\_multimedia/sheds\\_mm.html](http://www.epa.gov/heads/products/sheds_multimedia/sheds_mm.html)

## TABLE OF CONTENTS

<b>Forward</b>	<b>i</b>
<b>Executive Summary</b>	<b>ii</b>
<b>List of Tables</b>	<b>xii</b>
<b>List of Figures</b>	<b>xv</b>
<b>Acronyms and Abbreviations</b>	<b>xviii</b>
<b>1. Introduction</b>	<b>1</b>
1.1 Background	1
1.2 Goals and Objectives	3
<b>2. Experimental Methods</b>	<b>4</b>
2.1 Test Specimens	4
2.1.1 Caulk	4
2.1.2 Ceiling Tile	6
2.1.3 Light Ballasts	6
2.2 Test Facilities	9
2.2.1 Micro Chamber	9
2.2.2 Standard 53-Liter Chamber	11
2.2.3 Modified 53-Liter Chamber	12
2.3 Test Procedures	14
2.3.1 Caulk and Ceiling Tiles	14
2.3.2 Light Ballasts	14
2.3.2.1 Screening Testing	15
2.3.2.2 Elevated Temperature Testing	16
2.3.2.3 Live Ballast Testing	16
2.4 Sampling and Analysis	17
2.4.1 Air Sampling	17
2.4.2 Extraction and Sample Preparation	18
2.4.3 Target Compounds	18
2.4.4 Instrument and Analytical Methods	21
<b>3. Quality Assurance and Quality Control</b>	<b>26</b>
3.1 Data Quality Indicator Goals for Critical Measurements	26
3.2 GC/MS Instrument Calibration	27
3.3 Detection Limits	30

3.4	Environmental Parameters	32
3.5	Quality Control Samples	32
3.6	Daily Calibration Check	33
3.7	Recovery Check Standards	33
3.8	Comparison of Extraction Methods	34
<b>4.</b>	<b>Results</b>	<b>36</b>
4.1	Caulk	36
4.1.1	PCB Content in Caulk Samples	36
4.1.2	Summary of the Micro Chamber Tests	38
4.1.3	General Emission Patterns	38
4.1.4	Calculation of the Emission Rates and Emission Factors	40
4.1.5	Dependence of the Emission Factor on Congener Content in Caulk Samples	43
4.1.6	Dependence of Congener Emissions on Vapor Pressure (1) — the P-N Correlation	44
4.1.7	Dependence of Congener Emissions on Vapor Pressure (2) — the P-S Correlation	46
4.1.8	Temperature Dependence of the Emission Factor	47
4.1.9	The Difference between the Exposed and Freshly-cut Caulk Surfaces	50
4.1.10	Emission Factors for Aroclors	53
4.2	Ceiling Tiles	56
4.3	Light Ballasts	59
4.3.1	Test Summary	59
4.3.2	Method for Calculating the Emission Rate	60
4.3.3	Screening Tests	60
4.3.4	Live Ballast Tests	61
4.3.5	Effect of Ambient Temperature	63
4.3.6	Emissions from a Burst Light Ballast	64
4.3.7	Inside the Ballasts	70
4.3.7.1	Physical Descriptions	70
4.3.7.2	Analytical Results	75
<b>5.</b>	<b>Discussion</b>	<b>79</b>
5.1	Predicting the Emission Factors for PCB-Containing Caulk	79
5.1.1	Using the x-E Correlation (Method 1)	79
5.1.2	Using the P-N Correlation (Method 2)	79

5.1.3	Predictive Errors	79
5.1.4	Method Selection	80
5.1.5	Predicting the Emission Factors for Aroclor 1254	80
5.1.6	Estimating the Air Concentration Due to Emissions from Caulk	81
5.2	Using the Advanced Emission Models for Emissions from Caulk and Other Building Materials	81
5.3	Using the Emissions Data for Light Ballasts	83
5.4	Expressing the PCB concentrations as Aroclors	84
5.5	Study Limitations	85
<b>6.</b>	<b>Conclusion</b>	<b>87</b>
	<b>Acknowledgments</b>	<b>88</b>
	<b>References</b>	<b>89</b>
	<b>Appendix A Test Conditions for Caulk Samples and Determination of PCB Concentrations</b>	<b>94</b>
	<b>Appendix B Test Conditions for Light Ballasts</b>	<b>99</b>
	<b>Appendix C Simulating the Long-term PCB Emissions from Caulk</b>	<b>102</b>
	<b>Appendix D Simulation of a Failed Light Ballast</b>	<b>105</b>

## List of Tables

Table 2.1.	Summary of caulk samples	5
Table 2.2.	Summary of light ballast samples	8
Table 2.3.	Conditions and reasons for testing PCB emissions from light ballasts	15
Table 2.4.	Chemical names and CAS Registration Numbers for the PCB congeners analyzed	20
Table 2.5.	Chemical names and CAS Registration Numbers for the internal standards and recovery check standards	21
Table 2.6.	Operating conditions for the Agilent 6890/5973N GC/MS/ CTC PAL Auto Sampler System for the analysis of PCB congeners in Aroclor 1254	22
Table 2.7.	Operating conditions for the Agilent 6890/5973N GC/MS/ CTC PAL Auto Sampler System for the analysis of PCB congeners in Aroclor 1242 and Aroclor 1248	23
Table 2.8.	Operating conditions for the Agilent 6890/5973N GC/MS/ Agilent 7683 Auto Sampler System for the analysis of PCB congeners in Aroclor 1254	23
Table 2.9.	SIM acquisition parameters for the Agilent 6890/5973N GC/MS for the analysis of PCB congeners in Aroclor 1254	24
Table 2.10.	SIM acquisition parameters for the Agilent 6890/5973N GC/MS for the analysis of PCB congeners in Aroclor 1242 and Aroclor 1248	25
Table 3.1.	Data quality indicator goals for critical measurements	26
Table 3.2.	Objectives for small chamber operating parameters	27
Table 3.3.	Objectives for micro chamber systems operating parameters	27
Table 3.4.	GC/MS calibration for PCB congeners from Aroclor 1254	28
Table 3.5.	GC/MS calibration for PCB congeners from Aroclor 1242 and 1248	29
Table 3.6.	IAP results for each calibration	30
Table 3.7.	Instrument detection limits (IDLs) for PCB congeners for the PUF Soxhlet method	31
Table 3.8.	Method detection limits (MDLs) of the PUF Soxhlet extraction method for PCB congeners on GC/MS	32
Table 3.9.	Average recoveries of DCCs for small chamber and micro chamber tests	34
Table 3.10.	Comparison of extraction methods	35
Table 4.1.	Concentrations of target congeners and Aroclors in caulk samples	37
Table 4.2.	Calculated emission factors (E) and normalized emission factors ( $N_E$ ) at room temperature	41
Table 4.3.	Estimated constants ( $a_i$ ) for the x-E correlation	44
Table 4.4.	Vapor pressures for the target congeners in Aroclor 1254	45
Table 4.5.	Estimated constants $b_1$ and $b_2$ in Equation 4.5	46

Table 4.6.	Constants $d_1$ and $d_2$ in the N-T correlation for caulk sample CK-11 and CK-13	50
Table 4.7.	Emission factors ( $\mu\text{g}/\text{m}^2/\text{h}$ ) for the exposed surface ( $E_s$ ) and the newly cut surface ( $E_0$ ) for caulk CK-01	52
Table 4.8.	Emission factors ( $\mu\text{g}/\text{m}^2/\text{h}$ ) for the exposed surface ( $E_s$ ) and the newly cut surface ( $E_0$ ) for caulk CK-02	52
Table 4.9.	Emission factors ( $\mu\text{g}/\text{m}^2/\text{h}$ ) for the exposed surface ( $E_s$ ) and the newly cut surface ( $E_0$ ) for caulk CK-12	52
Table 4.10.	Aroclor 1254 concentrations in caulk samples (x) and chamber air (C) and the calculated emission factors (E)	55
Table 4.11.	Concentrations of target congeners in ceiling tile samples	58
Table 4.12.	Congener emission rates for light ballasts at room temperature and without electrical load	61
Table 4.13.	Rates of congener emission from ballasts with electrical load	62
Table 4.14.	Estimated constants ( $f_1$ and $f_2$ ) for the effect of ambient temperature on congener emissions from light ballasts	65
Table 4.15.	Concentrations of target congeners in chamber background ( $C_0$ ), during the live test (C) and the calculated emission rates (R) for ballast BL-08	68
Table 4.16.	Concentrations of target congeners in chamber air seven days after the burst of ballast BL-08 and the calculated average emission rates (R)	68
Table 4.17.	PCB content in the gel-like material and the tar-like resin collected from the chamber floor	70
Table 4.18.	Congener content in potting material in BL-02	76
Table 4.19.	Congener content in potting material in BL-12	77
Table 4.20.	Congener content in the potting material in the burst ballast (BL-08)	78
Table 5.1.	Predictive error for the x-E and P-N correlations	80
Table 5.2.	Variations of Aroclor concentrations in caulk and air samples calculated based on five individual congeners	85
Table 5.3.	Variations of Aroclor concentrations in air sample for light ballast BL-08 calculated based on five individual congeners	85
Table A.1.	Test conditions for PCB emissions from caulk at room temperature	94
Table A.2.	Test conditions for PCB emissions from caulk at different temperatures	95
Table A.3.	Test conditions for comparing the PCB emissions from different surfaces	95
Table A.4.	Average congener concentrations in chamber air, relative standard deviations, and number of valid data points	96
Table A.5.	Air concentrations at different temperatures for field caulk CK-11	98
Table A.6.	Air concentrations at different temperatures for laboratory-mix caulk CK-13	98

Table B.1.	Summary of conditions for the screening tests	99
Table B.2.	Summary of conditions for the live tests	99
Table B.3.	Summary of test conditions for the effect of ambient temperature	100
Table B.4.	Congener emission rates for four light ballasts at different temperatures	101
Table C.1.	Content in caulk, partition and diffusivity coefficients for four congeners in Aroclor 1254	104
Table D.1.	Physical properties of the congeners used in the simulation	106



## List of Figures

Figure E.1.	The micro chamber system with air sampling cartridges	iii
Figure E.2.	Two 53-liter environmental chambers in the temperature-controlled incubator	iii
Figure E.3.	Emission factor for congener #52 as a function of congener content in caulk	iv
Figure E.4.	Normalized emission factor as a function of vapor pressure for eight target congeners in a caulk sample	v
Figure E.5.	Part of the light ballasts tested; for comparison, a modern light ballast, marked “PCB-free”, is shown on the far right	vi
Figure E.6.	Condensation of fluids in the chamber outlet manifold after the failure of the light ballast	vi
Figure E.7.	The light ballast that burst during the emission test with electrical load	vii
Figure 2.1.	Caulk samples as received	4
Figure 2.2.	Five caulk samples provided by building owners	5
Figure 2.3.	Ceiling tile sample CT-02	7
Figure 2.4.	Seven of the light ballast samples tested; for comparison, a modern light ballast (marked “PCB-free”) is shown on the far right	9
Figure 2.5.	Markes $\mu$ -CTE system with polyurethane foam (PUF) sampling tubes	10
Figure 2.6.	Diagram of a single micro chamber	10
Figure 2.7.	Two small environmental chambers in the temperature-controlled incubator	11
Figure 2.8.	Modified chamber faceplate for live ballast testing	12
Figure 2.9.	Ballast system setup - overhead view	13
Figure 2.10.	Ballast wiring diagram for BL-09 and BL-11	13
Figure 2.11.	Caulk sample in one of the micro-chambers	14
Figure 2.12.	Ballast orientation in the small chamber for screening tests	15
Figure 2.13.	Live ballast with wiring connections	16
Figure 2.14.	Lamp was powered on by the ballast in the chamber	17
Figure 2.15.	Comparison of chromatograms of a field caulk sample and Aroclor 1254 standard solution analyzed by GC/MS	19
Figure 4.1.	Comparison of chromatograms (from top to bottom: Aroclor 1254 standard, caulk CK-09, caulk CK-08, and Aroclor 1260 standard)	36
Figure 4.2.	Comparison of chromatograms: Aroclor 1254, a caulk sample and an air sample	38
Figure 4.3.	Relative abundances of the target congeners for Aroclor 1254	39
Figure 4.4.	Concentration profiles for seven target congeners in chamber air for caulk CK-09 tested at room temperature	39

Figure 4.5.	x-E correlation for congener #52	43
Figure 4.6.	Correlation between the normalized emission factor and vapor pressure for eight target congeners in caulk CK-10	45
Figure 4.7.	Slope of the x-E correlation ( $a_i$ ) as a function of congener vapor pressure	47
Figure 4.8.	Normalized emission factor ( $N_E$ ) as a function of temperature for five congeners in caulk sample CK-11	49
Figure 4.9.	Normalized emission factor ( $N_E$ ) as a function of temperature for five congeners in caulk sample CK-13	49
Figure 4.10.	Caulk samples for testing the PCB emission rates of different surfaces	51
Figure 4.11.	Ratio of the emission factors for the exposed surface ( $E_s$ ) and the newly cut surface ( $E_0$ ) as a function of vapor pressure	53
Figure 4.12.	Emission factor for Aroclor 1254 as a function of Aroclor content in caulk sample	56
Figure 4.13.	Comparison of chromatograms - from top to bottom: Aroclors 1254, 1260, 1262, and 1268 and ceiling tile CT-01	57
Figure 4.14.	Relative abundances of the target congeners in three ceiling tile samples	57
Figure 4.15.	Congener content in the top (with paint) and bottom layers of the ceiling tile	59
Figure 4.16.	Normalized emission factor as a function of vapor pressure for sample CT-03	59
Figure 4.17.	Dependence of congener emission rate on vapor pressure for light ballast BL-09C	63
Figure 4.18.	Effect of ambient temperature on congener emissions from ballast BL-09C	64
Figure 4.19.	Condensation of fluids in the chamber outlet manifold after the failure	66
Figure 4.20.	Comparison of the PUF sampling cartridge for ballast BL-08 to a normal cartridge	66
Figure 4.21.	Temperature profile for chamber air during the live test for ballast BL-08	67
Figure 4.22.	PUF sampling from the sealed 53-L chamber containing the burst ballast	69
Figure 4.23.	Light ballast CK-08 after the burst	69
Figure 4.24.	Ballast BL-02 after the bottom metal plate was removed	71
Figure 4.25.	Ballast BL-02 (top side)	71
Figure 4.26.	Capacitor in ballast BL-02	72
Figure 4.27.	Ballast BL-12 after removing the casing	72
Figure 4.28.	Capacitor in ballast BL-02	73
Figure 4.29.	Ballast BL-08 after removing the bottom metal plate	73
Figure 4.30.	The capacitor in the burst ballast (BL-08)	74
Figure 4.31.	Fluid collected from the ruptured capacitor in ballast BL-08	74
Figure 4.32.	Comparison of chromatograms for Aroclor 1242 standard and fluids in light ballasts BL-02, BL-08, and BL-12	75

Figure 5.1.	Predicted congener concentrations over a 50-year period	82
Figure 5.2.	Percent of congener mass emitted over a 50-year period	83
Figure D.1.	Predicted concentrations of “total PCBs” and congener #18 following light ballast failure	106

## Acronyms and Abbreviations

ACH	air changes per hour
ANZECC	Australian and New Zealand Environment Conservation Council
ASHRAE	American Society of Heating, Refrigerating and Air-Conditioning Engineers
ASTM	American Society for Testing and Materials
ATSDR	Agency for Toxic Substances and Disease Registry
AWG	American wire gauge
CASRN	Chemical Abstract Services Registry Number
DAS	data acquisition system
DCC	daily calibration check
DQI	data quality indicator
EPA	Environmental Protection Agency
GC	gas chromatography
GC/MS	gas chromatography/mass spectrometry
IAP	internal audit program
IS	internal standard
IUPAC	International Union of Pure and Applied Chemistry
LCs	laboratory controls
NIOSH	National Institute for Occupational Safety and Health
PCB	polychlorinated biphenyl
ppm	parts per million
PQL	practical quantification limit
psi	pounds per square inch
PUF	polyurethane foam
QSAR	quantitative structure-activity relationship
RCS	recovery check standard
RH	relative humidity
RSD	relative standard deviation
RTD	resistance temperature detector
SIM	selected ion monitoring
TMX	tetrachloro- <i>m</i> -xylene
UNEP	United Nations Environment Programme
VOC	volatile organic compound
WHO	World Health Organization

# 1. Introduction

## 1.1 Background

Polychlorinated biphenyls (PCBs) are a class of 209 organic compounds, known as congeners, with the chemical formula of  $C_{12}H_{10-x}Cl_x$ , where  $x$  is the number of chlorine atoms in the range of 1 to 10. Different mixtures of these congeners were sold under many brands and trade names worldwide, among which Aroclors marketed by Monsanto Company were the most common trade names in the United States. Commercial production of PCBs started in 1929 and was banned by the U.S. Congress in 1978. According to a report by the National Institute for Occupational Safety and Health (NIOHS), the domestic sales of PCBs by Monsanto Company between 1957 and the first quarter of 1975 were 894 million pounds or approximately 400,000 tons (NIOSH, 1975). The approximate PCB usage in the U.S. included 60% for closed system and heat transfer fluids (e.g., transformers, capacitors, and fluorescent light ballasts), 25% for plasticizers, 10% for hydraulic fluids and lubricants, and 5% for miscellaneous uses (EIP Associates, 1997).

PCBs were once used as plasticizers — substances for providing flexibility and elongation — in caulking materials because of their compatibility with the base resin or binder such as polysulfide and polybutene (Monsanto, undated). According to the U.S. Department of Commerce (2009), these caulking materials could contain up to 30% PCBs. In 1974, the addition of PCBs to caulking materials was discontinued, but the use of existing stocks that contained PCBs continued at construction sites until about 1980. Thus, all buildings that have expansion joints and that were built or renovated between the 1940s and the late 1970s (Some references cited between the 1950s and the 1970s — author) are likely to contain PCBs in the caulking materials.

In the past two decades, a series of field measurements conducted in Europe and North America has shown that PCB-containing caulk and sealant can be a significant source of PCBs in buildings (Europe: Benthe et al., 1992; Balfanz et al., 1993; Piloty and Koppl, 1993; Fromme et al., 1996; Kohler et al., 2005; Priha et al., 2005 and North America: Herrick et al., 2004, 2007; Newman, 2010, Robson et al., 2010). For example, in a study conducted in Berlin (Fromme et al., 1996), the building blueprints and associated documents for public utility buildings, especially schools and childcare centers, were scrutinized and some buildings were investigated to determine whether they contained elastic sealants that contained PCBs. In the suspected buildings, samples of sealant materials and samples of room air were analyzed for PCBs. The air analyses ( $n = 410$ ) in the community rooms of the schools and childcare centers showed that the average concentration of PCBs was  $114 \text{ ng/m}^3$ , the maximum concentration was  $7,360 \text{ ng/m}^3$  and the geometrical mean was  $155 \text{ ng/m}^3$ . About 15% of the school buildings and 3% of the childcare centers had indoor air values of over  $300 \text{ ng/m}^3$ , indicating need for precautionary measures. Five percent of the school buildings were found to have concentrations exceeding  $3,000 \text{ ng/m}^3$ , indicating the need for intervention according to the German government.

In another study, Herrick and his co-workers (Herrick et al., 2004) investigated 24 schools and other public buildings in the Greater Boston area. Eight of these buildings contained caulking materials with PCB content exceeding 50 ppm, ranging from 70.5–36,200 ppm; the mean value was 15,600 ppm. In a university building in which similar levels of PCBs were found in caulking material, the PCB levels in the indoor air ranged from 111 to  $393 \text{ ng/m}^3$ ; in dust taken from the ventilation system of the building, the range was  $< 1$

ppm to 81 ppm. The authors also found that, in seven of the eight buildings with PCB-containing caulk, the PCBs were identified as Aroclor 1254; the remaining sample contained Aroclor 1260.

Light ballasts for fluorescent lamps are also potentially important sources of PCBs in buildings. As the primary electrical components of fluorescent light fixtures, light ballasts are generally located within the fixture under a metal cover plate. A light ballast unit is composed of a transformer to reduce the incoming voltage, a small capacitor (that may contain PCBs), and possibly a thermal cut-off switch and/or safety fuse. A tar-like substance, known as the potting material, is used to surround these components to muffle the noise that is inherent in the operation of the ballast. This substance covers the small capacitor in which liquid PCBs in the ballast would be located. If PCBs are present in the capacitor, the amount ranges from approximately 1 to 1.5 oz (30 to 45 mL) (U.S. EPA, 1993). Another estimate (UNEP, 1999) indicated that the amount of PCBs in ballasts ranges from 50 to 100 grams, which is equivalent to 37 to 74 mL of Aroclor 1242. The ballasts for high intensity discharge (HID) lamps, often used in large facilities such as indoor parking spaces and school gymnasiums, operate at much higher wattage than fluorescent lamps. The capacitors in the HID units are considerably larger than those in a fluorescent fixture. Most HID ballasts contain between 91 and 386 g PCBs (equivalent to 67 to 286 mL of Aroclor 1242) (Environment Canada, 1991).

Over the last thirty years, studies have shown that PCB-containing ballasts could be a significant source of PCBs inside buildings. A recent field study involving three communities in New York State found significant association between the presence of fluorescent lights and the total PCB concentrations in indoor air in the study area (Wilson et al., 2011). When certain types of ballasts reach the end of their useful life, spontaneous leaking and smoking may occur, and this is accompanied by a remarkably objectionable odor that penetrates the area (Staiff et al., 1974; U.S. EPA, 1993; Funakawa et al., 2002; Hosomi, 2005). A study by Staiff et al. (1974) reported PCB concentrations of 12,000 to 18,000 ng/m<sup>3</sup> in room air after the burnout of a ballast, and the concentration was still approximately 1,000 ng/m<sup>3</sup> after three days. MacLeod (1979, 1981) reported that concentrations of PCBs in the rooms containing the burned-out light ballast were more than 50 times higher than normal (11,600 versus 200 ng/m<sup>3</sup>) on the day of burnout and that the concentrations remained elevated for three to four months afterward. According to a study conducted in Japan, the PCB emission rate is highly dependent on temperature. The emission rate increased by a factor of 400 as the temperature increased from 30 to 50 °C (Funakawa et al., 2002; Hosomi, 2005). Therefore, identification and proper removal of PCB-containing ballasts must be considered in any PCB mitigation plan.

Researchers and others have raised concerns over the potential exposure to PCBs in buildings, including schools, because of the high concentrations of PCBs in some buildings and the toxicological effects of PCBs, including carcinogenicity and detrimental effects on the immune, reproductive, nervous and endocrine systems (ATSDR, 2009). EPA's peer reviewed cancer reassessment concluded that PCBs are probable human carcinogens (U.S. EPA, 2008a). On September 25, 2009, the U.S. EPA announced a series of steps that building owners and school administrators should take to reduce exposure to PCBs that may be found in the caulk used in many buildings that were constructed or renovated between 1950 and 1978 (U.S. EPA, 2009). Also, at the present time, the Agency is conducting research to better understand the risks posed by PCB-containing caulk. There are several unresolved scientific issues that must be better understood to assess the magnitude of the problem and to identify the best long-term solutions. For example,

the link between the concentrations of PCBs in caulk and PCBs in the air or dust is not well understood (U.S. EPA, 2009). This research will guide EPA's decisions concerning further recommendations for long-term measures to minimize exposure and decisions concerning the steps that must be taken to prioritize and conduct actions, such as removing the caulk, to protect public health. This report is part of the Agency's research effort. It complements and supplements a field study in school buildings currently conducted by the National Exposure Research Laboratory (NERL, 2010).

## **1.2 Goals and Objectives**

The main goal of this study was to conduct laboratory characterization of the PCB emissions from primary sources in buildings (especially in schools), with a focus on PCB-containing caulk and light ballasts. In addition to determining PCB emission rates, several factors that may have affected the emission rates were evaluated. This laboratory study supplemented and complemented the field measurements in buildings by providing a better understanding of the emission process and by establishing a direct link between the sources and the PCBs in the air. In addition to seeking a general understanding of the behaviors of primary sources of PCBs, this study was designed to: (1) support risk management decision making by providing new data and models for ranking the primary sources of PCBs, and (2) support the development and refinement of exposure assessment models for PCBs, such as the Stochastic Human Exposure and Dose Simulation (SHEDS) model (Zartarian et al., 2008; Stallings et al., 2008), by reducing the uncertainties in PCB emission estimates.

## 2. Experimental Methods

### 2.1 Test Specimens

#### 2.1.1 Caulk

In this report, the word “caulk” is used as a generic term for all types of caulking materials and sealants found in buildings. Thirteen caulk samples were tested. Unless indicated otherwise, all the samples were provided by building owners on a voluntary basis through the offices of EPA Region 1 and Region 2. The sample providers were instructed to wrap each caulk sample with aluminum foil and place it in a sealed plastic bag. Then the samples were placed in a container with ice blocks (Figure 2.1) and shipped to the authors by second-day delivery. Upon receipt, the packages were checked for damage. Then the samples were stored in a freezer at -20 °C.



**Figure 2.1. Caulk samples as received**

Table 2.1 provides a brief description and identification number for each sample. Most samples were in good or fair condition, and were approximately 15-centimeter long with width that varied from 3 to 12 mm. CK-09 was the only sample that had deteriorated severely and was in the form of small pellets (Figure 2.2).



**Table 2.1. Summary of caulk samples**

<b>ID</b>	<b>Description</b>	<b>Color</b>	<b>Notes</b>
CK-01	interior building caulk	gray	
CK-02	interior expansion caulk	off-white	
CK-03	exterior window caulk	gray	
CK-04	interior window caulk	gray	
CK-05	interior window sill caulk	light brown, translucent	
CK-06	interior window sill caulk	brown	
CK-07	interior window sill caulk	brown	
CK-08	interior window frame caulk	brown	
CK-09	interior door frame caulk; deteriorated pellets	gray	
CK-10	interior masonry joint caulk	light gray	[a]
CK-11	interior masonry joint caulk	brown	[a]
CK-12	interior window sill caulk	gray	[a]
CK-13	laboratory mixed two-part polysulfide caulk	gray	[b]

<sup>[a]</sup> This sample was collected by the authors from a pre-demolition public building.

<sup>[b]</sup> Two-part THIOKOL 2235M industrial polysulfide joint sealant for concrete expansion joints. Aroclor 1254 (0.160 g) was spiked into 2.66 g activator (part B), which was then mixed with 20 g polysulfide polymer (part A).



**Figure 2.2. Five caulk samples provided by building owners (sample CK-09 on far right is in an aluminum container)**

For emissions testing, field samples were prepared by cutting approximately 3.5 cm long sections from the strip with a utility knife. The sides of the section were trimmed to form a rectangular cuboid. After the weight and dimensions of the cuboid were determined, five sides of the sample were coated twice with an oil-based primer (Sherwin-Williams), leaving one side exposed to air. The coated sample was placed in a fume hood to allow the primer to cure before emissions testing. Several samples were too thin to create a cuboid, but the exposed side was always a trimmed flat rectangle. Laboratory mixed caulk was prepared to specified dimensions.

To prepare samples for determination of congener content in the caulk, two 1-cm pieces were cut from the field caulk strip. Pieces were then cut into thin (<1 mm thick) slices, which were cross-cut into pellets no larger than 2 mm × 2 mm in size. Duplicate samples, weighing approximately 0.2 g each, were placed in 20-mL amber-glass extraction vials.

### *2.1.2 Ceiling Tile*

Three ceiling tile samples were received and identified as CT-01, CT-02 and CT-03. Each sample was 15 cm by 15 cm in size. The sample storage and shipping procedures were the same as the procedures for the caulk samples. The three samples looked identical and were most likely made from the same type of fiber. They had densities of approximately 0.06 g/cm<sup>3</sup>. One side was painted (Figure 2.3).

For emissions testing, a 3.9-cm punch was used to cut a cylinder from the tile. All the surfaces except the painted side (the side facing the room) were coated with a silicone rubber sealant (Silicone I, General Electric), leaving only the painted side exposed to air. The sample was then placed in a fume hood to allow the sealant to cure for four days.

To determine the PCB content in the ceiling tile, duplicate samples, weighing approximately 0.5 g each, were prepared using scissors.

### *2.1.3 Light Ballasts*

Nineteen light ballasts were received, representing thirteen different models from five manufacturers. Brief descriptions and identifications of the samples are presented in Table 2.2. The ballasts were shipped to the authors' laboratory at ambient temperature. Each unit was wrapped in dual sealed plastic bags. The samples were inspected upon receipt and they showed no signs of damage or fluid leakage. None of the 19 ballasts was marked "PCB free", "No PCBs", or "Non PCB" by the manufacturer. Four models (BL-10 through BL-13) were marked "Class P", which indicated that integral protection was provided to prevent overheating of the ballast. All but one of the labels on the ballasts were readable. Photographs of seven of the ballasts are shown in Figure 2.4.



**Figure 2.3. Ceiling tile sample CT-02 (top: unpainted side; bottom: painted side)**

**Table 2.2. Summary of light ballast samples**

<b>Ballast ID</b>	<b>Manufacturer / brand</b>	<b>Catalog #</b>	<b>Power (W)</b>	<b>Additional Descriptions</b>	<b># of Units</b>
BL-01	Jefferson Electric Co.	234-983	118V 1.3 A, 3 x 40 W	Oct 1953D	1
BL-02	General Electric	59G276	118 V 1.3 A, 3 x 40 W	1953D; 23 W power loss	1
BL-03	<i>(Unreadable)</i>	263	100 Watt		1
BL-04	Universal Therm-O-Matic	446-LR-TC-T	120 V 0.8 A, 2 x 40 W T12/RS lamps	rapid start	1
BL-05	General Electric	8G1011	120 V 1.4 A, 2 x 40 W F96T12 or F72T12	equip with coil	1
BL-06	General Electric	58G983	118 V 0.8 A 2 x 40 watt	15.5 W power loss	1
BL-07	Ad-Lite	AD-240	118 V 0.8 A		1
BL-08	General Electric	89G347	118 V 0.45 A, 1 lamp	11 W power loss	1
BL-09	Universal Rapid Start	598-L-STF	265 V 0.37 A, 2 x 40 W T12RS		6
BL-10	Universal Therm-O-Matic	412-L-TC-P	120 V 60 Hz; one 40 W rapid start lamp		1
BL-11	Universal Therm-O-Matic	443-LR-TC-P	277 V 60 Hz 0.36 A, 2 x 40 W T12/R.S. lamps		2
BL-12	Universal Therm-O-Matic	458-L-TC-P	277 V 60 Hz; one 40 W lamp	[a]	1
BL-13	Advance	VQM-2S40-2-TP	277 V 60 Hz 0.35 A, 2 x 40 W rapid start lamps	[b]	1

<sup>[a]</sup> Mount lamp within ½" of grounded metal reflector

<sup>[b]</sup> Ground ballast and mount lamps within ½" of grounded metal reflector



**Figure 2.4.** Seven of the light ballast samples tested; for comparison, a modern light ballast (marked “PCB-free”) is shown on the far right

## 2.2 Test Facilities

### 2.2.1 Micro Chamber

The Markes Micro-Chamber / Thermal Extractor ( $\mu$ -CTE) (Markes International, United Kingdom) was used to determine the PCB emissions from the samples of caulk and ceiling tiles. According to a study by Schripp et al. (2007),  $\mu$ -CTE shows good quantitative and qualitative correlation with conventional emission test methods.

The  $\mu$ -CTE system (Figure 2.5) consists of six micro-chambers that allow surface or bulk emissions to be tested from up to six samples simultaneously at the same temperature and flow rate. Each micro-chamber consists of an open-ended cylinder (cup) constructed of Silicosteel® coated stainless steel measuring 25 mm deep with a diameter of 45 mm and a volume of 44 mL. The system has temperature control that allows the tests to be conducted at ambient temperature or at temperatures up to 120 °C. The chamber’s flow distribution system, shown in Figure 2.6, maintains a constant flow of air through each sample chamber, independent of sorbent tube impedance and whether or not a sorbent tube is attached. The flow rate was controlled by the source air pressure and the flow distribution device in the unit. For all of the PCB tests the high flow rate option (50 mL/min to 500 mL/min) was selected. According to the vendor, surface air velocities were roughly uniform across the surface of the sample and they ranged from approximately 0.5 cm/s at an inlet gas flow rate of 50 mL/min to approximately 5 cm/s at an inlet gas flow of 350 mL/min. Planar materials can be lifted up within the micro-chambers using spacers until they reach the collar that projects down from each micro-chamber lid. Samples of different thickness can be accommodated using spacers that are appropriately sized.



**Figure 2.5. Markes  $\mu$ -CTE system with polyurethane foam (PUF) sampling tubes**

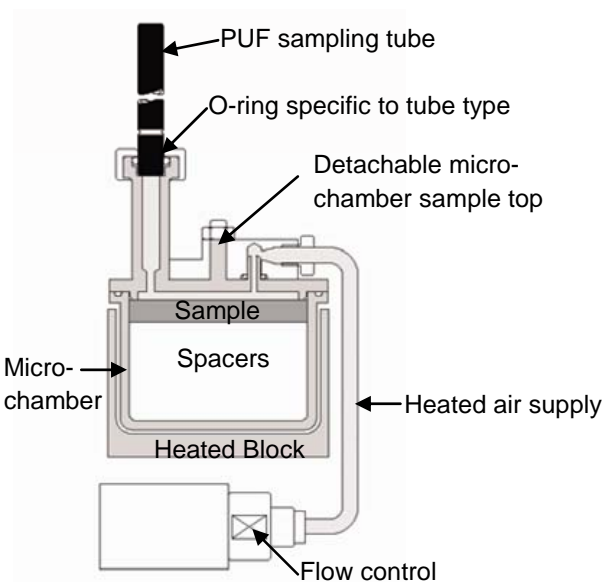

**Figure 2.6. Diagram of a single micro chamber**

The  $\mu$ -CTE system was set up in a fume hood. The air supply was from a clean air generation system consisting of house-supplied high-pressure oil-free air, a pure air generator (Aadco model 737-11A, Cleves, OH), a dryer (Hankinson model SSRD10-300, Canonsburg, PA), a Supelco activated charcoal canister, a Supelco micro sieve canister and gross particle filters (Grainger Speedaire, Chicago, IL).

### 2.2.2 Standard 53-Liter Chamber

All of the emission tests for light ballasts were conducted in 53-liter stainless steel chambers that conformed to ASTM Standard Guide D5116-10 — Standard Guide for Small-Scale Environmental Chamber Determinations of Organic Emissions from Indoor Materials/Products (ASTM, 2010). These chambers had nominal dimensions of 51 cm (width) by 25 cm (height) by 41 cm (depth). A stainless steel plate, fitted with a Teflon-coated Viton O-ring, was used to seal the open side. Clean air, free of volatile organic compounds (VOCs), was supplied to the chambers through the dedicated clean air system described in section 2.2.1. Each chamber was equipped with inlet and outlet manifolds for the air supply, a K-type thermocouple for temperature measurement in the chamber, and two RTD (resistance temperature detector) probes (HyCal model HTT-2WC-RP-TTB, Elmonte, CA) for measuring the relative humidity at the air supply inlet and inside the chamber. The relative humidity of the air supply to the chamber was controlled by blending dry air with humidified air from a glass one-liter round-bottom flask with an impinger submerged in a temperature-controlled water bath. All air transfer lines and sampling lines were made of glass, stainless steel, or Teflon. An OPTO 22 data acquisition system (OPTO 22, Temecula, CA) continuously recorded the outputs of the mass flow controllers, temperatures, and relative humidities. A 1½" (3.8 cm) computer cooling fan (RadioShack, Fort Worth, TX) was placed in the chamber to provide mixing for all of the small chamber tests. The two chambers were housed in a temperature-controlled incubator (Forma Scientific, model 39900), Figure 2.7.



**Figure 2.7. Two small environmental chambers in the temperature-controlled incubator**

The small environmental chambers were used with standard indoor parameters [23 °C, 50% RH, and one air change per hour (ACH)] for all of the ballast screening tests. The temperature tests were operated at 50% RH, as measured at 23 °C, and one ACH, with the temperature varying from 23 °C to 45 °C (at 5 °C increments from 30 °C to 45 °C) at 24-h intervals. Special modifications were made to one of the chambers

to accommodate live ballast testing (i.e., under electrical operation). Those details are presented in section 2.2.3.

### 2.2.3 Modified 53-Liter Chamber

To provide more realistic conditions for testing a ballast, one of the small chambers was modified to allow the electrical input to the ballast through the appropriate lighting fixture. The faceplate of the chamber was modified to support internal ballast wiring to an external 4-ft (122-cm) fluorescent light (Figure 2.8). Two sealed electrical cord entrances were formed in the upper part of the faceplate. The right side contained a 3/C 14 AWG (American wire gauge) cable and the left side had a 9/C 16 AWG wire bundle. The 3/C bundle was the inlet power supply and the 9/C bundle provided the power to the lamp. Immediately outside the chamber, two “quick-disconnect” junctions were formed using locking plug and socket connectors on each cord to maintain the reparability of the chamber and allow for its removal from the incubator without disturbing the seal.

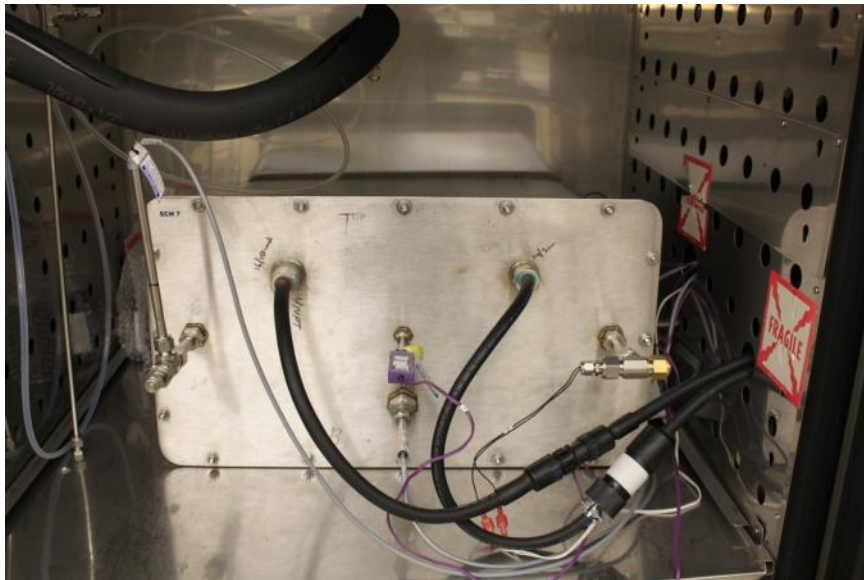

**Figure 2.8. Modified chamber faceplate for live ballast testing**

The ballasts that were evaluated during the screen testing were not identical. Some consisted of a 270-V, 2-lamp output; other ballasts included 120-V outputs, single lamp setups; a couple of the ballasts required a starter. For the 270-V ballasts, 120-V power from the wall outlet was sent to a junction box nearby using a 3/C 14 AWG cable. The transformer inside the junction box boosted the voltage to a 270-V output which was sent inside the chamber to the ballast via a second 3/C 14 AWG cable. The outgoing power from the ballast was then sent via the 9/C 16 AWG bundle to the fluorescent light fixture. This general system setup is shown in Figure 2.9. The setup for the 120-V ballasts was similar except that the junction box was not needed and power from the wall outlet was routed directly to the ballast. An example of the ballast wiring arrangements is shown in Figure 2.10. All the electrical wiring was done by a licensed electrician.



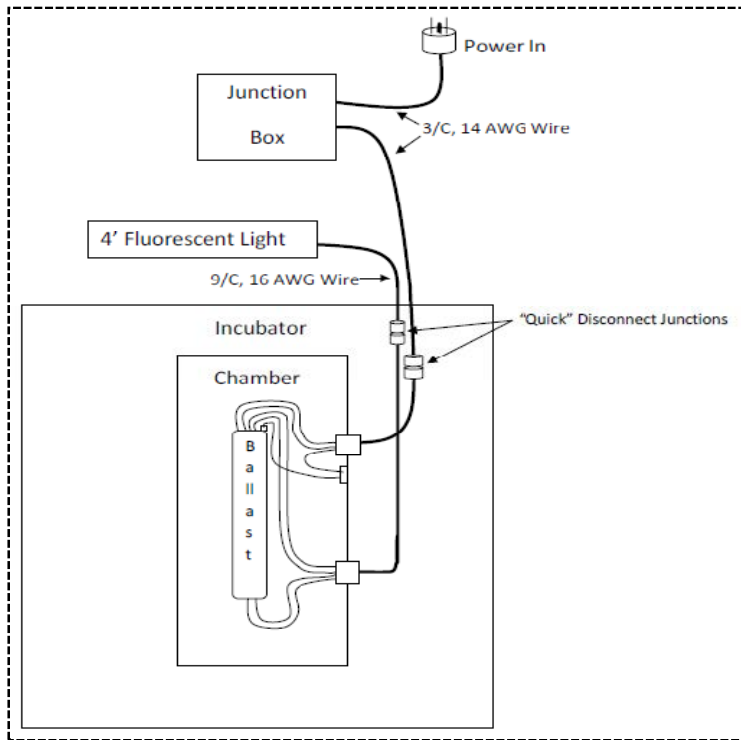

Figure 2.9. Ballast system setup - overhead view

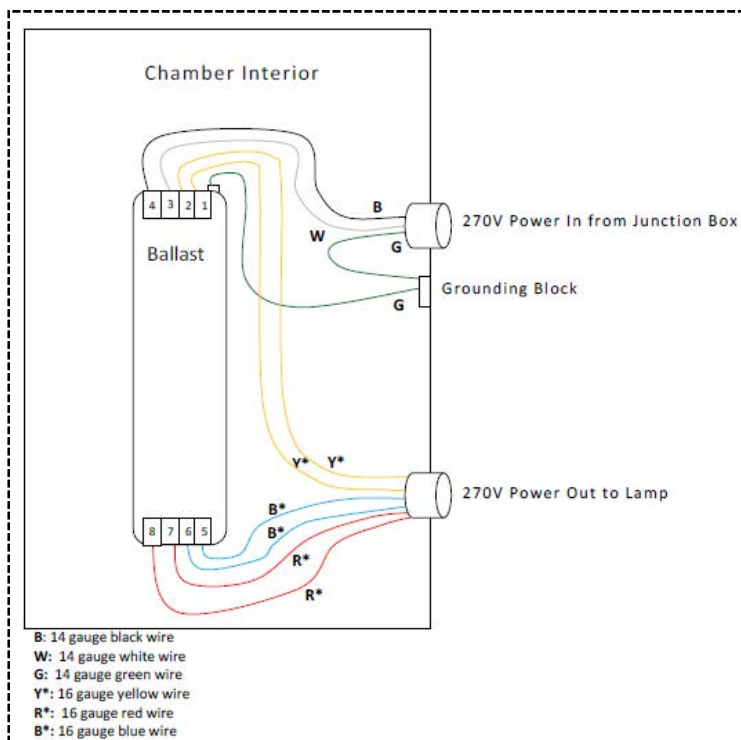
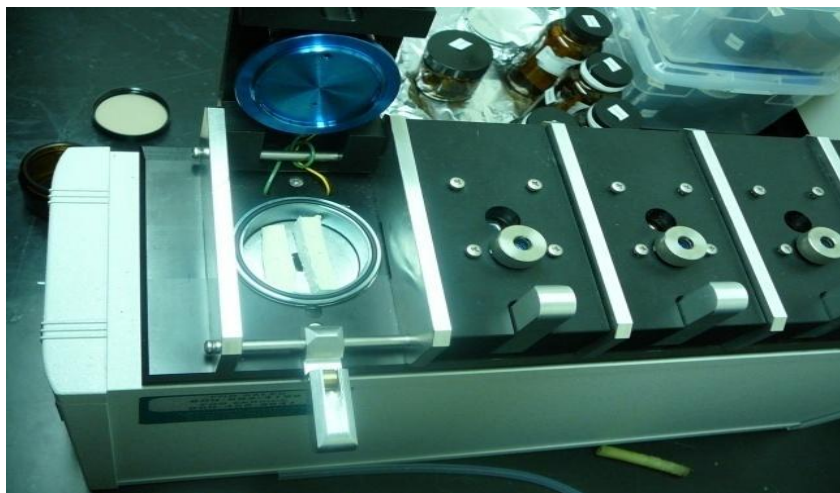

Figure 2.10. Ballast wiring diagram for BL-09 and BL-11 (270 V, 2 lamps)

## 2.3 Test Procedures

### 2.3.1 Caulk and Ceiling Tiles

PCB emissions from the caulk and ceiling tiles were tested in the micro-chambers. Prior to a test, each chamber was cleaned with ultra grade or equivalent hexane (Fisher, Pittsburgh, PA) and then sonicated for 10 minutes. The inlet air pressure was set at approximately 55 psi ( $3.8 \times 10^5$  Pa) to achieve the desired flow rate of air through the chambers of approximately 500 mL/min. The temperature was set to the test requirement. The system was allowed to equilibrate for several hours before a background sample was collected from one of the chambers. A polyurethane foam (PUF) sampling cartridge (Supelco, pre-clean certified) was attached to the outlet of the micro-chamber on the top of the lid covering the empty chamber (See Figure 2.5, above). The outlet air flow through the PUF was measured using a Gilibrator<sup>TM</sup> diagnostic calibration system (Sensidyne, Clearwater, FL). The background sample was collected over a 16-h period, after which samples were placed in each of the chambers (Figure 2.11). Typical sampling schedule was five PUF samples being collected over a two week period; the sampling duration was up to 16 hours.



**Figure 2.11. Caulk sample in one of the micro-chambers**

### 2.3.2 Light Ballasts

Three types of testing were conducted to measure the PCB emissions from the light ballasts in the 53-liter environmental chambers. Table 2.3 summarizes the conditions and reasons. Test procedures are described below.

**Table 2.3. Conditions and reasons for testing PCB emissions from light ballasts**

Type of Test	Temperature Setting	Electrical Load	Purpose
Screening	23 °C; constant	No	PCB emissions from ballasts without electrical load
Temperature effect	23, 30, 35, 40 °C	No	Effect of ambient temperature on PCB emissions from ballasts without electrical load
Live	23 °C; constant	Yes	PCB emissions from ballasts with electrical load

### 2.3.2.1 Screening Testing

Prior to each test the selected chamber was cleaned by wiping all of the interior surfaces with isopropyl alcohol wipes (Walgreens, Deerfield, IL) followed by washing with water with detergent. An inlet air flow rate of 1 ACH and a 50% RH was set via the data acquisition system. The incubator temperature was maintained at 23 °C. An empty-chamber background PUF sample was collected overnight at a sampling flow rate of approximately 600 mL/min for 16 hours. The designated ballast was then taken from storage and placed in the fume hood. The chamber was opened, and the ballast was placed on top of a sheet of aluminum foil at the center of the chamber floor (Figure 2.12). After approximately 2 hours, an individual PUF sample was collected at a sampling flow rate of approximately 600 mL/min overnight. After testing, the ballast was removed and relocated to its secure location. Then, the chamber was cleaned in preparation for testing the next ballast.



**Figure 2.12. Ballast orientation in the small chamber for screening tests**

### 2.3.2.2 Elevated Temperature Testing

Elevated temperature testing of ballasts was conducted in the 53-L stainless steel chambers following all of the same cleaning and setup procedures for the screening tests. The ballast was placed on top of a sheet of aluminum foil on the chamber floor (Figure 2.12, above) after a background PUF sample was collected overnight at the initial temperature setting of 23 °C. Then the chamber was sealed and a PUF sample was collected overnight at 23 °C. After sampling, the incubator temperature was increased to 30 °C at a rate of approximately 1 °C/h. Approximately six hours later, another PUF sample was collected overnight. This process was repeated every day for 3 additional days increasing the temperature by 5 °C until the incubator temperature reached 45 °C. Duplicate PUF samples were collected at 40 °C. For two tests, tandem samples were collected at 35 °C and 45 °C to determine if PCB breakthrough had occurred.

### 2.3.2.3 Live Ballast Testing

Before each live ballast test, the modified chamber and internal wiring were prepared using the same cleaning and set-up procedures detailed above. An inlet air flow with a rate of 1 ACH and 55% RH was introduced to the chamber.

Prior to a test, a background sample was collected. Then the chamber was opened; the designated ballast was connected to the electrical circuit (Figure 2.13) and placed on top of a sheet of aluminum foil on the chamber floor. Then the power to the ballast was turned on by plugging the electrical plug into the wall outlet, turning the lamp on to start the tests (Figure 2.14).

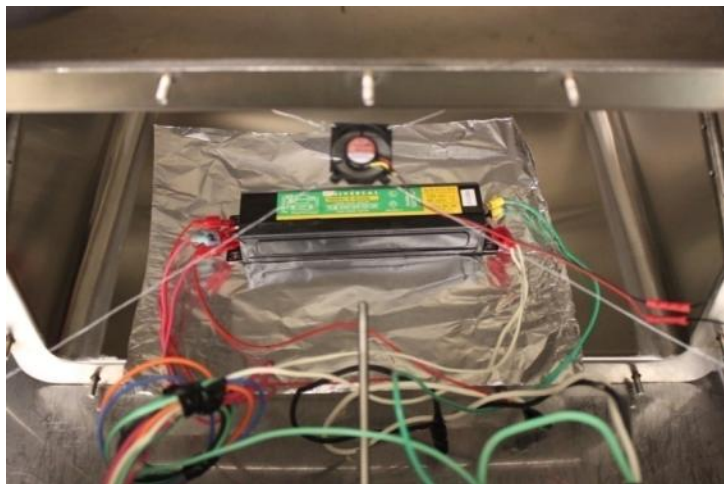

**Figure 2.13. Live ballast with wiring connections**



**Figure 2.14. Lamp was powered on by the ballast in the chamber**

Power to the ballast was maintained for an hour before any sampling began, allowing the ballast to reach its full operating temperature. PUF samples were collected at a flow rate of approximately 600 mL/min for individual samples and 300 mL/min for duplicate samples. The general sampling schedule was to activate the power to the ballast early in the morning, let it warm up for an hour, and then initiate the collection of an individual PUF sample that continued throughout the workday. At the end of the day, the PUF sample was removed, and duplicate PUFs were connected to the sampling manifold to collect air samples overnight. The next morning, the duplicates were removed and the power to the ballast was turned off. The final inlet and outlet flows were measured and then the ballast was removed from the chamber.

## **2.4 Sampling and Analysis**

### *2.4.1 Air Sampling*

Air samples from both the micro-chambers and small chambers were collected on polyurethane foam (PUF) at approximately 500 mL/min for 16 hours. The sampling method was modified based on EPA Method TO-10A (U.S. EPA, 1999). The micro-chamber system has a flow distribution system that maintains a constant flow of air through each sample chamber, independent of sorbent tube impedance and whether or not a sorbent tube was attached. Thus, no pump or mass flow controller was used for micro-chamber tests. For the small chamber tests, PUF samples were collected by drawing air from the small chamber outlet through PUF cartridges with a mass flow controller and a vacuum pump. The sampling flow rate was set by the mass flow controller and measured frequently by using the Gilibrator<sup>TM</sup> air flow calibrator before and during the tests.

After collection, the sample and glass holder were wrapped in a sheet of aluminum foil, placed in a sealable plastic bag, and stored in the refrigerator at 4 °C. The sample was extracted within seven days and analyzed within 40 days. Sample information was recorded on labels affixed to the glass holder in which the sample was stored and in the electronic sample log file. PUF samples and extracts were stored in the refrigerator at

4 °C before extraction or analysis. Quality control samples such as chamber background, duplicates, and field blanks were also collected. (See Section 3, below)

#### 2.4.2 Extraction and Sample Preparation

To determine the PCB content in caulk and potting material in light ballasts, approximately 0.2 g sample was extracted using a sonicator (Ultrasonic Cleaner FS30, Fisher Scientific, USA) with 10 mL of hexane (ultra grade or equivalent, Fisher, Pittsburgh, PA) and approximately 100 mg of sodium sulfate (anhydrous grade or equivalent, Fisher, Pittsburgh, PA) for 30 min in a scintillation vial. Before extraction, 100 µL of 5 ng/mL recovery check standards, including 2, 4, 5, 6-tetrachloro-*m*-xylene (TMX), <sup>13</sup>C-PCB-77, and <sup>13</sup>C-PCB-206, were added to the extraction solution. After extraction, 990 µL of the extract was placed in a 1-mL volumetric flask containing 10 µL of 10 µg/mL internal standards, including <sup>13</sup>C-PCB-4, <sup>13</sup>C-PCB-52 and <sup>13</sup>C-PCB-194, and then transferred to gas chromatography (GC) vials for analysis. The final concentrations of each recovery check standard and each internal standard were 50 ng/mL and 100 ng/mL, respectively. Because of their low density (0.06 g/cm<sup>3</sup>), ceiling tile samples were too bulky for the sonication method. The Soxhlet extraction method was used. The typical sample weight was 0.5 g.

All PUF samples were extracted using Soxhlet systems by following EPA Method 8082A (U.S. EPA, 2007). The PUF samples were placed in individual Soxhlet extractors with about 250 mL of hexane. Fifty microliters of 5 µg/mL recovery check standards were spiked onto the PUF samples inside the Soxhlet extractor. The samples were extracted for 16-24 h. The extract solution was concentrated to about 50 - 75 mL using a Snyder column. Then the concentrated solution was filtered through anhydrous sodium sulfate into a 100-mL borosilicate glass tube and further concentrated to about 1 mL using a RapidVap N<sub>2</sub> Evaporation System (Model 791000, LabConco, Missouri, USA). The 1 mL solution was cleaned up with sulfuric acid (certified plus grade or equivalent, Fisher, Pittsburgh, PA) and brought up to 5 mL with the rinse solution (i.e., hexane for rinsing the concentration tube) in a 5 mL volumetric flask. One milliliter of the 5-mL solution was separated, and 10 µL of 10-ng/µL internal standards were added, after which the extract was transferred to GC vials for analysis. The final concentrations of each recovery check standard and each internal standard were 50 ng/mL and 100 ng/mL, respectively.

When the concentrations of PCBs in the samples were above the highest calibration concentration, the extract solution was diluted with hexane. At that point, the recovery check standards were diluted with the sample, but 10 µL of 10 µg/mL internal standards were always added to the 1 mL of final solution before GC/MS analysis.

#### 2.4.3 Target Compounds

PCBs can be analyzed and quantified either as an Aroclor mixture or as individual congeners. Aroclors can be identified by recognition of Aroclor patterns (U.S. EPA, 2007). However, if the samples contain more than one Aroclor or the Aroclors have undergone environmental degradation, such Aroclor mixtures may have significant differences in peak patterns compared to those of Aroclor standards. The benefit of analyzing congeners is that it allows a direct estimation of the risk of PCBs (Prignano, 2008). There are 209 PCB congeners, and analyzing all of them would be very complicated and time consuming. Thus, it was our

intention to select certain PCB congeners as our target compounds for source characterization testing so that the emissions of PCB congeners can be linked to their physical properties such as vapor pressure.

Selection of the target congeners was based on several factors: inclusion of some predominant congeners in the source and in the emissions, inclusion of congeners with a wide range of vapor pressures and chlorine numbers, and inclusion of at least one dioxin-like congener. By comparing the chromatographic peak patterns of the Aroclor standards with the field caulk samples, we concluded that Aroclor 1254 was the major component in the field caulk (Figure 2.15). Thus we selected 10 individual PCB congeners for the source characterization study on caulk and ceiling tiles (i.e., PCB-52, PCB-66, PCB-101, PCB-154, PCB-77, PCB-110, PCB-118, PCB-105, PCB-17, and PCB-187). Their identifications were based on the literature (Frame et al., 1996; Rushneck et al., 2004) and comparison of retention times and mass spectra with individual PCB congener standards. Among these compounds, PCB-52, PCB-66, PCB-101, PCB-154, PCB-77, PCB-110, PCB-118, and PCB-105 are major PCB congeners in Aroclor 1254. Some of them (PCB-52, PCB-101, and PCB-110) are also the major congeners in the emissions. PCB-154, PCB-77 and PCB-110 co-elute but contain different numbers of chlorine atoms, so they can be quantified by GC/MS with selected ion monitoring (SIM) mode. PCB-77, PCB-105 and PCB-118 are compounds listed by World Health Organization (WHO) as dioxin-like congeners (Mydlová-Memersheimerová, 2009). PCB-17 (with 3 chlorines) and PCB-187 (with 7 chlorines) exist in Aroclor 1254 in small amounts. These compounds were added to the analyte list to cover a wider range of vapor pressures.

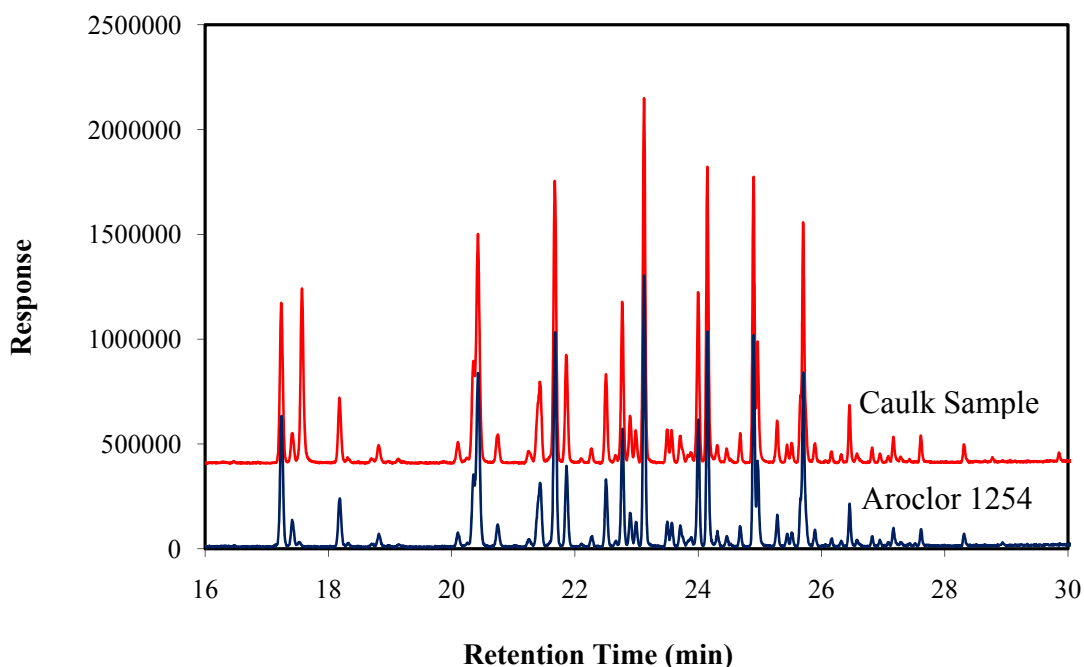

**Figure 2.15. Comparison of chromatograms of a field caulk sample and Aroclor 1254 standard solution analyzed by GC/MS**

According to the literature, the PCBs used in the capacitor of light ballasts were either Aroclor 1242 and 1248 (Frame et al., 1996; Staiff et al., 1974; Hosomi, 2005). We compared the patterns of the chromatographic peaks for the emissions from several light ballasts with the patterns for the emissions from the Aroclor 1242 standard solution and concluded that the PCBs in those light ballasts were Aroclor 1242 (see chromatograms in Section 4.3.7.2). Nine individual PCB congeners were selected for ballast source emission research. They were PCB-13, PCB-18, PCB-17, PCB-15, PCB-22, PCB-52, PCB-49, PCB-44, and PCB-64. The selected PCB congeners did not have high peak responses, but they were the congeners that can be separated with the GC/MS. PCB-13 and PCB-18 co-eluted, but they have different numbers of chlorines, so they could be quantified by GC/MS in SIM mode. PCB-64 mainly existed in the gas phase of Aroclor 1248. Chemical names and chemical abstract services registration numbers (CASRN) for the target congeners, internal standards, and recovery check standards are presented in Tables 2.4 and 2.5.

**Table 2.4. Chemical names and CAS Registration Numbers for the PCB congeners analyzed**

Congener #	Short Name	IUPAC Name	CASRN
13	PCB-13	3,4'-Dichlorobiphenyl	2974-90-5
15	PCB-15	4,4'-Dichlorobiphenyl	2050-68-2
17	PCB-17	2,2',4-Trichlorobiphenyl	37680-66-3
18	PCB-18	2,2',5-Trichlorobiphenyl	37680-65-2
22	PCB-22	2,3,4'-Trichlorobiphenyl	38444-85-8
44	PCB-44	2,2',3,5'-Tetrachlorobiphenyl	41464-39-5
49	PCB-49	2,2',4,5'-Tetrachlorobiphenyl	41464-40-8
52	PCB-52	2,2',5,5'-Tetrachlorobiphenyl	35693-99-3
64	PCB-64	2,3,4',6-Tetrachlorobiphenyl	52663-58-8
66	PCB-66	2,3',4,4'-Tetrachlorobiphenyl	32598-10-0
77	PCB-77	3,3',4,4'-Tetrachlorobiphenyl	32598-13-3
101	PCB-101	2,2',4,5,5'-Pentachlorobiphenyl	37680-73-2
105	PCB-105	2,3,3',4,4'-Pentachlorobiphenyl	32598-14-4
110	PCB-110	2,3,3',4',6-Pentachlorobiphenyl	38380-03-9
118	PCB-118	2,3',4,4',5-Pentachlorobiphenyl	31508-00-6
154	PCB-154	2,2',4,4',5,6'-Hexachlorobiphenyl	60145-22-4
187	PCB-187	2,2',3,4',5,5',6-Heptachlorobiphenyl	52663-68-0



**Table 2.5. Chemical names and CAS Registration Numbers for the internal standards and recovery check standards**

Purpose	Short Name	IUPAC Name	CASRN
Internal standard	<sup>13</sup> C-PCB-4	2,2,'-Dichloro[ <sup>13</sup> C <sub>12</sub> ]biphenyl	234432-86-1
	<sup>13</sup> C-PCB-52	2,2',5,5'-Tetrachloro[ <sup>13</sup> C <sub>12</sub> ]biphenyl	208263-80-3
	<sup>13</sup> C-PCB-194	2,2',3,3',4,4',5,5',-Octachloro[ <sup>13</sup> C <sub>12</sub> ]biphenyl	208263-74-5
Recovery check standard	TMX	1,2,3,5-Tetrachloro-4,6-dimethylbenzene	877-09-8
	<sup>13</sup> C-PCB-77	3,3',4,4'-Tetrachloro[ <sup>13</sup> C <sub>12</sub> ]biphenyl	105600-23-5
	<sup>13</sup> C-PCB-206	2,2',3,3',4,4',5,5',6-Nonachloro[ <sup>13</sup> C <sub>12</sub> ]biphenyl	208263-75-6

#### 2.4.4 Instrument and Analytical Methods

The analytical method used for this project was a modification of EPA Method 8082A and EPA Method 1668B (U.S. EPA, 2008b). The analytical instruments used for quantitative analysis of PCBs congeners in the project were the Agilent 6980/5973N GC/MS (Agilent, Santa Clara, CA) with CTC PAL Auto Sampler (LEAP Technology, Carrboro, NC) and Agilent 6980/5973+ GC/MS with 7683 Agilent Auto Sampler (Agilent, Santa Clara, CA). The operational conditions of the instruments are presented in Tables 2.6 through 2.8. The MSD selected ion monitoring (SIM) parameters were changed over time during analysis to achieve the best sensitivity, and they are presented in Tables 2.9 and 2.10. The instruments were calibrated with PCB congeners in the range of 5 to 200 ng/mL. The GC/MS calibration and quantitation were performed using the relative response factor (RRF) method based on peak areas of extracted ion profiles for target analytes relative to those of the internal standard.

Certified PCB standards (in isooctane) and Aroclor standards (in hexane) were purchased from AccuStandard Inc. (New Haven, CT). Certified <sup>13</sup>C labeled internal standards and recovery check standards (in nonane) were purchased from Wellington Laboratories Inc. (Guelph, Ontario, Canada). Certified TMX standard (in acetone) was purchased from ULTRA Scientific (N. Kingstown, RI).

**Table 2.6. Operating conditions for the Agilent 6890/5973N GC/MS/ CTC PAL Auto Sampler System for the analysis of PCB congeners in Aroclor 1254**

<b>Parameters</b>	<b>Settings</b>
Injector	CTC PAL
Injection volume	1 $\mu$ L
Inlet temperature	250 $^{\circ}$ C
Inlet mode	Splitless
Inlet Flow	1.9 mL/min measured at 100 $^{\circ}$ C
Carrier gas	Helium
GC column	Restek RTX-5Sil ms, 30 m with 0.25 mm ID and 0.25 $\mu$ m film thickness
Oven temperature program	100 $^{\circ}$ C for 2 min, to 150 $^{\circ}$ C at 25 $^{\circ}$ C/min, to 200 $^{\circ}$ C at 3 $^{\circ}$ C/min, to 280 $^{\circ}$ C at 8 $^{\circ}$ C/min, hold for 4 min, total time 34.67 min
Transfer line temperature	280 $^{\circ}$ C
Acquisition Mode	SIM
Solvent delay	6 min

**Table 2.7. Operating conditions for the Agilent 6890/5973N GC/MS/ CTC PAL Auto Sampler System for the analysis of PCB congeners in Aroclor 1242 and Aroclor 1248**

Parameters	Settings
Injector	CTC PAL
Injection volume	1 $\mu$ L
Inlet temperature	250 °C
Inlet mode	Splitless
Inlet Flow	1.8 mL/min measured at 100 °C
Carrier gas and flow	Helium
GC column	SGE BPX5 30 m with 0.25 mm ID and 0.25 $\mu$ m film thickness
Oven temperature program	100 °C for 2 min, to 150 °C at 25 °C/min, to 200 °C at 3 °C/min, to 300 °C at 8 °C/min, hold for 4 min, total time 37.17 min
Transfer line temperature	280 °C
Acquisition Mode	SIM
Solvent delay	6 min

**Table 2.8. Operating conditions for the Agilent 6890/5973N GC/MS/ Agilent 7683 Auto Sampler System for the analysis of PCB congeners in Aroclor 1254**

Parameters	Settings
Injector	Agilent 7683
Injection volume	1 $\mu$ L
Inlet temperature	250°C
Inlet mode	Splitless
Inlet Flow	1.0 mL/min measured at 100°C
Carrier gas and flow	Helium
GC column	SGE BPX5 30 m with 0.25 mm ID and 0.25 $\mu$ m film thickness
Oven temperature program	100 °C for 2 min, to 150 °C at 15 °C/min, to 200 °C at 3°C/min, to 280 °C at 8 °C/min, hold for 6 min, total time 38.00 min
Transfer line temperature	280°C
Acquisition Mode	SIM
Solvent delay	8 min

**Table 2.9. SIM acquisition parameters for the Agilent 6890/5973N GC/MS for the analysis of PCB congeners in Aroclor 1254**

Analytes	Internal Standard	Retention Time (min)	Primary Ion (m/z)
PCB-17	<sup>13</sup> C-PCB-4	16.6	258
PCB-52	<sup>13</sup> C-PCB-52	21.0	292
PCB-101	<sup>13</sup> C-PCB-52	25.2	326
PCB-154	<sup>13</sup> C-PCB-52	26.4	360
PCB-110	<sup>13</sup> C-PCB-52	26.5	326
PCB-77	<sup>13</sup> C-PCB-52	26.7	292
PCB-66	<sup>13</sup> C-PCB-52	24.3	292
PCB-118	<sup>13</sup> C-PCB-52	27.4	326
PCB-105	<sup>13</sup> C-PCB-52	28.2	326
PCB-187	<sup>13</sup> C-PCB-52	29.2	396
TMX (RCS) <sup>[a]</sup>	<sup>13</sup> C-PCB-4	10.2	244
<sup>13</sup> C-PCB-77 (RCS)	<sup>13</sup> C-PCB-52	23.7	304
<sup>13</sup> C-PCB-206 (RCS)	<sup>13</sup> C-PCB-194	31.0	476
<sup>13</sup> C-PCB-4 (IS) <sup>[b]</sup>	--	10.2	234
<sup>13</sup> C-PCB-52 (IS)	--	17.8	304
<sup>13</sup> C-PCB-194 (IS)	--	30.2	442

<sup>[a]</sup> TMX is tetrachloro-*m*-xylene; RCS is recovery check standard.

<sup>[b]</sup> IS is internal standard.

**Table 2.10. SIM acquisition parameters for the Agilent 6890/5973N GC/MS for the analysis of PCB congeners in Aroclor 1242 and Aroclor 1248**

Analytes	Internal Standard	Retention Time (min)	Primary Ions (m/z)
PCB-13	<sup>13</sup> C-PCB-4	16.9	222
PCB-18	<sup>13</sup> C-PCB-52	16.9	258
PCB-17	<sup>13</sup> C-PCB-52	16.9	258
PCB-15	<sup>13</sup> C-PCB-52	17.3	222
PCB-22	<sup>13</sup> C-PCB-52	20.4	258
PCB-52	<sup>13</sup> C-PCB-52	21.4	292
PCB-49	<sup>13</sup> C-PCB-52	21.5	292
PCB-44	<sup>13</sup> C-PCB-52	22.2	292
PCB-64	<sup>13</sup> C-PCB-52	22.8	292
TMX (RCS)	<sup>13</sup> C-PCB-4	12.6	244
<sup>13</sup> C-PCB-77 (RCS)	<sup>13</sup> C-PCB-52	26.2	304
<sup>13</sup> C-PCB-206 (RCS)	<sup>13</sup> C-PCB-194	32.8	476
<sup>13</sup> C-PCB-4	---	12.7	234
<sup>13</sup> C-PCB-52	---	21.3	304
<sup>13</sup> C-PCB-194	---	32.1	442

### 3. Quality Assurance and Quality Control

Quality assurance (QA) and quality control (QC) procedures were implemented in this project by following guidelines and procedures detailed in the approved Category II Quality Assurance Project Plan (QAPP), *Polychlorinated Biphenyls (PCBs) in Caulk: Source Characterization to Support Exposure/Risk Assessment for PCBs in Schools*. Quality control samples consisted of background samples collected prior to the test, field blanks, spiked field controls, and duplicates. Daily calibration check samples were analyzed on each instrument on each day of analysis. Results of QA/QC activities are described in the following subsections.

#### 3.1 Data Quality Indicator Goals for Critical Measurements

Data quality indicator (DQI) goals for the measurement parameters and validation methods are listed in Table 3.1.

**Table 3.1. Data quality indicator goals for critical measurements**

Measurement Parameters	Methods	Accuracy/Bias	Precision
Temperature	Thermocouple, RTD probe <sup>[a]</sup>	± 0.5 °C	± 2 °C
Relative humidity (RH)	RTD Probe, thin film capacitance sensor	± 5% RH	10%
Air exchange rate (ACH) for small chamber	Mass flow controller/meter	± 0.05 ACH	10%
Air flow rate	Mass flow controller	± 10% of full scale	15%
Weight of materials	Gravimetric	± 2 mg	± 2 mg
GC/MS <sup>b</sup> calibration	Relative response factor	Not applicable	25%
GC/MS calibration	Internal audit program	75-125%	25%
Recovery of spiked PCB standards <sup>[c]</sup>	GC/MS	60-140%	40%

<sup>[a]</sup> RTD is Resistance Temperature Detector.

<sup>[b]</sup> GC/MS is gas chromatography/ mass spectrometry.

<sup>[c]</sup> Recovery check standards are listed in Table 2.5.

In addition to the DQI goals for the critical measurement parameters, objectives established for the control of operating parameters for the small chamber system and the micro-chamber system are shown in Tables 3.2 and 3.3.

**Table 3.2. Objectives for small chamber operating parameters**

Operating Parameters	Control Methods	Typical set point	Bias
Chamber temperature	Incubator	23 °C	± 1.0 °C
Chamber inlet air RH	Water vapor generator/dilution system	45% RH	± 5% RH
Air exchange rate	Mass flow controllers/meters	1 ACH	± 0.05 ACH
Air velocity *	Fan	10 cm/s	Not defined
Individual PCB congener	Clean Air System	<10 ng/sample	Not applicable
Total PCB congeners	Clean Air System	<100 ng/sample	Not applicable

\* Measured by hot wire anemometer 1 cm above source surface

**Table 3.3. Objectives for micro chamber systems operating parameters**

Operating Parameter	Control Method	Typical Set Point	Accuracy
Chamber temperature	Air supply temperature control	28-120 °C	± 0.5°C
Low inlet air flow	Gas tank regulator	10-70 mL/min	± 10%
High inlet air flow	Gas tank regulator	50-500 mL/min	± 10%
Total PCB congeners	Clean air system	<100 ng/sample	Not applicable

### 3.2 GC/MS Instrument Calibration

The GC/MS calibration and quantitation of PCBs were performed by using the relative response factor (RRF) method based on peak areas of extracted ion profiles for target analytes relative to those of the internal standard. The calibration standards were prepared at six levels ranging from approximately 5 to 200 ng/mL in hexane. Three internal standards were added in each standard solution for different PCB congeners. The calibration curve was obtained by injecting 1 µL of the prepared standards in triplicate at each concentration level. Tables 3.4 and 3.5 summarize all GC/MS calibrations conducted for the project, including the practical quantification limit (PQL) and the highest calibration concentration. The percentage relative standard deviation (RSD) of average RRF meets the DQI goal of 25%.

**Table 3.4. GC/MS calibration for PCB congeners from Aroclor 1254 <sup>[a]</sup>**

Date	8/6/2010		10/12/2010		2/14/2011		PQL (ng/mL)	Hi Cal (ng/mL)
Analytes	RRF	%RSD	RRF	%RSD	RRF	%RSD		
PCB-17	1.07	7.61	0.90	9.37	0.69	6.14	5.00	200
PCB-52	1.56	6.30	1.23	8.22	1.05	3.53	5.01	200
PCB-101	1.28	9.09	1.18	7.48	0.90	7.86	5.01	200
PCB-154	1.41	14.8	1.20	8.19	0.90	7.80	4.98	199
PCB-110	1.58	11.1	1.52	7.83	1.18	12.1	5.01	200
PCB-77	1.34	24.0	1.54	11.9	1.21	19.0	5.01	200
PCB-66	1.39	11.8	1.40	8.24	1.07	7.22	5.03	201
PCB-118	1.27	14.8	1.42	7.96	1.03	10.9	5.05	202
PCB-105	1.12	15.8	1.32	8.44	0.95	11.0	5.00	200
PCB-187	0.83	13.1	0.93	8.54	0.68	9.78	4.98	199
TMX (RCS)	0.62	4.21	0.40	5.89	0.40	4.11	5.01	200
<sup>13</sup> C-PCB-77 (RCS)	1.30	24.9	1.15	15.5	1.12	16.7	5.00	200
<sup>13</sup> C-PCB-206 (RCS)	1.61	12.8	1.01	7.42	1.08	11.5	5.00	200

<sup>[a]</sup> The DQI goal for %RSD was 25%.



**Table 3.5. GC/MS calibration for PCB congeners from Aroclor 1242 and 1248**

<b>Date</b>	<b>1/11/2011</b>		<b>PQL (ng/mL)</b>	<b>Hi Cal (ng/mL)</b>
<b>Analytes</b>	<b>RRF</b>	<b>%RSD</b>		
PCB-13	0.91	17.3	5.03	201
PCB-18	0.58	8.58	5.03	201
PCB-17	0.73	10.1	5.00	200
PCB-15	0.92	14.7	5.03	201
PCB-22	0.79	10.4	4.95	198
PCB-52	0.81	5.43	5.01	200
PCB-49	0.82	7.92	5.02	201
PCB-44	0.69	7.13	4.98	199
PCB-64	1.09	7.46	4.98	199
TMX (RCS)	0.41	9.70	5.01	201
<sup>13</sup> C-PCB-77 (RCS)	1.04	14.2	5.00	200
<sup>13</sup> C-PCB-206 (RCS)	0.93	15.0	5.00	200

<sup>[a]</sup> The DQI goal for %RSD was 25%.

The Internal Audit Program (IAP) standards that contain three calibrated PCB congeners were analyzed after the calibration to evaluate instrument performance in terms of accuracy and precision. The IAP standards were purchased from a supplier (ChemService, West Chester, PA) different from the standards used for calibration and were certified as to their concentrations of PCB congeners.

Table 3.6 presents the results of the IAP standards analyzed for each calibration. The recoveries of IAP ranged from 80% to 124% and percentage RSDs ranged from 0.13% to 3.34%. They all meet the criteria for IAP analysis, which are  $100 \pm 25\%$  recovery with percentage RSD of triplicate analyses within 25%.

**Table 3.6. IAP results for each calibration**

Calibration	Analyte	IAP Concentration (ng/mL)	Avg. Recovery %	%RSD (n=3)
8/6/2010	PCB-52	70.8	114	0.46
	PCB-101	69.6	90	1.48
	PCB-77	70.8	93	1.10
10/12/2010	PCB-52	150	92	1.22
	PCB-101	150	86	1.64
	PCB-77	150	80	1.37
1/11/2011	PCB-13	50.0	97	3.34
	PCB-15	50.0	116	1.00
	PCB-44	50.0	124	1.18
2/14/2011	PCB-52	100	104	0.13
	PCB-101	100	93.5	0.33
	PCB-77	100	79.9	0.64

<sup>[a]</sup> The DQI goal for %RSD was 25%.

### 3.3 Detection Limits

After each calibration, the instrument detection limit (IDL) was determined by analyzing the lowest calibration standard seven times and then calculating three standard deviations from the measured concentrations of the standard. IDLs are listed in Table 3.7 for all calibrated PCB congeners.

**Table 3.7. Instrument detection limits (IDLs) for PCB congeners for the PUF Soxhlet method**

Date	8/6/2010	10/12/2010	2/2011	Analytes for Aroclors 1242/1248	1/11/2011
Analytes for Aroclor 1254	IDL (ng/mL)	IDL (ng/mL)	IDL (ng/mL)		IDL (ng/mL)
PCB-17	0.77	0.48	0.69	PCB-13	0.49
PCB-52	0.44	0.44	0.32	PCB-18	0.67
PCB-101	1.01	0.43	0.35	PCB-17	1.04
PCB-154	0.54	0.17	0.47	PCB-15	0.81
PCB-110	0.98	0.25	0.38	PCB-22	0.93
PCB-77	1.17	0.21	0.41	PCB-52	1.02
PCB-66	0.94	0.42	0.13	PCB-49	0.69
PCB-118	1.31	0.35	0.23	PCB-44	1.07
PCB-105	1.72	0.44	0.24	PCB-64	0.71
PCB-187	0.91	0.33	0.26	TMX (RCS)	0.90
TMX (RCS)	0.77	1.05	0.43	<sup>13</sup> C-PCB-77 (RCS)	0.83
<sup>13</sup> C-PCB-77 (RCS)	1.13	0.34	0.21	<sup>13</sup> C-PCB-206 (RCS)	1.58
<sup>13</sup> C-PCB-206 (RCS)	2.50	1.36	0.44	--	--

The method detection limit (MDL) was investigated for the PUF Soxhlet extraction method for PCB congeners. Seven PUFs were prepared by spiking seven aliquots of the PCB standard (the final concentration of which after extraction would be close to the PQL), and the recovery check standard solution into the matrix. The PUFs were extracted by following the same extraction and analytical procedure as for the samples. After analysis, the MDL was calculated by using three standard deviations from the measured concentrations of those standards. The results are tabulated in Table 3.8.

**Table 3.8. Method detection limits (MDLs) of the PUF Soxhlet extraction method for PCB congeners on GC/MS<sup>[a]</sup>**

Analytes for Aroclor 1254	MDL (ng/mL)	MDL (ng/PUF)	Analytes for Aroclors 1242/1248	MDL (ng/mL)	MDL (ng/PUF)
PCB-17	2.32	11.6	PCB-13	1.58	7.91
PCB-52	1.65	8.25	PCB-18	1.23	6.16
PCB-101	2.54	12.7	PCB-17	1.41	7.05
PCB-154	2.38	11.9	PCB-15	1.59	7.93
PCB-110	2.67	13.3	PCB-22	1.47	7.36
PCB-77	2.28	11.4	PCB-52	1.60	8.02
PCB-66	1.97	9.87	PCB-49	1.43	7.15
PCB-118	3.33	16.6	PCB-44	1.43	7.15
PCB-105	3.90	19.5	PCB-64	1.70	8.48
PCB-187	3.85	19.2	TMX (RCS)	1.19	5.95
TMX (RCS)	1.69	8.44	<sup>13</sup> C-PCB-77 (RCS)	1.79	8.94
<sup>13</sup> C-PCB-77 (RCS)	1.79	8.94	<sup>13</sup> C-PCB-206 (RCS)	1.76	8.81
<sup>13</sup> C-PCB-206 (RCS)	1.44	7.19	--	--	--

<sup>[a]</sup> To convert MDL to the air concentration unit: MDL (ng/m<sup>3</sup>) = MDL (ng/PUF) / sampling volume (m<sup>3</sup>).

### 3.4 Environmental Parameters

The temperature and RH sensors used to measure environmental conditions for the small chamber tests were calibrated by the EPA metrology laboratory in July, 2010. The air flow and temperature of the micro-chamber were manually measured before and after each sampling. Environmental data such as temperature and RH in the small chambers were recorded by the OPTO 22 data acquisition system (DAS). The air exchange rate of the small chamber was calculated based on the average flow rate of outlet air measured with a Gilibrator at the start and end of each small chamber test. The measurement device was a primary reference method calibrated by the EPA metrology laboratory.

### 3.5 Quality Control Samples

Data quality control samples discussed here included background, field blank and duplicates. Background samples were collected from the outlet of the empty chamber for all tests. A typical background sample showed the contribution of the contamination in the empty chamber, the sampling device, and the clean air supply. Concentrations of all PCB congeners detected in all micro chamber background samples were less than the PQL. The concentration of PCB-18 in 6 of 27 small chamber ballast tests was above the PQL, possibly due to carryover from previous tests since all ballast tests were conducted in a relatively short period of time, and there were some difficulties in cleaning up the PCB residues. These high backgrounds were subtracted when calculating the emission rates.

Duplicate samples were used to estimate the precision of the sampling and analysis methods. No duplicate samples were collected from the micro chamber tests because there was only one outlet for each chamber. Duplicate samples were prepared and analyzed for all bulk analysis of the solid sources. One duplicate sample was collected during each of the live ballast tests. The data showed that the percent RSD of all duplicate samples, except one pair, was less than 25%, meeting the data quality goal. Overall, the precision of the sampling and analysis methods was very good for all target PCB congeners with concentrations above the PQL.

Field blank samples were acquired to determine background contamination on the sampling media due to media preparation, handling, and storage. Field blank samples were handled and stored in the same manner as the samples. Seven field blank samples collected for micro-chamber tests and three for the ballast tests. The target PCB congener concentrations in the field blank were below PQL for all samples.

### **3.6 Daily Calibration Check**

On each day of analysis, at least one daily calibration check (DCC) sample was analyzed to document the performance of the instrument. DCC samples were analyzed at the beginning and during the analysis sequence on each day. Table 3.9 summarizes the average recovery of DCCs for the small chamber and micro chamber tests. The recoveries meet the laboratory criterion of 75 to 125% recovery for acceptable GC/MS instrument performance.

### **3.7 Recovery Check Standards**

Three recovery check standards (RCSs), TMX, <sup>13</sup>C-PCB-77, and <sup>13</sup>C-PCB-206, were spiked in each of the samples before extraction to serve as the laboratory controls (LCs). When the measured concentrations of PCBs in the sample were above the highest calibration level, which mostly happened during bulk analysis, dilution of the extract was performed to re-analyze the sample. In that case, recoveries of RCS were not reported. The analytical results are considered acceptable if the percent recovery of laboratory controls was in the range of 60-140% for at least two of the three recovery check standards.

**Table 3.9. Average recoveries of DCCs for small chamber and micro chamber tests**

Test Type	DCC Compound	Average Recovery	SD	%RSD	N <sup>[a]</sup>
Micro Chamber Tests	PCB-17	101%	0.051	5.09	98
	PCB-52	107%	0.064	5.99	98
	PCB-101	101%	0.052	5.10	98
	PCB-154	100%	0.065	6.46	98
	PCB-110	104%	0.058	5.60	98
	PCB-77	110%	0.062	5.64	98
	PCB-66	102%	0.056	5.51	98
	PCB-118	102%	0.054	5.35	98
	PCB-105	102%	0.062	6.04	98
	PCB-187	99.3%	0.080	8.10	98
	TMX (RCS)	101%	0.048	4.77	98
	<sup>13</sup> C-PCB-77 (RCS)	106%	0.053	5.04	98
	<sup>13</sup> C-PCB-206 (RCS)	97.4%	0.032	3.27	98
Small Chamber Tests	PCB-13	106%	0.081	7.68	44
	PCB-18	103%	0.066	6.42	44
	PCB-17	102%	0.061	5.96	44
	PCB-15	105%	0.086	8.20	44
	PCB-22	104%	0.095	9.08	44
	PCB-52	97.3%	0.019	1.92	44
	PCB-49	95.1%	0.023	2.39	44
	PCB-44	94.3%	0.029	3.12	44
	PCB-64	94.5%	0.031	3.25	44
	TMX (RCS)	99.6%	0.034	3.46	44
	<sup>13</sup> C-PCB-77 (RCS)	93.2%	0.081	8.66	44
	<sup>13</sup> C-PCB-206 (RCS)	94.1%	0.042	4.44	44

<sup>[a]</sup> N is the number of DCCs analyzed.

### 3.8 Comparison of Extraction Methods

To ensure that the sonication method for extraction of caulk samples is comparable with the Soxhlet extraction method, the extraction efficiencies of the two methods were evaluated. A field caulk sample was chopped into small pieces to make six subsamples. Triplicate subsamples were extracted by the sonication and Soxhlet methods, following the procedures for samples. The concentrations measured by the GC/MS are listed in Table 3.10. The percentage RSD for all target PCB congeners above the PQL was less than 17%. The percent RSD for all target PCB congeners was less than 24%. The Soxhlet and sonication methods are comparable for bulk analysis for this project.

**Table 3.10. Comparison of extraction methods (n=3 for each method) <sup>[a]</sup> (units: µg/g)**

Analytes	Soxhlet <sup>[b]</sup>	Sonication <sup>[b]</sup>	Mean <sup>[c]</sup>	%RSD
PCB-17	<del>1.37</del> <sup>[c]</sup>	<del>1.47</del>	<del>1.42</del>	4.88
PCB-52	322	372	347	10.2
PCB-101	660	838	750	16.8
PCB-154	69.1	77.6	73.4	8.17
PCB-110	694	856	775	14.8
PCB-77	<del>1.82</del>	<del>2.14</del>	<del>1.98</del>	11.1
PCB-66	87.4	98.2	92.8	8.26
PCB-118	651	745	698	9.51
PCB-105	294	320	307	5.95
PCB-187	<del>17.4</del>	<del>24.4</del>	<del>20.9</del>	23.6
Sum	2800	3336	3068	12.4

<sup>[a]</sup> Numbers in strikethrough font are below PQL.

<sup>[b]</sup> Mean of three measurements.

<sup>[c]</sup> Average of the means for Soxhlet and sonication.

## 4. Results

### 4.1 Caulk

#### 4.1.1 PCB Content in Caulk Samples

The PCBs in 11 of 12 field samples were identified as Aroclor 1254. The remaining sample contained Aroclor 1260 (Figure 4.1). The concentrations of the 10 target congeners and Aroclor 1254 are presented in Table 4.1. Judging from their low PCB content, samples CK-4, CK-5, and CK-6 are likely contaminated replacement caulk. It was noticed that the relative abundance of congener #52, the most abundant congener in most air samples, varied significantly from sample to sample. Its percentage in the sum of 10 target congeners ranged from 0.3% to 13.2% with a median of 6.8%, as compared to 15.6% for the laboratory-mixed caulk (CK-13). This variation may reflect the different weathering conditions of the caulk samples. For instance, among the caulk samples with low percentage of congener #52, CK-03 is an exterior window caulk and CK-09 is severely deteriorated. (see Table 2.1).

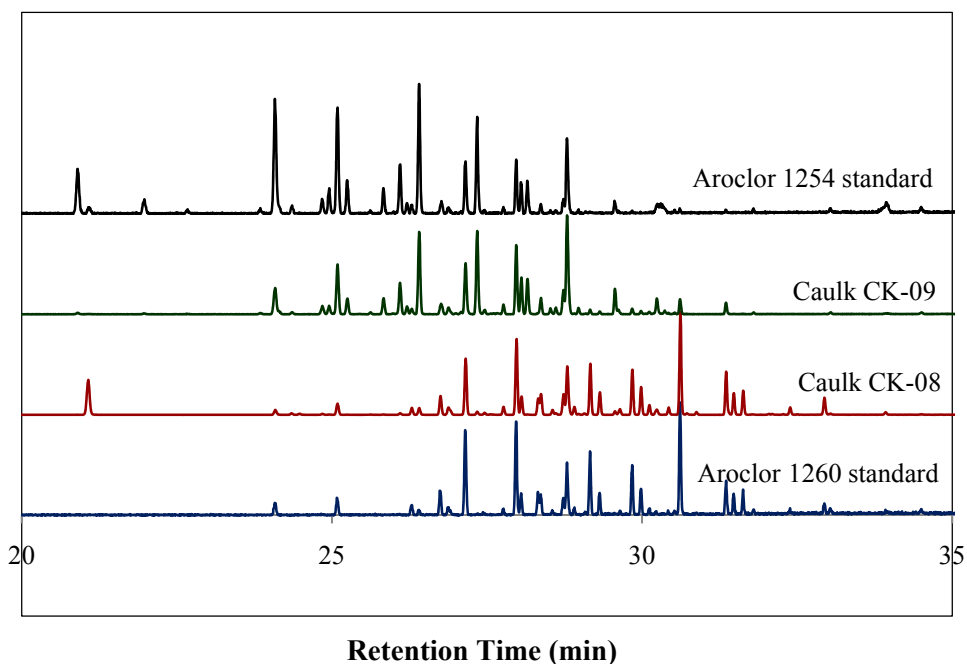

**Figure 4.1.** Comparison of chromatograms (from top to bottom: Aroclor 1254 standard, caulk CK-09, caulk CK-08, and Aroclor 1260 standard)



**Table 4.1. Concentrations of target congeners and Aroclors in caulk samples (units: µg/g)<sup>[a]</sup>**

Sample ID	#17	#52	#101	#154	#110	#77	#66	#118	#105	#187	Aroclor <sup>[b]</sup>
CK-01	<del>0.00</del> <sup>[c]</sup>	2790	6400	672	6940	<del>10.1</del>	549	5780	2370	<del>166</del>	96100
CK-02	<del>12.9</del>	2540	5020	517	5260	<del>9.98</del>	510	4290	1790	<del>135</del>	74300
CK-03	<del>0.00</del>	<del>37.67</del>	1401	198	2734	<del>25.5</del>	<del>63.4</del>	3434	1813	182	52100
CK-04	<del>0.00</del>	615	3080	346	3970	<del>14.1</del>	247	3440	1560	107	42600
CK-05	<del>0.00</del>	<del>0.01</del>	<del>0.08</del>	<del>0.03</del>	<del>0.09</del>	<del>0.00</del>	<del>0.11</del>	<del>0.09</del>	2.02 <sup>[d]</sup>	<del>0.11</del>	<sup>[e]</sup>
CK-06	<del>0.00</del>	<del>0.15</del>	0.73	0.26	0.25	<del>0.00</del>	<del>0.03</del>	<del>0.13</del>	0.33	0.30	7.14
CK-07	<del>0.02</del>	0.41	1.39	0.51	0.62	<del>0.00</del>	<del>0.10</del>	0.39	2.16	0.61	29.0
CK-08	<del>0.00</del>	8.49	843	488	462	<del>2.57</del>	<del>12.0</del>	242	<del>37.1</del>	2770	39700 <sup>[f]</sup>
CK-09	<del>0.00</del>	269	4570	538	7330	<del>0.00</del>	340	7330	3180	311	93300
CK-10	<del>22.2</del>	4850	9240	971	9505	<del>15.8</del>	975	7710	3170	<del>265</del>	136000
CK-11	<del>0.88</del>	223	545	<del>2.48</del>	602	<del>1.20</del>	96.6	614	259	19.2	9128
CK-12	<del>25.8</del>	3140	6420	<del>33.9</del>	7090	<del>6.92</del>	1160	6470	2650	186	103000
CK-13	<del>3.86</del>	330	509	<del>3.11</del>	540	<del>0.00</del>	78.4	499	192	<del>14.4</del>	8280

<sup>[a]</sup> Values are average of duplicate samples. Unless indicated otherwise, the RSD for all duplicates above the PQLs met the data quality goal of less than 25%.

<sup>[b]</sup> Aroclor 1254 unless indicated otherwise. Calculation method is described in 4.1.10.

<sup>[c]</sup> Values in strikethrough font is below the practical quantification limit.

<sup>[d]</sup> RSD for duplicate samples was greater than 25%.

<sup>[e]</sup> The Aroclor content was not calculated because most target congeners were below the practical quantification limit.

<sup>[f]</sup> Aroclor 1260.

#### 4.1.2 Summary of the Micro Chamber Tests

All of the 13 caulk samples listed in Table 4.1 were tested for PCB emissions at room temperature. Five were tested in duplicate. Two caulk samples were tested at different temperatures to evaluate the dependence of the emissions on temperature. Three samples were tested to compare the emissions from freshly cut surfaces and previously exposed surfaces. Test conditions are summarized in Appendix A.

#### 4.1.3 General Emission Patterns

Several studies (e.g., Balfanz et al., 1993) have recognized the significant difference in congener profiles between air and solid samples. When compared to the congener profiles of caulk samples, the congener profiles of air samples are skewed toward the congeners that are more volatile. As an example, Figure 4.2 compares the chromatograms of the Aroclor 1254 standard, a caulk sample, and an air sample taken from the emissions of the caulk. Similar patterns can also be seen by comparing the relative abundances of the target congeners (Figure 4.3). For example, the most abundant congener in the caulk sample was #110, which has vapor pressure of  $1.7 \times 10^{-5}$  torr; its abundance in the air sample was 58% less. On the other hand, congener #52, which has vapor pressure of  $1.5 \times 10^{-4}$  torr, was the most abundant congener in the air sample, where there was three times as much of it as there was in the caulk.

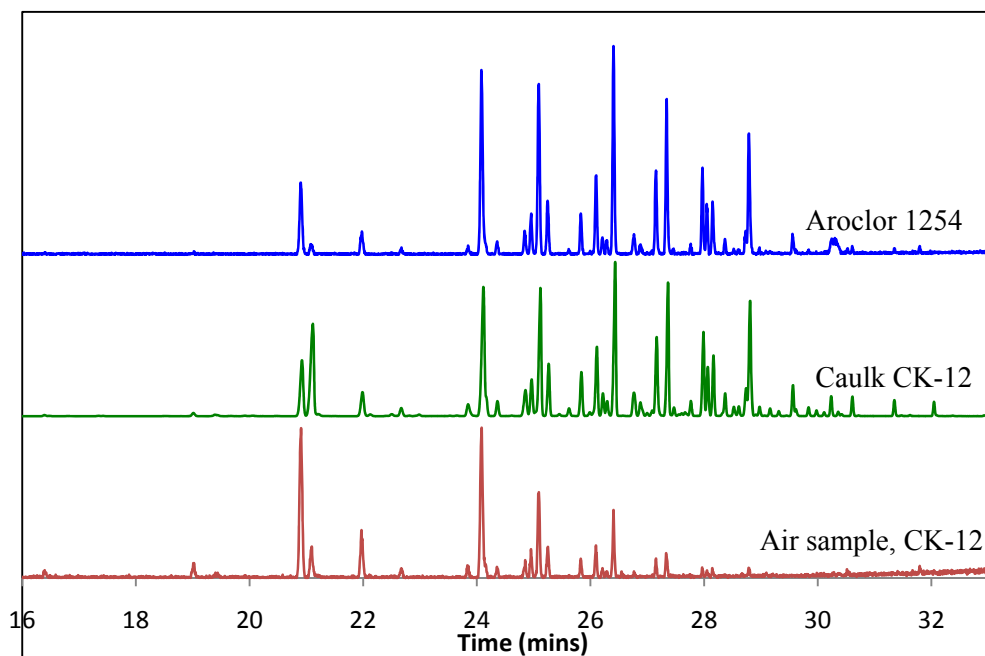

Figure 4.2. Comparison of chromatograms: Aroclor 1254, a caulk sample and an air sample

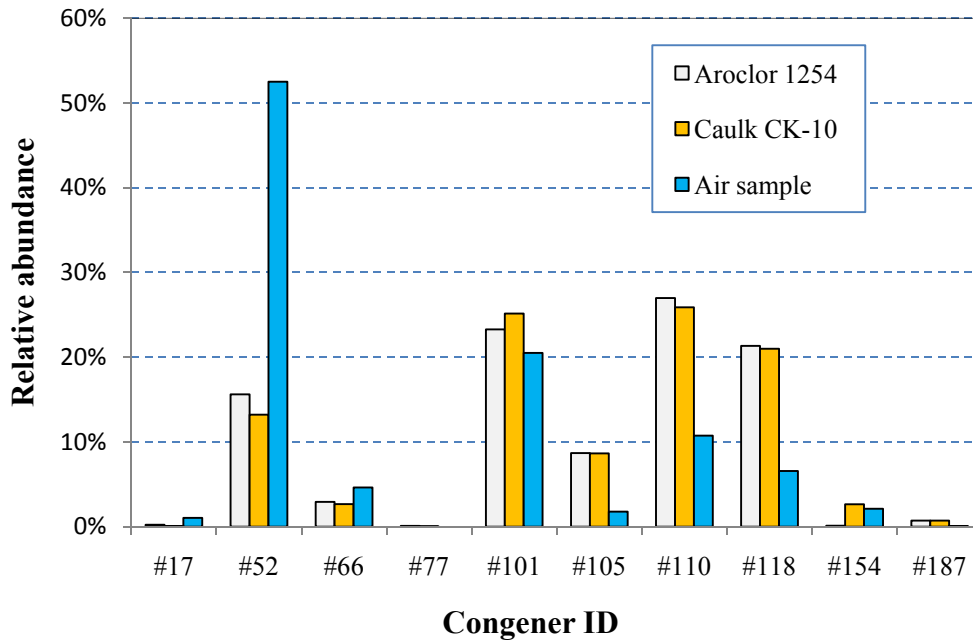

Figure 4.3. Relative abundances of the target congeners for Aroclor 1254

The air sample data showed that emissions remained stable over the test period (approximately two weeks). All the target congeners had similar patterns (Figure 4.4).

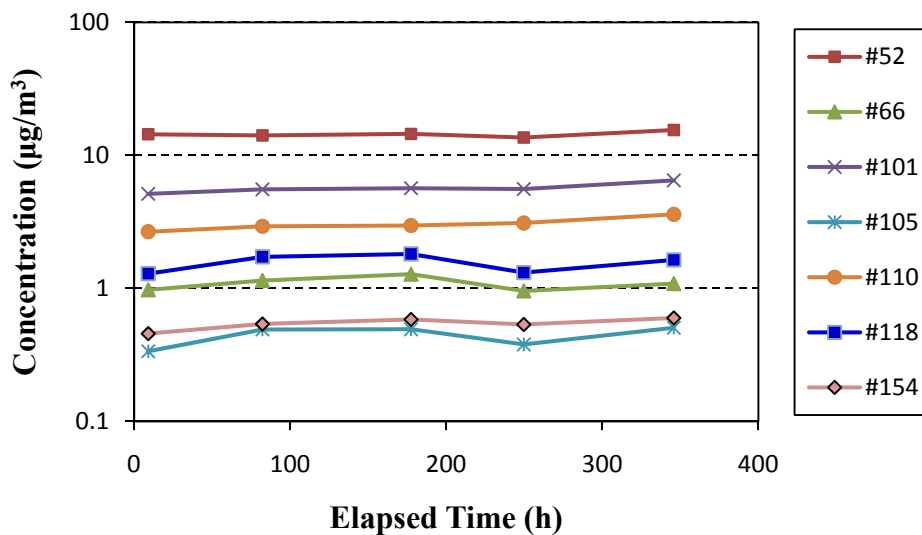

Figure 4.4. Concentration profiles for seven target congeners in chamber air for caulk CK-09 tested at room temperature

#### 4.1.4 Calculation of the Emission Rates and Emission Factors

In this study we used three terms to describe the emissions from caulk: emission rate, emission factor, and normalized emission factor. Emission rate is in ( $\mu\text{g/h}$ ) and can be used for both area sources such as caulk and non-area sources such as light ballasts. Emission factor is in ( $\mu\text{g/m}^2/\text{h}$ ) and can only be used for area sources (ASTM, 2010).

The caulk samples were treated as constant emission sources (see Figure 4.4) and the average air concentration was used to calculate the emission rate and emission factor by using Equations 4.1 and 4.2 (ASTM, 2010):

$$R = QC \tag{4.1}$$

$$E = \frac{R}{A} \tag{4.2}$$

where R = emission rate ( $\mu\text{g/h}$ )  
Q = air change flow rate ( $\text{m}^3/\text{h}$ )  
C = congener concentration in chamber air ( $\mu\text{g}/\text{m}^3$ )  
E = emission factor ( $\mu\text{g}/\text{m}^2/\text{h}$ )  
A = area of the source ( $\text{m}^2$ )

The concept of normalized emission factor is new. The normalized emission factor is defined as

$$N_E = E_x \frac{x_0}{x} \tag{4.3}$$

where  $N_E$  = normalized emission factor ( $\mu\text{g}/\text{m}^2/\text{h}$ )  
 $E_x$  = emission factor at congener content of x ( $\mu\text{g}/\text{m}^2/\text{h}$ )  
 $x_0$  = a reference value for congener content in caulk sample ( $\mu\text{g}/\text{g}$ )  
x = actual congener content in caulk sample ( $\mu\text{g}/\text{g}$ )

A major advantage of this parameter is allowing for comparison of congener emission factors on an equal basis (i.e., the same source strength). Throughout this report,  $x_0$  was set to 1000  $\mu\text{g}/\text{g}$ . Thus, the normalized emission factor for a congener is the emission factor that corresponds to a content of 1000  $\mu\text{g}/\text{g}$  in the caulk.

The air concentration data and test conditions presented in Appendix A were used to calculate the emission rates. The results are summarized in Table 4.2. Values in strikethrough font are below the practical quantification limit. Tests for caulk CK-05, CK-06, and CK-07 were unsuccessful because of the low PCB content in the samples. (See Table 4.1)

**Table 4.2. Calculated emission factors (E) and normalized emission factors (N<sub>E</sub>) at room temperature (µg/m<sup>2</sup>/h) <sup>[a] [b]</sup>**

Sample ID	Parameter	Congener ID								
		#17	#52	#66	#101	#105	#110	#118	#154	#187
CK-01a	E	--	746	58.6	--	371	25	202	102	33.9
	N <sub>E</sub>	--	267	107	--	58.0	10.6	29.1	17.6	50.4
CK-01b	E	5.2	910	60.6	--	439.5	29	233	115.6	42.3
	N <sub>E</sub>	--	326	110	--	68.7	12.2	33.6	20.0	62.9
CK-02a	E	12.3	688	56.9	299	20.8	158	72	28.7	--
	N <sub>E</sub>	--	271	112	59.5	11.6	30.0	16.9	55.6	--
CK-02b	E	11.7	691	53.6	326	22.7	172	88	27.7	--
	N <sub>E</sub>	--	272	105	64.9	12.7	32.8	20.5	53.7	--
CK-03	E	--	17.4	8.6	114	21.2	109	70.8	12.2	--
	N <sub>E</sub>	--	462	136	81.6	11.7	40.0	20.6	61.5	--
CK-04	E	--	106	20.4	158	15.8	113	56.9	14.1	--
	N <sub>E</sub>	--	172	82.5	51.5	10.1	28.5	16.6	40.8	--
CK-08 <sup>[c]</sup>	E	--	105	--	22.8	--	6.77	1.98	12.2	9.66
	N <sub>E</sub>	--	124	--	27.0	--	14.7	8.19	25.0	3.49
CK-09	E	--	125	72.1	575	72.1	451	252	56.9	3.96
	N <sub>E</sub>	--	464	212	126	22.6	61.6	34.4	106	12.7
CK-10a	E	25.9	1118	84.4	441	40.9	237	121	42.2	--
	N <sub>E</sub>	1168	231	86.6	47.8	12.9	25.0	15.7	43.4	--
CK-10b	E	27.5	1310	89.1	480	35.4	248	117	42.4	--

Sample ID	Parameter	Congener ID								
		#17	#52	#66	#101	#105	#110	#118	#154	#187
CK-11a	N <sub>E</sub>	<del>1240</del>	270	91.3	52.0	11.1	26.1	15.2	43.7	--
	E	--	40.6	3.79	20.8	--	9.99	5.56	--	--
CK-11b	N <sub>E</sub>	--	182	39.2	38.2	--	16.6	9.05	--	--
	E	--	34.7	3.25	19.5	--	9.48	5.29	--	--
CK-12	N <sub>E</sub>	--	156	33.6	35.7	--	15.7	8.62	--	--
	E	28.8	906	74.0	365	25.8	182	85.5	35.9	1.26
CK-13a	N <sub>E</sub>	--	288	64.0	56.8	9.74	25.6	13.2	--	6.78
	E	1.23	22.0	2.03	7.27	--	4.21	1.94	--	--
CK-13b	N <sub>E</sub>	<del>320</del>	66.6	25.9	14.3	--	7.80	3.88	--	--
	E	1.39	25.3	2.54	8.45	--	4.83	2.28	--	--
CK-13b	N <sub>E</sub>	<del>360</del>	76.8	32.4	16.6	--	8.95	4.57	--	--
	E	1.39	25.3	2.54	8.45	--	4.83	2.28	--	--

<sup>[a]</sup> Values in strikethrough font were calculated from the concentration data below the PQL.

<sup>[b]</sup> Caulk CK-01, CK-02, CK-10, CK-11 and CK-13 were tested in duplicate.

<sup>[c]</sup> Aroclor 1260.

#### 4.1.5 Dependence of the Emission Factor on Congener Content in Caulk Samples

There is a linear correlation between the content of a congener in the caulk and its emission factor:

$$E_i = a_i x_i \quad (4.4)$$

where  $E_i$  = emission factor for congener  $i$  ( $\mu\text{g}/\text{m}^2/\text{h}$ )  
 $x_i$  = content of congener  $i$  in caulk sample ( $\mu\text{g}/\text{g}$ )  
 $a_i$  = a constant specific to congener  $i$  [ $(\mu\text{g}/\text{m}^2/\text{h}) / (\mu\text{g}/\text{g})$ ]

Figure 4.5 shows the correlation for congener #52, the most abundant congener in most air samples. The estimated constant ( $a_i$ ), confidence of determination ( $r^2$ ), and sample number ( $n$ ) are presented in Table 4.3.

For the convenience of discussion, Equation 4.4 is referred to as the x-E correlation. It can be used to estimate the emission factors once the congener or Aroclor concentration is known.

The x-E correlation also exists for Aroclor concentrations. (See Section 4.1.10).

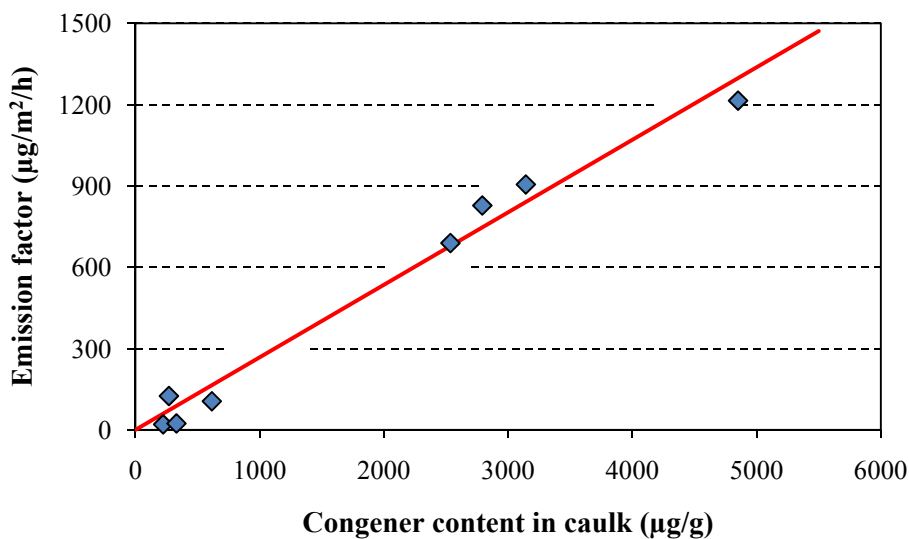

Figure 4.5. x-E correlation for congener #52 ( $r^2 = 0.9816$ ;  $n = 8$ )

**Table 4.3. Estimated constants ( $a_i$ ) for the x-E correlation**

Congener ID	Slope ( $a_i$ )	$r^2$	n
#52	0.268	0.9816	8
#66	0.0809	0.8709	7
#101	0.0557	0.9652	8
#105	0.0112	0.9016	6
#110	0.0280	0.9568	8
#118	0.0163	0.9201	8
#154	0.0459	0.7897	6

*4.1.6 Dependence of Congener Emissions on Vapor Pressure (1) — the P-N Correlation*

According to mass transfer theories, the rate of pollutant emission from a solid material is mainly controlled by two parameters: the pollutant's solid/air partition coefficient and the diffusion coefficient in the material. The former is a function of the vapor pressure of the pollutant whereas the latter is a function of the size of the pollutant molecule and the properties of the solid material. A sensitivity analysis using a mass transfer model (Little et al., 1990) suggested that, for pollutants with low volatilities such as PCBs, the partition coefficient is the most important parameter for the emission rate. Thus, there should be a link between the emission rates and the vapor pressures for different congeners.

The test results showed that an excellent correlation exists between the normalized emission factor and the vapor pressure:

$$\ln N_{Ei} = b_1 + b_2 \ln P_i \quad (4.5)$$

where  $N_{Ei}$  = normalized emission factor for congener i ( $\mu\text{g}/\text{m}^2/\text{h}$ )

$P_i$  = vapor pressure for congener i (torr)

$b_1, b_2$  = constants

Several sets of vapor pressure data for PCBs are available in the literature (i.e., Foreman and Bidleman, 1985; Fischer et al., 1992). In this study we selected the values from Fischer et al.'s method B approach (Table 4.4) because they used experimentally determined vapor pressures of specific congeners to interpolate the vapor pressures, whereas their Method A and (Foreman's method) used vapor pressures of alkanes to interpolate the other congener vapor pressures.



**Table 4.4. Vapor pressures for the target congeners in Aroclor 1254**

Congener	Cl#	P (torr)
#17	3	$5.82 \times 10^{-4}$
#52	4	$1.50 \times 10^{-4}$
#66	4	$4.42 \times 10^{-5}$
#77	4	$1.43 \times 10^{-5}$
#101	5	$2.99 \times 10^{-5}$
#105	5	$5.82 \times 10^{-6}$
#110	5	$1.68 \times 10^{-5}$
#118	5	$8.42 \times 10^{-6}$
#154	6	$1.36 \times 10^{-5}$
#187	7	$2.79 \times 10^{-6}$

Figure 4.6 shows the correlation for caulk CK-10. The calculated constants,  $b_1$  and  $b_2$ , coefficient of determination ( $r^2$ ), and sample number ( $n$ ) are presented in Table 4.5.

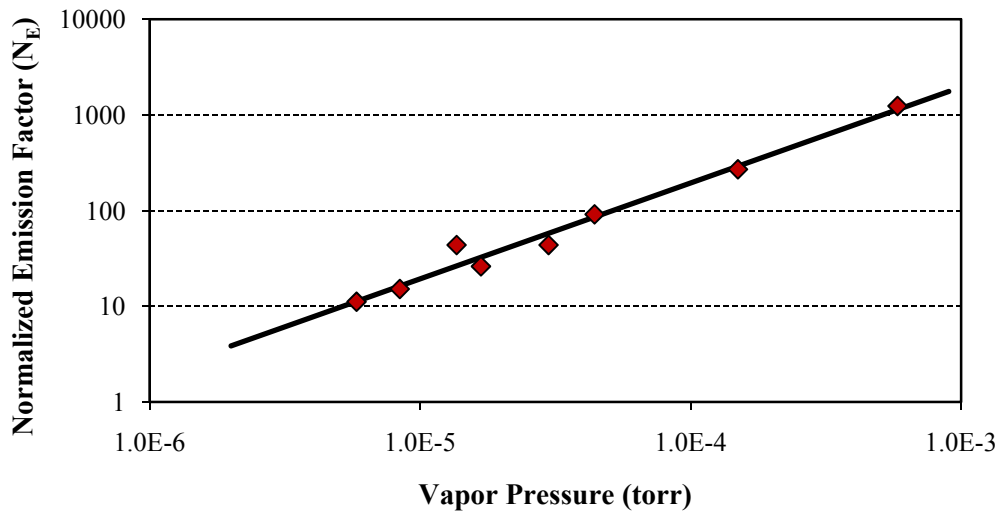

**Figure 4.6. Correlation between the normalized emission factor and vapor pressure for eight target congeners in caulk CK-10 ( $r^2 = 0.9748$ ). The content of #17 in the caulk was below the PQL.**

**Table 4.5. Estimated constants  $b_1$  and  $b_2$  in Equation 4.5 <sup>[a]</sup>**

Caulk ID	$b_1$	$b_2$	$r^2$	n
CK-01a	14.19	0.964	0.9418	7
CK-01b	14.37	0.967	0.9344	7
CK-02a	14.14	0.956	0.9305	7
CK-02b	13.73	0.913	0.9493	7
CK-03	16.45	1.146	0.9200	6
CK-04	14.17	0.971	0.9223	6
CK-08	12.59	0.879	0.8846	4
CK-09	14.37	0.916	0.9304	7
CK-10	14.06	0.960	0.9748	8
CK-11a	13.98	1.025	0.9531	5
CK-11a	13.73	0.993	0.9766	5
CK-12	13.28	0.988	0.9867	6
CK-13	13.14	1.005	0.9899	5

<sup>[a]</sup> Statistics:  $b_1 = 14.02 \pm 0.90$ ;  $b_2 = 0.976 \pm 0.065$ ;  $n=13$ .

Both constants ( $b_1$  and  $b_2$ ) were observed to be consistent among different caulk samples, which indicated that a single correlation could be applied to all caulk samples.

$$\ln N_{Ei} = 14.02 + 0.976 \ln P_i \quad (4.6)$$

For convenience of discussion, Equations 4.5 and 4.6 are referred to as the P-N correlation. This correlation can be used to predict the emission rate for a congener once its content in the caulk sample is known. For example, congener #77, a dioxin-like PCB, can be detected in caulk samples but it is difficult to measure in air samples because of its low concentration. The P-N correlation can be used to estimate its emission factor.

#### 4.1.7 Dependence of Congener Emissions on Vapor Pressure (2) — the P-S Correlation

The slopes of the x-E correlation ( $a_i$ ) in Table 4.3 differed significantly from congener to congener and the more volatile congeners had greater slopes. A plot of the slopes against the vapor pressure showed an excellent correlation (Figure 4.7). Equations 4.7 and 4.8 make it possible to predict the value of the slopes for other congeners.

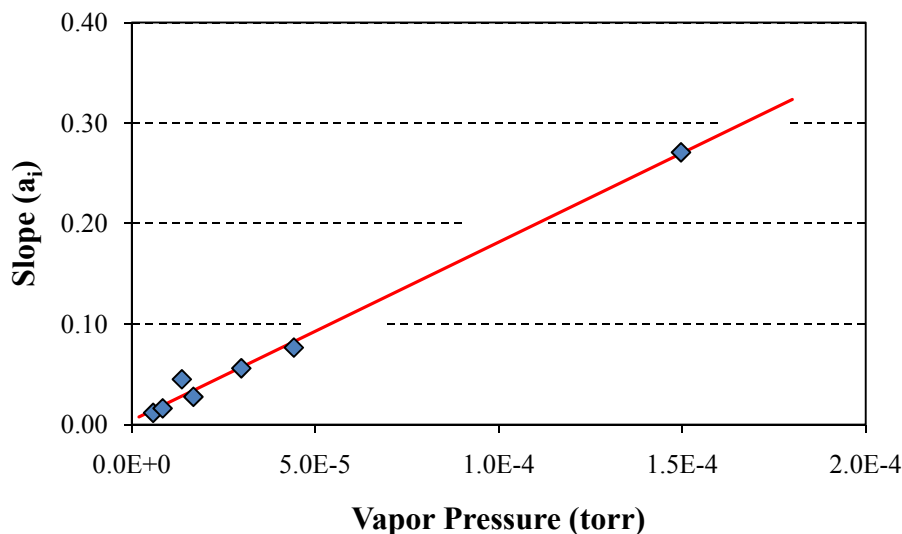

**Figure 4.7. Slope of the x-E correlation ( $a_i$ ) as a function of congener vapor pressure ( $r^2 = 0.9925$ ;  $n=7$ )**

$$a_i = 0.00504 + 1753 P_i \quad r^2 = 0.9925 \quad (n=7) \quad (4.7)$$

or

$$a_i = 1805 P_i \quad r^2 = 0.9902 \quad (n=7) \quad (4.8)$$

where  $a_i$  = slope of the x-E correlation for a given congener  $[(\mu\text{g}/\text{m}^2/\text{h}) / (\mu\text{g}/\text{g})]$

$P_i$  = vapor pressure of the congener (torr)

Equations 4.7 and 4.8 are designated the P-S correlation, where P represents vapor pressure and S represents the slope in the x-E correlation. A combination of the x-E and P-S correlations can be used to predict emission rate of a congener from its content in the caulk sample. Between the two correlations, Equation 4.8 is recommended.

#### 4.1.8 Temperature Dependence of the Emission Factor

Seasonal variations of indoor PCB concentrations have been observed, suggesting a significant effect of temperature on PCB emissions from caulk and other PCB sources (Minegishi et al., 2010). As described by the x-E correlation, the emissions of PCB congeners from the primary sources are driven mainly by the vapor pressure. Because the vapor pressure increases with increasing temperature (Paasivirta and Sinkkonen, 2009), the congener emission rates are expected to increase as the temperature increases.

To quantify the effect of temperature, two caulk samples (CK-11 and CK-13) were tested for emissions in the micro-chambers at four different temperatures. The effect of temperature on vapor pressure can be expressed by Equation 4.9, which is known as the Clausius–Clapeyron relation:

$$\ln P = c - \frac{\Delta H}{RT} \quad (4.9)$$

where      P = vapor pressure (torr)  
                $\Delta H$  = enthalpy of vaporization ( $\text{J mol}^{-1}$ )  
               R = gas constant ( $8.314 \text{ J mol}^{-1} \text{ K}^{-1}$ )  
               T = temperature (K)  
               c = constant

In this study an equation similar to the Clausius–Clapeyron relation was used to determine the dependence of the normalized emission rates on the temperature (Equation 4.10):

$$\ln N_E = d_1 - \frac{d_2}{T} \quad (4.10)$$

where       $N_E$  = normalized emission factor ( $\mu\text{g}/\text{m}^2/\text{h}$ )  
               T = temperature (K)  
                $d_1$  and  $d_2$  = constants

Figures 4.8 and 4.9 show the correlations. In Figure 4.8, data for sample CK-11 at 40 °C were discarded because of unexpected low concentrations possible due to a sampling leakage. Estimated constants ( $d_1$  and  $d_2$ ) in Equation 4.10, confidence of determination ( $r^2$ ), and sample number (n) are presented in Table 4.6.

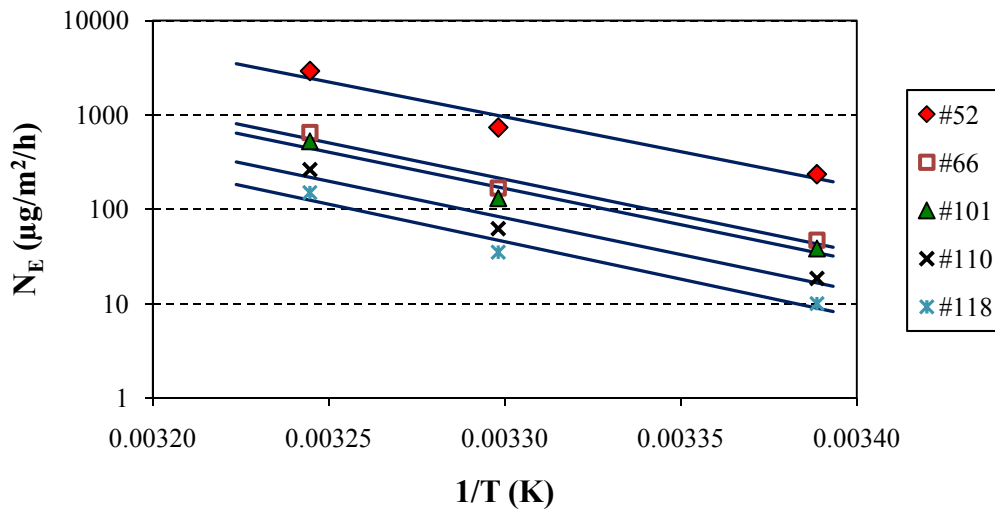

Figure 4.8. Normalized emission factor ( $N_E$ ) as a function of temperature for five congeners in caulk sample CK-11

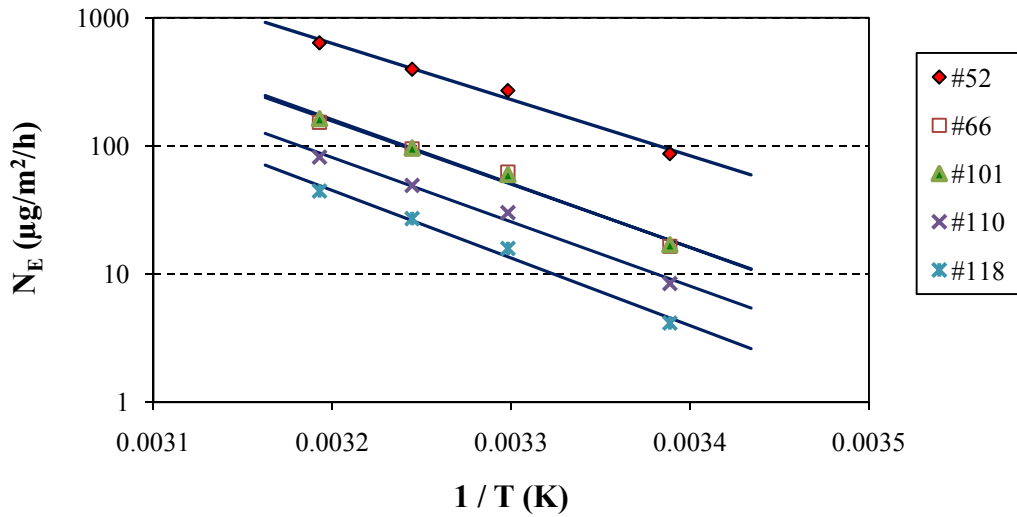

Figure 4.9. Normalized emission factor ( $N_E$ ) as a function of temperature for five congeners in caulk sample CK-13 (trend lines for congeners #66 and #101 are superimposed)

**Table 4.6. Constants  $d_1$  and  $d_2$  in the N-T correlation for caulk sample CK-11 and CK-13<sup>[a]</sup>**

Congener ID	CK-11 (n=3)			CK-13 (n=4)		
	$d_1$	$d_2$	$r^2$	$d_1$	$d_2$	$r^2$
#52	63.0	$1.70 \times 10^4$	0.960	38.7	$1.01 \times 10^4$	0.986
#66	64.0	$1.78 \times 10^4$	0.973	41.3	$1.13 \times 10^4$	0.978
#101	63.4	$1.77 \times 10^4$	0.967	41.9	$1.15 \times 10^4$	0.989
#110	63.4	$1.79 \times 10^4$	0.962	41.4	$1.16 \times 10^4$	0.988
#118	64.2	$1.83 \times 10^4$	0.964	42.7	$1.21 \times 10^4$	0.987

<sup>[a]</sup> Air concentrations are presented in Tables A.5 and A.6 in Appendix A.

The intercepts ( $d_1$ ) and the slopes ( $d_2$ ) for different congeners in the sample were very close to each other, but they differ between the samples. According to the coefficients for CK-11, the normalized emission factor increases by a factor of 5.4 to 9 when the temperature increases by 10 °C in the temperature range of 10 to 50 °C. The coefficients for CK-13 predict an increase by a factor of only 3 to 4. It appears that the composition of caulk has a significant effect on the temperature dependence of the emission rate. More tests are needed to reduce the uncertainty in predicting the temperature effect.

#### 4.1.9 *The Difference between the Exposed and Freshly-cut Caulk Surfaces*

Since there were continuous emissions from caulk, mass transfer models would suggest that a concentration gradient may exist between the exposed surface and the interior of the source material. In other words, the pollutant concentration is lower near the exposed surface than in the deep layers. Consequently, the emission rate at the exposed surface is expected to be lower than that at the newly cut surface of the same sample. To determine whether this difference is significant, three caulk samples were tested to compare the emission rates from the two types of surfaces (Figure 4.10). These caulk samples, as received from the buildings, had coatings on their exposed surfaces. There was a thin layer of clear coat on the exposed surface of caulk CK-01. Caulk CK-02 had two coats. The top coat looked like plain latex paint and was severely deteriorated. Caulk CK-12 had a thick layer of black gloss paint on the exposed side.

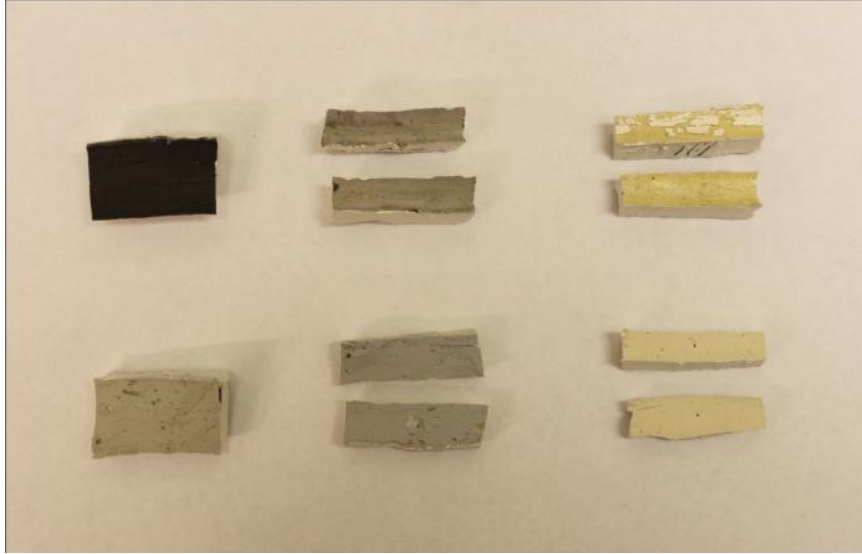

**Figure 4.10. Caulk samples for testing the PCB emission rates of different surfaces**

*From left to right: caulk samples CK-12, CK-01, and CK-02  
(Samples with the exposed surfaces are in top row, and those  
with newly cut surfaces are in bottom row.)*

Comparisons of the emission factors are presented in Tables 4.7 to 4.9. For caulk CK-01, the emission factors for the exposed surface were slightly higher than those for the newly cut surface, but the differences were within the range of experimental error. For caulk CK-02 and CK-12, the emission factors for the exposed surfaces were 36.7% and 25.6% lower than their respective emission factors for the newly cut surfaces. Overall, the limited number of tests shows that the difference between the exposed and newly-cut surfaces is 40% or less.

For caulk CK-12 there seemed to be a linear relationship between the ratio of the emission factors ( $E_s/E_0$ ) and the logarithm of the vapor pressure (Figure 4.11). Such a correlation simply means that, the more volatile the congener, the greater the concentration gradient between the surface and the interior of the source. However, such a trend is not apparent for caulks CK-01 and CK-02.

**Table 4.7. Emission factors ( $\mu\text{g}/\text{m}^2/\text{h}$ ) for the exposed surface ( $E_s$ ) and the newly cut surface ( $E_0$ ) for caulk CK-01**

Emission factor	Congener ID						
	#52	#66	#101	#105	#110	#118	#154
$E_s$ <sup>[a]</sup>	439±21.7	35.3±1.68	257±13.4	20.5±3.23	142±13.4	76.7±8.56	24.4±1.57
$E_0$ <sup>[a]</sup>	481±22.3	34.6±2.28	244±7.83	17.7±2.50	130±8.75	65.6±5.10	23.9±0.96
$E_s / E_0$	91.3%	102.0%	105.2%	116.3%	109.1%	117.0%	101.9%
p-Value	0.008	0.299	0.052	0.077	0.069	0.018	0.293

<sup>[a]</sup> Mean ± SD (n = 5) for all emission factors.

**Table 4.8. Emission factors ( $\mu\text{g}/\text{m}^2/\text{h}$ ) for the exposed surface ( $E_s$ ) and the newly cut surface ( $E_0$ ) for caulk CK-02**

Emission factor	Congener ID						
	#52	#66	#101	#105	#110	#118	#154
$E_s$ <sup>[a]</sup>	292±21.1	29.6±2.16	170±15.1	14.0±2.10	93.3±10.1	52.0±6.17	16.1±1.47
$E_0$ <sup>[a]</sup>	496±33.2	48.5±1.94	265±13.7	21.3±3.10	143±9.4	80.1±8.60	25.6±1.59
$E_s / E_0$	58.9%	61.0%	64.2%	65.8%	65.2%	64.9%	63.0%
p-Value	<0.001	<0.001	<0.001	0.001	<0.001	<0.001	<0.001

<sup>[a]</sup> Mean ± SD (n = 5) for all emission factors.

**Table 4.9. Emission factors ( $\mu\text{g}/\text{m}^2/\text{h}$ ) for the exposed surface ( $E_s$ ) and the newly cut surface ( $E_0$ ) for caulk CK-12**

Emission factor	Congener ID							
	#17	#52	#66	#101	#105	#110	#118	#154
$E_s$ <sup>[a]</sup>	15.7±0.77	598±9.22	58.6±3.71	281±7.21	21.7±3.55	141±29.4	75.5±5.54	24.7±1.86
$E_0$ <sup>[a]</sup>	28.8±1.21	906±35.7	74.0±7.25	365±16.6	25.8±4.54	182±15.2	85.5±5.15	35.9±2.91
$E_s / E_0$	54.5%	66.1%	79.2%	76.9%	83.8%	77.9%	88.2%	68.7%
p-Value	<0.001	<0.001	0.001	<0.001	0.072	0.013	0.009	<0.001

<sup>[a]</sup> Mean ± SD (n = 5) for all emission factors.



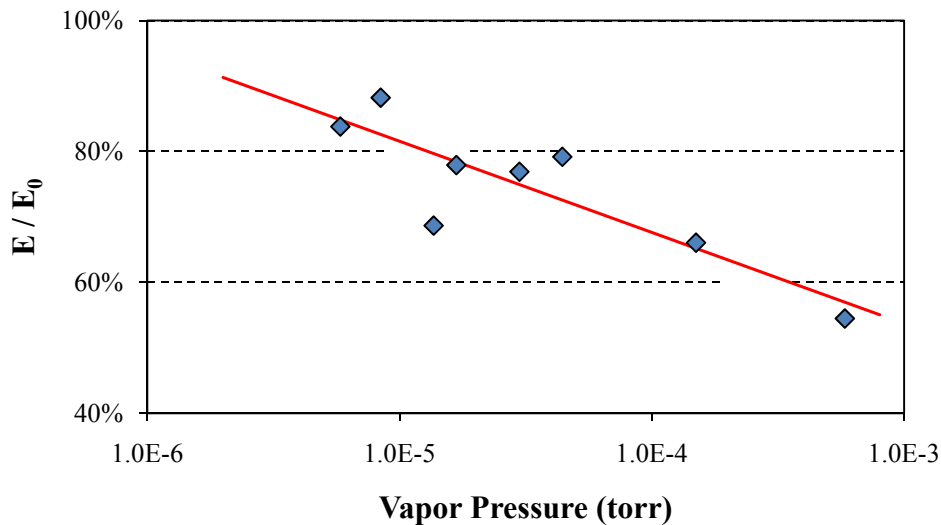

**Figure 4.11. Ratio of the emission factors for the exposed surface ( $E_s$ ) and the newly cut surface ( $E_0$ ) as a function of vapor pressure ( $r^2 = 0.746$ ;  $n = 8$ )**

#### 4.1.10 Emission Factors for Aroclors

This study focused on individual congeners to a greater extent than on Aroclors because we expected the transport rates to be dependent on the properties of individual congeners such as vapor pressures and because we expected different transport rates for different congeners. We needed to quantify the individual congeners to best characterize and model their transport through the indoor environment. However, expressing the emission factors as Aroclors is of practical interest because most field measurements of PCB concentrations in indoor air are given as Aroclors. This report accommodated these interests by following an adaptation of Method 8082A, which calculates the Aroclor concentration in three steps:

**Step 1:** One-point calibration to determine the response of three to five major congeners to the amount of Aroclor injected.

$$R_i = \frac{A_{si}}{W_s} \quad (4.11)$$

where  $R_i$  = response factor of congener  $i$  per nanogram of Aroclor standard injected

$A_{si}$  = area count for congener  $i$

$W_s$  = amount of Aroclor standard injected (ng)

**Step 2:** Calculate the amount of Aroclor in sample  $x$  based on individual congener peaks

$$W_{xi} = \frac{A_{xi}}{R_i} \quad (4.12)$$

where  $W_{xi}$  = amount of Aroclor in sample  $x$  based on congener  $i$   
 $A_{xi}$  = area count for congener  $i$  in sample  $x$   
 $R_i$  = response factor of congener  $i$  in the Aroclor (from Equation 4.11)

**Step 3:** Calculate an average based on three to five major congener peaks

$$W_x = \frac{\sum_{i=1}^n w_{xi}}{n} \quad (4.13)$$

where  $W_x$  = calculated amount of Aroclor in sample  $x$   
 $n$  = number of congener peaks used to calculate the Aroclor concentration ( $3 \leq n \leq 5$ )

In this study, we deviated from strict adherence to the 8082A method because we were quantifying individual congeners. The method described below is equivalent to the original methods described above.

**Step 1:** One-point calibration to determine the content of three to five major congeners in the Aroclor.

$$F_i = \frac{w_{si}}{W_s} \quad (4.14)$$

where  $F_i$  = weight fraction of congener  $i$  in the Aroclor standard injected  
 $w_{si}$  = content of congener  $i$  in the Aroclor standard injected (ng)  
 $W_s$  = amount of Aroclor standard injected (ng)

**Step 2:** Calculate the amount of Aroclor in the sample based on individual congener peaks

$$W_{xi} = \frac{w_{xi}}{F_i} \quad (4.15)$$

where  $W_{xi}$  = amount of Aroclor in sample  $x$  based on congener  $i$  (ng)  
 $w_{xi}$  = amount of congener  $i$  in sample  $x$  (ng)  
 $F_i$  = weight fraction of congener  $i$  in the Aroclor (from Eq. 2.1)

**Step 3:** Calculate an average based on three to five major congener peaks

$$W_x = \frac{\sum_{i=1}^n W_{xi}}{n} \quad (4.16)$$

where  $W_x$  = calculated amount of Aroclor in sample  $x$   
 $W_{xi}$  = amount of Aroclor in sample  $x$  based on congener  $i$   
 $n$  = number of congener peaks used to calculate the Aroclor concentration ( $3 \leq n \leq 5$ ).

The calculated emission factors as Aroclors are presented in Table 4.10.

**Table 4.10. Aroclor 1254 concentrations in caulk samples (x) and chamber air (C) and the calculated emission factors (E)**

Caulk ID	x (µg/g)	C (µg/m <sup>3</sup> )	E (µg/m <sup>2</sup> /h)
CK-01a	96100	74.9	5550
CK-01b		82.6	6920
CK-02a	74300	57.2	5000
CK-02b		62.3	4990
CK-03	52100	10.1	1210
CK-04	42600	19.9	1900
CK-09	93300	46.0	5260
CK-10a	136000	86.5	8030
CK-10b		70.6	5610
CK-11a	9128	8.36	187
CK-11b		7.87	176
CK-12	103000	154	6450
CK-13a	8280	8.01	179
CK-13b		9.14	207

Similar to individual congeners, the x-E correlation (Equation 4.4) is applicable to the emission factors for Aroclor 1254 (Equations 4.17 and 4.18). Figure 4.12 shows the emission factor as a function of Aroclor 1254 content in caulk samples.

$$E = -675 + 0.0672 x \quad r^2 = 0.9454 \text{ (n = 9)} \quad (4.17)$$

or

$$E = 0.0600 x \quad r^2 = 0.9301 \text{ (n=9)} \quad (4.18)$$

where E = emission factor for Aroclor 1254 ( $\mu\text{g}/\text{m}^2/\text{h}$ )  
 x = content of Aroclor 1254 in caulk sample ( $\mu\text{g}/\text{g}$ )

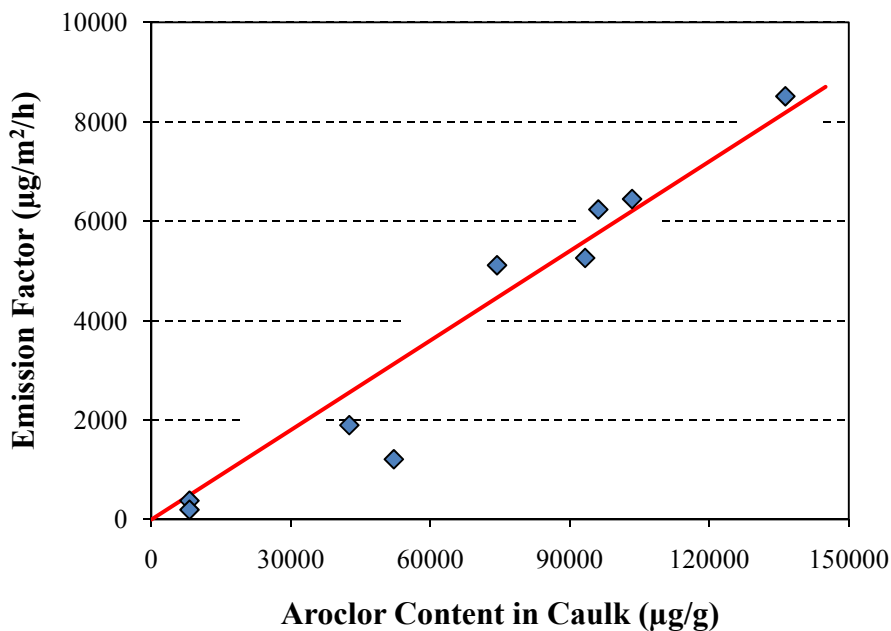

**Figure 4.12. Emission factor for Aroclor 1254 as a function of Aroclor content in caulk sample ( $r^2 = 0.9301$ ;  $n = 9$ )**

The validity and usefulness of expressing concentrations of PCBs in air as Aroclors are debatable. More discussion on this matter is given in Section 5.4.

## 4.2 Ceiling Tiles

The congener peak patterns in the three ceiling tile samples were similar but the Aroclor type could not be positively identified (Figure 4.13). The three samples may be of the same products and may have experienced similar weathering conditions because their congener profiles are similar (Figure 4.14). The content of target congeners in the samples is presented in Table 4.11.

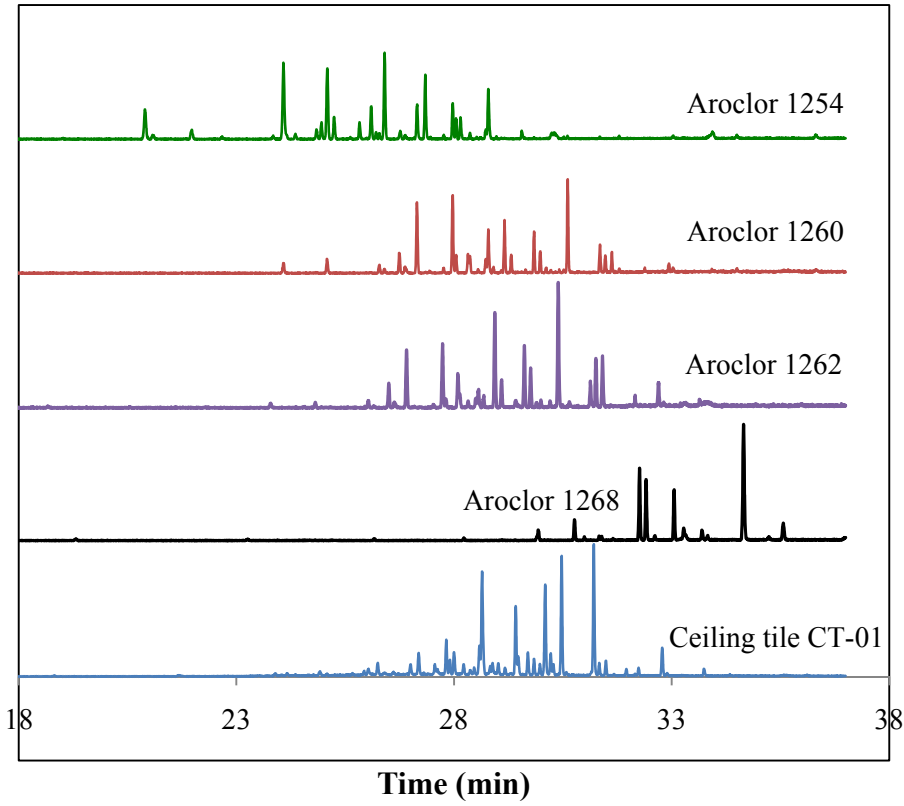

Figure 4.13. Comparison of chromatograms - from top to bottom: Aroclors 1254, 1260, 1262, and 1268 and ceiling tile CT-01

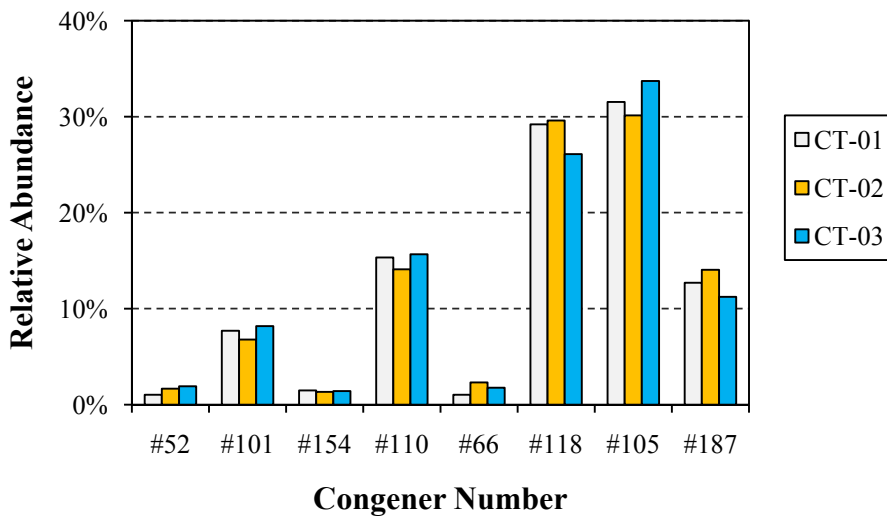

Figure 4.14. Relative abundances of the target congeners in three ceiling tile samples

**Table 4.11. Concentrations of target congeners in ceiling tile samples ( $\mu\text{g/g}$ )<sup>[a]</sup>**

Congener ID	Ceiling Tile ID		
	CT-01	CT-02	CT-03
#17	0.003	0.003	0.004
#52	0.124	0.059	0.117
#66	0.125	0.082	0.108
#77	0.017	0.017	0.015
#101	0.931	0.242	0.5
#105	3.81	1.07	2.06
#110	1.85	0.502	0.957
#118	3.53	1.05	1.59
#154	0.179	0.048	0.087
#187	1.53	0.5	0.687

<sup>[a]</sup> To convert the congener content to  $\mu\text{g}$  per  $\text{cm}^2$  paint, multiply the values in the table by the density of the ceiling tile ( $0.063 \text{ g/cm}^3$ ) and then by the height of the ceiling tile (2 cm).

To determine whether the PCBs were in the paint or fiber, a piece of the ceiling tile was split into two parts at approximately  $\frac{1}{4}$  of the height from the top (i.e., the painted side). The two parts were extracted separately. The results confirmed that the PCBs were mainly in the paint (Figure 4.15). The unevenness of the paint (Figure 2.4) may have contributed to the difference in PCB content between the three samples shown in Table 4.11.

The congener concentrations in air samples were all below the practical quantification limit, so the emission factors were not reported. However, the data did show that the P-N correlation could be applied to ceiling tiles (Figure 4.16).

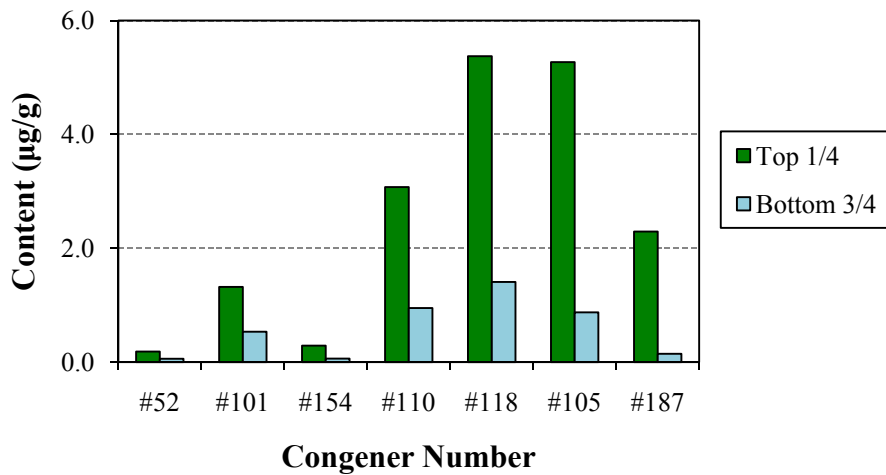

Figure 4.15. Congener content in the top (with paint) and bottom layers of the ceiling tile

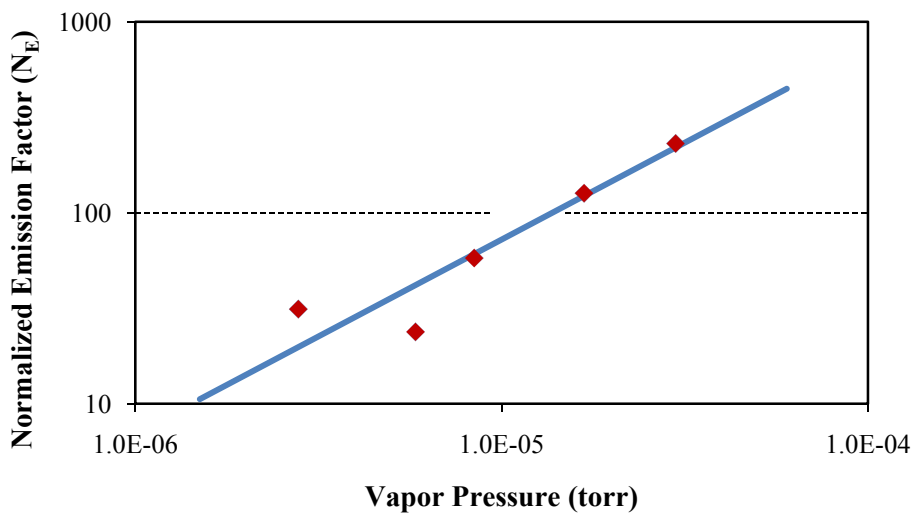

Figure 4.16. Normalized emission factor as a function of vapor pressure for sample CT-03 (All congener concentrations in air samples were below the practical quantification limit)

### 4.3 Light Ballasts

#### 4.3.1 Test Summary

Three types of chamber tests were conducted for PCB emissions from light ballasts: screening tests, live tests, and tests for temperature effect. The purpose of screening tests, which were conducted at room temperature and without electrical load, was to identify leaking ballasts. The live ballast tests were

conducted with the matching fluorescent lamps on. The tests for temperature effect were conducted at five different temperatures. The test conditions are provided in Appendix B.

#### 4.3.2 Method for Calculating the Emission Rate

The emission rate for a PCB congener was calculated from Equation 4.8, which is identical to Equation 4.1 for caulk:

$$R = Q C \quad (4.19)$$

where  $R$  = emission rate ( $\mu\text{g}/\text{h}$ )

$Q$  = chamber air flow rate ( $\text{m}^3/\text{h}$ )

$C$  = air concentration with the light ballast in the test chamber ( $\mu\text{g}/\text{m}^3$ )

During the screening tests the 53-L chambers were found to be more difficult to clean than the micro-chambers. As a result, the background concentration of congener #18, the most abundant congener in the emissions, was above the practical quantification limit in several screening tests. These high backgrounds were subtracted during the rate calculations (Equation 4.20):

$$R = Q (C - C_0) \quad (4.20)$$

where  $C_0$  = background concentration of PCB in chamber air ( $\mu\text{g}/\text{m}^3$ )

#### 4.3.3 Screening Tests

As shown in Table 4.12, the emissions were low for all the ballasts tested, indicating that the leakages were either minor or insignificant. Congener #18 made the largest contribution to the emissions.



**Table 4.12. Congener emission rates for light ballasts at room temperature and without electrical load (units:  $\mu\text{g/h}$ )<sup>[a]</sup>**

Ballast ID	Congener ID			
	#15	#17	#18	#52
BL-01	--	--	0.0026	--
BL-02	--	--	0.0050	--
BL-03	--	--	0.0003	--
BL-04	--	--	0.0040	--
BL-05	--	--	0.0074	--
BL-06	--	--	0.0051	--
BL-07	--	--	0.0014	--
BL-08		0.0032	0.0089	--
BL-09A	--	--	0.0068	--
BL-09B	--	--	0.0053	--
BL-09D	--	--	0.0043	--
BL-09E	--	--	0.0026	--
BL-10	--	0.0031	0.0111	--
BL-11B	--	--	--	--
BL-12	0.0040	0.0105	0.0307	0.0036
BL-13	--	--	0.0031	--

<sup>[a]</sup> Emission rates for #13, #22, #44, #49, and #64 were all below practical quantification limit.

#### 4.3.4 Live Ballast Tests

Six light ballasts were tested under conventional use conditions (i.e., with electrical load). The calculated emission rates are presented in Table 4.13. Overall, the emission rates were roughly of the same order as those from the screening tests. Ballast BL-08 burst unexpectedly during a test. Details are described in Section 4.3.6. The custom-made test chamber became unusable after the ballast burst, which made it impossible to conduct more live ballast tests.

The PCB emission rates reported in Table 4.13 may be lower than the emission rates of the same ballasts had they been operated under realistic operating conditions. In the real world, the light ballasts are often placed in enclosures causing higher ambient temperatures locally (Rensselaer Lighting Research Center, 2004). Because the PCB emission rate is highly sensitive to the temperature (see section 4.3.5 below), the PCB emission rates from light ballasts under realistic use conditions could be much higher.

**Table 4.13. Rates of congener emission from ballasts with electrical load (µg/h) <sup>[a]</sup> <sup>[b]</sup>**

Congener ID	Light Ballast ID				
	BL-09A	BL-09C	BL-09D <sup>[c]</sup>	BL-10	BL-11A
#13	--	0.0007	<del>0.0003</del>	0.0140	--
#18	0.0056	0.0093	0.0101	0.0190	<del>0.0028</del>
#17	<del>0.002</del>	<del>0.0027</del>	<del>0.0028</del>	0.0010	<del>0.001</del>
#15	<del>0.0007</del>	0.0013	<del>0.0016</del>	--	<del>0.0029</del>
#22	<del>0.0001</del>	0.0005	<del>0.0009</del>	--	--
#52	--	0.0006	<del>0.0006</del>	--	--
#49	--	0.0004	<del>0.0003</del>	--	--
#44	--	0.0004	<del>0.0003</del>	--	--
#64	--	--	<del>0.0001</del>	--	--

<sup>[a]</sup> Data for the burst ballast (BL-08) are presented in Section 4.3.6.

<sup>[b]</sup> Values in strikethrough font were calculated from air concentrations below the PQL.

<sup>[c]</sup> No chamber background sample for this test.

Although most congeners were below the PQL in air samples, the results do show that the P-N correlation applies to light ballasts as well as caulk (Figure 4.17). The normalized emission rate for a light ballast is defined by Equation 4.21:

$$N_R = R \frac{x_0}{x} \quad (4.21)$$

where  $N_R$  = normalized emission rate for a congener (µg/h)

$R$  = emission rate for the congener

$x_0$  = reference concentration for the congener in the liquid source;  $x_0 = 1000$  (µg/g)

$x$  = actual concentration for the congener in the liquid source (µg/g)

In Figure 4.17, the liquid source is pure Aroclor 1242 and the congener content in the liquid source is from Table 4A, data column 7 (G3) in Frame et al. (1996).

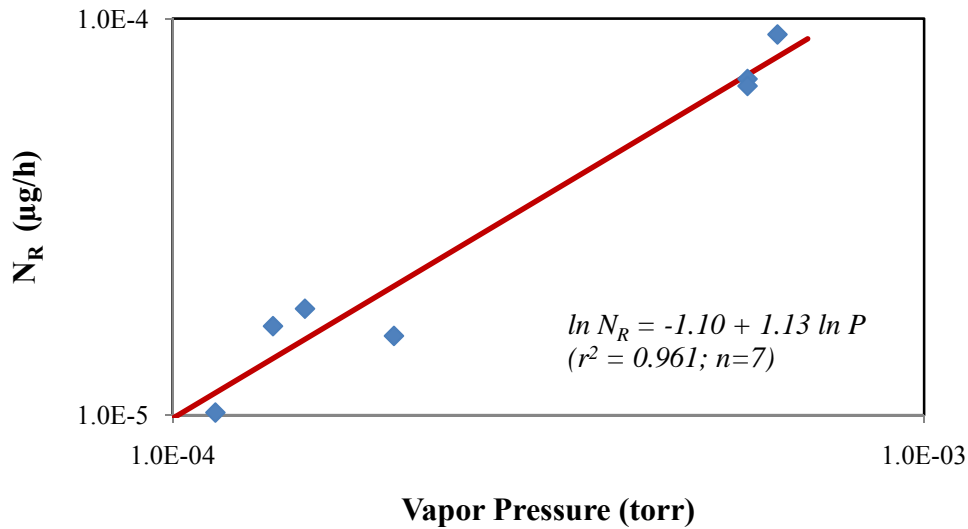

**Figure 4.17. Dependence of congener emission rate on vapor pressure for light ballast BL-09C**

#### 4.3.5 Effect of Ambient Temperature

A study by Hosomi (2005) showed that the rate of PCB emissions from PCB-containing light ballasts increases as the ambient temperature increases. The same trend was observed in this study (Figure 4.18). The linear model used for ballasts (Equation 4.22) was similar to the one for caulk (Equation 4.10) except that the normalized emission factor was replaced by the normalized emission rate:

$$\ln N_R = f_1 - \frac{f_2}{T} \quad (4.22)$$

where  $N_R$  = normalized emission rate ( $\mu\text{g}/\text{h}$ )

$T$  = temperature (K)

$f_1$  and  $f_2$  = constants

According to the estimated values for constants  $f_1$  and  $f_2$  (Table 4.14), every 10 °C increase in temperature results in an increase of the emission rate by a factor 3 to 6. These results are roughly in agreement with the data reported by Hosomi (2005). The variations of the  $f_1$  and  $f_2$  values for different ballasts suggest that ballast type or condition has an effect.

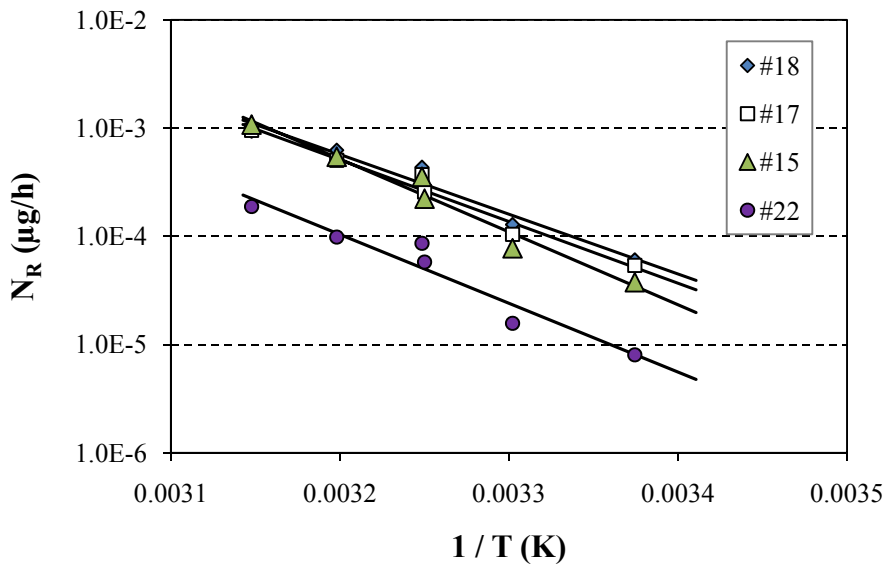

**Figure 4.18. Effect of ambient temperature on congener emissions from ballast BL-09C**

#### 4.3.6 Emissions from a Burst Light Ballast

Light ballast BL-08 failed during a live test. The power to the lamp was shut off (safety design) and there was a substantial amount of thick oily residue coating the interior surface of the sampling manifold (Figure 4.19). The PUF sample that was being collected had a dark yellow color, not generally seen during sampling (Figure 4.20). Because of safety concerns, the test was immediately suspended and the chamber was sealed and moved to a fume hood.

**Table 4.14. Estimated constants ( $f_1$  and  $f_2$ ) for the effect of ambient temperature on congener emissions from light ballasts**

Sample ID		Congener ID						
		#18	#17	#15	#22	#44	#52	#49
BL-02	$f_1$	24.9	27.2	--	--	--	--	--
	$f_2$	10100	10800	--	--	--	--	--
	$r^2$	0.9143	0.8997	--	--	--	--	--
	n	5	5	--	--	--	--	--
BL-05	$f_1$	36.6	38.5	22.0	23.7	11.8	14.6	12.3
	$f_2$	13600	14300	9350	10000	6520	7260	6650
	$r^2$	0.8821	0.8711	0.9896	0.9702	0.9868	0.9692	0.9914
	n	5	5	3	4	3	4	3
BL-09C	$f_1$	33.2	34.4	42.0	37.7	--	--	--
	$f_2$	12700	13100	15500	14600	--	--	--
	$r^2$	0.9637	0.9694	0.9666	0.9326	--	--	--
	n	6	5	5	5	--	--	--
BL-12	$f_1$	49.0	48.0	56.8	--	--	--	--
	$f_2$	16400	16200	19000	--	--	--	--
	$r^2$	0.9623	0.9605	0.9612	--	--	--	--
	n	5	5	4	--	--	--	--

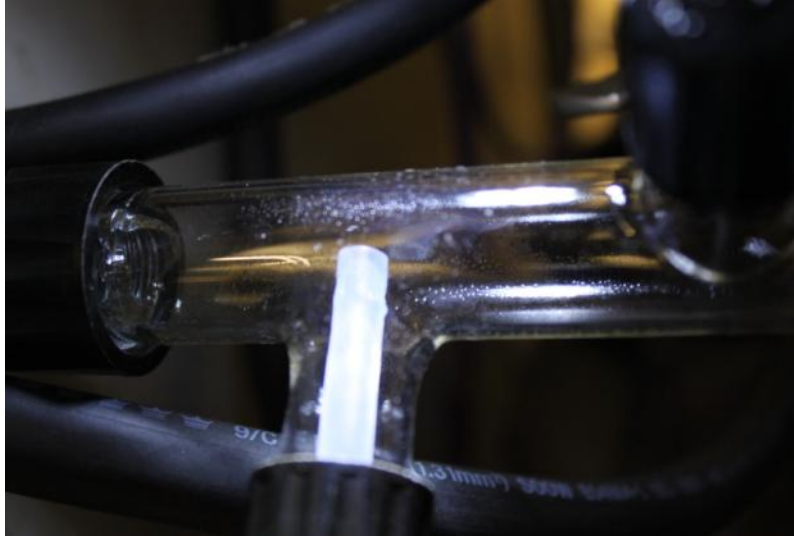
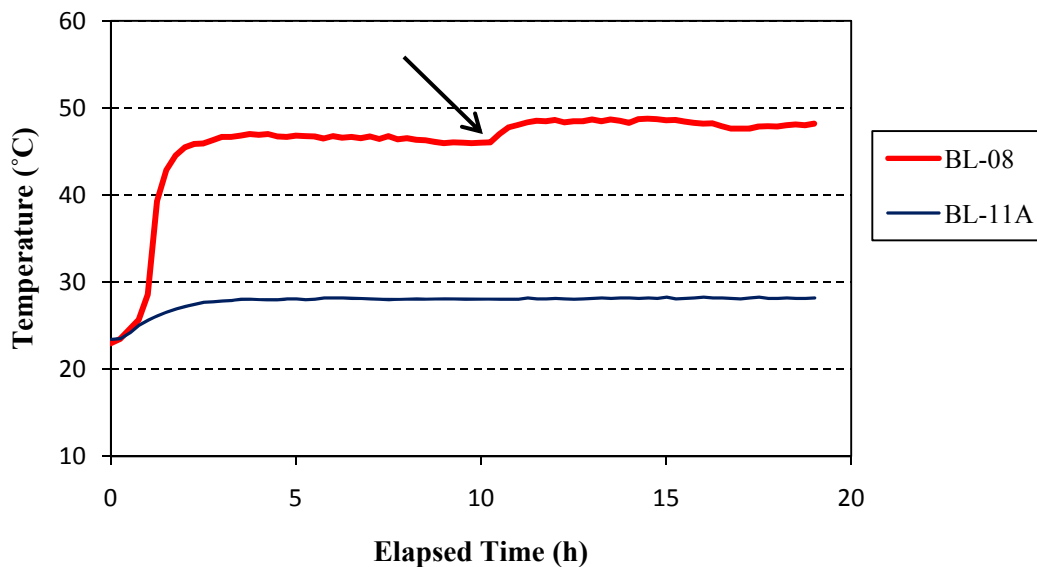

**Figure 4.19. Condensation of fluids in the chamber outlet manifold after the failure**



**Figure 4.20. Comparison of the PUF sampling cartridge for ballast BL-08 (right) to a normal cartridge (left)**

The temperature profile for the chamber air indicated that the ballast became overheated shortly after the test was started (Figure 4.21). The temperature increase suddenly at approximately 10 elapsed hours, suggesting the possible time when the ballast failed.



**Figure 4.21. Temperature profile for chamber air during the live test for ballast BL-08 (arrow indicates the sudden temperature increase; temperature profile for ballast BL-11A is shown for comparison)**

The ballast burst caused very high concentrations of PCBs in the air inside the chamber (Table 4.15). The air sample collected during this test is complex. The data presented in Table 4.15 are time-averaged concentrations over the 10-hour sampling period that started shortly after the test was started. Thus, the air concentrations immediately after the failure may have been much higher. The possibility that PUF captured some of the tiny liquid droplets immediately after the failure cannot be excluded.

Two sets of duplicate PUF air samples were collected from the sealed chamber seven days after the failure. The chamber with the burst ballast was connected to a mass flow controller running from the fume hood air source (Figure 4.22) and a flow rate of 1.8 L/min was maintained. Before air sampling, the chamber was purged with laboratory air for an hour. The emission rates are presented in Table 4.16.

The emission rates presented in Tables 4.15 and 4.16 likely include emissions from the burst ballast and the material that was deposited on chamber surfaces following the failure.

**Table 4.15. Concentrations of target congeners in chamber background (C<sub>0</sub>), during the live test (C) and the calculated emission rates (R) for ballast BL-08 <sup>[a]</sup>**

Congener ID	C <sub>0</sub> (µg/m <sup>3</sup> )	C (µg/m <sup>3</sup> )	R (µg/h)
#13	--	<del>25.1</del>	1.33
#15	<del>0.002</del>	106	5.63
#17	<del>0.008</del>	244	12.9
#18	<del>0.024</del>	766	40.6
#22	ND	100	5.32
#44	ND	48.5	2.57
#49	ND	43.6	2.31
#52	ND	63.2	3.35
#64	ND	<del>20.2</del>	1.07
Aroclor 1242	--	3270	173

<sup>[a]</sup> Values in strikethrough font are below practical quantification limit.

**Table 4.16. Concentrations of target congeners in chamber air seven days after the burst of ballast BL-08 and the calculated average emission rates (R) <sup>[a]</sup>**

Congener ID	Sample set 1 <sup>[b]</sup> (µg/m <sup>3</sup> )	Sample set 2 <sup>[b]</sup> (µg/m <sup>3</sup> )	R (µg/h)
#13	5.6	<del>5.03</del>	0.574
#15	18.6	21.9	2.19
#17	43.9	46.4	4.88
#18	154	159	16.9
#22	(18.2) <sup>[c]</sup>	21.7	2.15
#44	8.08	<del>9.47</del>	0.948
#49	6.78	<del>8.75</del>	0.839
#52	9.61	12.8	1.21
#64	2.74	<del>3.51</del>	0.337
Aroclor 1242	605	659	68.3

<sup>[a]</sup> Values in strikeout font are below practical quantification limit.

<sup>[b]</sup> Sample sets 1 and 2 were taken sequentially (4 hours apart); duplicate samples for each set.

<sup>[c]</sup> Recovery check standard failed to meet all acceptance criteria for this sample. Emission rate was calculated by using C<sub>2</sub>.





**Figure 4.22. PUF sampling from the sealed 53-L chamber containing the burst ballast**

After air sampling, the burst ballast chamber was opened inside the fume hood. The fan and its supporting wires were coated with a sticky black resin. The chamber walls were also darkened. These signs suggested a smoldering period immediately after the failure. The ballast showed leakage of a tar-like resin and gel-like material, as shown in Figure 4.23. Samples of these materials were collected and the analytical results are presented in Table 4.17.

The failed ballast was opened later for examination. Details are described in Section. 4.3.6.



**Figure 4.23. Light ballast CK-08 after the burst (the tar-like material is on the right and the gel-like material is on the left)**

**Table 4.17. PCB content in the gel-like material and the tar-like resin collected from the chamber floor (units: µg/g)**

Congener ID	Material <sup>[a]</sup>	
	“Gel”	Tar
#13	330	<del>16.7</del>
#18	5270	388
#17	1830	148
#15	1180	117
#22	1530	79.4
#52	924	<del>30</del>
#49	695	<del>24.6</del>
#44	854	<del>23.5</del>
#64	364	<del>9.8</del>
Aroclor 1242	31000	1900

<sup>[a]</sup> See Figure 4.23.

#### 4.3.7 Inside the Ballasts

##### 4.3.7.1 Physical Descriptions

Three ballasts (BL-02, BL-08, and BL-12) were opened to collect the fluids in the capacitor for Aroclor identification. According to ANZECC (1997), each ballast has a capacitor that is cylindrical or rectangular, encased in an aluminum container with a weld running all the way around the top edge with two quick-connect terminals. The capacitors in the three light ballasts fit the description well except that the one in BL-02 appeared to have three terminals.

There were no signs of fluid leakage in ballasts BL-02 and BL-12 (Figures 3.24 - 4.28). To collect the fluid sample, a screwdriver was used to punch a hole (approximately 5 mm long and 1.5 mm wide) along the top edges. The capacitor was almost full of liquid. Approximately 2.5 mL of fluid were collected from each of the two ballasts with a glass pipette. After sampling, the hole was sealed with a silicone rubber sealant. Samples of the potting material were taken from different locations and extracted by the method for caulk samples. The analytical results are presented in Section 4.3.7.2.



**Figure 4.24. Ballast BL-02 after the bottom metal plate was removed (the entire casing was filled with the potting material)**



**Figure 4.25. Ballast BL-02 (top side) (the capacitor is on the right)**



**Figure 4.26. Capacitor in ballast BL-02**

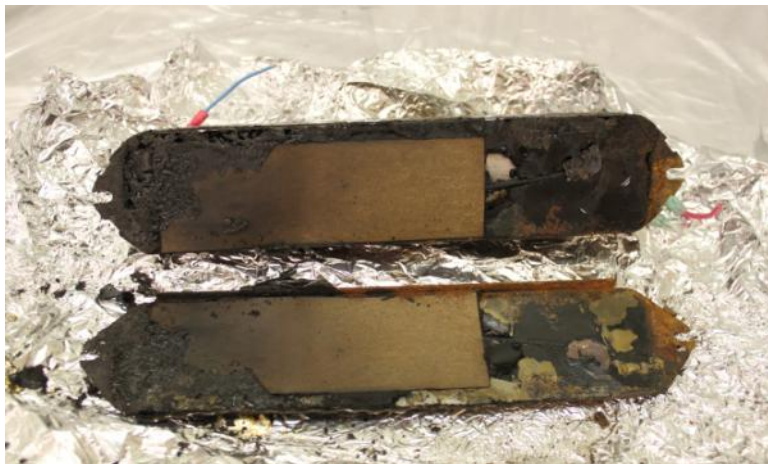

**Figure 4.27. Ballast BL-12 after removing the casing (the capacitor is on the left)**



**Figure 4.28. Capacitor in ballast BL-02**

BL-08 was the ballast that burst during a live test. The potting material on the opposite side of the capacitor showed signs of burning (Figure 4.29) and a total loss of elasticity. The capacitor in this ballast ruptured (Figure 4.30), creating a small opening (approximately 1 mm in diameter) near one of the two wire terminals. No fluid could be seen inside the capacitor. The attempt to collect a fluid sample with a glass pipette was unsuccessful. The opening was then widened with a screwdriver. The capacitor was turned upside down to allow any residual fluid to drip through the opening. Approximately 1.5 mL of fluid was collected. Unlike the fluids in ballasts BL-02 and BL-012, which were clear, this fluid was yellow (Figure 4.31). A small amount of fluid could be seen on the potting material that was in contact with the capacitor.



**Figure 4.29. Ballast BL-08 after removing the bottom metal plate (above) (there were signs of smoldering on the left side; capacitor is on the right side)**



**Figure 4.30. The capacitor in the burst ballast (BL-08) (note the expansion on both ends likely due to the instantaneous high pressure)**



**Figure 4.31. Fluid collected from the ruptured capacitor in ballast BL-08**

#### 4.3.7.2 Analytical Results

The fluids collected from the three capacitors were all Aroclor 1242 (Figure 4.32). The PCB content in the potting material varied from ballast to ballast. For ballast BL-02, the material near the capacitor contained a much higher concentration of PCBs than the opposite side (Table 4.18), suggesting early development of leakage. Ballast BL-12 showed a similar trend, but the contamination was more modest (Table 4.19). As can be expected, the potting material in the burst ballast (BL-08) was severely contaminated (Table 4.20).

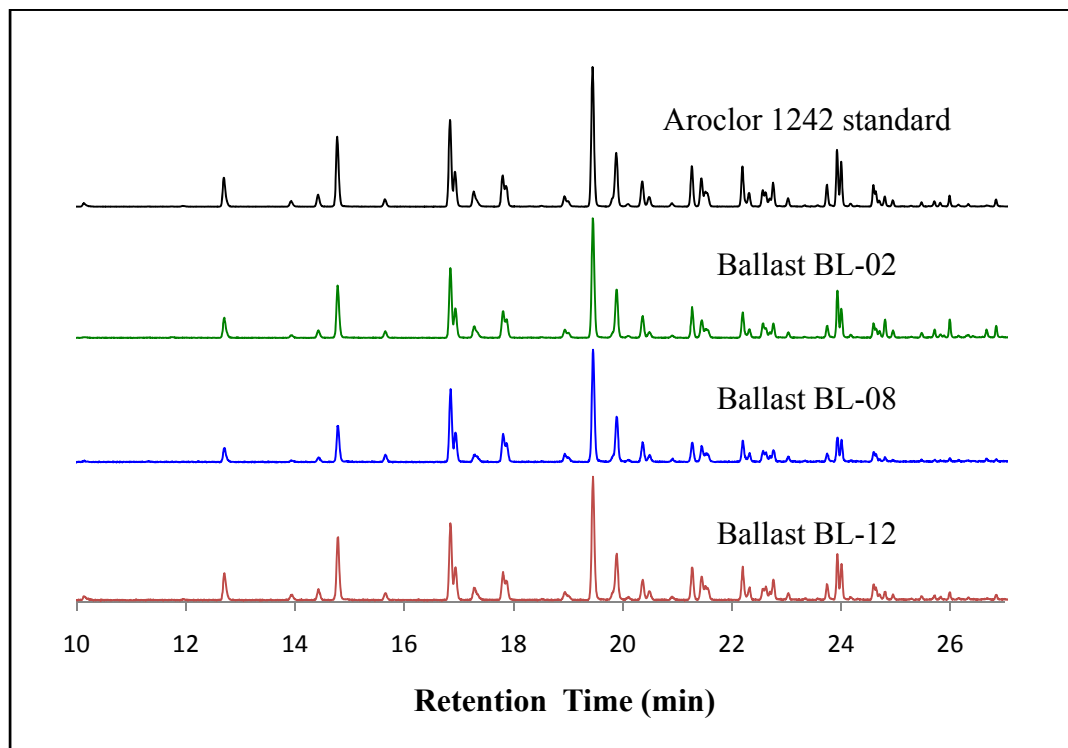

**Figure 4.32. Comparison of chromatograms for (from top to bottom) Aroclor 1242 standard and fluids in light ballasts BL-02, BL-08, and BL-12**

**Table 4.18. Congener content in potting material in BL-02 (units:  $\mu\text{g/g}$ )<sup>[a]</sup>**

Congener ID	Sampling Locations <sup>[b]</sup>			
	A	B	C	D
#13	<del>0.43</del>	11.5	93.1	379
#18	9.19	<b>179</b>	1890	5980
#17	3.68	<b>70.9</b>	707	2180
#15	3.45	111	669	1460
#22	1.10	<b>38.1</b>	544	1410
#52	0.71	<b>9.25</b>	266	1000
#49	<del>0.41</del>	<b>6.37</b>	179	593
#44	0.61	<b>5.95</b>	222	823
#64	<del>0.22</del>	<b>3.00</b>	94.8	312
Aroclor 1242	42.3	861	10800	33400

<sup>[a]</sup> Numbers in strikethrough font are below PQL; numbers in bold are average of duplicate samples with RSD greater than 25%.

<sup>[b]</sup> Locations:

A = from the end of the ballast opposite to the capacitor

B = from the middle section of the ballast

C = from the wiring side of the capacitor

D = from underneath the capacitor



**Table 4.19. Congener content in potting material in BL-12 (units:  $\mu\text{g/g}$ ) <sup>[a]</sup>**

Congener ID	Sampling Locations <sup>[b]</sup>			
	A	B	C	D
#13	0.86	10.2	47.3	30.1
#18	10.1	144	714	466
#17	4.00	52.2	252	165
#15	5.36	53.2	190	110
#22	2.53	50.9	260	125
#52	1.00	44.8	335	154
#49	0.77	32.9	230	108
#44	0.65	40.4	348	137
#64	<del>0.38</del>	20.1	153	58.4
Aroclor 1242	53.3	1036	6101	3200

<sup>[a]</sup> Numbers in strikethrough font are below PQL.

<sup>[b]</sup> Locations:

A = from the end of the ballast opposite to the capacitor

B = from the middle section of the ballast

C = from the wiring side of the capacitor

D = from underneath the capacitor

**Table 4.20. Congener content in the potting material in the burst ballast (BL-08) (units:  $\mu\text{g/g}$ ) <sup>[a]</sup>**

Congener ID	Sampling locations <sup>[b]</sup>					
	A	B	C	D	E	F
#13	57.8	1090	1680	<del>1722</del>	1080	1050
#18	898	18400	28100	27700	17000	17000
#17	308	5700	7940	8560	6070	5410
#15	262	2870	3980	3920	2500	2570
#22	220	5660	8370	8300	5610	5180
#52	102	4390	7300	6920	4630	4460
#49	72.5	3100	4950	4790	3230	3060
#44	79.0	4670	7180	6670	4860	4390
#64	40.1	1840	3000	2780	1980	1740
Aroclor 1242	4612	117000	176000	175000	118000	110000

<sup>[a]</sup> Numbers in strikethrough font are below PQL.

<sup>[b]</sup> Locations:

A = from the end of the ballast opposite to the capacitor; burned; lost elasticity;

B = from the middle section of the ballast;

C = from the wiring side of the capacitor;

D = from underneath the capacitor; w/ leaked fluid;

E = from outside of the ballast;

F = next to the wiring side of capacitor; w/ leaked fluid.

## 5. Discussion

### 5.1 Predicting the Emission Factors for PCB-Containing Caulk

When the congener content in the caulk is known, its emission factor can be estimated by using either the x-E correlation (Equation 4.4) or the P-N correlation (Equation 4.6). Details are discussed below.

#### 5.1.1 Using the x-E Correlation (Method 1)

The calculation includes two steps: (1) obtain the congener content in caulk [ $x_i$  in ( $\mu\text{g/g}$ )] and (2) calculate the emission factor using Equation 4.4. The coefficient,  $a_i$ , can be found in Table 4.3. For example, if a caulk contains 5000  $\mu\text{g/g}$  of congener #52, its estimated emission factor is:

$$E_i = 0.268 \times 5000 = 1340 \text{ } (\mu\text{g/m}^2/\text{h}) \quad (5.1)$$

For congeners that are not listed in Table 4.3, the P-S correlation (Equation 4.8) can be used to estimate coefficient  $a_i$ .

#### 5.1.2 Using the P-N Correlation (Method 2)

As illustrated, the calculation includes three steps by using the value for congener #52 mentioned above:

**Step 1:** Obtain the congener content in caulk [ $x_i$  in ( $\mu\text{g/g}$ )] and the vapor pressure ( $P_i$  in torr):

$$x_i = 5000 \text{ } (\mu\text{g/g}) \quad (5.2)$$

$$P_i = 1.497 \times 10^{-4} \text{ (torr)} \quad (5.3)$$

**Step 2:** Calculate the normalized emission factor ( $N_{Ei}$ ) from Equation 4.6:

$$\ln N_{Ei} = 14.02 + 0.976 \ln 1.497 \times 10^{-4} = 5.42 \quad (5.4)$$

$$N_{Ei} = 226 \text{ } (\mu\text{g/m}^2/\text{h}) \quad (5.5)$$

**Step 3:** Convert the normalized emission factor to the emission factor ( $E_i$ ):

$$E_i = 226 \div 1000 \times 5000 = 1130 \text{ } (\mu\text{g/m}^2/\text{h}) \quad (5.6)$$

#### 5.1.3 Predictive Errors

The predictive errors for the two methods were calculated by using Equation 5.7, and the results are presented in Table 5.1.

$$\varepsilon = \left| \frac{E_p - E_m}{E_m} \right| \times 100\% \quad (5.7)$$

where  $\varepsilon$  = predictive error (%)  
 $E_p$  = predicted emission factor ( $\mu\text{g}/\text{m}^2/\text{h}$ )  
 $E_m$  = measured emission factor ( $\mu\text{g}/\text{m}^2/\text{h}$ )

**Table 5.1. Predictive error for the x-E and P-N correlations** <sup>[a]</sup>

Congener ID	Correlation	
	x-E (Eq. 4.4) <sup>[b]</sup>	P-N (Eq. 4.6) <sup>[c]</sup>
#52	28.0%	30.0%
#66	39.7%	40.8%
#101	32.2%	32.3%
#105	13.3%	21.6%
#110	32.0%	31.2%
#118	26.8%	29.7%
#154	39.0%	59.4%
Average	30.1%	35.0%

<sup>[a]</sup> Sample CK-13 (laboratory-mix caulk) was excluded.

<sup>[b]</sup> Coefficients from Table 4.3.

<sup>[c]</sup> Coefficients from Equation 4.6.

#### 5.1.4 Method Selection

Method 1 is recommended for congeners that are listed in Table 4.3. Method 2 is recommended for other congeners.

#### 5.1.5 Predicting the Emission Factors for Aroclor 1254

The emission factor for Aroclor 1254 can be calculated from Equation 4.18. The average predictive error was 32.1%, excluding the laboratory-mixed sample (CK-13). It is emphasized that the composition of the congener mixture in air samples is significantly different from that in the Aroclor 1254 standard or that in caulk samples. In general, there are proportionally more volatile congeners in the air. As a result, there is greater uncertainty when the air concentration is expressed in Aroclor. See section 5.4 for more discussion.

### 5.1.6 Estimating the Air Concentration Due to Emissions from Caulk

At steady-state conditions, Equation 5.8 (for a single source) or Equation 5.9 (for multiple sources) can be used to estimate the contribution of emissions from caulk to the PCB concentration in the air:

$$C = \frac{AE}{Q} \quad (5.8)$$

where  $C$  = congener or Aroclor concentration in room air ( $\mu\text{g}/\text{m}^3$ )  
 $A$  = source area ( $\text{m}^2$ )  
 $E$  = emission factor for a congener or Aroclor ( $\mu\text{g}/\text{m}^3/\text{h}$ )  
 $Q$  = air change flow rate ( $\text{m}^3/\text{h}$ )

$$C = \frac{\sum_{i=1}^n A_i E_i}{Q} \quad (5.9)$$

where  $C$  = congener or Aroclor concentration in room air ( $\mu\text{g}/\text{m}^3$ )  
 $n$  = number of sources  
 $A_i$  = source area for the  $i^{\text{th}}$  source ( $\text{m}^2$ )  
 $E_i$  = emission factor for the  $i^{\text{th}}$  source for a congener or Aroclor ( $\mu\text{g}/\text{m}^2/\text{h}$ )  
 $Q$  = air change flow rate ( $\text{m}^3/\text{h}$ )

## 5.2 Using the Advanced Emission Models for Emissions from Caulk and Other Building Materials

The results presented above represent the current status of the caulk samples. To estimate their emissions in the past or future, mathematical models must be used. Emissions of volatile and semi-volatile chemicals from solid building materials have been studied extensively in the past two decades and, consequently, many mass transfer models have been developed (Little et al., 1994; Huang and Haghghat, 2002; Xu and Yang, 2003; Deng and Kim, 2004; Qian, et al., 2007). While differing in complexity and applicability, these models have several features in common:

- They are all derived from the Fick's second law.
- They use the same set of parameters to describe the source, i.e., the content of the chemical in the source, the solid/air partition coefficient, the diffusion coefficient of the chemical in the source, and the area and thickness of the source.
- With one exception, they all require that a non-linear equation be solved.

To apply the mass transfer models to PCB emissions from caulk, the partition and diffusion coefficients for PCB congeners must be determined. Although several methods are available for experimental determination of these two parameters (Bodalal et al., 2000; Cox et al., 2001, Haghight et al., 2002), their applicability to PCB congeners is questionable because of the low vapor pressures of these compounds. In this study, chamber data and existing quantitative structure-activity relationship (QSAR) models were used to make rough estimations of these two parameters. Technical details are described in Appendix C. The simulation conditions and results are summarized below.

- Room volume 300 m<sup>3</sup>
- Ventilation rate 1 air change per hour
- Caulk area 0.5 m<sup>2</sup>
- Caulk density 1.5 g/cm<sup>3</sup>
- Initial content of Aroclor 1254 in caulk 10% by weight

The time-concentration profiles and percent of mass emitted for congeners #52, #77, #154, and #187 over a 50-year period are shown in Figures 5.1 and 5.2, respectively. These results should be considered as semi-quantitative.

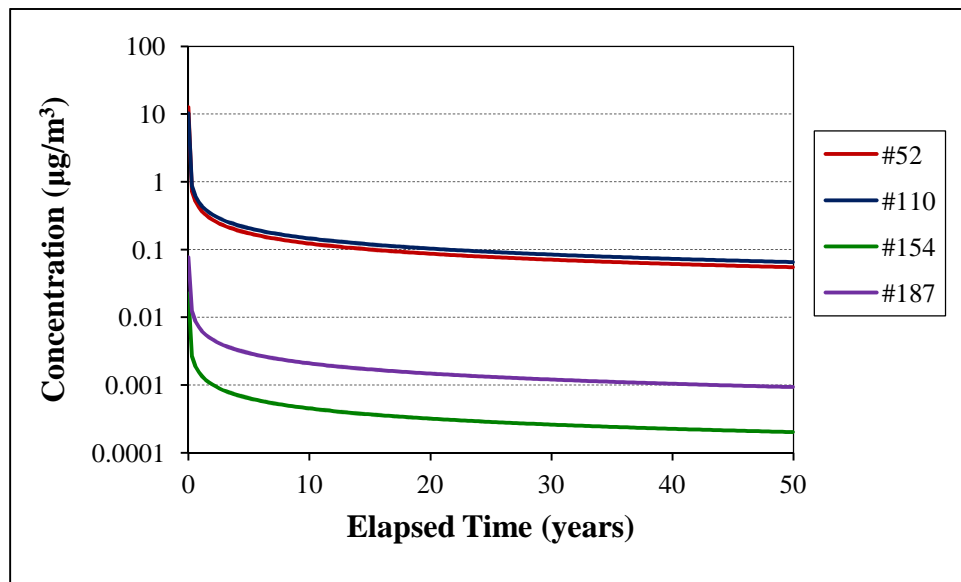

**Figure 5.1. Predicted congener concentrations over a 50-year period**

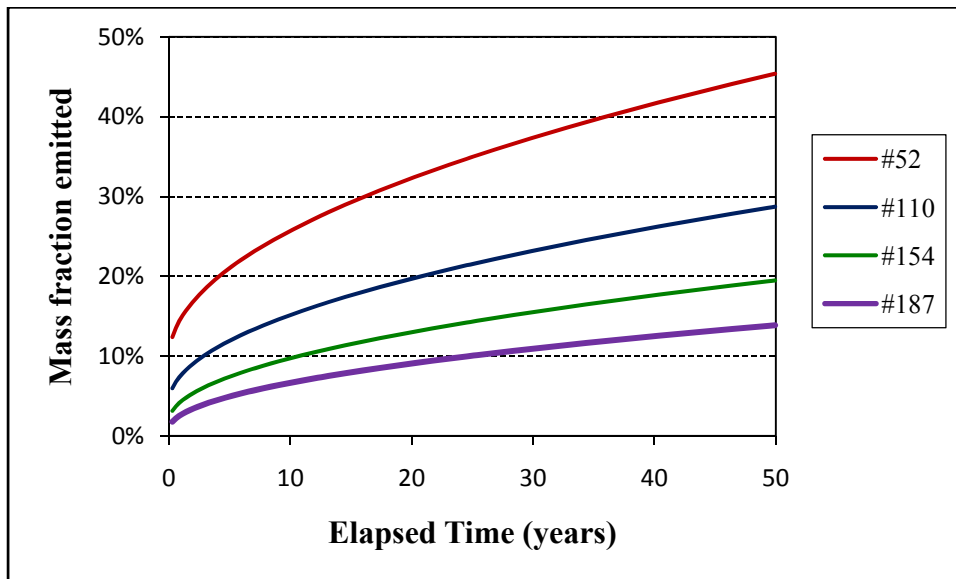

**Figure 5.2. Percent of congener mass emitted over a 50-year period**

### 5.3 Using the Emissions Data for Light Ballasts

The behavior of PCB-containing light ballasts as an emission source is difficult to predict. The test results showed that ballasts with no fluid leakage or with small amounts of fluid leakage do not emit significant amounts of PCBs. The rates of PCB emissions from light ballasts increase quickly at elevated temperature. The live tests (i.e., with electrical load) conducted in this study may have been at lower temperatures than the operating temperatures under realistic operating conditions. In addition, chamber walls may adsorb PCBs and cause underestimation of the emission rate. Thus, the test results should be considered the lower bounds for the emission rates. Because the PCB-containing ballasts that are currently in use have approached or even exceeded their designed service life, leakage of PCB fluid will develop. More importantly, the rate of capacitor failure increases drastically as the light ballasts age (Philips, undated). PCB release from failed light ballasts have been reported in the United States (Staiff et al., 1974) and Japan (Funakawa et al., 2002; Hosomi, 2005). In this study, ballast BL-08 burst during a live test and, consequently, most of the Aroclor 1242 in the capacitor was ejected into the air inside the test chamber. Equation 5.10 (Hosomi, 2005) is recommended for estimating the PCB concentration in room air at steady-state conditions:

$$C = \frac{\sum_{i=1}^n R_i}{Q} \quad (5.10)$$

where      C = congener or Aroclor concentration in room air ( $\mu\text{g}/\text{m}^3$ )  
                $R_i$  = emission rate for ballast  $i$  ( $\mu\text{g}/\text{h}$ )  
               n = number of ballasts in the room  
               Q = ventilation flow rate ( $\text{m}^3/\text{h}$ )

For predicting the release of PCB fluid from a failed ballast, an existing liquid spill model is recommended. Details are described in Appendix D.

This study did not test any light ballasts with apparent fluid leakages. Consequently, the test results may not be representative of the large population of PCB-containing light ballasts that are currently in use in the buildings in the United States.

#### 5.4 Expressing the PCB concentrations as Aroclors

It has been a common practice to express the PCB concentrations in some environmental samples as Aroclors (U.S. EPA, 2008c). The advantage of this approach is its simplicity. However, the uncertainties associated with this method have never been fully addressed. Because the Aroclor concentration is a calculated value based on the congener content in the Aroclor standards, the uncertainty of the calculation depends on how similar the congener profile of the sample is to that of the Aroclor standards. For example, the congener profile for caulk CK-10 (a weathered field sample in good condition) is similar to that for the Aroclor 1254 standard (Figure 4.1), and the calculated Aroclor concentrations based on individual congeners are very close to the average and the relative standard deviation (RSD) is only 10% (Table 5.2). Caulk CK-02 (another field caulk) and C-13 (a laboratory-mix caulk) had similar variations. For caulk CK-09, severely deteriorated, the variation was much greater. The variations for air samples were even worse because, proportionally, there are more volatile congeners in the air than in caulk. Clearly, the greater the variations between congeners, the more uncertainty there will be in the calculated Aroclor concentration. It is also a critical factor to select the congener peaks, especially for air samples. As shown in Table 5.2, the results were significantly different depending on whether congener #52, the most abundant congener in caulk emissions, was included or not. A similar problem exists for air samples associated with emissions of Aroclor 1242 from light ballast (Table 5.3).

The authors recommend further investigation into these issues. Standardization is needed for selecting congener peaks for calculating the Aroclor concentrations in environmental samples, especially air samples.



**Table 5.2. Variations of Aroclor concentrations in caulk and air samples calculated based on five individual congeners**

Sample type	Caulk ID	Calculated Aroclor 1254 concentrations based on individual congeners <sup>[a]</sup>					Concentration of Aroclor 1254 <sup>[b]</sup>	
		#52	#101	#110	#118	#105	Mean	RSD
Caulk ( $\mu\text{g/g}$ )	CK-02	58500	75800	78400	80600	81100	74900	13%
	CK-09	6210	69000	109000	138000	144000	93300	61%
	CK-10	112000	140000	142000	145000	144000	136000	10%
	CK-13	7610	7680	8050	9370	8680	8280	9.0%
Chamber air ( $\mu\text{g/m}^3$ )	CK-02	199	61.4	32.1	20.6	12.8	65.2	118%
	CK-09	25.2	76.0	58.8	41.4	28.6	46.0	46%
	CK-10	381	91.4	46.6	27.6	20.2	113	134%
	CK-13	22.7	4.91	2.81	1.63	--	8.01	123%

<sup>[a]</sup> Calculated from Equations 4.14 and 4.15 in Section 4.1.10.

<sup>[b]</sup> Calculated from Equation 4.1.6 in Section 4.1.10.

**Table 5.3. Variations of Aroclor concentrations in air sample for light ballast BL-08 calculated based on five individual congeners (concentration units:  $\mu\text{g/m}^3$ ) <sup>[a][b]</sup>**

Calculated Aroclor 1254 concentrations based on individual congeners					Concentration of Aroclor 1242	
C#17	C#18	C#22	C#44	C#52	Mean	RSD
1061	1202	434	146	182	605	82.0%

<sup>[a]</sup> The air sample was taken four days after the burst.

<sup>[b]</sup> See footnotes [a] and [b] for Table 5.2.

## 5.5 Study Limitations

This study was conducted in a relatively short period of time and only a few samples were tested. It was not our intention to collect and test samples that are statistically representative of the primary sources in U.S. building stock. The study was not intended to link the test results to the buildings from which the samples were collected.

This study investigated several factors that may affect PCB emissions from caulk, including the PCB content of the source, the properties of PCB congeners, temperature, and exposed versus unexposed surfaces of the source. The effects of humidity and ventilation rate were not evaluated. The moisture content of the air may have a significant effect on the emissions of hydrophilic pollutants such as formaldehyde, but PCBs are highly hydrophobic, so the effect of humidity on PCB emissions is expected to be negligible. Although

the effect of ventilation rate on air concentrations can be significant due to different levels of dilution, its effect on the emission rate from a dry source (such as caulk) is rather small.

For similar reasons, we also chose not to evaluate the effects of humidity and ventilation rates on PCB emissions from light ballasts. Although a light ballast that is leaking may be considered an evaporative source, none of the 19 light ballasts we evaluated had any visible signs of PCB leakage.

Because of time constraint and technical difficulty, this study did not investigate the effects of caulk composition and weathering conditions on PCB emissions. It should be a topic of future research because understanding such effects will reduce the uncertainty in the QSAR models for PCB emissions such as the x-E correlation.

Over a dozen types of primary sources have been identified in PCB-contaminated buildings (EH&E, 2011). Our study tested only caulk, light ballasts, and very limited number of ceiling tile samples because of the unavailability of other types of samples and short testing schedule.

## 6. Conclusion

Among the 12 field caulk samples tested, 11 were determined to contain Aroclor 1254 and the remaining sample was determined to contain Aroclor 1260. The Aroclor content ranged from less than 10 to 136000  $\mu\text{g/g}$ . A linear correlation, designated the x-E correlation, exists between the emission factor and Aroclor or congener content in caulk. There are significant differences in the congener profiles between the caulk and air samples; proportionally, more volatile congeners are found in the air samples. An excellent correlation exists between the normalized emission factor and the vapor pressure of the congener on a logarithmic scale. This correlation, which is designated the P-N correlation, allows the estimation of the emission factor for a congener in the caulk as long as its content in the caulk and vapor pressure are known. These correlations make it possible to estimate the emission factors for either congeners or Aroclor 1254, as long as their content in the caulk is known. PCB emissions increase as temperature increases. The test of a field caulk sample showed that, for every 10 °C increase between 10 and 50 °C, the emission factor increases by a factor of 5.4 to 9. The PCB emissions from the exposed surface are less than the emissions from a newly cut surface, but the difference is 40% or less based on a limited number of tests. Further study should include developing methods for measuring the partition and diffusion coefficients for PCB congeners in caulk and other building materials. These parameters can help further understand the sources, sinks, and mitigation methods for PCBs in buildings. The effect of the composition of caulk and sealants on PCB emissions should also be investigated.

The emissions from PCB-containing light ballasts are difficult to predict. Overall, the emission rates are small at room temperature for light ballasts with no or little leakage of fluid. The emission rate increases significantly at elevated temperature. The emission rates determined in the test chamber may be much lower than those in realistic use conditions because, in the latter case, the ballasts are often located in enclosures causing higher operating temperatures. This study did not test any light ballasts with visible fluid leakage because of safety concerns. One ballast unit burst during a live test, causing release of Aroclor 1242 fluid from its ruptured capacitor. Thus, the presence of PCB-containing light ballasts in buildings may pose a potential risk to the occupants because most existing PCB-containing light ballasts have approached or exceeded their designed service life and because the decontamination process is both difficult and costly.

Overall, this study established a direct link between the PCB content in primary sources (caulk and light ballasts) and PCB concentrations in room air by experimentally measuring the emission rates. The data and empirical models reported above can be used to rank indoor PCB sources or as input for indoor contaminant models and for exposure models. However, it is beyond the scope of this study to link the emissions to potential health risks.

## **Acknowledgments**

The authors thank the building owners who provided field samples for this study; Kimberley Tisa of EPA Region 1 and Dennis Santella and James Haklar of EPA Region 2 for facilitating sample acquisition; Jacqueline McQueen of the EPA Office of Science Policy for assistance in communications; Kent Thomas of the EPA National Exposure Research Laboratory for technical consultation; Dale Greenwell of the EPA National Risk Management Research Laboratory, Russell Logan, Corey Mocka, and Aaron DeBlois of ARCADIS for laboratory support; Robert Wright and Joan Bursey of the EPA National Risk Management Research Laboratory and Libby Nessley of ARCADIS for QA support.

## References

(Website accessibilities were last verified on March 28, 2011)

- ANZECC (1997). Identification of PCB-containing capacitors, Australian and New Zealand Environment and Conservation Council (ANZECC).  
<http://www.environment.gov.au/settlements/publications/chemicals/scheduled-waste/pubs/pcbaid.pdf>
- ASTM (2010). ASTM D5116-10 Standard guide for small-scale environmental chamber determinations of organic emissions from indoor materials/products, ASTM International, West Conshohocken, PA.
- ATSDR (2000). Toxicological profile for polychlorinated biphenyls (PCBs), Ch 5, Production, import/export, use, and disposal, Agency for Toxic Substances and Disease Registry.  
<http://www.atsdr.cdc.gov/toxprofiles/tp.asp?id=142&tid=26>
- Balfanz, E., Fuchs, J., and Kieper, H. (1993). Sampling and analysis of polychlorinated biphenyls (PCBs) in indoor air due to permanently elastic sealants, *Chemosphere*, 26(5): 871-880.
- Bodalal, A, Zhang J. S., and Plett E. G. (2000). A method for measuring internal diffusion and equilibrium partition coefficients of volatile organic compounds for building materials, *Building and Environment*, 35: 101–110.
- Bodalal, A., Zhang, J. S., Plett, E. G., and Shaw, C. Y. (2001). Correlations between the internal diffusion and equilibrium partition coefficients of volatile organic compounds (VOCs) in building materials and the VOC properties, *ASHRAE Transactions*, 107: 789–800.
- Cox, S. S., Zhao, D., and Little, J. C. (2001). Measuring partition and diffusion coefficients for volatile organic compounds in vinyl flooring, *Atmospheric Environment*, 35: 3823–30.
- Dean, R. B, and Dixon, W. J. (1951). Simplified statistics for small numbers of observations, *Analytical Chemistry*, 23(4): 636–638.
- Deng, B., and Kim, C. N. (2004). An analytical model for VOCs emission from dry building materials, *Atmospheric Environment*, 38: 1173–1180.
- EH&E (2011). Literature review of remediation methods for PCBs in buildings, prepared for U.S. EPA by Environmental Health & Engineering, Inc., Needham, MA (in press).
- EIP Associates (1997). Polychlorinated biphenyls (PCBs) source identification, prepared for: Palo Alto Regional Water Quality Control Plant.  
<http://www.cityofpaloalto.org/civica/filebank/blobload.asp?BlobID=3772>
- Environment Canada (1991). Identification of lamp ballasts containing PCBs, Environment Canada Report EPS 2/CC/2 (Revised). <http://www.ec.gc.ca/Publications/default.asp?lang=En&xml=F1D91988-3B5E-4956-A705-78D054685FFE>

Fischer, R. C., Wittlinger, R. and Ballschmiter, K. (1992). Retention-index based vapor pressure estimation for polychlorobiphenyl (PCB) by gas chromatography, *Fresenius' Journal of Analytical Chemistry*, 342(4): 421-425.

Foreman, W. T. and Bidleman, T. F. (1985). Vapor pressure estimates of individual polychlorinated biphenyls and commercial fluids using gas chromatographic retention data, *Journal of Chromatography A*, 330: 203-216.

Frame, G. M., Cochran, J. W., and Bøwadt, S. S. (1996). Complete PCB congener distributions for 17 Aroclor mixtures determined by 3 HGC systems optimized for comprehensive, quantitative, congener-specific analysis, *Journal of High Resolution Chromatography*, 19(12): 657-668.

Fromme H., Baldauf, A. M., Klautke, O., Piloty, M., and Bohrer, L. (1996). Polychlorinated biphenyls (PCB) in caulking compounds of buildings — assessment of current status in Berlin and new indoor air sources, *Gesundheitswesen*, 58(12): 666-672.

Funakawa, M., Takada, M., Niida, M., and Hosomi, M. (2002). Volatilization of PCB from PCB containing ballast in fluorescent lamp and indoor PCB pollution, *Journal of Environmental Chemistry*, 12: 615-620.

Guo, Z. (2000), Simulation tool kit for indoor air quality and inhalation exposure (IAQX), Version 1.0 user's guide, U.S. EPA, National Risk Management Research Laboratory, Research Triangle Park, NC, Report No. EPA-600/R-00-094 (NTIS PB2001-101221), 76 pp.

Guo, Z. (2002). Review of indoor emission source models — part 2. parameter estimation, *Environmental Pollution*, 120: 551-564.

Guo, Z. (2005). Program PARAMS user's guide, U.S. EPA, National Risk Management Research Laboratory, Research Triangle Park, NC, Report No. EPA-600/R-05/066, 32 pp.

Haghighat, F., Lee, C-S., and Ghaly, W. S. (2002). Measurement of diffusion coefficients of VOCs for building materials: review and development of a calculation procedure, *Indoor Air*, 12: 81-91.

Herrick, R. F., McClean, M. D., Meeker, J. D., Baxter, L. K., and Weymouth, G. A. (2004). An unrecognized source of PCB contamination in schools and other buildings, *Environmental Health Perspectives*, 112(10): 1051-1053.

Herrick, R. F., Meeker, J. D., Hauser, R., Altshul, L., and Weymouth, G. A. (2007). Serum PCB levels and congener profiles among US construction workers, *Environmental Health*, 6(1): 25-32.

Hosomi, M. (2005). Volatilization of PCBs from PCB-containing ballast in fluorescent lamp and indoor PCB pollution: odor of PCBs, *Journal of Japan Association on Odor Environment*, 36(6): 323-330.

Huang, H., and Haghighat, F. (2002). Modelling of volatile organic compounds emission from 3 dry building materials, *Building and Environment*, 37: 1117-1126.

Kohler M., Tremp, J., Zennegg, M., Seiler, C., Minder-Kohler, S., Beck, M., Lienemann, P., Wegmann, L., and Schmid, P. (2005). Joint sealants: an overlooked diffuse source of polychlorinated biphenyls in buildings. *Environmental Science & Technology*, 39(7): 1967-1973.

Little, J. C., Hodgson, A. T., and Gadgil, A. J. (1994). Modeling emissions of volatile organic compounds from new carpets, *Atmospheric Environment*, 28(2): 227-234.

MacLeod, K. (1979). Sources of emissions of polychlorinated biphenyls into the ambient atmosphere and indoor air, U.S. EPA, Health Effect Research Laboratory, Research Triangle Park, Report EPA-600/4-79-022.

MacLeod, K. (1981). Polychlorinated biphenyls in indoor air, *Environmental Science & Technology*, 15: 926-928.

Minegishi, T., Allen, J. G., MacIntosh, D. L. (2010). Predicting seasonal indoor PCBs concentrations based on fundamental equations, *The 30<sup>th</sup> International Symposium on Halogenated Persistent Pollutants*, September 12-17, 2010, San Antonio, Texas, paper ID 1569. <http://www.xcdtech.com/dioxin2010/pdf/1569.pdf>

Monsanto (undated). Aroclor plasticizers, Monsanto Technical Bulletin O/PL-306.

Mydlová-Memersheimerová, J., Tienpont, B., David, F., Krupčík, J., and Sandra, P. (2009). Gas chromatography of 209 polychlorinated biphenyl congeners on an extremely efficient nonselective capillary column, *Journal of Chromatography A*, 1216 (32): 6043-6062.

NERL (2010). A research study to investigate PCBs in school buildings, EPA 600R-10/074, National Exposure Research Laboratory. <http://www.epa.gov/pcb sincaulk/research-plan.pdf>

Newman, D. M. (2010). PCBs in schools: what about school maintenance workers? *New Solutions*, 20(2): 189-191.

NIOSH (1975). Current Intelligence Bulletin 7: Polychlorinated biphenyls (PCBs), National Institute of Occupational Safety and Health. [http://www.cdc.gov/niosh/78127\\_7.html#background](http://www.cdc.gov/niosh/78127_7.html#background)

Paasivirta, J. and Sinkkonen, S. I. (2009). Environmentally relevant properties of all polychlorinated biphenyl congeners for modeling their fate in different natural and climate conditions, *Journal of Chemical Engineering Data*, 34: 1189-1213.

Philips Lighting (undated). Ballast lifetime calculations, Philips Lighting Technical Note TN005. [http://lighting.philips.com/gl\\_en/global\\_sites/fluo-gear/dimming/download/pdf/technical-notes/tn005.pdf](http://lighting.philips.com/gl_en/global_sites/fluo-gear/dimming/download/pdf/technical-notes/tn005.pdf)

Piloty, M. and Koppl, B. (1993). PCB caulking sealants — experiences and results of measures in Berlin and decontamination of a school (Part I), *Gesundheitswesen*, 55(11): 577-81.

Prignano, A. L., Narquis, C. T., Hyatt, J. E. (2008). Generating the right PCB data: determination of Aroclors versus PCB congeners, Waste Management 2008 Conference, February 24-28, Phoenix, AZ.

Priha, E., Hellman, S., and Sorvari, J. (2005). PCB contamination from polysulphide sealants in residential areas — exposure and risk assessment, *Chemosphere*, 59(4): 537-543.

Qian, K., Zhang, Y., Little, J. C., and Wan X. (2007). Dimensionless correlations to predict VOC emissions from dry building materials, *Atmospheric Environment*, 41: 352–359.

Rensselaer Lighting Research Center (2004). Methods for the efficient operation of ceiling-mounted fluorescent residential luminaries.  
<http://www.lrc.rpi.edu/programs/lightingtransformation/heatManagement/pdf/finalThermalTesting.pdf>

Robson M., Melymuk L., Csiszar S. A., Giang A., Diamond M. L., Helm P. A. (2010). Continuing sources of PCBs: the significance of building sealants, *Environmental International*, 36: 506-513.

Rorabacher, D. B. (1991). Statistical treatment for rejection of deviant values: critical values of Dixon Q parameter and related subrange ratios at the 95 percent confidence level, *Analytical Chemistry*, 63 (2): 139–146.

Rushneck, D. R., Beliveau, A., Fowler, B., Coreen, H., Hoover, D., Kaye, K., Berg, M., Smith, T., Telliard, W. A., Roman, H., Ruder, E., and Ryan, L. (2004). Concentrations of dioxin-like PCB congeners in unweathered Aroclors by HRGC/HRMS using EPA Method 1668A, *Chemosphere*, 54(1): 79-87.

Schripp, T., Nachtwey, B., Toelke, J., Salthammer, T., Uhde, E., Wensing, M., and Bahadir, M. (2007). A microscale device for measuring emissions from materials for indoor use, *Analytical and Bioanalytical Chemistry*, 387(5): 1907-1919.

Staiff, D. C., Quiby, G. E., Spencer, D. L., and Starr, Jr., H. G. (1974). Polychlorinated biphenyl emission from fluorescent lamp ballasts, *Bulletin of Environmental Contamination and Toxicology*, 12(4): 455-463.

Stallings, C., Zartarian, V., and Glen, G. (2008). Stochastic human exposure and dose simulation model for multimedia, multipathway chemicals SHEDS-multimedia model, Version 3 user guide, EPA 600/R-08/118.  
[http://www.epa.gov/heads/products/sheds\\_multimedia/sheds\\_mm.html](http://www.epa.gov/heads/products/sheds_multimedia/sheds_mm.html)

UNEP (1999). Guidelines for the identification of PCBs and materials containing PCBs, United Nations Environment Programme. <http://www.chem.unep.ch/Publications/pdf/GuidIdPCB.pdf>

U.S. Department of Commerce (2009). PCBs in concrete structures.  
[http://www.docep.wa.gov.au/worksafe/content/safety\\_topics/hazardous\\_substances/Additional\\_resources/PCBs\\_in\\_concrete\\_structures.html#3](http://www.docep.wa.gov.au/worksafe/content/safety_topics/hazardous_substances/Additional_resources/PCBs_in_concrete_structures.html#3)

U.S. EPA (1993). PCBs in fluorescent light fixtures, U.S. Environmental Protection Agency, Region 10, Air and Toxics Division; U.S. Government Printing Office, Washington, DC.

U.S. EPA (1999). EPA method TO-10A (1999), Determination of pesticides and polychlorinated biphenyls in ambient air using low volume polyurethane foam (PUF) sampling followed by gas chromatographic/multi-detector detection (GC/MD), EPA Center for Environmental Research Information,



Office of Research and Development, EPA/625/R-96/010b.  
<http://www.epa.gov/ttn/amtic/files/ambient/airtox/to-10ar.pdf>

U.S. EPA (2007). EPA method 8082A, polychlorinated biphenyls (PCBs) by gas chromatography.  
<http://www.epa.gov/waste/hazard/testmethods/sw846/pdfs/8082a.pdf>

U.S. EPA (2008a). Health effects of PCBs. <http://www.epa.gov/epawaste/hazard/tsd/pcbs/pubs/effects.htm>

U.S. EPA (2008b). EPA method 1668B, chlorinated biphenyl congeners in water, soil, sediment, biosolids and tissue by high resolution gas chromatography/high resolution mass spectrometry (HRGC/HRMS).  
<http://epa.gov/waterscience/methods/method/files/1668.pdf>

U.S. EPA (2008c). Test methods for evaluating solid waste, physical/chemical methods, in EPA publication SW-846, U.S. EPA, Government Printing Office: Washington, D.C.

U.S. EPA (2009). EPA news release — EPA announces guidance to communities on PCBs in caulk of buildings constructed or renovated between 1950 and 1978 / EPA to gather latest science on PCBs in caulk.  
<http://yosemite.epa.gov/opa/admpress.nsf/6fa790d452bcd7f58525750100565efa/28c8384eea0e67ed8525763c0059342f!OpenDocument>

Wilson, L. R., Palmer, P. M., Belanger, E. E., Cayo, M. R., Durocher, L. A., Hwang, S-A. A., and Fitzgerald, E. F. (2011). Indoor air polychlorinated biphenyl concentrations in three communities along the upper Hudson River, New York, *Archives of Environmental Contamination and Toxicology*, 61(3): 530-538.

Xu, Y. and Zhang, Y. (2003). An improved mass transfer based model for analyzing VOC emissions from building materials, *Atmospheric Environment*, 37: 2497–2505.

Zartarian, V., Glen, G., Smith, L. and Xue, J. (2008). Stochastic human exposure and dose simulation model for multimedia, multipathway chemicals, SHEDS-multimedia model, Version 3 technical manual, U.S. Environmental Protection Agency, EPA 600/R-08/118.  
[http://www.epa.gov/heads/products/sheds\\_multimedia/sheds\\_mm.html](http://www.epa.gov/heads/products/sheds_multimedia/sheds_mm.html)

## Appendix A

### Test Conditions for Caulk Samples and Determination of PCB Concentrations

**Table A.1. Test conditions for PCB emissions from caulk at room temperature<sup>[a]</sup>**

Caulk ID	Air flow rate (L/min)	Temperature (°C)	Source area (cm <sup>2</sup> )
CK-01 <sup>[b]</sup>	0.449	22.2	3.63
	0.455	22.2	3.26
CK-02 <sup>[b]</sup>	0.455	22.2	3.12
	0.454	22.2	3.4
CK-03	0.481	22.2	2.25
CK-04	0.452	22.2	2.85
CK-05	0.428	22.2	1.46
CK-06	0.450	22.2	3.79
CK-07 <sup>[b]</sup>	0.444	22.2	2.96
	0.441	22.2	3.31
CK-08	0.472	22.2	0.21
CK-09	0.446	22.2	2.34
CK-10 <sup>[b]</sup>	0.459	22.8	2.97
	0.473	22.8	3.56
CK-11 <sup>[b]</sup>	0.473	21.2	6.64
	0.451	21.2	6.66
CK-12 <sup>[b]</sup>	0.451	21.2	6.45
CK-13 <sup>[b]</sup>	0.492	21.8	13.2
	0.498	21.8	13.2

<sup>[a]</sup> The ratio of air change rate to chamber loading factor ranged from 22 to 1350 m/h.

<sup>[b]</sup> This caulk sample was tested in duplicate.

**Table A.2. Test conditions for PCB emissions from caulk at different temperatures**

<b>Caulk ID</b>	<b>Air flow rate (L/min)</b>	<b>Temperature (°C)</b>	<b>Source area (cm<sup>2</sup>)</b>
CK-11	0.470	21.9	3.12
	0.457	30.0	
	0.411	35.0	
	0.417	40.0	
CK-13	0.453	21.9	7.89
	0.445	30.0	
	0.436	35.0	
	0.434	40.0	

**Table A.3. Test conditions for comparing the PCB emissions from different surfaces <sup>[a]</sup>**

<b>Caulk ID</b>	<b>Surface type</b>	<b>Air flow rate (L/min)</b>	<b>Source area (cm<sup>2</sup>)</b>
CK-01	Previously exposed	456	7.76
	Newly cut surface	455	7.78
CK-02	Previously exposed	484	7.36
	Newly cut surface	448	6.15
CK-12	Previously exposed	447	6.95
	Newly cut surface	451	6.45

<sup>[a]</sup> The temperature was 22.6 °C for all six chambers.

**Table A.4. Average congener concentrations in chamber air, relative standard deviations, and number of valid data points <sup>[a][b]</sup>**

Caulk ID		#17	#52	#66	#101	#105	#110	#118	#154	#187
CK-01a	Mean ( $\mu\text{g}/\text{m}^3$ )	--	10.1	0.791	--	5.01	0.34	2.73	1.37	0.457
	RSD	--	12.0%	21.9%	--	13.0%	3.6%	16.1%	4.9%	0.0623
	n	--	5	5	--	5	4	5	5	4
CK-01b	Mean ( $\mu\text{g}/\text{m}^3$ )	0.062	10.9	0.724	--	5.25	0.34	2.78	1.38	0.505
	RSD	16.4%	12.4%	4.6%	--	9.9%	6.6%	10.5%	3.8%	0.159
	n	4	5	4	--	5	4	5	4	5
CK-02a	Mean ( $\mu\text{g}/\text{m}^3$ )	0.141	7.86	0.651	3.42	0.238	1.80	0.83	0.329	--
	RSD	3.4%	24.3%	19.1%	20.7%	26.2%	20.8%	2.5%	20.2%	--
	n	4	4	4	4	4	4	3	4	--
CK-02b	Mean ( $\mu\text{g}/\text{m}^3$ )	0.146	8.63	0.669	4.07	0.284	2.15	1.09	0.346	--
	RSD	12.9%	14.5%	2.0%	20.8%	19.2%	21.9%	18.6%	3.1%	--
	n	4	4	3	4	4	4	4	3	--
CK-03	Mean ( $\mu\text{g}/\text{m}^3$ )	--	0.145	0.0719	0.950	0.176	0.910	0.589	0.101	--
	RSD	--	18.1%	14.4%	12.6%	25.4%	18.6%	21.2%	12.0%	--
	n	--	4	4	4	4	4	4	4	--
CK-04	Mean ( $\mu\text{g}/\text{m}^3$ )	--	1.11	0.214	1.67	0.166	1.19	0.599	0.148	--
	RSD	--	28.5%	24.6%	21.8%	32.7%	26.4%	31.6%	25.3%	--
	n	--	5	5	5	5	5	5	5	--
CK-08	Mean ( $\mu\text{g}/\text{m}^3$ )	--	<del>0.0230</del>	--	0.500	--	0.148	<del>0.044</del>	0.267	0.212
	RSD	--	22.9%	--	16.9%	--	20.3%	20.2%	19.0%	24.2%
	n	--	5	--	5	--	5	5	5	5

<sup>[a]</sup> Values in strikethrough font are below the PQL; caulk CK-01, CK-02, C-10, CK-11 and CK-13 were tested in duplicate; results for CK-05, CK-06 and CK-07 were not reported because all the congener concentrations were below the PQL.

<sup>[b]</sup> Outliers in air concentration measurements were discarded according to Dean and Dixon (1951) and Rorabacher (1991).

**Table A.4. Average congener concentrations in chamber air, relative standard deviations, and number of valid data points (continued)**

Caulk ID		#17	#52	#66	#101	#105	#110	#118	#154	#187
CK-09	Mean ( $\mu\text{g}/\text{m}^3$ )	--	<del>1.09</del>	0.631	5.03	0.630	3.95	<del>2.20</del>	0.498	<del>0.035</del>
	RSD	--	25.2%	21.9%	21.2%	18.3%	20.7%	14.3%	17.2%	22.5%
	n	--	5	5	5	5	5	5	5	5
CK-10a	Mean ( $\mu\text{g}/\text{m}^3$ )	0.279	12.0	0.909	4.75214	0.440	2.56	1.303	0.454	--
	RSD	8.1%	5.8%	14.5%	10.4%	20.3%	13.4%	18.5%	12.2%	--
	N	3	5	5	5	3	5	5	5	--
CK-10b	Mean ( $\mu\text{g}/\text{m}^3$ )	0.346	16.5	1.12	6.05	0.445	3.13	1.47	0.534	--
	RSD	11.9%	9.4%	12.6%	8.7%	32.9%	9.8%	17.1%	5.7%	--
	N	2	4	4	4	2	4	4	4	--
CK-11a	Mean ( $\mu\text{g}/\text{m}^3$ )	--	0.902	0.084	0.463	--	0.222	0.124	--	--
	RSD	--	3.0%	11.6%	8.7%	--	10.8%	13.8%	--	--
	N	--	5	5	5	--	5	5	--	--
CK-11b	Mean ( $\mu\text{g}/\text{m}^3$ )	--	0.818	0.077	0.459	--	0.224	0.125	--	--
	RSD	--	3.9%	5.0%	6.5%	--	10.5%	13.0%	--	--
	N	--	5	5	5	--	5	5	--	--
CK-12	Mean ( $\mu\text{g}/\text{m}^3$ )	0.692	21.8	1.8	8.79	0.622	4.37	2.06	0.865	0.030
	RSD	4.2%	3.9%	9.8%	4.6%	17.6%	8.4%	6.0%	8.1%	20.2%
	n	5	5	5	5	5	5	5	5	5
CK-13a	Mean ( $\mu\text{g}/\text{m}^3$ )	0.055	0.983	0.091	0.325	--	0.188	0.087	--	--
	RSD	0.253	24.6%	28.4%	27.6%	--	28.8%	32.4%	--	--
	n	4	6	6	6	--	6	5	--	--
CK-13b	Mean ( $\mu\text{g}/\text{m}^3$ )	0.0613	1.120	0.112	0.373	--	0.214	0.101	--	--
	RSD	13.7%	14.3%	12.2%	18.5%	--	19.0%	19.1%	--	--
	n	4	5	5	5	--	5	4	--	--

**Table A.5. Air concentrations at different temperatures for field caulk CK-11<sup>[a]</sup>**

Temperature (°C)	Congener ID								
	#17	#52	#101	#154	#110	#66	#118	#105	#187
21.9	<del>9.60</del> ×10 <sup>-3</sup>	6.20×10 <sup>-1</sup>	2.48×10 <sup>-1</sup>	1.61×10 <sup>-2</sup>	1.32×10 <sup>-1</sup>	5.39×10 <sup>-2</sup>	7.27×10 <sup>-2</sup>	<del>2.02</del> ×10 <sup>-2</sup>	0.00×10 <sup>0</sup>
30.0	<del>2.72</del> ×10 <sup>-2</sup>	1.95×10 <sup>0</sup>	8.46×10 <sup>-1</sup>	<del>4.97</del> ×10 <sup>-2</sup>	4.44×10 <sup>-1</sup>	1.92×10 <sup>-1</sup>	2.55×10 <sup>-1</sup>	<del>7.13</del> ×10 <sup>-2</sup>	<del>3.02</del> ×10 <sup>-3</sup>
35.0	<del>1.13</del> ×10 <sup>-1</sup>	7.73×10 <sup>0</sup>	3.39×10 <sup>0</sup>	<del>2.06</del> ×10 <sup>-1</sup>	1.88×10 <sup>0</sup>	<del>7.43</del> ×10 <sup>-1</sup>	1.09×10 <sup>0</sup>	<del>3.07</del> ×10 <sup>-1</sup>	<del>1.02</del> ×10 <sup>-2</sup>

<sup>[a]</sup> Values in strikethrough font are below the PQL.

**Table A.6. Air concentrations at different temperatures for laboratory-mix caulk CK-13<sup>[a]</sup>**

Temperature (°C)	Congener ID								
	#17	#52	#101	#154	#110	#66	#118	#105	#187
21.9	<del>3.10</del> ×10 <sup>-2</sup>	8.49×10 <sup>-1</sup>	2.54×10 <sup>-1</sup>	2.42×10 <sup>-2</sup>	1.35×10 <sup>-1</sup>	3.81×10 <sup>-2</sup>	6.11×10 <sup>-2</sup>	<del>1.61</del> ×10 <sup>-2</sup>	—
30.0	<del>8.41</del> ×10 <sup>-2</sup>	2.64×10 <sup>0</sup>	8.98×10 <sup>-1</sup>	<del>7.80</del> ×10 <sup>-2</sup>	4.81×10 <sup>-1</sup>	1.44×10 <sup>-1</sup>	2.33×10 <sup>-1</sup>	<del>7.26</del> ×10 <sup>-2</sup>	<del>3.27</del> ×10 <sup>-3</sup>
35.0	<del>1.16</del> ×10 <sup>-1</sup>	3.87×10 <sup>0</sup>	1.45×10 <sup>0</sup>	<del>1.23</del> ×10 <sup>-1</sup>	7.84×10 <sup>-1</sup>	2.20×10 <sup>-1</sup>	3.99×10 <sup>-1</sup>	<del>1.16</del> ×10 <sup>-1</sup>	<del>5.25</del> ×10 <sup>-3</sup>
40.0	<del>1.75</del> ×10 <sup>-1</sup>	6.22×10 <sup>0</sup>	2.45×10 <sup>0</sup>	<del>2.03</del> ×10 <sup>-1</sup>	1.30×10 <sup>0</sup>	<del>3.54</del> ×10 <sup>-1</sup>	6.55×10 <sup>-1</sup>	<del>1.95</del> ×10 <sup>-1</sup>	<del>1.70</del> ×10 <sup>-2</sup>

<sup>[a]</sup> Values in strikethrough font are below the PQL.

## Appendix B

### Test Conditions for Light Ballasts

**Table B.1. Summary of conditions for the screening tests**

<b>Ballast ID</b>	<b>Duration (hrs)</b>	<b>Avg. air flow rate (L/min)</b>	<b>Avg. chamber Temp. (°C)</b>	<b>Avg. chamber RH (%)</b>
BL-01	21.5	0.916	23.3	44.6
BL-02	10.7	0.909	23.3	41.3
BL-03	95.8	0.908	23.8	47.8
BL-04	27.0	0.909	23.7	53.1
BL-06	68.2	0.910	23.6	52.9
BL-07	26.9	0.918	23.9	46.5
BL-08	18.1	0.906	23.3	41.9
BL-09a	68.6	0.921	23.8	43.1
BL-09b	19.0	0.908	23.5	41.6
BL-09d	331	0.920	23.8	33.7
BL-09e	23.2	0.913	23.3	44.1
BL-09f	26.8	0.919	23.4	43.9
BL-10	22.0	0.912	23.8	45.0
BL-11b	19.7	0.914	23.3	41.0
BL-12	22.3	0.905	23.8	47.6
BL-13	21.8	0.908	23.6	52.0

**Table B.2. Summary of conditions for the live tests**

<b>Ballast ID</b>	<b>Duration (hrs)</b>	<b>Avg. air flow rate (L/min)</b>	<b>Avg. chamber Temp. (°C)</b>	<b>Avg. chamber RH (%)</b>
BL-08 <sup>a</sup>	19.0	0.903	45.7	40.6
BL-09a	25.2	0.895	28.2	52.1
BL-09c	24.5	0.917	28.1	50.5
BL-09d	26.2	0.901	28.6	49.9
BL-10	24.6	0.905	27.1	52.0
BL-11a	25.6	0.910	27.9	49.5

<sup>a</sup> Ballast BL-08 failed during the test. See section 4.3.6 for details.

**Table B.3. Summary of test conditions for the effect of ambient temperature <sup>[a]</sup>**

<b>Ballast ID</b>	<b>Test Duration (hrs)</b>	<b>Avg. air flow rate (L/min)</b>	<b>Avg. chamber Temp. (°C)</b>	<b>Avg. chamber RH (%)</b>
BL-02	18.5	0.904	23.1	48.6
	17.5		29.9	48.7
	17.1		34.8	41.4
	19.6		39.7	35.2
	17.0		44.6	30.2
BL-05	16.7	0.893	23.0	50.4
	18.0		29.4	49.8
	65.8		34.8	45.3
	17.4		39.8	38.2
	17.4		44.8	32.1
BL-09c	16.7	0.909	23.2	49.4
	18.0		29.6	49.0
	65.6		34.6	41.5
	17.4		39.5	16.6
	17.3		44.5	12.4
BL-12	17.7	0.910	22.9	44.2
	17.6		29.7	43.0
	17.1		34.6	32.9
	19.6		39.5	20.6
	16.9		44.4	10.4

<sup>[a]</sup> Environmental data were recorded every 15 minutes.



**Table B.4. Congener emission rates for four light ballasts at different temperatures (units: µg/g) <sup>[a]</sup>**

Ballast ID	Temperature °C	Congener ID								
		#13	#18	#17	#15	#22	#52	#49	#44	#64
BL-02	23.1	<del>2.17</del> ×10 <sup>-4</sup>	9.43×10 <sup>-3</sup>	2.44×10 <sup>-3</sup>	<del>5.51</del> ×10 <sup>-4</sup>	<del>3.12</del> ×10 <sup>-4</sup>	<del>5.11</del> ×10 <sup>-4</sup>	<del>1.09</del> ×10 <sup>-4</sup>	6.67×10 <sup>-5</sup>	—
	29.9	<del>6.59</del> ×10 <sup>-4</sup>	2.67×10 <sup>-2</sup>	8.53×10 <sup>-3</sup>	<del>2.22</del> ×10 <sup>-3</sup>	<del>1.21</del> ×10 <sup>-3</sup>	<del>1.26</del> ×10 <sup>-3</sup>	5.08×10 <sup>-4</sup>	6.56×10 <sup>-4</sup>	2.22×10 <sup>-4</sup>
	34.8	<del>7.57</del> ×10 <sup>-4</sup>	2.88×10 <sup>-2</sup>	8.97×10 <sup>-3</sup>	<del>2.26</del> ×10 <sup>-3</sup>	<del>1.57</del> ×10 <sup>-3</sup>	<del>1.69</del> ×10 <sup>-3</sup>	7.44×10 <sup>-4</sup>	8.58×10 <sup>-4</sup>	2.17×10 <sup>-4</sup>
	39.7	<del>2.72</del> ×10 <sup>-3</sup>	9.10×10 <sup>-2</sup>	3.00×10 <sup>-2</sup>	7.88×10 <sup>-3</sup>	5.17×10 <sup>-3</sup>	5.53×10 <sup>-3</sup>	<del>2.66</del> ×10 <sup>-3</sup>	<del>3.20</del> ×10 <sup>-3</sup>	8.27×10 <sup>-4</sup>
	44.6	<del>2.69</del> ×10 <sup>-3</sup>	8.32×10 <sup>-2</sup>	2.56×10 <sup>-2</sup>	7.25×10 <sup>-3</sup>	4.97×10 <sup>-3</sup>	5.47×10 <sup>-3</sup>	<del>2.50</del> ×10 <sup>-3</sup>	<del>3.31</del> ×10 <sup>-3</sup>	8.96×10 <sup>-4</sup>
BL-05	23.0	—	4.25×10 <sup>-3</sup>	<del>1.12</del> ×10 <sup>-3</sup>	<del>2.01</del> ×10 <sup>-4</sup>	<del>1.50</del> ×10 <sup>-4</sup>	<del>3.88</del> ×10 <sup>-4</sup>	7.74×10 <sup>-5</sup>	1.75×10 <sup>-4</sup>	—
	29.4	<del>7.01</del> ×10 <sup>-4</sup>	3.03×10 <sup>-2</sup>	1.01×10 <sup>-2</sup>	<del>1.83</del> ×10 <sup>-3</sup>	2.15×10 <sup>-3</sup>	2.75×10 <sup>-3</sup>	<del>1.19</del> ×10 <sup>-3</sup>	<del>1.62</del> ×10 <sup>-3</sup>	3.86×10 <sup>-4</sup>
	34.8	<del>1.51</del> ×10 <sup>-3</sup>	6.37×10 <sup>-2</sup>	1.93×10 <sup>-2</sup>	4.62×10 <sup>-3</sup>	5.11×10 <sup>-3</sup>	5.15×10 <sup>-3</sup>	2.28×10 <sup>-3</sup>	3.03×10 <sup>-3</sup>	8.95×10 <sup>-4</sup>
	39.8	<del>2.12</del> ×10 <sup>-3</sup>	8.63×10 <sup>-2</sup>	2.55×10 <sup>-2</sup>	6.89×10 <sup>-3</sup>	7.17×10 <sup>-3</sup>	6.68×10 <sup>-3</sup>	3.40×10 <sup>-3</sup>	3.98×10 <sup>-3</sup>	<del>1.22</del> ×10 <sup>-3</sup>
	44.8	2.86×10 <sup>-3</sup>	1.14×10 <sup>-1</sup>	3.80×10 <sup>-2</sup>	1.20×10 <sup>-2</sup>	1.13×10 <sup>-2</sup>	9.11×10 <sup>-3</sup>	4.49×10 <sup>-3</sup>	5.91×10 <sup>-3</sup>	<del>1.79</del> ×10 <sup>-3</sup>
BL-09c	23.2	<del>2.04</del> ×10 <sup>-4</sup>	5.53×10 <sup>-3</sup>	<del>1.77</del> ×10 <sup>-3</sup>	<del>7.33</del> ×10 <sup>-4</sup>	<del>2.48</del> ×10 <sup>-4</sup>	<del>1.68</del> ×10 <sup>-4</sup>	—	—	—
	29.6	<del>4.67</del> ×10 <sup>-4</sup>	1.17×10 <sup>-2</sup>	3.43×10 <sup>-3</sup>	<del>1.51</del> ×10 <sup>-3</sup>	<del>4.84</del> ×10 <sup>-4</sup>	<del>5.54</del> ×10 <sup>-4</sup>	9.50×10 <sup>-5</sup>	2.33×10 <sup>-4</sup>	1.67×10 <sup>-3</sup>
	34.5	<del>1.21</del> ×10 <sup>-3</sup>	2.70×10 <sup>-2</sup>	8.47×10 <sup>-3</sup>	4.33×10 <sup>-3</sup>	<del>1.78</del> ×10 <sup>-3</sup>	<del>1.08</del> ×10 <sup>-3</sup>	6.76×10 <sup>-4</sup>	7.29×10 <sup>-4</sup>	2.04×10 <sup>-4</sup>
	34.6	<del>1.67</del> ×10 <sup>-3</sup>	3.98×10 <sup>-2</sup>	1.22×10 <sup>-2</sup>	6.92×10 <sup>-3</sup>	2.65×10 <sup>-3</sup>	<del>1.42</del> ×10 <sup>-3</sup>	9.10×10 <sup>-4</sup>	8.93×10 <sup>-4</sup>	3.45×10 <sup>-4</sup>
	39.5	2.25×10 <sup>-3</sup>	5.71×10 <sup>-2</sup>	1.66×10 <sup>-2</sup>	1.06×10 <sup>-2</sup>	3.03×10 <sup>-3</sup>	<del>1.98</del> ×10 <sup>-3</sup>	<del>1.40</del> ×10 <sup>-3</sup>	<del>1.24</del> ×10 <sup>-3</sup>	3.82×10 <sup>-4</sup>
	44.5	4.93×10 <sup>-3</sup>	8.56×10 <sup>-2</sup>	3.13×10 <sup>-2</sup>	2.10×10 <sup>-2</sup>	5.79×10 <sup>-3</sup>	3.62×10 <sup>-3</sup>	<del>2.14</del> ×10 <sup>-3</sup>	2.40×10 <sup>-3</sup>	7.79×10 <sup>-4</sup>
BL-12	22.9	<del>6.37</del> ×10 <sup>-3</sup>	1.52×10 <sup>-1</sup>	5.19×10 <sup>-2</sup>	<del>1.48</del> ×10 <sup>-2</sup>	<del>6.14</del> ×10 <sup>-3</sup>	<del>4.99</del> ×10 <sup>-3</sup>	<del>1.29</del> ×10 <sup>-3</sup>	2.04×10 <sup>-3</sup>	—
	29.7	<del>1.66</del> ×10 <sup>-2</sup>	4.64×10 <sup>-1</sup>	1.35×10 <sup>-1</sup>	5.06×10 <sup>-2</sup>	<del>1.95</del> ×10 <sup>-2</sup>	<del>1.72</del> ×10 <sup>-2</sup>	8.73×10 <sup>-3</sup>	7.70×10 <sup>-3</sup>	3.01×10 <sup>-3</sup>
	34.6	<del>2.71</del> ×10 <sup>-2</sup>	7.48×10 <sup>-1</sup>	2.30×10 <sup>-1</sup>	8.45×10 <sup>-2</sup>	<del>3.57</del> ×10 <sup>-2</sup>	<del>2.99</del> ×10 <sup>-2</sup>	<del>1.98</del> ×10 <sup>-2</sup>	<del>1.59</del> ×10 <sup>-2</sup>	3.65×10 <sup>-3</sup>
	39.5	1.46×10 <sup>-1</sup>	3.83×10 <sup>0</sup>	1.14×10 <sup>0</sup>	5.60×10 <sup>-1</sup>	2.08×10 <sup>-1</sup>	1.57×10 <sup>-1</sup>	8.98×10 <sup>-2</sup>	9.47×10 <sup>-2</sup>	3.00×10 <sup>-2</sup>
	44.4	2.24×10 <sup>-1</sup>	5.43×10 <sup>0</sup>	1.72×10 <sup>0</sup>	9.53×10 <sup>-1</sup>	3.64×10 <sup>-1</sup>	2.54×10 <sup>-1</sup>	1.54×10 <sup>-1</sup>	1.61×10 <sup>-1</sup>	4.89×10 <sup>-2</sup>

<sup>[a]</sup> Values in strikethrough font are below the practical quantification limit.

## Appendix C

### Simulating the Long-term PCB Emissions from Caulk

#### C.1 Model description

The emissions data presented in this report represent the emission status of the caulk samples as they were tested. To estimate their emissions in the past or future, one must rely on mathematical models. Emissions of volatile and semivolatile chemicals from solid building materials have been extensively studied in the past two decades and, consequently, a series of mass transfer models have been developed (Little et al., 1994; Huang and Haghight 2002; Xu and Yang, 2003; Deng and Kim, 2004; Qian et al., 2007). While differing in complexity and applicability, they have several features in common:

- They are all derived from Fick's second law;
- They use the same set of parameters to describe the source: the content of the chemical in the source, the solid/air partition coefficient, the diffusivity (i.e., diffusion coefficient) of the chemical in the source, and the area and thickness of the source; and
- They, with one exception, all require solving a non-linear equation.

The model used here was developed by Little and his co-workers in 1994. The computer program that implements this model was developed by Guo (2000).

#### C.2 Parameter Estimation

##### *C.2.1 Estimation of the solid/air partition coefficient*

The solid/air partition coefficient (K) is defined by Equation C.1:

$$K = \frac{C_s}{C_a} \tag{C.1}$$

where      K = solid/air partition coefficient (dimensionless)  
               $C_s$  = concentration of a congener in the solid phase ( $\mu\text{g}/\text{cm}^3$ )  
               $C_a$  = concentration of the congener in the air in equilibrium with  $C_s$  ( $\mu\text{g}/\text{cm}^3$ )

Several empirical models are available for estimating K from the vapor pressure of the chemical. Equation C.2 (Guo, 2002) is one of them:



**Table C.1. Content in caulk, partition and diffusivity coefficients for four congeners in Aroclor 1254**

Parameter	Units	Congener ID			
		#52	#77	#154	#187
Congener content in Aroclor 1254 <sup>[a]</sup>	%	5.38	0.03	0.04	0.25
Congener content in caulk	$\mu\text{g}/\text{m}^3$	$8.07 \times 10^9$	$4.50 \times 10^7$	$6.00 \times 10^7$	$3.75 \times 10^8$
Partition coefficient (K)	—	$6.54 \times 10^7$	$4.13 \times 10^7$	$4.29 \times 10^7$	$1.49 \times 10^8$
Diffusion coefficient (D)	$\text{m}^2/\text{h}$	$2.25 \times 10^{-11}$	$2.25 \times 10^{-11}$	$5.52 \times 10^{-12}$	$3.02 \times 10^{-12}$

<sup>[a]</sup> The percent weight data was from Frame et al. (1996).

#### C.4 Simulation results

Simulations were made for air concentrations and percent of congener mass emitted over a 50-year period. The results are presented in Figures 5.1 and 5.2 in the main body of this report.

#### C5. Limitations

The partition and diffusion coefficients are two key parameters in this model. The values of these parameters are rough estimates based on best available knowledge. Developing methods for accurately determine these parameters is a key to improving the uncertainty in the model.

## **Appendix D**

### **Simulation of a Failed Light Ballast**

#### **D.1 Purpose**

This appendix describes how to use an existing spill model to roughly predict the concentrations of individual congeners or total PCB concentrations following the rupture of the capacitor in a light ballast unit.

#### **D.2 Model Description**

The spill model used for a PCB spill from a failed light ballast was originally developed for petroleum-based solvents, which contain hundreds of hydrocarbons. The model uses the most abundant hydrocarbons in the solvent to estimate the emissions of the total VOCs. The emissions from spilled PCB fluids are similar. A full description of the model can be found in Guo (2000). The simulation program can be downloaded from the EPA website <http://www.epd.gov/nrmrl/appcd/mmd/iaq.html>.

#### **D.3 Assumptions**

The simulation was based on the following assumptions:

- The PCB fluid in the light ballast is Aroclor 1242
- The volume of the fluid ejected during the failure is 20 mL
- After the burst, the fluid quickly either condenses or deposits on the nearby surfaces
- There is no human intervention after the failure
- The initial concentration surge due to high temperature is ignored

#### **D.4 Model Input**

The six most abundant congeners in Aroclor 1242 were used for the simulation. Their properties are summarized in Table D.1. Other environmental parameters are as follows:

- Room volume                      230 m<sup>3</sup>
- Ventilation rate                    0.5 air change per hour
- Density of Aroclor 1242        1.35 g/cm<sup>3</sup>
- Total spill area                    0.04 m<sup>2</sup>

**Table D.1. Physical properties of the congeners used in the simulation**

Congener ID	Chlorine #	MW	P <sup>[a]</sup> (torr)	D <sub>a</sub> <sup>[b]</sup> (m <sup>2</sup> /h)	Content <sup>[c]</sup> (mg/g)
#8	2	199.1	1.19×10 <sup>3</sup>	0.0199	64.8
#18	3	233.6	6.38×10 <sup>4</sup>	0.0191	91.4
#28	3	233.6	2.43×10 <sup>4</sup>	0.0191	73.1
#31	3	233.6	2.60×10 <sup>4</sup>	0.0191	78.2
#33	3	233.6	2.21×10 <sup>4</sup>	0.0191	53.5
#70	4	268.0	4.73×10 <sup>4</sup>	0.0183	37.0

<sup>[a]</sup> Method B in Fischer et al. (1992).

<sup>[b]</sup> FSG method; calculated using program PARAMS (Guo, 2005).

<sup>[c]</sup> Congener content in Aroclor 1242 (Frame et al., 1996, Table 4A, column 7).

### D.5 Simulation Results

The predicted time-concentration profile is shown in Figure D.1. The peak concentration for total PCBs is in agreement with the monitoring data reported by MacLeod (1981). The predicted concentrations remain high for the simulation period because it was assumed that there are not clean-up measures.

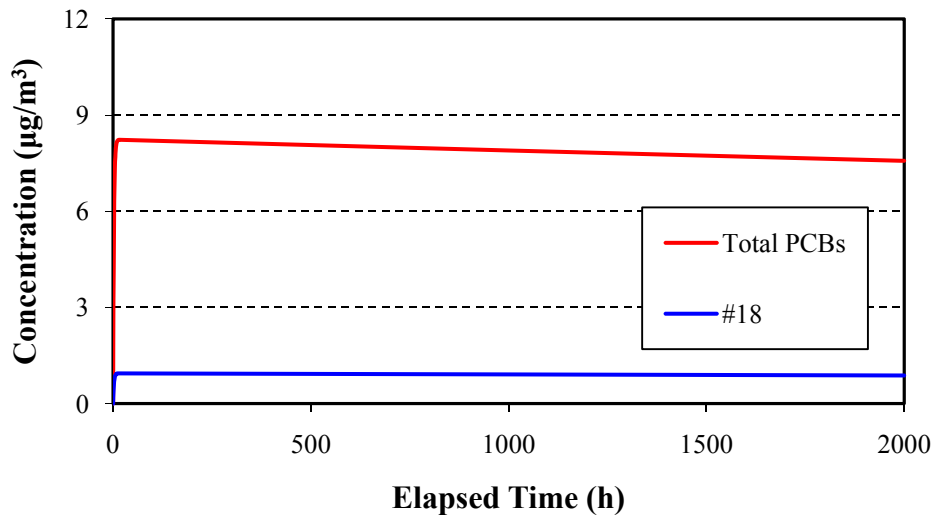

**Figure D.1. Predicted concentrations of “total PCBs” and congener #18 following light ballast failure**

## **D.6 Limitations**

This model was developed for evaporation of volatile organic compounds from a shallow pool of solvent mixture. It has not been tested for PCBs. The simulation described above does not take into account of any clean-up procedures.

To simulate the leakage of PCBs from a light ballast located inside of an enclosure, a two-compartment model is needed, where the enclosure is considered a compartment because the enclosure is not air tight and is designed to be convection cooled. The two-compartment spill model requires knowledge about the air change rate between the enclosure and the room air.