

Re-imagining aging coastal urban infrastructure systems for nutrient recovery and management that contribute to sustainable and healthy communities

James R. Mihelcic, Director
Sheila Olmstead, Deputy Director

**U.S. EPA National Center for Environmental Research
(NCER) National Nutrient Management Kickoff
Workshop
January 20-21, 2015**



Our Center consists of faculty,
research staff, and students from:

University of South Florida

University of Texas-Austin

Resources for the Future

Yale University

University of Florida

University of Maryland

Corporation to Develop Communities of Tampa

Hazen & Sawyer





James Mihelcic



Sheila Olmstead



Julie Zimmerman



Qiong Zhang



Jeff Cunningham



Daniel Yeh



Sarina Ergas



Maya Trotz



Trevor Boyer



Allen Davis



Nancy Diaz

Elsayed



Yusuke Kuwayama



Jhih-Shyang Shih



Nathan Richardson



Ernest Coney Jr.

Damann Anderson





Dr. Charles B. Bott, Chief of Research and Development, Hampton Roads Sanitation District



Dr. Sudhir Murthy, Innovations Chief, District of Columbia Water and Sewer Authority



Dr. Kenneth Williamson, Clean Water Services, Oregon



Jeanette Brown, Professor of Practice, at Manhattan College



Dr. Robert Rubin, Professor Emeritus, North Carolina State University



Ms. Lindsay Cross, Environmental Science and Policy Manager, Tampa Bay Estuary Program



Ms. Jennette Seachrist, Surface Water Improvement/Management Program, Southwest Florida Water Management District

Dr. Richard A. Smith, USGS



Mr. Lance Davis, sustainable design expert with focus on gaining knowledge and educating federal agencies



Dr. Richard Woodward, Professor of Agricultural Economics Texas A&M University

Our External Science Advisory Board



Our Research & Demonstrations

- a) address point and diffuse sources of nutrients,
- b) consider different scales (i.e., household, building, community, and city),
- c) develop and assess options with different implementation time frames, and
- d) prioritize source reduction and reuse/recycling.



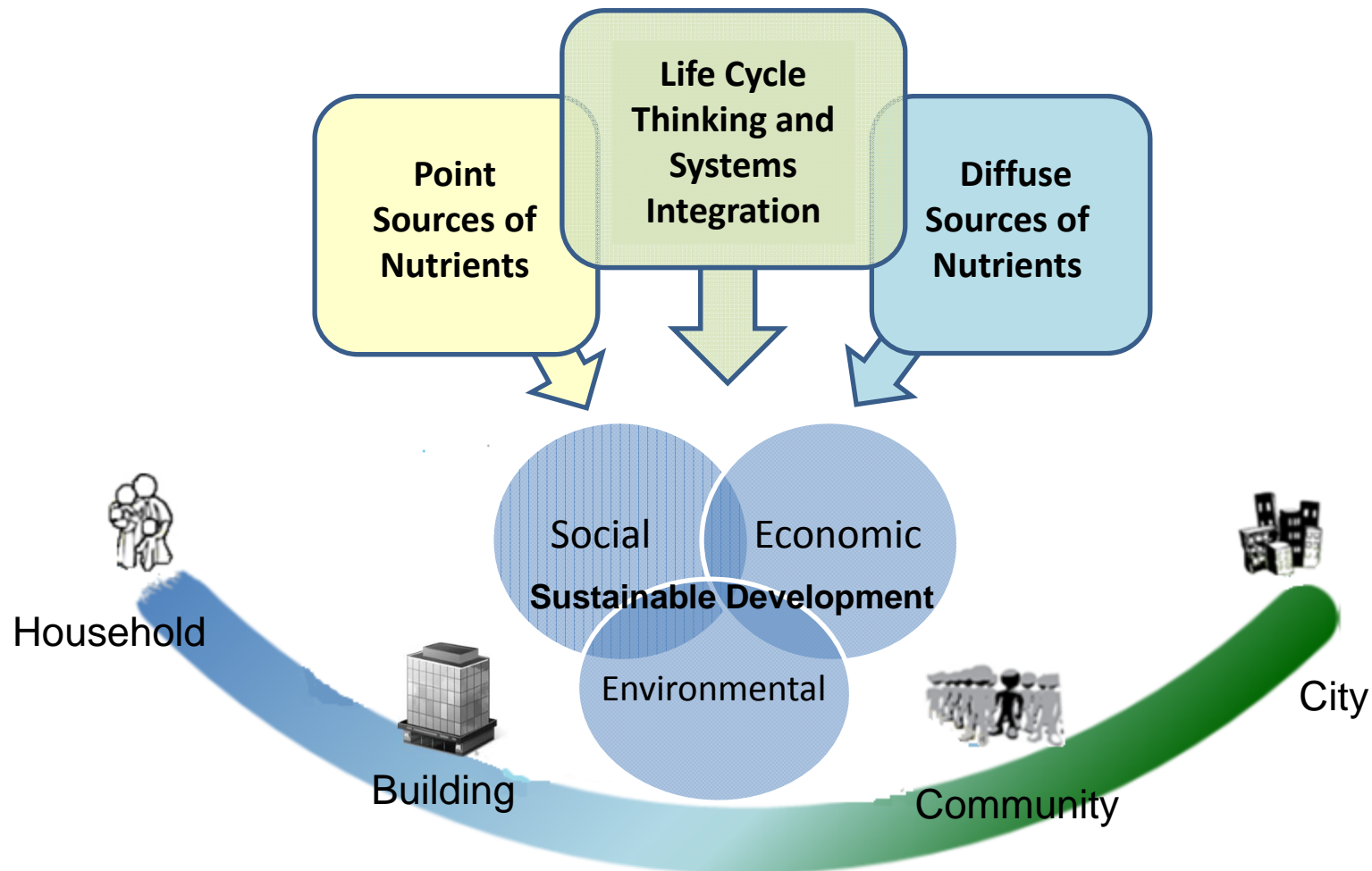

Our *mission* is to achieve sustainable and cost-effective health and environmental outcomes by re-imagining aging coastal urban infrastructure systems for nutrient recovery and management contributing to sustainable and healthy communities.

Another emphasis is that the Pollution Prevention hierarchy is also a key feature

- “Pollution Prevention is focused on increasing the efficiency of a process to reduce the amount of pollution generated”

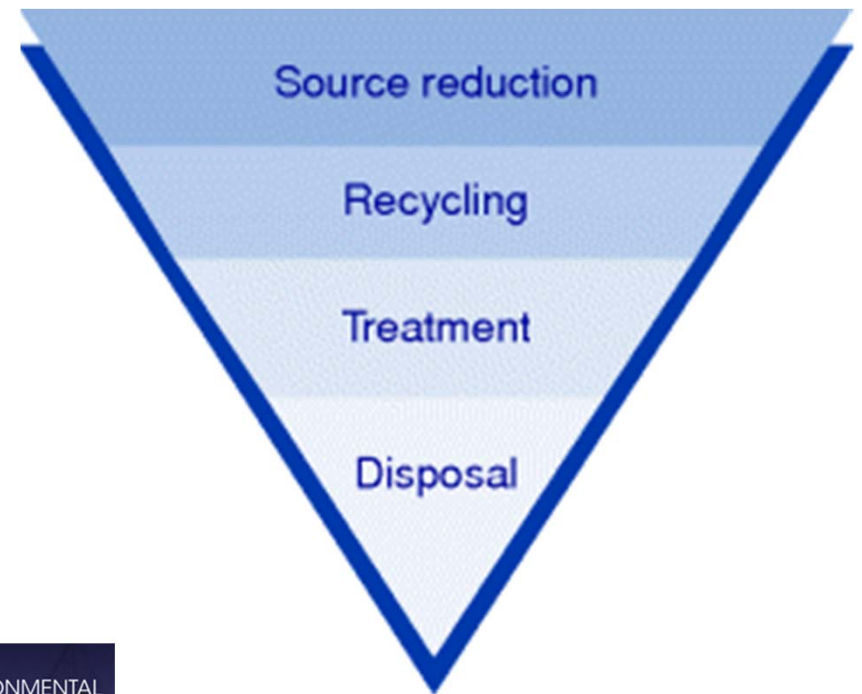

Mihelcic, J.R., J.B. Zimmerman, *Environmental Engineering: Fundamentals, Sustainability, Design*, John Wiley & Sons, 2nd Edition, 2014.



What Makes Our Research Innovative?

Information from EPA's Technology Roadmap (EPA-190-S-12-003, April 2012) as well as the Sustainability Analytics Report (<http://www.epa.gov/sustainability/analytics/>)

- Effective stakeholder engagement and collaboration that is initiated in the early stages of a project and maintained throughout the problem-solving process (problem scoping and formulation, goal-setting, indicator selection, alternative development, implementation, and evaluation).
- Novel solutions that replace (rather than incrementally improve) current approaches and strategies
- Utilize scenario planning to identify positive futures to work towards generating feasible solutions that reduce risks that can be difficult to quantify
- Seek tangible and outcome-oriented interventions with the greatest potential to achieve multiple environmental goals
- Target environmental problems with significant economic and social impacts
- Multidisciplinary solutions that deliver better results to solve a complex problem
- Requires the development new assessment tools and data sources

Three Research Thrusts & Demonstrations

- The overall research question for Research Thrusts 1 and 2 is: *What innovative and sustainable nutrient management technologies and strategies can be developed, demonstrated, and integrated for novel management of point and non-point sources of nutrients?*
- Research Thrust 3 will apply systems approaches and socioeconomic and environmental analyses to the science and demonstration projects of Research Thrusts 1 and 2.
- RAINmgt will quantify social, environmental and economic benefits and costs, defining barriers to implement new technological approaches (in terms of incentives for their adoption by private households and businesses, and regulated public entities such as municipal treatment plants).



Community Demonstration Projects

- the City of Tampa's Advanced Wastewater Treatment Plant
- a university building,
- residential homeowner,
- low income urban community of East Tampa, a 7.5 sq. mi. predominantly African American community and the largest residential community draining directly to McKay Bay (and subsequently Tampa Bay).



Research Thrust 1: Sustainable Management of Point Sources of Nutrients

SUSTAINABILITY ASSESSMENT of Environmental, Social and Economic COSTS and BENEFITS

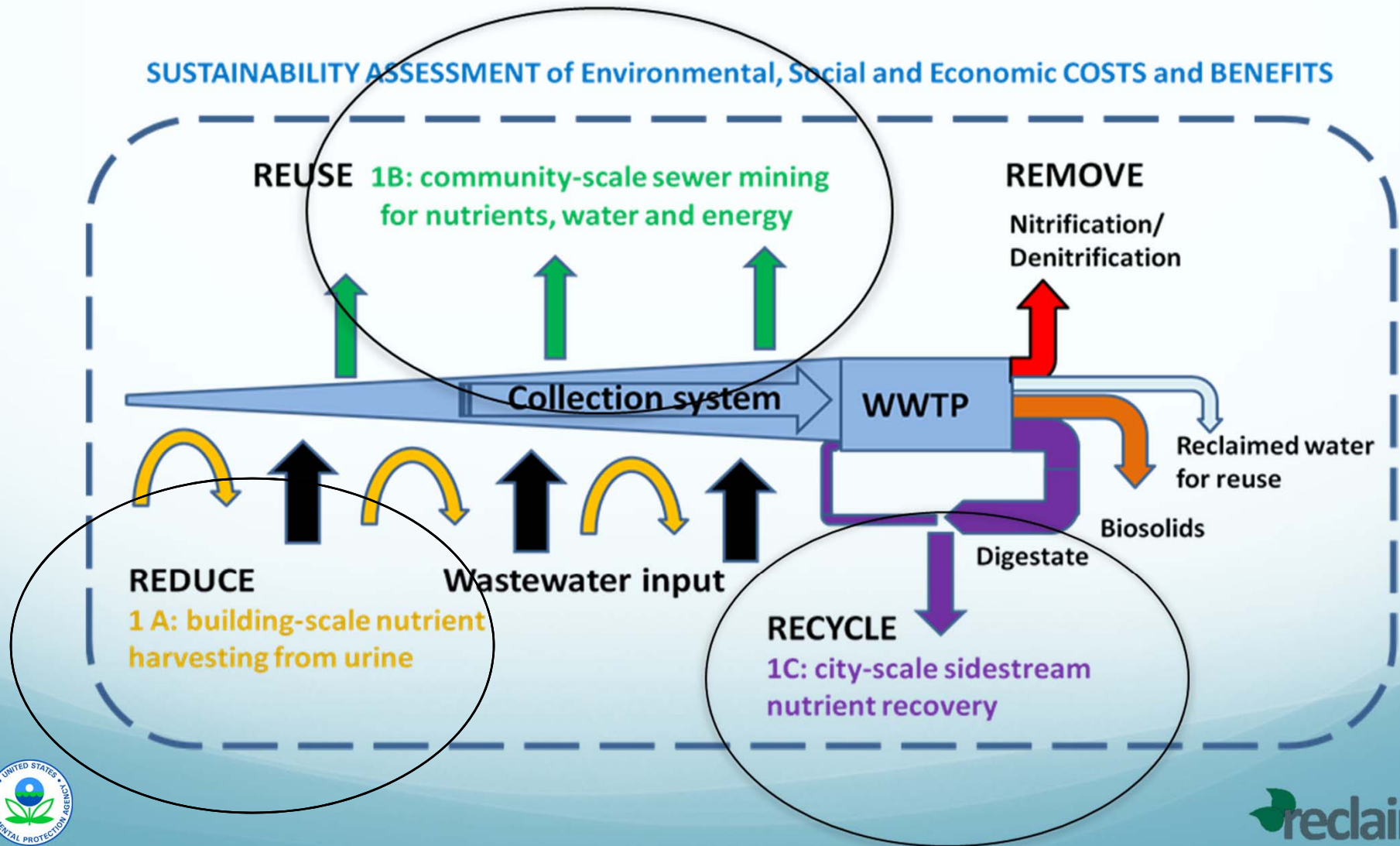

Research Thrust 1: Sustainable Management of Point Sources of Nutrients

SUSTAINABILITY ASSESSMENT of Environmental, Social and Economic COSTS and BENEFITS

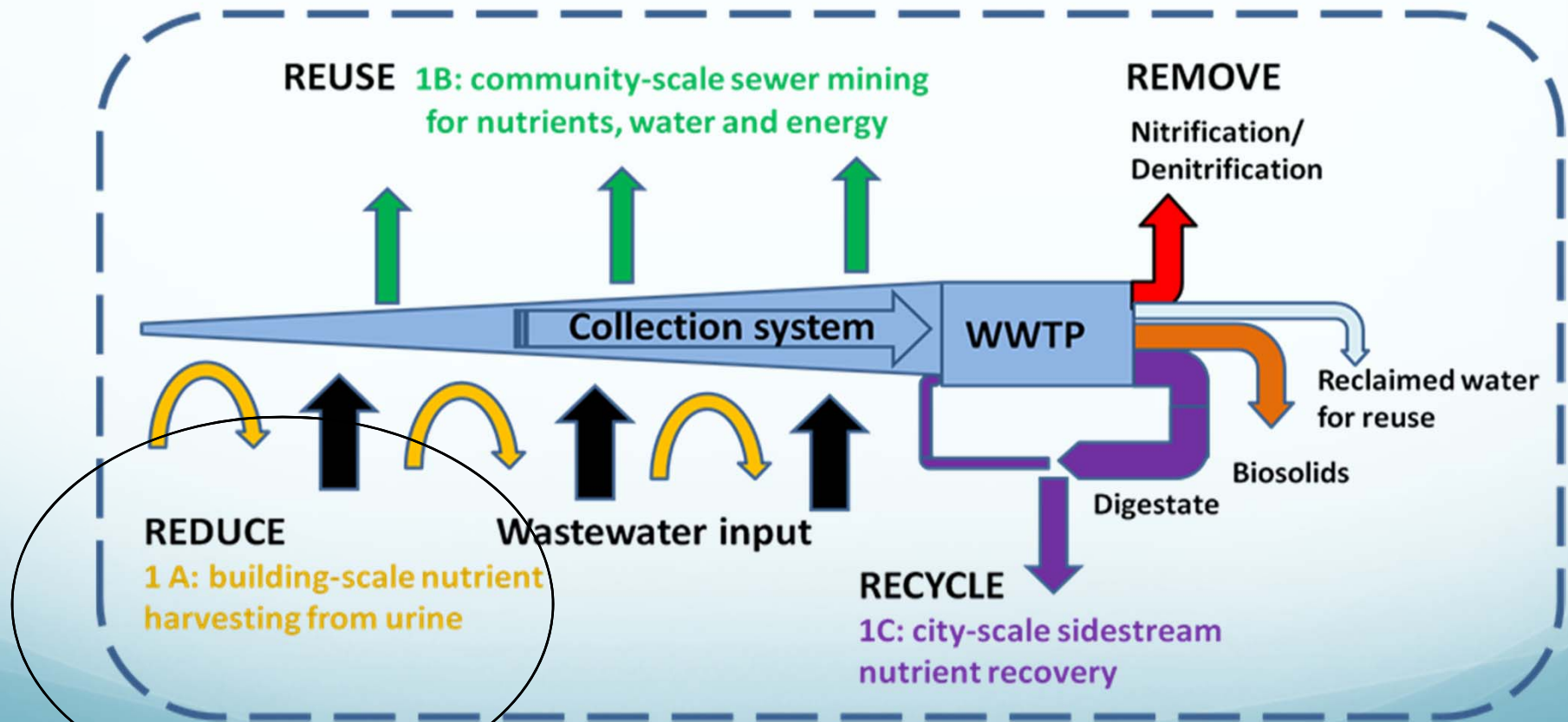

Phosphate removal and recovery from urine using an ion-exchange reactor in a waterless urinal

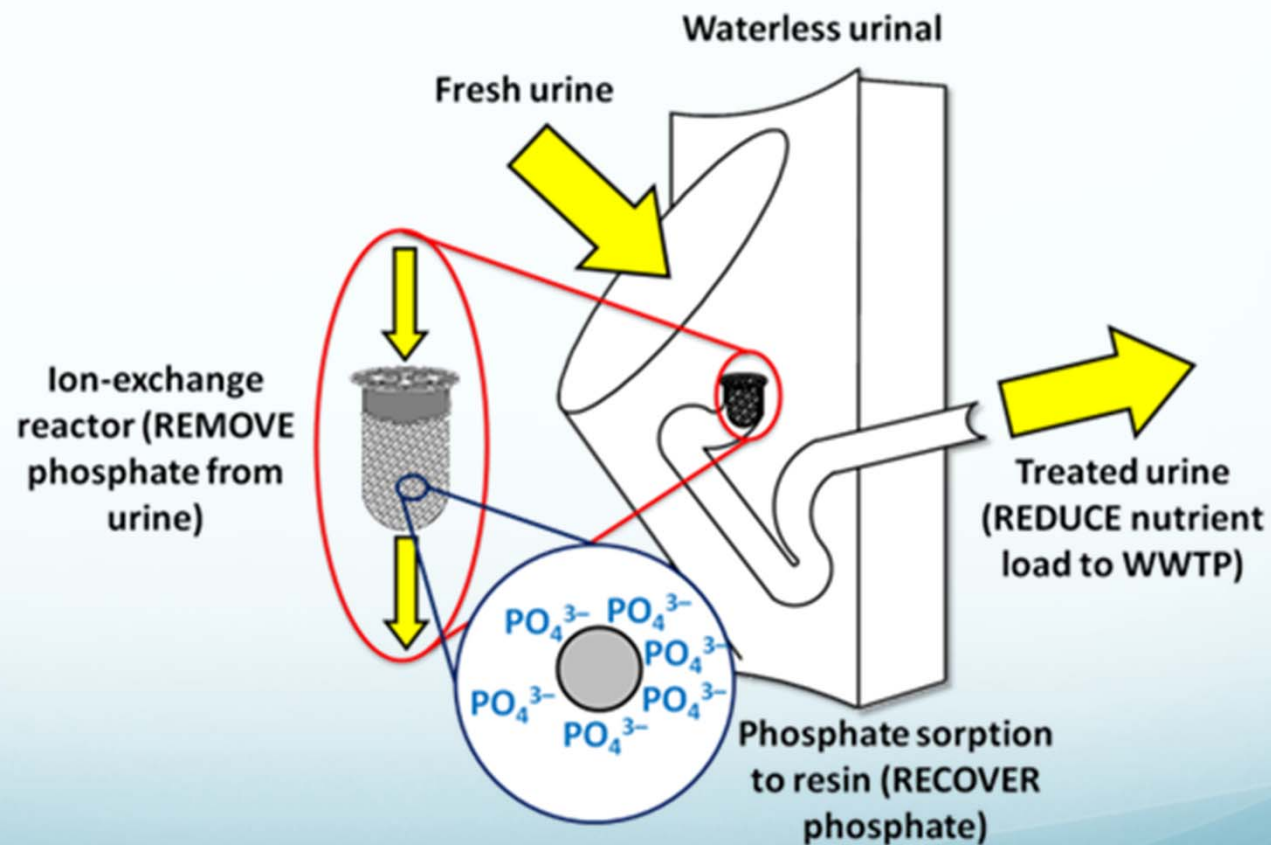

Research Thrust 1: Sustainable Management of Point Sources of Nutrients

SUSTAINABILITY ASSESSMENT of Environmental, Social and Economic COSTS and BENEFITS

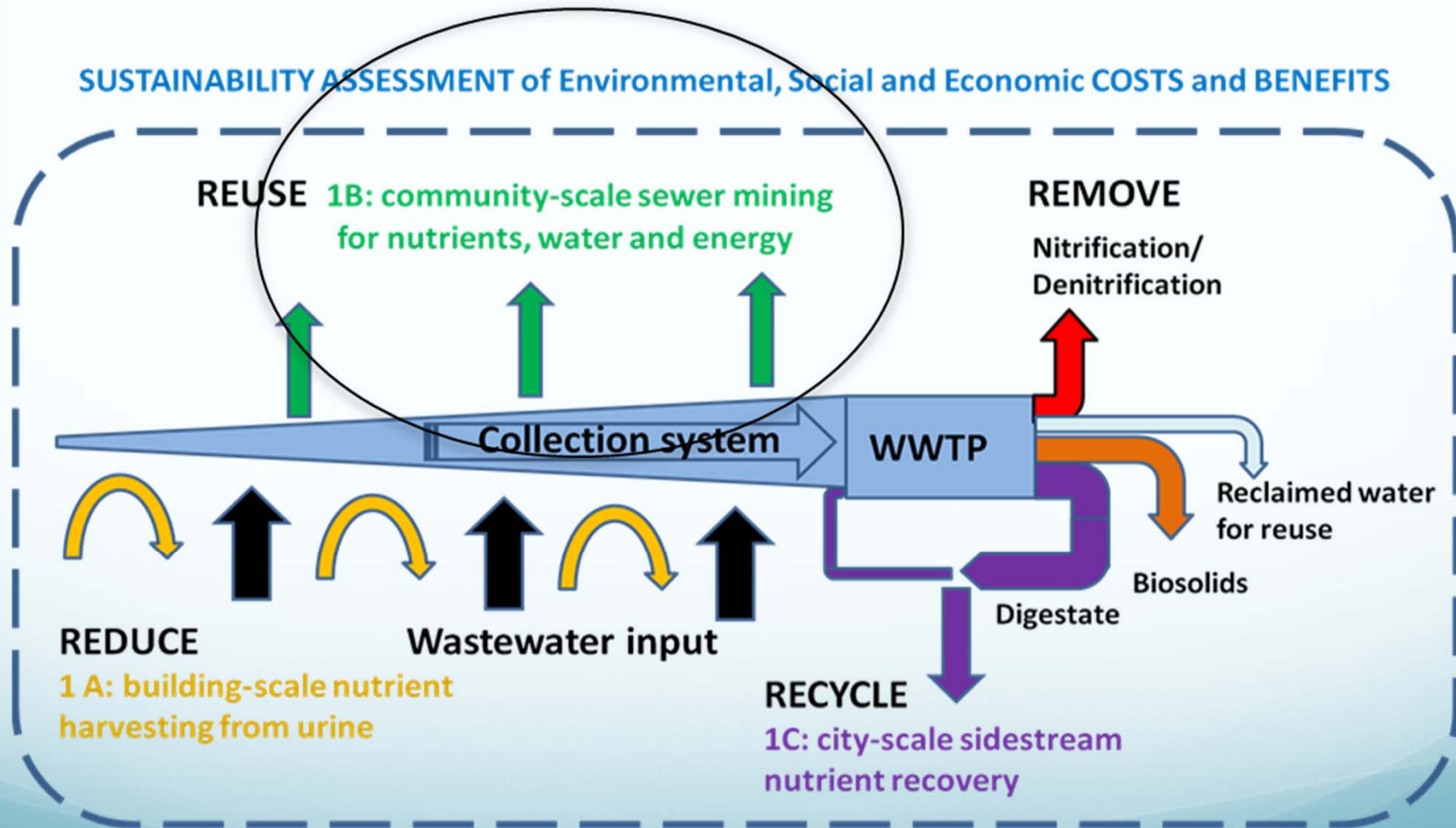

Sewer mining to recycle and reuse water and nutrients with an energy producing anaerobic membrane bioreactor

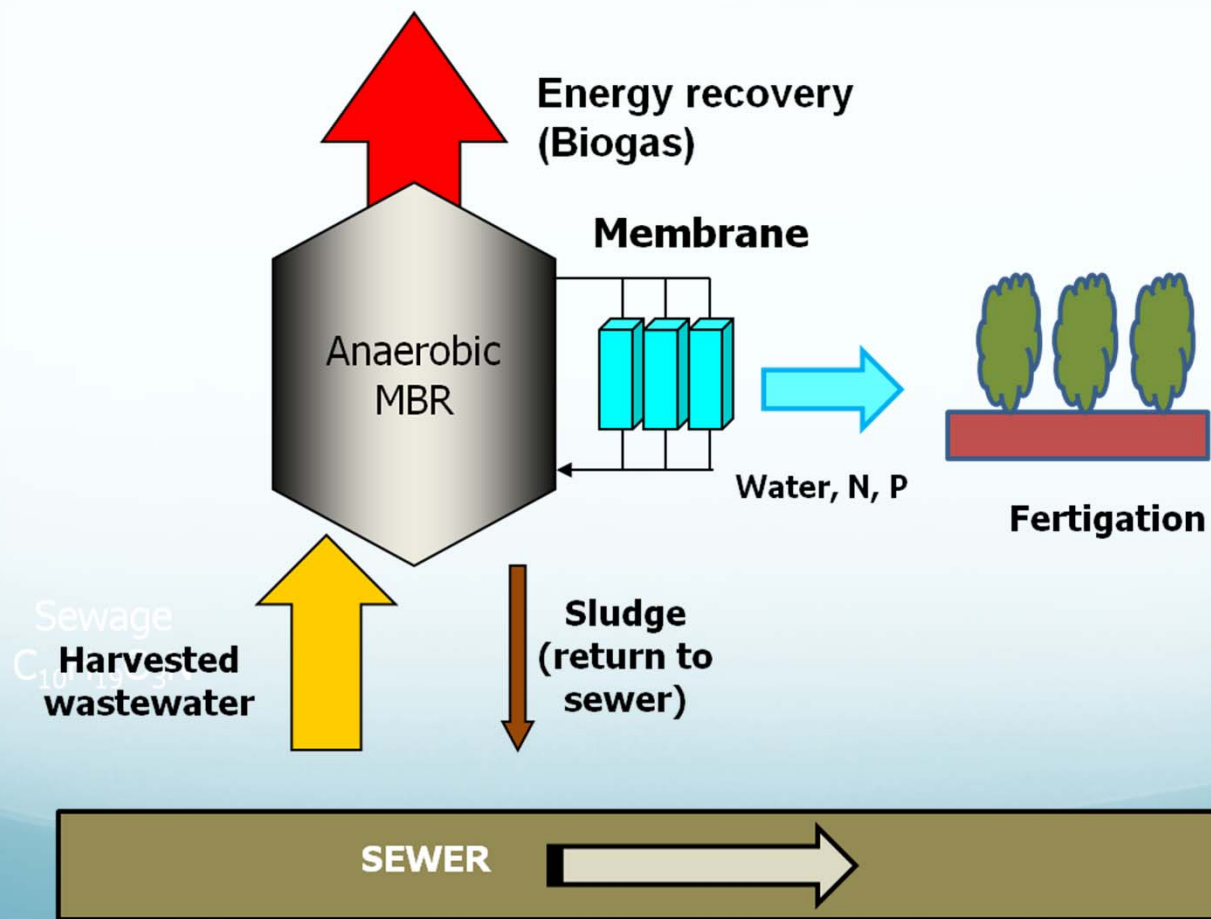

Research Thrust 1: Sustainable Management of Point Sources of Nutrients

SUSTAINABILITY ASSESSMENT of Environmental, Social and Economic COSTS and BENEFITS

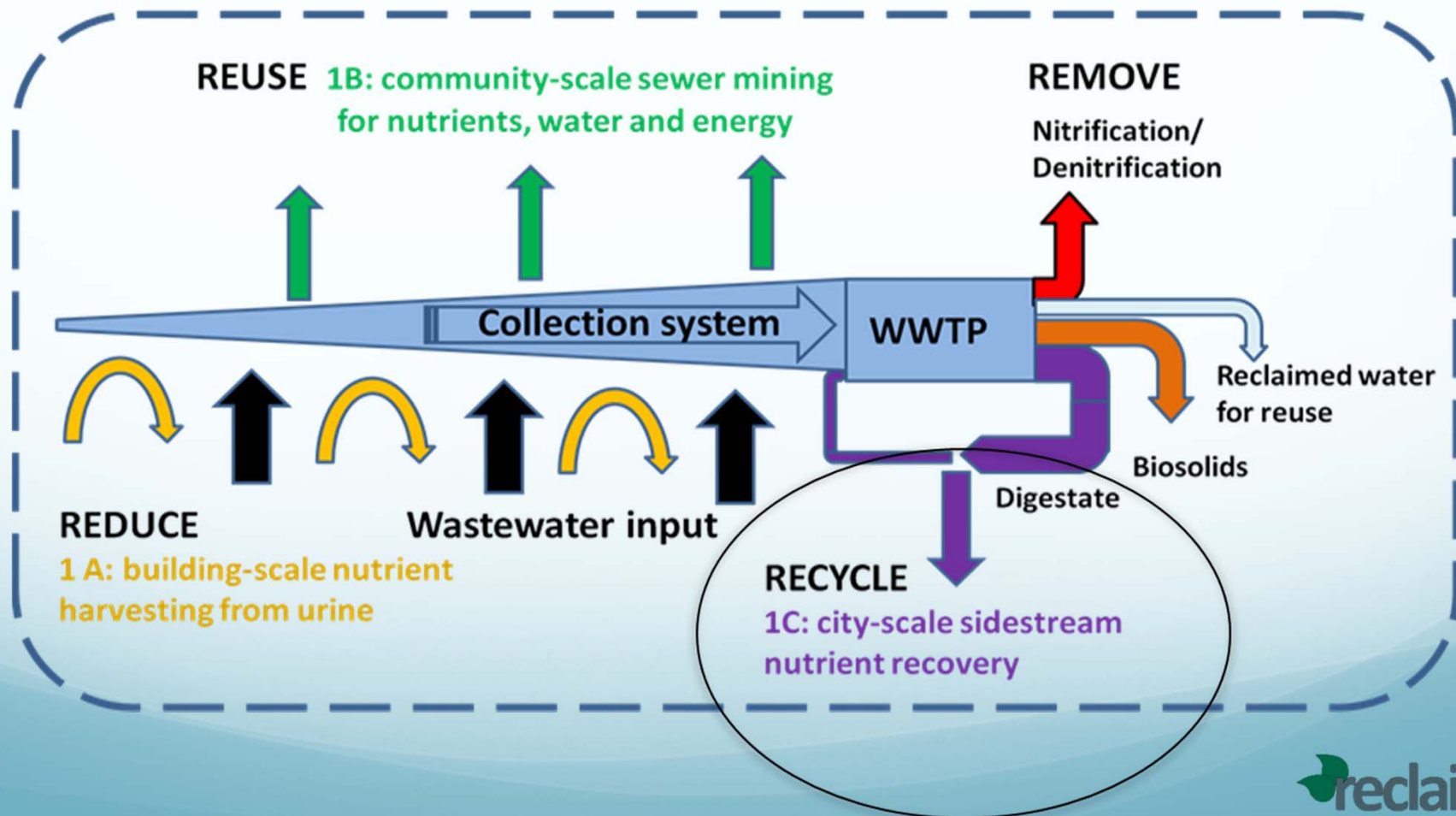

Research Thrust Area 2: Sustainable Management of Diffuse Sources of Nutrients

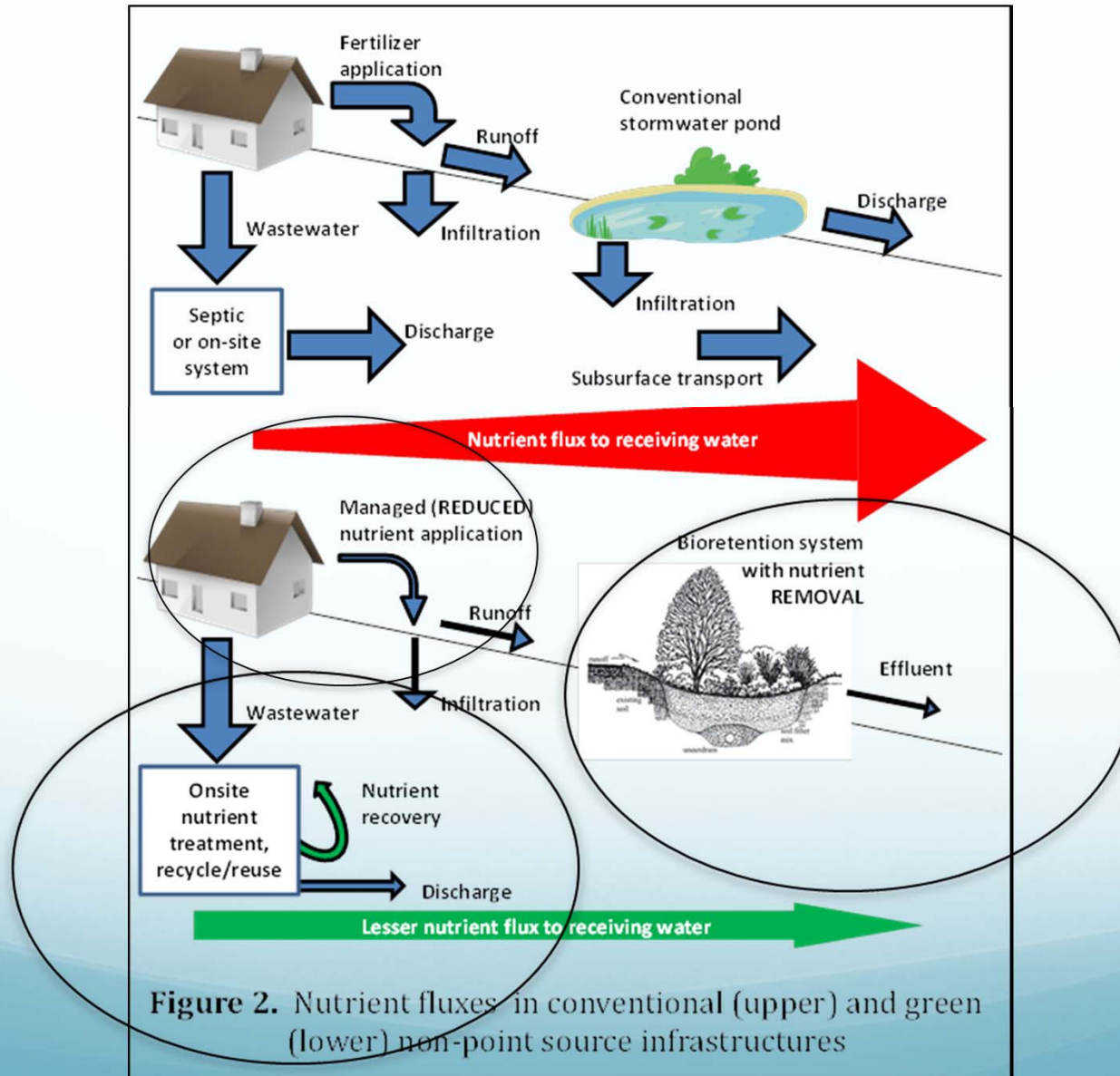

Research Thrust Area 2: Sustainable Management of Diffuse Sources of Nutrients

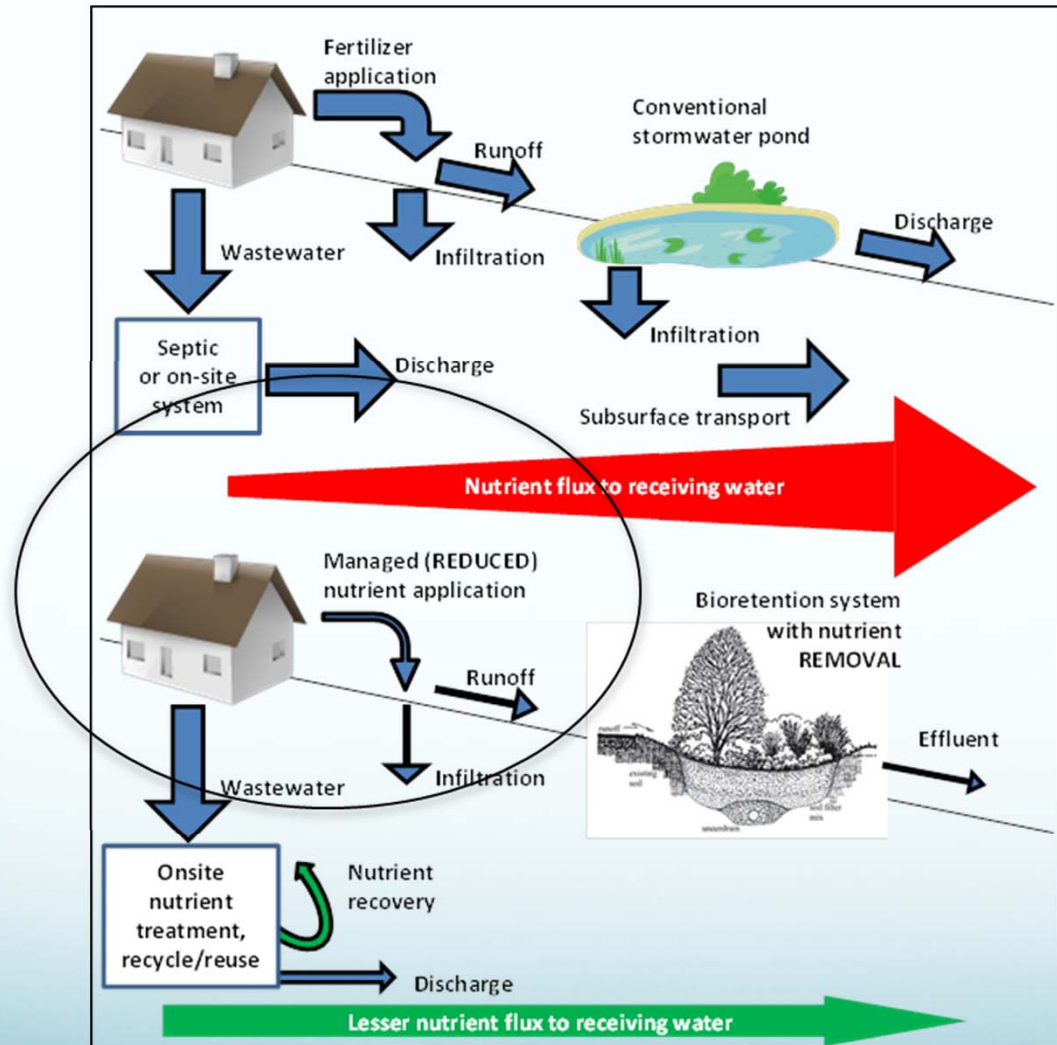
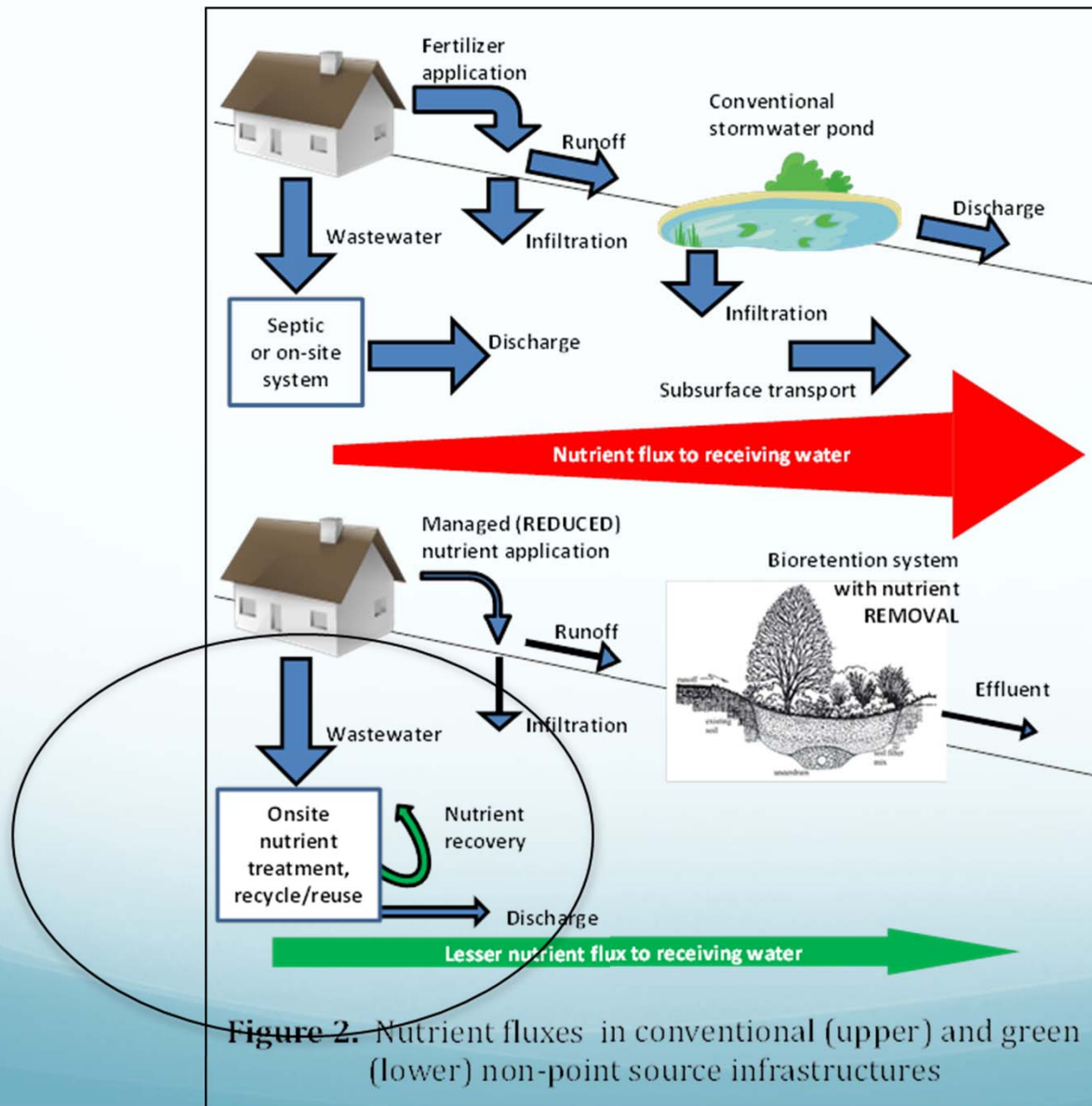

Figure 2. Nutrient fluxes in conventional (upper) and green (lower) non-point source infrastructures

Research Thrust Area 2: Sustainable Management of Diffuse Sources of Nutrients



On-Site Nutrient Treatment/Reuse

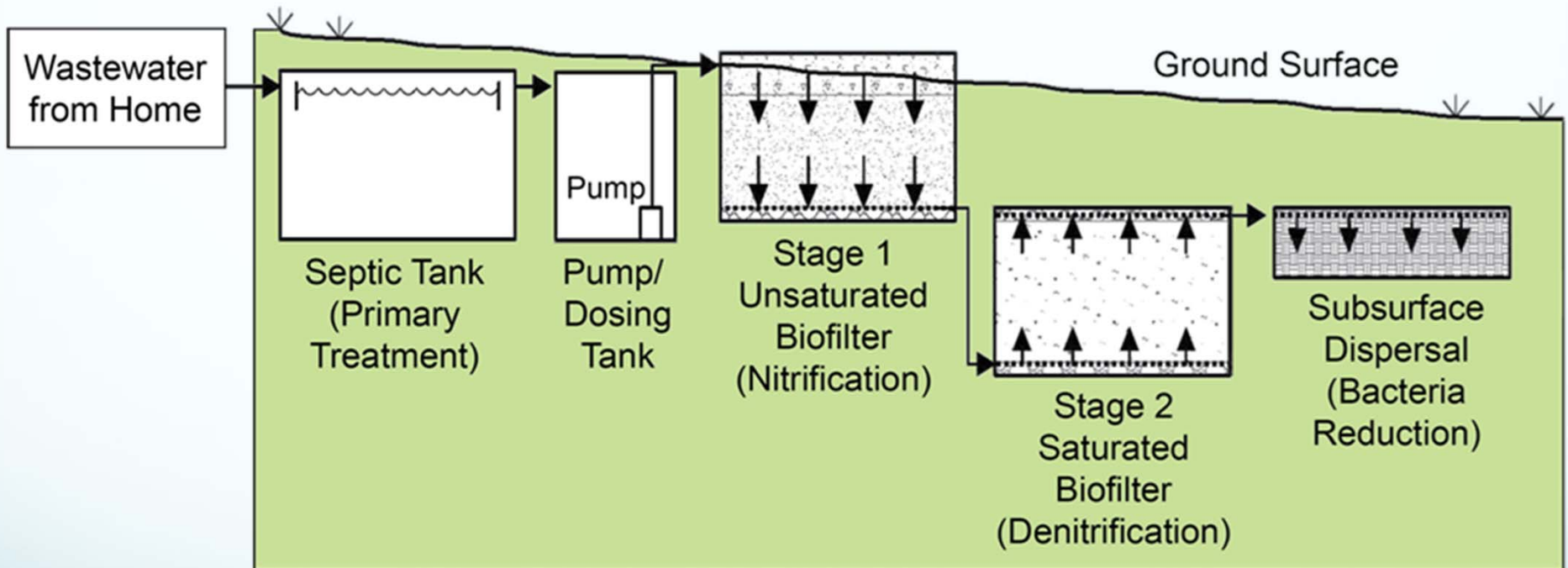
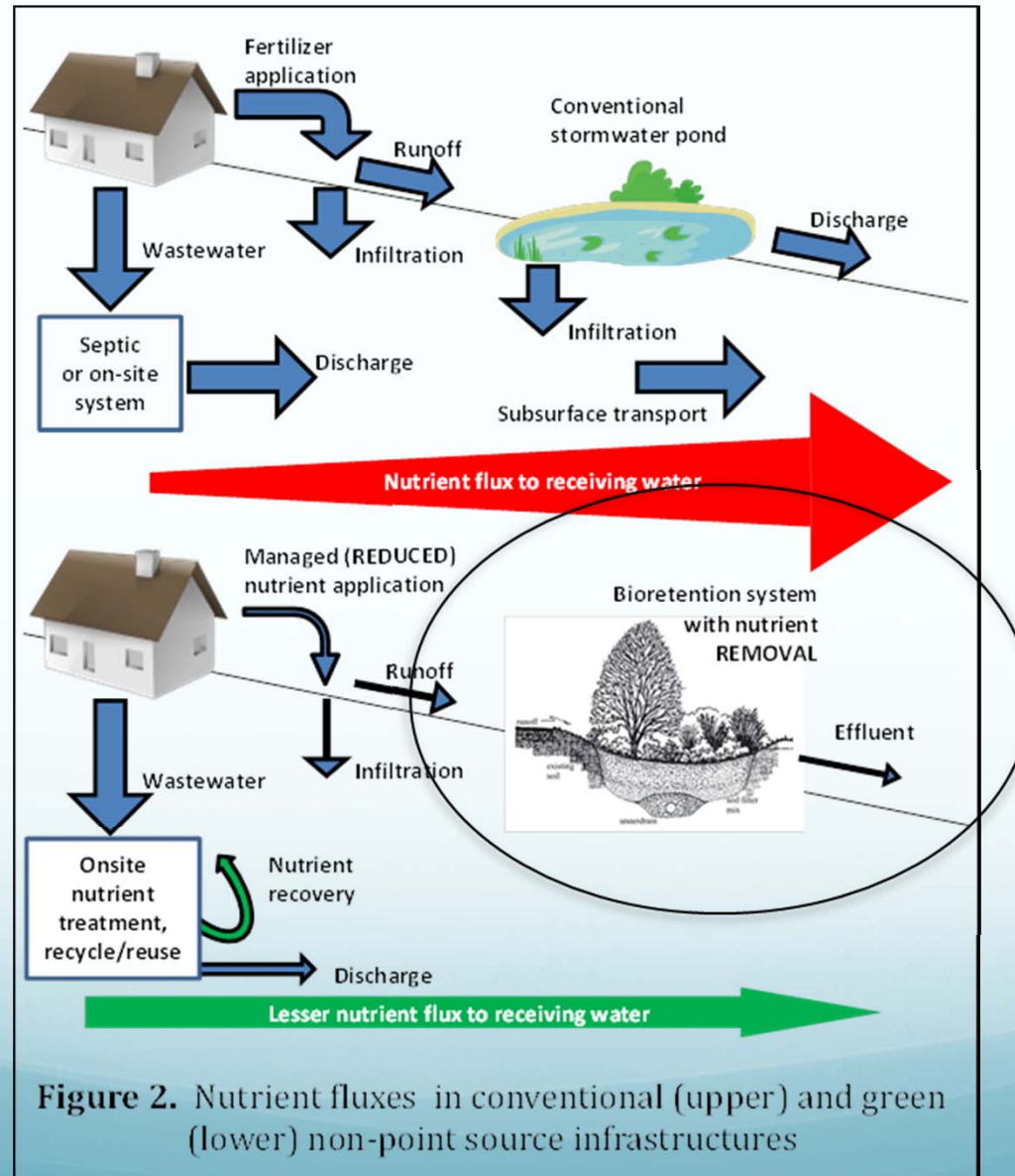

Figure 9. Schematic of passive nitrogen reduction system to be installed at homes as part of the FOSNRS Project (Hirst, 2012)

Research Thrust Area 2: Sustainable Management of Diffuse Sources of Nutrients



Research Thrust Area 3: Socioeconomic & Environmental Sustainability Analysis and Systems Integration

- **Project 3a: Life cycle environmental impact and cost analysis for nutrient removal and recovery technologies**
- **Project 3b: Integrated analytical, hydroeconomic modeling frameworks to analyze the cost-effectiveness of nutrient removal and recovery technologies**
- **Project 3c: Scaling up of integrated hydroeconomic modeling frameworks to nutrient management problems**
- **Project 3d: Reducing social and regulatory barriers to implementation of innovative nutrient management practices in urban coastal watersheds.**



Project 3a. LCA and LCCA of Nutrient Management Strategies

- Goal: Illuminate a path forward for the social optimization of nutrient management techniques for both point and non-point sources.
- Objective: Quantify life-cycle environmental impacts and economic costs of the full portfolio of nutrient management strategies.
- Data sources include Thrust 1 and 2 demonstration projects, WWT facility data, literature, interviews, and LCA databases.

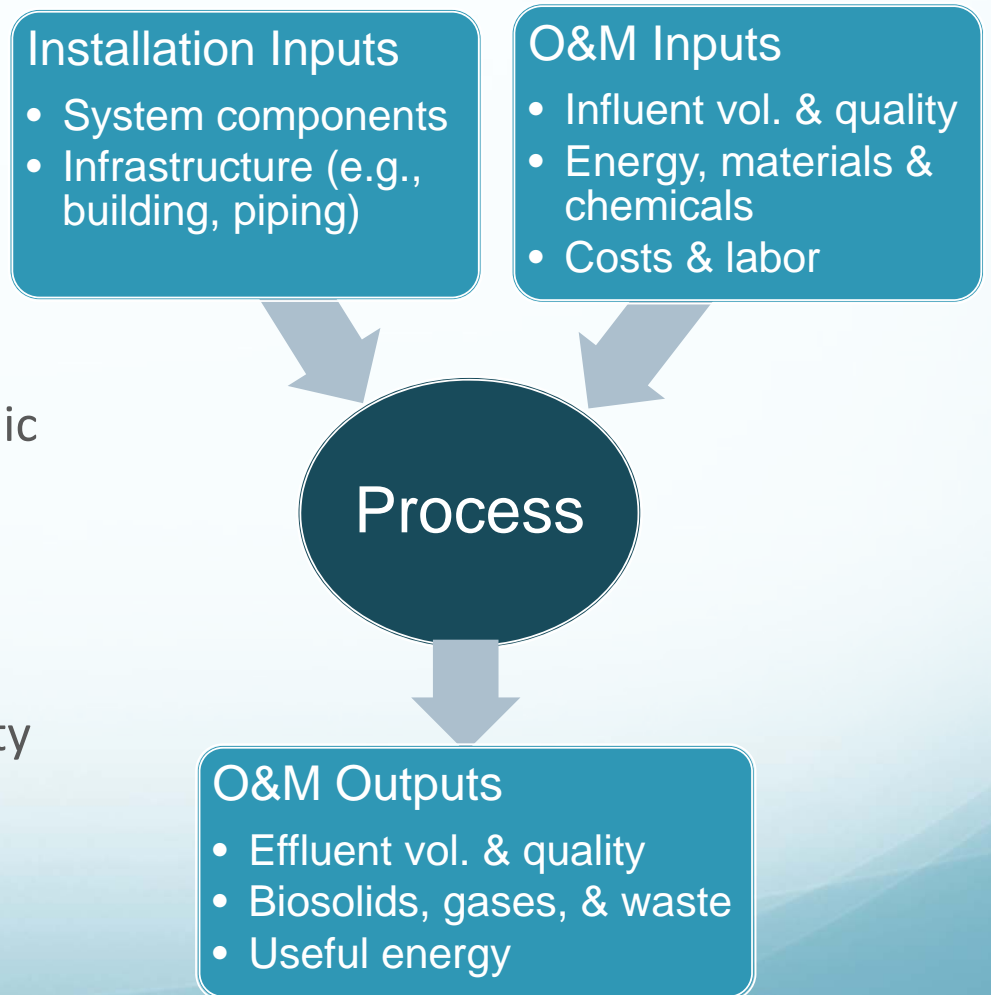

Project 3b. Analytically characterize economic benefits of nutrient removal/recovery, water reuse

- Develop a general understanding of economic tradeoffs
- Establish relationships between model parameters and optimal management policies
- Calibrate models using data obtained from Thrusts 1 and 2
- Estimate private and social benefits
- Derive optimal capacities and removal/recovery rates

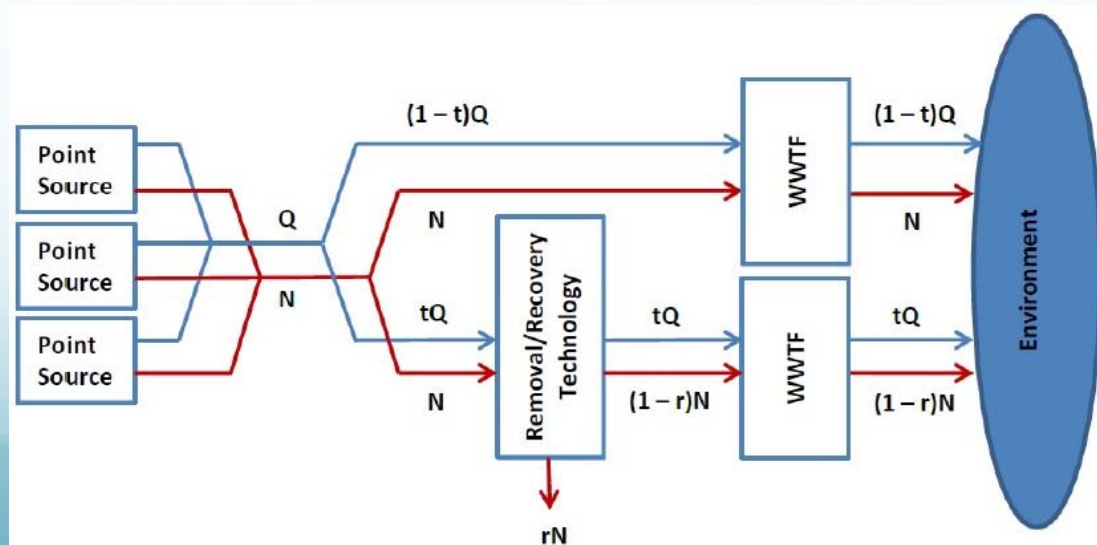

Preliminary study of the drivers of FL municipal wastewater reuse

Water Reuse Capacities

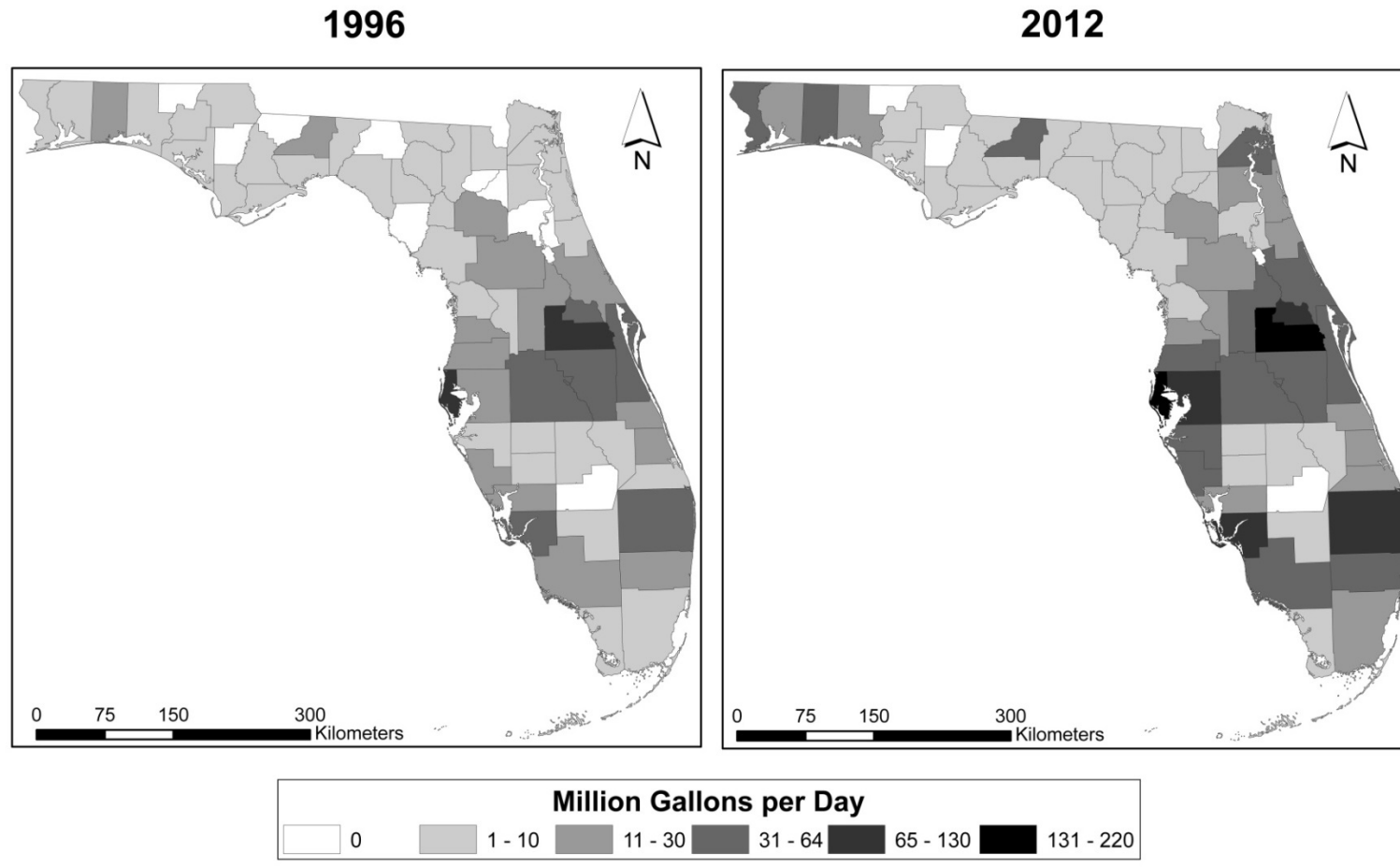

Project 3c. Scale up modeling frameworks to nutrient management in Tampa Bay

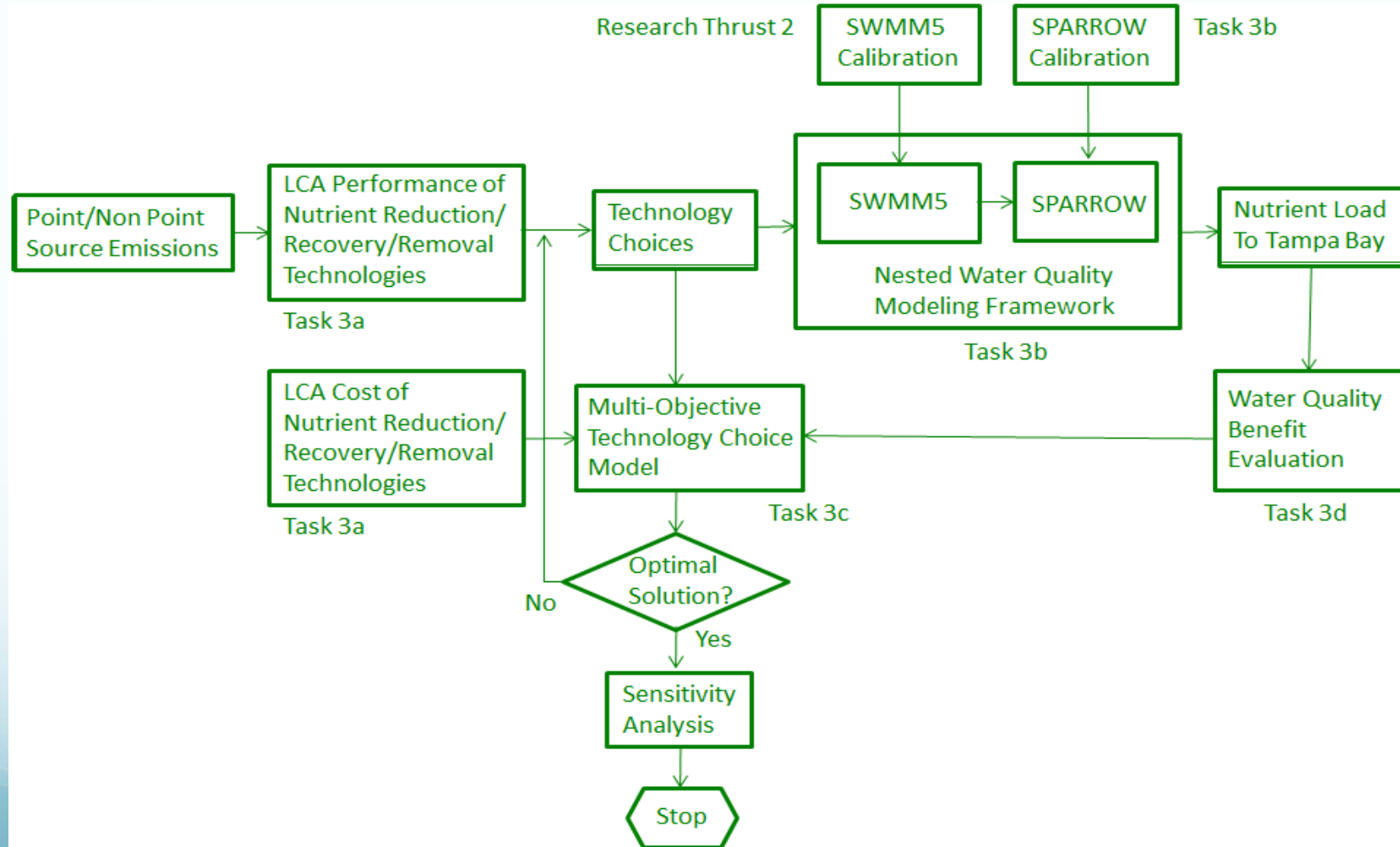

Project 3c. Scale up, and develop decision support tool

- Apply the USGS SPARROW model to quantify costs and benefits from onsite nutrient management using septic tanks.
- Develop a nested water quality modeling framework which combines catchment-scale modeling of impacts of LID and onsite nutrient management technologies.
- Monetize the benefits of simulated water quality improvements in Tampa Bay from innovative nutrient management, using benefit estimates from the economics literature.
- Develop a decision support system for sustainable nutrient management.



Preliminary work with SPARROW on septic systems

Urban Land

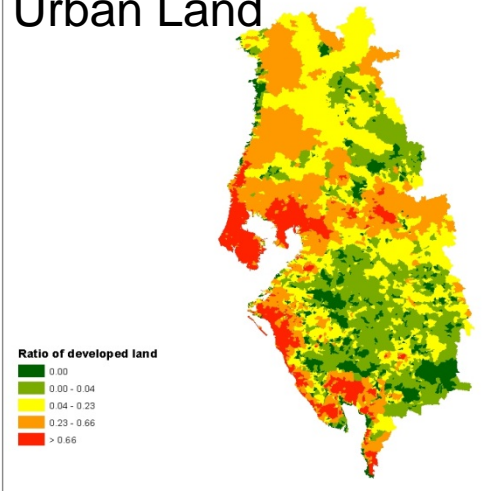

Fertilizer (corn & soybean)

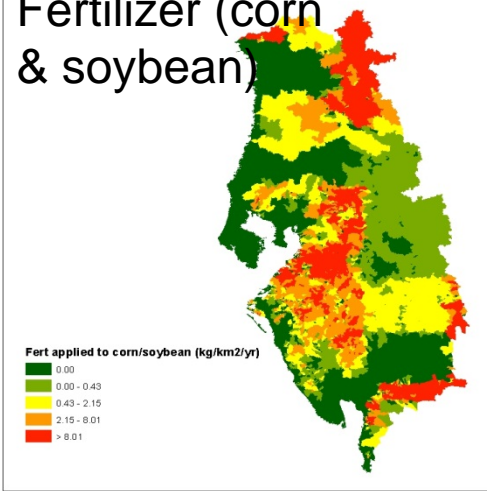

Fertilizer (other crops)

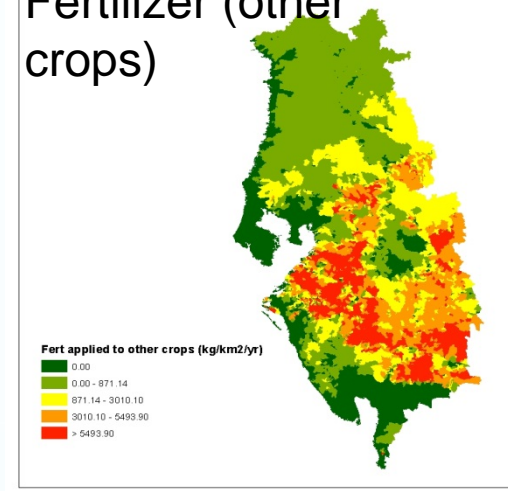

Manure

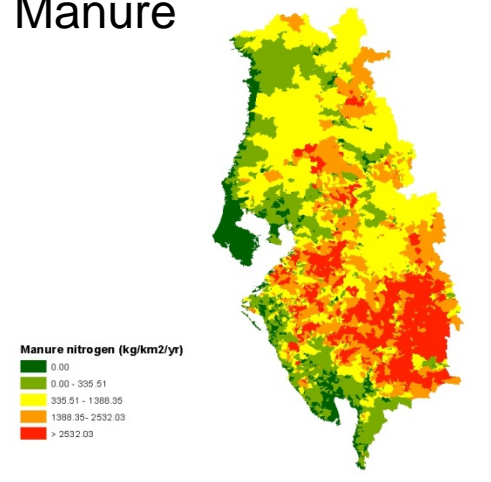

Atmospheric deposition

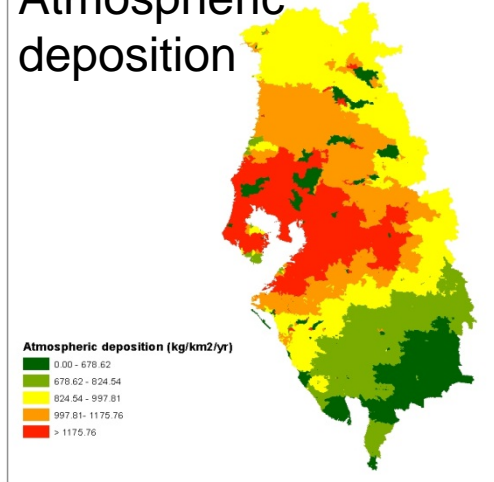

Onsite wastewater treatment system

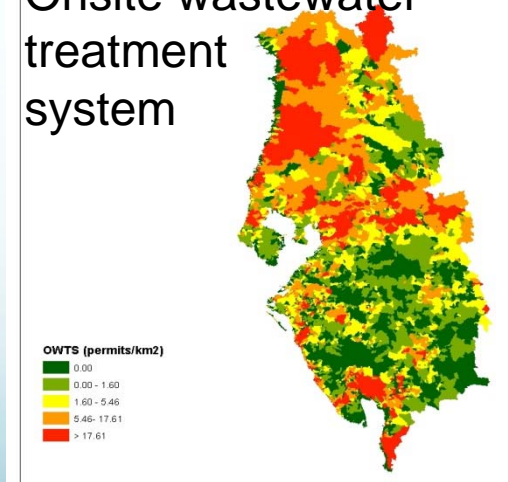

Sample Questions Thrust 3 Will Answer

- **What is the optimal distribution, over geographic space and point/non-point technologies, of nutrient management within the Tampa Bay watershed, considering environmental impacts and life-cycle costs?**
- **How can we quantify economic costs and benefits of implementing onsite nutrient management?**
- **What are the economic and regulatory barriers to adoption of innovative nutrient management technologies across different scales (household, business, community)?**



Questions

<http://usf-reclaim.org/>

Follow us on Twitter: @USF_Reclaim

