

Results of the Lake Michigan Mass Balance Project: Polychlorinated Biphenyls Modeling Report

Prepared for

U.S. Environmental Protection Agency
Great Lakes National Program Office
77 West Jackson Boulevard
Chicago, Illinois 60604

Prepared by

U.S. Environmental Protection Agency
Office of Research and Development
National Health and Environmental Effects Research Laboratory
Mid-Continent Ecology Division
Large Lakes and Rivers Forecasting Research Branch
Large Lakes Research Station
9311 Groh Road
Grosse Ile, Michigan 48138

Ronald Rossmann, Editor



Notice

The information in this document has been obtained primarily through funding by the United States Environmental Protection Agency (USEPA) under the auspices of the Office of Research and Development (ORD) and by the Great Lakes National Program Office (GLNPO). The report has been subjected to the Agency's peer and administrative review and it has been approved for publication as a USEPA document. Mention of trade names or commercial products does not constitute endorsement or recommendation for use.

Foreword

The Lake Michigan Mass Balance Project (LMMBP) was initiated by the United States Environmental Protection Agency (USEPA), Great Lakes National Program Office (GLNPO) to determine strategies for managing and remediating toxic chemicals in the lake basin. Within the ecosystem approach, the mass balance framework is considered the best means of accomplishing this objective, and GLNPO requested the assistance of the USEPA Office of Research and Development (ORD) to facilitate and produce mathematical models that account for the sources, sinks, transport, fate, and food chain bioaccumulation of certain chemicals. This approach has been used in the past and builds upon the modeling efforts that have occurred in the Assessment and Remediation of Contaminated Sediments (ARCS) Program and the lower Fox River/Green Bay Mass Balance Project. The feasibility of such studies and resultant alternative management options for contaminants in large rivers and a large embayment were demonstrated, and a logical extension to the entire Lake Michigan receiving water body and major tributaries was warranted. There were a large number of cooperators in this project, and by focusing Federal, State, local, private, and academic efforts and resources on a common goal, much more was accomplished than if these entities acted independently.

The project was conducted in conjunction with the Enhanced Monitoring Program and the approach required that all monitoring and field research be coordinated and common methodologies used. Mathematical modelers were consulted during planning for sample design, parameters, and temporal and spatial sampling considerations. The product was then a consistent and reliable database of information that was accessible by project participants and the public. Data for the LMMBP were collected primarily during 1994 and 1995 and have been compiled according to specified quality assurance/quality control (QA/QC) requirements, and other data assessments have been made for modeling purposes.

The need to consider the environmental benefits and consequences of alternative remediation choices to protect and improve our environment continues to intensify as: 1) environmental problems become more complex; 2) the means to address and investigate problems become more technical, time-consuming, and expensive; and 3) the actual costs to implement action strategies has escalated. The integrated PCBs mass balance modeling results are presented in this document and can aid managers in establishing priorities for both lake-wide and local improvements. The forecasting of PCB concentrations in top predator fish is one of the primary endpoints of this investigation as it relates to both ecosystem and human health. The capability of forecast modeling presented here is a salient feature of this approach directed toward providing multiple alternatives, which then can be examined through benefit-cost analyses.

This report presents the current status and results of the PCB modeling effort through the summer of 2006. Within this document some recommendations have been provided for potential future work with the models. Of course, a model and modeling applications are never complete, and it is expected that further efforts will change some results, insights, and our understanding of Lake Michigan. These efforts require an investment of resources and time, and improvements with additional model run executions are measured in years. In the larger picture, the need for Agency modeling technologies continues to intensify and the requirement for

reduced uncertainty will lead to future improved generations of models. We have put great emphasis on following guidance provided by the USEPA and other agencies in assuring that the scientific theory is implemented accurately and completely by model computer code and that best modeling practices have been instituted. We also submitted this to scientific peer review using an interdisciplinary panel of scientists and experts that reviewed model theory and application which evolve on a continuing basis. The purpose is to ensure that decisions based on the modeling efforts are reliable and scientifically credible.

This document is not intended to include all of the details and background required to understand the entire LMMBP. Rather the reader should refer to the LMMBP Work Plan and other materials on the GLNPO web site and the Lake Michigan Mass Balance Modeling Quality Assurance Plan on the ORD-Grosse Ile web site for further information.

This document includes replies to peer reviewer comments made during a peer review conducted 27-28 July 2004 in Romulus, Michigan. These replies and the original peer review comments are found in Part 7.

Abstract

The Lake Michigan Mass Balance Project (LMMBP) was conducted to measure and model nutrients, atrazine, polychlorinated biphenyls (PCBs), *trans*-nonachlor, and mercury to gain a better understanding of the sources, sinks, transport, fate, and effects of these substances within the system and to aid managers in the environmental decision-making process for the Lake Michigan Basin. The United States Environmental Protection Agency (USEPA) Office of Research and Development (ORD) was requested to conduct and facilitate modeling in cooperation with the USEPA Region V; the USEPA Great Lakes National Program Office (GLNPO); other Federal agencies; the States of Michigan, Wisconsin, Illinois, and Indiana; the Tribes; and the public and private sectors. The effort was supported by intensive sampling of the atmosphere, major tributaries, sediments, water column, and biota during the 1994-1995 field years as well as by extensive quality assurance and database development. Multimedia, mass balance modeling frameworks were applied to examine primary source and loss categories and make various model forecasts for a variety of loading scenarios. This report focuses on the modeling practices applied and results for PCBs from the MICHTOX screening-level model and the higher-resolution LM2-Toxic and LM Food Chain models. A unique aspect of this work is the modeling of PCBs on a congener-level basis to make predictions of total PCBs in the system.

Results of the system mass balance show that the greatest, external gross input of PCBs to the system is atmospheric vapor phase absorption followed by tributary inputs and atmospheric deposition, respectively. The greatest gross losses from the system are volatilization and deep burial in sediments. Internal PCBs loading from sediment resuspension is substantial. Gross PCBs inputs to, losses from, and cycling processes within the system each typically exceed 1000 kg/year. Tributary inputs and atmospheric deposition are approximately 381 and 980 kg/year, respectively. Results indicate that during the mass balance field collection years of 1994-1995, the Fox, Grand, Calumet, and Kalamazoo Rivers had the largest tributary loads of PCBs to Lake Michigan. When all gross input and output fluxes are summed, the system exhibits a net loss of approximately 3,229 kg/year of PCBs. The mass balance results demonstrate the importance of contaminant cycling and the dynamic interactions among air, water, and sediments. These interactions, with present PCB inventories already in the lake, will continue to control PCB concentrations in the system.

LM Food Chain, linked to LM2-Toxic, and MICHTOX were used to forecast future concentrations of PCBs in lake trout at two sites for various loading scenarios. Scenarios included constant 1994-1995 conditions, fast continued recovery with an atmospheric load half-life of 6.0 years, slow continued recovery with an atmospheric load half-life of 20.0 years, and various combinations of reduced atmospheric and tributary loadings. Forecasts indicate that PCBs concentrations in lake trout will continue to decrease. For the fast continued recovery scenario, the target level for the unrestricted consumption of fish (0.075 ppm) was forecasted to be achieved for five to six year-old lake trout between the years 2030 and 2036. The narrow forecast range for scenarios, past actions, the long-term decrease in loads, and decreasing PCB concentrations in the system indicate that PCBs are presently controlled by dynamic interactions among media, as well as air and sediment cycling. Model results from the present two models are compared. In the future, these results will be compared to those from a greater-resolution model under development (LM3-

Toxic). It is anticipated that the higher-resolution model will better delineate the nearshore and sediment zones, define lake interactions with tributary inputs, and describe PCBs in lake trout populations.

This synthetic lake-wide perspective is anticipated to aid managers in moving forward on pollution prevention, remedial actions, and legislative priorities associated with the Lake Michigan Lake-wide Management Plans. It will also help describe expected local improvements associated with Remedial Action Plans in Areas of Concern. *This abstract does not necessarily reflect USEPA policy.*

Table of Contents

Notice	ii
Foreword	iii
Abstract	v
Table of Contents	vii
List of Figures	xviii
List of Tables	xxx
Abbreviations	xxxvi
Acknowledgments	xxxviii
Executive Summary	xxxix
Part 1 Introduction	1
Chapter 1 Project Overview	1
1.1.1 Background	1
1.1.2 Description	2
1.1.3 Scope	3
1.1.3.1 Modeled Pollutants	3
1.1.3.1.1 PCBs	3
1.1.3.1.2 Isomer <i>trans</i> -Nonachlor	5
1.1.3.1.3 Atrazine	5
1.1.3.1.4 Mercury	5
1.1.3.2 Other Measured Parameters	6
1.1.3.3 Measured Compartments	6
1.1.4 Objectives	6
1.1.5 Design	7
1.1.5.1 Organization	7
1.1.5.2 Study Participants	9
1.1.5.3 Workgroups	9
1.1.5.4 Information Management	9
1.1.5.4.1 Data Reporting	10
1.1.5.4.2 Great Lakes Environmental Monitoring Database	11
1.1.5.4.3 Public Access to LMMBP Data	11
1.1.5.5 Quality Assurance Program	11
1.1.6 Project Documents and Products	13

Chapter 2	PCBs Modeling Overview	16
1.2.1	Background	16
1.2.2	Modeling Objectives	16
1.2.3	Historical Modeling	17
1.2.3.1	Lake-1	17
1.2.3.2	Completely-Mixed Model	18
1.2.3.3	General Mass Balance Framework for Toxic Chemicals in the Great Lakes	18
1.2.3.4	Food Web Bioaccumulation Model	18
1.2.3.5	MICHTOX	18
1.2.3.6	Green Bay Mass Balance Project	19
1.2.3.7	SEDZL	19
1.2.4	Model Resolution	19
1.2.5	Models Developed and Applied	21
1.2.5.1	Lake Process Models	21
1.2.5.2	Hydrodynamics (POM)	21
1.2.5.3	Eutrophication/Sorbent Dynamics (LM3-Eutro)	22
1.2.5.4	Contaminant Transport and Fate (LM2-Toxic)	22
1.2.5.5	Food Web Bioaccumulation (LM Food Chain)	23
1.2.6	Model Quality Assurance	23
1.2.7	Model Application and Computational Aspects	23
1.2.7.1	Annual Simulations	23
1.2.7.2	Long-Term Simulations	23
Chapter 3	Information Management	26
1.3.1	Overview of Information Management at the LLRS	26
1.3.2	Calculation of Total PCBs	28
1.3.3	Regression Analysis of Measured Congener, Total PCB Data	28
1.3.4	Summary	30
Appendix 1.3.1	List of Parameters Analyzed and Principal Investigators for the LMMBP	31
Appendix 1.3.2	Example of Data Verification Checklist Used for the LMMBP	35
Appendix 1.3.3	Printout of Information Stored in the LMMBP Tracking Database (R:/Access2000/Immb/Imtrack.mdb)	39
Appendix 1.3.4	Generalized Format for the LMMBP Water Data to be Analyzed With IDL Programs	44
Appendix 1.3.5	Generalized Format for the LMMBP Sediment Data to be Analyzed With IDL Programs	46
Appendix 1.3.6	Generalized Format for the LMMBP Fish Data to be Analyzed With IDL Programs	48
Appendix 1.3.7	Documents From Marcia Kuehl Discussing How Total PCBs Were Calculated by Focus Groups	50
Appendix 1.3.8	Uncertainty of Z Values (Slope of Linear Regression Line) for PCBs in Media Modeled at the LLRS for the LMMBP	53

Chapter 4 Representativeness of the LMMBP Years Relative to Lake Michigan's Historic Record	55
1.4.1 Introduction	55
1.4.2 Ice Cover	55
1.4.3 Water and Air Temperatures	56
1.4.4 Lake Water Levels	59
1.4.5 Precipitation	59
1.4.5.1 Annual Comparisons	59
1.4.5.2 Monthly Comparisons	59
1.4.6 Tributary Flows	59
1.4.7 Wave Heights	59
1.4.8 Summary	63
Chapter 5 PCBs in the Lake Michigan Ecosystem	66
1.5.1 Introduction	66
1.5.2 Atmospheric	66
1.5.2.1 Vapor Phase	66
1.5.2.2 Precipitation	69
1.5.2.3 Particulate	71
1.5.2.4 Dry Deposition	71
1.5.3 Lake Water	71
1.5.3.1 Total PCBs	71
1.5.3.2 Dissolved PCBs	71
1.5.3.3 Particulate PCBs	78
1.5.4 Tributaries	78
1.5.5 Sediment	83
1.5.6 Biota	86
1.5.7 Summary	86
Chapter 6 Congener Pattern Matching of Data Collected for the Lake Michigan Mass Balance Project (LMMBP)	93
1.6.1 Introduction	93
1.6.2 Analytical Approach	94
1.6.3 Methodology	94
1.6.4 Results	94
1.6.4.1 Comparison of Modeled Congener Patterns to All Analyzed Congener Patterns	94
1.6.4.2 Comparison of Median to Mean Data	97
1.6.4.3 Comparison of Congener Patterns in Different Media in Segment 2/ Saugatuck Biota Box	97
1.6.4.4 Comparison of Atmospheric Congener Data	101
1.6.4.5 Comparison of Tributary Congener Patterns	103
1.6.4.6 Comparison of Ages 5 and 6 Lake Trout Congener Patterns in All Biota Boxes	105
1.6.4.7 Comparison of Different Lake Trout Age Class Congener Patterns in Saugatuck Biota Box	105
1.6.5 Conclusions	105

Chapter 7 Hindcasting and Forecasting Functions for PCBs in the Lake Michigan Ecosystem	110
1.7.1 Introduction	110
1.7.2 Forecast Functions	110
1.7.2.1 Tributary Loads	111
1.7.2.2 Atmospheric Loads	112
1.7.3 Hindcast Functions	112
1.7.4 Estimated PCB Storage	117
Part 2 LM2-Eutro	120
Chapter 1 Conclusions (Executive Summary)	120
Chapter 2 Recommendations	123
Chapter 3 Model Description	125
2.3.1 Transport Scheme for Lake Michigan	125
2.3.2 Sediments	126
2.3.3 Formulation of Eutrophication Equations	126
Appendix 2.3.1 Development of LM3-Eutro Equations	130
A2.3.1.1 Phytoplankton Growth	130
A2.3.1.2 Zooplankton Kinetics	133
A2.3.1.3 Carbon Interactions	133
A2.3.1.4 Phosphorus	135
A2.3.1.5 Nitrogen	137
A2.3.1.6 Silica	138
Chapter 4 Model Input and Field Data	140
2.4.1 Loading and Sediment-Water Interactions	140
2.4.1.1 Atmospheric Loads	140
2.4.1.2 Tributary Loads	140
2.4.1.3 Shoreline Erosion	141
2.4.1.4 Sediment	142
2.4.2 Field Data	142
2.4.2.1 Open Lake Nutrient and Carbon Data	142
2.4.2.1.1 Total Phosphorus	142
2.4.2.1.2 Dissolved Phosphorus	144
2.4.2.1.3 Soluble Reactive Phosphorus	144
2.4.2.1.4 Nitrate	145
2.4.2.1.5 Ammonia	145
2.4.2.1.6 Total Kjeldahl Nitrogen	145
2.4.2.1.7 Dissolved Silica	145
2.4.2.1.8 Dissolved Organic Carbon	145

2.4.2.1.9	Particulate Organic Carbon	145
2.4.2.1.10	Green Bay Nutrient Data	145
2.4.2.2	Plankton	146
2.4.2.2.1	Phytoplankton	146
2.4.2.2.2	Chlorophyll <i>a</i>	146
2.4.2.2.3	Phytoplankton Carbon	147
2.4.2.2.4	Zooplankton	149
2.4.2.2.5	Zooplankton Carbon	150
2.4.3	Initial Conditions	150
2.4.4	Parameter Estimation	152
2.4.4.1	Physical Measurements	152
2.4.4.1.1	Secchi Disk	152
2.4.4.1.2	Solar Radiation and Temperature	152
2.4.4.2	Primary Production Estimates	152
Appendix 2.4.1	Modeled Versus Measured Variables	157
Chapter 5	Calibration	159
2.5.1	Description of Process	159
2.5.2	Selection of Best Calibration	160
2.5.2.1	Phytoplankton	160
2.5.2.2	Particulate Organic Carbon	167
2.5.2.3	Total Phosphorus	167
2.5.2.4	Dissolved Silica	167
Chapter 6	Model Confirmation	168
2.6.1	Additional Field Data	168
2.6.2	MICH1 Model	168
2.6.3	Comparison of LM3-Eutro to the MICH1 Model and Field Data	168
Chapter 7	Results – Application of Model	171
2.7.1	Scenario 1 – Constant Conditions	171
2.7.1.1	Description of Assumptions	171
2.7.1.2	Results and Discussion	171
2.7.2	Scenario 2 – Virtual Elimination (Lower Bound)	171
2.7.2.1	Description of Assumptions	171
2.7.2.2	Results and Discussion	171
2.7.3	Scenario 3 – Best Estimate of Current Trends Resulting From Previous Actions	173
2.7.3.1	Description of Assumptions	173
2.7.3.2	Results and Discussion	173
2.7.4	Scenario 4 – Scenario 1 With Instantaneous Reduction of Tributary Loads to Zero	173
2.7.4.1	Description of Assumptions	173
2.7.4.2	Results and Discussion	174

2.7.5	Scenario 5 – Scenario 1 With Instantaneous Reduction of Atmospheric Loads to Zero	174
2.7.5.1	Description of Assumptions	174
2.7.5.2	Results and Discussion	174
2.7.6	Scenario 6 – Scenario 1 With Tributary and Atmospheric Loads Increased 20%	174
2.7.6.1	Description of Assumptions	174
2.7.6.2	Results and Discussion	176
2.7.7	Scenario 7 – Application of Great Lakes Water Quality Agreement Loads to Model	176
2.7.7.1	Description of Assumptions	176
2.7.7.2	Results and Discussion	177
2.7.8	Scenario 8 – Estimate of Total Maximum Daily Loads to Reach International Joint Commission’s Target Total Phosphorus Concentration	177
2.7.8.1	Description of Assumptions	177
2.7.8.2	Results and Discussion	177
2.7.9	Scenario Comparison and Discussion	177
2.7.10	Mass Budget	177
	Chapter 8 Results Provided for LM2-Toxic	182
2.8.1	Description	182
2.8.2	Manipulation of Results	182
Part 3	Level 1 Models	183
	Chapter 1 MICHTOX PCB Model Executive Summary	183
	Chapter 2 MICHTOX Recommendations	185
	Chapter 3 MICHTOX PCB Fate and Transport Modeling	186
3.3.1	Description	186
3.3.2	Description of Data Used in MICHTOX	189
3.3.2.1	Water Column PCB Concentrations	189
3.3.2.2	Surficial Sediment PCB Concentrations	189
3.3.2.3	Atmospheric and Tributary Loads	189
3.3.3	Model Confirmation	191
3.3.3.1	Description of Hindcast Process	191
3.3.3.2	Hindcast Results	192
3.3.3.3	Comparison to the LMMBP Data	196
3.3.4	Model Uncertainty	198
	Chapter 4 MICHTOX Food Chain Modeling	201
3.4.1	Model Development	201
3.4.2	Description of the Data Used in MICHTOX Food Chain	202
3.4.2.1	Description of Data	202
3.4.2.2	Sources and Choice of Constants	203

3.4.3	Model Confirmation	203
3.4.4	Results – Forecast Scenarios	207
3.4.4.1	Conditions Remain the Same as 1994-1995 (Constant Conditions)	207
3.4.4.2	Continued Recovery – Fast	208
3.4.4.3	Continued Recovery – Slow	209
3.4.5	Model Sensitivity	209
3.4.5.1	No Atmospheric Wet and Dry Deposition Loadings	209
3.4.5.2	No Tributary Loadings	210
3.4.5.3	No Atmospheric Deposition and No Tributary Loadings	210
3.4.5.4	Sediment Total PCB Concentration Initial Conditions Set to Zero	210
Appendix 3.4.1	Derivation of a Hypothetical Lake Michigan Lake Trout Fish Consumption Criteria for PCBs	212
Part 4	LM2-Toxic	216
Chapter 1	Executive Summary	216
Chapter 2	Recommendations	221
Chapter 3	Model Description	223
4.3.1	Model Framework	223
4.3.2	Model Configuration	224
4.3.2.1	Spatial Resolution – Segmentation	224
4.3.2.2	Temporal Resolution	228
4.3.3	Water Balance	228
4.3.4	Solid Balance	231
4.3.4.1	Solid Kinetics	232
4.3.4.2	Sediment Transport	233
4.3.4.2.1	Steady-State Resuspension Calibration	234
4.3.4.2.2	Empirical Wave-Induced Resuspension Calculation	235
4.3.4.2.3	The Sediment Bed – Semi-Lagrangian Option	237
4.3.5	Chemical Balance	238
4.3.5.1	PCB Partitioning	239
4.3.5.2	PCB Air-Water Exchange	240
4.3.5.3	PCB-Specific Parameterization	242
4.3.6	Modification	242
Appendix 4.3.1	Lake Michigan Resuspension Field Data Set	246
Appendix 4.3.2	Notes From Nathan Hawley on the Data Set in Appendix 4.3.1	247
Chapter 4	Model and Field Data	248
4.4.1	Water Transport	248
4.4.1.1	Circulation	248
4.4.1.2	Vertical Dispersion	250
4.4.1.3	Verification of Water Transport Fields	250

4.4.2	Organic Carbon	257
4.4.2.1	Loads	257
4.4.2.2	Field Data and Initial Conditions	258
4.4.2.3	Parameterization	266
4.4.3	PCBs	271
4.4.3.1	Loading	272
4.4.3.2	Field Data, Initial Conditions, and Boundary Conditions	273
4.4.3.3	Parameterization	273
4.4.3.4	Kinetic Time Functions	281
Appendix 4.4.1	Sample Data Interpolation for the LMMBP	286
A.4.4.1.1	The Distance Square Inverse Method	287
A.4.4.1.2	The Natural-Neighborhood Method	287
A.4.4.1.3	Application	288
A4.4.1.3.1	Contouring Plots	288
A.4.4.1.3.2	Volume-Weighted Averaging With Formulations	288
A.4.4.1.4	Discussion	289
A.4.4.1.5	Steps to Run nngridr	289
Chapter 5	LM-2 Toxic Calibration and Confirmation	291
4.5.1	Vertical Dispersion Coefficients Calibration	291
4.5.2	Organic Carbon Dynamics Calibration	293
4.5.2.1	Calibration Process/Procedure	293
4.5.2.2	Results and Discussion	293
4.5.3	PCB Dynamics Calibration	294
4.5.3.1	Calibration Procedures	304
4.5.3.2	Results and Discussion	305
4.5.4	The LM2-Toxic Confirmation	313
4.5.4.1	Mass Balance Checking	313
4.5.4.2	Chloride Model	313
4.5.4.3	¹³⁷ Cs and ^{239,240} Pu Simulation and Results	313
4.5.4.4	Long-Term Organic Carbon Simulations	317
4.5.4.5	PCB Hindcast	319
4.5.4.5.1	Data and Procedure for the PCB Hindcast	319
4.5.4.5.2	Results From the LM2-Toxic PCB Hindcast	328
Appendix 4.5.1	Results From Thermal Balance Model	337
Appendix 4.5.2	Calibrated Results for Organic Carbons	349
Appendix 4.5.3	Calibration Results for PCB ₂₈₊₃₁ and ΣPCBs	365
Appendix 4.5.4	Simulation Results From Chloride	418
Appendix 4.5.5	Primary Production for the LM2-Toxic	426
Chapter 6	The LM2-Toxic Application and Interpretation	430
4.6.1	Conversion of PCB Congener Results to Total PCBs	430
4.6.2	Mass Budget Diagnosis of the LM2-Toxic for the LMMBP Period	430

4.6.3	LM2-Toxic Application for Long-Term Forecast and Sensitivity Scenarios	436
4.6.4	Results of the Forecast and Sensitivity Scenarios and Discussion	437
4.6.5	Results Provided for the LM Food Chain Model	442
Chapter 7 LM2-Toxic Sensitivity Analysis		444
4.7.1	Primary Production Sensitivity	444
4.7.2	PCB Loads Sensitivity	450
Part 5	LM Food Chain	453
Chapter 1 Executive Summary		453
Chapter 2 Recommendations		455
5.2.1	Additional Model Validations	455
5.2.2	Model Applications	455
5.2.3	Future Improvements	456
Chapter 3 Model Description		457
5.3.1	Chemical Bioaccumulation in Fish	457
5.3.1.1	Chemical Uptake From Water	458
5.3.1.2	Chemical Uptake From Prey	459
5.3.1.3	Chemical Elimination <i>Via</i> Gills	459
5.3.1.4	Chemical Dilution by Growth	460
5.3.2	Chemical Bioaccumulation in the Base of Food Webs	460
5.3.2.1	Chemical Bioaccumulation in Zooplankton	460
5.3.2.2	Chemical Bioaccumulation in <i>Diporeia</i>	461
5.3.3	Model Description of Exposure Environment	462
Chapter 4 Description of Data, Constants, and Other Information Necessary to Run Model		465
5.4.1	Chemical Properties of PCB Contaminants	465
5.4.2	Site-Specific Data	465
5.4.2.1	Fish Food Web Structures	465
5.4.2.1.1	Lake Trout Food Web	465
5.4.2.1.2	Coho Salmon Food Web	468
5.4.2.2	Fish Growth Rates	475
5.4.2.3	Energy Density of Food Web Components	476
5.4.2.4	Exposure Conditions	476
5.4.2.4.1	PCB Concentrations in Water	481
5.4.2.4.2	PCB Concentrations in Sediment	481
5.4.2.4.3	Exposure Temperature	483
5.4.2.4.4	Oxygen Concentration in Water	483

5.4.3	Physiological Data of Fish and Other Organisms	483
5.4.3.1	Species-Specific Respiration Rates	483
5.4.3.2	Respiration Rates Adjusted for Specific Dynamic Action (SDA)	486
5.4.4	Calibrated Model Parameters	487
Chapter 5 Calibration		492
5.5.1	Introduction	492
5.5.2	Description of Process	492
5.5.3	Calibration Results	493
5.5.4	Field Data for PCBs in Fish and Their Comparisons to Calibrated Model Outputs	495
Appendix 5.5.1	PCB Concentrations	502
Appendix 5.5.2	Agreement Between Modeled and Observed PCB Concentrations	516
Chapter 6 Model Verification		526
5.6.1	Introduction	526
5.6.2	Model Applicability to Other Sites	526
Chapter 7 Model Sensitivity and Uncertainty		528
5.7.1	Introduction	528
5.7.2	Sensitivity Analysis	528
5.7.2.1	Chemical Assimilation Efficiency (α)	529
5.7.2.2	Food Assimilation Efficiency (β)	529
5.7.2.3	Chemical Relative Gill Transfer Coefficient (E_c/E_o)	531
5.7.2.4	The Fraction of Ingested Energy for Specific Dynamic Action (SDA)	531
5.7.2.5	Fish Growth Rate	532
5.7.2.6	Octanol-Water Partition Coefficient K_{ow}	533
5.7.2.7	Fish Diet	533
Chapter 8 Model Application		536
5.8.1	Introduction	536
5.8.2	Simulation of Fish PCB Levels Based on Hypothetical Exposure Inputs	536
5.8.2.1	Exposure Concentration Inputs Used for Model Simulations	536
5.8.2.2	Responses of Fish Models to Different Exposure Inputs	537
5.8.2.3	Discussion	542
Part 6	Comparison of Model Results	544
6.1	Summary	544
6.2	Comparison of Models	545
6.2.1	Model Similarities	545
6.2.2	Model Differences	546
6.3	Comparison of Model Results	547
6.3.1	Comparison of Mass Budget Analyses	547
6.3.2	Comparison of Model Forecast Scenarios	547

Part 7	Appendices	552
	Appendix 7.1 Lake Michigan Mass Balance Project (LMMBP) PCB Peer Review Report	552
7.1.1	Executive Summary	552
7.1.2	LMMBP Peer Review Panel	553
7.1.3	LMMBP PCB Charge to Peer Reviewers	553
	7.1.3.1 Overall Multimedia Ecosystem Modeling Approach	555
	7.1.3.2 Overall Model Performance	555
	7.1.3.3 Suitability for Management	555
7.1.4	Modelers' Responses to Peer Review Comments	555
7.1.5	Modelers' Responses to Specific Comments Made by Peer Review Panel Member – James Martin	563
	Appendix 7.2 Comments as Received From Dr. James Martin Peer Review Summary: Lake Michigan Mass Balance Project	573
7.2.1	General Comments	573
	7.2.1.1 Overall Multi-Media Ecosystem Modeling Approach	573
	7.2.1.2 Overall Model Performance	573
	7.2.1.3 Suitability for Management	574
7.2.2	Specific Recommendations	574
	7.2.2.1 POM and Linkages	574
	7.2.2.2 LM2-Eutro and LM3-Eutro	574
	7.2.2.3 Level 1 Model	575
	7.2.2.4 LM2-Toxic	575
	7.2.2.5 LM Food Chain	575
	7.2.2.6 LM3-Toxic	575
7.2.3	Specific Comments	575
	7.2.3.1 Hydrodynamics and POM Linkage	575
	7.2.3.2 LM2-Eutro and LM3-Eutro	577
	7.2.3.3 Level 1 Model	577
	7.2.3.4 LM2-Toxic	578
	7.2.3.5 LM Food Chain	579

List of Figures

1.1.1	Simplified mass balance approach	2
1.1.2	The LMMBP sampling locations	8
1.1.3	Flow of information in the LMMBP	10
1.2.1	Surface water segmentation for alternative Lake Michigan mass balance model levels	20
1.2.2	Model construct used for the LMMBP to model PCBs	22
1.4.1	Location of the NOAA's buoys in Lake Michigan	56
1.4.2	Monthly mean water temperatures in southern Lake Michigan	58
1.4.3	Monthly mean water temperatures in northern Lake Michigan	58
1.4.4	Mean June water temperatures in southern Lake Michigan	58
1.4.5	Mean June water temperatures in northern Lake Michigan	58
1.4.6	Monthly mean air temperatures in southern Lake Michigan	60
1.4.7	Monthly mean air temperatures in northern Lake Michigan	60
1.4.8	Mean June air temperatures in southern Lake Michigan	60
1.4.9	Mean June air temperatures in northern Lake Michigan	60
1.4.10	Record of mean monthly water levels for Lake Michigan	60
1.4.11	Annual precipitation to Lake Michigan between 1949 and 1998	60
1.4.12	Comparison of 1982, 1983, 1994, and 1995 monthly mean precipitation to the means for the period of 1949 through 1998	61
1.4.13	Comparison of tributary flow for hydrodynamic model calibration (1982-1983) to the historic means	61

1.4.14	Comparison of tributary flow for the study period (1994-1995) to the historic means	62
1.5.1	Median concentration of vapor phase PCBs in the atmosphere during 1994 and 1995 for all seasons of both years	68
1.5.2	Time variation of vapor phase PCBs in Lake Michigan	70
1.5.3	Time variation of vapor phase PCBs in Lake Michigan at Sleeping Bear Dunes based on IADN data	70
1.5.4	Median concentration of wet (precipitation) PCBs in the atmosphere during 1994 and 1995 for all seasons of both years	72
1.5.5	Time variation of precipitation PCBs in Lake Michigan at Sleeping Bear Dunes based on IADN data	73
1.5.6	Median concentration of particulate PCBs in the atmosphere during 1994 and 1995 for all seasons of both years	74
1.5.7	Time variation of atmospheric particulate PCBs in Lake Michigan at Sleeping Bear Dunes based on IADN data	75
1.5.8	Distribution of total PCBs (ng/L) in 1994-1995 Lake Michigan water	76
1.5.9	Time variation of total PCBs in Lake Michigan water	77
1.5.10	Time variation of total PCBs in Lake Michigan water since 1986	78
1.5.11	Distribution of dissolved PCBs (ng/L) in 1994-1995 Lake Michigan water	79
1.5.12	Distribution of dissolved PCBs (ng/L) in 1994-1995 summer hypolimnetic Lake Michigan water	80
1.5.13	Time variation of dissolved PCBs in Lake Michigan water	81
1.5.14	Distribution of particulate PCBs (ng/L) in 1994-1995 Lake Michigan water	81
1.5.15	Time variation of particulate PCBs in Lake Michigan water	82
1.5.16	Relative loads of PCBs to Lake Michigan from tributaries	83
1.5.17	Total PCBs in 1994-1995 Lake Michigan surficial sediments (ng/g)	85
1.5.18	Vertical variation of PCBs in dated sediment cores collected for the LMMBP	85
1.5.19	Vertical variation of PCBs in dated sediment cores reported by Swackhamer and Armstrong (1988)	87
1.5.20	Vertical variation of PCBs in dated sediment cores reported by Hermanson <i>et al.</i> (1991)	87

1.5.21	Vertical variation of PCBs in dated sediment cores reported by Golden <i>et al.</i> (1993)	88
1.5.22	Vertical variation of PCBs in dated sediment cores reported by Schneider <i>et al.</i> (2001)	88
1.5.23	PCB concentrations in various members of the lake trout food web during the LMMBP	89
1.5.24	PCB concentrations in various age classes of lake trout during the LMMBP	90
1.5.25	Time variation of PCB concentration in five to six year-old lake trout from Lake Michigan	90
1.5.26	Time variation of PCB concentrations in bloater from Lake Michigan	91
1.6.1	LM2 surface water segmentation and LMMBP biota boxes	94
1.6.2	Cumulative frequency distribution – PCB congeners in segment 2 vapor phase	98
1.6.3	Cumulative frequency distribution – PCB congeners in segment 2 dry deposition.	98
1.6.4	Cumulative frequency distribution – PCB congeners in segment 2 wet deposition	98
1.6.5	Cumulative frequency distribution – dissolved PCB congeners in segment 2 water	98
1.6.6	Cumulative frequency distribution – particulate PCB congeners in segment 2 water.	98
1.6.7	Cumulative frequency distribution – PCB congeners in segment 2 surficial sediment	98
1.6.8	Cumulative frequency distribution – dissolved PCB congeners in Kalamazoo River water	99
1.6.9	Cumulative frequency distribution – particulate PCB congeners in Kalamazoo River water . . .	99
1.6.10	Cumulative frequency distribution – age 5-6 Saugatuck lake trout	99
1.6.11	Cumulative frequency distribution – PCB congeners in segment 2 vapor phase	99
1.6.12	Cumulative frequency distribution – PCB congeners in segment 2 dry deposition.	99
1.6.13	Cumulative frequency distribution – dissolved PCB congeners in Kalamazoo River water	99
1.6.14	Cumulative frequency distribution – particulate PCB congeners in Kalamazoo River water . . .	100
1.6.15	Cumulative frequency distribution – PCB congeners in segment 2 wet deposition	100
1.6.16	Cumulative frequency distribution – dissolved PCB congeners in Saugatuck water	100
1.6.17	Cumulative frequency distribution – particulate PCB congeners in Saugatuck water	100
1.6.18	Cumulative frequency distribution – PCB congeners in surficial sediment.	100

1.6.19	Cumulative frequency distribution – PCB congeners in age 5-6 Saugatuck lake trout	100
1.6.20	PCB congeners in segment 2, Saugatuck	101
1.6.21	Air sampling locations	102
1.6.22	Lake Michigan high-resolution 5 km x 5 km grid with 19 sigma layers	102
1.6.23	Cumulative frequency distribution (mean) – PCB congeners in atmospheric vapor phase	103
1.6.24	Cumulative frequency distribution (mean) – PCB congeners in atmospheric wet deposition	103
1.6.25	Cumulative frequency distribution (mean) – PCB congeners in atmospheric dry deposition	103
1.6.26	Cumulative frequency distribution (mean) – PCB congeners in segment 2 atmospheric data	103
1.6.27	PCB congeners in Lake Michigan tributaries	104
1.6.28	Comparison of dissolved PCB congeners in Lake Michigan western tributaries to segment 2 vapor phase	105
1.6.29	Comparison of dissolved PCB congeners in Lake Michigan eastern tributaries to segment 2 water	106
1.6.30	Comparison of particulate PCB congeners in Lake Michigan segment 2 to tributaries	106
1.6.31	Cumulative frequency distribution (mean) – PCB congeners in ages 5 and 6 lake trout	107
1.6.32	Cumulative frequency distribution (mean) – PCB congeners in Saugatuck lake trout	107
1.6.33	Comparison of dissolved PCB congeners in west side-to-east side of Lake Michigan tributaries	108
1.6.34	Comparison of particulate PCB congeners in west side-to-east side of Lake Michigan tributaries	108
1.7.1	Locations of dated cores analyzed for PCBs by Hermanson <i>et al.</i> (1981), Swackhamer and Armstrong (1988), Schneider <i>et al.</i> (2001), Golden <i>et al.</i> (1993), and P. Van Hoof (personal communication) for the LMMBP	113
1.7.2	Fit of concentration functions to observed data for core 15	114
1.7.3	Lake Michigan non-depositional (0-40 m), transitional (40-100 m), and depositional (> 100 m) zones based on water depth and the depth of wind-wave interaction with sediments	116

1.7.4	Comparison of load function to ²¹⁰ Pb focusing factor corrected core 15 loads	117
2.4.1	The LMMBP sampling locations	143
2.4.2	Lake-wide phytoplankton carbon calculated from biovolume data and carbon-to-chlorophyll <i>a</i> ratios for the eight LMMBP cruises	148
2.4.3	Level 2 model segmentation for LM3-Eutro.	151
2.4.4	Lake-wide Secchi depths for the eight LMMBP cruises	153
2.5.1	Level 2 and Level 3 model segmentation	159
2.5.2	LM3-Eutro model versus laboratory primary production	161
2.5.3	Level 3 LM3-Eutro model predictions versus field data, lake-wide.	164
2.5.4	Level 2 LM3-Eutro model output versus field data for selected segments.	165
2.5.5	Level 3 LM3-Eutro model output versus field data for selected nearshore and offshore cells.	166
2.6.1	MICH1 versus LM3-Eutro model predictions and available field data	170
2.7.1	Scenario 1: Constant Conditions	172
2.7.2	Scenario 2: Virtual elimination	172
2.7.3	Historical total phosphorus loading – Lake Michigan	173
2.7.4	Scenario 3: Best estimate of current trends resulting from previous actions	174
2.7.5	Scenario 4: Scenario 1 with tributary load elimination	175
2.7.6	Scenario 5: Scenario 1 with atmospheric load elimination	175
2.7.7	Scenario 6: Scenario 1 with tributary and atmospheric loads increased 20%	176
2.7.8	Scenario 7: Application of the GLWQA loads to model.	178
2.7.9	Scenario 8: Estimate of the TMDL to reach the IJC's target total phosphorus concentration	178
2.7.10	Annual average (1994-1995) Lake Michigan total phosphorus loading (kg/year)	180
2.7.11	Annual average (1994-1995) Lake Michigan and Green Bay total phosphorus loading (kg/year)	181
3.3.1	MICHTOX PCB mass balance schematic	187

3.3.2	MICHTOX model segmentation	188
3.3.3	Long-term estimates of Lake Michigan total PCB vapor concentrations	192
3.3.4	Long-term estimates of Lake Michigan total PCB atmospheric deposition loadings	192
3.3.5	Long-term estimates of Lake Michigan total PCB tributary loadings	192
3.3.6	Long-term Scenario A predictions of main lake total PCB concentrations	192
3.3.7	Comparison of long-term Scenario A predictions to main lake sediment total PCB concentrations (sediment cores collected in 1991-1992).	193
3.3.8	Comparison of long-term Scenario A predictions to GLNPO lake trout data.	193
3.3.9	Comparison of MICHTOX Scenario A total PCB concentrations to Sheboygan Reef data	193
3.3.10	Long-term Scenario B predictions of main lake total PCB concentrations.	193
3.3.11	Comparison of long-term Scenario B predictions to the LMMBP deep water dissolved total PCB concentrations	194
3.3.12	Comparison of Scenario B predictions to main lake sediment total PCB concentrations (sediment cores collected in 1991-1992).	194
3.3.13	Comparison of long-term Scenario B predictions to average total PCB sediment concentrations (LMMBP and GBMBP box core samples).	194
3.3.14	Comparison of long-term Scenario B predictions to GLNPO lake trout data.	194
3.3.15	Comparison of long-term Scenario B total PCB concentrations to Sheboygan Reef fish data	195
3.3.16	Long-term Scenario C predictions of main lake total PCB concentrations	195
3.3.17	Comparison of Scenario C predictions to main lake sediment total PCB concentrations (sediment cores collected in 1991-1992).	196
3.3.18	Comparison of long-term Scenario C predictions to GLNPO lake trout data.	196
3.3.19	Comparison of MICHTOX Scenario C total PCB concentrations to Sheboygan Reef fish data	196
3.3.20	Comparison of MICHTOX epilimnetic total PCB concentrations to the LMMBP cruise data	197
3.3.21	Comparison of MICHTOX hypolimnetic total PCB concentrations to the LMMBP cruise data	198

3.3.22	MICHTOX predicted mass balance fluxes and inventories (kg/year) for 1994-1995, whole lake results	199
3.3.23	MICHTOX predicted mass balance fluxes and inventories (kg/year) for 1994-1995, Green Bay and main lake results	199
3.4.1	The LMMBP biota sampling zones	202
3.4.2	Total PCB concentrations of organisms in Lake Michigan biota zones	206
3.4.3	Total PCB concentrations in 5.5 year-old lake trout at Saugatuck biota zone	207
3.4.4a	Sensitivity scenario predicted total PCB concentrations in 5.5 year-old lake trout from Saugatuck biota zone	208
3.4.4b	Sensitivity scenario total PCB predictions and the fish consumption target level	208
3.4.5a	Model application scenario total PCB predictions in 5.5 year-old lake trout from the Saugatuck biota zone	208
3.4.5b	Application scenario total PCB predictions and the fish consumption target level	208
3.4.6	Sensitivity scenario total PCB concentration predictions for 5.5 year-old lake trout at Saugatuck	209
A3.4.1	Whole fish to edible portion of fish PCBs and lipid ratios for lake trout	214
A3.4.2	Comparison of whole fish to fillet PCB ratios and lipid content for various fish species	214
4.1.1	Mass budget average for 1994-1995 total PCBs Lake Michigan system (including Green Bay)	218
4.1.2	Annual long-term responses of total PCB concentrations in the water column of Lake Michigan for the forecast and sensitivity scenarios	219
4.3.1	Water column segmentation for the LM2-Toxic model	225
4.3.2	Surface sediment segmentation for the LM2-Toxic model	226
4.3.3	Cross-sectional sediment segmentation and overlying water column segments for 10 Lake Michigan and four Green Bay water columns	227
4.3.4	Conceptual framework of organic carbon sorbent dynamics used in the LM2-Toxic model	232
4.3.5	Schematic of conceptualization for the steady-state mass balance analysis for PDC vertical transport	234
4.3.6	Locations of the 30 deployments between 1994 and 2000	236

4.3.7	Regression analysis on the data set (resuspension observed only)	237
4.3.8	Conceptual framework used by the LM2-Toxic model for PCB congeners in Lake Michigan	238
4.4.1	Locations of 10 tributaries whose flows were considered a part of the water transport used in the LM2-Toxic	249
4.4.2	Locations of monitored and unmonitored tributaries during the LMMBP	253
4.4.3	Lake Michigan water sampling sites during the LMMBP	254
4.4.4	Primary production generated from the LM3-Eutro for Lake Michigan, including Green Bay	257
4.4.5	Lake Michigan sediment sampling sites of organic carbon during the LMMBP	265
4.4.6	Distribution of POC in Lake Michigan surficial sediments (mg/g _{dw})	265
4.4.7	Distribution of POC in Lake Michigan surficial sediments (mg/L)	266
4.4.8	Σ PCBs tributary (11 monitored and 18 unmonitored tributaries) loads to Lake Michigan during the LMMBP period	272
4.4.9	Estimated Σ PCBs atmospheric loads including dry and wet deposition into Lake Michigan during the LMMBP period	273
4.4.10	Lake Michigan atmospheric sampling sites during the LMMBP	275
4.4.11	Seasonal variation of Σ PCB vapor phase concentrations observed during the LMMBP	276
4.4.12	Lake Michigan sediment sampling sites for PCBs during the LMMBP	277
4.4.13	Distribution of Σ PCBs in Lake Michigan surficial sediments (ng/g _{dw})	278
4.4.14	Distribution of Σ PCBs in Lake Michigan surficial sediments (ng/L)	278
4.4.15	Comparison between the estimated $\log K'_{\text{POC},\alpha}$ for the LMMBP selected PCB congeners based on the two-phase partitioning model and K_{ow} calculated by Hawker and Connell (1988) for all 209 PCB congeners	281
4.5.1a	Comparison between the temporal profiles for temperature from the LM2-Toxic	292
4.5.1b	Comparison between the temporal profiles for temperature results from the Princeton Ocean Hydrodynamic model	292
4.5.2	Temporal profiles of DOC in the Lake Michigan water column segments for the organic carbon dynamics calibration of the LM2-Toxic and the LMMBP cruise mean data	295

4.5.3	Temporal profiles of BIC in the Lake Michigan water column segments for the organic carbon dynamics calibration of the LM2-Toxic and the LMMBP cruise mean data	298
4.5.4.	Temporal profiles of PDC in the Lake Michigan water column segments for the organic carbon dynamics calibration of the LM2-Toxic and the LMMBP cruise mean data	301
4.5.5	Observed data versus the LM2-Toxic predictions for DOC, BIC, and PDC for the LMMBP period	304
4.5.6	Temporal profiles of PCB ₂₈₊₃₁ (dissolved phase + particulate phase) in Lake Michigan water column segments for PCB dynamics calibration of the LM2-Toxic and the LMMBP cruise mean data	306
4.5.7	Temporal profiles of ΣPCBs (dissolved phase + particulate phase) in Lake Michigan water segments for PCB dynamics calibration of the LM2-Toxic and the LMMBP cruise mean data	309
4.5.8	Observed data versus the LM2-Toxic predictions for PCB ₂₈₊₃₁ and ΣPCBs for the LMMBP period	312
4.5.9	Lake-wide average concentrations of (a) ¹³⁷ Cs and (b) ^{239,240} Pu computed by the LM2 radionuclide model over 46 years (1950-1995)	318
4.5.10	Sediment ¹³⁷ Cs inventory comparison between the observed data and the LM2 radionuclide model outputs	318
4.5.11	Reconstructed historical total PCB loading time functions and sediment core LM94-15A total PCB concentration profiles for Lake Michigan	323
4.5.12	Reconstructed total PCB vapor phase concentrations and total PCB loading time functions for Lake Michigan	323
4.5.13	Reconstructed total organic carbon load (primary production + LMMBP tributary loads) for Lake Michigan	325
4.5.14	The sampling sites of the sediment box core samples (LM94-15A, LM95-61A, LM95-87A) taken during the LMMBP for which vertical PCB concentration profiles were analyzed and available	327
4.5.15	Annual lake-wide average total PCB water column concentrations from the LM2-Toxic PCB hindcast simulation	329
4.5.16	Monthly lake-wide average total PCB water column concentrations from the LM2-Toxic PCB hindcast simulation	329
4.5.17	Annual average total PCB concentration profiles in the sediment depositional zone from the LM2-Toxic PCB hindcast simulation	330
4.5.18	ΣPCB mass budget of Lake Michigan during the period of the LM2-Toxic PCB hindcast (1949-1995)	332

4.5.5.1	Model data versus measured total phosphorus loads	427
4.5.5.2	Model output versus measured total phosphorus concentration data	428
4.5.5.3	Relationship between lake-wide total phosphorus concentration and primary productivity based on model output from the LM3-Eutro model	428
4.6.1	Mass budget average for 1994-1995 total PCBs in the Lake Michigan system (including Green Bay)	432
4.6.2	1994-1995 total PCB Lake Michigan and Green Bay mass budget (averaged)	433
4.6.3a	Annual long-term responses to total PCB concentrations in the water column of Lake Michigan for the forecast scenarios and USEPA water quality criteria for the protection of wildlife (U.S. Environmental Protection Agency, 2005) and human health (U.S. Environmental Protection Agency, 1997) in the Great Lakes system	438
4.6.3b	Annual long-term responses to total PCB concentrations in the water column of Lake Michigan for the sensitivity scenarios	438
4.6.4a	Monthly long-term responses to total PCB concentrations in the water column of Lake Michigan for the forecast scenarios and USEPA water quality criteria for the protection of wildlife (U.S. Environmental Protection Agency, 2005) and human health (U.S. Environmental Protection Agency, 1997) in the Great Lakes system	439
4.6.4b	Monthly long-term responses to total PCB concentrations in the water column of Lake Michigan for the sensitivity scenarios	439
4.6.5a	Annual long-term responses to total PCB concentrations in the surficial sediment of Lake Michigan for the forecast scenarios	441
4.6.5b	Annual long-term responses to total PCB concentrations in the surficial sediment of Lake Michigan for the sensitivity scenarios	441
4.7.1	Short-term (1994-1995) variations of lake-wide (Green Bay included) organic carbon concentrations for \pm 50% primary production changes without adjusting settling and resuspension rates	445
4.7.2	Long-term (1994-2055) variations of lake-wide (Green Bay included) organic carbon concentrations for \pm 50% primary production changes without adjusting settling and resuspension rates	446
4.7.3	Short-term (1994-1995) variations of lake-wide (Green Bay included) PCB ₂₈₊₃₁ (dissolved + particulate) concentrations for \pm 50% primary production changes without adjusting settling and resuspension rates	448
4.7.4	Long-term (1994-2055) variations of lake-wide (Green Bay included) PCB ₂₈₊₃₁ (dissolved + particulate) concentrations for \pm 50% primary production changes without adjusting settling and resuspension rates	449

4.7.5	Sensitivity analysis of the LM2-Toxic predictions to varying PCB loads	451
5.3.1	Primary chemical exchange processes between a fish and its environment	458
5.3.2	Comparison of modeling approaches for exposure temperatures in food web models	463
5.4.1	Biota zones in Lake Michigan	467
5.4.2a	Typical annual cycles of exposure temperature for Lake Michigan food webs at Saugatuck and Sturgeon Bay	485
5.4.2b	Typical annual cycles of exposure temperature for Lake Michigan food web at Sheboygan Reef	485
5.4.2c	Typical annual cycles of exposure temperature for coho salmon in Lake Michigan	486
5.5.1	Agreement between modeled and observed fish PCB concentrations in coho salmon using Saugatuck food web (1994 and 1995)	497
5.5.2	Individual comparison between modeled and observed data for PCB congeners in lake trout at Saugatuck (1994 and 1995)	499
5.5.3	Comparison between modeled and observed total PCBs for lake trout at Saugatuck (1994 and 1995)	500
5.7.1	Sensitivity of PCBs in lake trout (age four) to chemical assimilation efficiency presented as ratios of model outputs with modified chemical assimilation efficiency to model outputs with the calibrated chemical assimilation efficiency	530
5.7.2	Effect of changes in food assimilation efficiency on the computed PCB data for lake trout in Lake Michigan presented as ratios of model outputs with modified food assimilation efficiency to model outputs with the calibrated food assimilation efficiency	530
5.7.3	Effect of changes in chemical relative gill transfer coefficient (E_c/E_o) on the computed PCB data for lake trout in Lake Michigan presented as ratios of model outputs with modified chemical relative gill transfer coefficient to model outputs with the calibrated chemical relative gill transfer coefficient	531
5.7.4	Effect of changes in SDA on the computed PCB data for lake trout in Lake Michigan presented as ratios of model outputs with modified SDA parameter to model outputs with the calibrated SDA value	532
5.7.5	Sensitivity of PCBs in lake trout (age four) to fish growth rate presented as the ratios of model outputs with zero lake trout growth rate to model outputs with field estimated growth rate	533
5.7.6	Sensitivity of PCBs in lake trout (age four) to octanol-water partition coefficient ($\log K_{ow}$) presented as ratios of model outputs with $\log K_{ow}$ input reduced by 5% to model outputs with original $\log K_{ow}$ values	534

5.7.7	Sensitivity of PCBs in lake trout (age four) to fish diet presented as ratios of model outputs with modified fish diet to model outputs with field estimated fish diet	534
5.8.1a	PCB congener-specific exposure concentrations at Sturgeon Bay predicted by LM2-Toxic for Scenario A – PCBs in suspended particles of the water column	538
5.8.1b	PCB congener-specific exposure concentrations at Sturgeon Bay predicted by LM2-Toxic for Scenario A – PCBs in the surface sediment	539
5.8.2	Total PCB concentrations of the lake trout in response to the exposure concentration inputs associated with various loading scenarios	540
5.8.3	Total PCB concentrations of the lake trout in response to the exposure concentration inputs associated with various loading scenarios	541
6.1	Supporting models and links for MICHTOX and the LM models	545
6.2	Comparison of the Lake Michigan total PCB mass balance analyses results, 1994-1995	547
6.3	Comparison of model output annual average total PCB water concentrations for the Constant Conditions Scenario	548
6.4	Comparison of model output annual average total PCB sediment concentrations for the Constant Conditions Scenario	549
6.5	Comparison of model output annual average total PCB water concentrations for the Continued Recovery – Fast Scenario	549
6.6	Comparison of the bioaccumulation model annual average total PCB concentration results for the Constant Conditions Scenario	550
6.7	Comparison of the bioaccumulation model annual average total PCB concentration results for the Continued Recovery – Fast Scenario	551

List of Tables

1.1.1	Characteristics of the LMMBP Modeled Pollutants	4
1.1.2	The LMMBP Parameters	7
1.3.1	Revised Regression Equations for the LMMBP Total PCBs in All Media	29
1.3.2	Ratio of Measured Field Data/Model Results for Congeners 84+92 and 99 in Water.	30
1.4.1	Summary of Lake Michigan Ice Cover Based Upon Assel (2003)	57
1.4.2	Description Wave Statistics for POM Calibration Years (1982-1983) and Study Years (1994-1995) Compared to the Period of Record for NOAA's Buoys in Northern and Southern Lake Michigan	64
1.5.1	Significant Dates in the History of PCBs in the Lake Michigan Basin	67
1.5.2	Monthly Composite Concentrations of Vapor Phase Total PCBs Measured in Samples Collected Around Lake Michigan From April 1994 to October 1995	69
1.5.3	Monthly Composite Concentrations of Total PCBs Measured in Precipitation Samples Collected Around Lake Michigan From April 1994 to October 1995	73
1.5.4	Monthly Composite Concentrations of Particulate Phase Total PCBs Measured in Samples Collected Around Lake Michigan From April 1994 to October 1995	75
1.5.5	Monthly Composite Concentrations of PCBs Measured in Dry Deposition	76
1.5.6	Concentrations of PCBs in 1994-1995 Lake Michigan Water (ng/L)	77
1.5.7	Concentrations of PCBs Measured in Tributaries	82
1.5.8	Comparison of PCB Concentrations in Samples Collected From Tributaries in 1994-1995 With Those in Samples Collected From Tributaries in 1980-1983	84
1.5.9	Concentrations of Total PCBs in Lake Michigan Surficial Sediment (ng/g)	84
1.5.10	Physical Parameters Associated With LMMBP Cores	86

1.5.11	Mean Concentrations of PCBs Measured in the 1994-1995 Lake Michigan Food Web	89
1.6.1	Comparison of Congeners Available for Analysis in All LMMBP Media	95
1.7.1	Significant Dates in the History of PCBs in the Lake Michigan Basin	111
1.7.2	Sedimentary Zones of Lake Michigan	115
2.3.1	Nutrient State Variables	126
2.4.1	1994-1995 Monthly Atmospheric Total Phosphorus Loads	140
2.4.2	Tributary Total Phosphorus Loads (kg/year)	141
2.4.3	Sediment Masses, Fluxes, and Loads	142
2.4.4	The LMMBP Sampling Cruises	142
2.4.5	The LMMBP Open Lake Nutrient Data Summary Statistics	144
2.4.6	Relationship of Field Measurements and Model State Variables	152
2.4.7	Important LM3 Model Coefficients	153
2.5.1	Coefficients Used in the LM3 Model (Units Correspond to Required LM3 Model Output)	162
2.5.2	Summary of Statistical Results of the Calibration	165
2.7.1	Final Eutrophication Scenario Results	179
3.3.1	MICHTOX Segment Geometry	188
3.3.2	Model Parameters and Coefficients	189
3.3.3	Cruise and Segment-Specific Average Dissolved Total PCB Concentrations (ng/L)	190
3.3.4	Cruise and Segment-Specific Average Particulate Total PCB Concentrations (ng/L)	190
3.3.5	Segment-Specific Average Surficial Sediment Total PCB Concentrations (ng/g)	190
3.4.1	Average Total PCB Concentrations in Fish in the Saugatuck Biota Zone	203
3.4.2	Average Total PCB Concentrations in Fish in the Sheboygan Reef Biota Zone	204
3.4.3	Average Total PCB Concentrations in Fish in the Sturgeon Bay Biota Zone	204
3.4.4	MICHTOX Food Chain Age- and Species-Specific Weight, Growth Rate, and Lipid Concentrations	205

3.4.5	MICHTOX Food Chain Model Parameters and Coefficients	206
A3.4.1	Comparison of the LMMBP Lake Trout to MDEQ Lake Superior Lake Trout	213
4.3.1	Geometry Data for Water Column Segments and Lake Michigan (Total)	229
4.3.2	Initial Geometry Data for Surficial Sediment Segments and Surficial Sediment Layer (Total)	230
4.3.3	Processes Considered in Organic Carbon Sorbent Dynamics Constructed for the LM2-Toxic	233
4.4.1	Average Annual Flows of the 10 Monitored Tributaries	249
4.4.2	Monthly Average Flows Across the Straits of Mackinac	251
4.4.3	Initial Temperatures in Water Column Segments for the Thermal Balance Model	251
4.4.4	Cruise-Segment Mean Temperatures for the LMMBP Period	252
4.4.5	The LMMBP Sampling Cruises	255
4.4.6	Initial Chloride Concentrations in Water Column Segments for the Chloride Model	255
4.4.7	Cruise-Segment Mean Chloride Concentrations for the LMMBP Period	256
4.4.8	Annual Average Organic Carbon Loads From 11 Monitored Tributaries to Lake Michigan During the LMMBP	259
4.4.9	Annual Average Organic Carbon Loads From 18 Unmonitored Tributaries to Lake Michigan During the LMMBP	259
4.4.10	Annual Average Organic Carbon Internal Loads Generated From the LM3-Eutro for Lake Michigan During the LMMBP	260
4.4.11	Initial Concentrations of Organic Carbon Sorbents in Water Column Segments for the LM2-Toxic	261
4.4.12	Cruise-Segment Mean Concentrations of DOC (mg/L) for the LMMBP Period	262
4.4.13	Cruise-Segment Mean Concentrations of BIC (mg/L) for the LMMBP Period	263
4.4.14	Cruise-Segment Mean Concentrations of PDC (mg/L) for the LMMBP Period	264
4.4.15	Concentration of Organic Carbon Sorbents in Surficial Sediments for the LM2-Toxic	267
4.4.16	Organic Carbon Sorbent Biotransformation Parameters Specified for the LM2-Toxic	268
4.4.17	Segment-Specific Settling Rates (m/d) for Organic Carbon Sorbents (BIC and PDC) Specified for the LM2-Toxic	269

4.4.18	Segment-Specific Effective PDC Concentrations (C_w) Used in the Steady-State Resuspension Calculation Based on the LMMBP Data	270
4.4.19	Segment-Specific Sediment Accumulation Rates (v_b) and Thickness of Mixing Layer (z) Used in the Steady-State Resuspension Calculation	270
4.4.20	Segment-Specific Critical Wave Heights (W_{cr}) and Empirical Wave Coefficients (α) Used in the Wave-Induced Resuspension Calculation Based on the LMMBP Data	271
4.4.21	List of PCB State Variables Modeled in the LM2-Toxic	272
4.4.22	Annual Average Σ PCB Loads From 11 Monitored and 18 Unmonitored Tributaries to Lake Michigan During the LMMBP.	274
4.4.23	Annual Average Σ PCB Atmospheric Dry and Wet Loads in the 10 Surface Water Column Segments of Lake Michigan During the LMMBP.	274
4.4.24	Annual Average Boundary Conditions of Σ PCB Vapor Phase Concentrations for Lake Michigan During the LMMBP.	276
4.4.25	Initial Concentrations of Σ PCBs in Water Column Segments for Lake Michigan	278
4.4.26	Cruise-Segment Mean Concentration of Σ PCBs (ng/L) for the LMMBP Period	279
4.4.27	Initial Concentrations of Σ PCBs in Sediment Segments for Lake Michigan	280
4.4.28	Final Partition Coefficients for the LMMBP Selected PCBs Used in the LM2-Toxic	282
4.4.29	Values of Parameters Used for Air-Water Exchange in the LM2-Toxic for the LMMBP Selected PCB Congeners	283
4.5.1	Results of the Regression Between the LM2-Toxic Calibration Results and the Cruise Mean Data for the LMMBP Selected PCB Congeners	314
4.5.2	Results of the LM2-Toxic Mass Balance Checking for a 62-Year Simulation of an Assumed Conservative Tracer	315
4.5.3	Comparison Between the LMMBP Field-Generated and the LM2-Toxic-Generated Sediment Accumulation Rates (cm/year)	320
4.5.4	Available Historical Water Column Total PCB Concentrations for Lake Michigan	325
4.5.5	Sediment PCB Concentration Vertical Profiles Analyzed for Three Sediment Box Cores Taken During the LMMBP	326
4.5.6	Available Inventories of PCBs in Lake Michigan Sediments	327
4.5.7	Calculations in PCB Mass Budget Checking for the LM2-Toxic PCB Hindcast	332

4.6.1	Regression Equations Used for Converting Σ PCBs to Total PCBs for the LM2-Toxic Results	431
4.6.2	Results of Total PCB Mass Budget Analysis for Lake Michigan and Green Bay	434
4.6.3	Mean and Medium Particulate PCBs/Organic Carbon and Field Data and Scaling Factor for Hypolimnetic Level 2, Segments 21, 30, and 37, and for Saugatuck Biota Box Hypolimnion	442
4.7.1	Annual Average Concentrations of Water Column Carbon Solids and Annual Average Change in Percentage for Water Column Carbon Solids Concentrations Resulting From the LM2-Toxic Model Runs for Both the Short-Term (1994-1995) and the Long-Term (1994-2055) Simulations with 50% Increase and 50% Decrease of the LM3-Eutro Produced Primary Production	447
4.7.2	PCB ₂₈₊₃₁ Mass Fluxes and Inventories for Lake Michigan System Results From the LM2-Toxic Sensitivity Analysis on Primary Production for the Short-Term (Two-Year Period: 1994-1995) Simulations	448
4.7.3	PCB ₂₈₊₃₁ Mass Fluxes and Inventories for Lake Michigan System Results From the LM2-Toxic Sensitivity Analysis on Primary Production for the Last Two Years of the Long-Term (62-Year Period: 1994-2055) Simulations	449
4.7.4	PCB ₂₈₊₃₁ Average Inventories of Water Column and Surficial Sediment Results From the LM2-Toxic Simulations for the Primary Production Sensitivity Analysis, and Changes in Percentage for These Inventories Compared to the Inventories From the Original Base Runs	451
5.4.1	Targeted PCB Congeners and Their K_{ow}	466
5.4.2a	Annual Dietary Composition of Lake Trout at Saugatuck (1994-1995)	469
5.4.2b	Annual Dietary Composition of Lake Trout at Sheboygan Reef (1994-1995)	470
5.4.2c	Annual Dietary Composition of Lake Trout at Sturgeon Bay (1994-1995)	472
5.4.3	Dietary Composition of Alewife in Lake Michigan (1994-1995)	473
5.4.4.	Dietary Composition of Bloater in Lake Michigan (1994-1995)	474
5.4.5	Dietary Composition of Rainbow Smelt in Lake Michigan (1994-1995)	474
5.4.6	Dietary Composition of Slimy Sculpin in Lake Michigan (1994-1995)	474
5.4.7	Dietary Composition of Deepwater Sculpin in Lake Michigan (1994-1995)	475
5.4.8	Dietary Composition of Coho Salmon in Lake Michigan (1994-1995)	475
5.4.9a	Average Weight-Age Relationships for Lake Trout in Lake Michigan (1994-1995)	477

5.4.9b	Average Weight-Age Relationships for Coho Salmon in Lake Michigan (1994-1995)	477
5.4.9c	Average Weight-Age Relationships of Forage Fish in Lake Michigan (1994-1995)	478
5.4.9d	Estimated Weight-Age Relationships of <i>Mysis</i> in Lake Michigan	478
5.4.10a	Average Lipid and Protein Fractions (%) of Lake Trout in Lake Michigan (1994-1995)	478
5.4.10b	Average Lipid and Protein Fractions (%) of Coho Salmon in Lake Michigan (1994-1995)	479
5.4.10c	Average Lipid and Protein Fractions (%) of Alewife in Lake Michigan (1994-1995)	479
5.4.10d	Average Lipid and Protein Fractions (%) of Bloater in Lake Michigan (1994-1995)	480
5.4.10e	Average Lipid and Protein Fractions (%) of Rainbow Smelt in Lake Michigan (1994-1995)	480
5.4.10f	Average Lipid and Protein Fractions (%) of Slimy Sculpin in Lake Michigan (1994-1995)	480
5.4.10g	Average Lipid and Protein Fractions (%) of Deepwater Sculpin in Lake Michigan (1994-1995)	481
5.4.10h	Average Lipid and Protein Fractions (%) of Zooplankton, <i>Mysis</i> , and <i>Diporeia</i> in Lake Michigan (1994-1995)	481
5.4.11	PCB Concentrations in Lake Michigan Water Column (1994-1995)	482
5.4.12	PCB Concentrations in Lake Michigan Surface Sediment (1994-1995)	484
5.4.13	Bioenergetic Parameters of Lake Michigan Fishes	487
5.5.1	Calibrated Parameter Values for <i>Diporeia</i> Submodel	494
5.5.2	Calibrated Model Parameters for PCBs in the Sturgeon Bay and Saugatuck Lake Trout Food Webs	494
5.5.3	Calibrated Model Parameters for PCBs in the Sheboygan Reef Lake Trout Food Web	494
5.5.4	Calibrated Model Parameters for PCBs in Lake Michigan Coho Salmon	495
7.1.1	Agenda – Lake Michigan Mass Balance PCB Modeling Peer Review	554
7.1.2	Significant Dates in the History of PCBs in the Lake Michigan Basin	562

Abbreviations

AOCs	Areas of Concern
AREAL	Atmospheric Research and Exposure Assessment Laboratory
BIC	Biotic carbon
BMC	Bayesian Monte Carlo
BNL	Benthic nepheloid layer
CCC	Criterion continuous concentration
CMC	Criterion maximum concentration
CPE	Catch per unit of effort
CTF	Contaminant transport and fate model
DDE	Dichlorodiphenyldichloroethylene
DEA	Deethylatrazine
DIA	Deisopropylatrazine
DIN	Dissolved inorganic nitrogen
DOC	Dissolved organic carbon
DON	Dissolved organic nitrogen
DOP	Dissolved organic phosphorus
DQO	Data quality objectives
DSi	Dissolved silica
EEGLE	Episodic Events-Great Lakes Experiments
EMP	Enhanced Monitoring Program
GLERL	Great Lakes Environmental Research Laboratory
GLNPO	Great Lakes National Program Office
GLWQA	Great Lakes Water Quality Agreement
GBMBP	Green Bay Mass Balance Project
HOC	Hydrophobic organic chemicals
IADN	Integrated Atmospheric Deposition Network
IDL	Instrument detection limit
IDW	Inverse distance weighted
LaMP	Lake-wide Management Plan
LLRFRB	Lake Lakes and Rivers Forecasting Research Branch
LLRS	Large Lakes Research Station
LMMBP	Lake Michigan Mass Balance Project
LOC	Labile organic carbon
LON	Labile organic nitrogen
LOP	Labile organic phosphorus
MCL	Maximum contaminant level
MDEQ	Michigan Department of Environmental Quality

MDL	Method detection limit
MED	Mid-Continent Ecology Division
MQO	Measurement quality objectives
NHEERL	National Health and Environmental Effects Research Laboratory
NOAA	National Oceanic and Atmospheric Administration
ORD	Office of Research and Development
PCBs	Polychlorinated biphenyls
PDC	Particulate detrital carbon
PI	Principal Investigator
POC	Particulate organic carbon
POM	Princeton Ocean Model
POP	Persistent organic pollutants
QA	Quality assurance
QAPP	Quality Assurance Project Plan
QC	Quality control
RAPs	Remedial Action Plans
RDMQ	Research Data Management and Quality Control System
RFS	Routine field sample
ROC	Refractory organic carbon
RON	Refractory organic nitrogen
ROP	Refractory organic phosphorus
SA	Available silica
SDA	Specific dynamic action
SDL	System detection limit
SRP	Soluble reactive phosphorus
SU	Biogenic silica
TKN	Total Kjeldahl nitrogen
TMDL	Total maximum daily load
USDOI	United States Department of Interior
USEPA	United States Environmental Protection Agency
USFWS	United States Fish and Wildlife Service
USGS	United States Geological Survey
VWA	Volume-weighted average

Acknowledgments

Special thanks to the United States Environmental Protection Agency, Great Lakes National Program Office for leadership, support, and collaboration on the Lake Michigan Mass Balance Project. The multiple efforts by the Principal Investigators for providing data, necessary for the modeling, are greatly appreciated. Thank you to David H. Miller, Kenneth R. Rygwelski, Timothy J. Feist, Xiaomi Zhang, and James P. Pauer for providing internal technical reviews of various parts of this document. Thanks to Kay Morrison for the graphic renditions and figures and to Debra L. Caudill for formatting and word processing. Finally, thanks to Robert B. Ambrose, Jr., Joel E. Baker, Ken G. Drouillard, Barry Lesht, and James L. Martin for serving on the peer review panel.

Executive Summary

The Lake Michigan Mass Balance Project (LMMBP) provided an opportunity to improve the quality of polychlorinated biphenyl (PCB) mass balance models used to represent large, freshwater ecosystems. A rigorously quality-assured large supporting data set derived from samples collected during eight cruises in 1994-1995 was used to establish atmospheric and tributary loads, estimate initial conditions, perform model calibration and confirmation and, to a lesser extent, to assist in estimating a number of kinetic coefficients. A significant aspect of this modeling effort was modeling PCBs at a congener-level basis.

Lake Michigan is acted upon by a number of physical parameters that impact the hydrology, chemistry, and biology of the lake. For a lake the size of Lake Michigan, changes in these parameters can lead to significant changes, especially when models are used in long-term predictions to predict the outcome of various scenarios. The primary driving forces are wind, air temperature, and precipitation. These impact tributary flows, lake levels, waves, water circulation, water temperature, and ice cover. For the period of record, these driving forces vary from year-to-year. The period of 1982 to 1983 was used to calibrate the hydrodynamic models. For this period of time, hydrodynamic conditions were not at any extreme. This is also true for the period of 1994 and 1995 when the models were applied.

Major physical forcing functions were not extreme during the sampling period of 1994-1995 or the hydrodynamic model calibration period of 1982-1983. Precipitation was within the normal range for all years of modeling interest, resulting in lake levels and tributary flows that were within normal bounds.

Temperature will impact the eutrophication and contaminant modeling. Air temperature impacts how quickly the lake warms in any one year. Water temperature is critical to the timing of algae blooms, especially the spring diatom bloom. It also impacts the volatilization of contaminants. There appears to be a four-year cycle of quicker warming which exists within a trend of general warming of the lake. The trend of warming may be part of a longer term, undocumented cycle, or may be related to climate change.

Models developed at the United States Environmental Protection Agency's Large Lakes Research Station, including LM3-Eutro, MICHTOX, LM2-Toxic, and LM Food Chain, utilized results from a hydrodynamic model to describe the lake's physics and results from air and tributary models to provide loadings to the lake.

LM3-Eutro uses state-of-the-science eutrophication kinetics to simulate the interactions between plankton and nutrients. LM3-Eutro is a high-resolution (44,042 cells and 19 sigma layers) carbon based model that provides a highly resolved description of areas such as near and off shore zones, bays, river confluences, and the thermocline. Its nutrient variables include dissolved, labile particulate, and refractory particulate forms which provide a more realistic description of phytoplankton-nutrient interactions. Improvements were made to the light calculation by using a three-hour rather than 24-hour (one day) average estimate of solar radiation. The model is driven by the Princeton Ocean hydrodynamics Model which simulates water movements. LM3-Eutro

has 17 state variables, including a single zooplankton class, two phytoplankton classes, and several particulate and dissolved nutrient (including carbon) states.

The model was calibrated on the high-resolution (44,042 cells) Level 3 framework as well as the 41 segment Level 2 framework. The Level 2 calibration enabled us to visually observe known spatial and temporal trends such as the spring diatom bloom and phytoplankton concentration gradients between the epilimnion and hypolimnion. The Level 3 calibration was performed on a whole-lake basis. The 1994-1995 LMMBP field data were used to calibrate the model. The final calibration was chosen based on the best Level 3 calibration, but Level 2 output was visually inspected to ensure that expected phytoplankton and nutrients trends were reflected. Model confirmation was performed by comparing the model to limited total phosphorus data for 1998 and 2000 and to a historical model, MICH1, which was developed and calibrated in the 1970s and modified more recently. All comparisons were done on a whole-lake basis, and LM3-Eutro fits the 1998 and 2000 data well. LM3-Eutro and MICH1 compared surprisingly well, especially given the fact that they are based on very different frameworks, kinetics, and segmentation. Compared to field data and LM3-Eutro predicted, MICH1 underpredicted both total phosphorus concentrations. This was probably due to the fact that MICH1 does not have any phosphorus sediment recycling. Lower phosphorus values also cause MICH1 to under-predict chlorophyll *a* concentrations in the lake.

MICHTOX is a toxic chemical mass balance and food chain bioaccumulation model developed in the early 1990s. A Bayesian Monte Carlo uncertainty analysis demonstrated that MICHTOX predicted PCB concentrations should be within a factor of two measured data. During the early part of the LMMBP, MICHTOX was updated and used as a preliminary assessment tool of the LMMBP PCB data and to provide a screening-level analysis of the potential future trends in total PCB concentrations in Lake Michigan water, sediment, and fish under a variety of contaminant load scenarios. Unmonitored tributary inputs were added to the model and the applicability of MICHTOX for predicting Lake Michigan total PCB concentrations in water, sediment, and fish was reconfirmed. MICHTOX was applied using the previously developed parameterization and LMMBP data and forcing functions. The model fit to data was acceptable with no adjustments to the model parameters. The model also provided a comparison of an older, "off-the-shelf" model with the more complex models developed as part of the Lake Michigan Mass Balance Project (LMMBP). MICHTOX was run for seven scenarios to help evaluate the impacts on PCB trends caused by various loading sources and to evaluate loading scenarios. Results of the MICHTOX modeling indicate that atmospheric exchange is a dominant loss process of total PCBs in Lake Michigan, and that the reservoir of total PCBs in the sediment has a significant impact on the future trends in concentrations of total PCBs in lake trout.

LM2-Toxic is a sophisticated and state-of-the-art toxic chemical fate and transport model for Lake Michigan. It is a coupled mass balance of organic carbon solids and toxic chemical (PCBs) dynamics. Using the LMMBP generated field data, the organic carbon solids dynamics were first calibrated. This was followed by the independent calibration of PCB dynamics. The temporal variations of both biotic carbon (BIC) and particulate detrital carbon (PDC) resulted from an algal bloom in late spring and early summer. Primary production was the dominant organic carbon load to Lake Michigan. The eutrophication model (LM3-Eutro) generated primary production accounted for over 90 percent of the total particulate organic carbon load to the lake.

The main focus of this model is to address the relationship between sources of toxic chemicals and their concentrations in water and sediments of Lake Michigan and to provide the PCB exposure concentrations to the bioaccumulation model (LM2 Food Chain) to predict PCBs concentrations in lake trout tissue. LM2-Toxic is a revision of the USEPA supported WASP4 water quality modeling framework. It incorporates the organic carbon dynamics featured in GBTOX and the sediment transport scheme, a quasi-Lagrangian framework, used in the IPX. Both GBTOX and IPX were WASP4-type models and major components in the Green Bay Mass Balance Study modeling framework. Another important modification was the addition of updated air-water exchange formulations to the model.

The results at 5 x 5 km² grid generated by Princeton Ocean Model for the Great Lakes (POMGL) were linked to the transport fields for LM2-Toxic. Due to an affinity of PCBs for organic carbon, three organic carbon sorbents were simulated as state variables in LM2-Toxic. They were BIC, PDC and dissolved organic carbon (DOC). The model simulated 54 PCB congeners which accounted for 63% to 85% of the total PCB mass in various media for Lake Michigan. This was an enormous effort because individual congeners or co-eluting congeners were modeled as separate state variables in the mass balance, each with their own physical/chemical properties. Four phases were simulated in LM2-Toxic for the congeners. The four phases were dissolved, sorbed to PDC, sorbed to BIC, and bound to DOC.

To reduce uncertainties associated with water transport, settling and resuspension, and sedimentation, a thermal balance model, a chloride model, a long-term simulation using a ¹³⁷Cs and ^{239,240}Pu model, and a long-term organic carbon simulation using LM2-Toxic were developed and run for LM2-Toxic confirmation.

Air-water exchange of PCBs was the most important process for Lake Michigan. Net sediment resuspension was the second largest net source. Both the water column and the surficial sediment layer of the lake were not at steady-state during the LMMBP period. The model was also applied for forecasting the long-term responses (60-year simulation, starting on January 1, 1996) of the PCBs in Lake Michigan under various forcing functions and load reduction scenarios. The results indicate that the PCB mass in the surficial sediment is large and thus could support PCB concentrations in the water column for a very long time.

LM Food Chain is the food web bioaccumulation model developed for the LMMBP. The model established dynamic relationships between PCBs concentrations in the exposure environments and resulting PCBs levels in the lake trout food webs of Lake Michigan. The model was based upon available theory and data characterizing the bioaccumulation of toxic chemicals in fish and other aquatic organisms. Samples collected for the LMMBP were used to generate data on lake trout and coho salmon food webs in Lake Michigan and to facilitate refinement of model parameters to site-specific conditions for forty PCB congeners or co-eluters that represented toxic chemicals covering a wide range of hydrophobicity.

The food web model was calibrated with PCB data collected in 1994 and 1995 for lake trout food webs at Sturgeon Bay, Sheboygan Reef, and Saugatuck. The lake trout sub-populations in these three biota zones were believed to be appropriate representations of lake trout in Lake Michigan. Model calibration was also performed for a lake-wide coho salmon food web. During the model calibration, model parameters were refined to achieve an adequate agreement between model calculations and observed PCB data for a food web. The focus of model calibration was not limited to top predators or to toxics with a certain hydrophobicity. The model parameters were systematically optimized for all species at various trophic levels and for PCB congeners of a wide range of hydrophobicity. Extra care was taken to ensure the refined parameter values were consistent with the hydrophobicity of individual PCB congeners and with the trophic position of individual species. Satisfactory calibration results were achieved for the lake trout food webs at Sturgeon Bay and Saugatuck. The model parameters calibrated with data from the Sturgeon Bay food webs were independently tested and validated with data from the Saugatuck food web, and *vice versa*.

The availability of a complete account of observed data for each food web made this model calibration probably the most thorough process among similar efforts. Although PCB concentrations in lake trout or coho salmon were the endpoint of the model computation and the focus of most model applications, the food web model with parameters "fine-tuned" for species at all trophic levels can be used to target any desirable species in the food web with a high degree of confidence. Also, the food web model can be used to model toxics with various hydrophobicities. No food web model intended to simulate as many toxic chemicals with diverse hydrophobicity has been previously developed.

The validated food web model was applied to the lake trout food webs at Sturgeon Bay and Saugatuck and inferred for the southeastern and northwestern regions of the lake to predict future PCB concentrations. Several model simulations were performed to predict the expected changes in future lake trout PCB concentrations in response to different exposure scenarios. Hypothetical long-term PCB exposure scenarios in the post-1994/1995 period for the food webs at the Sturgeon Bay and Saugatuck biota zones were generated by the water quality model LM2-Toxic. For each lake trout food web, the resulting concentrations of individual PCB congeners in fish were predicted. Similar model predictions were observed for these two biota zones under each reduction scenario. For the continued fast recovery scenario, current simulations indicate that the total PCB concentrations in adult lake trout (5.5 years old) were expected to reach the target level of 0.075 ppm in 2030 for the Saugatuck biota zone, 2033 for southeastern Lake Michigan, 2036 for northwestern Lake Michigan, and 2036 for the Sturgeon Bay biota zone.

PART 1

INTRODUCTION

Chapter 1. Project Overview

Harry B. McCarty, Ken Miller, Robert N. Brent, and
Judy Schofield

DynCorp (a CSC Company)

601 Stevenson Avenue

Alexandria, Virginia 22304

and

Ronald Rossmann and Kenneth R. Rygwelski

U.S. Environmental Protection Agency

Office of Research and Development

National Health and Environmental Effects

Research Laboratory

Mid-Continent Ecology Division

Large Lakes and Rivers Forecasting Research

Branch

Large Lakes Research Station

9311 Groh Road

Grosse Ile, Michigan 48138

The United States Environmental Protection Agency's (USEPA) Great Lakes National Program Office (GLNPO) instituted the Lake Michigan Mass Balance Project (LMMBP) to measure and model the concentrations of representative pollutants within important compartments of the Lake Michigan ecosystem. For the LMMBP, concentrations of polychlorinated biphenyls (PCBs), *trans*-nonachlor, atrazine, and mercury in tributaries, lake water, sediments, food webs, and the atmosphere surrounding Lake Michigan were measured. This document contains the PCB modeling results reported by staff and contractors of the USEPA/Office of Research and Development (ORD)/National Health and Environmental Effects Research Laboratory (NHEERL)/Large Lakes and

Rivers Forecasting Research Branch (LLRFRB) staff and contractors located at the Large Lakes Research Station (LLRS).

1.1.1 Background

The Great Lakes, which contain 20% of the world's freshwater, are a globally important natural resource currently threatened by multiple stressors. While significant progress has been made to improve the quality of the lakes, pollutant loads from point, non-point, atmospheric, and legacy sources continue to impair ecosystem functions and limit the attainability of designated uses of these resources. Fish consumption advisories and beach closings continue to be issued, emphasizing the human health concerns from lake contamination. Physical and biological stressors, such as invasion of non-native species and habitat loss, also continue to threaten the biological integrity of the Great Lakes.

The United States and Canada have recognized the significance and importance of the Great Lakes as a natural resource and have taken steps to restore and protect the lakes. In 1978, both countries signed the Great Lakes Water Quality Agreement (GLWQA). This Agreement calls for the restoration and maintenance of the chemical, physical, and biological integrity of the Great Lakes by developing plans to monitor and limit pollutant flows into the lakes.

The GLWQA, as well as Section 118(c) of the Clean Water Act, require the development of a Lake-wide Management Plan (LaMP) for each Great Lake. The purpose of these LaMPs is to document an approach to reduce inputs of critical pollutants to the Great

Lakes and restore and maintain Great Lakes integrity. To assist in developing these LaMPs and to monitor progress in pollutant reduction, Federal, State, Tribal, and local entities have instituted Enhanced Monitoring Plans (EMPs). Monitoring is essential to the development of baseline conditions for the Great Lakes and provides a sound scientific base of information to guide future toxic load reduction efforts.

The LMMBP is a part of the EMPs for Lake Michigan. The LMMBP was a coordinated effort among Federal, State, and academic scientists to monitor tributary and atmospheric pollutant loads, develop source inventories of toxic substances, and evaluate the fates and effects of these pollutants in Lake Michigan. A mass balance modeling approach provides the predictive ability to determine the environmental benefits of specific load reduction

scenarios for toxic substances and the time required to realize those benefits. This predictive ability will allow Federal, State, Tribal, and local agencies to make more informed load reduction decisions.

1.1.2 Description

The LMMBP used a mass balance approach to evaluate the sources, transport, and fate of contaminants in the Lake Michigan ecosystem. A mass balance approach is based on the law of conservation of mass, which states that the amount of a pollutant entering a system is equal to the amount of that pollutant leaving, trapped in, and chemically changed in the system (Figure 1.1.1). In the Lake Michigan system, pollutant inputs may come from atmospheric deposition or tributary loads.

Simple Mass Budget for Conservative Substances

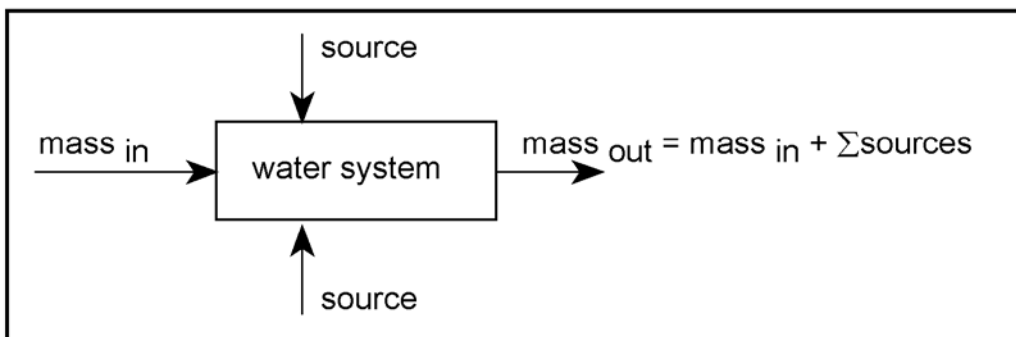

Mass Balance Modeling Approach

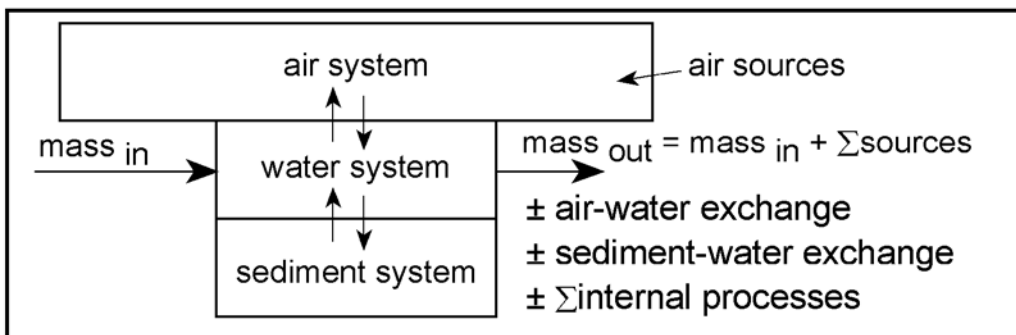

Figure 1.1.1. Simplified mass balance approach.

Pollutants may leave the system through burial in bottom sediments, volatilization to the atmosphere, or discharge into Lake Huron through the Straits of Mackinaw. Pollutants within the system may be transformed through degradation or stored in ecosystem compartments such as the water column, sediments, or biota.

For the LMMP, contaminant concentrations in various inputs and ecosystem compartments over spatial and temporal scales were measured. Mathematical models that track the transport and fate of contaminants within Lake Michigan were developed and calibrated using these field data. The LMMP was the first lake-wide application of a mass balance determination for the Great Lakes and will serve as a basis for future mass budget/mass balance efforts.

1.1.3 Scope

1.1.3.1 Modeled Pollutants

When the USEPA published the Water Quality Guidance for the Great Lakes System (58 FR 20802), the Agency established water quality criteria for 29 pollutants. Those criteria were designed to protect aquatic life, terrestrial wildlife, and human health. PCBs, *trans*-nonachlor, and mercury are included in the list of 29 pollutants. The water quality criteria and values proposed in the guidance apply to all of the ambient waters of the Great Lakes System, regardless of the sources of pollutants in those waters. The proposed criteria provide a uniform basis for integrating Federal, State, and Tribal efforts to protect and restore the Great Lakes ecosystem.

The number of pollutants that can be intensively monitored and modeled in the Great Lakes System is limited by the resources available to collect and analyze thousands of samples, assure the quality of the results, manage the data, and develop and calibrate the necessary models. Therefore, the LMMP focused on constructing mass balance models for a limited group of pollutants. PCBs, *trans*-nonachlor, atrazine, and mercury were selected for inclusion in the LMMP because these pollutants currently or potentially pose a risk to aquatic and terrestrial organisms (including humans) in the Lake Michigan ecosystem (Table 1.1.1). These pollutants also were selected to cover a wide range of chemical

and physical properties and represent other classes of compounds which pose current or potential problems. Once a mass budget for selected pollutants is established and a mass balance model calibrated, additional contaminants can be modeled with limited data and future resources can be devoted to activities such as emission inventories and dispersion modeling.

1.1.3.1.1 PCBs

Polychlorinated biphenyls (PCBs) are a class of man-made, chlorinated, organic chemicals that include 209 congeners, or specific PCB compounds. The highly stable, nonflammable, non-conductive properties of these compounds made them useful in a variety of products including electrical transformers and capacitors, plastics, rubber, paints, adhesives, and sealants. PCBs were produced for such industrial uses in the form of complex mixtures under the trade name "Aroclor" and were commercially available from 1930 through 1977, when the USEPA banned their production due to environmental and public health concerns. PCBs also may be produced by combustion processes, including incineration, and can be found in stack emissions and ash from incinerators.

Because they were found by the USEPA in the effluents from one or more wastewater treatment facilities, seven Aroclor formulations were included in the Priority Pollutant List developed by the USEPA Office of Water under the auspices of the Clean Water Act. Aroclors may have entered the Great Lakes through other means, including spills or improper disposal of transformer fluids, contaminated soils washing into the watershed, or discharges from ships. The PCBs produced by combustion processes may be released to the atmosphere where they are transported in both vapor and particulate phases and enter the lakes through either dry deposition or precipitation events (e.g., rain).

The stability and persistence of PCBs, which made them useful in industrial applications, have also made these compounds ubiquitous in the environment. PCBs do not readily degrade and thus accumulate in water bodies and aquatic sediments. PCBs also bioaccumulate, or build up, in living tissues. Levels of PCBs in some fish from Lake Michigan exceed U.S. Food and Drug Administration tolerances,

Table 1.1.1. Characteristics of the LMMBP Modeled Pollutants

Pollutant	Sources	Uses	Toxic Effects	Bioconcentration Factor ¹	USEPA Regulatory Standards ²
PCBs	<ul style="list-style-type: none"> Waste incinerators (unintentional byproducts of combustion) Industrial dischargers Electrical power 	<ul style="list-style-type: none"> Electrical transformers and capacitors Carbonless copy paper Plasticizers Hydraulic fluids 	<ul style="list-style-type: none"> Probable human carcinogen Hearing and vision impairment Liver function alterations Reproductive impairment and deformities in fish and wildlife 	1,800 to 180,000	MCL = 0.5 µg/L CCC = 14 ng/L HH = 0.17 ng/L
<i>trans</i> -Nonachlor ³	<ul style="list-style-type: none"> Application to crops and gardens 	<ul style="list-style-type: none"> Pesticide on corn and citrus crops Pesticide on lawns and gardens 	<ul style="list-style-type: none"> Probable human carcinogen Nervous system effects Blood system effects Liver, kidney, heart, lung, spleen, and adrenal gland damage 	4,000 to 40,000	MCL = 2 µg/L CMC = 2.4 µg/L CCC = 4.3 ng/L HH = 2.1 ng/L
Atrazine	<ul style="list-style-type: none"> Application to crops 	<ul style="list-style-type: none"> Herbicide for corn and sorghum production 	<ul style="list-style-type: none"> Weight loss Cardiovascular damage Muscle and adrenal degeneration Congestion of heart, lungs, and kidneys Toxic to aquatic plants 	2 to 100	MCL = 3 µg/L CMC ⁴ = 350 µg/L CCC ⁴ = 12 µg/L
Mercury	<ul style="list-style-type: none"> Waste disposal Manufacturing processes Energy production Ore processing Municipal & medical waste incinerators Chloralkali factories Fuel combustion 	<ul style="list-style-type: none"> Battery cells Barometers Dental fillings Thermometers Switches Fluorescent lamps 	<ul style="list-style-type: none"> Possible human carcinogen Damage to brain and kidneys Adverse affects on the developing fetus, sperm, and male reproductive organs 	63,000 to 100,000	MCL = 2 µg/L CMC = 1.4 µg/L CCC = 0.77 µg/L HH = 50 ng/L FWA ⁵ = 2.4 µg/L FWC ⁵ = 12 ng/L Wildlife ⁶ = 1.3 ng/L

¹From: U.S. Environmental Protection Agency, 1995a, National Primary Drinking Water Regulations, Contaminant Specific Fact Sheets, Inorganic Chemicals, Technical Version, EPA 811/F-95/002-T, USEPA, Office of Water, Washington, D.C.; and U.S. Environmental Protection Agency, 1995b, National Primary Drinking Water Regulations, Contaminant Specific Fact Sheets, Synthetic Organic Chemicals, Technical Version, EPA 811/F-95/003-T, USEPA, Office of Water, Washington, D.C.

²MCL = Maximum Contaminant Level for drinking water. CMC = Criterion Maximum Concentration for protection of aquatic life from acute toxicity. CCC = Criterion Continuous Concentration for protection of aquatic life from chronic toxicity. HH = water quality criteria for protection of human health from water and fish consumption. Data from: U.S. Environmental Protection Agency, 1999, National Recommended Water Quality Criteria-Correction, EPA 822/Z-99/001, USEPA, Office of Water, Washington, D.C.

³Characteristics presented are for chlordane. *trans*-Nonachlor is a principle component of the pesticide chlordane.

⁴Draft water quality criteria for protection of aquatic life. From: U.S. Environmental Protection Agency, 2001b, Ambient Aquatic Life Water Quality Criteria for Atrazine, USEPA, Office of Water, Washington, D.C.

⁵FWA = Freshwater acute water quality criterion. FWC = Freshwater chronic water quality criterion. From National Toxics Rule (58 FR 60848).

⁶Wildlife criterion. From the Stay of Federal Water Quality Criteria for Metals (60 FR 22208), 40 CFR 131.36 and the Water Quality Guidance for the Great Lakes System (40 CFR 132).

prompting closure of some commercial fisheries and issuance of fish consumption advisories. PCBs are a probable human carcinogen, and human health effects of PCBs exposure include stomach, kidney, and liver damage; liver and biliary tract cancer; and reproductive effects, including effects on the fetus after exposure of the mother.

PCB congeners exhibit a wide range of physical and chemical properties (e.g. vapor pressures, solubilities, boiling points), are relatively resistant to degradation, and are ubiquitous. These properties make them ideal surrogates for a wide range of organic compounds from anthropogenic sources.

1.1.3.1.2 Isomer *trans*-Nonachlor

The isomer *trans*-nonachlor is a component of the pesticide chlordane. Chlordane is a mixture of chlorinated hydrocarbons that was manufactured and used as a pesticide from 1948 to 1988. Prior to 1983, approximately 3.6 million pounds of chlordane were used annually in the United States. In 1988, the USEPA banned all production and use of chlordane in the United States.

Like PCBs, chlordane is relatively persistent and bioaccumulative. The *trans*-nonachlor is the most bioaccumulative of the chlordanes, and is a probable human carcinogen. Other human health effects include neurological effects, blood dyscrasia, hepatotoxicity, immunotoxicity, and endocrine system disruption.

Historically, *trans*-nonachlor may have entered the Great Lakes through a variety of means related to the application of chlordane, including improper or indiscriminate application, improper cleaning and disposal of pesticide application equipment, or contaminated soils washing into the watershed. In the LMMBP, *trans*-nonachlor served as a model for the cyclodiene pesticides.

1.1.3.1.3 Atrazine

Atrazine is a triazine herbicide based on a ring structure with three carbon atoms alternating with three nitrogen atoms. Atrazine is the most widely used herbicide in the United States for corn and sorghum production. Atrazine has been used as an agricultural herbicide since 1959, and 64 to 75 million

pounds of atrazine are used annually in the United States. Atrazine is extensively used in the upper Midwest, including the Lake Michigan watershed, where it is primarily associated with corn crops.

Unlike PCBs and *trans*-nonachlor, atrazine is not bioaccumulative. It is persistent in water; however, it is moderately susceptible to biodegradation in soils with a half-life of about 60-150 days. Atrazine rarely exceeds the 3 ppb maximum contaminant level (MCL) set by the USEPA as a drinking water standard, but localized peak values can exceed the MCL following rainfall events after atrazine application.

In January 31, 2003, the U.S. EPA issued an Interim Reregistration Eligibility Decision (IRED) for atrazine. In an October 2003 addendum to the IRED, the agency concluded that there is sufficient evidence to formulate a hypothesis that atrazine exposure may impact gonadal development in amphibians, but there are currently insufficient data to either confirm or refute the hypothesis. Based on available test data, atrazine is not likely to be a human carcinogen. The Agency does have concern in regards to the potential hormonal effects observed in laboratory animals exposed to atrazine. Above certain concentration thresholds, atrazine is toxic to aquatic plants. In the LMMBP, atrazine served as a model to describe the transport and fate of a water-soluble pesticide in current use.

1.1.3.1.4 Mercury

Mercury is a naturally-occurring toxic metal. Mercury is used in battery cells, barometers, thermometers, switches, fluorescent lamps, and as a catalyst in the oxidation of organic compounds. Global releases of mercury in the environment are both natural and anthropogenic (caused by human activity). It is estimated that about 11,000 metric tons of mercury are released annually to the air, soil, and water from anthropogenic sources. These sources include combustion of various fuels such as coal; mining, smelting and manufacturing activities; wastewater; and agricultural, animal, and food wastes.

As an elemental metal, mercury is extremely persistent in all media. Mercury also bioaccumulates with reported bioconcentration factors in fish tissues in the range of 63,000 to 100,000. Mercury is a

possible human carcinogen and causes the following human health effects: stomach, large intestine, brain, lung, and kidney damage; blood pressure and heart rate increase; and fetal damage. In the LMMBP, mercury served as a model for bioaccumulative metals.

1.1.3.2 Other Measured Parameters

In addition to the four chemicals modeled in the LMMBP, many other chemicals and parameters were measured in the LMMBP as part of the EMPs. A survey of these chemicals and parameters aids in the understanding of the overall ecological integrity of Lake Michigan. These additional parameters include various biological indicators; meteorological parameters; and organic, metal, and conventional chemicals in Lake Michigan. A complete listing of parameters included in this study is provided in Table 1.1.2. A comprehensive listing of parameters and compartments may be found in Chapter 3 (Appendix 1.3.1).

1.1.3.3 Measured Compartments

In the LMMBP, contaminants were measured in the following compartments:

- **Open Lake Water Column:** The water column in the open lake was sampled and analyzed for the modeled pollutants.
- **Tributaries:** Major tributaries were sampled and analyzed for the modeled pollutants.
- **Fish:** Top predators and forage base species were sampled and analyzed for diet analysis and contaminant burden.
- **Lower Pelagic Food Chain:** Phytoplankton and zooplankton were sampled and analyzed for species diversity, taxonomy, and contaminant burden.
- **Sediments:** Cores were collected and trap devices were used to collect sediment for determination of contaminants and sedimentation rates.

- **Atmosphere:** Vapor, particulate, and precipitation phase samples were collected and analyzed for the modeled pollutants.

For the modeled pollutants, more than 20,000 samples were collected at more than 300 sampling locations and analyzed, including more than 9,000 quality control (QC) samples (Figure 1.1.2). Field data collection activities were initially envisioned as a one-year effort. However, it became evident early into the project that a longer collection period would be necessary to provide a full year of concurrent information on contaminant loads and ambient concentrations for modeling purposes. Therefore, field sampling occurred from April 1994 to October 1995.

1.1.4 Objectives

The goal of the LMMBP was to develop a sound, scientific base of information to guide future toxic load reduction efforts at the Federal, State, Tribal, and local levels. To meet this goal, the four following LMMBP objectives were developed:

- ▶ **Estimate pollutant loading rates:** Environmental sampling of major media will allow estimation of relative loading rates of critical pollutants to the Lake Michigan Basin.
- ▶ **Establish baseline:** Environmental sampling and estimated loading rates will establish a baseline against which future progress and contaminant reductions can be gauged.
- ▶ **Predict benefits associated with load reductions:** The completed mass balance model will provide a predictive tool that environmental decision-makers and managers may use to evaluate the benefits of specific load reduction scenarios.
- ▶ **Understand ecosystem dynamics:** Information from the extensive LMMBP monitoring and modeling efforts will improve our scientific understanding of the environmental processes governing contaminant cycling and availability within relatively closed ecosystems.

Table 1.1.2. The LMMBP Parameters

Organics	
acenaphthene	<i>p,p'</i> -DDT
acenaphthylene	endosulfan sulfate
aldrin	endosulfan I
anthracene	endosulfan II
atrazine	endrin
α-BHC	endrin aldehyde
β-BHC	endrin ketone
δ-BHC	fluoranthene
γ-BHC	fluorene
benzo[a]anthracene	heptachlor
benzo[g,h,i]perylene	heptachlor epoxide
benzo[b]fluoranthene	hexachlorobenzene (HCB)
benzo[k]fluoranthene	indeno[1,2,3-cd]pyrene
benzo[e]pyrene	mirex
benzo[a]pyrene	<i>trans</i> -nonachlor
α-chlordane	oxychlordane
γ-chlordane	PCBs congeners
chrysene	phenanthrene
coronene	pyrene
<i>p,p'</i> -DDE	retene
<i>p,p'</i> -DDD	toxaphene

Metals	
aluminum	magnesium
arsenic	manganese
calcium	sodium
cadmium	nickel
chromium	lead
cesium	selenium
copper	thorium
iron	titanium
mercury	vanadium
potassium	zinc

Conventionals	
alkalinity	particulate organic carbon
ammonia	percent moisture
bromine	pH
chloride	phosphorus
chlorine	silica
sulfate	silicon
conductivity	temperature
dissolved organic carbon	total Kjeldahl nitrogen
dissolved oxygen	total organic carbon
dissolved phosphorus	total phosphorus
dissolved reactive silica	total suspended particulates

Conventionals (Continued)	
dry weight fraction element carbon	<i>ortho</i> -phosphorus
nitrate	total hardness
	turbidity

Biologicals	
fish species	fish weight
fish age	fish length
fish maturity	fish taxonomy
chlorophyll <i>a</i>	fish diet analysis
fish lipid amount	primary productivity
zooplankton	

Meteorological	
air temperature	wind direction
relative humidity	wind speed
barometric pressure	visibility
weather conditions	wave height and direction

1.1.5 Design

1.1.5.1 Organization

The GLNPO proposed a mass balance approach to provide coherent, ecosystem-based evaluation of toxics in Lake Michigan. GLNPO served as the program sponsor for the LMMBP. GLNPO formed two committees to coordinate study planning, the Program Steering Committee and the Technical Coordinating Committee. These committees were comprised of Federal, State, and academic laboratories as well as commercial laboratories (see Section 1.1.5.2, Study Participants). The committees administered a wide variety of tasks including: planning the project, locating the funding, designing the sample collection, coordinating sample collection activities, locating qualified laboratories, coordinating analytical activities, assembling the data, assuring the quality of the data, assembling skilled modelers, developing the models, and communicating interim and final project results. The Mid-Continent Ecology Division (MED) at Duluth, in cooperation with the National Oceanic and Atmospheric Administration (NOAA) Great Lakes Environmental Research Laboratory (GLERL) and the Atmospheric Sciences Modeling Division, supported the modeling component of the mass balance study by developing a suite of integrated mass balance models to

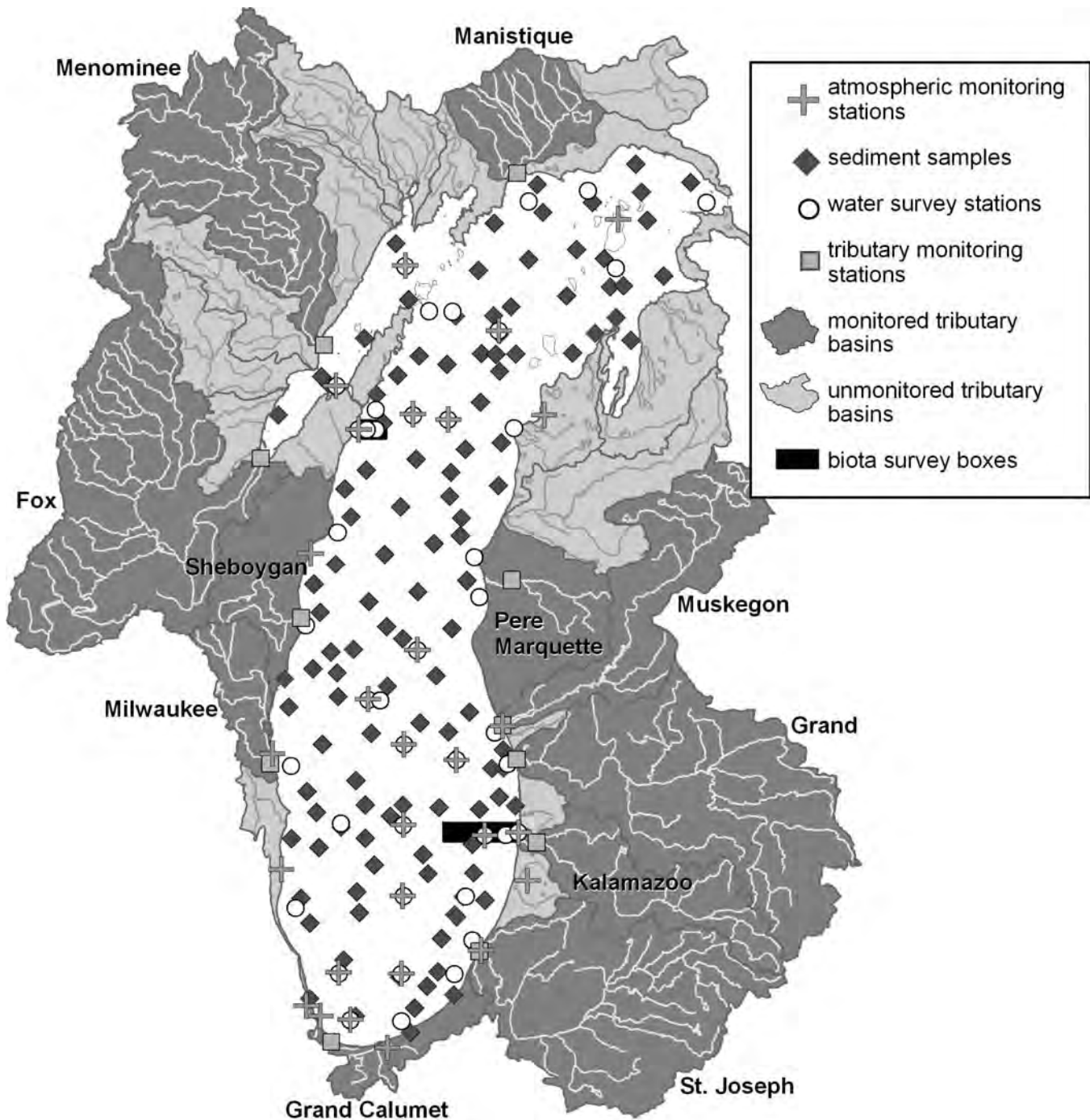

Figure 1.1.2. The LMMBP sampling locations.

simulate the transport, fate, and bioaccumulation of the study target analytes.

1.1.5.2 Study Participants

The LMMBP was a coordinated effort among Federal, State, and academic scientists; and commercial laboratories. The following agencies and organizations have all played roles in ensuring the success of the LMMBP. Except for the three organizations indicated with an asterisk (*), all of the participants were members of the LMMBP Steering Committee.

Federal and International

- ▶ USEPA GLNPO (*Program Sponsor*)
- ▶ USEPA Region V Water Division (WD)
- ▶ USEPA Region V Air Division
- ▶ USEPA/ORD/NHEERL/MED/LLRFRB
- ▶ ORD National Exposure Research Laboratory
- ▶ U.S. Department of Interior (USDOI) U.S. Geological Survey (USGS) Water Resources Division (WRD)
- ▶ USDOI/USGS Biological Resources Division Great Lakes Science Center (GLSC)
- ▶ U.S. Fish and Wildlife Service (USFWS)
- ▶ U.S. Department of Energy
- ▶ U.S. Department of Commerce NOAA/GLERL
- ▶ USEPA Office of Air and Radiation*
- ▶ USEPA Office of Water*
- ▶ Environment Canada*
- ▶ U.S. Department of Energy Battelle NW

State

- ▶ Illinois Department of Natural Resources
- ▶ Illinois Water Survey
- ▶ Indiana Department of Environmental Management
- ▶ Michigan Department of Natural Resources
- ▶ Michigan Department of Environmental Quality (MDEQ)
- ▶ Wisconsin Department of Natural Resources
- ▶ Wisconsin State Lab of Hygiene

Academic and Commercial

- ▶ Indiana University
- ▶ Rutgers University
- ▶ University of Maryland

- ▶ University of Michigan
- ▶ University of Minnesota
- ▶ University of Wisconsin
- ▶ Grace Analytical

1.1.5.3 Workgroups

Eleven workgroups were formed to provide oversight and management of specific project elements. The workgroups facilitated planning and implementation of the study in a coordinated and systematic fashion. The workgroups communicated regularly through participation in monthly conference calls and annual “all-hands” meetings. Workgroup chairs were selected and were responsible for managing tasks under the purview of the workgroup and communicating the status of activities to other workgroups. The workgroups and workgroup chairs are listed below.

- Program Steering Committee – Paul Horvatin (USEPA/GLNPO)
- Technical Coordinating Committee – Paul Horvatin (USEPA/GLNPO)
- Modeling Workgroup – William Richardson (USEPA/ORD/NHEERL/MED/LLRFRB)
- Air Monitoring Workgroup – Jackie Bode (USEPA/GLNPO)
- Biota Workgroup – Paul Bertram (USEPA/GLNPO) and John Gannon (USDOI/USGS/GLSC)
- Chemistry Workgroup – David Anderson (USEPA/GLNPO)
- Data Management Workgroup – Kenneth Klewin and Philip Strobel (USEPA/GLNPO)
- Lake Monitoring Workgroup – Glenn Warren (USEPA/GLNPO)
- Tributary Monitoring Workgroup – Gary Kohlhepp (USEPA/Region V/WD) and Robert Day (MDEQ)
- Quality Assurance Workgroup – Louis Blume and Michael Papp (USEPA/GLNPO)
- Sediment Monitoring Workgroup – Brian Eadie (NOAA/GLERL)

1.1.5.4 Information Management

As program sponsor, GLNPO managed information collected during the LMMBP. Principal Investigators (PIs) participating in the study reported field and analytical data to GLNPO. GLNPO developed a data standard for reporting field and analytical data and a database for storing and retrieving study data.

GLNPO was also responsible for conducting data verification activities and releasing verified data to the study modelers and the public. The flow of information is illustrated in Figure 1.1.3.

1.1.5.4.1 Data Reporting

Over 20 organizations produced LMMBP data through the collection and analysis of more than 20,000 samples. In the interest of standardization, specific formats (i.e., file formats and codes to represent certain data values) were established for reporting the LMMBP data. Each format specified the “rules” by which data were submitted, and, in many cases, the allowable values by which they were to be reported. The data reporting formats were designed to minimize the number of data elements

reported from the field crews and laboratory analysis. Data reporting formats and the resulting Great Lakes Environmental Monitoring Database (GLENDa, see Section 1.1.5.4.2) were designed to be applicable to projects outside the LMMBP as well.

Principal Investigators (including sampling crews and the analytical laboratories) supplied sample collection and analysis data following the standardized reporting formats, if possible. The LMMBP data were then processed through an automated SAS-based data verification system, Research Data Management and Quality Control System (RDMQ), for quality assurance (QA)/QC checking. After verification and validation by the PI, the data sets were output in a form specific for upload to GLENDa. Finally, these data sets were uploaded to GLENDa.

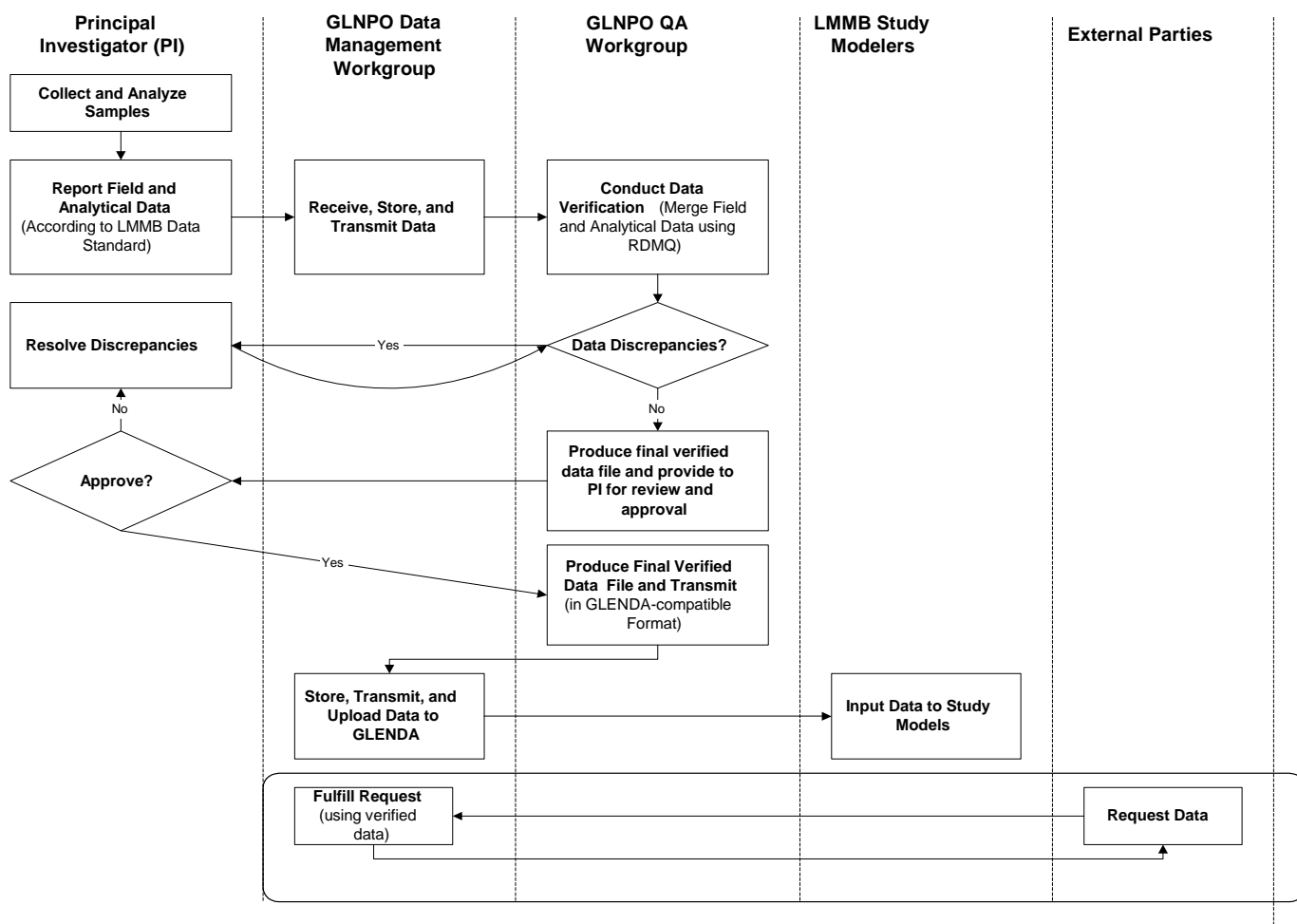

Figure 1.1.3. Flow of information in the LMMBP.

1.1.5.4.2 Great Lakes Environmental Monitoring Database

Central to the data management effort is a computerized database system to house LMMBP and other project results. That system, the Great Lakes Environmental Monitoring Database (GLENDA), was developed to provide data entry, storage, access, and analysis capabilities to meet the needs of mass balance modelers and other potential users of Great Lakes data.

Development of GLENDA began in 1993 with a logical model based on the modernized STORET concept and requirements analysis. GLENDA was developed with the following guiding principles:

- **True multi-media scope** – Water, air, sediment, taxonomy, fish tissue, fish diet, and meteorology data can all be housed in the database.
- **Data of documented quality** – Data quality is documented by including results of quality control parameters.
- **Extensive contextual indicators** – Ensure data longevity by including enough information to allow future or secondary users to make use of the data.
- **Flexible and expandable** – Database is able to accept data from any Great Lakes monitoring project.
- **National compatibility** – GLENDA is compatible with STORET and allows ease of transfer between these large databases.

In an effort to reduce the data administration burden and ensure consistency of data in this database, GLNPO developed several key tools. Features including standard data definitions, reference tables, standard automated data entry applications, and analytical tools are (or will soon be) available.

1.1.5.4.3 Public Access to LMMBP Data

All LMMBP data that have been verified (through the QC process) and validated (accepted by the PI) are available to the public. Currently, GLNPO requires that written requests be made to obtain the LMMBP

data. The data sets are available in several formats including WK1, DBF, and SD2.

The primary reason for requiring an official request form for the LMMBP data is to keep track of requests. This allows GLNPO to know how many requests have been made, who has requested data, and what use they intend for the data. This information assists GLNPO in managing and providing public access to Great Lakes data and conducting public outreach activities. In the future, after all data are verified and validated, GLNPO intends to make condensed versions of the data sets available on the LMMBP web site for downloading. This will allow easy public access to the LMMBP data.

Further information on the information management for the LMMBP can be found in The Lake Michigan Mass Balance Study Quality Assurance Report (U.S. Environmental Protection Agency, 2001a).

1.1.5.5 Quality Assurance Program

At the outset of the LMMBP, managers recognized that the data gathered and the models developed from the study would be used extensively by decision-makers responsible for making environmental, economic, and policy decisions. Environmental measurements are never true values and always contain some level of uncertainty. Decision-makers, therefore, must recognize and be sufficiently comfortable with the uncertainty associated with data on which their decisions are based. In recognition of this requirement, the LMMBP managers established a QA program goal of ensuring that data produced under the LMMBP would meet defined standards of quality with a specified level of confidence.

The QA program prescribed minimum standards to which all organizations collecting data were required to adhere. Data quality was defined, controlled, and assessed through activities implemented within various parameter groups (e.g., organic, inorganic, and biological parameters). QA activities included the following:

-
- ▶ **QA Program** – Prior to initiating data collection activities, plans were developed, discussed, and refined to ensure that study objectives were adequately defined and to ensure that all QA activities necessary to meet study objectives were considered and implemented.
 - ▶ **QA Workgroup** – USEPA established a QA Workgroup whose primary function was to ensure that the overall QA goals of the study were met.
 - ▶ **QA Project Plans (QAPPs)** – USEPA worked with PIs to define program objectives, data quality objectives (DQOs), and measurement quality objectives (MQOs) for use in preparing Quality Assurance Project Plans (QAPPs). Principal investigators submitted QAPPs to the USEPA for review and approval. USEPA reviewed each QAPP for required QA elements and soundness of planned QA activities.
 - ▶ **Training** – Before beginning data collection activities, PIs conducted training sessions to ensure that individuals working on the project were capable of properly performing data collection activities for the LMMBP.
 - ▶ **Monthly Conference Calls and Annual Meetings** – USEPA, PIs, and support contractors participated in monthly conference calls and annual meetings to discuss project status and objectives, QA issues, data reporting issues, and project schedules.
 - ▶ **Standardized Data Reporting Format** – PIs were required to submit all data in a standardized data reporting format that was designed to ensure consistency in reporting and facilitate data verification, data validation, and database development.
 - ▶ **Intercomparison Studies** – USEPA conducted studies to compare performance among different PIs analyzing similar samples. The studies were used to evaluate the comparability and accuracy of program data.
 - ▶ **Technical Systems Audits** – During the study, USEPA formally audited each PI's laboratory for compliance with their QAPPs, the overall study objectives, and pre-determined standards of good laboratory practice.
 - ▶ **Data Verification** – PIs and the USEPA evaluated project data against pre-determined MQOs and DQOs to ensure that only data of acceptable quality would be included in the program database.
 - ▶ **Statistical Assessments** – USEPA made statistical assessments of the LMMBP data to estimate elements of precision, bias, and uncertainty.
 - ▶ **Data Validation** – USEPA and modelers evaluated the data against the model objectives.
- Comparability of data among PIs participating in the LMMBP was deemed to be important for successful completion of the study. Therefore, MQOs for several data attributes were developed by the PIs and defined in the QAPPs. MQOs were designed to control various phases of the measurement process and to ensure that the total measurement uncertainty was within the ranges prescribed by the DQOs. MQOs were defined in terms of six attributes:
- ▶ **Sensitivity/Detectability** – The determination of the low-range critical value that a method-specific procedure can reliably discern for a given pollutant. Sensitivity measures included, among others, method detection limits (MDLs) as defined in 40 CFR Part 136, system detection limits (SDLs), or instrument detection limits (IDLs).
 - ▶ **Precision** – A measure of the degree to which data generated from replicate or repetitive measurements differ from one another. Analysis of duplicate samples was used to assess precision.
 - ▶ **Bias** – The degree of agreement between a measured and actual value. Bias was expressed in terms of the recovery of an appropriate standard reference material or spiked sample.
 - ▶ **Completeness** – The measure of the number of samples successfully analyzed and reported compared to the number that were scheduled to be collected.

-
- ▶ **Comparability** – The confidence with which one data set can be compared to other data sets.
 - ▶ **Representativeness** – The degree to which data accurately and precisely represent characteristics of a population, parameter variations at a sampling point, a process condition, or an environmental condition.

The PI-defined MQOs also were used as the basis for the data verification process. GLNPO conducted data verification through the LMMBP QA Workgroup. The workgroup was chaired by GLNPO's Quality Assurance Manager and consisted of QC Coordinators that were responsible for conducting review of specific data sets. Data verification was performed by comparing all field and QC sample results produced by each PI with their MQOs and with overall LMMBP objectives. If a result failed to meet predefined criteria, the QC Coordinator contacted the PI to discuss the result, verify that it was correctly reported, and determine if corrective actions were feasible. If the result was correctly reported and corrective actions were not feasible, the results were flagged to inform data users of the failure. These flags were not intended to suggest that data were not useable; rather they were intended to caution the user about an aspect of the data that did not meet the predefined criteria. Data that met all predefined requirements were flagged to indicate that the results had been verified and were determined to meet applicable MQOs. In this way, every data point was assigned one or more validity flags based on the results of the QC checks. GLNPO also derived data quality assessments for each LMMBP data set for a subset of the attributes listed above, specifically sensitivity, precision, and bias. The LMMBP modelers and the LLRS Database Manager also performed data quality assessments prior to inputting data into study models. Such activities included verifying the readability of electronic files, identifying missing data, checking units, and identifying outliers. A detailed description of the QA program is included in The Lake Michigan Mass Balance Project Quality Assurance Report (U.S. Environmental Protection Agency, 2001a). A brief summary of quality implementation and assessment is provided in each of the following parts.

1.1.6 Project Documents and Products

During project planning, LMMBP participants developed study tools including work plans, a methods compendium, QAPPs, and data reporting standards. Through these tools, LMMBP participants documented many aspects of the study including information management and QA procedures. Many of these documents are available on GLNPO's website at <http://www.epa.gov/glnpo/lmmb>.

The LMMBP Work Plan

Designers of the LMMBP have documented their approach in a report entitled Lake Michigan Mass Budget/Mass Balance Work Plan (U.S. Environmental Protection Agency, 1997a). The essential elements of a mass balance study and the approach used to measure and model these elements in the Lake Michigan system are described in the work plan. This document was developed based upon the efforts of many Federal and State scientists and staff who participated in the initial planning workshop, as well as PIs.

QA Program/Project Plans

The Lake Michigan Mass Balance Project: Quality Assurance Plan for Mathematical Modeling, Version 3.0 (Richardson *et al.*, 2004) documents the quality assurance process for the development and application of LMMBP models, including hydrodynamic, sediment transport, eutrophication, transport chemical fate, and food chain bioaccumulation models.

The Enhanced Monitoring Program QA Program Plan

The Enhanced Monitoring Program Quality Assurance Program Plan (U.S. Environmental Protection Agency, 1997b) was developed in 1993 to ensure that data generated from the LMMBP supported its intended use.

The LMMBP Methods Compendium

The Lake Michigan Mass Balance Project Methods Compendium (U.S. Environmental Protection Agency, 1997c, 1997d) describes the sampling and analytical methods used in the LMMBP. The entire

three volumes are available on GLNPO's website mentioned above.

The LMMBP Data Reporting Formats and Data Administration Plan

Data management for the LMMBP was a focus from the planning stage through data collection, verification, validation, reporting, and archiving. The goal of consistent and compatible data was a key to the success of the project. The goal was met primarily through the development of standard formats for reporting environmental data. The data management philosophy is outlined on the LMMBP website mentioned above.

Lake Michigan LaMP

"Annex 2" of the 1972 Canadian-American Great Lakes Water Quality Agreement (amended in 1978, 1983, and 1987) prompted development of a Lake-wide Area Management Plan (LaMP) for each Great Lake. The purpose of these LaMPs is to document an approach to reducing input of critical pollutants to the Great Lakes and restoring and maintaining Great Lakes integrity. The Lake Michigan LaMP calls for basin-wide management of toxic chemicals.

GLENDa Database

Central to the data management effort is a computerized data system to house LMMBP and other project results. That system, the Great Lakes Environmental Monitoring Database (GLENDa), was developed to provide data entry, storage, access, and analysis capabilities to meet the needs of mass balance modelers and other potential users of Great Lakes data.

References

Richardson, W.L., D.D. Endicott, R.G. Kreis, Jr., and K.R. Rygwelski (Eds.). 2004. The Lake Michigan Mass Balance Project Quality Assurance Plan for Mathematical Modeling. Prepared by the Modeling Workgroup. U.S. Environmental Protection Agency, Office of Research and Development, National Health and Environmental Effects Research Laboratory, MED-Duluth, Large Lakes Research Station, Grosse Ile, Michigan. EPA/600/R-04/018, 233 pp.

U.S. Environmental Protection Agency. 1995a. National Primary Drinking Water Regulations, Contaminant Specific Fact Sheets, Inorganic Chemicals, Technical Version. U.S. Environmental Protection Agency, Office of Water, Washington, D.C. EPA/811/F-95/002-T.

U.S. Environmental Protection Agency. 1995b. National Primary Drinking Water Regulations, Contaminant Specific Fact Sheets, Synthetic Organic Chemicals, Technical Version. U.S. Environmental Protection Agency, Office of Water, Washington, D.C. EPA/811/F-95/003-T.

U.S. Environmental Protection Agency. 1997a. Lake Michigan Mass Budget/Mass Balance Work Plan. U.S. Environmental Protection Agency, Great Lakes National Program Office, Chicago, Illinois. EPA/905/R-97/018, 155 pp.

U.S. Environmental Protection Agency. 1997b. The Enhanced Monitoring Program Quality Assurance Program Plan. U.S. Environmental Protection Agency, Great Lakes National Program Office, Chicago, Illinois. EPA/905/R-97/017, 61 pp.

U.S. Environmental Protection Agency. 1997c. Lake Michigan Mass Balance Study (LMMB) Methods Compendium, Volume 1: Sample Collection Techniques. U.S. Environmental Protection Agency, Great Lakes National Program Office, Chicago, Illinois. EPA/905/R-97/012a, 1,440 pp.

U.S. Environmental Protection Agency. 1997d. Lake Michigan Mass Balance Study (LMMB) Methods Compendium, Volume 2: Organic and Mercury Sample Analysis Techniques. U.S. Environmental Protection Agency, Great Lakes National Program Office, Chicago, Illinois. EPA/905/R-97/012b, 532 pp.

U.S. Environmental Protection Agency. 1999. National Recommended Water Quality Criteria-Correction. U.S. Environmental Protection Agency, Office of Water, Washington, D.C. EPA/822/Z-99/001, 25 pp.

U.S. Environmental Protection Agency. 2001a. The Lake Michigan Mass Balance Study Quality Assurance Report. U.S. Environmental Protection Agency, Great Lakes National Program, Chicago, Illinois. EPA/905/R-01/013.

U.S. Environmental Protection Agency. 2001b. Ambient Aquatic Life Water Quality for Atrazine. U.S. Environmental Protection Agency, Office of Water, Washington, D.C. EPA/822/D-01/002, 230 pp.

PART 1

INTRODUCTION

Chapter 2. PCBs Modeling Overview

Douglas D. Endicott
Great Lakes Environmental Center
Traverse City, Michigan
and
William L. Richardson
Retired
and
Ronald Rossmann
U.S. Environmental Protection Agency
Office of Research and Development
National Health and Environmental Effects
Research Laboratory
Mid-Continent Ecology Division
Large Lakes and Rivers Forecasting Research
Branch
Large Lakes Research Station
9311 Groh Road
Grosse Ile, Michigan 48138

1.2.1 Background

The mass balance project was based upon the Enhanced Monitoring Program (EMP), a comprehensive, two-year synoptic survey for selected toxic chemicals in the Lake Michigan ecosystem. The EMP included tributary load and atmospheric deposition monitoring; ambient water column, biota, and sediment sampling; and additional measurements to define and confirm transport and fate processes. The toxics studied for the Lake Michigan Mass Balance Project (LMMBP) included polychlorinated biphenyls (PCBs), atrazine, *trans*-nonachlor, and mercury. The project was led by the United States Environmental Protection Agency

(USEPA)/Great Lakes National Program Office (GLNPO). Modeling support to the project was provided by the USEPA/Mid-Continent Ecology Division (MED)/Office of Research and Development (ORD)/Large Lakes Research Station (LLRS) in cooperation with the Atmospheric Research and Exposure Assessment Laboratory (AREAL); the National Oceanic and Atmospheric Administration (NOAA)/Great Lakes Environmental Research Laboratory (GLERL); and other cooperators. The research developed a suite of integrated mass balance models to simulate the transport, fate, and bioaccumulation of toxic chemicals in Lake Michigan.

1.2.2 Modeling Objectives

Development of effective strategies for toxics management requires a quantitative understanding of the relationships between sources, inventories, concentrations, and effects of contaminants in the ecosystem. A mass balance modeling approach was used to address the relationship between sources of toxic chemicals and concentrations in air, water, sediment, and biota. This approach integrated load estimation, ambient monitoring, and research efforts within a modeling framework that was compatible with both scientific as well as ecosystem management objectives. The mass balance approach estimated the magnitude of mass fluxes that constitute the pathways for toxics transport into and out of the lake, that distribute toxics within the lake water column and sediment, and that lead to bioaccumulation of the aquatic food webs. Based upon these estimates, the mass balance was used to determine the rate of change in concentrations and inventories of toxics as inputs such as atmospheric

and tributary loadings change. Thus, the mass balance can serve as a useful tool to estimate or predict the outcome of alternatives under consideration for toxics management.

Modeling efforts associated with the LMMBP had the following objectives:

1. Provide a consistent framework for integrating load estimates, ambient monitoring data, process research efforts, and prior modeling efforts, leading to a better understanding of toxic chemical sources, transport, fate, and bioaccumulation in Lake Michigan.
2. Estimate the loading of priority toxics, solids, and nutrients from all major tributaries to Lake Michigan for the duration of the study.
3. Estimate the atmospheric deposition and air-water exchange of priority toxics, including spatial and temporal variability over Lake Michigan.
4. Calibrate and confirm mass balance models for priority toxics using project data, based upon models for hydrodynamic and sediment transport, eutrophication/organic carbon dynamics, toxics transport and fate, and food web bioaccumulation.
5. Based upon the mass balance models, evaluate the magnitude and variability of toxic chemical fluxes within and between lake compartments, especially between the sediment and water column and between the water column and the atmosphere.
6. Apply the calibrated mass balance models to forecast contaminant concentrations in water and sediment throughout Lake Michigan, based upon meteorological forcing functions and future loadings based upon load reduction alternatives.
7. Predict the bioaccumulation of persistent toxic chemicals through the food web leading to top predator fish (lake trout and coho salmon) for location-specific fish populations in the lake, in order to relate mass balance predictions of water and sediment exposure to this significant impaired use.

8. Estimate (quantify) the uncertainty associated with estimates of tributary and atmospheric loads of priority toxics, and model predictions of contaminant concentrations.
9. Identify and prioritize further monitoring, modeling, and research efforts to (1) address additional toxic substances, (2) further reduce uncertainty and improve accuracy of predictions, (3) establish additional cause-effect linkages, such as ecological risk endpoints and feedbacks, and (4) evaluate additional source categories, such as non-point sources in the watershed.

The purpose of PCBs modeling was to simulate their transport, fate, and bioaccumulation in Lake Michigan. PCBs are a group of persistent, bioaccumulative hydrophobic organic chemicals (HOCs) that are ubiquitous in the Great Lakes. Although anthropogenic inputs from production and disposal largely ceased following their ban in the 1970s, atmospheric and watershed tributary transport pathways to the lake continue the import of PCBs. In addition, a large in-lake sediment inventory represents an internal source of PCBs, which are recycled annually. PCBs have been consistently identified as the contaminant of greatest concern to human and ecosystem health in the Great Lakes (Ludwig *et al.*, 1993; Swain, 1991; Gilbertson *et al.*, 1991).

1.2.3 Historical Modeling

The modeling design and approach for the LMMBP reflects a progression of prior modeling efforts in Lake Michigan and throughout the Great Lakes. These include eutrophication and toxic substance mass balance models, food web bioaccumulation models, and predictive hydrodynamic and sediment transport models. Although not a comprehensive review, several of these prior modeling efforts are discussed below.

1.2.3.1 Lake-1

A eutrophication model for Lake Michigan was developed by Rodgers and Salisbury (1981), based upon the Lake-1 model which was also applied to Lakes Erie, Huron, and Ontario. The model was calibrated and tested using data from 1976 and 1977.

The importance of climatic factors on limnological (including eutrophication) processes in Lake Michigan was demonstrated, as the severe winter and extensive ice cover of 1976-1977 dramatically reduced total phosphorus concentrations in the second year. This work also identified several refinements necessary for accurate modeling of eutrophication: phosphorus availability to phytoplankton and particle transport including shoreline erosion and sediment resuspension were apparently significant influences upon nutrient and phytoplankton dynamics observed in Lake Michigan.

1.2.3.2 Completely-Mixed Model

A lakes-in-series model for conservative substances was developed by Sonzogni *et al.* (1983) and applied to forecast chloride concentrations in each of the Great Lakes as a function of expected future loadings. This model demonstrated that concentrations of non-reactive substances would substantially “lag” the history of their input. This was especially the case for Lake Michigan, where maximum chloride concentrations were not predicted to occur until the 22nd Century despite declining loads after the 1970s. Similarly strong, non-steady-state behavior may be expected for other chemicals which are non-reactive and weakly associated to particles.

1.2.3.3 General Mass Balance Framework for Toxic Chemicals in the Great Lakes

At about the same time, models were being developed which would serve as the foundation for describing and simulating the transport and fate of hydrophobic chemicals in the Great Lakes. Thomann and Di Toro (1983) and Robbins (1985) demonstrated that the lake-wide, annual concentration trend of contaminants including cesium-137, plutonium-239/240, and PCBs, were dependent upon particle transport between the water column and a resuspendable sediment compartment. The principal loss mechanisms from the lakes were found to be burial by sedimentation and (for PCBs) volatilization. The somewhat paradoxical behavior of these models was that the water column contaminant dynamics were largely controlled by sediment parameters.

1.2.3.4 Food Web Bioaccumulation Model

A food web bioaccumulation model was developed by Thomann and Connolly (1984) and applied to simulate bioaccumulation of PCBs in Lake Michigan lake trout. The model was confirmed with an extensive data set collected in 1971, including nine age classes of trout, diet characterization by gut contents analysis, and alewife. The model was successful in predicting bioaccumulation for mature age classes of lake trout, although not for juveniles. Dietary transfer was demonstrated to be the predominant route of PCBs accumulation, in comparison to direct chemical uptake from water. Substantial residual variance in lake trout PCBs concentrations within age class $CV = 1$ was not explained by this lake-wide, average-individual model.

1.2.3.5 MICHTOX

An integrated mass balance and bioaccumulation model for PCBs (modeled as two homologs) and 10 other toxic chemicals was developed as a planning tool for the LMMBP (Endicott *et al.*, 2005). The MICHTOX mass balance was calibrated to suspended solids and plutonium data for the southern lake basin, while the bioaccumulation model combined Thomann and Connolly’s (1984) effort with chemical-specific parameterization from Lake Ontario. MICHTOX demonstrated that reasonable predictions of PCB concentration trends in water, sediment, and biota could be developed although significant uncertainties regarding sediment-water and air-water contaminant transport remained. These are the most significant transport fluxes for PCBs and presumably other hydrophobic contaminants. Major data gaps for other priority toxics allowed only order-of-magnitude estimates of load-concentration relationships. When this model was developed and run, available monitoring data for toxic chemical concentration in tributaries, air, lake water, sediment, and biota were not adequate to define loading trends or to relate the distribution of loadings to contaminant gradients observed for sediment and biota. Credible model predictions of toxic chemical transport, fate, and bioaccumulation would depend upon developing a comprehensive data set quantifying loadings, sediment inventories,

concentrations, and transport fluxes on a spatially-resolved basis, and localized descriptions of food web structures.

1.2.3.6 Green Bay Mass Balance Project

The Green Bay Mass Balance Project (GBMBP) demonstrated the feasibility of applying mass balance principles to manage toxic chemicals in the Great Lakes ecosystem. A two-year (1989-1990) synoptic sampling program was designed to collect appropriate and complete data for the mass balance study. A suite of integrated mass balance and bioaccumulation models were developed which, together, provided an ecosystem-level simulation of sources, transport, fate, and bioaccumulation of PCBs throughout the Fox River and Green Bay. This study advanced the state-of-the-art of mass balance modeling, particularly the ability to construct a fairly complete and accurate description of contaminant mass transport.

Several aspects of the Green Bay modeling effort were noteworthy. Particle transport and sorption processes were found to be of fundamental importance as bases for contaminant modeling. Resuspension of contaminated sediments in the Fox River constituted the major source of PCBs to the river as well as the bay. In the bay, particle sorbent dynamics were strongly affected by phytoplankton production and decay. The relative significance of hydraulic transport, sediment transport, burial, volatilization, and open lake boundary exchange processes upon the PCBs mass balance varied considerably with location in Green Bay. Radionuclide tracers were again essential for calibration of particle fluxes and confirmation of long-term contaminant transport predictions. The significance of contaminant accumulation at the base of the food web, and fish movement in relation to exposure gradients, were demonstrated in the bioaccumulation model. The LMMBP demonstrated the linked submodel approach to ecosystem model development and application, and the feasibility of using such a model for assessing the effectiveness of toxics management control alternatives.

1.2.3.7 SEDZL

The Green Bay Mass Balance Project (GBMBP) also provided data to test a predictive two-dimensional, hydrodynamic and sediment transport model of the Fox River, SEDZL (Gailani *et al.*, 1991). SEDZL incorporates realistic descriptions of cohesive sediment resuspension, flocculation, and deposition processes, and contaminant sorption, which are critical for accurate prediction of hydrophobic contaminant transport. These process descriptions were based on laboratory and field experiments with river, bay, and lake sediments. A three-dimensional bed submodel was used to describe sediment bed properties which varied with depth as well as location. The fine spatial resolution of the model allowed detailed simulation of in-place pollutant transport in both the water column and sediment bed. Although computationally intensive and requiring specialized data, SEDZL has substantially advanced the state-of-the-art for sediment and contaminant transport modeling in the Great Lakes. SEDZL had also been applied to the Buffalo and Saginaw Rivers as part of the ARCS/RAM project (Gailani *et al.*, 1994; Cardenas and Lick, 1996). These applications included long-term forecasts (10-25 years) of sediment and contaminant transport. SEDZL had also been applied to large water bodies such as Lake Erie, and marine coastal waters including Santa Barbara Channel, and Atchafalaya Bay (Lick *et al.*, 1994; Pickens, 1992) where wave action as well as currents force sediment resuspension.

1.2.4 Model Resolution

Model resolution is the spatial and temporal scale of predictions, as well as the definitions of model state variables. While factors such as data availability, model sophistication, and computer resources constrain resolution to a degree, different levels of model resolution are possible and, are in fact, necessary. Three "levels" of spatial resolution, indicated by the segmentation grid of the lake surface, are illustrated in Figure 1.2.1. Level 1 was resolved at the scale of lake basins (characteristic length, $L = 150$ km), with an associated seasonal temporal resolution. This was a screening-level model resolution used in MICHTOX. Level 2 was

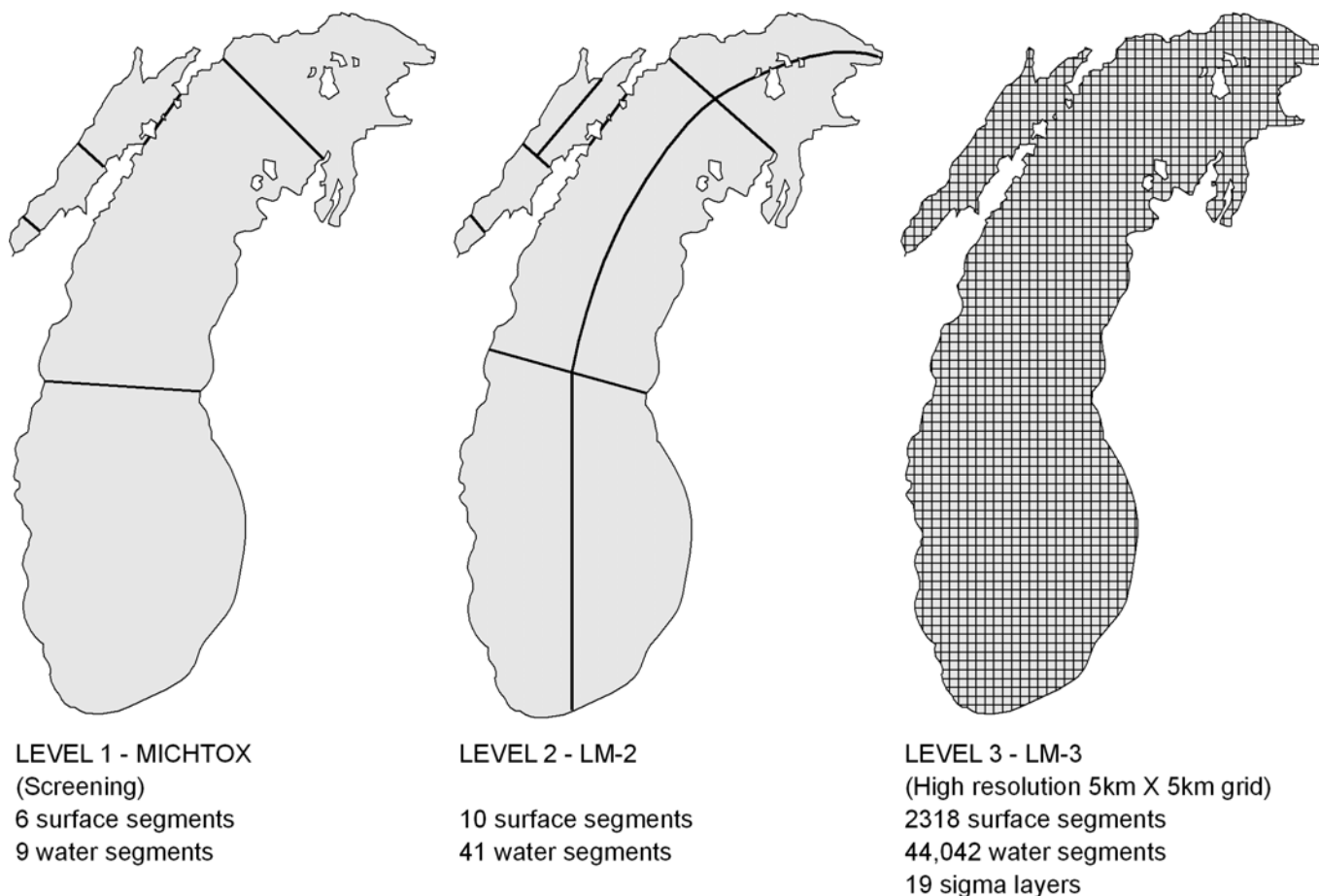

Figure 1.2.1. Surface water segmentation for alternative Lake Michigan mass balance model levels.

resolved at a regional scale defined by food webs ($L = 40$ km) including gross resolution of the nearshore and offshore regions; temporal resolution was weekly-to-monthly. This resolution was roughly comparable to that achieved by models developed in the GBMBP. Level 3 was a hydrodynamic scale resolution ($L = 5$ km), with associated daily temporal resolution. Level 3 was scaled to resolve and predict particle transport processes as well as hydrodynamic transport.

Although the Lake-wide Management Plan (LaMP) and the Great Waters Program objectives are “lake-wide,” both of these emphasize biotic impairments occurring primarily in localized, nearshore regions. LaMP objectives also require that the transport of contaminants from tributaries and other nearshore sources to the open lake be resolved. Therefore, the

Level 1 model was not adequate for the study objectives. Level 2 resolution was adequate for most modeling objectives, but not for resolution of significant hydrodynamic and sediment transport events. Level 3 resolution was required for accurate hydrodynamic and sediment transport modeling and was desirable for predicting nearshore gradients, especially those formed by transients such as thermal bars, upwelling, and storm-induced resuspension; as well as more persistent features such as tributary plumes, thermal stratification, and the benthic nepheloid layer. Level 3 transport resolution was also valuable in relating toxics loading from the 10 Areas of Concern (AOCs) adjoining Lake Michigan, which must be addressed by the Remedial Action Plan (RAP) process, to the LaMP via the LMMBP.

The modeling design for the LMMBP was based on the development of a number of models at three levels of resolution. For the contaminant transport and fate (CTF) models, MICTOX was resolved at Level 1, and LM2-Toxic was resolved at Level 2. For the eutrophication models, MICH1 was resolved at Level 1 and LM3-Eutro was resolved at Level 3. The Princeton Ocean Model (POM) and atmospheric loading models were resolved at Level 3. Results of the hydrodynamic model were spatially and temporally averaged prior to coupling to the Level 2 model. The rationale for specifying different resolutions was the hydrodynamic models require a Level 3 resolution to offer the best capability for transport simulation and forecasting. A lower resolution was specified for LM2-Toxic because this model had been demonstrated at this resolution.

1.2.5 Models Developed and Applied

The model design for the LMMBP was based upon the linked submodel approach used in the GBMBP. Models developed, refined, and applied by the Large Lakes and Rivers Forecasting Research Branch (LLRFRB) included eutrophication/sorbent dynamics (MICH1 and LM3-Eutro), contaminant transport and fate (MICTOX and LM2-Toxic), and food web bioaccumulation (LM Food Chain) models (Figure 1.2.2). Models developed and run elsewhere included a hydrodynamics model (POM) (Schwab and Beletsky, 1998), an atmospheric loading model (Green *et al.*, 2000; Miller *et al.*, 2001), and a tributary loading model (Hall and Robertson, 1998). Only the models developed, refined, and applied at LLRFRB will be discussed in detail within this document.

1.2.5.1 Lake Process Models

The mass balance for toxics in Lake Michigan was comprised of linked hydrodynamic (POM), eutrophication/sorbent dynamics (LM3-Eutro), contaminant transport and transformation (LM2-Toxic), and bioaccumulation simulations (LM Food Chain). In addition, Level 1 eutrophication/sorbent dynamics (MICH1) and contaminant transport and transformation/bioaccumulation (MICTOX) simulations were run for comparison to Level 3 and 2 results, respectively. Each of these models represented significant processes affecting the mass balance for toxic chemicals. The hydrodynamic

model predicted water movements necessary to describe the three-dimensional transport of dissolved and particulate constituents in the water column. The eutrophication models described the production, respiration, grazing, and decomposition of planktonic biomass within the lake. The contaminant transport and fate models described contaminant partitioning between dissolved and sorbed phases, mass transfer between media (air, water, sediment), and biogeochemical transformations. The bioaccumulation models simulated contaminant accumulation from water and sediments to predator fish *via* direct exposure and trophic transfer through benthic and pelagic food webs. Together, these submodels formed an integrated description of toxic chemical cycling in the aquatic ecosystem with which to predict the relationship between loadings and concentrations of PCBs.

1.2.5.2 Hydrodynamics (POM)

The Princeton Ocean Model (POM) (Blumberg and Mellor, 1980, 1987) was used to compute three-dimensional current fields in the lake. The POM simulated large- and medium (km)-scale circulation patterns, vertical stratification and velocity distribution, seiche, and surface waves. This model was also used to simulate a thermal balance for the lake. The POM is a primitive equation, numerical hydrodynamic circulation model that predicts three-dimensional water column transport in response to wind stress, temperature, barometric pressure, and Coriolis force. The POM has been demonstrated to accurately simulate the predominant physics of large water bodies (Blumberg and Mellor, 1983, 1985; Blumberg and Goodrich, 1990). This model was used to develop year-long simulations on a 5 km horizontal grid, with nine sigma vertical layers, at one-hour intervals for Lake Michigan (Schwab and Beletsky, 1998). Observed and simulated meteorological data were used to define model forcing functions. Extensive measurements of temperature and current distributions collected in Lake Michigan during 1982-1983 were used to provide the necessary data for model calibration; measurements of daily surface temperature and current distributions were used to confirm hydrodynamic simulations for 1994-1995.

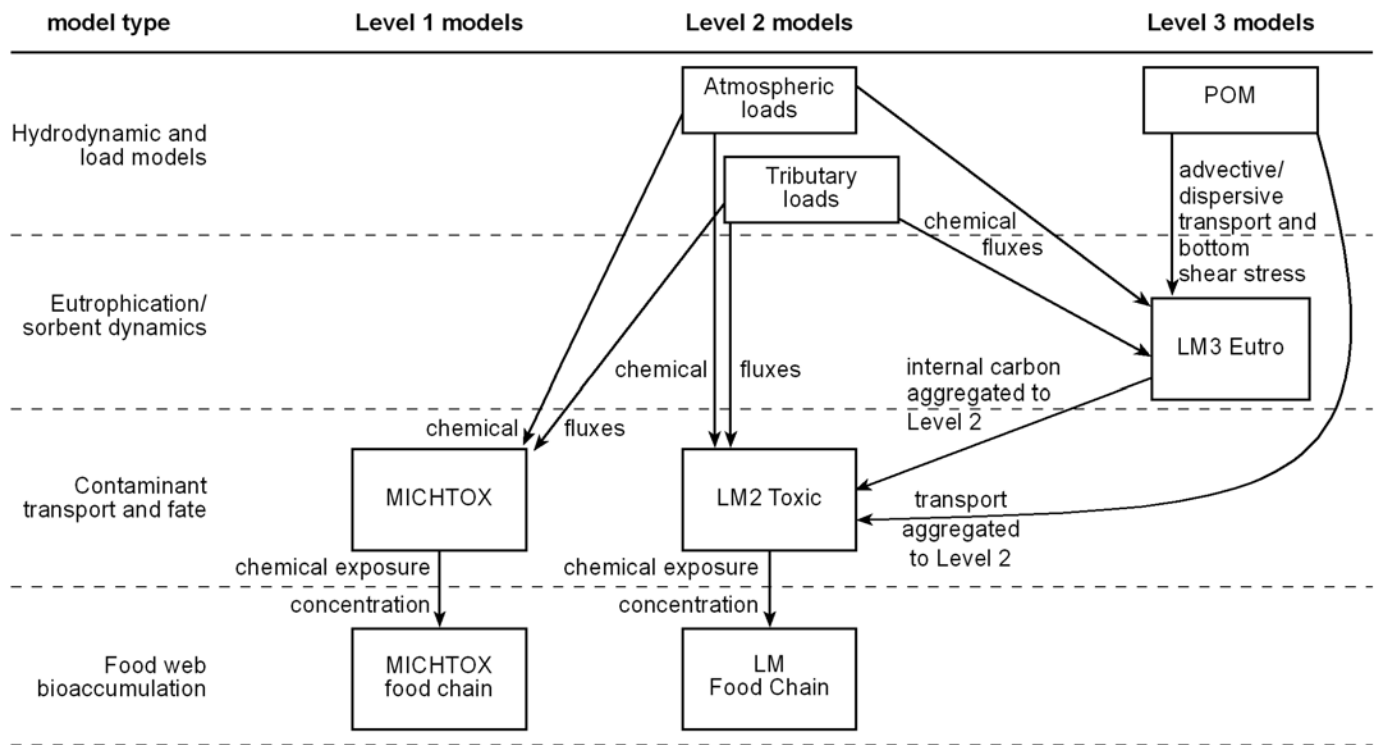

Figure 1.2.2. Model construct used for the LMMBP to model PCBs.

1.2.5.3 Eutrophication/Sorbent Dynamics (LM3-Eutro)

The eutrophication/sorbent dynamics (LM3-Eutro) model predicted the production, transformation, and decay of plankton biomass in response to seasonal dynamics of temperature, light, and nutrient concentrations. In the open lake, living and dead plankton comprise the majority of suspended particles and generate significant autochthonous loads of particulate and dissolved organic carbon (POC and DOC) to which PCBs and other contaminants preferentially partition (Richardson *et al.*, 1983; DePinto *et al.*, 1993). LM3-Eutro simulated the non-conservative, seasonally-variable dynamics of the biotic organic pool, which has a significant influence upon partitioning of HOCs (Dean *et al.*, 1993). A similar, less resolute model was applied to simulate the dynamics of organic carbon states in Green Bay as part of the GBMBP (DePinto *et al.*, 1993). Model outputs included autochthonous solids

loads and transformation and decay rates that were used as inputs for LM2-Toxic.

1.2.5.4 Contaminant Transport and Fate (LM2-Toxic)

The mass balance for toxic chemicals in the lake was computed in a contaminant transport and fate model (LM2-Toxic) which described contaminant transport, intermedia exchange, phase distribution, and biogeochemical transformations in both the water column and sediments. LM2-Toxic was calibrated and confirmed for selected individual congeners and the sum of PCBs congeners. Mass balance analyses were performed for total PCBs to evaluate the significant source, transport, and loss pathways. The effectiveness of alternative load reduction scenarios upon reducing total PCB concentrations were forecast.

1.2.5.5 Food Web Bioaccumulation (LM Food Chain)

A bioaccumulation model simulated chemical accumulation in the food web in response to chemical exposure, based upon chemical mass balances for aquatic biota. The general form of the bioaccumulation equation was well-defined, and equated the rate of change in chemical concentration within a fish (or other aquatic organism) to the sum of chemical fluxes into and out of the animal. These fluxes included direct uptake of chemical from water, the flux of chemical into the animal through feeding, and the loss of chemical due to elimination (desorption and excretion) and dilution due to growth. To predict bioaccumulation for top predator fish, the bioaccumulation mass balance was repeatedly applied to animals at each trophic level to simulate chemical biomagnification from primary and secondary producers, through forage species to top predators. Food web bioaccumulation models have been successfully applied for PCBs and other HOCs in several large-scale aquatic ecosystems (Thomann and Connolly, 1984; Connolly and Tonelli, 1985) and, most recently, for the GBMBP (Connolly *et al.*, 1992). The model developed for that project, FDCHN, was adapted for use in Lake Michigan (LM Food Chain). FDCHN is a time-variable, population-based age class model, incorporating realistic descriptions of bioenergetic, trophodynamic, and toxicokinetic processes. The general features of FDCHN were well-suited to a modeling application such as the LMMBP. For Lake Michigan, bioaccumulation of PCB congeners was modeled for lake trout and coho salmon food webs. Food web bioaccumulation was simulated for sub-populations of lake trout in three distinct biotic zones.

1.2.6 Model Quality Assurance

A Quality Assurance Project Plan (QAPP) was prepared and implemented for the PCBs modeling (Richardson *et al.*, 2004). The QAPP specified procedures for code development, testing, modification, and documentation; as well as methods and measures applied in model calibration, confirmation, and uncertainty analysis.

1.2.7 Model Application and Computational Aspects

1.2.7.1 Annual Simulations

Annual simulations were run with the models for the period of 1994-1995. Results were analyzed in terms of regional and lake-wide contaminant loads, fluxes and inventories, and spatial and temporal gradients of contaminant concentrations. Bioaccumulation simulations were analyzed in terms of relative accumulation pathways, spatial and temporal variability of contaminant concentration ratios (bioconcentration factor, bioaccumulation factor, biota/sediment accumulation factor, predator/prey), and influence of diet, age, and migration factors.

1.2.7.2 Long-Term Simulations

Long-term simulations were used to forecast the impact of various management scenarios. Forecasts were performed to determine time to steady-state for both continuing and discontinued loads. Forecasts were also run to evaluate reductions in exposure concentrations resulting from elimination of tributary and/or atmospheric loading. These forecasts were propagated through the food web bioaccumulation model for PCBs to estimate time for sport fish contaminant concentrations to decline below criteria limits.

References

- Blumberg, A.F. and G.L. Mellor. 1980. A Coastal Ocean Numerical Model. In: J. Sunderman and K.P. Holtz (Eds.), *Mathematical Modeling of Estuarine Physics*, pp. 203-214, Proceedings of the International Symposium, Hamburg, Germany, August 1978.
- Blumberg, A.F. and G.L. Mellor. 1983. Diagnostic and Prognostic Numerical Circulation Studies of the South Atlantic Bight. *J. Geophys. Res.*, 88(C8):4579-4592.
- Blumberg, A.F. and G.L. Mellor. 1985. A Simulation of the Circulation in the Gulf of Mexico. *Israel J. Earth Sci.*, 34:122-144.

-
- Blumberg, A.F. and G.L. Mellor. 1987. A Description of a Three-Dimensional Coastal Ocean Circulation Model. In: N.S. Heaps (Ed.), Three-Dimensional Coastal Ocean Models, Coastal and Estuarine Sciences, pp. 1-16. American Geophysical Union, Washington, D.C.
- Blumberg, A.F. and D.M. Goodrich. 1990. Modeling of Wind-Induced Destratification in Chesapeake Bay. *Estuaries*, 13:1236-1249.
- Cardenas, M. and W. Lick. 1996. Modeling the Transport of Sediment and Hydrophobic Contaminants in the Lower Saginaw River. *J. Great Lakes Res.*, 22(3):669-682.
- Connolly, J.P. and R. Tonelli. 1985. Modeling Kepone in the Striped Bass Food Chain of the James River Estuary. *Estuarine Coast. Shelf Sci.*, 20:349-366.
- Connolly, J.P., T.F. Parkerton, J.D. Quadrini, S.T. Taylor, and A.J. Thurmann. 1992. Development and Application of PCBs in the Green Bay, Lake Michigan Walleye and Brown Trout and Their Food Webs. Report to the U.S. Environmental Protection Agency, Office of Research and Development, ERL-Duluth, Large Lakes Research Station, Grosse Ile, Michigan. 300 pp.
- Dean, K.E., M.M. Shafer, and D.E. Armstrong. 1993. Particle-Mediated Transport and Fate of a Hydrophobic Organic Contaminant in Southern Lake Michigan: The Role of Major Water Column Particle Species. *J. Great Lakes Res.*, 19(2):480-496.
- DePinto, J.V., R. Raghunathan, P. Sierzenga, X. Zhang, V.J. Bierman, Jr., P.W. Rodgers, and T.C. Young. 1993. Recalibration of GBTOX: An Integrated Exposure Model for Toxic Chemicals in Green Bay, Lake Michigan. Final Report. U.S. Environmental Protection Agency, Office of Research and Development, ERL-Duluth, Large Lakes Research Station, Grosse Ile, Michigan. 132 pp.
- Endicott, D.D., W.L. Richardson, and D.J. Kandt. 2005. 1992 MICHTOX: A Mass Balance and Bioaccumulation Model for Toxic Chemicals in Lake Michigan. In: R. Rossmann (Ed.), MICHTOX: A Mass Balance and Bioaccumulation Model for Toxic Chemicals in Lake Michigan, Part 1. U.S. Environmental Protection Agency, Office of Research and Development, National Health and Environmental Effects Research Laboratory, MED-Duluth, Large Lakes Research Station, Grosse Ile, Michigan. EPA/600/R-05/158, 140 pp.
- Gailani, J., C.K. Ziegler, and W. Lick. 1991. Transport of Suspended Solids in the Lower Fox River. *J. Great Lakes Res.*, 17(4):479:494
- Gailani, J.Z., W. Lick, M.K. Pickens, C.K. Ziegler, and D.D. Endicott. 1994. Sediment and Contaminant Transport in the Buffalo River. U.S. Environmental Protection Agency, Office of Research and Development, ERL-Duluth, Large Lakes Research Station, Grosse Ile, Michigan. 54 pp.
- Gilbertson, M., T. Colborn, and A. Duda. 1991. Focus on International Joint Commission Activities, Volume 16, Number 2, July/August 1991, Windsor, Ontario, Canada.
- Green, M.L., J.V. DePinto, C.W. Sweet, and K.C. Hornbuckle, 2000. Regional Spatial and Temporal Interpolation of Atmospheric PCBs: Interpretation of Lake Michigan Mass Balance Data. *Environ. Sci. Technol.*, 34(9):1833-1841.
- Hall, D. and D. Robertson. 1998. Estimation of Contaminant Loading from Monitored and Unmonitored Tributaries to Lake Michigan for the USEPA Lake Michigan Mass Balance Study. Quality Systems and Implementation Plan. Submitted October 23, 1998. U.S. Environmental Protection Agency, Great Lakes National Program Office, Chicago, Illinois. 19 pp.
- Lick, W., J. Lick, and C.K. Ziegler. 1994. The Resuspension and Transport of Fine-Grained Sediments in Lake Erie. *J. Great Lakes Res.*, 20(4):599-612.

-
- Ludwig, J.P., J.P. Giesy, C.L. Summer, W. Bowerman, R. Aulerich, S. Bursian, H.J. Auman, P.D. Jones, L.L. Williams, D.E. Tillett, and M. Gilbertson. 1993. A Comparison of Water Quality Criteria for the Great Lakes Based on Human and Wildlife Health. *J. Great Lakes Res.*, 19(4):789-807.
- Miller, S.M., M.L. Green, J.V. DePinto, and K.C. Hornbuckle. 2001. Results from the Lake Michigan Mass Balance Study: Concentrations and Fluxes of Atmospheric Polychlorinated Biphenyls and *trans*-Nonachlor. *Environ. Sci. Technol.*, 35(2):278-285.
- Pickens, K., C. Donna, M. Chen, J. Lick, and W. Lick. 1992. Sediment Transport in a Stratified Estuary. In: H. Alder and J.C. Heinrich (Eds.), *Numerical Methods in Engineering and Applied Sciences*. Centro Internacional de Metodos Numericos en Ingerieria, Barcelona, Spain.
- Richardson, W.L., V.E. Smith, and R. Wethington. 1983. Dynamic Mass Balance of PCB and Suspended Solids in Saginaw Bay – A Case Study. In: D. Mackay, S. Patterson, and S.J. Eisenreich (Eds.), *Physical Behavior of PCBs in the Great Lakes*, pp. 329-366. Ann Arbor Science Publishers, Ann Arbor, Michigan.
- Richardson, W.L., D.D. Endicott, R.G. Kreis, Jr., and K.R. Rygwelski (Eds.). 2004. *The Lake Michigan Mass Balance Project Quality Assurance Plan for Mathematical Modeling*. Prepared by the Modeling Workgroup. U.S. Environmental Protection Agency, Office of Research and Development, National Health and Environmental Effects Research Laboratory, MED-Duluth, Large Lakes Research Station, Grosse Ile, Michigan. EPA/600/R-04/018, 233 pp.
- Robbins, J.A. 1985. *The Coupled Lakes Model for Estimating the Long-Term Response of the Great Lakes to Time-Dependent Loadings of Particle-Associated Contaminants*. National Oceanic and Atmospheric Administration, Great Lakes Environmental Research Laboratory, Ann Arbor, Michigan. NOAA Technical Memorandum ERL GLERL-57, 41 pp.
- Rodgers, P.W. and D. Salisbury. 1981. Water Quality Modeling of Lake Michigan and Consideration of the Anomalous Ice Cover of 1976-1977. *J. Great Lakes Res.*, 7(4):467-480.
- Schwab, D. and D. Beletsky. 1998. *Lake Michigan Mass Balance Study: Hydrodynamic Modeling Project*. National Oceanic and Atmospheric Administration, Great Lake Environmental Research Laboratory, Ann Arbor, Michigan. NOAA Technical Memorandum ERL GLERL-108, 53 pp.
- Sonzogni, W.C., W. Richardson, P. Rodgers, and T.J. Monteith. 1983. Chloride Pollution of the Great Lakes. *Water Pollut. Contr. Fed. J.*, 55(5):513-521.
- Swain, W.R. 1991. Effects of Organochlorine Chemicals on the Reproductive Outcome of Humans Who Consumed Contaminated Great Lakes Fish: An Epidemiological Consideration. *J. Toxic. Environ. Health*, 33:587-639.
- Thomann, R.V. and D.M. Di Toro. 1983. Physico-Chemical Model of Toxic Substances in the Great Lakes. *J. Great Lakes Res.*, 9(4):474-496.
- Thomann, R.V. and J.P. Connolly. 1984. An Age Dependent Model of PCB in a Lake Michigan Food Chain. U.S. Environmental Protection Agency, Office of Research and Development, ERL-Duluth, Large Lakes Research Station, Grosse Ile, Michigan. EPA/600/S3-84/026, 3 pp.

PART 1

INTRODUCTION

Chapter 3. Information Management

David A. Griesmer
Computer Sciences Corporation
Large Lakes Research Station
9311 Groh Road
Grosse Ile, Michigan 48138

To support the modeling efforts of the Lake Michigan Mass Balance Project (LMMBP), large amounts of data were collected and analyzed by a number of State and government agencies and universities (Appendix 1.3.1). Data were collected, analyzed, and sent to the United States Environmental Protection Agency (USEPA) Great Lakes National Program Office (GLNPO) in Chicago, Illinois. GLNPO staff, under the direction of Lou Blume, were responsible for quality assurance (QA) assessment, organization, and consolidation of all data. To facilitate the QA assessment process, a SAS application Research Data Management and Quality Assurance System (RDMQ), developed by Syd Allen, a private contractor, was used to automate the QA process (Sukloff, 1995). RDMQ is a menu-driven SAS program. It has capabilities for loading data, applying quality control checks, adding validity flags, viewing and editing data, producing user-defined tables and graphs, and exporting data in ASCII files. These tasks are performed through a set of menu-driven SAS programs and macros. Data which had been put through the assessment process and approved for release by both GLNPO and the Principal Investigator (PI) were then sent to USEPA, Office of Research and Development (ORD)/National Health and Environmental Effects Research (NHEERL)/Large Lakes and Rivers Forecasting

Research Branch (LLRFRB)/Large Lakes Research Station (LLRS) for use by the modeling staff.

1.3.1 Overview of Information Management at the LLRS

Data received from GLNPO were usually in the form of electronic media. Data were typically E-mailed, but sometimes they were downloaded from GLNPO databases or received on CD-ROM. Data were reformatted by GLNPO into a form facilitating entry into database programs at the LLRS. Upon arrival, raw data were copied to the "Immb" folder on Dave Griesmer's personal network space ("n:\") drive). In addition, data were imported into one of several Microsoft Access databases in the "\Access_2000\Immb" folder on Mr. Griesmer's "n:\") drive. The "n:\") drive was used to facilitate data security because this file space is backed up regularly and is only available to Mr. Griesmer. Data were placed in the Microsoft Access databases to facilitate data review/assessment and later retrieval for the modeling team.

Prior to use, several reviews were done of the data received to look for errors in the data sets. At the LLRS, this review was broken up into two parts. First, an initial review was made to check for completeness of information, to look for transcription errors, programming errors, and formatting errors, and to review comments added by collection and analysis personnel. Second, a review was done by the data users to determine if the data made environmental sense. This type of review was conducted for the open lake, surficial sediment and sediment trap, lower food chain, and fish

polychlorinated biphenyl (PCB) data sets. Atmospheric PCB fluxes/loadings and tributary PCB loadings did not go through this review process at the LLRS, but they were assessed by study members assigned with providing loading values. Tributary PCB loading assessment was done by David Hall, U.S. Geological Survey (USGS). All atmospheric PCB loading/concentration data were assessed by Keri Hornbuckle, University of Iowa. The assessment process used by these individuals is unknown.

For data reviewed at LLRS, samples which GLNPO determined had failed the RDMQ QA process were flagged with the value of -9999. GLNPO preserved the values in the data sets that were received and flagged the analytical remark field for that parameter. Flagging these values as -9999 facilitated processing by analytical software such as IDL. Parameter values with analytical remark flags of "INV" (invalid data, as determined by GLNPO QA evaluation), and "NAI" (no result reported - interference) were changed to -9999. Samples with the analytical remark flag of "LAC" (no results reported, laboratory accident) were removed.

Documentation associated with the data was studied. RDMQ data warning fields (RS_NMAND,RS_WARN,RS_UPDAT) were checked to verify that there were no problems flagged by RDMQ which were inadvertently included in the database. Every routine field sample (RFS) and field duplicate (FD#) was checked to verify that a valid station name, sampling date, and depth collection information were included. The value ranges (minimum, maximum, average) for all congeners was checked to look for any obvious errors. Data ranges of all data were also checked for obvious errors. Data were checked to verify units and to confirm whether blank, dilution, or surrogate corrections were done. Quality Control (QC) Coordinator (RECSTAT), station notes (STNNOTES), and record (RECSTAFF) comment fields were checked for comments associated with a sample. All of this information was recorded on a Data Verification Checklist (Appendix 1.3.2). If questions or errors were found, they were referred back to GLNPO for resolution.

Upon completion of this initial data check, readme files were created to describe the data, and the raw data set(s) and readme files were copied to a data

archive on the LLRS Unix systems. This archive is located at \usr\lmmdata on the Alpha workstation named llrsv2 and is available to modeling staff at the LLRS. Each study has its own directory (LMI0001 - LMI0041) within the lmmdata archive. PCB data for the LMMBP can be found in directories: LMI0029 (daily gas phase congener, total PCBs, and *trans*-nonachlor for each surface cell in the LMMBP 5 km grid); LMI0032 (particulate and precipitation congener, total PCBs, and *trans*-nonachlor data for eight onshore sampling stations around Lake Michigan and for shipboard sampling from the Lake Guardian); LMI0035 (open lake congener, total PCBs, and *trans*-nonachlor data collected during the eight LMMBP cruises conducted in 1994-1995); LMI0036 (phytoplankton, zooplankton, *Mysis* and *Diporeia* congener, total PCBs, and *trans*-nonachlor data collected during eight LMMBP cruises); LMI0037 (forage and predator (lake trout, coho salmon) fish congener, total PCBs, and *trans*-nonachlor data collected for the LMMBP); LMI0040 (surficial sediment and sediment trap congener, total PCBs, and *trans*-nonachlor data); and LMI0041 (daily tributary congener, total PCBs, and *trans*-nonachlor loading data from 11 monitored and 18 unmonitored Lake Michigan tributaries).

At the same time, information about data received (metadata) was stored in a searchable Microsoft Access database. The database is found on the LLRS common drive "\\giord2\grlcommon", which is also known as the "r:\\" drive. This database is named "ltrack2000.mdb" and is found in the r:\access2000\ folder. This database is available to all staff. This database can be searched by library number (consecutive number assigned when data are logged in, corresponds to LMI folder name in lmmdata archive), PI, parameter, PI and parameter, or library number and parameter (Appendix 1.3.3.).

After initial review of a data set was completed, data were retrieved from the Microsoft Access databases and exported into files (usually Microsoft Excel) for assessment by the modeler who would be using the data set. Water and sediment PCB data were given to Xiaomi Zhang. Lower food chain data were assessed by Xin Zhang and Katie Taunt. Forage and predator fish data were assessed by Xin Zhang. Initially, only routine field samples and field duplicates were given to the data assessors. If issues or problems were found, the person assessing the data

would then request additional QA data. If questions/problems could not be resolved by looking at QA data, they were referred back to GLNPO for resolution.

In several instances, data which passed GLNPO QA checks from the analytical point of view were rejected during assessment because values were not environmentally reasonable. For example, particulate and dissolved water PCB values from station MB63 from the October 1995 cruise were orders of magnitude higher than values for surrounding stations. In addition, their values were orders of magnitude higher than values from the same station collected on different cruises. Environmentally these results were unreasonable, and they were not used by the modelers. GLNPO was informed whenever we rejected data.

After the assessment process was completed, files were created which could be used in IDL, which is a software package used for visualization and analysis of LMMBP data. Standard formats were developed for water, sediment, and fish data (Appendices 1.3.4, 1.3.5, 1.3.6). All files were fixed format ASCII text files. One of the principal uses of IDL was to develop volume-weighted averages (VWA) estimates of parameter concentrations for each cell in the modeling grid. These VWA estimates could then be compared to model results.

1.3.2 Calculation of Total PCBs

In general, total PCBs were calculated by the PI reporting the data. In the case of tributary loads for total PCBs, total PCBs were calculated by the PI, and loads were calculated by David Hall, USGS. In a similar fashion, total PCBs were calculated by the PI, and atmospheric loads were calculated by Keri Hornbuckle, University of Iowa. Open lake total PCBs were calculated by GLNPO contractor staff (Marcia Kuehl). A GLNPO contractor, DynCorp, verified total PCB values. However, the method used to calculate total PCBs was not consistent from PI-to-PI. Some PIs blanked corrected data; some included invalid data (samples with INV analytical remark field); and some did not surrogate correct data. In those instances when invalid samples were included in the total PCB calculation or surrogate correction was not done, total PCBs were recalculated by DynCorp to correct these problems. Attached are

documents from Marcia Kuehl, PCBs QA Coordinator, describing how total PCBs were calculated by each PI (Appendix 1.3.7).

1.3.3 Regression Analysis of Measured Congener, Total PCB Data

As the modeling study was originally devised, all modeling was to be done at the congener level; however, at a later date it was decided that simulation of total PCBs would also be desirable. The Level 2 (LM2) and Level 3 (LM3) LMMBP models did not model total PCBs; therefore, a method was devised to calculate total PCB concentrations for model results based on the set of congeners modeled. Regressions and ratios were calculated comparing the PIs' measured total PCB field values (the independent variable) to the PIs' measured sum of the congeners that were modeled at the LLRS (the dependent variable) in all media modeled (atmospheric vapor phase, wet and dry deposition, dissolved and particulate tributary water, total, dissolved and particulate water, surficial sediment, phytoplankton, zooplankton, *Diporeia*, *Mysis*, and all forage and predator fish species). Note that total PCBs in water were not measured, but were derived by adding up dissolved and particulate PCBs for each sample. With R² values of .90 or greater, these regression analyses produced very good results (Table 1.3.1).

Additional analysis was then performed to produce an uncertainty estimate for the regression equations. A mean was calculated for the slope of the line in the linear regression (z), and 95 percent confidence intervals were calculated for z using the formula:

$$z = x/y$$

where

x = total of PCB congener subset that was modeled

y = true total PCBs as calculated by the PI.

David Miller, statistician at LLRS, verified that the z values were generally normally distributed. This allowed us to calculate a mean, standard deviation,

Table 1.3.1. Revised Regression Equations for the LMMBP Total PCBs in All Media

Media	Ratio of PI Calculated Total PCBs to Summed Modeling Congeners	PIs' Calculated Total PCBs Versus Summed Modeling Congeners: Regression Equation	R ²
Atmospheric Vapor Phase	1.2944	$y = 1.2707x + 0.0891$	0.9997
Atmospheric Dry Deposition	1.3597	$y = 1.3204x + 0.2159$	0.9623
Atmospheric Wet Deposition	1.5775	$y = 1.6917x - 0.0322$	0.9672
Tributary Loading Data	1.2476	$y = 1.2134x + 0.7752$	0.991
Dissolved Water	1.4822	$y = 1.2738x + 0.0268$	0.9413
Particulate Water	1.2948	$y = 1.2251x + 0.0051$	0.9992
Dissolved + Particulate Water	1.4147	$y = 1.2427x + 0.0347$	0.9829
Surficial Sediment	1.1805	$y = 1.1668x + 0.6125$	0.997
Phytoplankton	1.3842	$y = 1.2871x + 3.6216$	0.9584
Zooplankton	1.3923	$y = 1.2058x + 22.833$	0.9595
<i>Diporeia</i>	1.3652	$y = 1.3763x - 3.4124$	0.9795
<i>Mysis</i>	1.3162	$y = 1.3829x - 12.842$	0.9833
Alewife < 120 mm	1.4458	$y = 1.4534x - 1.296$	0.9784
Alewife > 120 mm	1.4281	$y = 1.3338x + 38.145$	0.947
Bloater < 160 mm	1.4761	$y = 1.4317x + 19.505$	0.9851
Bloater > 160 mm	1.4827	$y = 1.4146x + 38.14$	0.9426
Deepwater Sculpin	1.5157	$y = 1.3752x + 38.735$	0.9897
Slimy Sculpin	1.4976	$y = 1.5272x - 8.4009$	0.9257
Adult Smelt	1.4447	$y = 1.46693x - 5.2828$	0.9044
Hatchery Coho	1.2836	$y = 1.4009x - 11.024$	0.994
Coho Yearling	1.497	$y = 1.6263x - 16.984$	0.9835
Coho Adult	1.444	$y = 1.4392x + 2.7179$	0.9927
Adult Lake Trout	1.4897	$y = 1.4875x + 3.7424$	0.9977

and 95 percent confidence intervals for the z value in all media modeled (Appendix 1.3.8).

A comparison of field measured water congeners values to model results from Xiaomi Zhang, WelSo modeler at LLRS, indicated that there were some problems with measured field results for congeners 84+92 and 99. In both dissolved and particulate water fractions, concentrations for both of these congeners were much higher than model results.

Investigation into this issue revealed a contamination issue with congener 99. The analytical technique used to measure the water congener could not adequately separate congener 99 from *trans*-nonachlor, which caused a co-elution problem. The

reason for the high field values for congener 84+92 was unclear, but it also is believed to be caused by a co-elution problem. Xiaomi Zhang developed ratios comparing field data to model results (Table 1.3.2).

These ratios were used to correct 84+92 and 99 congener values by the following formula:

$$\text{Corrected congener nn value} = \text{Measured congener nn value} / \text{ratio}$$

where

$$\text{nn} = \text{congener 84+92 or 99.}$$

Table 1.3.2. Ratio of Measured Field Data/Model Results for Congeners 84+92 and 99 in Water

Congener	Ratio in Dissolved Water	Ratio in Particulate Water
84+92	2.08	3.41
99	1.15	1.94

Regression analysis was then redone for dissolved, particulate, and dissolved + particulate water.

These revised regression equations were then applied to summed modeled congeners to calculate modeled total PCBs. Regression equations for dissolved and particulate fractions of total PCBs have a positive y-intercept. This means that when these regressions are used to calculate total PCBs, the value will never drop to zero even if modeled congeners drop to zero. Meetings were held with the modeling staff to discuss this issue. It was believed that this bias was caused by 1) lack of blank correction of congener data, 2) detection limits, and 3) inherent uncertainty in the regression process. Since it was not possible to correct these problems,

the decision was made to use the regression equations, and carefully explain these difficulties when documenting modeling scenarios.

1.3.4 Summary

The LMMBP data received at the LLRS were carefully evaluated prior to use to insure that the field data being used by the modelers were as accurate as possible. In addition, data were archived and cataloged to protect these valuable data sets and make it easier for users to find the information. Incorporation of this information into LLRS Microsoft Access databases has given us flexibility in retrieving the information needed by the modeling staff at the LLRS. These data were used to develop regression equations which were used to approximate total PCB concentrations for modeled data.

References

- Sukloff, W.B., S. Allan, and K. Ward. 1995. RDMQ User Manual. Environment Canada, Atmospheric Environment Service, North York, Ontario, Canada. 91 pp.

PART 1

INTRODUCTION

Appendix 1.3.1. List of Parameters Analyzed and Principal Investigators for the LMMBP

Parameter	Focus Group	Media	Notes	Principal Investigator
Atrazine, Deethylatrazine (DEA), Deisopropylatrazine (DIA), Terbutylazine	IUAA	Atmospheric Vapor and Particulate Phase, Precipitation	Sleeping Bear Dunes site only.	Ron Hites, Indiana University. Keri Hornbuckle, U. of Iowa used this data to calculate loadings.
Atrazine, DEA, DIA, d5-Atrazine	WSAA	Atmospheric Vapor and Particulate Phase, Precipitation	All stations except Sleeping Bear Dunes site.	Clyde Sweet, Illinois State Water Survey. Keri Hornbuckle, U. of Iowa used this data to calculate loadings.
Atrazine	RULA	Open Lake		Steven Eisenreich, Rutgers University
Atrazine	RUTA	Tributary		Steven Eisenreich, Rutgers University. David Hall, USGS used this data to calculate loads.
Alkalinity, Conductivity, Hardness, pH, Turbidity	GPLN	Open Lake		Marvin Palmer, GLNPO. Analysis by Grace Analytical Labs.
Alkalinity, Chloride, Conductivity, NO ₂ +NO ₃ , Organic Carbon, pH, Total Phosphorus, TKN	GRAN	Atmospheric		Glenn Warren, GLNPO. Analysis by Grace Analytical Labs.

Parameter	Focus Group	Media	Notes	Principal Investigator
Conductivity, DO, pH, Temperature	USTN	Tributary		Peter Hughes, USGS
Alkalinity, Chloride, Conductivity, NH ₄ , NO ₂ +NO ₃ , Orthophosphorus, SiO ₄ /SiO ₃ , Sulfate, Total Phosphorus, TSS, TKN	LHTN	Tributary		George Bowman, Wisconsin State Lab of Hygiene. David Hall, USGS used this data to calculate loads.
Chloride, Ammonium-Nitrogen (NH ₄ N), NO ₂ +NO ₃ , Dissolved Phosphorus, Orthophosphorus, Total Phosphorus, Dissolved Silica, TKN	GRLN	Open Lake		Glenn Warren, GLNPO, Analysis by Grace Analytical Labs.
Phosphorus (Base Extractable as PO ₄), Total Phosphorus, Biogenic Silica (SiO ₂ -bio)	GLSN	Sediment, Sediment Traps		Thomas Johengen, NOAA/GLERL
Total Organic Carbon, Total Organic Nitrogen	NASN	Sediment, Sediment Traps		Brian Eadie, NOAA/GLERL
Organic Carbon (DOC, POC), TSS	BALN	Open Lake		Eric Crecelius, Battelle Marine Sciences
Organic Carbon (DOC, POC)	WWTN	Tributary		Martin Shafer, University of Wisconsin Water Quality Laboratory
Mercury	MIAH	Atmospheric Vapor, Particulate, and Precipitation	Monthly deposition/ concentration calculated by Matt Landis, University of Michigan	Jerry Keeler, University of Michigan
Mercury	MDLH	Open Lake		Robert Mason, U. of Maryland. David Hall, USGS used this data to calculate loads.
Mercury	MNPH	Plankton		Edward Nater, U. of Minnesota

Parameter	Focus Group	Media	Notes	Principal Investigator
Mercury	LLSH	Sediment, Sediment Trap		Ronald Rossmann, LLRS
Mercury, Methylmercury	WWTH	Tributary		Jim Hurley, U. of Wisconsin, Water Quality Laboratory. David Hall, USGS used this data to calculate loads.
Mercury	MIFH	Fish		Jerome Nriagu, U. of Michigan
Congener PCBs, <i>trans</i> -nonachlor	IUAP	Atmospheric Vapor and Particulate Phase, Precipitation	Sleeping Bear Dunes site only.	Ron Hites, Indiana University. Keri Hornbuckle, U. of Iowa used this data to calculate loadings.
Congener PCBs, <i>trans</i> -nonachlor	WSAP	Atmospheric Vapor and Particulate Phase, Precipitation	All stations except Sleeping Bear Dunes site.	Clyde Sweet, Illinois State Water Survey. Keri Hornbuckle, U. of Iowa used this data to calculate loadings.
Congener PCBs, <i>trans</i> -nonachlor	RUAP	Atmospheric Dry Deposition	Includes both land and over-lake sampling sites.	Steven Eisenreich, Rutgers University
Congener PCBs, <i>trans</i> -nonachlor	BALP	Open Lake		Eric Crecelius, Battelle Marine Sciences Laboratory
Congener PCBs, <i>trans</i> -nonachlor	LHTP	Tributary		William Sonzogni, Wisconsin State Lab of Hygiene
Congener PCBs, <i>trans</i> -nonachlor	NASP	Sediment, Sediment Trap		Pat Van Hoof, NOAA/GLERL
Congener PCBs, <i>trans</i> -nonachlor	MNPP	Plankton, <i>Mysis</i> , <i>Diporeia</i>		Deborah Swackhamer, U. of Minnesota
Congener PCBs, <i>trans</i> -nonachlor	MNFP	Forage Fish, Lake Trout, Coho Salmon		Deborah Swackhamer, U. of Minnesota

Parameter	Focus Group	Media	Notes	Principal Investigator
Seabird Temperature, Chlorophyll <i>a</i> , Transmissivity	N/A	Open Lake	Chlorophyll <i>a</i> calculated from fluorescence data	Glenn Warren, GLNPO
Chlorophyll <i>a</i>	WSLH	Tributary		George Bowman, Wisconsin State Lab of Hygiene. David Hall, USGS used this data to calculate loads.
Primary Productivity	GRLY	Open Lake Phytoplankton		Glenn Warren, GLNPO. Analyzed by Grace Analytical Laboratory
Abundance/Biomass	GRLP	Phytoplankton		Glenn Warren, GLNPO. Analyzed by Grace Analytical Laboratory.
Abundance/Biomass	GRLZ	Zooplankton		Glenn Warren, GLNPO. Analyzed by Grace Analytical Laboratory.
Diet Information	BSDB	Forage Fish		John Gannon/ Jacqueline Savino, USGS, National Biological Survey
Diet Information	BSDB	Lake Trout		John Gannon/Edward Brown, USGS, National Biological Survey
Diet Information	FSDB	Coho Salmon		Mark Holey, U.S. Fish and Wildlife Service
Cs-137 and Pb-210	NASR	Sediment		John Robbins, NOAA/GLERL
Sediment Bulk Density, Fraction Dry weight, Porosity, Sediment Mixing Depth, Vertical Sediment Transport, Net Mass Accumulation Rate	N/A	Sediment		John Robbins, NOAA/GLERL

PART 1

INTRODUCTION

Appendix 1.3.2. Example of Data Verification Checklist Used for the LMMBP

Data Verification Checklist

FOCUS _____ Version Number _____ Date Received _____

Description: _____

1. Read any documentation which came with data files: _____
2. Make sure I understand field names in RDMQ files: _____
3. Check fields which according to RDMQ should not be flagged/or indicate some question, with data (e.g. RS_NMAND, RS_WARN, RS_UPDAT).

RS_NMAND _____

RS_WARN _____

RS_UPDAT _____

4. Make sure every RFS and field duplicate has station, date, depth collected information.

5. Check to make sure every sample has station name that is valid.

6. Check number of RFS and field duplicates for every analyte. Total Samples _____

Analyte _____ RFS _____ FDn _____

Analyte _____ RFS _____ FDn _____

Analyte _____ RFS _____ FDn _____

Analyte _____ RFS _____ FDn _____

Analyte _____ RFS _____ FDn _____

Analyte _____ RFS _____ FDn _____

7. Analysis Results for RFS and field duplicates for every analyte.

Analyte _____ Avg _____ Min _____ Max _____ Count _____

Analyte _____ Avg _____ Min _____ Max _____ Count _____

Analyte _____ Avg _____ Min _____ Max _____ Count _____

Analyte _____ Avg _____ Min _____ Max _____ Count _____

Analyte _____ Avg _____ Min _____ Max _____ Count _____

Analyte _____ Avg _____ Min _____ Max _____ Count _____

Analyte _____ Avg _____ Min _____ Max _____ Count _____

Analyte _____ Avg _____ Min _____ Max _____ Count _____

Analyte _____ Avg _____ Min _____ Max _____ Count _____

Analyte _____ Avg _____ Min _____ Max _____ Count _____

Analyte _____ Avg _____ Min _____ Max _____ Count _____

Analyte _____ Avg _____ Min _____ Max _____ Count _____

Analyte _____ Avg _____ Min _____ Max _____ Count _____

Analyte _____ Avg _____ Min _____ Max _____ Count _____

Analyte _____ Avg _____ Min _____ Max _____ Count _____

Analyte _____ Avg _____ Min _____ Max _____ Count _____

Analyte _____ Avg _____ Min _____ Max _____ Count _____

Analyte _____ Avg _____ Min _____ Max _____ Count _____

Analyte _____ Avg _____ Min _____ Max _____ Count _____

Analyte _____ Avg _____ Min _____ Max _____ Count _____

Analyte _____ Avg _____ Min _____ Max _____ Count _____

8. Check date ranges of data to see if they are reasonable.

Analyte _____ Min _____ Max _____

Analyte _____ Min _____ Max _____

Analyte _____ Min _____ Max _____

Analyte _____ Min _____ Max _____

Analyte _____ Min _____ Max _____

Analyte _____ Min _____ Max _____

Analyte _____ Min _____ Max _____

Analyte _____ Min _____ Max _____

Analyte _____ Min _____ Max _____

Analyte _____ Min _____ Max _____

Analyte _____ Min _____ Max _____

Analyte _____ Min _____ Max _____

9. Check to verify units information looks alright.

10. Number of significant digits for each analyte.

11. Number of negative values for each analyte.

12. Check flags on RFS and field duplicates.

13. Core slice range (sediment)/species, age, length, weight (fish).

14. Check blank correction, dilution, and surrogate correction fields.

15. Questions about QC Coordinator remarks (RECSTAT). Check flags for whole record (RECSTATF).
Questions about Station Notes (STNNOTES), Field Remarks (FREMARK), and Sample Description
(SAMPDESC).

16. Additional Questions.

PART 1

INTRODUCTION

Appendix 1.3.3. Printout of Information Stored in the LMMBP Tracking Database (R:\Access2000\lmmmb\ltrack.mdb)

LMMBP DATA ARCHIVE - QUICK REPORT

Note: All Data Archived on llrsv2 in /usr/lmmbdata.

Library No.	LM10001	PI:	David Scwab
Description	Hourly Lake Michigan wind, wave, and atmospheric data (5 km grid) for 1982, 1983, 1994, 1995. Original data files were converted to SEDZL and POM formerly by M. Settles. Also, bathymetric data for Lake Michigan.		
Library No.	LM10002	PI:	William Richardson
Description	STORET conventional and general chemistry data for Lake Michigan, April 1962 - August 1993. Note: Date range varies by parameter, includes original file, reformatted spreadsheet, and MS Access file.		
Library No.	LM10003	PI:	David Scwab
Description	2D and 3D GLERL hydrodynamics data for the Lake Michigan 5 km grid. 2D data: January 1982-September 1983; 3D: covers January-July 1982. Program//llrsv2/~model/dev/PATRIC2D/RCS is for 2D processing, no 3D programming yet.		
Library No.	LM10004	PI:	Steven Eisenreich
Description	Open Lake (RULA) and tributary (RUTA), atrazine, DEA, DIA data for LMMBP. Open lake 325 samples (1/17/94 - 4/17/95). Tributary: 126 samples (4/4/95 - 5/15/96). Revised version of data sent 2/19/98.		
Library No.	LM10005	PI:	Angela Bandemehr
Description	Hourly meteorological data (air temperature, solar radiation, relative humidity, wind speed and direction, and precipitation) from 13 air sampling sites both in and outside of the Lake Michigan basin. 11/30/90 - 12/31/96 (Dates vary by site).		

Library No.	LM10006	PI:	Glenn Warren
Description	Seabird water temperature data for seven LMMBP surveys, April 1994 - October 1995. Data collected at 0.5 m intervals. Does not include January 1994 survey. Note: Data received was extensively revised from original version.		
Library No.	LM10007	PI:	David Hall
Description	Tributary flow data for 11 tributaries to Lake Michigan (Fox, Grand, Indiana Harbor, Kalamazoo, Manistique, Menominee, Milwaukee, Muskegon, Pere Marquette, Sheboygan, St. Joseph), 1/1/94 - 12/31/95. Some data estimated.		
Library No.	LM10008	PI:	Glenn Warren
Description	Open lake organic carbon (dissolved and particulate), and solids data for eight LMMBP cruises. Sampling date was 4/14/94 - 10.13/96. Data also received in D-base (dbf) format. Focus: BALN		
Library No.	LM10009	PI:	Debra Piper
Description	Open Lake Michigan nutrient data (chlorophyll, ammonia, NO ₂ +NO ₃ , total phosphorus, dissolved phosphorus, orthophosphate, silica, and TKN), 4/24/94 - 10/13/95 (orthophosphate, NH ₄ -N started 10/14/94). Focus GRLN, collected and analyzed by Grace Labs. Focus: GRLN.		
Library No.	LM10010	PI:	David Hall
Description	Total and dissolved mercury loading estimates for monitored and unmonitored tributaries to Lake Michigan - 1/1/94 - 12/31/95. Note: Associated flow data is included in an earlier release of this data.		
Library No.	LM10011	PI:	David Schwab
Description	Lake Michigan final report, hourly circulation, meteorology, and wave data (5 km grid) for 1982, 1983, 1994, 1995. Includes intake, cruise, mooring, water level data. Also, HTML files and images, model results (XDR format), Fortran and IDL programs.		
Library No.	LM10012	PI:	David Rockwell
Description	Open lake conventional data (alkalinity, conductivity, total hardness, pH, turbidity) from eight LMMBP cruises, 4/24/94 - 10/13/95. Data received in D-base, and Lotus formats. Focus: GPLN.		
Library No.	LM10013	PI:	Peter Hughes
Description	Conventional data (conductivity, dissolved oxygen, pH, temperature) collected from 11 Lake Michigan tributaries, 3/29/94 - 12/5/95. Note: Five dissolved oxygen samples were flagged as invalid (INV) and should not be used. Files in D-base and Lotus formats. Focus: USTN.		
Library No.	LM10014	PI:	Robert Mason
Description	Open lake mercury data (particulate and total), collected 6/17/94 - 10/10/95. Note: There are 11 invalid samples (flagged as INV) in this data set which should not be used. Data received in D-base, Lotus, SAS, and tabular delimited formats. Focus: MDLH.		
Library No.	LM10015	PI:	David Rockwell
Description	Secchi depth data collected during eight LMMBP cruise, 1/16/94 - 10/11/95. Focus: GPLS.		
Library No.	LM10016	PI:	Matt Landis
Description	Mercury deposition/concentration data estimated into the NOAA/GLERL 5 km over water grid. All data are monthly averages. Covers time period: July 1994 - October 1995.		

Library No.	LM10017	PI:	Glenn Warren
Description	By species and by functional group, abundance, and biomass value, for open lake zooplankton data collected during eight LMMBP cruises (4/24/94 - 10/10/95). Focus Group: GRLZ.		
Library No.	LM10018	PI:	George Bowman
Description	Tributary chlorophyll a data, collected 3/24/94 - 10/31/95. Focus Group: LHTL.		
Library No.	LM10019	PI:	Tom Johengen
Description	Sediment nutrient data (NaOH extractable PO ₄ , total phosphorus, biogenic silica), 6/24/94 - 5/22/96. Note: One sample was flagged as invalid (INV) for all parameters and should not be used. Focus Group: GLSN.		
Library No.	LM10020	PI:	Keri Hornbuckle
Description	Atmospheric atrazine and nutrient (NO ₃ , total phosphorus, TKN) wet deposition loading data for Lake Michigan 5 km grid cells used in hydrodynamic model. Atrazine wet deposition and particulate monthly concentration data. Data for 10/94 - 10/95 (nutrient) and 5/94 - 10/95 (atrazine).		
Library No.	LM10021	PI:	David Hall
Description	Tributary inorganic/nutrient loading data for 10 parameters (alkalinity, ammonia, chloride, NO ₂ +NO ₃ , orthophosphate, dissolved silica, TKN, total nitrogen, total phosphorus, total suspended solids) collected from 11 monitored Lake Michigan tributaries. Data collected 1/1/94 - 12/31/95.		
Library No.	LM10022	PI:	David Hall
Description	Atrazine, DEA, DIA tributary loading data for 11 monitored tributaries and atrazine data for unmonitored tributaries to Lake Michigan. Data covers the time period: 1/1/94 - 12/31/95.		
Library No.	LM10023	PI:	Glenn Warren
Description	Primary productivity data collected during eight surveys for the LMMBP study. Data covers the time period: 4/24/94 - 10/13/95. Data did not go through RDMQ, but was QA'd by Deb Piper, Grace Analytical. Focus Group: GRLY.		
Library No.	LM10024	PI:	Glenn Warren
Description	Abundance and biomass for plankton samples collected during the LMMBP. Data covers the time period: 4/24/94 - 10/10/95. Data is reported both by individual species and by functional group. Focus: GRLP.		
Library No.	LM10025	PI:	John Robbins
Description	Sediment radiochemistry (Pb-210, Cs-137), physical properties (mass, fraction dry weight, soluble fraction, bulk density, porosity, age) of Lake Michigan sediment collected 1994-1996. Station location and modeled data (mixing rates, settling) also included. Focus: NASR.		
Library No.	LM10026	PI:	Nathan Hawley
Description	Current velocity, water transparency, temperature from three stations, 10/31/94 - 10/11/95. In-situ sediment resuspension from sediment flume experiments (8/12/95 - 9/23/98). Also profile data - temperature, dissolved oxygen, conductivity, BAT, pH, fluorescence, TSM data from six stations in Lake Michigan (1/4/95 - 11/29/95).		

Library No.	LM10027	PI:	Barry Lesht
Description	Current velocity and direction, bottom wave orbital velocity, temperature, beam attenuation, and TSM data collected from Tripod Station 98(latitude 42 52.18, longitude 87 42.41), during the EEGLE project, 4/2/98 - 12/1/98. Data collected every 30 minutes.		
Library No.	LM10028	PI:	Michael Settles
Description	NEMA and NOAA wind speed and direction, wave height and period data for six stations in Lake Michigan, retrieved from ACOE Web Site (http://bigfoot.wes.army.mil/c300.html). 1980-1998 (not all stations cover entire date range). NEMO-Daily data, NOAA-Hourly data.		
Library No.	LM10029	PI:	Keri Hornbuckle
Description	Daily gas phase congener, total PCBs, and <i>trans</i> -nonachlor concentration data for LMMBP 5 km grid. Covers time period: 1/1/94 - 9/30/95.		
Library No.	LM10030	PI:	Catherine Taylor
Description	Sedflume data gathered from Catherine Taylor's masters thesis. Excel files contain erosion data at different energy levels and graphs of shear stress at different erosional stresses.		
Library No.	LM10031	PI:	Ronald Rossmann
Description	Surficial sediment/sediment trap mercury data collected during eight LMMBP cruises, 7/18/94 - 8/28/95. Surficial sediment samples collected by R. Rossmann, trap samples by Brian Eadie, NOAA. All analysis by R. Rossmann. D-base files from RDMQ output. GLNPO Focus LLSH.		
Library No.	LM10032	PI:	Keri Hornbuckle
Description	Congener, total PCBs, <i>trans</i> -nonachlor monthly and annual loading and flux data (particulate and precipitation data) for eight land stations around Lake Michigan and from Lake Guardian. Monthly and annual precipitation loading for LMMBP 5 km grid (text files). 4/94 - 9/95.		
Library No.	LM10033	PI:	Ken Klewin
Description	Nutrient data (chlorophyll, NO ₂ +NO ₃ , silica, total dissolved phosphorus, and total phosphorus for 1998 spring and summer GLNPO surveys of all five Great Lakes. Lake Michigan data was collected 4/25/98 - 5/10/98 and August 1998 - first week in September 1998.		
Library No.	LM10034	PI:	Rich Quintal
Description	1994-1995 Lake Michigan diet, length, weight, age, and migration data (coho only) for forage fish, coho salmon and lake trout. Data compiled by Lauri Davis based on data received from R. Quintal.		
Library No.	LM10035	PI:	Marcia Kuehl
Description	Open water congener PCBs and <i>trans</i> -nonachlor data collected during eight LMMBP cruises, 4/24/94 - 10/13/95. Data analyzed by Battelle Marine Science Lab (Focus: BALP).		
Library No.	LM10036	PI:	Deborah Swackhamer
Description	Lower food chain (phytoplankton, zooplankton, <i>Mysis</i> , <i>Diporeia</i>) congener PCBs, total PCBs, <i>trans</i> -nonachlor, lipids and moisture data collected during LMMBP cruises (6/17/94 - 10/10/95). Focus group: MNPP.		
Library No.	LM10037	PI:	James Hickey
Description	Lipids, moisture, congener PCBs data for composite samples of two predator fish species (coho salmon, lake trout) and five forage fish (alewife, bloater, deepwater sculpin, slimy sculpin, and smelt). Length/weight data also. Data collected during LMMBP.		

Library No.	LM10038	PI:	Ken Klewin
Description	Nutrient data (chlorophyll, dissolved and total phosphorus, dissolved silica, NO ₂ +NO ₃) collected and analyzed by GLNPO for spring (4/9 - 4/30/00) and summer (8/2 - 8/28/00) 2000 cruises for selected stations for all five Great Lakes. Note: File is a Lotus 123 file, the rest are Excel files.		
Library No.	LM10039	PI:	Glenn Warren
Description	Seabird chlorophyll a transmissivity profiles for eight LMMBP cruises (4/25/94 - 10/13/95). Chlorophyll a calculated by John Goldsmith, GLNPO. Most 1/2 m depth intervals.		
Library No.	LM10040	PI:	Pat Van Hoof
Description	Surficial sediment and sediment trap PCB congeners, total PCBs, and <i>trans</i> -nonachlor data collected 10/5/94 - 5/22/96 (surficial), 7/4/94 - 8/28/95 (traps), analyzed by Pat Van Hoof. Samples are from top 1 cm of box and gravity cores, and ponar samples.		
Library No.	LM10041	PI:	David Hall
Description	Daily tributary loading data (1/1/94 - 12/31/95) for PCB congeners, total PCBs, and <i>trans</i> -nonachlor for 11 monitored and 18 unmonitored tributaries to Lake Michigan. Data analyzed by Wisconsin Laboratory of Hygiene. Loading estimates by David Hall and Faye Blondin.		

PART 1

INTRODUCTION

Appendix 1.3.4. Generalized Format for the LMMBP Water Data to be Analyzed With IDL Programs

Beginning - Ending Columns	Variable Description	Format (A = Alpha, F = Floating Point No., I = Integer, X = Skip)	Sort Order (A = Ascending, D = Descending, Blank = None)	Missing Data Code
1 - 7	Cruise Name	A7	A	Blank
8 - 8	Blank Space	1X	N/A	N/A
9 - 14	Latitude (ddd.ddd)	F6.3		Blank
15 - 15	Blank Space	1X	N/A	N/A
16 - 22	Longitude (-ddd.ddd)	F7.3		Blank
23 - 23	Blank Space	1X	N/A	N/A
24 - 35	Station Name	A12	A	Blank
36 - 36	Blank Space	1X	N/A	N/A
37 - 44	Depth Sampled	F8.0	A	Blank
45 - 45	Blank Space	1X	N/A	N/A
46 - 53	Sampling Start Date (mm/dd/yy)	A8	A	Blank
54 - 54	Blank Space	1X	N/A	N/A
55 - 58	Sampling Start Time (24-hour clock)	A4		Blank
59 - 59	Blank Space	1X	N/A	N/A

Beginning - Ending Columns	Variable Description	Format (A = Alpha, F = Floating Point No., I = Integer, X = Skip)	Sort Order (A = Ascending, D = Descending, Blank = None)	Missing Data Code
60 - 67	Sampling End Date (mm/dd/yy)	A8	A	Blank
68 - 68	Blank Space	1X	N/A	N/A
69 - 72	Sampling End Time (24-hour clock)	A4		Blank
73 - 73	Blank Space	1X	N/A	N/A
74 - 75	Filter Fraction	A2	A	Blank
76 - 76	Blank Space	1X	N/A	N/A
77 - 79	Sample Type	A3	D	Blank
80 - 80	Blank Space	1X	N/A	N/A
81 - 88	Value Parameter 1	F8.0		-9999
89 - 103	Parameter 1 Flags	A15		Blank
104 - 111	Value Parameter 2	F8.0		-9999
112 - 126	Parameter 1 Flags	A15		Blank
				
	Value Parameter n	F8.0		-9999
	Parameter n Flags	A15		Blank

PART 1

INTRODUCTION

Appendix 1.3.5. Generalized Format for the LMMBP Sediment Data to be Analyzed With IDL Programs

Beginning - Ending Columns	Variable Description	Format (A = Alpha, F = Floating Point No., I = Integer, X = Skip)	Sort Order (A = Ascending, D = Descending, Blank = None)	Missing Data Code
1 - 6	Latitude (ddd.ddd)	F6.3		Blank
7 - 7	Blank Space	1X	N/A	N/A
8 - 14	Longitude (-ddd.ddd)	F7.3		Blank
15 - 15	Blank Space	1X	N/A	N/A
16 - 27	Station Name	A12	A	Blank
28 - 28	Blank Space	1X	N/A	N/A
29 - 36	Station Depth	F8.0		Blank
37 - 37	Blank Space	1X	N/A	N/A
38 - 47	Sampling Start Date (mm/dd/yyyy)	A10		Blank
48 - 48	Blank Space	1X	N/A	N/A
49 - 58	Sampling End Date (mm/dd/yy)	A8		Blank
59 - 59	Blank Space	1X	N/A	N/A
60 - 65	Top of Core Slice	F6.0	A	Blank
66 - 66	Blank Space	1X	N/A	N/A

Beginning - Ending Columns	Variable Description	Format (A = Alpha, F = Floating Point No., I = Integer, X = Skip)	Sort Order (A = Ascending, D = Descending, Blank = None)	Missing Data Code
67 - 72	Bottom of Core Slice	F6.0		Blank
73 - 73	Blank Space	1X	N/A	N/A
74 - 75	Filter Fraction	A2	A	Blank
76 - 76	Blank Space	1X	N/A	N/A
77 - 79	Sample Type	A3	D	Blank
80 - 80	Blank Space	1X	N/A	N/A
81 - 87	Collection Method	A7		Blank
88 - 88	Blank Space	1X	N/A	N/A
89 - 96	Value Parameter 1	F8.0		-9999
97 - 111	Parameter 1 Flags	A15		Blank
112 - 119	Value Parameter 2	F8.0		-9999
120 - 134	Parameter 1 Flags	A15		Blank
				
	Value Parameter n	F8.0		-9999
	Parameter n Flags	A15		Blank

PART 1

INTRODUCTION

Appendix 1.3.6. Generalized Format for the LMMBP Fish Data to be Analyzed With IDL Programs

Beginning - Ending Columns	Variable Description	Format (A = Alpha, F = Floating Point No., I = Integer, X = Skip)	Sort Order (A = Ascending, D = Descending, Blank = None)	Missing Data Code
1 - 13	Species	A13		Blank
14 - 14	Blank Space	1X	N/A	N/A
15 - 27	Biota Zone	A13		Blank
28 - 28	Blank Space	1X	N/A	N/A
29 - 41	Station Name	A13		Blank
42 - 42	Blank Space	1X	N/A	N/A
43 - 45	No. of Samples in Composite	I3		Blank
46 - 46	Blank Space	1X	N/A	N/A
47 - 49	Minimum Age	I3		Blank
50 - 50	Blank Space	1X	N/A	N/A
51 - 52	Maximum Age	I2		Blank
53 - 53	Blank Space	1X	N/A	N/A
54 - 58	Minimum Length	F5.0		Blank
59 - 59	Blank Space	1X	N/A	N/A
60 - 64	Maximum Length	F5.0		Blank

Beginning - Ending Columns	Variable Description	Format (A = Alpha, F = Floating Point No., I = Integer, X = Skip)	Sort Order (A = Ascending, D = Descending, Blank = None)	Missing Data Code
65 - 65	Blank Space	1X	N/A	N/A
66 - 87	Gender	A22		Blank
88 - 88	Blank Space	1X	N/A	N/A
89 - 99	Sampling Start Date (mm/dd/yyyy)	A11		Blank
100 - 100	Blank Space	1X	N/A	N/A
101 - 110	Sampling End Date (mm/dd/yy)	A10		Blank
111 - 111	Blank Space	1X	N/A	N/A
112 - 119	Parameter Units	A8		Blank
120 - 120	Blank Space	1X	N/A	N/A
121 - 128	Biota Part Sampled	A8		Blank
129 - 129	Blank Space	1X	N/A	N/A
130 - 137	Value Parameter 1	F8.0		-9999
138 - 138	Blank Space	1X	N/A	N/A
139 - 146	Value Parameter 2	F8.0		-9999
147 - 147	Blank Space	1X	N/A	N/A
				
	Value Parameter n	F8.0		-9999
	Parameter n Flags	A15		Blank

PART 1

INTRODUCTION

Appendix 1.3.7. Documents From Marcia Kuehl Discussing How Total PCBs Were Calculated by Focus Group

PCBs total routines
2/28/01

IUAP: reported by PI as pcbtot, is in rdmq output. PI added all congeners except 30, 204, 14, 65, 166, and in two cases 44 due to interference. As PI added prior to rdmq verification, INV data included in totals and totals not surrogate corrected. Dyncorp redid, using surrogate corrected values for summation and excluding INV results and #44 as indicated by PI. Values are called pcbtot2 in the rdmq output.

WSAP: PI added prior to rdmq verification and gave to modeler. Not reported to GLNPO and therefore not in rdmq output. INV data included in totals. Added all congeners except 30, 204, 14, 65, 166. Dyncorp did totals, using surrogate corrected values for summation and excluding INV results. Some samples have no pcbtot due to whole sample invalidated from biased Lake Guardian sampling location.

RUAP: PI added and included mention of protocol in ES&T journal article. Not reported to GLNPO and therefore not in rdmq output. Added all congeners except 30, 204, 14, 65, 166, and 4+10, 6, 8+5, 7+9 due to interference/contamination. Each sample had its associated field blank (FMB) subtracted from it. No mention of how to handle negative results included, but I would assume negative values revert become zero. Dyncorp did totals including INV results and blank subtraction with negative results reverting to zero. Totals were qualified as field blank corrected (FBC).

LHTP: Modeler added. Not reported to GLNPO and therefore not in rdmq output. INV data not included in totals. Added all congeners except 30, 204, 14, 65, 166. Dyncorp did using these rules and totals were verified against Faye Blondin's totals.

BALP: Not reported to GLNPO and therefore not in rdmq output. Excluded 14, 65, 166, 103, 30, 204 and any INV flagged results for first run at totals. Subsequent runs may also exclude INT, UNC values and/or replacement of zeros with a value (my thesis work). Some samples have no pcbtot due to whole sample invalidated due to extremely low surrogate recoveries. Dyncorp has done using these rules.

NASP: Not reported to GLNPO and therefore not in rdmq output. PI developed routine which excludes congeners that had small peak heights: 12, 13, 77, 119, 129, 130, 189 and those with interference: 33, 49, 201 and low recoveries in QC spikes: 16, 19. All trap samples lab blank corrected on a congener by congener

basis, negative results become zero. Low level (< 4 ng/g) ponar samples lab blank corrected if total pcbs in lab blank is > 10% of total pcbs in sample, blank correction done on a congener by congener basis, negative results become zero. If > 33% of blank corrected results are 0, and/or NAI, pcbtot flagged with LOB. Any lab blank corrected pcbtot values flagged with (LBC). INV results excluded from any pcbtot calculation. Dyncorp has done using these rules.

MNPP: As per PI: " We generally summed all congeners, and those below the MDL were assigned a value of zero for summation purposes. HOWEVER we then applied lots of expert judgement in looking at the sums, and applied some other criteria (for instance, if a single congener made up more than 10% of the mass of the sum we rejected it entirely) - and if you simply sum you will definitely get different results than we are publishing (on a significant number of samples)." PI supplied totals using below MDL values as reported and considering them zero. I chose to have Dyncorp enter the PI totals that used the below MDL values in the total as the biggest difference between the two methods was $\leq 7\%$.

BSFP: Not reported to GLNPO and therefore not in rdmq output. Added all congeners reported (no 14, 65, 166, 30, 204 reported for BSFP) for each RFS. No INV DATA TO BE INCLUDED.

Spreadsheet Highlighting Differences and Similarities in How Total PCBs Were Calculated In Different LMMBP Focus Groups

FOCUS	INV Flagged Congeners Excluded	Surrogate Corrected	LOB Flagged Congeners Excluded*	HIB Flagged Congeners Excluded*	MDL Flagged Congeners Excluded*	Blank Corrected	Other Conditions
IUAP	Y	Y	N	N	Y	N	BZ #44 excluded in two cases
WSAP	Y	Y	N	N	Y	N	
RUAP	Y	N	N	N	Y	Y, flagged FBC*	If field blank subtraction yielded negative value, reverted to 0
BALP	Y	Y	N	N	Y	N	
LHTP	Y	Y	N	N	Y	N	
NASP	Y	Y	N	N	Y	Y, flagged LCB*, LOB* if > 33% results = 0 or NAI*	If lab blank correction yielded neg. value, reverted to 0. Small peak height congeners excluded: BZ#12, 13, 77, 119, 129, 130, 189. Excluded congeners with interferences: BZ# 33, 49, 201. Excluded low matrix spike recovery congeners: BZ# 16, 19.
MNPP	Y	Y	N	N	Y	N	“Expert judgment” and any congener > 10% total was excluded and retotal done
BSFP	Y	Y	N	N	Y	N	

*Key to Flags: LOB = Low Bias Flag, HIB = High Bias Flag, MDL = Method Detection Limit Flag, FCB = Field Corrected Blank, LCB = Lab Corrected Blank, NAI = Not Analyzed Due to Interference Flag

PART 1

INTRODUCTION

**Appendix 1.3.8. Uncertainty of Z Values (Slope of Linear Regression Line) for PCBs
in Media Modeled at the LLRS for the LMMBP**

Media	Z - Mean	Z - sd	Number of Samples	95% Confidence Interval Lower	95% Confidence Interval Upper
Dissolved Water	1.53924569	0.290911927	369	1.509305468	1.569185912
Particulate Water	1.353079101	0.120677122	372	1.340709374	1.365448829
Surficial Sediment	1.17528269	0.05661207	132	1.16550663	1.18505875
Phytoplankton	1.432619553	0.355361646	86	1.356363486	1.50887562
Zooplankton	1.462624095	0.399167732	77	1.371918262	1.553329928
<i>Diporeia</i>	1.3641858	0.0432741	42	1.3506909	1.3776807
<i>Mysis</i>	1.312835	0.04129	62	1.302347	1.323322
Alewife <120mm	1.439713618	0.140086181	60	1.403380756	1.47604648
Alewife >120mm	1.434390619	0.08071193	70	1.415096777	1.45368446
Bloater <160mm	1.479266265	0.049654336	70	1.467396609	1.491135922
Bloater >160mm	1.487545716	0.109039931	67	1.46090302	1.514188411
Deepwater Sculpin	1.533308409	0.089680915	74	1.512520571	1.554096246
Slimy Sculpin	1.495781353	0.110647788	69	1.469140496	1.52242221
Adult Smelt	1.44344149	0.166498179	73	1.41625314	1.470629841
Adult Lake Trout	1.489208126	0.06449037	246	1.481079185	1.497337067

Coho Salmon - Hatchery	1.280547696	0.028621549	5	1.245015047	1.316080345
Coho Salmon - Yearling	1.485910089	0.112380374	8	1.391942816	1.579877362
Coho Salmon - Adult	1.448267317	0.074873035	54	1.427797757	1.468736876

Z values for the LMMBP Total PCBs Data in Various Media. $Z = Y/X$, where X = Sum of all modeled congeners, as measured by Principal Investigator (PI), and Y = PI Calculated Total PCBs.

Notes from David Miller, Statistician at the LLRS:

"I used Histograms with a normal distribution overlaid upon them as well as quantile-quantile plots (Q-Q Plots) to analyze these data sets for normality.

The assumption of normality appears to be supported for these data sets, although the following observations should be noted.

Dissolved and particulate water, surficial sediment, phytoplankton, zooplankton, deepwater sculpin, and adult coho, appear to exhibit some degree of kurtosis. Thus, the confidence intervals for the mean of these data sets will be conservative.

Bloater >160mm and adult lake trout appear to have a few values at the upper end of the distribution that fall higher than the rest of the distribution (appear under-represented according to a quantile-quantile plot).

Surficial sediments have some outlying values on the low end of the distribution as examined by the quantile-quantile plot.

Coho salmon - Hatchery and coho salmon - Yearling have too few data to make a determination."

PART 1

INTRODUCTION

Chapter 4. Representativeness of the LMMBP Years Relative to Lake Michigan's Historic Record

Ronald Rossmann, Kenneth R. Rygwelski, and Russell G. Kreis, Jr.

U.S. Environmental Protection Agency
Office of Research and Development
National Health and Environmental Effects
Research Laboratory

Mid-Continent Ecology Division
Large Lakes and Rivers Forecasting Research
Branch

Large Lakes Research Station
9311 Groh Road
Grosse Ile, Michigan 48138
and

Gregory J. Gerstner, Xiaomi Zhang, and Brent Burman

Welso Federal Services, LLC
Large Lakes Research Station
9311 Groh Road
Grosse Ile, Michigan 48138

1.4.1 Introduction

A major concern related to modeling contaminants in the lake was the representativeness of the years of sampling (1994-1995) relative to the historical record. This was particularly important when using the models to predict future conditions in the lake. The models were calibrated using 1994-1995 data collected during the project. If these data did not represent something close to average conditions, the resulting predictions could be biased. Parameters considered most important to the performance of the

models included ice cover, air temperature, water temperature, lake water levels, precipitation, tributary flows, and wave heights. Each of these were investigated for the representativeness of the 1994-1995 project data relative to the available historical data record.

1.4.2 Ice Cover

Ice cover impacts the volatilization, absorption, and physical mixing of the lake during the winter months. In locations where there is ice cover, gas exchange between the water and atmosphere is prevented by the physical barrier. Physical mixing includes not only the mixing of the water column but also the interaction of waves with the lake bottom to resuspend sediments. Winters having extensive ice cover yield a more poorly mixed water column, and a large region of the lake becomes depositional due to lack of wave resuspension of sediments. Once ice retreats in the spring, sediments accumulated during ice cover will be resuspended as a pulse. Ice cover can cause significant changes in winter circulation patterns in a large lake (Campbell *et al.*, 1987). The years of interest that were important were 1982, 1983, 1994, and 1995. The hydrodynamic modeling included three-dimensional lake circulation, surface flux for atmospheric input, and wind-wave models (Schwab and Beletsky, 1998). These were calibrated for the period of 1982-1983 using temperature, current, water level, and wind-wave measurements. The calibrated model was applied to 1994-1995 and validated. There was no ice modeling component for the version of hydrodynamic model applied. Thus, ice cover was important for understanding any potential weakness associated with the

hydrodynamic results as well as the dynamics of exchanges between the water and the atmosphere.

Ice cover data were available from the National Oceanic and Atmospheric Administration (NOAA)/ Great Lakes Environmental Research Laboratory (GLERL) (Assel, 2003). This data set is partially described in Assel *et al.* (2002). Tabular information presented in Assel (2003) were summarized in a manner that seemed appropriate for this discussion (Table 1.4.1). For the period when ice was recorded on Lake Michigan, the mean and median daily ice cover were 16.7% and 14.7%, respectively. Ice years began with the first ice. For example, 1982 may include December of 1981. Both 1982 and 1994 were greater than the mean and median; whereas, 1983 and 1995 were less than the mean and median. None of the four years represented an extreme of mean daily ice cover. The lowest ice cover was observed in 2002, and the highest was observed in 1977. Results for each winter's maximum daily ice cover were similar to mean daily ice cover. None of the four years represented an extreme of maximum daily ice cover. As before, 1982 and 1994 were above the mean and median, and 1983 and 1995 were below the mean and median. The maximum mean occurred in 1977, and the minimum mean occurred in 2002. For all four years, 1982 and 1994 were above average for number of days ice was observed, and 1983 and 1984 were slightly below the average. None of the four years represented a minimum or maximum extreme. Ice cover is extremely variable from year-to-year. The impact upon hydrodynamics as modeled was believed to be minimal with respect to 1983 and 1995 when ice cover was quite low. Though high ice cover occurred during the winters of 1982 and 1994, these periods were not a part of the hydrodynamic model period. Using the hydrodynamic model information for models that are used to predict future conditions could lead to potential errors. Modeled circulation patterns could be in error and impact a high bias to modeled current velocities during the winters of high ice cover years due to the lack of an ice model within the hydrodynamics model.

1.4.3 Water and Air Temperatures

Water and air temperature data were retrieved from the National Data Buoy Center (U.S. Department of

Commerce, 2002). The buoy numbers are 45002 (north buoy) and 45007 (south buoy) (Figure 1.4.1). Water temperature sensors were located 1 m below the water surface, and air temperature sensors were located 4 m above the surface. Water and air temperature data were available 1979 through 2002 for the north buoy and 1981 through 2002 for the south buoy.

Water temperature is highly variable from year-to-year. The data had been stratified in two ways for presentation. First, monthly mean temperatures were calculated and plotted for the south (Figure 1.4.2) and north (Figure 1.4.3) buoys. Years of importance to the hydrodynamic model were highlighted. It was interesting to note that 1983 and

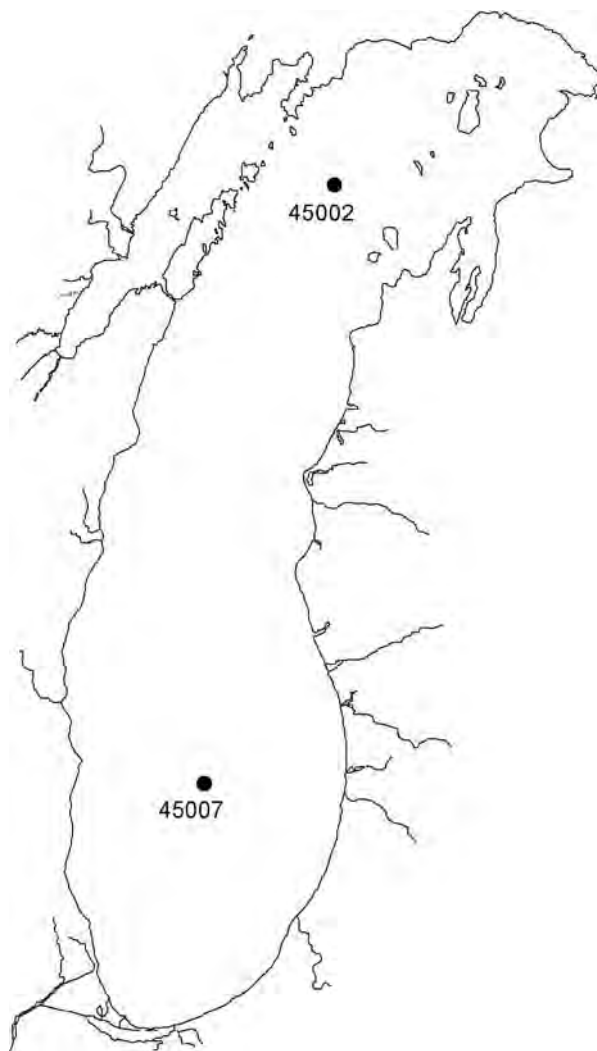

Figure 1.4.1. Location of the NOAA's buoys in Lake Michigan.

Table 1.4.1. Summary of Lake Michigan Ice Cover Based Upon Assel (2003)

Year	Mean Daily Ice Cover During Ice Period	Days of Observed Ice	Maximum Daily Ice Cover
1973	13.3	104	33.0
1974	16.9	122	39.4
1975	13.9	113	28.1
1976	15.5	119	29.5
1977	46.5	132	93.1
1978	26.6	132	66.6
1979	35.2	132	92.3
1980	18.2	106	38.6
1981	24.6	112	53.8
1982	24.0	135	60.2
1983	8.2	118	23.6
1984	15.6	127	43.3
1985	20.1	119	41.3
1986	25.3	126	66.8
1987	9.1	100	19.3
1988	16.6	104	32.7
1989	13.1	140	30.9
1990	17.5	132	32.4
1991	10.0	120	21.5
1992	8.3	149	32.8
1993	11.0	126	32.2
1994	27.3	134	82.7
1995	7.2	120	21.6
1996	19.4	161	75.0
1997	13.4	156	37.8
1998	6.1	109	15.1
1999	8.7	111	23.0
2000	9.2	103	27.2
2001	13.4	134	29.5
2002	6.0	116	12.4
Mean	16.7	124	41.2
Median	14.7	121	32.8
Minimum	6.0	100	12.4
Maximum	46.5	161	93.1

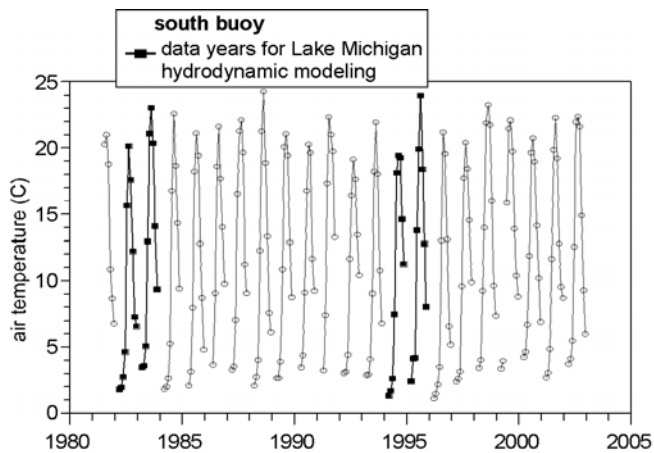

Figure 1.4.2. Monthly mean water temperatures in southern Lake Michigan.

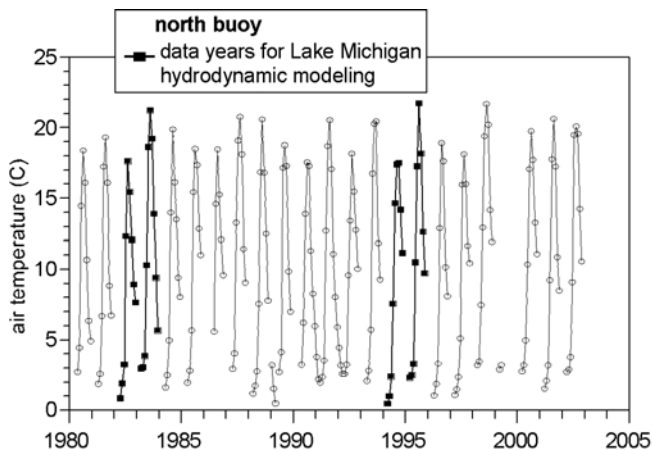

Figure 1.4.3. Monthly mean water temperatures in northern Lake Michigan.

1995 had higher monthly mean temperatures than 1982 or 1994. Both 1983 and 1995 had above normal maximum mean monthly temperature; whereas, 1982 had a typical maximum and 1995 had a very low maximum. This was reflected in the previously discussed ice cover for the four years. Water temperatures tended to be higher at the southern buoy than at the northern buoy, reflecting its more southerly latitude.

The rate at which the lake warms each year is important for the eutrophication and polychlorinated biphenyl (PCB) models. A more rapid warming resulted in an earlier spring diatom bloom when preferred water temperatures were reached. This impacted the timing of annual events, including

generation of biotic carbon to which PCBs partition. One way to identify the relative warming rate among years was to look at the mean June water temperature for the period of observation available from the NOAA buoys. Mean June temperatures at the south (Figure 1.4.4) and north (Figure 1.4.5) showed similar patterns that were quite interesting. Beginning in 1983, relatively high mean June temperatures were observed every four years (1983, 1987, 1991, 1995, 1999). This cycling, as well as the apparent increasing mean June water temperature for the period of record, should be further investigated. Both these trends can impact long-term model forecasts. The years of the Lake Michigan Mass Balance Project (LMMBP) (1994 and 1995) represented a fairly average mean June temperature and one of the relatively high means, respectively.

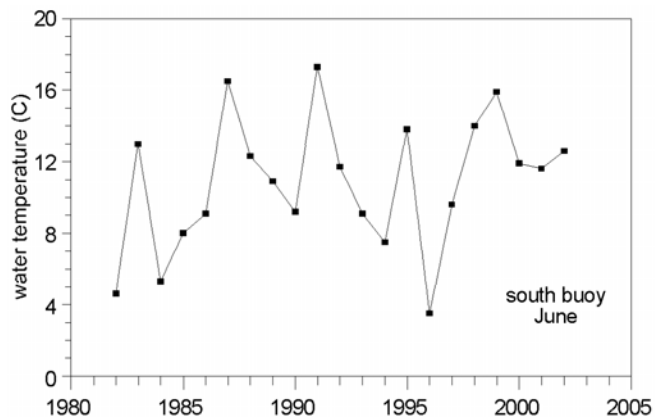

Figure 1.4.4. Mean June water temperatures in southern Lake Michigan.

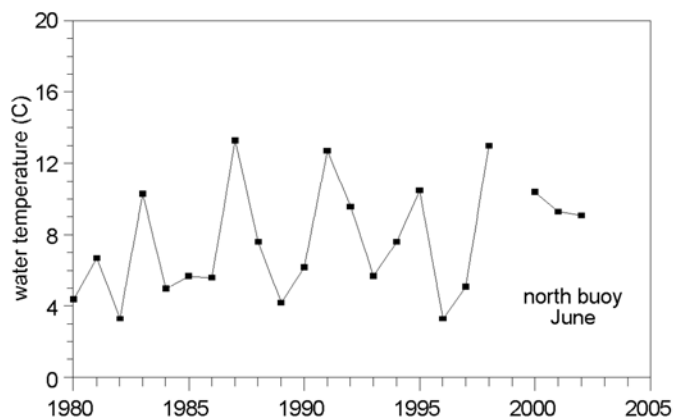

Figure 1.4.5. Mean June water temperatures in northern Lake Michigan.

This, in part, explained why sampling missed the spring 1995 diatom bloom.

The exchange of PCBs between the air and water were dependent on both water and air temperatures. Air temperature varied from year-to-year at the south and north buoys (Figure 1.4.6 and 1.4.7). Because air temperature drives observed water temperature, it was not surprising that patterns observed and conclusions made for water temperature are the same for air temperature. The cyclic pattern of June mean water temperatures was also found for the air temperatures (Figures 1.4.8 and 1.4.9). As additional data become available, future modeling efforts will need to address these cyclic patterns and long-term temperature trends for water and air temperatures.

1.4.4 Lake Water Levels

Lake levels can affect model geometry. If segment volume deviates significantly from the volumes used at the time of calibration, model results can be impacted. On a percentage basis, the impact will be most noticeable for shallow water segments and predictions from the hydrodynamic model and surface water model could be affected. Monthly mean lake water levels varied between 175.5 and 177.5 m for the period of record (1918-1997). Lake levels during 1994 and 1995 were near the average for the period of record (Figure 1.4.10).

1.4.5 Precipitation

Precipitation influences the flux of airborne contaminants to the lake, impacts tributary loading rates, and controls water levels. The 1982 and 1983 hydrodynamic years, and the 1994 and 1995 project years were compared to the previous 50 years of data (Croley and Hunter, 1994).

1.4.5.1 Annual Comparisons

Precipitation to Lake Michigan for 1982, 1983, 1994, 1995 were close to the 50-year mean for the lake (Figure 1.4.11). 1982 and 1983 were slightly above the mean, and 1994 and 1995 were slightly below the mean. 1995 total annual precipitation was very close to the 50-year mean for over-lake precipitation. No visual trend was apparent in the total annual amounts of precipitation over the 50-year period.

1.4.5.2 Monthly Comparisons

The monthly mean precipitation for 1982, 1983, 1994, and 1995 were compared to the 50-year mean for the period of 1949 through 1998 (Figure 1.4.12). For the years of interest, January, July, November and December of 1982; May of 1983; and October of 1995 had relative high amounts of precipitation, exceeding one standard deviation of the 50-year mean. For the four years of interest, February of 1982; June of 1983; March, May and December of 1994; and June of 1995 had relatively low amounts of precipitation. This illustrates that, in any one year, precipitation varies from month-to-month while the precipitation for the year can be at or near the average expected.

1.4.6 Tributary Flows

Tributary flows impact the delivery of materials to the lake, including nutrients and contaminants. During high flow events triggered by spring snow melt or rain events, tributary flows increase and materials can be carried from the watersheds to the tributaries. Within the tributary, sediments containing contaminants may resuspend. Thus, the fluxes of solids, nutrients, and contaminants to the lake have the potential to increase during high flow events. Tributary flows were obtained from the United States Geological Survey (USGS) website (www.usgs.gov). A historical average and median daily flow were calculated for each tributary for the period of record, as well as for the 1994-1995 and 1982-1983 time periods. During 1982 and 1983, tributary flows were approximately 20% greater than the average flows (Figure 1.4.13). The 1994-1995 time period had relatively ordinary tributary flows (Figure 1.4.14).

1.4.7 Wave Heights

In Lake Michigan, waves are the driving force for the resuspension of sediments and their associated contaminants. As waves move from offshore to inshore, they begin to interact with the lake bottom. The energy associated with the waves serves to resuspend the sediments. Lake Michigan is deep enough such that it can be divided into three zones based upon the potential for waves to resuspend sediments. The zones are non-depositional,

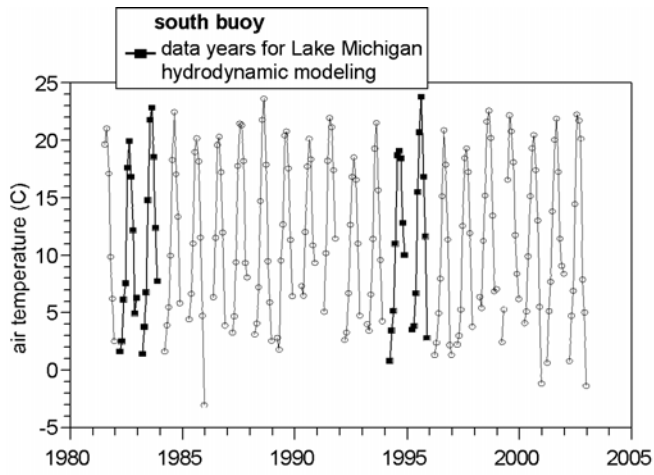

Figure 1.4.6. Monthly mean air temperatures in southern Lake Michigan.

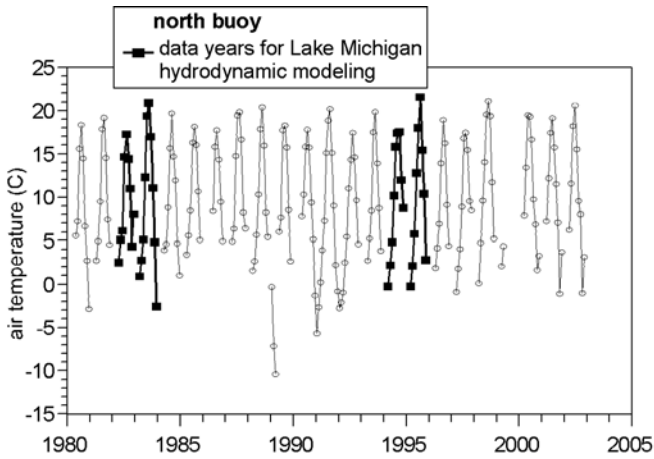

Figure 1.4.7. Monthly mean air temperatures in northern Lake Michigan.

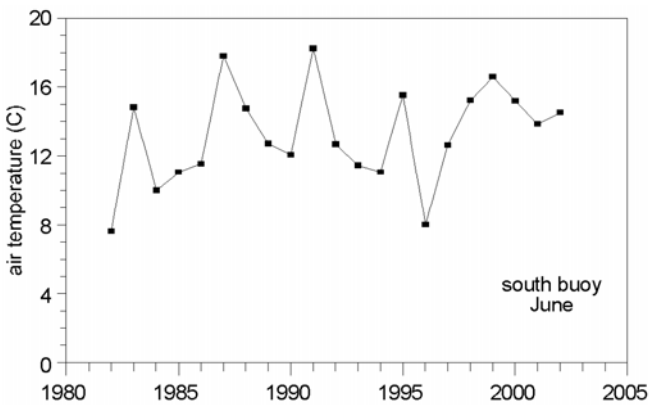

Figure 1.4.8. Mean June air temperatures in southern Lake Michigan.

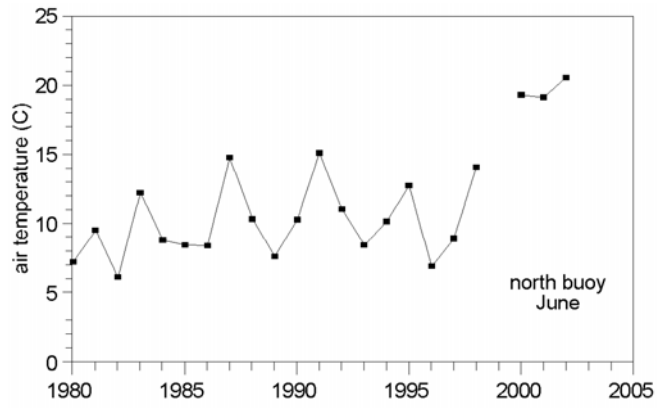

Figure 1.4.9. Mean June air temperatures in northern Lake Michigan.

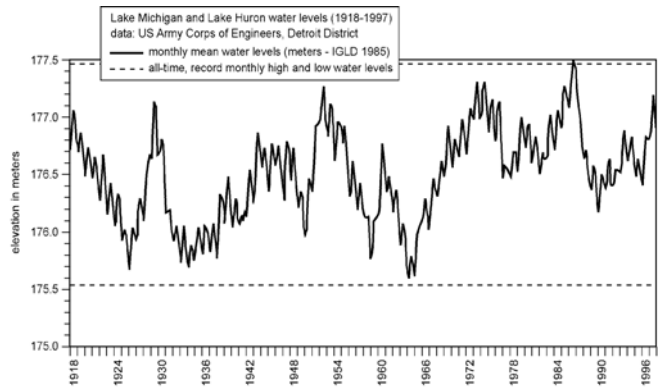

Figure 1.4.10. Record of mean monthly water levels for Lake Michigan.

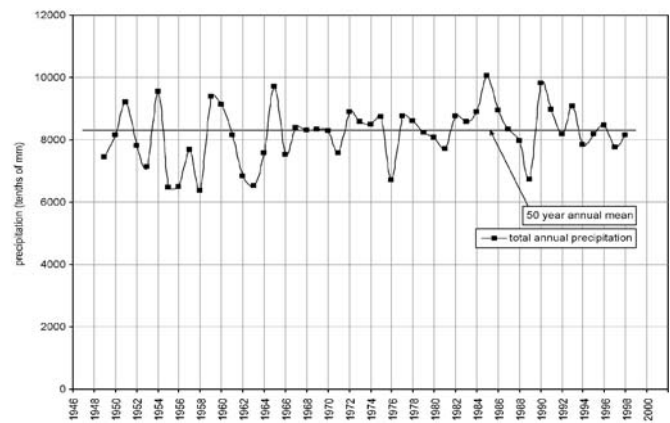

Figure 1.4.11. Annual precipitation to Lake Michigan between 1949 and 1998.

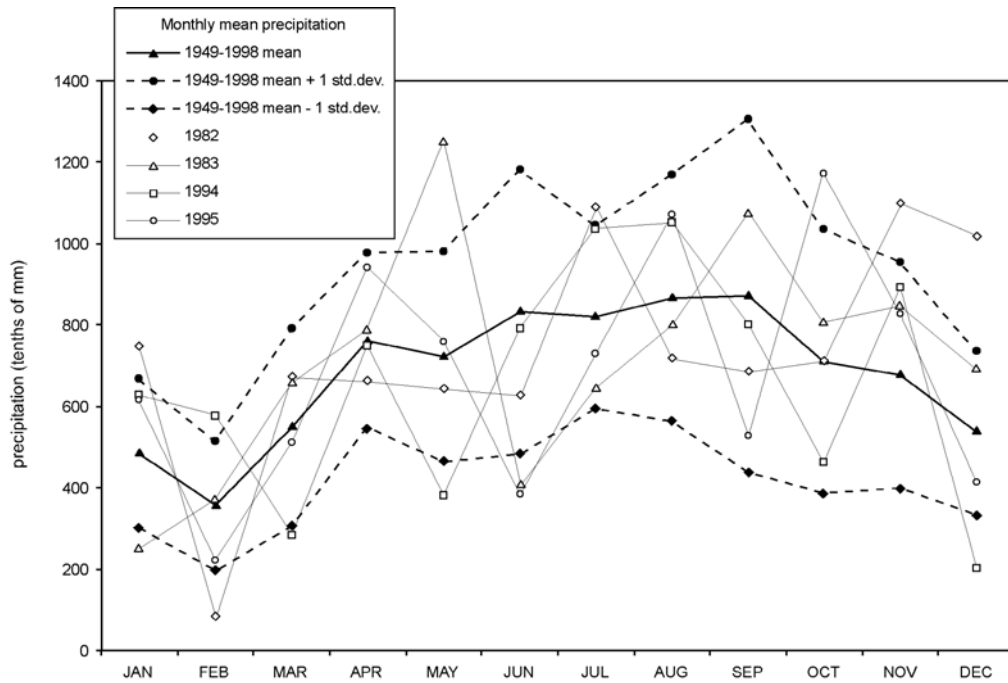

Figure 1.4.12. Comparison of 1982, 1983, 1984, and 1995 monthly mean precipitation to the means for the period of 1949 through 1998.

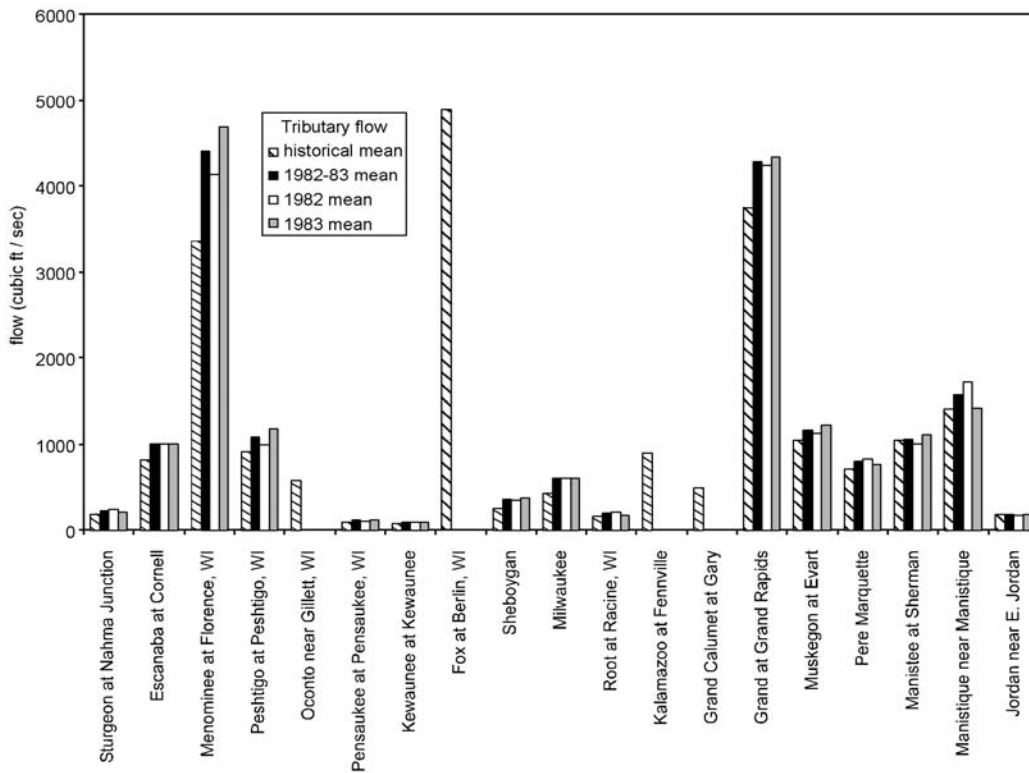

Figure 1.4.13. Comparison of tributary flow for hydrodynamic model calibration (1982-1983) to the historic means.

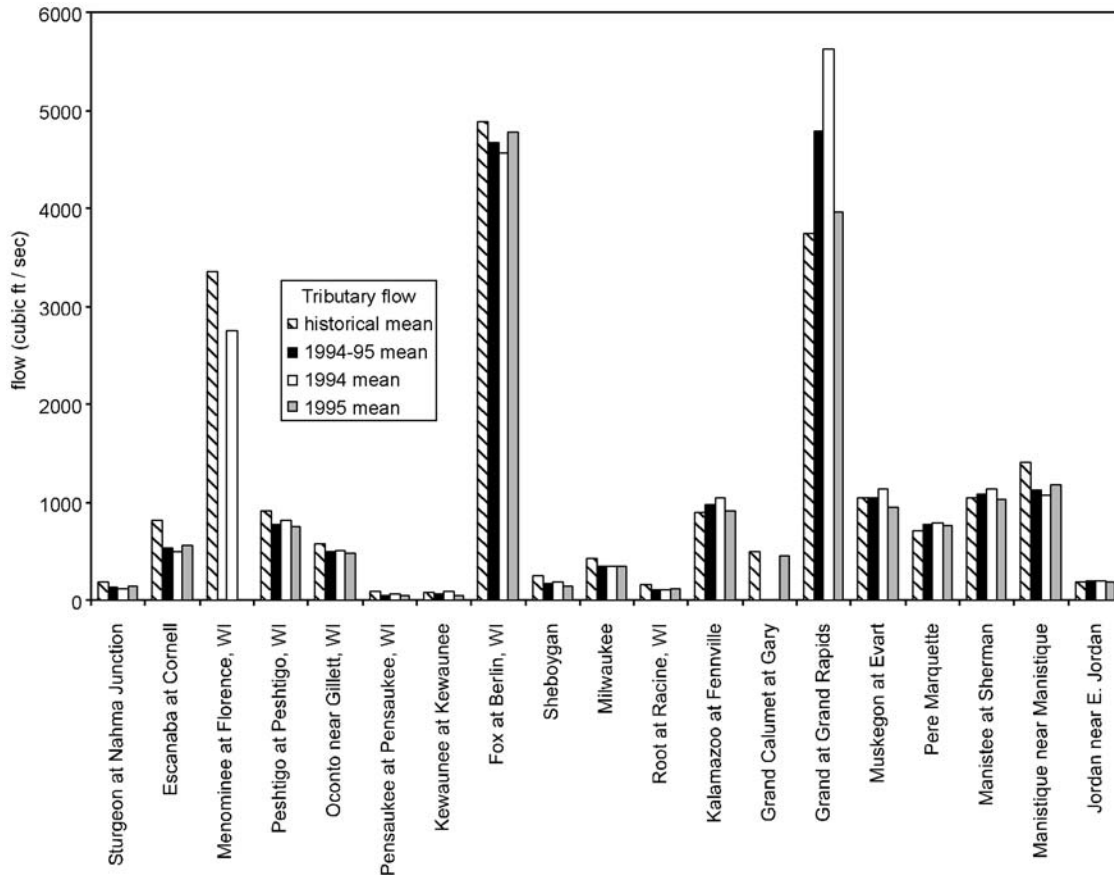

Figure 1.4.14. Comparison of tributary flow for the study period (1994-1995) to the historic means.

transitional, and depositional. The definitions of these zones were based on deep-water wave data.

The complete records of NOAA buoy data for Lake Michigan at the northern buoy (45002) and southern buoy (45007) were assessed to determine the representativeness of the 1994-1995 wave data relative to the period of record (U.S. Department of Commerce, 2002). For 45002, the record began in 1979; whereas, the 45007 record began in 1981. These data were chosen because they are the most complete data sets for Lake Michigan deep-water waves. Determining the representativeness of one period of time relative to the entire record can be very complex and can lead to mixed conclusions. The entire period of record from each buoy was examined with respect to wave height, maximum wave height in any one year, the water depth at which waves begin to interact with the lake bottom, and the horizontal component of the wave's orbital velocity. Some of these were done with respect to the mean

and median. Velocity and water depth of interaction with the lake bottom were calculated on the basis of deep-water linear wave theory (Sverdrup *et al.*, 1942).

$$L = gT^2 / 2\pi \tag{1.4.1}$$

where,

L = wave length, cm

T = wave period, s

g = acceleration due to gravity, cm/s²

The water depth at which a wave begins to interact with the lake bottom (*d*) is equal to one-half the calculated wave length (*L*) (Sverdrup *et al.*, 1942).

The maximum horizontal component of a wave's orbital velocity (μ_{max}) was calculated with the

following equation (U.S. Army Coastal Engineering Research Center, 1973).

$$\mu_{\max} = \frac{H\sqrt{gd}}{2\pi L} \quad (1.4.2)$$

where,

H = wave height, cm

For both 1994 and 1995, mean wave heights at the northern and southern buoys were similar to historic mean and median observations (Table 1.4.2). Maximum wave heights for these years were high at the northern buoy relative to the historical mean and median heights for both years; however, they were less than the historical maximum wave height at both locations. At the southern buoy, maximum wave heights were high in 1982, 1983, and 1995 relative to historic mean and median maximum heights. At this location, the 1994 maximum height was lower than historic means and medians. For all calibration and study years, the maximum wave heights were neither an extreme high or low for the period of observation at the two locations.

At both buoys, the annual maximum water depths of wave interaction with sediments were not unusual. Though at the maximum in the southern basin (78 m), the maximum was achieved for more than one-half the years of record (Table 1.4.2).

During the calibration and study years, the annual maximum horizontal component of wave orbital velocity ranged between 11.2 and 15.0 cm/s (Table 1.4.2). These observations were close to their historical means. Chambers and Eadie (1981) hypothesized that thermal bar migration generated currents of four to 13.4 cm/s which were enough to resuspend surficial shelf sediment. For fine/medium sand in southwestern Lake Michigan, a near-bottom wave orbital velocity of 17.8 cm/s was enough to initiate resuspension (Lesht, 1989). Similar results (18 cm/s) were found for silty sand in southeastern Lake Michigan (Lesht and Hawley 1987). Sediment resuspension was found in Hamilton Harbor at bottom current speeds of 4.8 cm/s (Brassard and Morris, 1997). Thus the annual maximum horizontal component of wave orbital velocity was sufficient to at least once, on an annual basis, resuspend fine-grained (silt and clay) sediment.

Therefore, it appeared that the repetitious use of the 1994 through 1995 Princeton Ocean Model (POM) results will not introduce bias to the results. Though 1994 and 1995 were not the perfect mean and median situation, they were not singular extremes of what has historically occurred within the lake.

1.4.8 Summary

Lake Michigan is acted upon by a number of physical parameters that impact the physics, chemistry, and biology of the lake. For a lake the size of Lake Michigan, changes in these parameters can lead to significant changes, especially when models are used in long-term predictions to predict the outcome of various scenarios. The primary driving forces are wind, air temperature, and precipitation. These impact tributary flows, lake levels, waves, water circulation, water temperature, and ice cover. For the period of record, these driving forces varied from year-to-year. The period of 1982 to 1983 was used to calibrate the hydrodynamic models. Fortunately for the period of time the models were calibrated, conditions were not at any extreme. This was also true for the period of 1994 and 1995 when the models were applied. However, the impact of ice cover remains a concern and will have to be dealt with in the future.

Temperature can impact atrazine modeling. Air temperature impacts how quickly the lake warms in any one year. Water temperature impacts the volatilization of atrazine. There appears to be a four-year cycle of quicker warming which exists within a trend of general warming of the lake. The trend of warming may be part of a longer term undocumented cycle or may be related to climate change. For future modeling, these cycles and trends will have to be considered to improve long-term predictions.

Precipitation will impact both lake levels and tributary flows. Tributary flows have an impact on the delivery of contaminants to the lake. Precipitation was within the normal range for all years of modeling interest, resulting in lake levels and tributary flows that were within normal bounds. Changes in lake levels as well as the response of tributaries to precipitation events will need to be considered for future modeling used to predict changes of contaminants within the lake.

Table 1.4.2. Descriptive Wave Statistics for POM Calibration Years (1982-1983) and Study Years (1994-1995) Compared to the Period of Record for NOAA's Buoys in Northern and Southern Lake Michigan

Description	Historical Mean	Historical Median	Historical Minimum (Year)	Historical Maximum (Year)	1982	1983	1994	1995
Northern Buoy								
Annual Maximum Wave Height, m	4.3	4.1	3.1 (1996)	5.9 (1991)	4.0	4.5	4.6	5.3
Wave Height, m	0.7	0.6	0.6 (numerous)	0.9 (several)	0.8 (Mean)	0.9 (Mean)	0.6 (Mean)	0.7 (Mean)
Annual Maximum Water Depth of Wave Interaction with Bottom Sediments, m	14.1	65		96 (1991)	65	78	78	78
Annual Horizontal Component of Maximum Orbital Wave Velocity, cm/s	4.9	13.4		18.0 (1984)	12.1	11.3	12.7	15.0
Southern Buoy								
Annual Maximum Wave Height, m	4.5	4.2	2.8 (1991)	6.2 (1998)	4.9	5.3	3.7	5.2
Wave Height, m	0.6	0.5	0.5 (several)	0.8 (numerous)	0.8 (Mean)	0.8 (Mean)	0.6 (Mean)	0.5 (Mean)
Annual Maximum Water Depth of Wave Interaction with Bottom Sediments, m	12.7	65		78 (numerous)	65	78	65	78
Annual Horizontal Component of Maximum Orbital Wave Velocity, cm/s	4.6	13.6		19.2 (1998)	13.1	15.0	11.2	14.7

References

- Assel, R.A., D.C. Norton, and K.C. Cronk. 2002. A Great Lakes Digital Ice Cover Data Base for Winters 1973-2000. National Oceanic and Atmospheric Administration, Great Lakes Environmental Research Laboratory, Ann Arbor, Michigan. NOAA Technical Memorandum ERL GLERL-121, 46 pp.
- Assel, R.A. 2003. An Electronic Atlas of Great Lakes Ice Cover. NOAA Great Lakes Ice Atlas. National Oceanic and Atmospheric Administration, Great Lakes Environmental Research Laboratory, Ann Arbor, Michigan.
- Brassard, P. and W. Morris. 1997. Resuspension and Redistribution of Sediments in Hamilton Harbor. *J. Great Lakes Res.*, 23(1):74-85.
- Campbell, J.E., A.H. Clites, and G.M. Green. 1987. Measurements of Ice Motion in Lake Erie Using Satellite-Tracked Drifter Buoys. National Oceanic and Atmospheric Administration, Great Lakes Environmental Research Laboratory, Ann Arbor, Michigan. NOAA Technical Memorandum ERL GLERL-30, 22 pp.

-
- Chambers, R.L. and B.L. Eadie. 1981. Nepheloid and Suspended Particulate Matter in Southeastern Lake Michigan. *Sedimentology*, 28(3):439-447.
- Croley, T.E., II and T.S. Hunter. 1994. Great Lakes Monthly Hydrologic Data. National Oceanic and Atmospheric Administration, Great Lakes Environmental Research Laboratory, Ann Arbor, Michigan. NOAA Technical Memorandum ERL GLERL-83, 13 pp.
- Lesht, B.M. and N. Hawley. 1987. Near-Bottom Currents and Suspended Sediment Concentration in Southeastern Lake Michigan. *J. Great Lakes Res.*, 13(3):375-386.
- Lesht, B.M. 1989. Climatology of Sediment Transport on Indiana Shoals, Lake Michigan. *J. Great Lakes Res.*, 15(3):486-497.
- Schwab, D.J. and D. Beletsky. 1998. Lake Michigan Mass Balance Study: Hydrodynamic Modeling Project. National Oceanic and Atmospheric Administration, Great Lakes Environmental Research Laboratory, Ann Arbor, Michigan. NOAA Technical Memorandum ERL GLERL-108, 53 pp.
- Sverdrup, H.U., M.W. Johnson, and R.H. Fleming. 1942. *The Oceans: Their Physics, Chemistry, and General Biology*. Prentice-Hall, Incorporated, New Jersey, 1,087 pp.
- U.S. Army Coastal Engineering Research Center. 1973. *Shore Protection Manual*, Volumes 1, 2, and 3. U.S. Army Corps of Engineers, U.S. Army Engineering Waterways Experiment Station, Vicksburg, Mississippi.
- U.S. Department of Commerce. 2002. *National Data Buoys*. National Weather Service, National Oceanic and Atmospheric Administration, Ann Arbor, Michigan. National Data Buoy Center files downloaded from www.ndbc.noaa.gov.

PART 1

INTRODUCTION

Chapter 5. PCBs in the Lake Michigan Ecosystem

Ronald Rossmann
U.S. Environmental Protection Agency
Office of Research and Development
National Health and Environmental Effects
Research Laboratory
Mid-Continent Ecology Division
Large Lakes and Rivers Forecasting Research
Branch
Large Lakes Research Station
9311 Groh Road
Grosse Ile, Michigan 48138

1.5.1 Introduction

Within this chapter, polychlorinated biphenyl (PCB) data for Lake Michigan are summarized. These data are then compared to historical data. Summaries of the 1994-1995 data are taken directly from the "Results of the Lake Michigan Mass Balance Study: Polychlorinated Biphenyls and *trans*-Nonachlor Data Report" (McCarty *et al.*, 2004) and are referenced appropriately. Presentation of the data are arranged by media.

Details of the use of PCBs within the Lake Michigan basin are difficult to document. However, a list of significant dates for the basin was compiled from a variety of online sources. PCBs appear to have been first purchased for use in the basin in 1948 (Table 1.5.1). Use appears to have been phased out by 1972. Remediation of PCBs at various locations began in the late 1980s with Sheboygan Harbor

being the earliest completed in 1991. Remediation continues to this day.

1.5.2 Atmospheric

Atmospheric concentrations measured include vapor phase, precipitation, particulate, and dry deposition PCBs. Each of these is plotted for stations within the basin that are representative of the annual seasons for 1994 and 1995.

1.5.2.1 Vapor Phase

Median vapor phase concentrations of PCBs are elevated in the northern end of the lake and especially offshore of Chicago (Figure 1.5.1). The elevation in the northern end of the lake is related to the air station at Beaver Island. The site was discovered to be impacted by a local source of contamination and was not representative of that region of the lake.

Complete data are summarized in Table 1.5.2. Monthly mean composite concentrations ranged from 110 pg/m³ outside the basin to 2600 pg/m³ at IIT Chicago (McCarty *et al.*, 2004).

Historic information are sparse. Data sets vary in temporal and spatial scales. Data sets found include the period of 1976, 1979, and 1992-2002 (Murphy and Rzeszutko, 1977; Rice *et al.*, 1982; The Integrated Atmospheric Deposition Network, 2004). The Integrated Atmospheric Deposition Network (IADN) data for 2001 and 2002 were presented in a graphic by Boughton (2004) and attributed to the IADN Steering Committee, unpublished 2004. Vapor

Table 1.5.1. Significant Dates in the History of PCBs in the Lake Michigan Basin

Date	Event
1865	First PCB-like chemical discovered
1881	First PCBs synthesized
1914	Measurable amounts of PCBs found in bird feathers
1927	PCBs first manufactured at Anniston, Alabama
1935	PCBs manufactured at Anniston, Alabama and Sauget, Illinois
1948-1971	Outboard Marine Corporation at Waukegan, Illinois purchased eight million gallons of hydraulic fluid with PCBs
Mid-1950s to Mid-1960s	PCBs loaded to Kalamazoo River from deinking
1950s to 1980s	PCBs discharged to Manistique River and Harbor
1954	Appleton Paper Company began using PCBs as PCB-coated carbonless copy paper
1959-1971	PCBs used by Tecumseh Products Company as a hydraulic fluid was loaded to Sheboygan River
1959-1972	Outboard Marine Corporation at Waukegan, Illinois used hydraulic fluid with PCBs for die-casting
1969-1970	Paper company discharges of PCBs to Fox River peaked
1970	PCB production peaked at 85 million pounds and huge contamination noted at Sauget, Illinois plant
1971-1972	Appleton Paper Company and NCR Corporation phased out PCB use. Recycling of carbonless paper had occurred for several decades
1973	U.S. Food and Drug Administration (USFDA) establish 5 ppm PCB tolerance level in fish
1975	124,000 cans of salmon from Lake Michigan seized because of PCBs
1977	PCB production ends
1984	USFDA lowered PCB tolerance level in fish to 2 ppm
1985	Commercial fishing for carp and other valuable species outlawed on Green Bay
1991	End Sheboygan River PCB remediation of upper river
1991	U.S. Department of Health and Human Services label PCBs as possible carcinogen
1992	End Waukegan Harbor PCB remediation
1998	The eight Great Lakes states agreed on a "Great Lakes Protocol for Fish Consumption Advisories" that lowered the regional standard from the USFDA commercial standard of 2 ppm down to 0.05 ppm
1997-1998	Milwaukee River PCB remediation
2001	Manistique Harbor PCB remediation completed
2002	Possibly begin Grand Calumet River PCB remediation

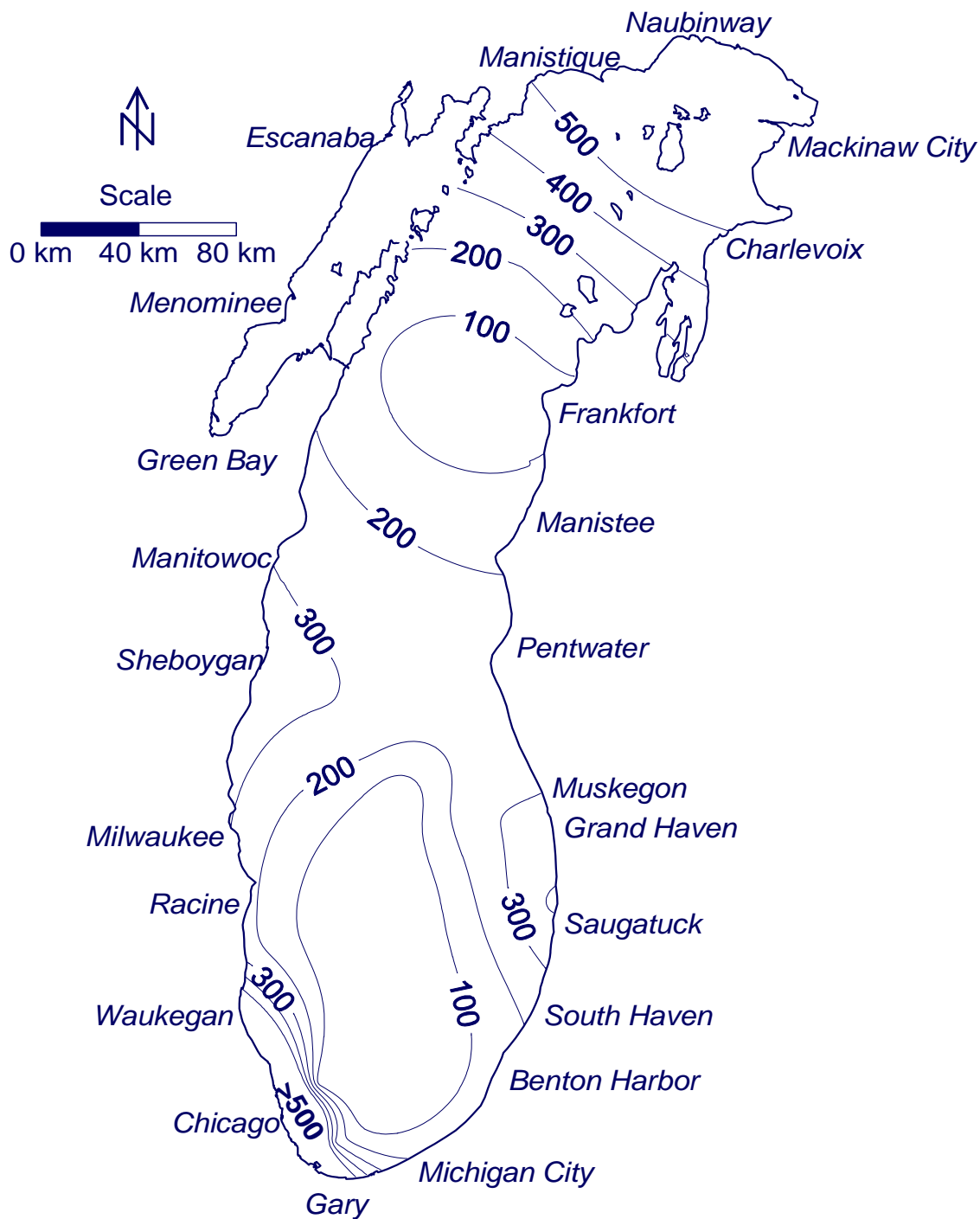

Figure 1.5.1. Median concentration of vapor phase PCBs in the atmosphere during 1994 and 1995 for all seasons of both years.

Table 1.5.2. Monthly Composite Concentrations of Vapor Phase Total PCBs Measured in Samples Collected Around Lake Michigan From April 1994 to October 1995

Sampling Station		N	Mean (pg/m ³)	SD (pg/m ³)
Shoreline Atmospheric Stations	Beaver Island	19	970	880
	Chiwaukee Prairie	19	320	230
	IIT Chicago	19	2600	1900
	Indiana Dunes	19	680	580
	Manitowoc	19	350	260
	Muskegon	18	490	410
	Sleeping Bear Dunes	15	380	550
	South Haven	19	400	360
Out-of-Basin Atmospheric Stations	Bondville	19	250	150
	Brule River	19	110	110
	Eagle Harbor	4	260	370
Over-Water Atmospheric Stations	Empire Michigan	4	170	77
	GB24M	4	940	1600
	1	5	990	1500
	5	6	670	590
	6	4	1200	1800
	110	3	810	1200
	18M	5	560	930
	23M	4	490	600
	27M	5	360	410
	280	4	480	570
	310	3	650	430
	380	1	290	NA
	40M	4	340	460
	41	2	21	6.4
	47M	5	410	630
MB19M	1	280	NA	
11M	2	2200	3100	

phase PCBs have decreased dramatically since the very first measurements in 1976 (Figure 1.5.2); however, the IADN data set vapor phase concentrations at Sleeping Bear Dunes does not show a definitive trend between 1992 and 2002 (Figure 1.5.3). For the period of 1992 through 2001, an examination of the temperature corrected PCB partial pressure IADN data revealed that partial pressures were declining with a half-life rate of 8.3 ± 1.5 years (Buehler *et al.*, 2004). The 1994-1995 concentrations measured during the Lake Michigan Mass Balance Project (LMMBP) are considerably higher (21 to 2,600 pg/m³) than concentrations observed at Sleeping Bear Dunes (50 to 110 pg/m³).

Thus it appears that Sleeping Bear Dunes does not represent the Lake Michigan basin. Concentrations observed at the Chicago IADN station were greater than 1,000 pg/m³ for all the years (1993-2000) of observation (Buehler and Hites, 2002). Recently, an average concentration of 1,900 pg/m³ PCBs was reported for June 2001 at Milwaukee, Wisconsin (Wethington and Hornbuckle, 2005).

1.5.2.2 Precipitation

Median precipitation concentrations of PCBs are elevated in the southern end of the lake and

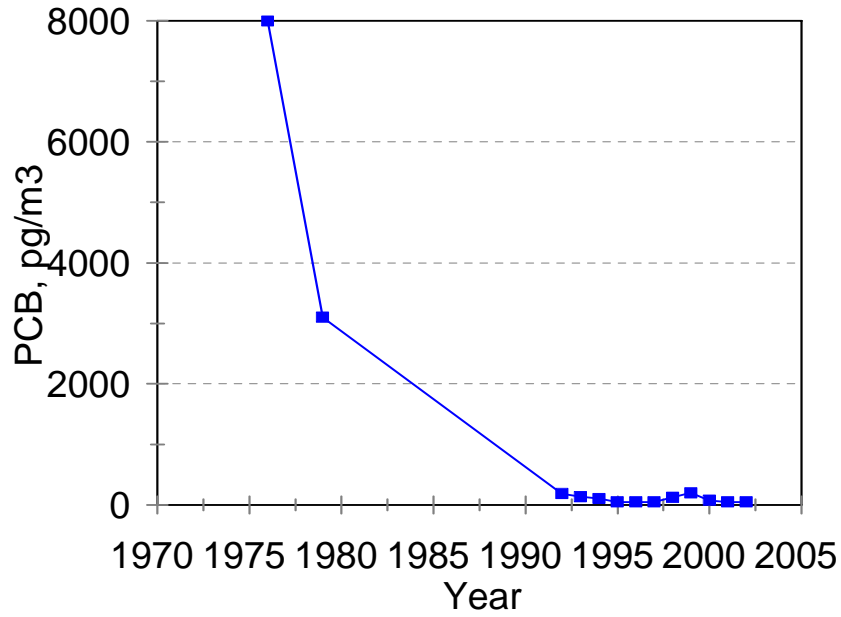

Figure 1.5.2. Time variation of vapor phase PCBs in Lake Michigan.

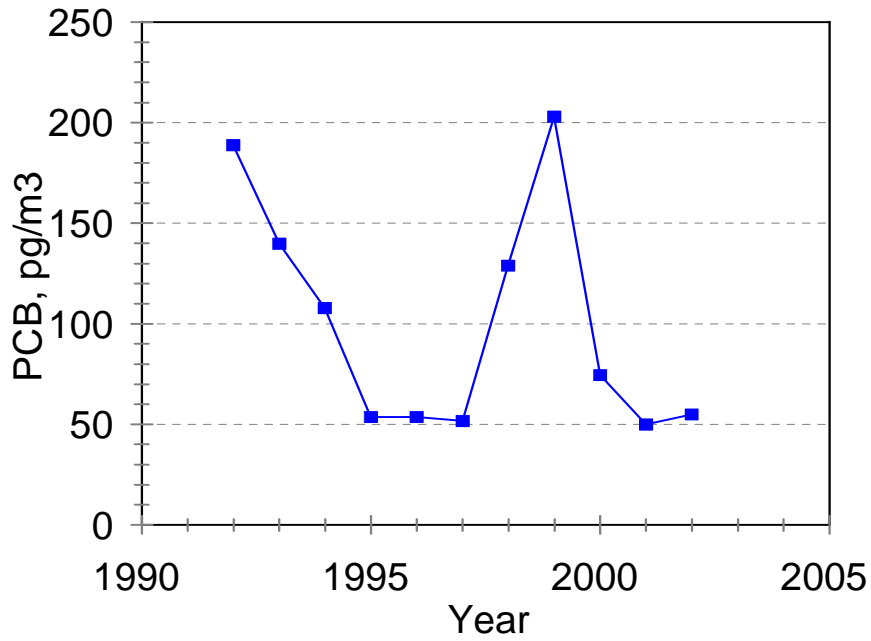

Figure 1.5.3. Time variation of vapor phase PCBs in Lake Michigan at Sleeping Bear Dunes based on IADN data.

especially offshore of Chicago (Figure 1.5.4). Concentrations decline from south-to-north.

Complete data are summarized in Table 1.5.3. Monthly mean composite concentrations ranged from 290 pg/L outside the basin to 16,000 pg/L at IIT Chicago (McCarty *et al.*, 2004).

Historic concentrations of PCBs in precipitation were only available from IADN (2004). The time trend of the data are plotted in Figure 1.5.5. There is no apparent trend in the data. Again, the 1994-1995 basin results (360 to 16,000 ng/L) are higher than those reported by IADN for Sleeping Bear Dunes (955 to 2,849 ng/L). Sleeping Bear Dunes may under-represent the PCB concentration in precipitation. Chicago concentrations ranged between 3,500 and 8,600 ng/L for the 1996-2000 period of observation (IADN, 2004).

1.5.2.3 Particulate

Median atmospheric particulate concentrations of PCBs are elevated in the southern end of the lake and especially offshore of Chicago (Figure 1.5.6). Concentrations decline from south-to-north and then increase slightly in the northern end of the lake. The elevation in the northern end of the lake is related to the air station at Beaver Island. The site was discovered to be impacted by a local source of contamination and was not representative of that region of the lake.

Complete data are summarized in Table 1.5.4. Monthly mean composite concentrations ranged from 0.37 pg/m³ at an over-water station to 91 pg/m³ at IIT Chicago (McCarty *et al.*, 2004).

Historic particulate concentrations of PCBs were only available from IADN (2004). The time trend of the data are plotted in Figure 1.5.7. Again, the 1994-1995 basin results (0.37 to 91 pg/m³) are higher than those reported by IADN at Sleeping Bear Dunes (7.8 to 9.2 pg/m³). Sleeping Bear Dunes under-represents the PCB concentration in particulates. Samples collected in June 2001 at Milwaukee averaged 50 pg/m³ (Wethington and Hornbuckle, 2005).

1.5.2.4 Dry Deposition

Some measurements were made of PCB concentrations in dry deposition (Table 1.5.5). Highest mean concentration (315,000 ng/m²) occurred at South Haven and the lowest mean concentration (1,830 ng/m²) occurred at the Chicago SWFP crib intake (McCarty *et al.*, 2004). Thus the mean range was very large and fluxes could be high. However, the limited number of data points and high standard deviations precluded any further interpretation of the data.

1.5.3 Lake Water

Water concentrations measured included dissolved, particulate, and total PCBs. Results are plotted for the 1994 through 1995 stations. Only stations representative of all annual seasons were included in the figures.

1.5.3.1 Total PCBs

Total PCB concentrations in lake water were elevated in southern and central Lake Michigan (Figure 1.5.8). Of note were high concentrations offshore of Milwaukee and along the eastern shoreline from South Haven to Manistee. Highest concentrations were found along the shoreline of the lake. Concentrations are summarized in Table 1.5.6 and averaged 0.25 ppb in 1994 and 0.27 ppb in 1995 (McCarty *et al.*, 2004).

Historic data were available for the period of 1976 through 1994 (Chambers and Eadie, 1980; Rice *et al.*, 1982; Anderson *et al.*, 1999; Offenbergh and Baker, 2000; Bicksler, 1996; Murphy and Rzeszutko, 1977; Swackhamer and Armstrong, 1987; Filkins *et al.*, 1983; Lefkovitz, 1987; Pearson *et al.*, 1996). Since 1976, concentrations have dramatically decreased (Figure 1.5.9). Expanding the scale and looking only at the 1986 and later data, concentrations decrease from 1986 to 1993; however, they appear constant since 1993 (Figure 1.5.10).

1.5.3.2 Dissolved PCBs

Dissolved PCBs had a pattern similar to that of total PCBs. Concentrations were highest in the southern basin of the lake with special note of the Milwaukee, Michigan City, Saugatuck, and Grand Haven

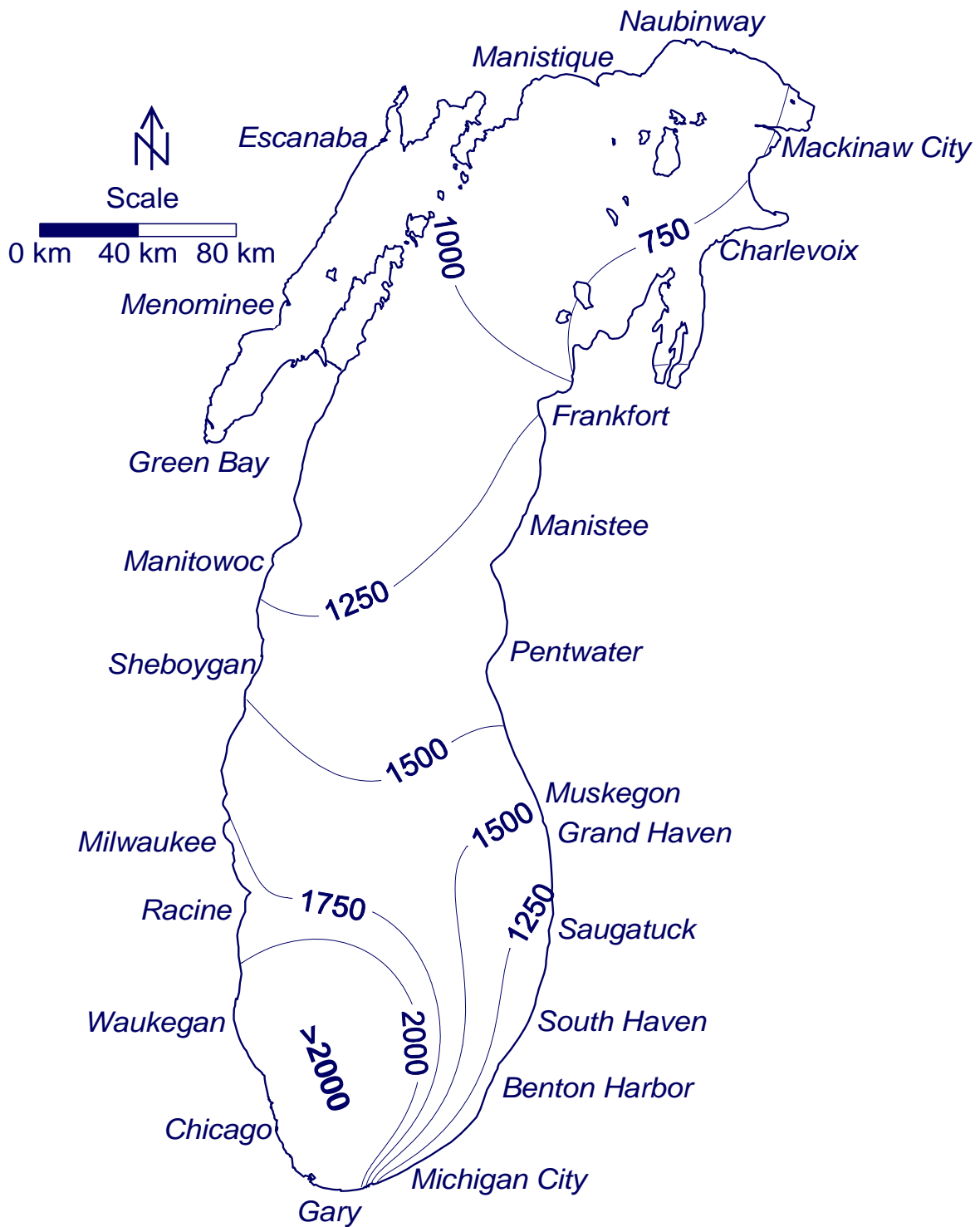

Figure 1.5.4. Median concentration of wet (precipitation) PCBs in the atmosphere during 1994 and 1995 for all seasons of both years.

Table 1.5.3. Monthly Composite Concentrations of Total PCBs Measured in Precipitation Samples Collected Around Lake Michigan From April 1994 to October 1995

Sampling Station		N	Mean (pg/L)	SD (pg/L)
Shoreline Atmospheric Stations	Beaver Island	20	1900	2800
	Chiwaukee Prairie	20	1800	1200
	IIT Chicago	17	16000	28000
	Indiana Dunes	21	1500	1500
	Manitowoc	20	2600	4200
	Muskegon	20	2600	4000
	Sleeping Bear Dunes	16	1300	880
	South Haven	21	3800	10000
Out-of-Basin Atmospheric Stations	Bondville	21	1700	1100
	Brule River	19	1700	2900
	Eagle Harbor	4	290	300
Over-Water Atmospheric Stations	Empire Michigan	4	2000	2000
	GB17	1	2300	
	GB24M	1	680	
	1	1	750	
	5	1	1500	
	23M	1	360	
	380	1	510	

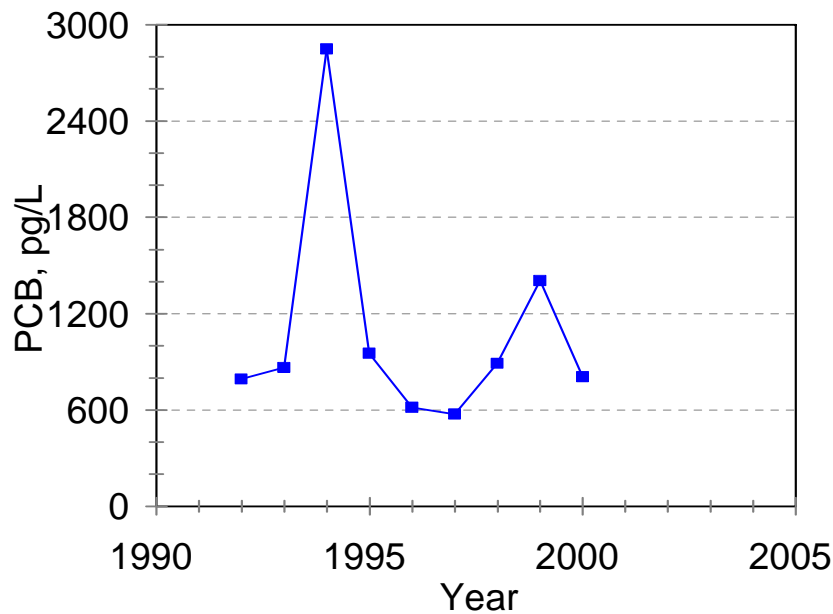

Figure 1.5.5. Time variation of precipitation PCBs in Lake Michigan at Sleeping Bear Dunes based on IADN data.

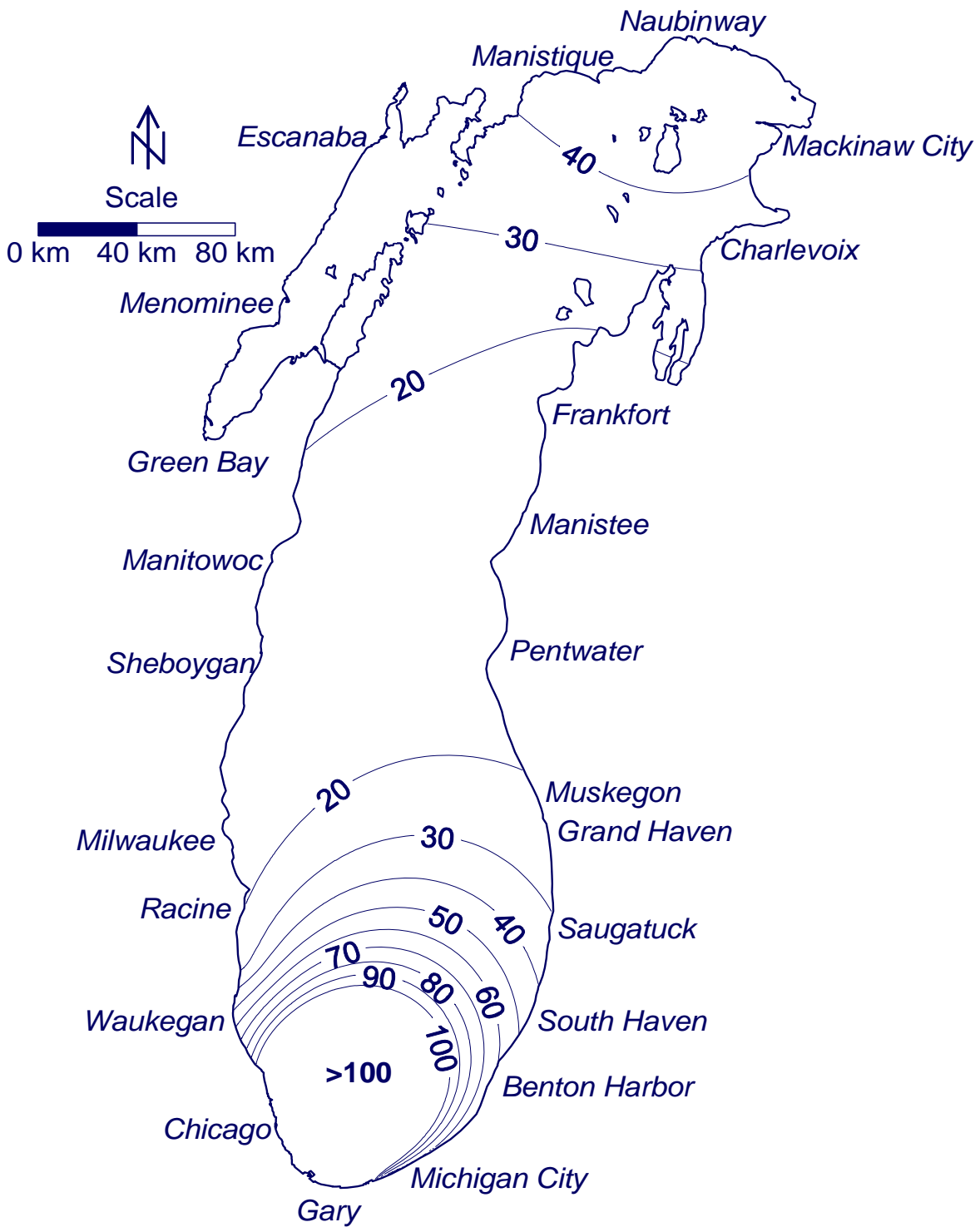

Figure 1.5.6. Median concentration of particulate PCBs in the atmosphere during 1994 and 1995 for all seasons of both years.

Table 1.5.4. Monthly Composite Concentrations of Particulate Phase Total PCBs Measured in Samples Collected Around Lake Michigan From April 1994 to October 1995

Sampling Station		N	Mean (pg/m ³)	SD (pg/m ³)
Shoreline Atmospheric Stations	Beaver Island	18	52	29
	Chiwaukee Prairie	19	22	6.1
	IIT Chicago	19	91	48
	Indiana Dunes	19	33	12
	Manitowoc	19	26	22
	Muskegon	16	24	12
	Sleeping Bear Dunes	15	18	21
	South Haven	18	23	12
Out-of-Basin Atmospheric Stations	Bondville	19	25	14
	Brule River	18	21	14
	Eagle Harbor	4	14	4.7
Over-Water Atmospheric Stations	Spatial Composites	18	19	21
	Empire Michigan	4	14	4.0
	GB24M	2	3.9	5.2
	1	1	2.6	
	5	3	17	27
	6	1	0.37	

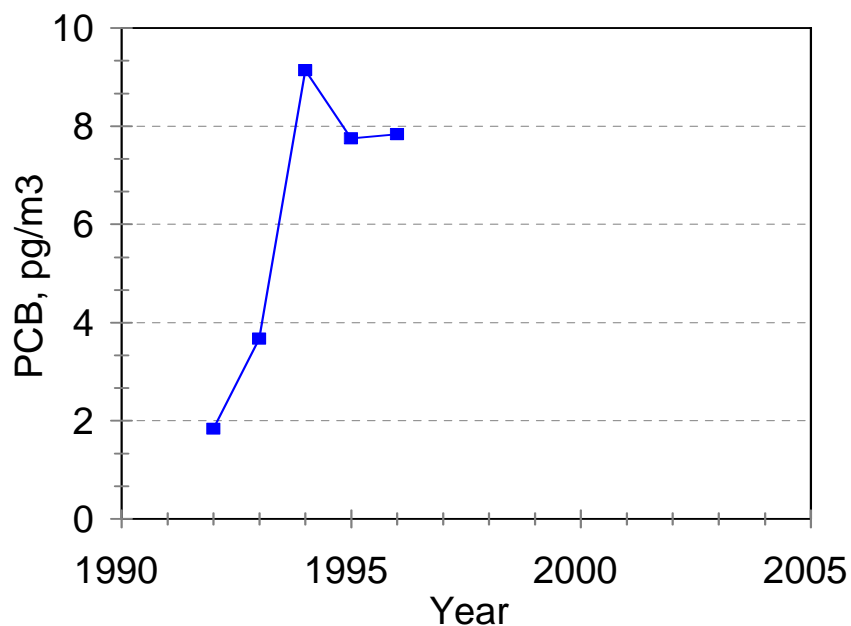

Figure 1.5.7. Time variation of atmospheric particulate PCBs in Lake Michigan at Sleeping Bear Dunes based on IADN data.

Table 1.5.5. Monthly Composite Concentrations of PCBs Measured in Dry Deposition

Sampling Station	N	Mean (ng/m ²)	SD (ng/m ²)
Chicago SWFP Crib Intake	9	1830	1710
Harrison Crib	1	5400	
IIT Chicago	13	7060	6480
Sleeping Bear Dunes	8	6120	7940
South Haven	11	315,000	1,020,000

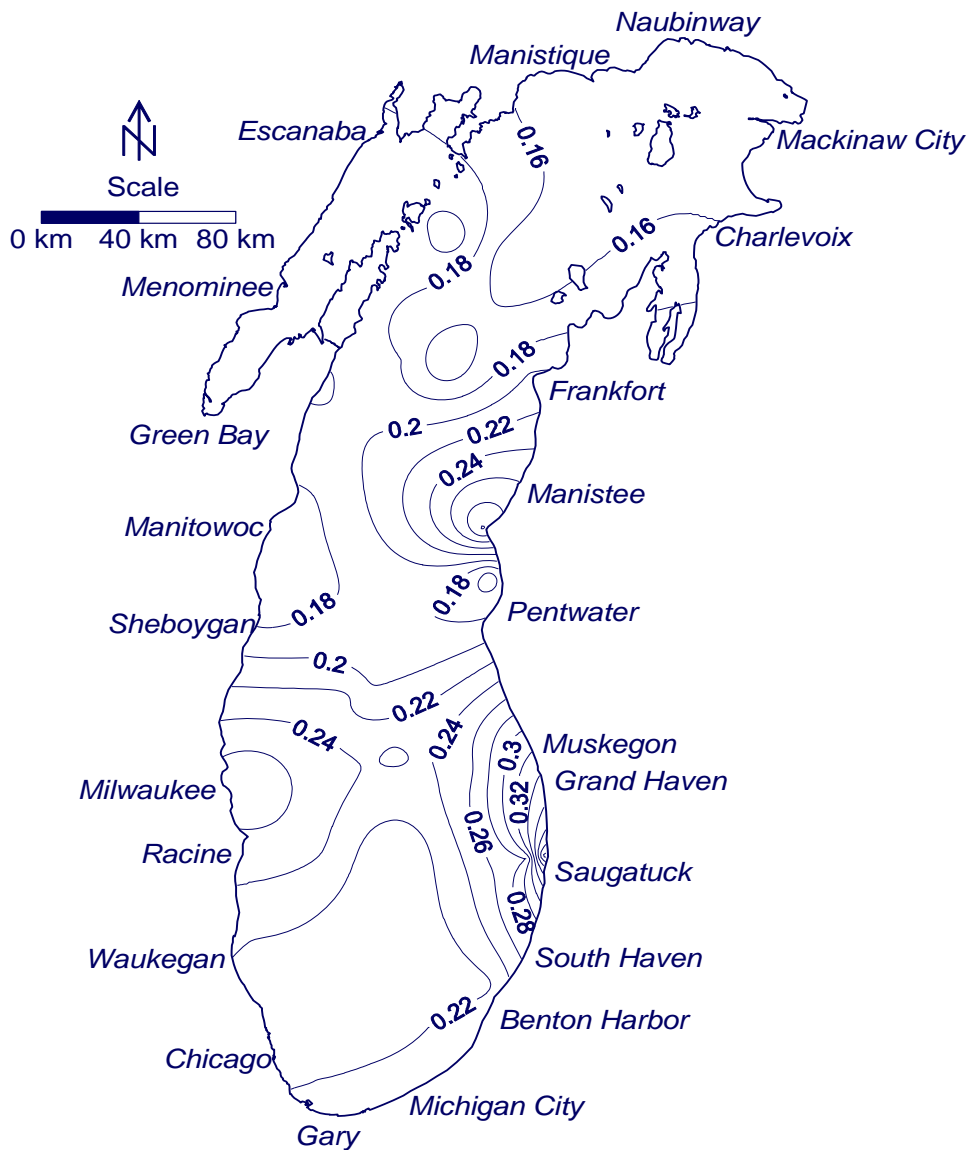

Figure 1.5.8. Distribution of total PCBs (ng/L) in 1994-1995 Lake Michigan water.

Table 1.5.6. Concentrations of PCBs in 1994-1995 Lake Michigan Water (ng/L)

Year	Descriptive Statistics	Dissolved PCBs	Particulate PCBs	Total PCBs
1994	Mean	0.17	0.079	0.25
1994	Standard Deviation	0.11	0.088	0.16
1994	Number of Samples	181	181	181
1995	Mean	0.21	0.066	0.27
1995	Standard Deviation	0.16	0.060	0.19
1995	Number of Samples	142	142	142

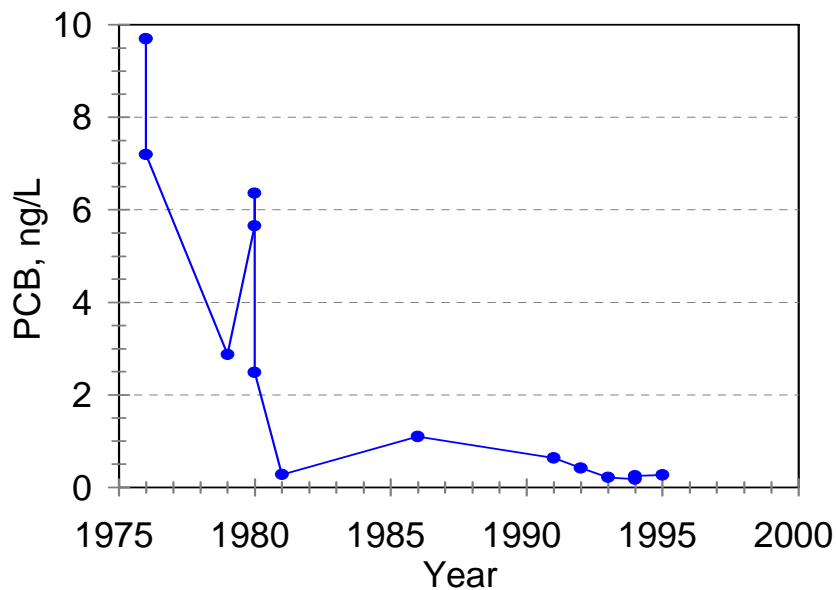

Figure 1.5.9. Time variation of total PCBs in Lake Michigan water. Historic data from Chambers and Eadie (1980), Rice *et al.* (1982), Anderson *et al.* (1999), Offenber and Baker (2000), Bicksler (1996), Murphy and Rzeszutko (1977), Swackhamer and Armstrong (1987), Filkins *et al.* (1983), Lefkovitz (1987), and Pearson *et al.* (1996).

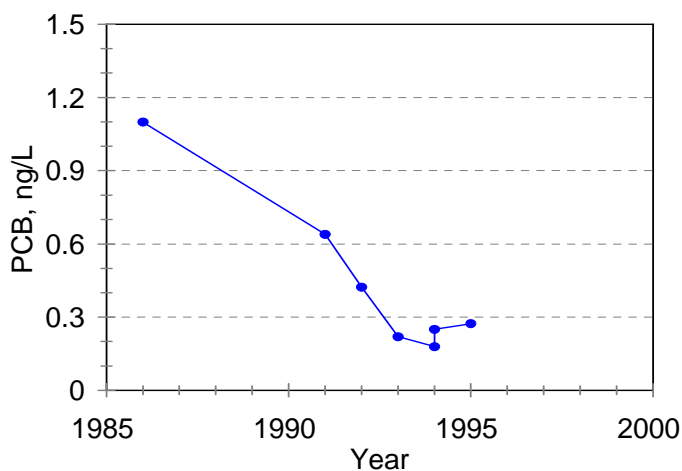

Figure 1.5.10. Time variation of total PCBs in Lake Michigan water since 1986. Historic data from Anderson *et al.* (1999), Offenber and Baker (2000), Bicksler (1996), Lefkovitz (1987), and Pearson *et al.* (1996).

locations (Figure 1.5.11). Green Bay appears as a source of dissolved PCBs to the lake. For the lake as a whole, concentrations averaged 0.17 ppb with a standard deviation of 0.11 ppb in 1994 and 0.21 ppb with a standard deviation of 0.16 ppb in 1995 (Table 1.5.6) (McCarty *et al.*, 2004).

During the summer thermal stratification, dissolved PCB concentrations in the hypolimnion are notably high offshore of the region bounded by Racine and Michigan City and centered on Waukegan (Figure 1.5.12). This region appears to continue to be impacted by the historical contamination at Waukegan (Swackhamer and Armstrong, 1988).

Dissolved PCB data were found for the period of 1991 through 1994 (Anderson *et al.*, 1999; Offenber and Baker 2000; Pearson *et al.*, 1996). What few data are available illustrate a downward trend in concentration (Figure 1.5.13). This is similar to the trend observed for total PCBs.

1.5.3.3 Particulate PCBs

Particulate PCB concentrations were highest along the shoreline, notably at Saugatuck and especially at Milwaukee (Figure 1.5.14). Concentrations averaged 0.079 ppb with a standard deviation of 0.088 ppb in 1994 and 0.066 ppb with a standard deviation of 0.060 ppb in 1995 (Table 1.5.6) (McCarty *et al.*, 2004).

Particulate PCB data were derived from the difference between total and dissolved concentrations for the period of 1991 through 1994 from the data of Anderson *et al.* (1999), Offenber and Baker (2000), and Pearson *et al.* (1996). The variation of these and the project data is one of a decreasing trend (Figure 1.5.15).

1.5.4 Tributaries

Tributary water concentrations measured included dissolved and particulate forms. Mean particulate concentrations were higher than mean dissolved concentrations in the Fox, Grand Calumet, Grand, Kalamazoo, Pere Marquette, Sheboygan, and St. Joseph Rivers (Table 1.5.7) (McCarty *et al.*, 2004). Concentrations of dissolved PCBs were highest in the Grand Calumet River and lowest in the Pere Marquette River. Concentrations of particulate PCBs were highest in the Sheboygan River and lowest in the Muskegon River. Loads of total PCBs to Lake Michigan were highest for the Fox River and lowest for the Manistique River (Figure 1.5.16).

One historic data set for PCBs in Lake Michigan tributaries was found (Marti and Armstrong, 1990). These data permitted comparison of the Fox, Grand Calumet, Grand, Kalamazoo, Manistique, Menominee, Milwaukee, Muskegon, Pere Marquette, Sheboygan, and St. Joseph Rivers for dissolved and particulate PCB concentrations. Between 1980 and 1995, dissolved PCB concentrations decreased at all

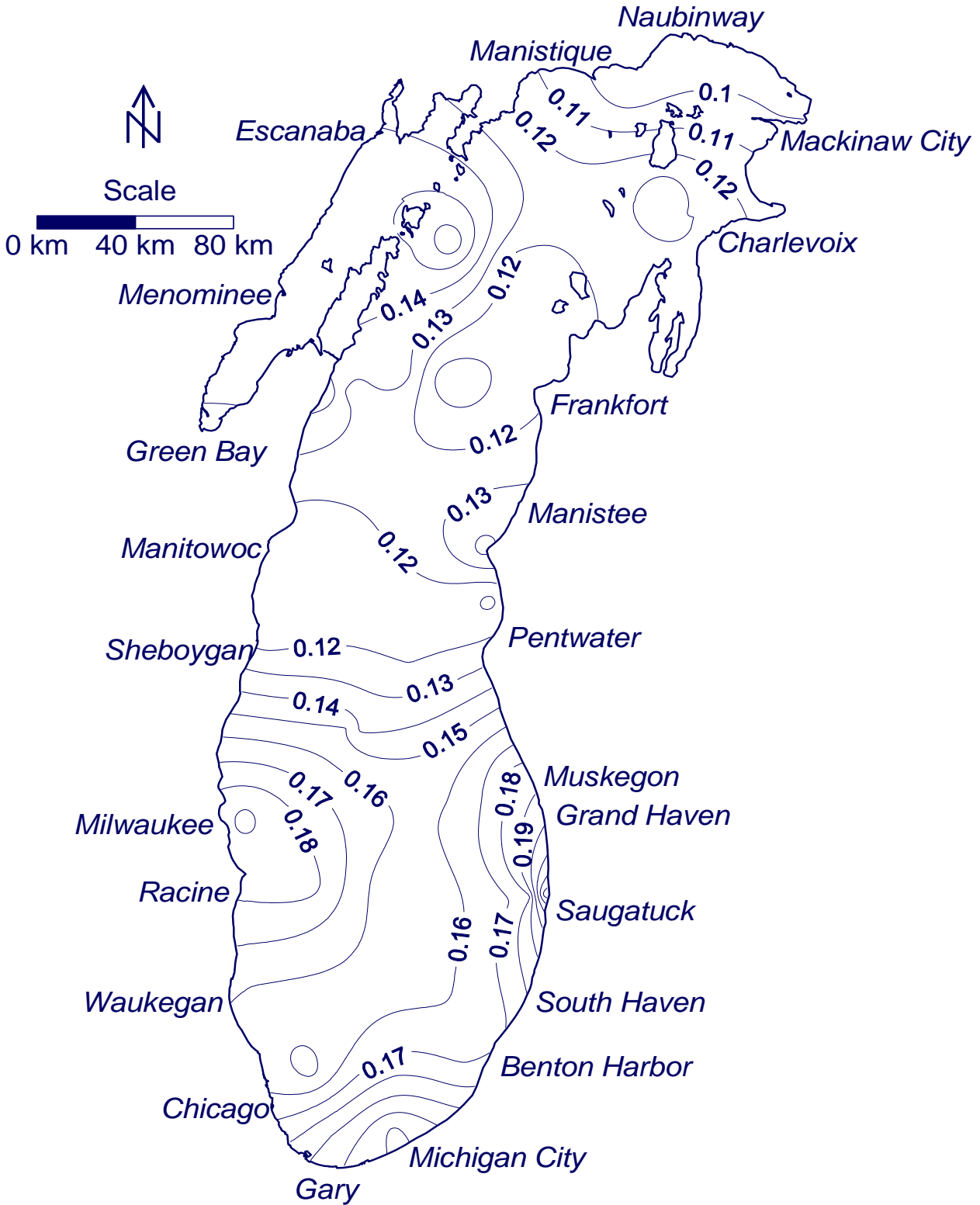

Figure 1.5.11. Distribution of dissolved PCBs (ng/L) in 1994-1995 Lake Michigan water.

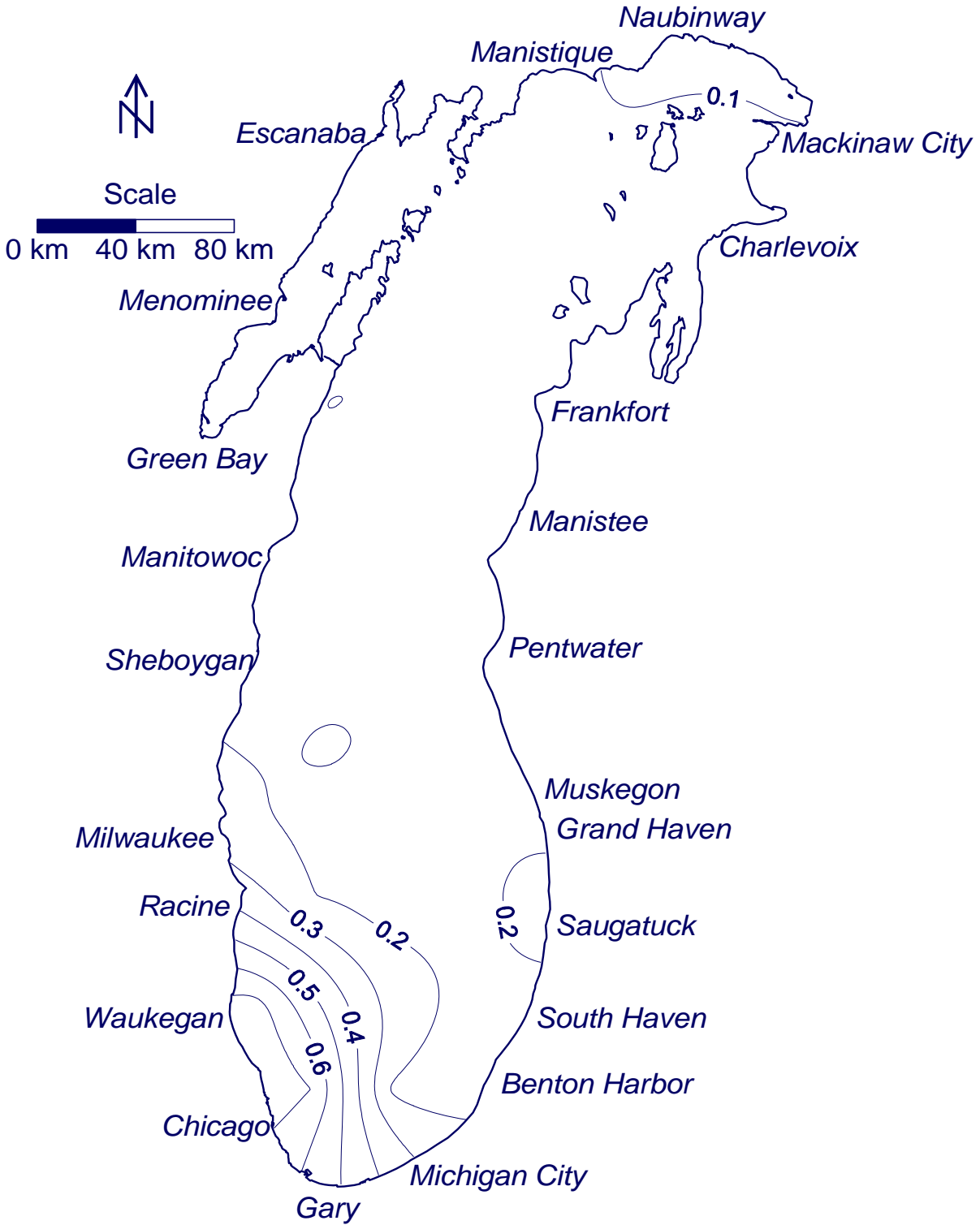

Figure 1.5.12. Distribution of dissolved PCBs (ng/L) in 1994-1995 summer hypolimnetic Lake Michigan water.

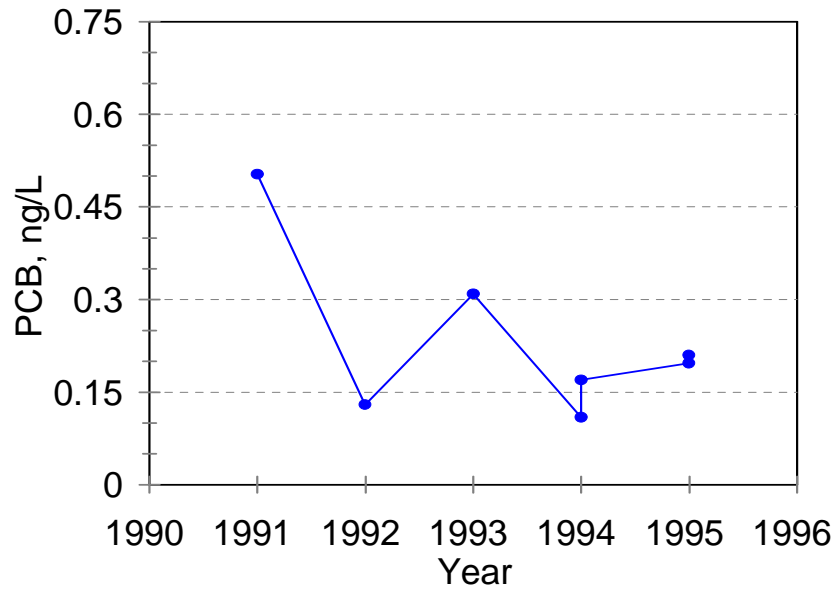

Figure 1.5.13. Time variation of dissolved PCBs in Lake Michigan water.

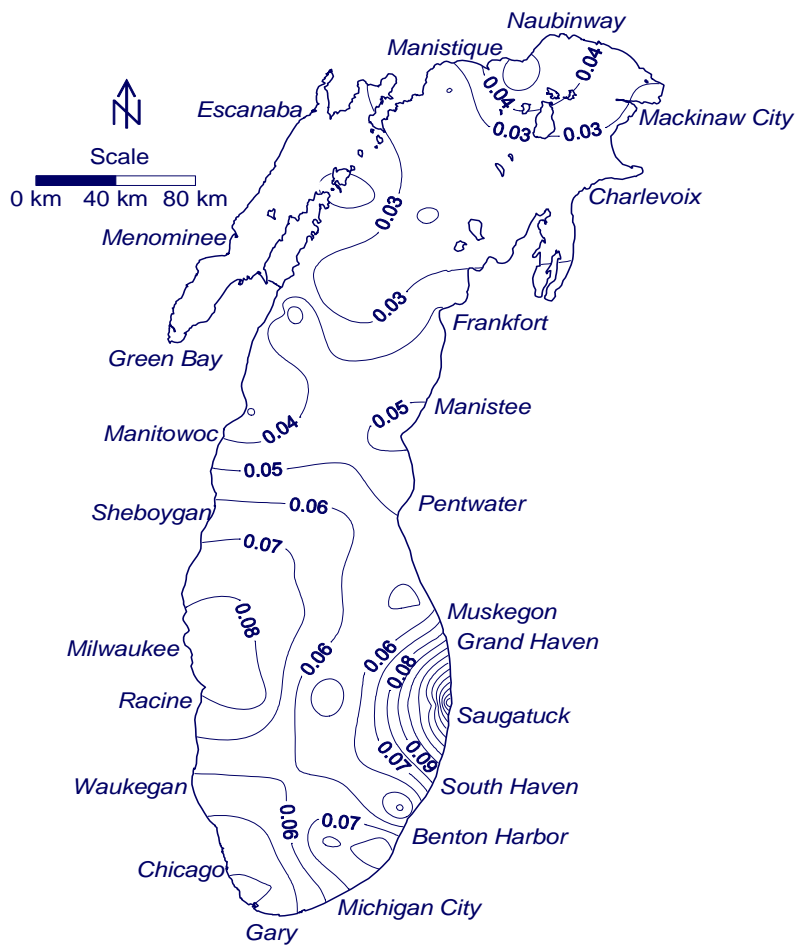

Figure 1.5.14. Distribution of particulate PCBs (ng/L) in 1994-1995 Lake Michigan water.

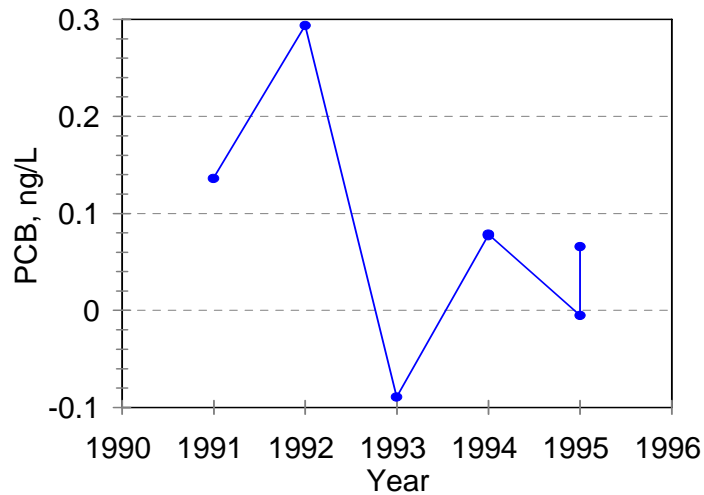

Figure 1.5.15. Time variation of particulate PCBs in Lake Michigan water.

Table 1.5.7. Concentrations of PCBs Measured in Tributaries

Fraction	Tributary	N	Mean (ng/L)	SD (ng/L)
Dissolved	Fox River	39	14	7.6
	Grand Calumet	15	35	6.5
	Grand River	47	0.76	0.35
	Kalamazoo	38	6.9	2.1
	Manistique	28	0.76	0.39
	Menominee	24	1.4	2.1
	Milwaukee	38	13	4.0
	Muskegon	28	0.58	0.40
	Pere Marquette	28	0.43	0.19
	Sheboygan	36	26	8.3
	St. Joseph	33	1.0	0.53
Particulate	Fox River	39	39	25
	Grand Calumet	15	41	22
	Grand River	47	1.6	0.63
	Kalamazoo	38	16	9.6
	Manistique	28	0.41	0.37
	Menominee	24	0.52	0.27
	Milwaukee	38	11	6.2
	Muskegon	28	0.25	0.14
	Pere Marquette	28	0.47	0.32
	Sheboygan	36	55	31
	St. Joseph	33	1.9	0.98

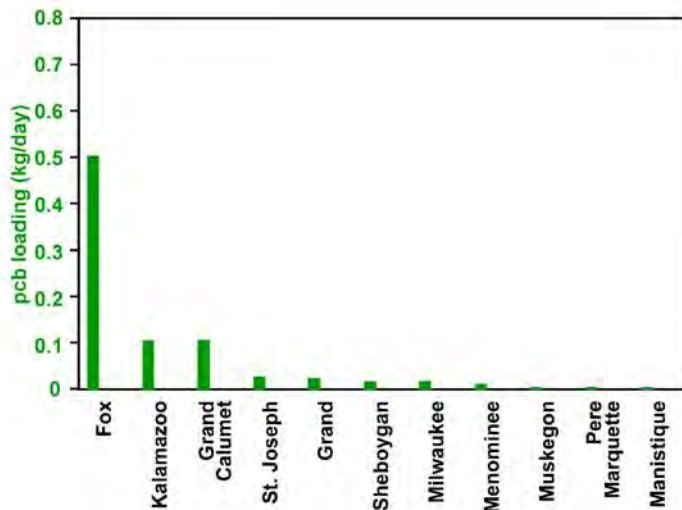

Figure 1.5.16. Relative loads of PCBs to Lake Michigan from tributaries.

but one of the tributaries that could be compared (Table 1.5.8). Particulate PCB concentrations declined at all locations between 1980 and 1995 (Table 1.5.8).

1.5.5 Sediment

PCB concentrations in Lake Michigan surficial (0.5 to 1.5 cm in thickness) sediments ranged between 0.066 and 220 ng/g for samples collected between 1994 and 1996 (Table 1.5.9). This is similar to the range reported by Swackhamer and Armstrong (1988) for samples collected between 1978 and 1980. The mean concentration in 1994-1996 was 47 ng/g. This is within the range of means reported by Swackhamer and Armstrong (1988) for depositional (81 ng/g), transitional (26 ng/g), and non-depositional (7.2 ng/g) regions of the lake as defined by Cahill (1981). All of these results are considerably higher than those reported by Frank *et al.* (1981) for 1975 (Table 1.5.9). Results of the 1975 samples represented samples that had been freeze-dried. Freeze-drying can result in the loss of volatile contaminants from the sediment samples. The spatial variation of PCBs in the main lake surficial sediments in 1994-1996 is consistent with that reported by Frank *et al.* (1981) and Swackhamer and Armstrong (1988). Concentrations are elevated in southeastern Lake Michigan, offshore of Sheboygan,

and offshore of Frankfort (Figure 1.5.17). Of these three areas, PCB concentrations are highest in southeastern Lake Michigan.

Currently, LMMBP PCB results are available for six sediment cores (Figure 1.5.18) (Eadie and Van Hoof, personal communication). All of these cores illustrate the decline in PCB concentrations in recent times. The cores are of varying resoluteness due to the thickness of the surface mixed layer which results in varying particle residence times in the mixed layer (Table 1.5.10). Historic records indicate the first use of PCBs in the basin began no earlier than 1948. PCBs occurring in cores prior to 1948 represent vapor phase PCBs transported to the basin, the failure of sealed sources within the basin, or physical processes within the lake associated with the surface mixed layer of the cores. The surface mixed layer is a surficial zone of the sediment that is consistently mixed by physical or biotic processes. This mixing homogenizes the sediment to a given depth referred to as the mixed layer. The residence time of a particle and its associated PCBs varies from core to core (Robbins *et al.*, 1999). For the six cores this residence time varies from 0.0 to 31.5 years. Thus some cores are highly resolved (LM-94-15) and some are poorly resolved (LM-95-58). This results in differences for the apparent time of appearance of PCBs in the cores.

Table 1.5.8. Comparison of PCB Concentrations in Samples Collected From Tributaries in 1994-1995 With Those in Samples Collected From Tributaries in 1980-1983 (Marti and Armstrong, 1990)

Tributary	1980-1983 Dissolved Mean Concentration (ng/L)	1994-1995 Dissolved Mean Concentration (ng/L)	1980-1983 Particulate Mean Concentration (ng/L)	1994-1995 Particulate Mean Concentration (ng/L)
Fox River	17	14	81	39
Grand Calumet	24	35	220	41
Grand River	16	0.76	41	1.6
Kalamazoo	9	6.9	31	16
Manistique	6	0.76	18	0.41
Menominee	6	1.4	9	0.52
Milwaukee	28	13	69	11
Muskegon	4	0.58	5	0.25
Pere Marquette	4	0.43	10	0.47
Sheboygan	34	26	69	55
St. Joseph	7	1.0	7	1.9

Table 1.5.9. Concentrations of Total PCBs in Lake Michigan Surficial Sediment (ng/g)

Year Collected	Number of Samples	Mean	Standard Deviation	Minimum	Maximum	Median	Source
1994- 1996	113	47	48	0.066	220	29	LMMBP
1975	179	9.7	15.7				Frank <i>et al.</i> , 1981
1978- 1980	60	7.2-81		1.0	201		Swackhamer and Armstrong, 1988

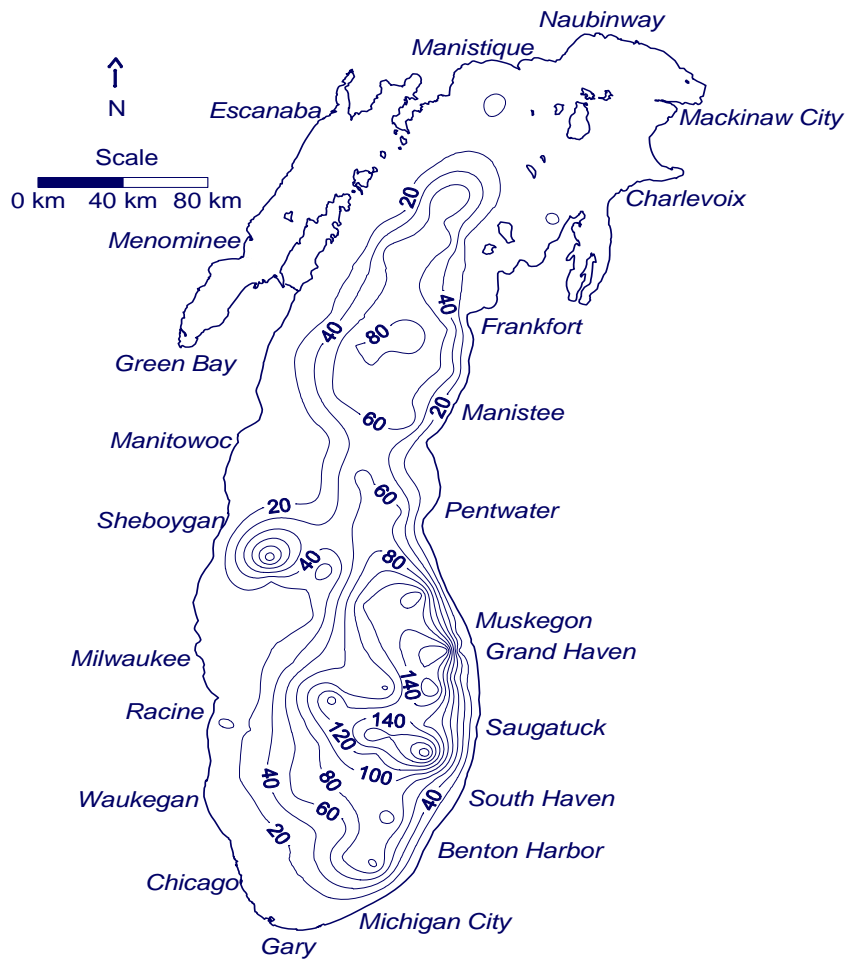

Figure 1.5.17. Total PCBs in 1994-1995 Lake Michigan surficial sediments (ng/g).

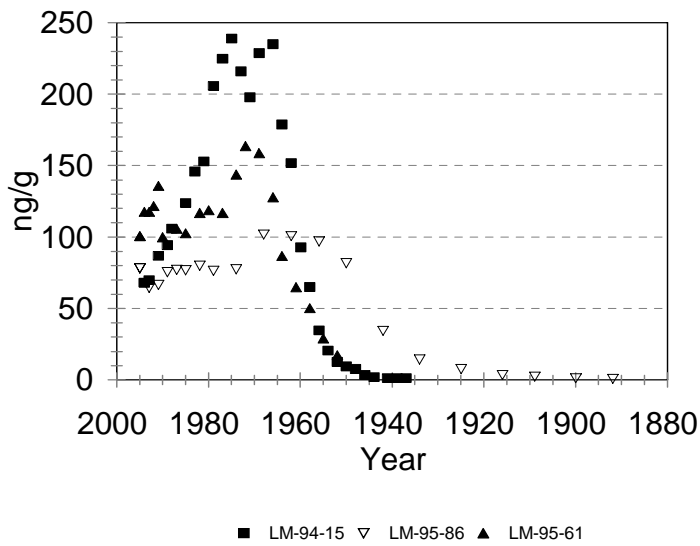

Figure 1.5.18. Vertical variation of PCBs in dated sediment cores collected for the LMMBP.

Table 1.5.10. Physical Parameters Associated With LMMBP Cores (Robbins *et al.*, 1999; Eadie and Van Hoof, Personal Communication)

Station Number	Sedimentation Rate g/cm ² /year	Mixed Layer Residence Time, Year	Year of Peak PCB Concentration	Year of PCB Onset Above Background
LM-94-15	0.2235	0.0	1965, 1972	1943
LM-95-58	0.0357	31.5		
LM-95-61	0.1064	7.8	1969	1916
LM-95-86	0.0312	14.9	1968	1917
LM-95-103	0.0266	23.1	~1953	Prior to 1916
LM-95-108	0.0511	12.5	~1961	1932

Historic cores include those reported by Swackhamer and Armstrong (1988), Hermanson *et al.* (1991), Golden *et al.* (1993), and Schneider *et al.* (2001) (Figures 1.5.19 to 1.5.22). The core reported by Swackhamer and Armstrong (1988) was collected in 1980 (Figure 1.5.19). It failed to capture any decline in PCBs attributable to the ceasing of the manufacture of PCBs in 1977. For cores collected in 1984, a decline in PCBs was documented in four of the five cores (Figure 1.5.20). For these cores, the apparent peak of PCBs occurred after 1965. Cores collected in 1991 and 1992 had a peak PCB concentration between the early 1960s and early 1980s (Figure 1.5.21), and the core collected in 1998 had a peak concentration in the mid-1970s (Figure 1.5.22). Peak concentrations in all these cores are consistent with the LMMBP cores which had a peak concentration between the early 1960s and early 1970s (Figure 1.5.18).

1.5.6 Biota

Various biota were analyzed for PCBs. These include phytoplankton, zooplankton, *Diporeia*, *Mysis*, alewife, bloater, deepwater sculpin, smelt, slimy sculpin, coho, and lake trout (Table 1.5.11). Mean concentrations ranged from 49 ng/g in phytoplankton to 3,000 ng/g in lake trout. For alewife and bloater, the fish were divided into two size classes based on length. For both of these, PCB concentrations were higher in the larger fish. Concentrations of PCBs in members of the lake trout food web increase with trophic level, with concentrations lowest in the plankton, higher in benthos, and highest in the forage

fish, illustrating biomagnification of PCBs (Figure 1.5.23). For lake trout, PCB concentrations increased in a predictable way with fish age until age 10 (Figure 1.5.24). All PCB concentrations in lake trout exceed those of their prey. For unknown reasons, age 11 fish and older have PCB concentrations that vary in no predictable way with increasing age.

PCB concentrations in lake trout have been declining since 1975 (Figure 1.5.25). Similarly, concentrations of PCBs have declined in bloater since 1974 (Figure 1.5.26). These appear to be responding to the phase-out of PCB use in the basin which occurred at most locations by the early 1970s (Table 1.5.1).

1.5.7 Summary

Concentrations of PCBs have declined in Lake Michigan since the phase-out of use by industries within the basin. Concentrations are highest in southern Lake Michigan for most media. For air and water media, concentrations are highest near shoreline sources.

References

Anderson, D.J., T. B. Bloem, R.K. Blankenbaker, and T.A. Stanko. 1999. Concentration of Polychlorinated Biphenyls in the Water Column of the Laurentian Great Lakes: Spring 1993. *J. Great Lakes Res.* 25(1):160-170.

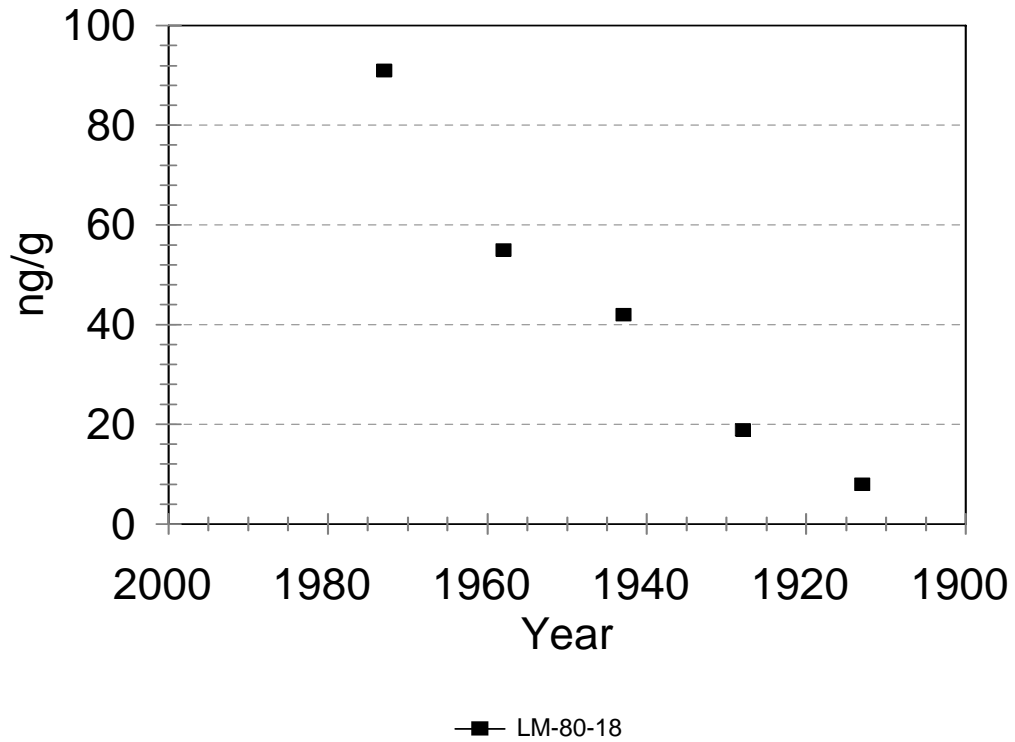

Figure 1.5.19. Vertical variation of PCBs in dated sediment cores reported by Swackhamer and Armstrong (1988).

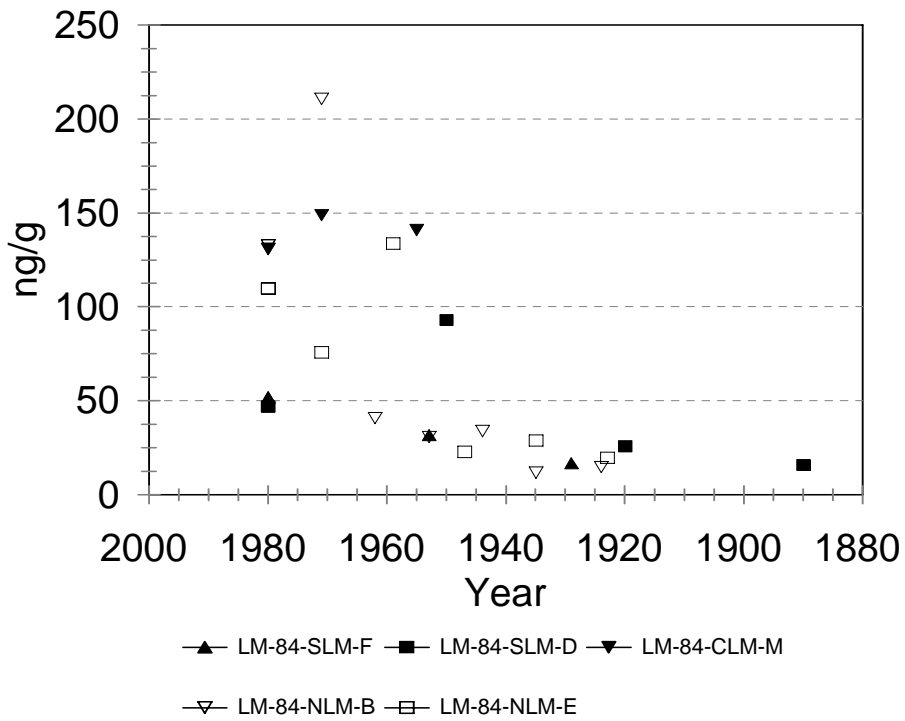

Figure 1.5.20. Vertical variation of PCBs in dated sediment cores reported by Hermanson *et al.* (1991).

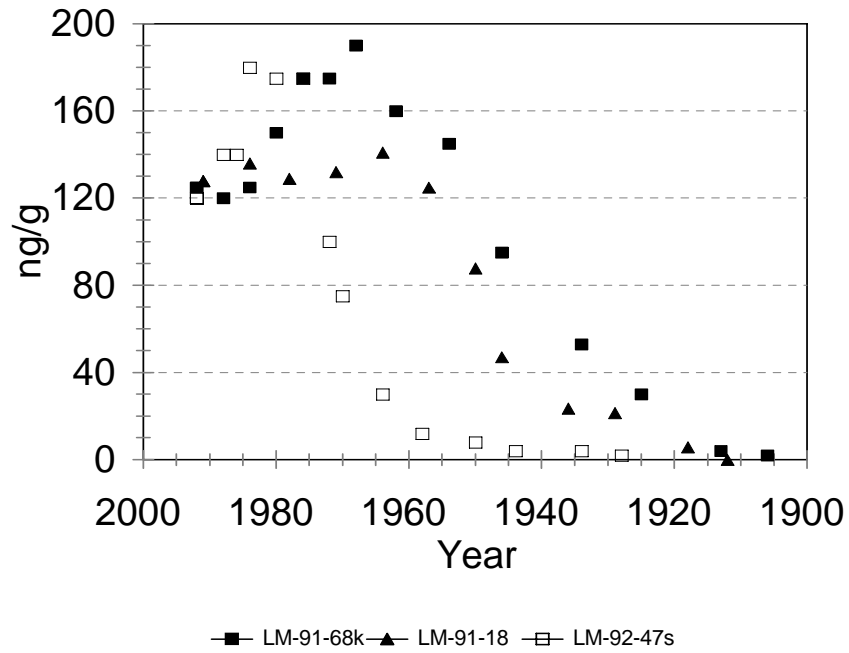

Figure 1.5.21. Vertical variation of PCBs in dated sediment cores reported by Golden *et al.* (1993).

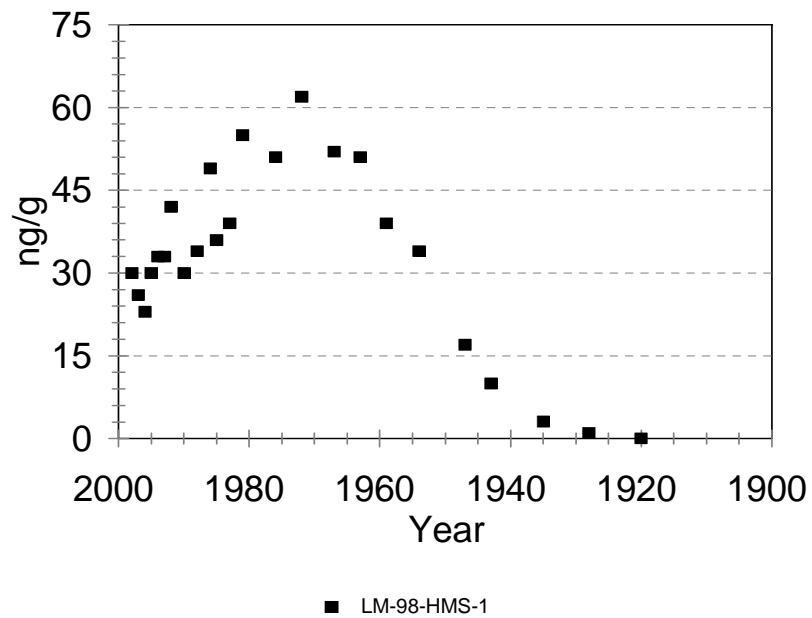

Figure 1.5.22. Vertical variation of PCBs in dated sediment cores reported by Schneider *et al.* (2001).

Table 1.5.11. Mean Concentrations of PCBs Measured in the 1994-1995 Lake Michigan Food Web (McCarty *et al.* 2004)

Sample Type	N	Mean (ng/g)	Standard Deviation (ng/g)
Phytoplankton	71	49	38
Zooplankton	70	170	74
<i>Mysis</i>	53	250	61
<i>Diporeia</i>	39	420	100
Smelt	73	310	83
Slimy Sculpin	69	430	130
Deepwater Sculpin	74	420	200
Alewife < 120 mm	60	250	150
Alewife > 120 mm	70	580	140
Bloater < 160 mm	70	650	180
Bloater > 160 mm	67	830	210
Coho - Hatchery	5	120	27
Coho - Yearling	8	200	90
Coho - Adult	54	810	520
Lake Trout (All Age Classes)	246	3000	2300

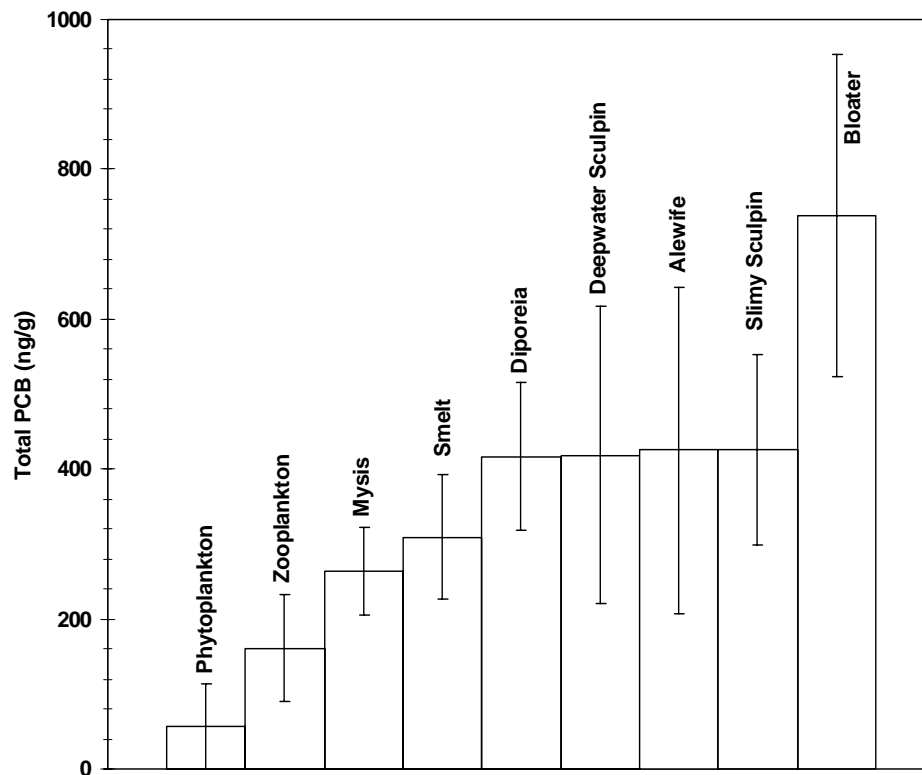

Figure 1.5.23. PCB concentrations in various members of the lake trout food web during the LMMBP.

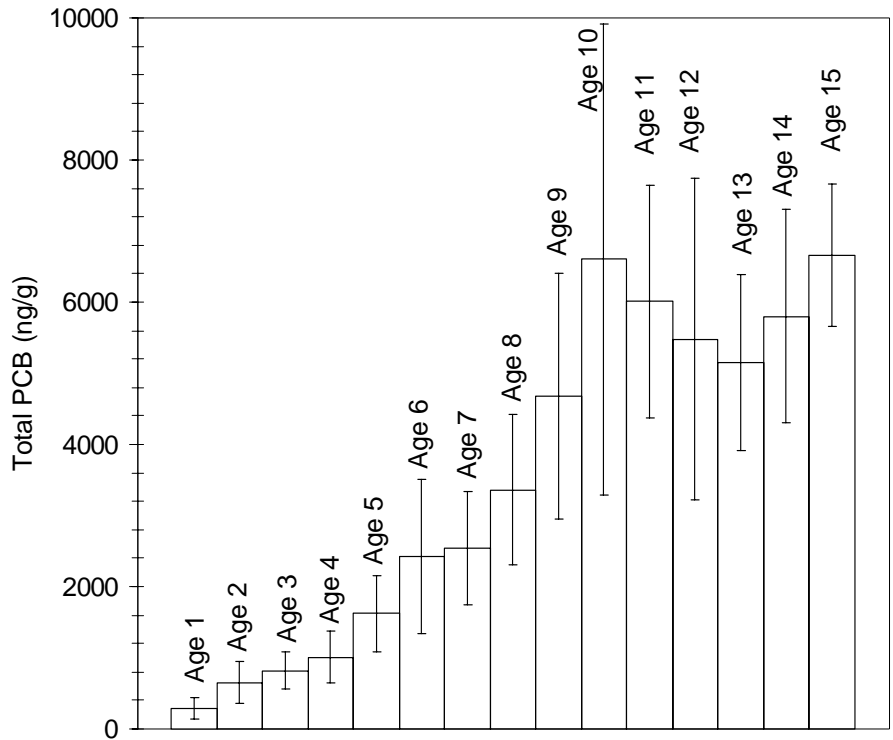

Figure 1.5.24. PCB concentrations in various age classes of lake trout during the LMMBP.

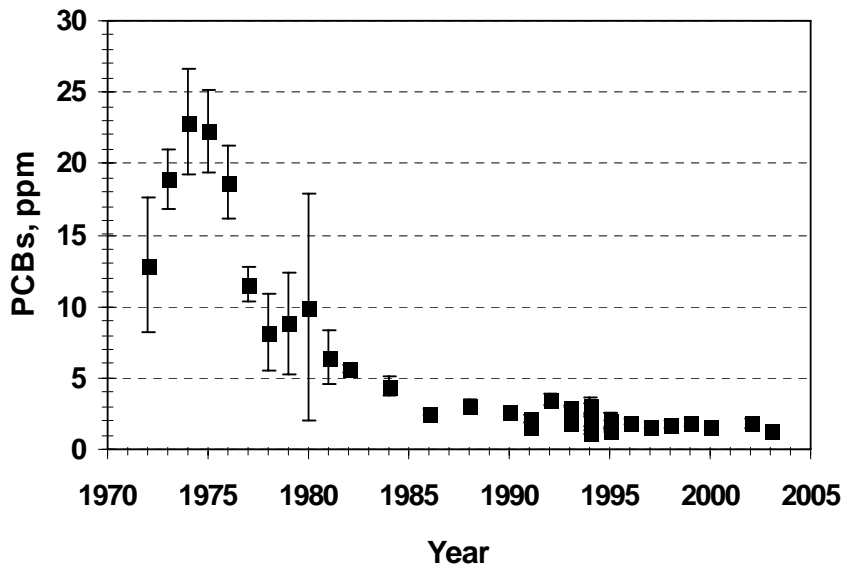

Figure 1.5.25. Time variation of PCB concentration in five to six year-old lake trout from Lake Michigan.

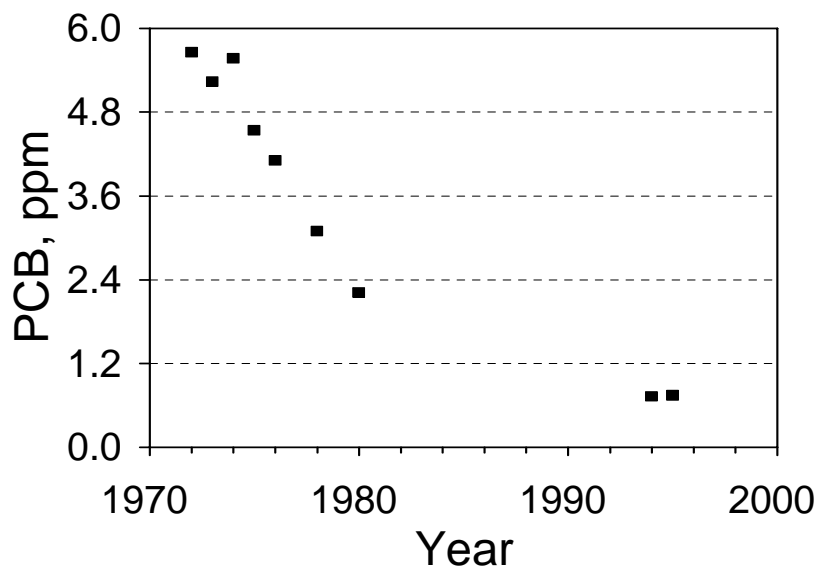

Figure 1.5.26. Time variation of PCB concentrations in bloater from Lake Michigan.

Bicksler, J. 1996. PCBs in the Spring-Time Water Column of the Great Lakes. M.S. Thesis, University of Minnesota, Minneapolis, Minnesota. 160 pp.

Boughton, L. 2004. Human Impact. Presented at the State of the Lakes Ecosystem Conference. Toronto, Ontario, Canada, October 6-8, 2004.

Buehler, S.S. and R.A. Hites. 2002. The Great Lakes' Integrated Atmospheric Deposition Network. *Environ. Sci. Technol.*, 36(17):354A-359A.

Buehler, S.S., I. Basu, and R. A. Hites. 2004. Causes of Variability in Pesticide and PCB Concentrations in Air Near the Great Lakes. *Environ. Sci. Technol.*, 38(2):414-422.

Chambers, R.L. and B.J. Eadie. 1980. Nearshore Chemistry in the Vicinity of the Grand River, Michigan. National Oceanic and Atmospheric Administration, Great Lakes Environmental Research Laboratory, Ann Arbor, Michigan. NOAA Technical Memorandum ERL GLERL-28, 28 pp.

DeVault, D.S., R. Hesselberg, P.W. Rodgers, and T.J. Feist. 1996. Contaminant Trends in Lake Trout and Walleye From the Laurentian Great Lakes. *J. Great Lakes Res.*, 22(4):884-895.

Filkins, J.C., J.M. Townsend, and S.G. Rood. 1983. Organochlorines in Offshore Waters of the Great Lakes, 1981. U.S. Environmental Protection Agency, Office of Research and Development, ERL-Duluth, Large Lakes Research Station, Grosse Ile, Michigan. 12 pp.

Frank, R., R.L. Thomas, H.E. Braun, D.L. Gross, and T.T. Davies. 1981. Organochlorine Insecticides and PCB in Surficial Sediments of Lake Michigan (1975). *J. Great Lakes Res.*, 7(1):42-50.

Golden, K.A., C.S. Wong, J.D. Jeremiason, S.J. Eisenreich, G. Sanders, J. Hallgren, D.L. Swackhamer, D.R. Engstrom, and D.T. Long. 1993. Accumulation and Preliminary Inventory of Organochlorines in Great Lakes Sediments. *Water Sci. Technol.*, 29(8-9):19-31.

Hermanson, M.H., E.R. Christensen, D.J. Buser, and L. Chen. 1991. Polychlorinated Biphenyls in Dated Sediment Cores From Green Bay and Lake Michigan. *J. Great Lakes Res.*, 17(1):94-108.

-
- Integrated Atmospheric Deposition Network. 2004. Download from the web site www.msc.ec.gc.ca/iadn/Data/form/form_e.html. "The Integrated Atmospheric Deposition Network, established in 1990, is implemented by the Canadian Federal (Environment Canada) and Provincial (Ontario Ministry of the Environment) Governments and the U.S. Environmental Protection Agency as Mandated in Annex 15 of the Great Lakes Water Quality Agreement (GLWQA)."
- Lefkovitz, L.F. 1987. The Particle Mediated Fractionation of PCBs in Lake Michigan. M.S. Thesis, University of Wisconsin, Madison, Wisconsin. 238 pp.
- Marti, E.A. and D.E. Armstrong. 1990. Polychlorinated Biphenyls in Lake Michigan Tributaries. *J. Great Lakes Res.*, 16(3):396-405.
- McCarty, H. B., J. Schofield, K. Miller, R. N. Brent, P. Van Hoof, and B. Eadie. 2004. Results of the Lake Michigan Mass Balance Study: Polychlorinated Biphenyls and *trans*-Nonachlor Data Report. U.S. Environmental Protection Agency, Great Lakes National Program Office, Chicago, Illinois. EPA/905/R-01/011, 289 pp.
- Murphy, T.J. and C.P. Rzesutko. 1977. Precipitation Inputs of PCBs to Lake Michigan. *J. Great Lakes Res.*, 3(3-4):305-312.
- Offenberg, J.H. and J.E. Baker. 2000. PCBs and PAHs in Southern Lake Michigan in 1994 and 1995: Urban Atmospheric Influences and Long-Term Declines. *J. Great Lakes Res.* 26(2): 196-208.
- Pearson, R.F., K.C. Hornbuckle, S.J. Eisenreich, and D.L. Swackhamer. 1996. PCBs in Lake Michigan Water Revisited. *Environ. Sci. Technol.*, 30(5):1429-1436.
- Rice, C.P., B. J. Eadie, and K.M. Erstfield. 1982. Enrichment of PCBs in Lake Michigan Surface Films. *J. Great Lake Res.*, 8(2):265-270.
- Robbins, J.A., N.R. Morehead, R.W. Rood, D.N. Edgington, and S. Meyer. 1999. Accumulation and Near-Shore Mixing of Sediments in Lake Michigan as Determined for the Lake Michigan Mass Balance Program. Part 1. Cores Collected between 1994 and 1996 (2 Volumes). Final Report. U.S. Environmental Protection Agency, Office of Research and Development, ERL-Duluth, Large Lakes Research Station, Grosse Ile, Michigan. 274 pp.
- Rodgers, P.W. and W.R. Swain. 1983. Analysis of Polychlorinated Biphenyl (PCB) Loading Trends in Lake Michigan. *J. Great Lakes Res.* 9(4): 548-558.
- Schneider, A.R., H.M. Stapleton, J. Cornwell, and J.E. Baker. 2001. Recent Declines in PAH, PCB, and Toxaphene Levels in the Northern Great Lakes as Determined from High Resolution Sediment Cores. *Environ. Sci. Technol.*, 35(19):3809-3815.
- Swackhamer, D.L. and D.E. Armstrong. 1987. Distribution and Characterization of PCBs in Lake Michigan Water. *J. Great Lakes Res.*, 13(1):24-36.
- Swackhamer, D.L. and D.E. Armstrong. 1988. Horizontal and Vertical Distribution of PCBs in Southern Lake Michigan Sediments and the Effect of Waukegan Harbor as a Point Source. *J. Great Lakes Res.*, 14(3):277-290.
- Wethington, D.M. And K.C. Hornbuckle. 2005. Milwaukee, WI, as a Source of PCBs to Lake Michigan. *Environ. Sci. Technol.*, 39(1):57-63.

PART 1

INTRODUCTION

Chapter 6. Congener Pattern Matching of Data Collected for the Lake Michigan Mass Balance Project (LMMBP)

David A. Griesmer
Computer Sciences Computer
Large Lakes Research Station
9311 Groh Road
Grosse Ile, Michigan 48138

1.6.1 Introduction

As part of the quality assurance (QA) process for the Lake Michigan Mass Balance Project (LMMBP), a LMMBP PCB Modeling Peer Review Conference was held on July 27-28, 2004 at the Crowne Plaza Hotel in Romulus, Michigan to review the LMMBP polychlorinated biphenyl (PCB) models developed for this study. One of the recommendations to come out of this peer review was to “Investigate congener patterns in air, water, fish, and sediment. How do these compare?” (Part 7, Appendix 1). In response to this question, the peer review response document states that: “The PCB patterns of multiple media will be compared to determine similarities and differences within and among media. This technique is commonly referred to as PCB fingerprinting or PCB signature recognition and has had mixed success in the past. This recommendation has minor implications to the modeling; however, it is a data analysis tool and has merit for data presentation and interpretation purposes. The relative percent of total PCBs represented by each congener will be computed and then expressed as a cumulative frequency plot for comparative purposes. These will represent data for an entire study period, will be

tested with both mean and median values, and will be a composite expression of seasonal and spatial data. In addition, selected evaluation of pattern recognition using the LMMBP data set can be found in Kuehl (2002) and McCarty *et al.* (2004). Fingerprints will be calculated for sediment, water column (dissolved and particulate), vapor phase, wet and dry atmospheric deposition, and age 5-6 year-old lake trout signatures from the Saugatuck biota site. Atmospheric signatures will be based on a subset of all congeners because vapor phase data were computed by Keri Hornbuckle for the study, and over-lake concentrations were only calculated for the congeners that are being modeled at Grosse Ile. In addition, PCB patterns associated with water discharging from the Kalamazoo River near the Saugatuck biota site and other selected tributaries will be compared/contrasted to the lake water”.

One of the main objectives of this analysis was to see if there was a correlation between congener patterns in the LMMBP biota boxes and the atmospheric, tributary, and sediment sources of congener contamination. To accomplish this, congener pattern matching analysis was expanded from that originally suggested in the peer review modelers’ response. This included congener pattern matching for all 11 major tributaries, as well as a comparison of atmospheric inputs for all 10 surface segments defined in the LM2-Toxic model. In addition, ages 5-6 year-old lake trout were evaluated in Sturgeon Bay, Sheboygan Reef, and Saugatuck biota boxes (Figure 1.6.1), instead of just in the Saugatuck biota box. Multiple year classes (age 2, age 3, and age 9), of lake trout were analyzed for the Saugatuck biota box, to see if there were differences in the congener patterns of different aged lake trout.

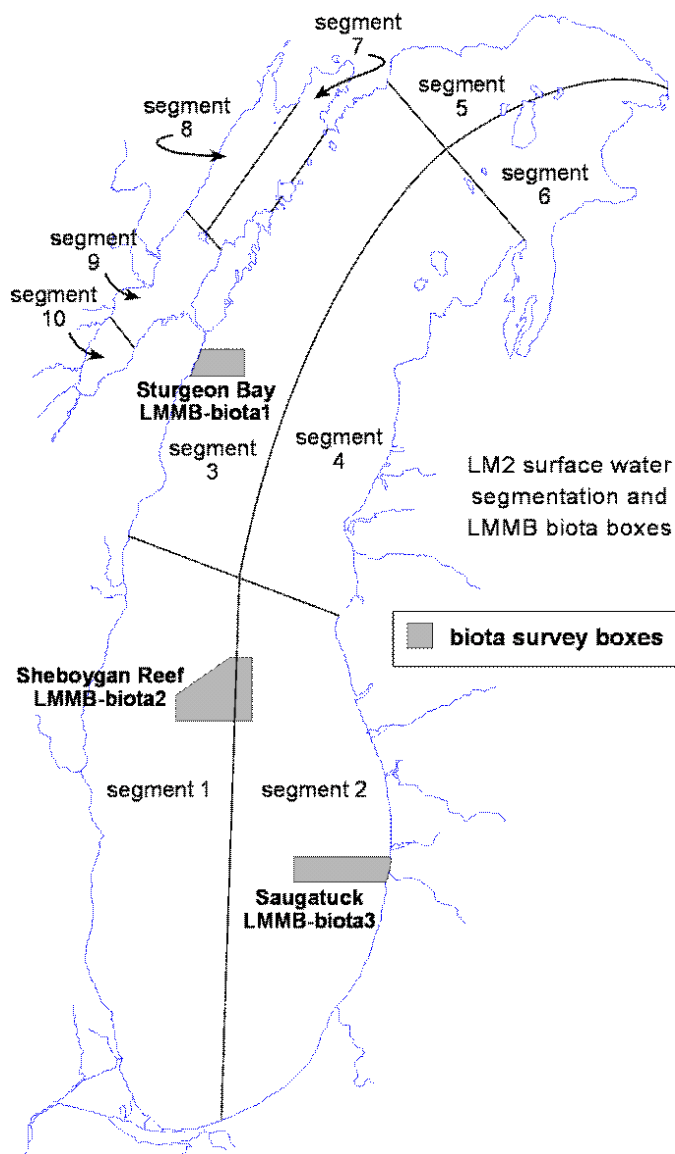

Figure 1.6.1. LM2 surface water segmentation and LMMBP biota boxes.

1.6.2 Analytical Approach

This exercise was not meant to be a rigorous statistical analysis of the data, rather it is strictly an empirical look at congener patterns in different media collected for the LMMBP. All available congener data were included in the analysis. Analysis was done for most of the media collected for PCBs during the LMMBP (atmospheric, tributary, lake water, sediment, and biota). Kuehl (2002) previously had done a comparison of congener patterns of the biota

media (phytoplankton, zooplankton, *Mysis*, *Diporeia*, bloater chub, slimy and deepwater sculpin, alewife, rainbow smelt, coho salmon, and lake trout) collected for the LMMBP. Therefore, with the exception of lake trout, these biota media were not examined in the present analysis. For all of the analyses done for the present study, comparisons were made by plotting the congener patterns and doing a visual comparison for obvious similarities or differences.

1.6.3 Methodology

PCB congener analysis for the LMMBP were performed by a number of different principal investigators, using different instrumentation and techniques, which are detailed in the LMMB Methods Compendium (U.S. Environmental Protection Agency, 1997). These variation in methods may have had some impact of the comparison of samples from different media due to co-elution and congener detection differences from media-to-media.

All analyzed congeners were used to maximize the amount of data available. All analyses were done using Microsoft Excel spreadsheets. Congeners were ordered in each media by congener number, with co-eluting congeners ordered by the lowest co-eluting congener number (see Table 1.6.1) Data were analyzed by media, where the mean and median values were calculated for each congener. Cumulative frequency analysis was then performed on the means and medians for each congener. The percent frequency of each congener was calculated by dividing the means and median of each congener by the total sum of all the congeners in that media to give a percent value to each congener. These percentages were added together to give a cumulative frequency distribution which totals to one.

These data were graphed, and visual comparisons were done.

1.6.4 Results

1.6.4.1 Comparison of Modeled Congener Patterns to All Analyzed Congener Patterns

In an effort to make use of as many congeners as possible in this analysis, all congeners analyzed in each media were used rather than just the modeled

Table 1.6.1 Comparison of Congeners Available for Analysis in All LMMBP Media

Modeled Congeners	Available Congeners in All Media						
	Vapor Phase	Wet Deposition	Dry Deposition	Open Lake Water	Surficial Sediment	Tributary	Lake Trout
8+5	8+5	8+5	8+5	4+10	8+5	003	022
15+17	15+17	012	012	8+5	006	4+10	24+27
16+32	16+32	013	013	006	7+9	8+5	31+28
018	018	15+17	15+17	7+9	012	006	029
026	026	016	016	012	013	7+9	033
28+31	28+31	018	108	013	15+17	15+17	040
033	033	026	1026	014	016	16+32	41+71
37+42	37+42	31+28	31+28	15+17	018	017	042
044	044	032	032	016	019	018	044
049	049	033	033	018	021	019	47+48
052	052	037	037	019	022	022	049
56+60	56+60	042	042	021	24+27	24+27	052
066	066	044	044	022	025	025	56+60
70+76	70+76	049	049	024	026	026	063
074	074	052	052	025	31+28	31+28	064
77+110	77+110	56+60	56+60	026	029	033	066
081	081	066	066	027	032	37+42	70+76
92+84	92+84	70+76	70+76	31+28	033	040	074
085	085	074	074	029	37+42	41+71+64	77
087	087	077	077	032	040	044	81+87
089	089	081	081	033	41+71	045	082
099	099	92+84	92+84	37+42	042	046	083
101	101	085	085	040	043	47+48	92+84+89
132+153+105	132+153+105	087	087	41+71	044	049	085
118	118	089	089	043	045	051	091
123+149	123+149	099	099	044	046	052	095
163+138	163+138	101	101	045	47+48	053	097
146	146	132+153+105	132+153+105	046	049	56+60	099
151	151	110	110	47+48	051	063	101
170+190	170+190	118	118	049	052	066	105
172+197	172+197	123+149	123+149	051	053	66+95	107
180	180	163+138	163+138	052	56+60	70+76	110
187+182	187+182	170+190	146	053	063	074	114
195+208	195+208	172	151	56+60	064	77+110	118
196+203	196+203	180	170+190	063	066	082	119
201	201	187+182	172	064	70+76	083	123
		208+195	180	066	074	92+84	126
		196	187+182	70+76	77	085	128
		197	108+195	074	081	087	129
		201	196	77+110	082	089	131
		203	197	081	083	091	132+153
			201	082	92+84	095	134
			203	083	085	097	135+144
				92+84	087	099	137+176
				085	089	101	163+138
				087	091	105+132+153	141
				089	095	118	146
				091	097	123+149	149
				095	099	128	151
				097	100	132+153	156
				099	101	135+144	157
				100	105+132+153	136	158
				101	107	137+176	167

Table 1.6.1. Comparison of Congeners Available for Analysis in All LMMBP Media (Continued)

Modeled Congeners	Available Congeners in All Media						
	Vapor Phase	Wet Deposition	Dry Deposition	Open Lake Water	Surficial Sediment	Tributary	Lake Trout
				103	110	163+138	170+190
				105+132+153	114+131	141	171
				107	118	146	172
				114+131	119	149	173
				118	123+149	151	174
				123+149	128	158	175
				147+124	129	167	177
				128	130	170+190	178
				129	134	202+171	180
				130	135+144	172	187+182
				134	136	172+197	183
				135+144	137+176	174	185
				136	163+138	177	189
				137+176	141	178	191
				163+138	146	180	193
				141	151	187+182	194
				146	156	183	195
				151	157+200	185	203+196
				156	158	193	197
				157+200	167	194	198
				158	170+190	208+195	199
				167	202+171	203+196	200
				170+190	172	198	201
				202+171	173	199	202
				172+197	174	201	205
				173	175	206	206
				174	177	207	207
				175	178		208
				177	180		209
				178	187+182		
				180	183		
				187+182	185		
				183	189		
				185	191		
				189	193		
				191	194		
				193	208+195		
				194	203+196		
				208+195	197		
				196	198		
				198	199		
				199	201		
				201	205		
				203	206		
				205	207		
				206	209		
Total # Congeners:				207			
				209			
54	54	54	56	127	123	107	98

congeners. Because most of the comparisons were in the same media, this would give the maximum number of data points. However, there were some concerns when comparing data from different media. To see if this approach was feasible, an initial comparison was done to see if the congener pattern trends seen using only modeled congeners were different from the congener patterns seen when “all available congeners” were analyzed (Table 1.6.1). This analysis was done for a number of different media (vapor phase, wet and dry deposition, dissolved and particulate PCBs in lake water, surficial sediments, and 5-6 year-old lake trout).

The definition of “all congeners” varied somewhat, depending on the medium being examined. For dissolved and particulate water, sediment, tributary, and lake trout data, all congeners reported were used in this analysis. This number varied from a low of 98 congeners in the lake trout analysis to a high of 127 congeners in the open lake water samples. For the atmospheric samples, Keri Hornbuckle calculated over-water concentrations of only modeled congeners in vapor phase, as well as wet and dry deposition data (Table 1.6.1); therefore, the only congeners available in this media are the 54 modeled congeners. While over 100 congeners were available from Hornbuckle in the atmospheric wet and dry deposition data sets, only a subset were used because data needed to be aggregated by LM2-Toxic modeling segment. These aggregated data sets contained only 54 congeners of wet deposition data and 56 congeners of dry deposition data (Table 1.6.1).

This comparison was limited to the samples collected in or near the Saugatuck Biota Box, LMMBP-Biota3, for lake trout and surficial sediment, or to LMMBP modeling segment 2 (Figure 1.6.1), which contains the Saugatuck biota box, for the atmospheric and lake water samples. In addition, dissolved and particulate water data for the Kalamazoo River were included, because this is the tributary which discharges water closest to the Saugatuck biota box.

Cumulative frequency plots comparing all available congener data and modeled congener data were then created. This comparison showed that the trends in the different media were similar, whether modeled congeners or all available congeners were used (Figures 1.6.2-1.6.10). This is not too

surprising because the 54 modeled congeners made up the bulk of the congener mass in all media sampled, accounting for an average of 74% of the mass across all media (77.3% of vapor phase PCB mass, 63.4% of wet deposition PCB mass, 73% of dry deposition PCB mass, 80.2% of tributary water PCB mass, 67.5% of dissolved lake water PCB mass, 77.2% of particulate lake water PCB mass, 84.7% of surficial sediment PCB mass, and 67.1% of lake trout PCB mass). Because these trends were similar, it was decided that all available congeners would be used in the data analysis, so that we could take advantage of the maximum amount of data points.

1.6.4.2 Comparison of Median to Mean Data

A comparison between mean and median values in different media was done to see how much results varied between averaging methods. In vapor phase samples, dry deposition samples, dissolved and particulate tributary water samples, there was almost no difference between median and mean plots (Figures 1.6.11 - 1.6.14). In wet deposition samples, dissolved and particulate water samples, surficial sediment samples, and 5-6 year-old lake trout samples, there were some small differences in the plots (Figures 1.6.15 - 1.6.19), with median values being somewhat lower in all instances due to the fact that some of the congeners have zero median values. These zero median values were the result of a large number of congeners with reported values of zero or near zero. We decided to use mean values for the rest of the analysis because there appeared to be little difference between median and mean plots and to avoid the zero median values.

1.6.4.3 Comparison of Congener Patterns in Different Media in Segment 2/Saugatuck Biota Box

When the congener patterns for different media in segment 2 and the Saugatuck biota box were compared (Figure 1.6.20), the following general trends were identified. Vapor phase data appeared to have a higher percentage of lower chlorinated congeners than any of the other media. Dissolved PCB congeners in water from the Kalamazoo River most nearly matched the congener pattern seen in the vapor phase, with the congener pattern for dichloro, tetrachloro — decachloro's most closely

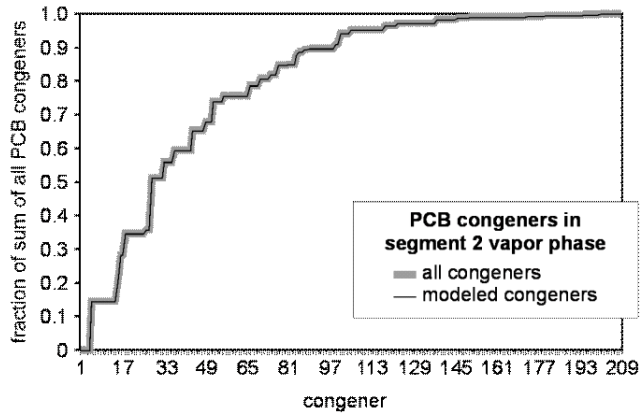

Figure 1.6.2. Cumulative frequency distribution – PCB congeners in segment 2 vapor phase.

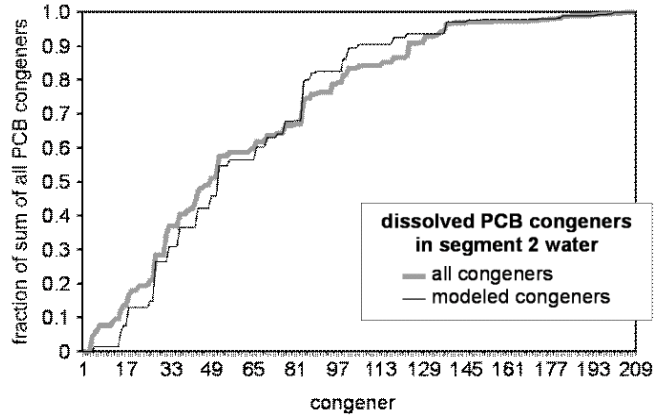

Figure 1.6.5. Cumulative frequency distribution – dissolved PCB congeners in segment 2 water.

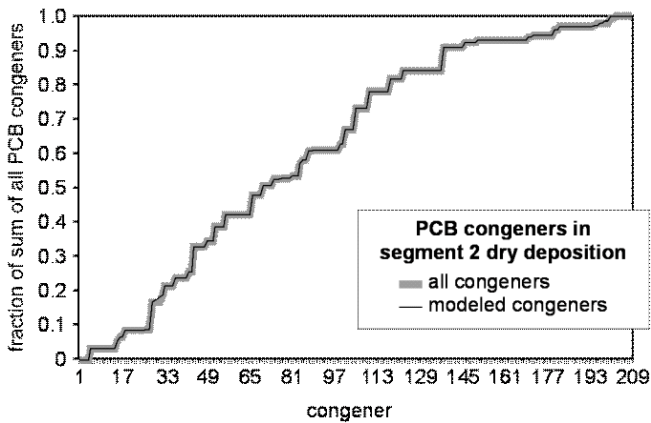

Figure 1.6.3. Cumulative frequency distribution – PCB congeners in segment 2 dry deposition.

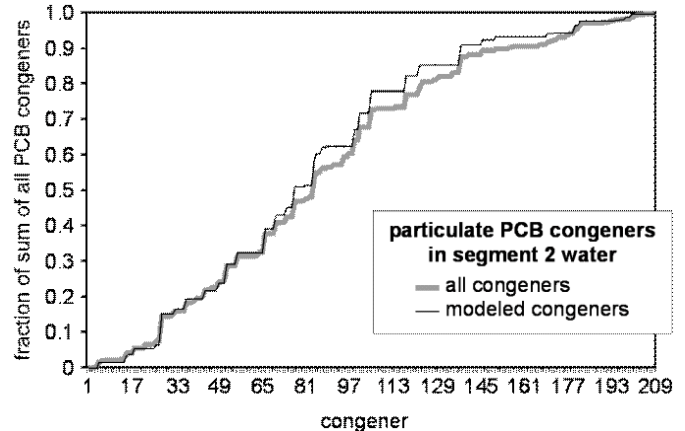

Figure 1.6.6. Cumulative frequency distribution – particulate PCB congeners in segment 2 water.

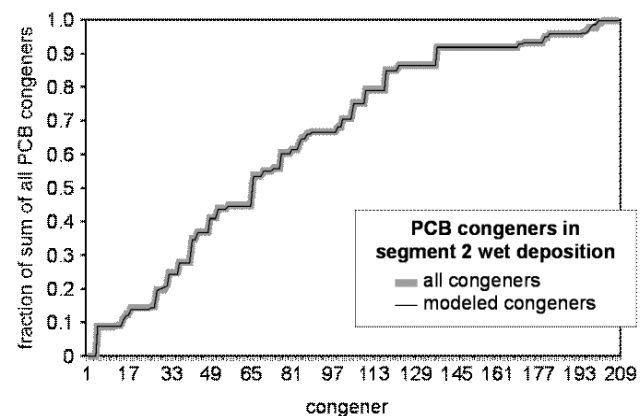

Figure 1.6.4. Cumulative frequency distribution – PCB congeners in segment 2 wet deposition.

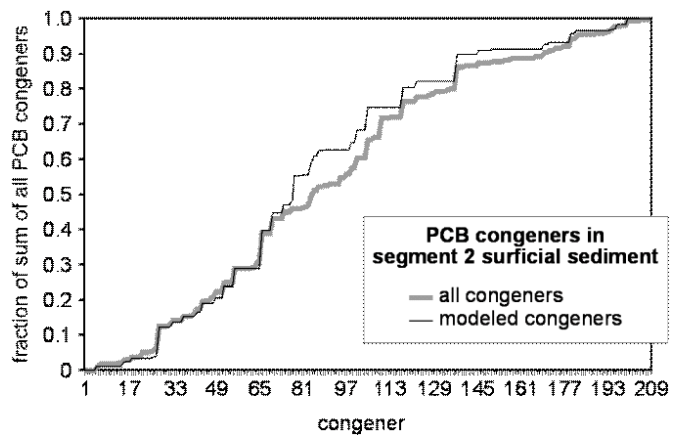

Figure 1.6.7. Cumulative frequency distribution – PCB congeners in segment 2 surficial sediment.

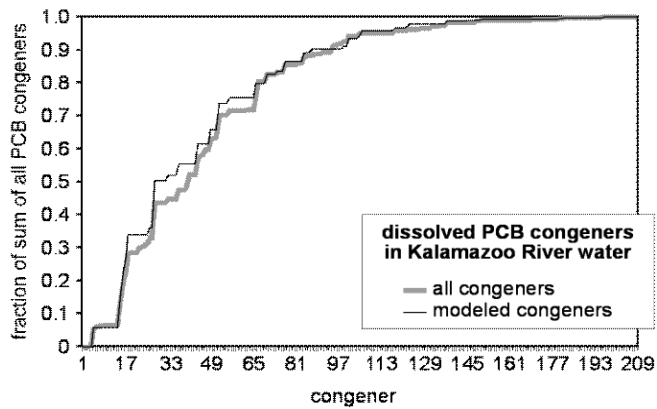

Figure 1.6.8. Cumulative frequency distribution – dissolved PCB congeners in Kalamazoo River water.

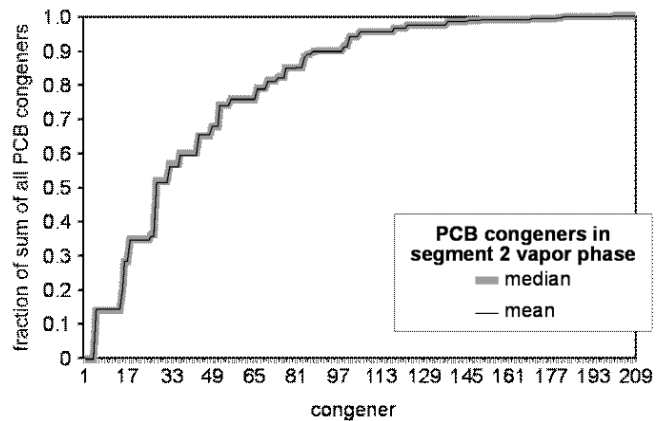

Figure 1.6.11. Cumulative frequency distribution – PCB congeners in segment 2 vapor phase.

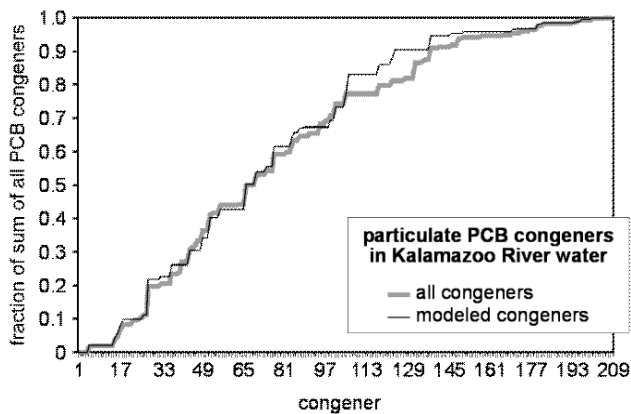

Figure 1.6.9. Cumulative frequency distribution – particulate PCB congeners in Kalamazoo River water.

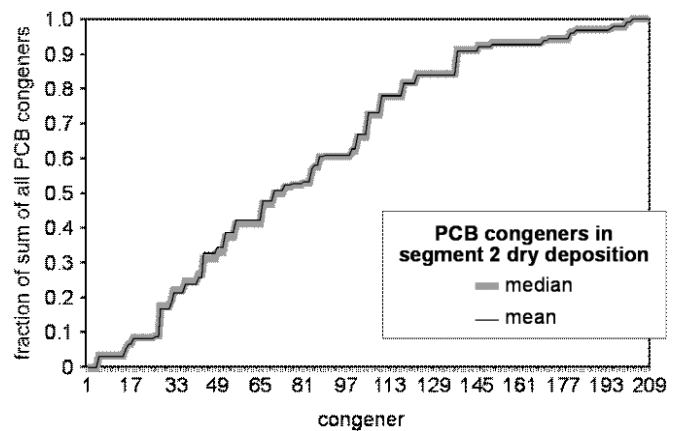

Figure 1.6.12. Cumulative frequency distribution – PCB congeners in segment 2 dry deposition.

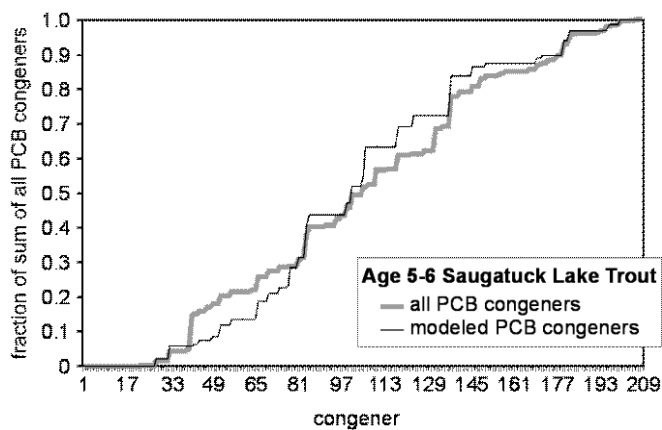

Figure 1.6.10. Cumulative frequency distribution – age 5-6 Saugatuck lake trout.

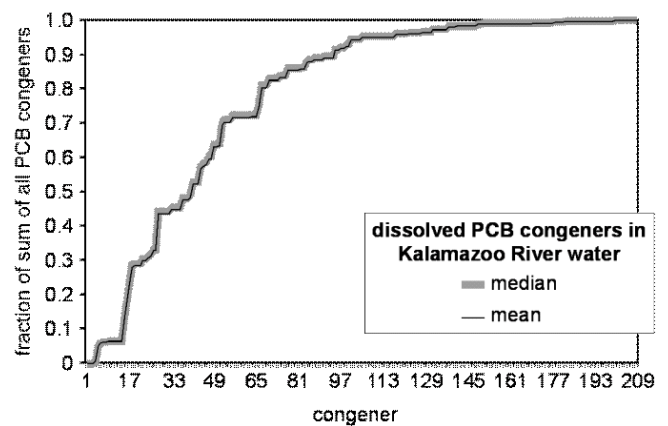

Figure 1.6.13. Cumulative frequency distribution – dissolved PCB congeners in Kalamazoo River water.

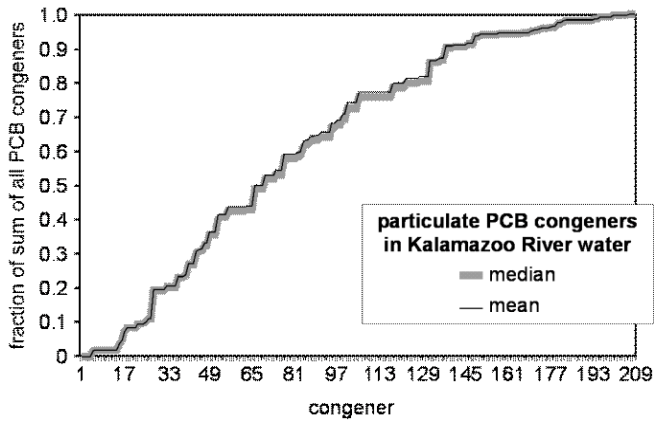

Figure 1.6.14. Cumulative frequency distribution – particulate PCB congeners in Kalamazoo River water.

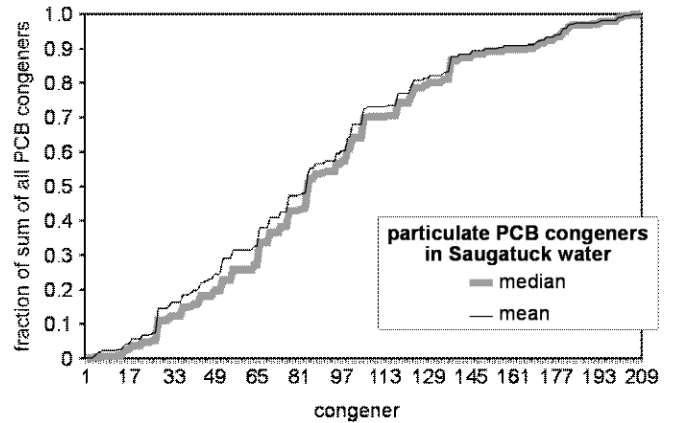

Figure 1.6.17. Cumulative frequency distribution – particulate PCB congeners in Saugatuck water.

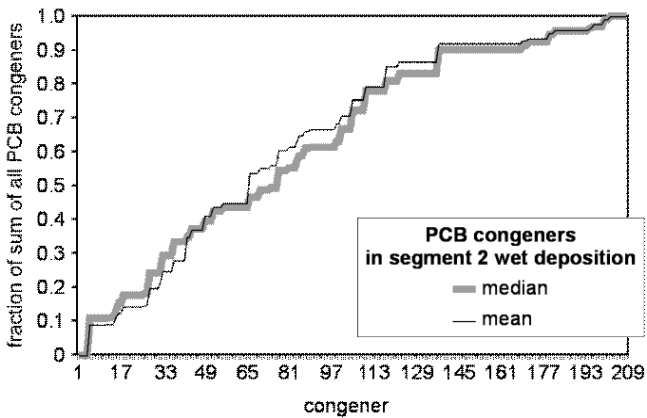

Figure 1.6.15. Cumulative frequency distribution – PCB congeners in segment 2 wet deposition.

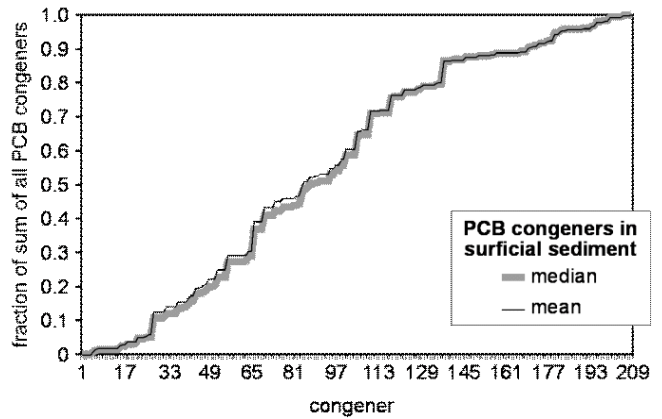

Figure 1.6.18. Cumulative frequency distribution – PCB congeners in surficial sediment.

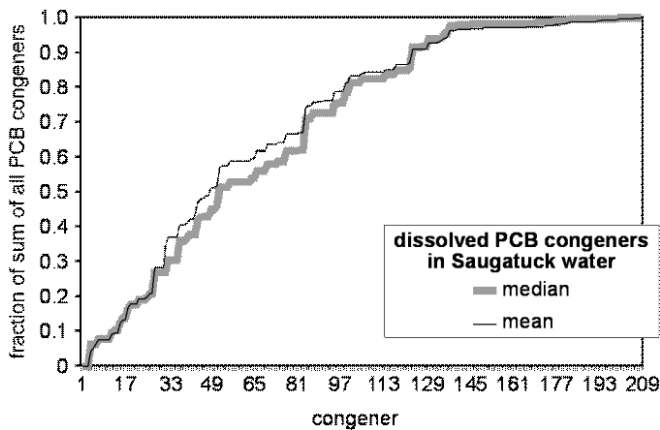

Figure 1.6.16. Cumulative frequency distribution – dissolved PCB congeners in Saugatuck water.

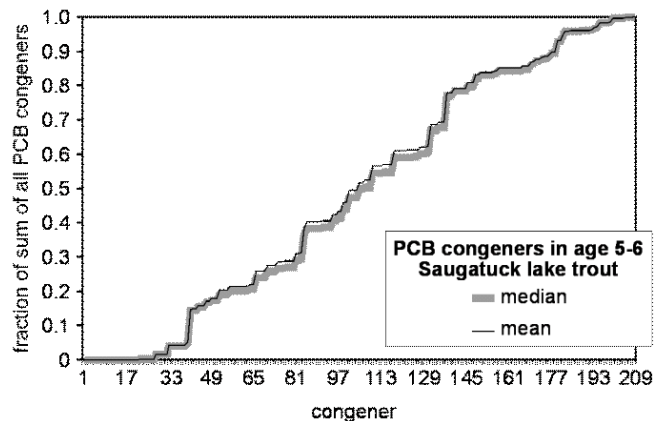

Figure 1.6.19. Cumulative frequency distribution – PCB congeners in age 5-6 Saugatuck lake trout.

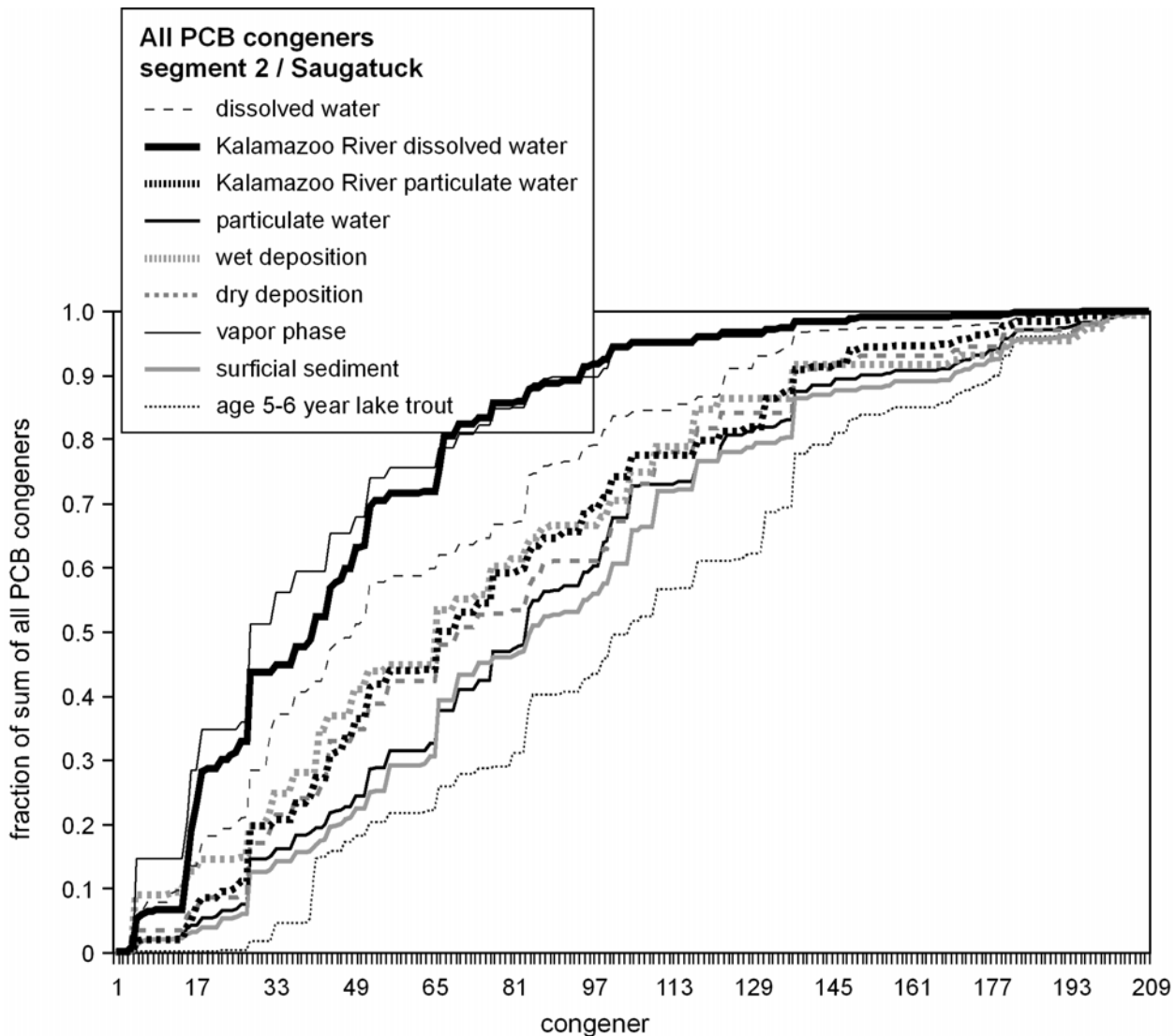

Figure 1.6.20. PCB congeners in segment 2, Saugatuck.

matching the vapor phase data. The pattern seen for open lake dissolved water samples did not closely match any of the other media. Open lake dissolved PCB congeners in water had a lower percentage of lower chlorinated congeners than either the vapor phase or dissolved water congener samples from the Kalamazoo River, but it had a higher percentage of these congeners than any of the other media.

The Kalamazoo River particulate PCB congeners in water had a higher percentage of lower congeners than open lake particulate PCB congeners in water and closely matched the congener patterns seen in both wet and dry deposition data for segment 2.

Open lake particulate PCB congeners data most closely matched the surficial sediment for segment 2. Age 5-6 year-old lake trout had a much lower percentage of lower chlorinated congeners than any of the other media.

1.6.4.4 Comparison of Atmospheric Congener Data

Atmospheric PCB samples for vapor phase and wet and dry deposition media were collected from a number of land-based stations around Lake Michigan, as well as from shipboard stations (Figure 1.6.21) on several LMMBP surveys (U.S.

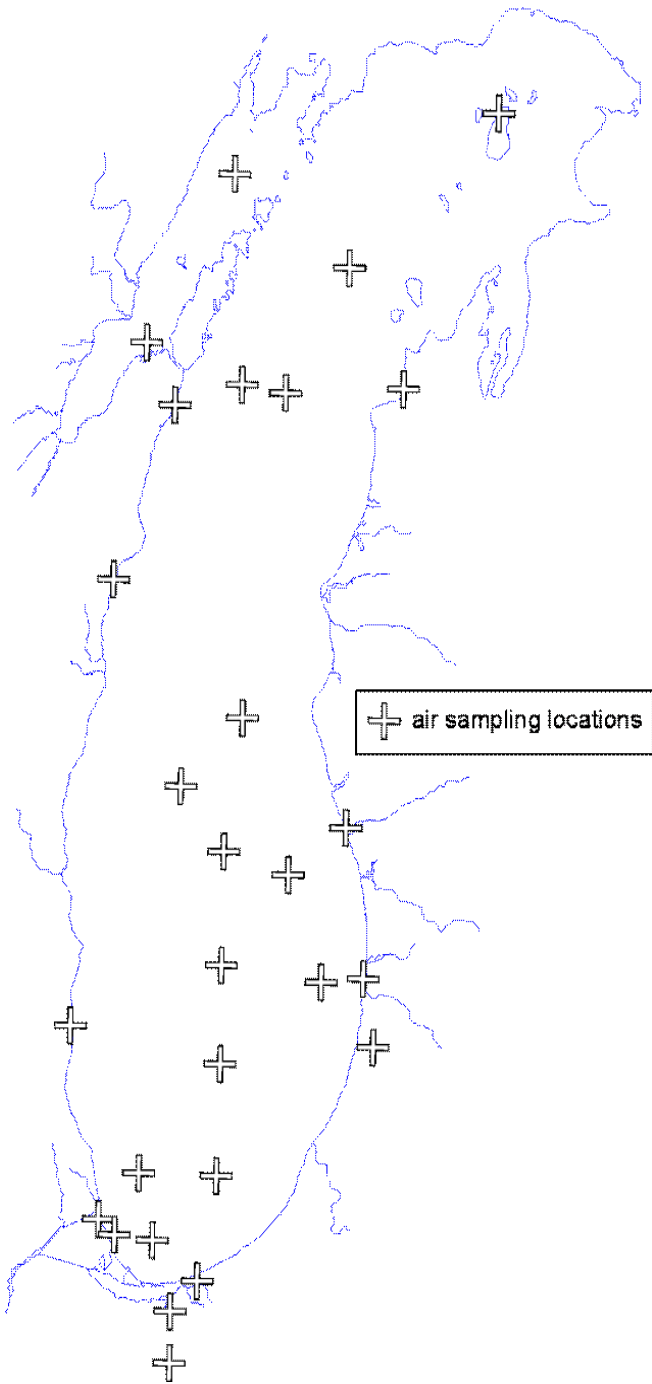

Figure 1.6.21. Air sampling locations.

Environmental Protection Agency, 1997). These data were then used by Hornbuckle to generate over-water concentrations of PCB congeners for all 5 km surface grid cells used for the high-resolution model (Green, 2000; Miller *et al.*, 2001) (see Figure 1.6.22). Hornbuckle only analyzed modeled congeners, thus

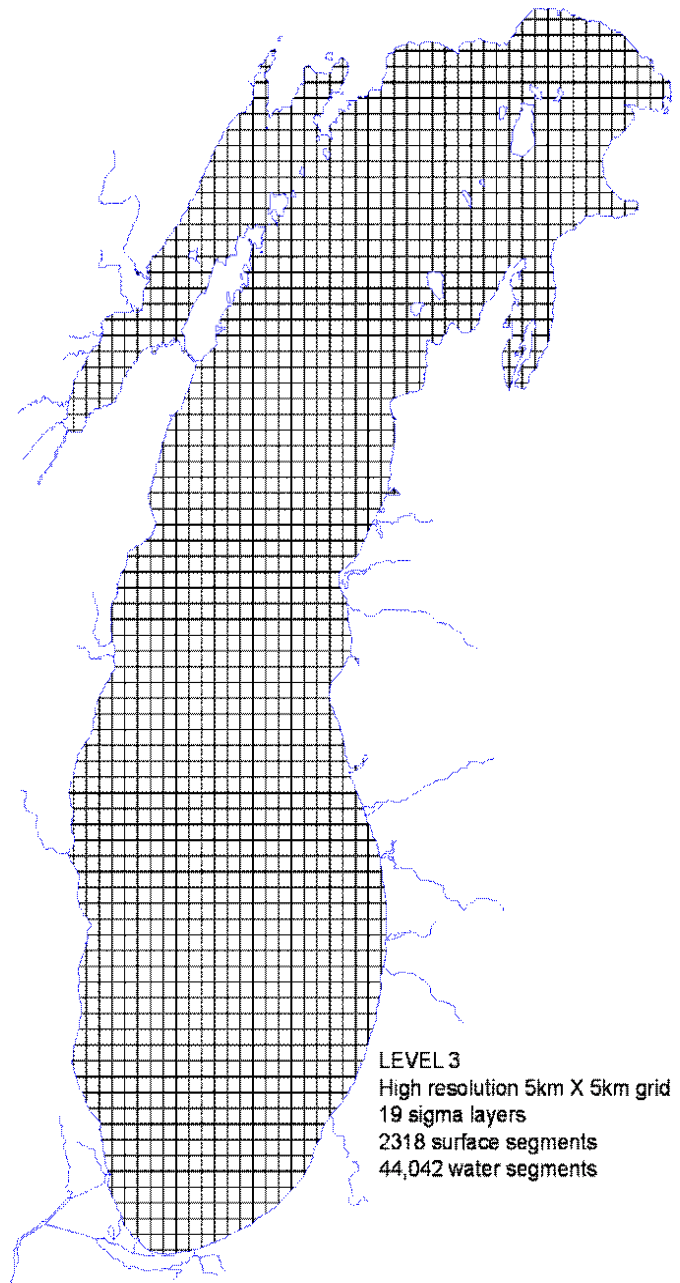

Figure 1.6.22. Lake Michigan high-resolution 5 km x 5 km grid with 19 sigma layers.

the congener set for this media is somewhat smaller than in other media. These data were then aggregated for modeling into surface segment cells for the LM2-Toxic model (Figure 1.6.1). As stated previously, the Saugatuck biota box (LMMBP-Biota3) is located within LM2 segment 2. A congener pattern comparison was done to see if the congener patterns

seen in segment 2 were similar to patterns seen in other segments. This was indeed the case with vapor phase and wet deposition data (Figures 1.6.23 and 1.6.24). For dry deposition samples, LM2 segment 1, which is the southwest corner of the lake, is somewhat lower in tetrachloro and pentachloro congeners than all of the other segments, which have a very similar congener pattern (Figure 1.6.25).

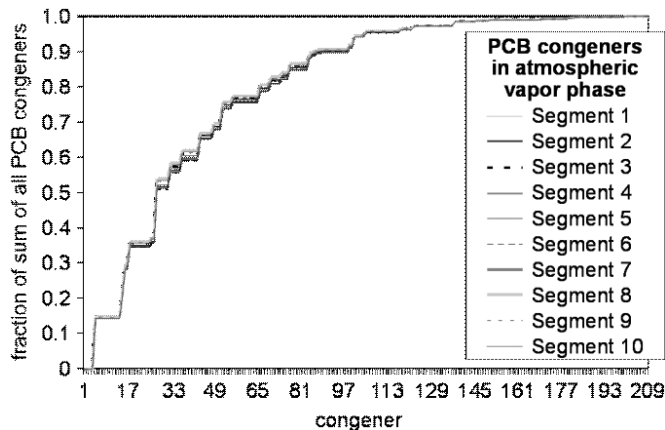

Figure 1.6.23. Cumulative frequency distribution (mean) – PCB congeners in atmospheric vapor phase.

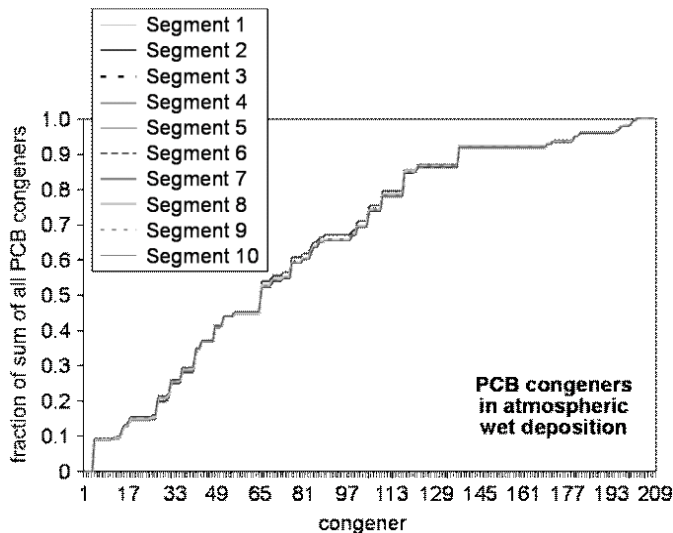

Figure 1.6.24. Cumulative frequency distribution (mean) – PCB congeners in atmospheric wet deposition.

A comparison of vapor phase PCB samples from segment 2 to wet and dry deposition samples from this segment (Figure 1.6.26) showed a somewhat similar congener distribution for wet and dry

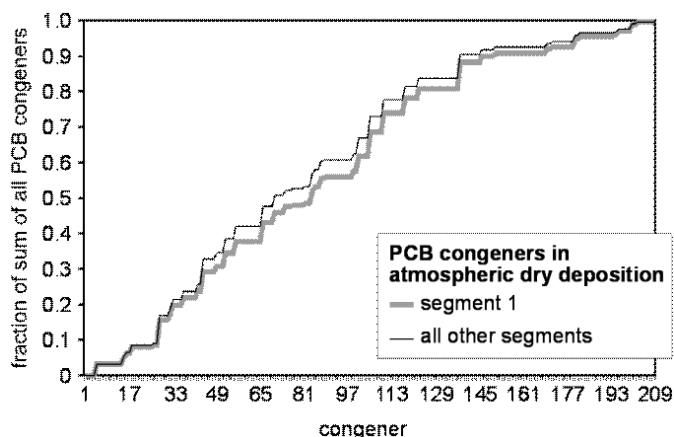

Figure 1.6.25. Cumulative frequency distribution (mean) – PCB congeners in atmospheric dry deposition.

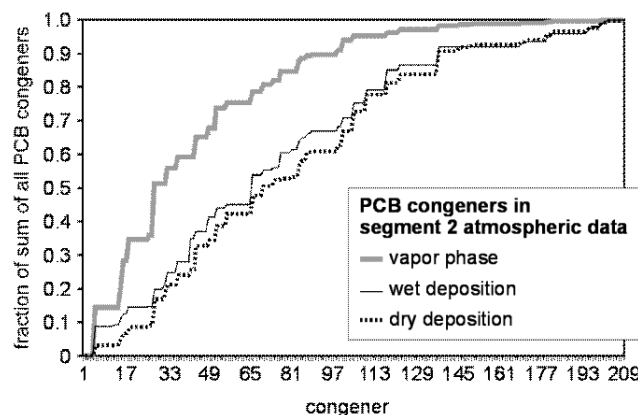

Figure 1.6.26. Cumulative frequency distribution (mean) – PCB congeners in segment 2 atmospheric data.

deposition samples. The vapor phase congener pattern was quite different with a much higher percentage of lower chlorinated congeners.

1.6.4.5 Comparison of Tributary Congener Patterns

An examination of 11 monitored LMMPB tributaries show that dissolved water samples clearly had a higher percentage of lower chlorinated congeners than do particulate water samples (Figure 1.6.27). The Fox River dissolved PCBs in water had a higher percentage of lower congeners than any of the other dissolved tributary samples. This same trend held true for Fox River particulate water samples.

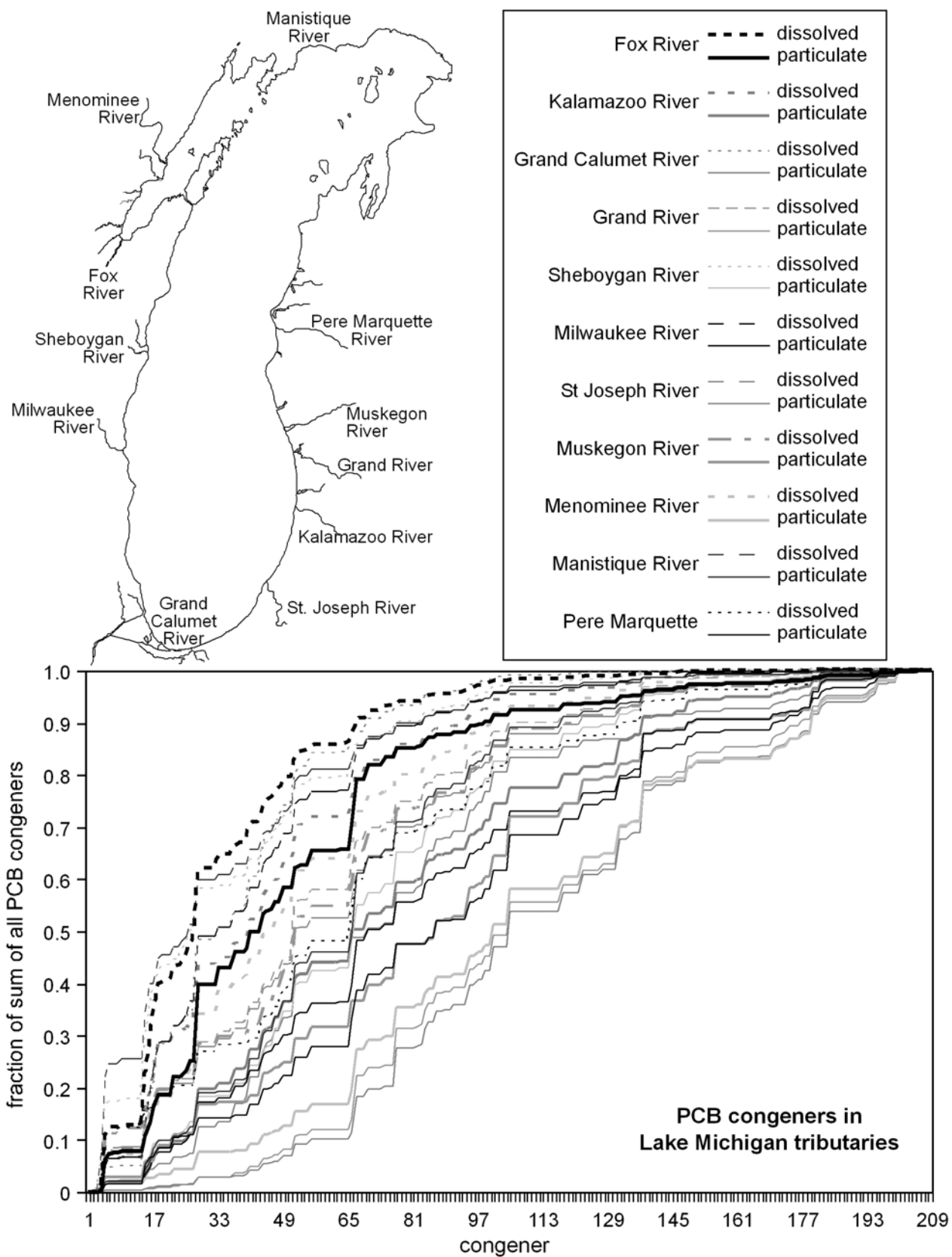

Figure 1.6.27. PCB congeners in Lake Michigan tributaries.

When segment 2 data for other media were overlaid on the tributary data, it appears that vapor phase data most closely matched dissolved water tributaries data from the western side of the lake (Figure 1.6.28), dissolved water data from segment 2 most closely matched dissolved water tributary data from rivers in the lower peninsula of Michigan (Figure 1.6.29), and particulate water data from segment 2 generally fell in the middle of the particulate tributary data (Figure 1.6.30).

1.6.4.6 Comparison of Ages 5 and 6 Lake Trout Congener Patterns in All Biota Boxes

Five and six year-old lake trout were collected and analyzed from all three LMMBP biota boxes (Sturgeon Bay: LMMBP-Biota1, Sheboygan Reef: LMMBP-Biota2, and Saugatuck: LMMBP-Biota3). Congener patterns were similar for all three biota boxes, with Saugatuck having a somewhat higher percentage of lower congeners, Sheboygan reef

having the lowest percentage of lower congeners, and Sturgeon Bay being in between (Figure 1.6.31).

1.6.4.7 Comparison of Different Lake Trout Age Class Congener Patterns in Saugatuck Biota Box

A comparison was done between different age classes of lake trout in the Saugatuck biota box to see if the congener patterns were different for different age classes. Lake trout data for year classes 2, 3, and 9 were compared to age classes 5 and 9 lake trout (Figure 1.6.32). This comparison showed that there was very little difference between the congener patterns of these different age classes.

1.6.5 Conclusions

When all media were looked at, there were very clear differences in the congener patterns that were observed.

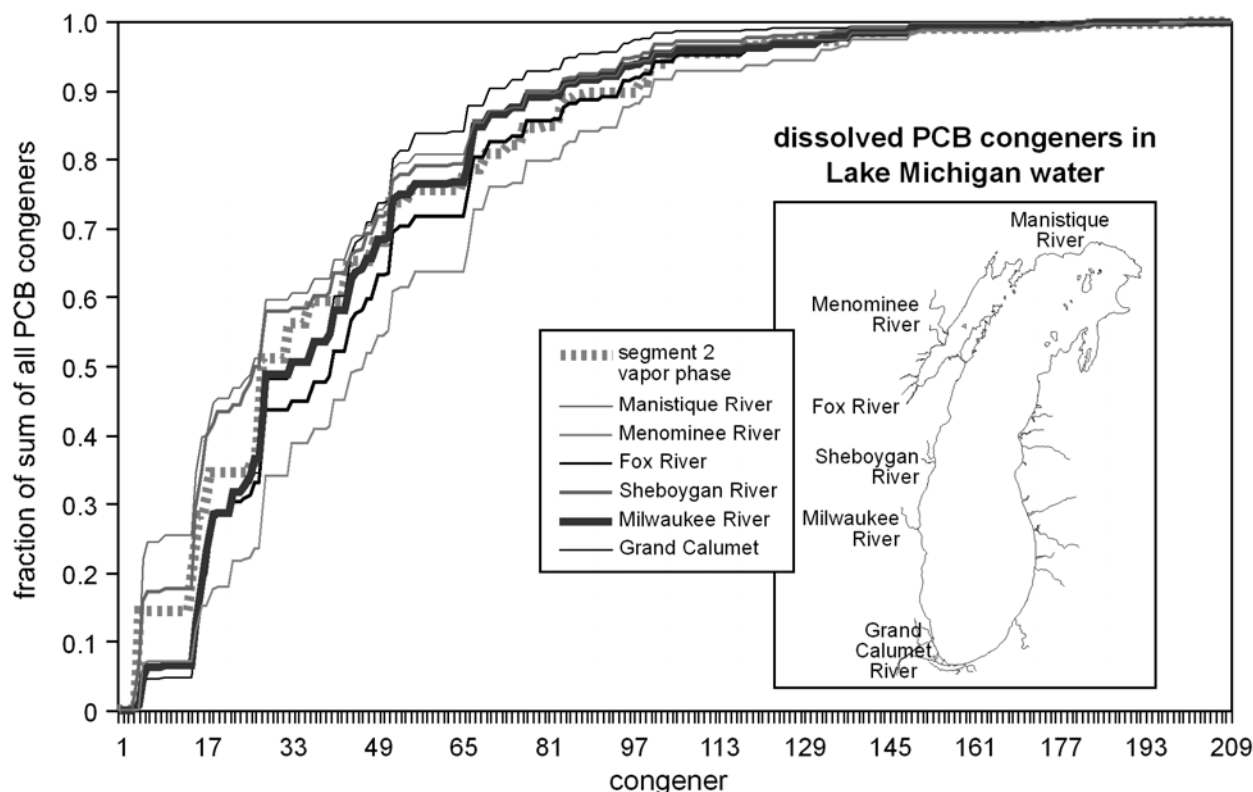

Figure 1.6.28. Comparison of dissolved PCB congeners in Lake Michigan western tributaries to segment 2 vapor phase.

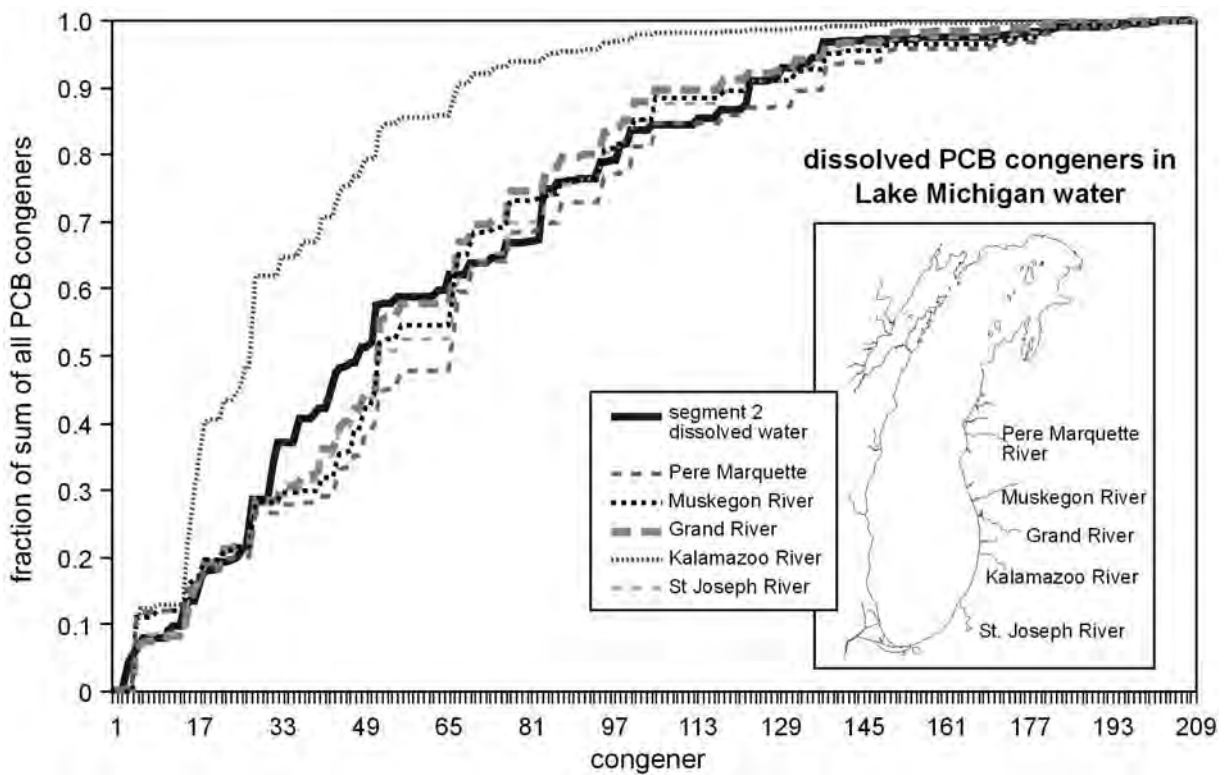

Figure 1.6.29. Comparison of dissolved PCB congeners in Lake Michigan eastern tributaries to segment 2 water.

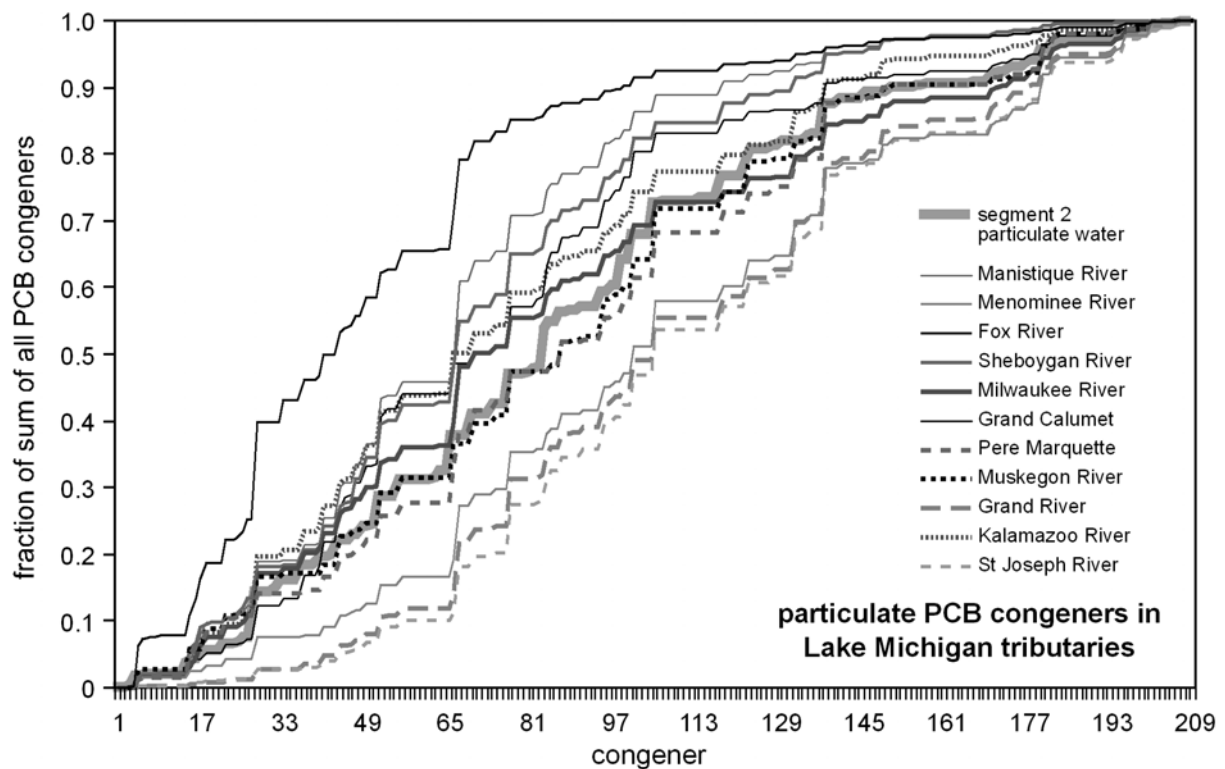

Figure 1.6.30. Comparison of particulate PCB congeners in Lake Michigan segment 2 to tributaries.

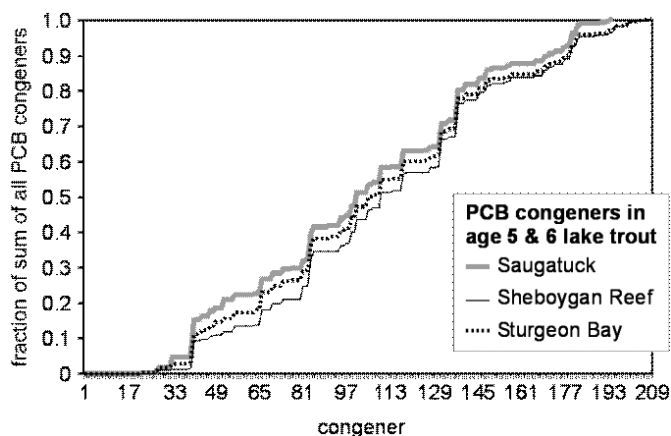

Figure 1.6.31. Cumulative frequency distribution (mean) – PCB congeners in ages 5 and 6 lake trout.

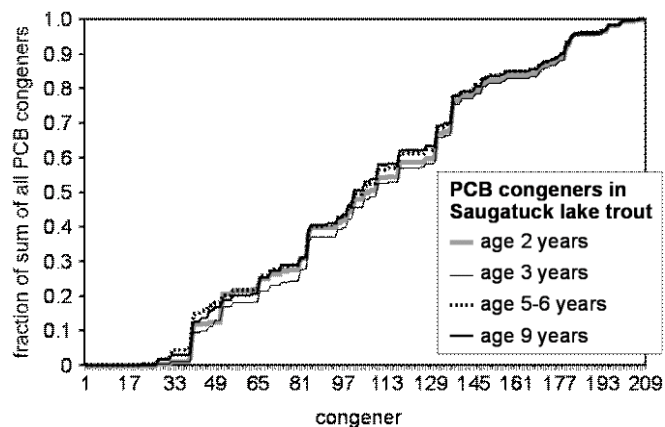

Figure 1.6.32. Cumulative frequency distribution (mean) – PCB congeners in Saugatuck lake trout.

Vapor phase data had the highest percentage of lower chlorinated congeners of all the media examined. In all cases, the dissolved fraction of water samples had a higher percentage of lower chlorinated congeners than the corresponding particulate fraction of water samples. The Kalamazoo River dissolved and particulate water samples had a higher percentage of lower chlorinated congeners than the corresponding open lake dissolved and particulate water samples. The Kalamazoo River dissolved water samples most closely resembled the vapor phase data, while the Kalamazoo River particulate water data most closely resembled segment 2 wet and dry deposition data. This could be due to the possibility that PCBs in the

river are from a newer (non-weathered) source of contamination than open lake samples.

Open lake particulate samples most closely matched the surficial sediment data for segment 2. This result probably is not too surprising considering the close relationship between sediments and particulates and the continuous deposition and resuspension of bottom sediments in the water column.

Atmospheric congener patterns were very uniform over the entire lake, with the exception of dry deposition data which had a somewhat different congener pattern in segment 1 than in all of the other model segments. Wet and dry deposition samples showed similar congener patterns for segment 2 with dry deposition samples having a slightly lower congener distribution pattern than wet deposition samples. This is the same trend that was seen in lake water and tributary samples. Vapor phase samples for segment 2 had a very different congener pattern with a much higher percentage of lower chlorinated congeners.

Dissolved tributary water samples had a higher percentage of lower chlorinated congeners than particulate water samples. It is interesting that dissolved water tributary data, with the exception of the Kalamazoo River, from the western side of Lake Michigan (Fox, Grand Calumet, Sheboygan, Milwaukee, Manistique, and Menominee Rivers) generally had a higher concentration of the lower chlorinated congeners than tributaries from the lower peninsula of Michigan (Grand, Muskegon, Pere Marquette, and St. Joseph Rivers) (Figure 1.6.33). This same trend generally holds true for the tributary particulate data (Figure 1.6.34). Overall, the Fox River had the highest percentage of lower chlorinated congeners for both dissolved and particulate samples.

Fish from all three biota boxes had very similar congener patterns. In addition, fish from different age classes in the same biota box (Saugatuck) also had very similar congener patterns. This would seem to indicate that the same processes are responsible for determining the congener pattern distribution in fish. This pattern was also similar to the trend that Kuehl observed in her analysis of LMMBP biota samples (Kuehl, 2002), where she reported that

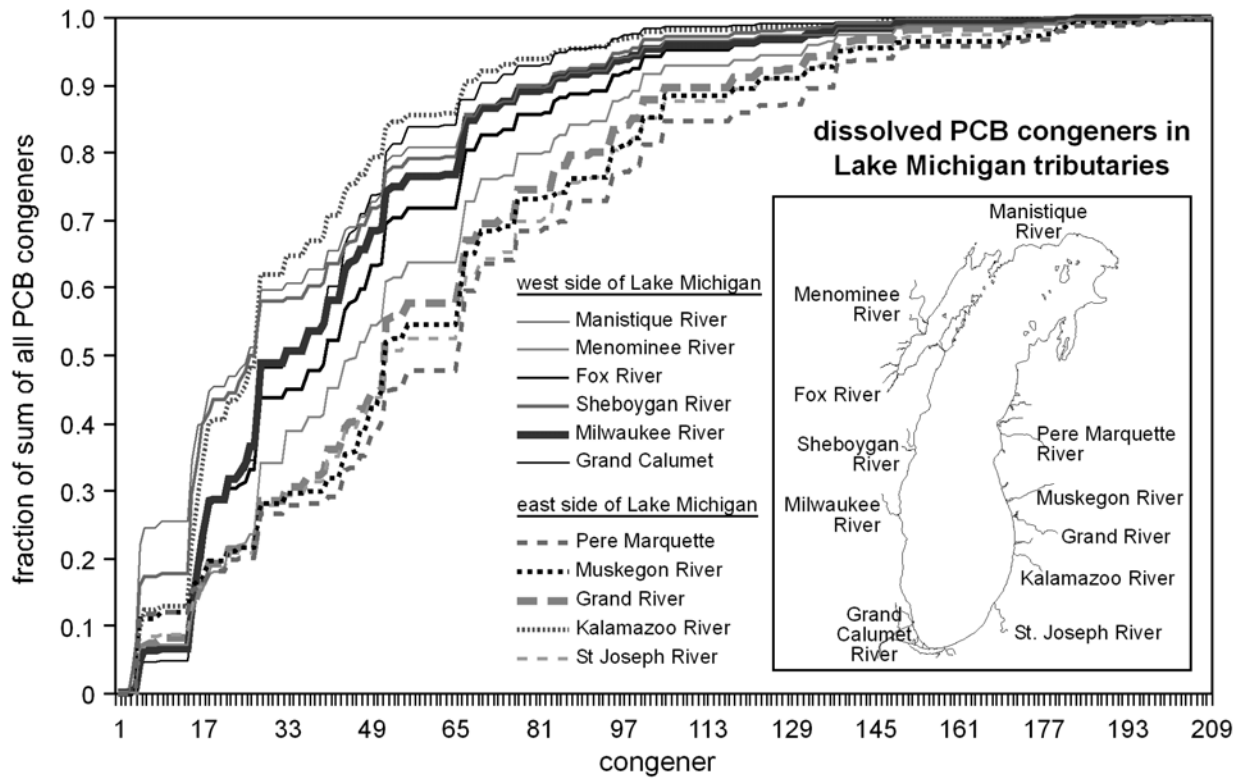

Figure 1.6.33. Comparison of dissolved PCB congeners in west side-to-east side of Lake Michigan tributaries.

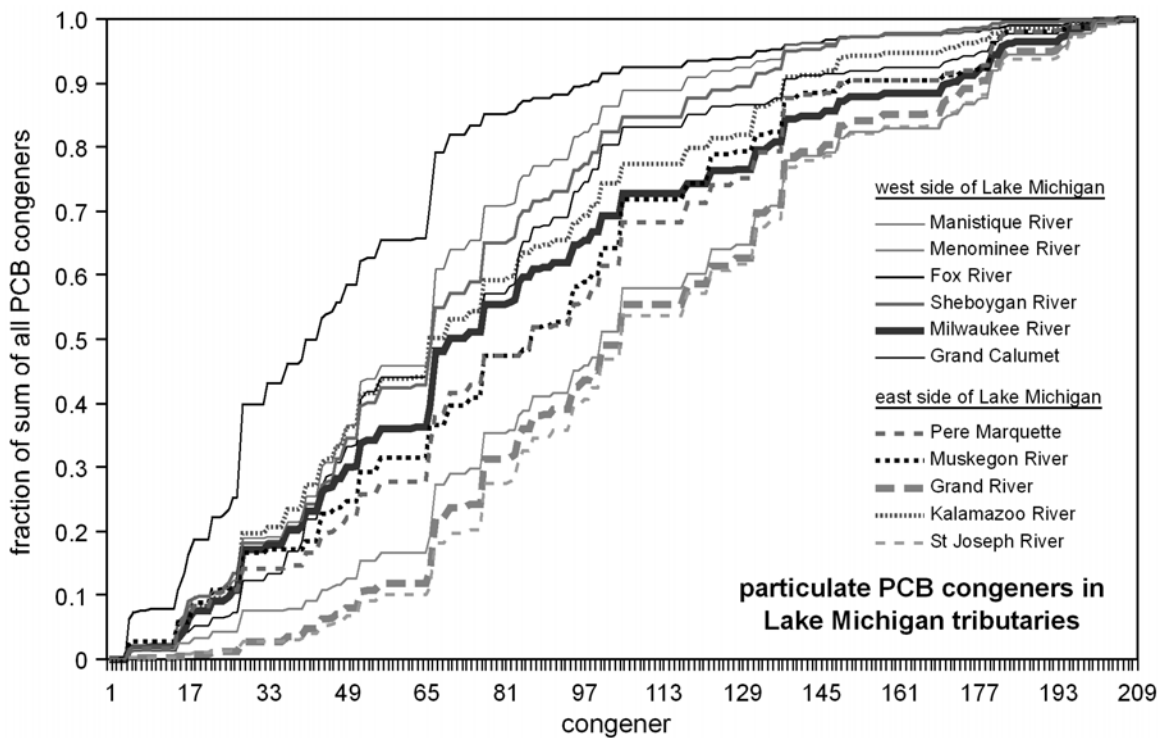

Figure 1.6.34. Comparison of particulate PCB congeners in west side-to-east side of Lake Michigan tributaries.

“With the exception of deepwater sculpin samples collected in Biota Box #3 near Saugatuck, all LMMBP biota sample congener patterns were homogeneous”, and “A relatively consistent pattern of the selected PCB congeners was measured in all of the biota species or classifications.” Also, while the age class 5-6 year-old lake trout congeners pattern for biota box number 3 most nearly matched the congener patterns of surficial sediment and particulate water samples from modeling segment 2, this was not a very close match.

From this data investigation, it was clear that it was impossible to relate PCB contamination of lake trout to a tributary source based on congener pattern matching. This is due to the fact that tributary congener patterns for Lake Michigan, regardless of source, had congener patterns which were significantly different from all lake trout congener patterns. In addition, congener patterns seen in lake trout from different biota boxes had very similar congener patterns, which would indicate that there are no spatial differences in lake trout congener patterns.

References

- Green, M.L. 2000. Geographic Information System Based Modeling of Semi-Volatile Organic Compounds Temporal and Spatial Variability. Ph.D. Thesis, University of New York, Buffalo, New York. 250 pp.
- Kuehl, M. 2002. Polychlorinated Biphenyl (PCB) Congener Patterns in Lake Michigan Mass Balance Study Biota. M.S. Thesis, University of Wisconsin, Green Bay, Wisconsin. 120 pp.
- McCarty, H.D., J. Schofield, K. Miller, R.N. Brent, P. Van Hoff, and B. Eadie. 2004. Results of the Lake Michigan Mass Balance Study: Polychlorinated Biphenyls and *trans*-Nonachlor Data Report. U.S. Environmental Protection Agency, Great Lakes National Program Office, Chicago, Illinois. EPA/905-R-01/011, 289 pp.
- Miller, S.M., M.L. Green, J.V. DePinto, and K.C. Hornbuckle. 2001. Results from the Lake Michigan Mass Balance Study: Concentrations and Fluxes of Atmospheric Polychlorinated Biphenyls and *trans*-Nonachlor. *Environ. Sci. Technol.*, 35(2):278-285.
- U.S. Environmental Protection Agency. 1997. Lake Michigan Mass Balance Study (LMMBP) Methods Compendium, Volume 2: Organic and Mercury Sample Analysis Techniques. U.S. Environmental Protection Agency, Great Lakes National Program Office, Chicago, Illinois. EPA/905/R-97/012b, 532 pp.

PART 1

INTRODUCTION

Chapter 7. Hindcasting and Forecasting Functions for PCBs in the Lake Michigan Ecosystem

Ronald Rossmann
U.S. Environmental Protection Agency
Office of Research and Development
National Health and Environmental Effects
Research Laboratory
Mid-Continent Ecology Division
Large Lakes and Rivers Forecasting Research
Branch
Large Lakes Research Station
9311 Groh Road
Grosse Ile, Michigan 48138

1.7.1 Introduction

The challenge for both hindcasting and forecasting is the development of functions that represent the change of polychlorinated biphenyl (PCB) loads to the lake with time. To accomplish this, quality historical databases are required that bracket both sides of the peak load to the lake. The use of PCB production information are of limited usefulness. They do not represent the historical use of PCBs in the Lake Michigan basin. The early use of PCBs was primarily in sealed containers as capacitors and transformers. PCBs were not released except at points of manufacture and locations where capacitors and transformers were manufactured. The number of these sites was limited. None were within the Lake Michigan basin. The open use of PCBs within the basin were primarily for the manufacture of carbonless paper and as a hydraulic fluid for die-casting. The first recorded use of PCBs for

manufacture of carbonless paper was in 1954 in the Fox River Valley at Green Bay, Wisconsin (Table 1.7.1). In the Fox River Valley, its use for this purpose peaked in 1969-1970. Its use for production of the paper as well as recycling of the paper was phased out in 1971-1972. Other locations associated with production of this carbonless paper or its recycling included the Manistique and Kalamazoo Rivers. The use of hydraulic fluids with PCBs began in 1948 and ended in 1971 at Waukegan, Illinois. Another location where these hydraulic fluids were used was Sheboygan, Wisconsin. It appears that these two uses are most responsible for the loads of PCBs to Lake Michigan. These uses are poorly quantified. Therefore, historical observations of PCBs in various media were used to construct load functions for both forecasts and hindcasts.

1.7.2 Forecast Functions

Functions developed for the purpose of forecasting PCBs in various media were developed from the 1994-1995 Lake Michigan Mass Balance Project (LMMBP) data and data from various published and unpublished sources. The data were used to develop functions that describe the apparent loading trends for PCB loads from the atmosphere and tributaries. Data were extremely limited. Historical data are of unknown quality due to changes in methodology. Specifically, those data generated using packed columns rather than capillary columns for the gas chromatography are suspect. Packed columns did not provide a good separation of PCB peaks. Older results were expressed as Aroclors rather than congeners. These weaknesses can lead to a high bias. However, these data were all that

Table 1.7.1. Significant Dates in the History of PCBs in the Lake Michigan Basin

Date	Event
1865	First PCB-like chemical discovered
1881	First PCBs synthesized
1914	Measurable amounts of PCBs found in bird feathers
1927	PCBs first manufactured at Anniston, Alabama
1935	PCBs manufactured at Anniston, Alabama and Sauget, Illinois
1948-1971	Outboard Marine Corporation at Waukegan, Illinois purchased eight million gallons of hydraulic fluid with PCBs
1954	Appleton Paper Company began using PCBs as PCB-coated carbonless copy paper
Mid-1950s to Mid-1960s	PCBs loaded to Kalamazoo River from deinking
1950s to 1980s	PCBs discharged to Manistique River and Harbor
1959-1972	Outboard Marine Corporation at Waukegan, Illinois used hydraulic fluid with PCBs for die-casting
1959-1971	PCBs used by Tecumseh Products Company as a hydraulic fluid was loaded to Sheboygan River
1969-1970	Paper company discharges of PCBs to Fox River peaked
1970	PCB production peaked at 85 million pounds and huge contamination noted at Sauget, Illinois plant
1971-1972	Appleton Paper Company and NCR Corporation phased out PCB use. Recycling of carbonless paper had occurred for several decades
1973	U.S. Food and Drug Administration (USFDA) establish 5 ppm PCB tolerance level in fish
1975	124,000 cans of salmon from Lake Michigan seized because of PCBs
1977	PCB production ends
1984	USFDA lowered PCB tolerance level in fish to 2 ppm
1985	Commercial fishing for carp and other valuable species outlawed on Green Bay
1991	End Sheboygan River PCB remediation of upper river
1991	U.S. Department of Health and Human Services label PCBs as possible carcinogen
1992	End Waukegan Harbor PCB remediation
1998	The eight Great Lakes states agreed on a "Great Lakes Protocol for Fish Consumption Advisories" that lowered the regional standard from the USFDA commercial standard of 2 ppm down to 0.05 ppm
1997-1998	Milwaukee River PCB remediation
2001	Manistique Harbor PCB remediation completed
2002	Possibly begin Grand Calumet River PCB remediation

were available at the time of model development and execution.

1.7.2.1 Tributary Loads

Several data sets were used to develop a first-order exponential decay function for tributary loads. The derivation of the PCB loading attenuation rate half-life for tributaries is straightforward. It utilized 1994 and 1995 LMMBP tributary data (McCarty *et al.*, 2004) along with data for the Fox River for 1989-1990 (Velleux and Endicott, 1994) and for Lake Michigan tributaries for 1982 (Marti and Armstrong, 1990). The loading data for the Fox River, Lake Michigan

tributaries, and 1994-1995 were fit using Equation 1.7.1.

$$C_1 = C_2 e^{-kt} \tag{1.7.1}$$

where:

C_1 = load at time t_1

C_2 = load at time t_2

k = attenuation rate

t = interval of time between t_1 and t_2

The equation was solved for k . For the Fox River and Lake Michigan tributaries, k was calculated to be 0.053/year and 0.054/year, respectively. These yielded the half-lives of 12-13 years. The k of 0.054/year was used.

Recent reports of half-lives for individual tributaries range from 6.1 years ($k = 0.114/\text{year}$) in the Kalamazoo River (Blasland, Bouck and Lee, Inc., 2000) to 6.8 years ($k = 0.102/\text{year}$) at the Fox River DePere Dam and 9.0 years ($k = 0.077/\text{year}$) at the river mouth (Limno Tech, Inc., 2002). Thus, the choice of a k equal to 0.054 is probably conservative for the purposes of a forecast; that is, tributary loadings could be biased high, leading to later dates when lake trout will cease to have consumption advisories.

1.7.2.2 Atmospheric Loads

For the period of 1992 to 1997, Simcik *et al.* (2000) reported a half-life of 6.9 ± 3.5 for precipitation. The half-life for atmospheric vapor phase PCBs was taken as reported by Schneider *et al.* (2001) based upon the work of Hillery *et al.* (1997). Hillery *et al.* (1997) based their work on the 1992-1995 International Atmospheric Deposition Network (IADN) data. At that time, the reported half-life was six years. This is one of the bounding half-lives used for all forecasts. More recently published half-lives include those of Simcik *et al.* (1999) who reported half-lives of 2.7 years and 3.0 years over water and land, respectively. Their results were based on 1992-1997 IADN data. For the period of 1992 through 2000 at Sleeping Bear Dunes, Buehler *et al.* (2002) reported half-lives of 3.1 ± 0.7 years for 1992 through 1995, 4.9 ± 0.9 years for 1992 through 1997, and 20.0 ± 8.6 years for 1992 through 2000. For the period of 1992 through 2001, an examination of the temperature-corrected PCB partial pressure IADN data revealed that partial pressures were declining at Sleeping Bear Dunes with a half-life rate of 8.3 ± 1.5 years (Buehler *et al.*, 2004). Because of the uncertainty concerning the rate of decline and the apparent increase in half-life with the addition of more recent data, bounding half-lives of 6 and 20 years were used for the purposes of the forecasts. The uncertainty in the half-life of atmospheric vapor phase PCBs suggests that a half-life of 13 years for tributaries is within reason.

1.7.3 Hindcast Functions

Development of a hindcast load function was more problematic. The only data that exist for years prior to the year of peak load are for preserved museum forage fish specimens (Neidermyer and Hickey, 1976) and lake trout (DeVault *et al.*, 1996). Though the forage fish data can not be used for a hindcast because they are preserved specimens, they do provide valuable information about when PCBs first appeared in Lake Michigan fish. The fourhorn sculpin data are of most interest. PCBs were not detected in the fish collected in 1949 but were found in fish collected in 1951. For rainbow smelt, PCBs were not detected in 1942 but were detected and measured in 1960. This is consistent with the first known reported purchase of hydraulic fluids with PCBs in 1948 for use at Waukegan, Illinois. Thus, it appears contamination of the lake with PCBs did not begin until after 1948. The lake trout annual data only go back to 1972 (DeVault *et al.*, 1996). The peak in the lake trout occurred in 1974-1975; hence, not enough data for establishing a function for the onset of contamination.

The only way currently available to reconstruct the load function of PCBs for the lake was to utilize information available from dated sediment cores. The number of sediment cores for which data are available are limited (Figure 1.7.1). Cores SLMD, SLMF, CLMM, NLMB, and NLME are from the work of Hermanson *et al.* (1991). The 18S core is from Swackhamer and Armstrong (1988), the HMS1 core is from Schneider *et al.* (2001), and cores 18G, 47s, and 68k are from Golden *et al.* (1993). The LMMBP cores are from Stations 15, 61, and 86 (Van Hoof and Eadie, personal communication). All the cores are of varying quality. Core quality is dependent upon sedimentation rate, depth of surficial sediment mixing by physical and biological processes, location with respect to sources, and thickness of the core interval samples. Of 13 cores, core 15 is of the highest quality. Sedimentation rate ($0.2235 \text{ g/cm}^2/\text{year}$) is one of the highest for Lake Michigan (core is highly resolved with the surficial 1 cm representing 1.2 years of deposition), its mixed layer is less than the 1 cm interval sampled, and it is located in an area of the lake that is very responsive to loadings. The location of core 15 is in the region impacted by an annual spring plume of suspended

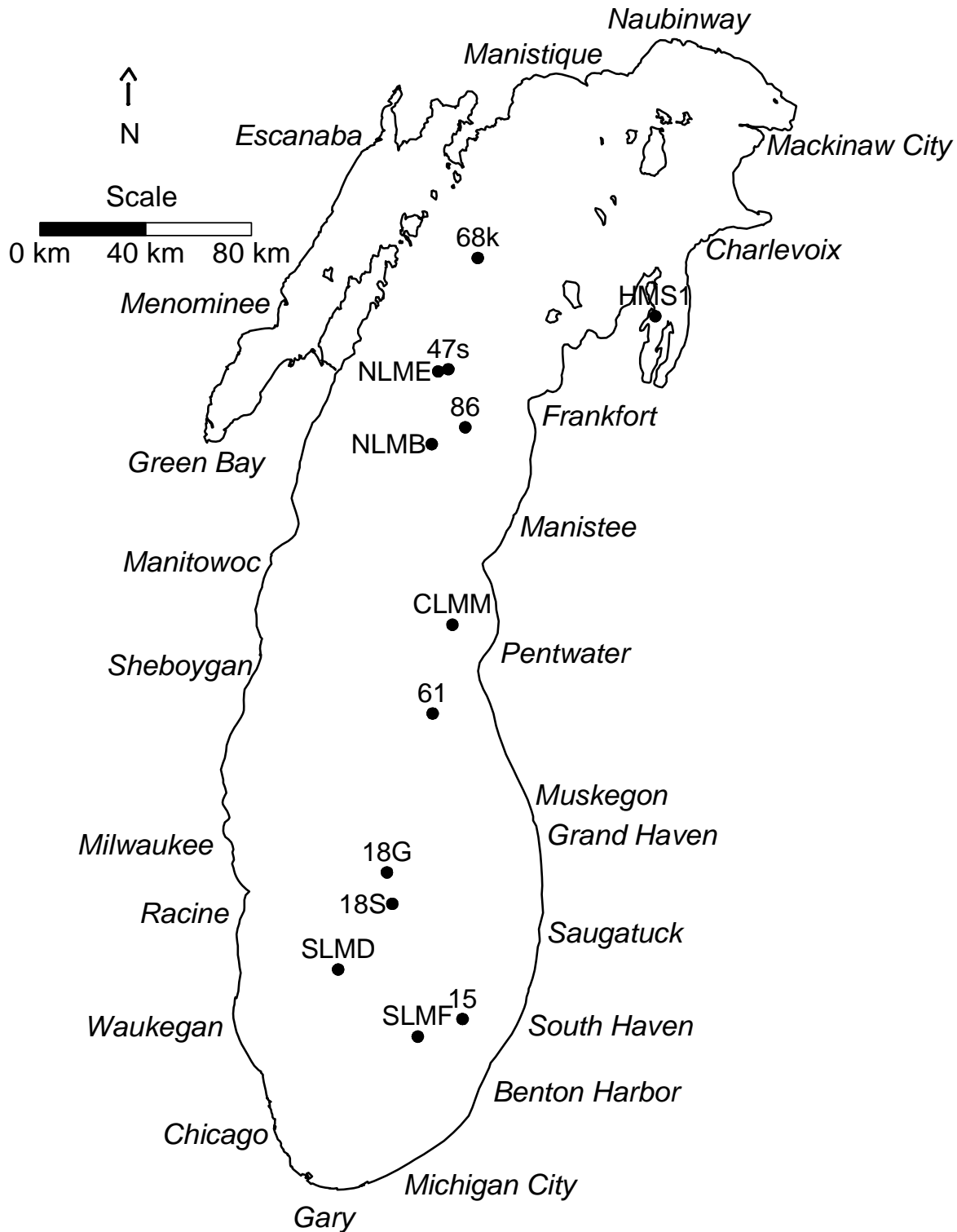

Figure 1.7.1. Locations of dated cores analyzed for PCBs by Hermanson *et al.* (1981), Swackhamer and Armstrong (1988), Schneider *et al.* (2001), Golden *et al.* (1993), and Van Hoof (personal communication) for the LMMBP.

particulate matter that has concentrations four to 10 times that of the lake (Eadie *et al.*, 1996). Because core 15 is highly resolved, relatively undisturbed by post-depositional mixing processes (mixed layer less than 1 cm), and in a region responsive to an annual transport event in the lake, it was chosen for the development of a total PCB loading function for the lake.

The distribution of PCBs within the core with time can be broken into two linear functions; one prior to peak concentration and one after peak concentration (Figure 1.7.2). The pre-peak function was based on the period of 1947 to 1965, and the post-peak function was based on the period 1972 to 1994. The two functions crossed one another in 1967, indicating this should be the peak load year. The exact location of the peak was problematic because there are two peaks in the observed data. The year of peak loading was constrained by the date of the peak concentration of PCBs in lake trout. This peak occurred between 1974 and 1975 for five to six year-old fish (DeVault *et al.*, 1996). Thus, peak exposure could have occurred as early as 1968 and as late as 1970. This was used as guidance when selecting the year ranges from which the linear functions were

chosen. The peak concentration for the intersection of the two functions needed to be near the range of 1968 to 1970. In addition, the simple linear regression model for the onset of contamination had to intersect the x-axis around 1949 when PCBs were first noted in forage fish. The function derived for the onset of PCB loading to the lake is:

$$C_{PCB} = [(- 26316.85) + (13.509334 * yr)] \quad (R^2 = 0.865) \quad (1.7.2)$$

where:

C_{PCB} = concentration of PCBs in ng/g

yr = calendar year.

The function derived for the decline of PCB load to the lake is:

$$C_{PCB} = [(15647.899) + (- 7.823438 * yr)] \quad (R^2 = 0.897) \quad (1.7.3)$$

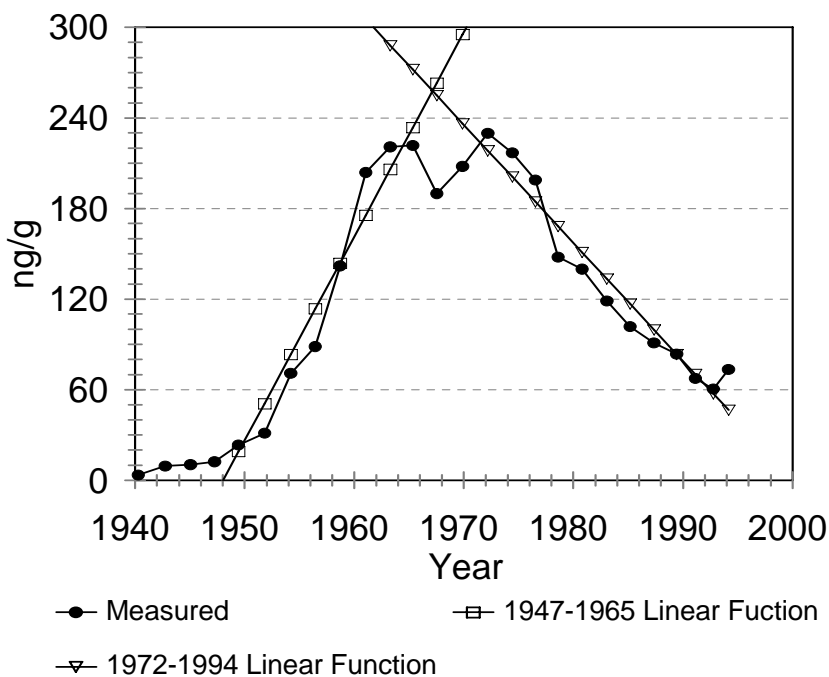

Figure 1.7.2. Fit of concentration functions to observed data for core 15.

The two function lines crossed in roughly 1967. This was considered acceptable and assumed to be the peak load year.

Finally, results from these concentration functions were converted to annual loads. This was done by using mass sedimentation rate information (Rossmann and Edgington, 2000; Rossmann, 2002). The flux of PCBs to the lake can be described as:

$$F_{PCB} = (C_{PCB}) * (MSR) \quad (1.7.4)$$

where

F_{PCB} = flux of PCBs in ng/cm²/year

MSR = mass sedimentation rate in g/cm²/year.

This calculated flux was then corrected for physical processes that redistribute sediment within the lake. Sediment focusing is the process by which sediments are moved from one location to another. The process includes sediment resuspension and transport by currents until deposition at another location. The materials that are preferentially resuspended are the fine-grained fraction of sediments. This fraction of the sediments has ²¹⁰Pb, ¹³⁷Cs, PCBs, and other contaminants associated with it. Thus sediments at the new deposition site become enriched in these while those at the original resuspension site may become depleted in these. The focusing factor applied was that for ²¹⁰Pb (Rossmann and Edgington, 2000). The ²¹⁰Pb focusing factor is defined as:

$$FF_{Pb210} = (A_{210Pb} - AS_{210Pb})/D_{210Pb} \quad (1.7.5)$$

where:

FF_{210Pb} = ²¹⁰Pb focusing factor

A_{210Pb} = Activity of ²¹⁰Pb stored in the core for time period year

AS_{210Pb} = Activity of ²¹⁰Pb supported by radium in the sediment

D_{210Pb} = Decay corrected activity of ²¹⁰Pb deposited for time period year.

The ²¹⁰Pb flux from the atmosphere is constant, and the amount stored is calculated from core measurements. The focusing factor corrected PCB flux (FFF_{PCB}) in ng/cm²/year is calculated using:

$$FFF_{PCB} = F_{PCB} * FF_{210Pb} \quad (1.7.6)$$

This flux is then converted to a load to the lake using the depositional and transitional areas of the lake. The depositional area is defined as the area of the lake with water depths greater than 100 m, the transitional area is defined as the areas of the lake with water depths between 40 and 100 m, and the non-depositional area is defined as the area of the lake with water depths less than 40 m (Figure 1.7.3). Together (excluding Green Bay), the transitional and depositional areas of the lake represent 68.6% of the lake's total area of 58,016 km² (Table 1.7.2).

Table 1.7.2. Sedimentary Zones of Lake Michigan

Region of the Lake	Percent of the Lake's Area	Area, km ²
Non-Depositional	24.7	14,334
Transitional	32.8	19,032
Depositional	35.8	20,756
Green Bay	6.7	3,894
Total	100.0	58,016

Flux is converted to load using the equation:

$$L_{PCB} = FFF_{PCB} * (10^{-12} \text{ kg/ng}) * (10^{10} \text{ cm}^2/\text{km}^2) * A_{TD} \quad (1.7.7)$$

where:

L_{PCB} = Total load to lake depositional and transitional areas in kg/year

A_{TD} = Total depositional and transitional area of the lake in km².

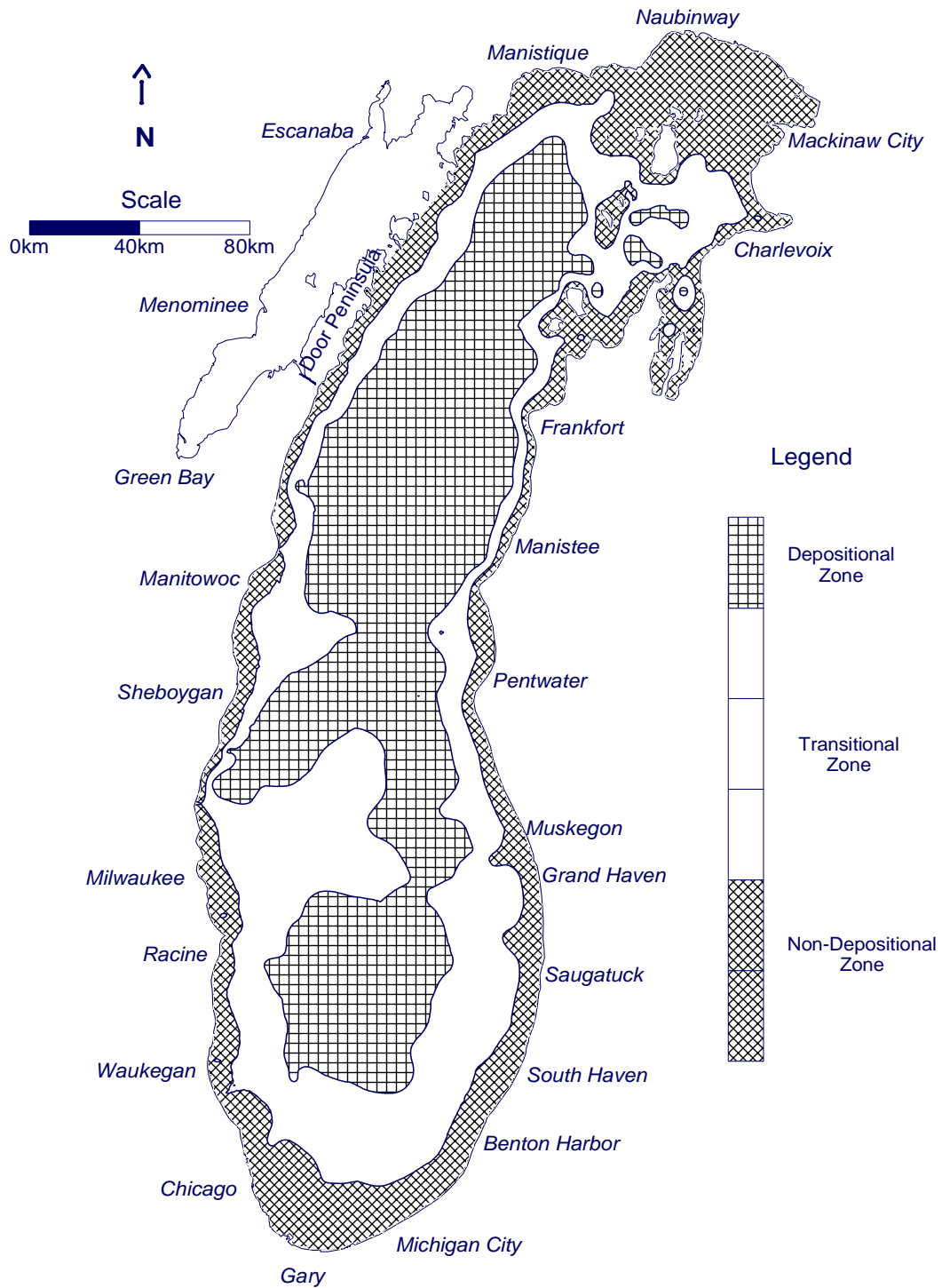

Figure 1.7.3. Lake Michigan non-depositional (0-40 m), transitional (40-100 m), and depositional (> 100 m) zones based on water depth and the depth of wind-wave interaction with sediments.

The remaining terms are unit conversion terms. Loads in the post-peak function were normalized to the 1989 load (2,731 kg/year) because the best linear fit line went through 1989. The result of this function in 1967 of 8,129 kg/year was used to normalize the onset function so that its result in 1967 was also 8,129 kg/year. The resulting load function had a PCB load onset in 1949, a peak load of 8,129 kg/year in 1967, and a 1994 load of 1,504 kg/year (Figure 1.7.4). The 1994 total load was 1.9 times higher than the measured load of 786 kg/year. This was considered within reason because at least one additional loading source was identified since the project. The source is Milwaukee, Wisconsin with an estimated load of 130 kg/year (Wethington and Hornbuckle, 2005). In addition, atmospheric loads did not include the coarse particulate fraction which would contribute an additional load. Franz *et al.* (1998) estimated a particle dry deposition flux of 1,100 kg/year which was considerably higher than previously reported dry deposition fluxes of 16 to 170 kg/year. For the LMMBP, the average particulate PCB flux reported was 120 ng/m²/month (Miller *et al.*, 2001). This converts to roughly 85 kg/year for the whole lake. Thus the coarse particulate load could be as high as 1,000 kg/year. Therefore, using a load function that results in a 1994 load of 1,504 kg/year seems quite plausible given the uncertainties in the dry deposition fluxes. Finally, it is suspected that other loads, similar to the Milwaukee load,

were undetected due to the lack of sampling stations in all metropolitan areas.

1.7.4 Estimated PCB Storage

To provide an estimate of the PCBs stored in Lake Michigan sediment, the three LMMBP core PCB results were manipulated in the same way as described above. This included the application of ²¹⁰Pb focusing factors to each core so that storage in the entire lake could be estimated. Cores 15, 61, and 86 yielded a lake-wide storage of 209,239, 64,533, and 41,192 kg, respectively. The mean of these is 104,988 kg. This is higher than the 75,000 kg reported by Golden *et al.* (1993). As seen from the three LMMBP cores, storage results are highly variable and location dependent. Application of the above procedure used for estimating storage in the lake's sediments to cores reported in the literature (Golden *et al.*, 1993; Hermanson *et al.*, 1991; Schneider *et al.*, 2001), the mean storage in the main lake is estimated to be 46,466 kg. This is comparable to more recent work by Brian J. Eadie and Patricia Van Hoof (NOAA, Great Lakes Environmental Research Laboratory, Ann Arbor, Michigan, personal communication) based on the LMMBP data which has yielded an estimate of 40,700 kg for the main lake and 60,000 kg for the main lake plus Green Bay.

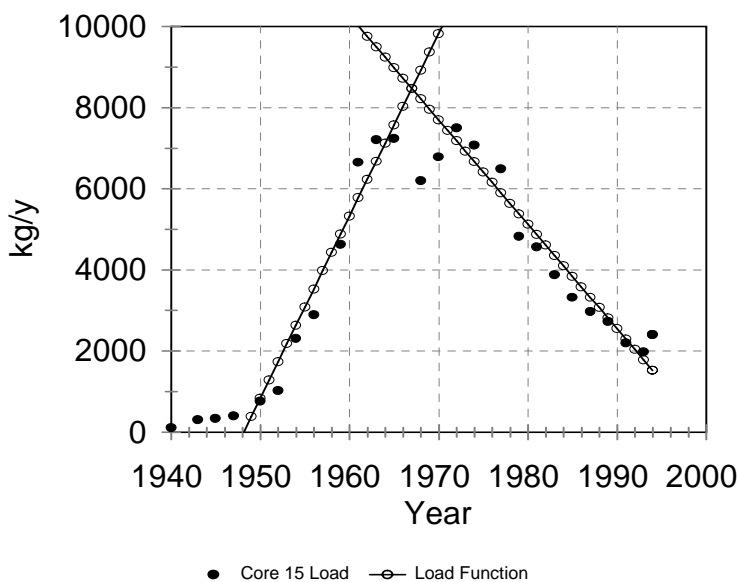

Figure 1.7.4. Comparison of load function to ²¹⁰Pb focusing factor corrected core 15 loads.

References

- Blasland, Bouck, and Lee, Incorporated. 2000. Allied Paper, Incorporated/Portage Creek/Kalamazoo River Superfund Site Remedial Investigation/Feasibility Study. Remedial Investigation Report - Phase I. A 10/30/2000 draft for state and federal review.
- Buehler, S.S., I. Basu, and R.A. Hites. 2002. Gas-Phase Polychlorinated Biphenyl and Hexachlorocyclohexane Concentrations Near the Great Lakes: A Historical Perspective. *Environ. Sci. Technol.*, 36(23):5051-5056.
- Buehler, S.S. and R.A. Hites. 2002. The Great Lakes' Integrated Atmospheric Deposition Network. *Environ. Sci. Technol.*, 36(17):354A-359A.
- Buehler, S.S., I. Basu, and R.A. Hites. 2004. Causes of Variability in Pesticide and PCB Concentrations in Air Near the Great Lakes. *Environ. Sci. Technol.*, 38(2):414-422.
- DeVault, D.S., R. Hesselberg, P.W. Rodgers, and T.J. Feist. 1996. Contaminant Trends in Lake Trout and Walleye From the Laurentian Great Lakes. *J. Great Lakes Res.*, 22(4):884-895.
- Eadie, B.J., D.J. Schwab, R.A. Assel, N. Hawley, M.B. Lansing, G.S. Miller, N.R. Morehead, and J.A. Robbins. 1996. Development of Recurrent Coastal Plume in Lake Michigan Observed for the First Time. *EOS, Transaction, American Geophysical Union*, 77:337-338.
- Franz, T.P., S.J. Eisenreich, and T.M. Holsen. 1998. Dry Deposition of Particulate Polychlorinated Biphenyls and Polycyclic Aromatic Hydrocarbons to Lake Michigan. *Environ. Sci. Technol.*, 32(23):3681-3688.
- Golden, K.A., C.S. Wong, J.D. Jeremiason, S.J. Eisenreich, G. Sanders, J. Hallgren, D.L. Swackhamer, D.R. Engstrom, and D.T. Long. 1993. Accumulation and Preliminary Inventory of Organochlorines in Great Lakes Sediments. *Water Sci. Technol.*, 29(8-9):19-31.
- Hermanson, M.H., E.R. Christensen, D.J. Buser, and L. Chen. 1991. Polychlorinated Biphenyls in Dated Sediment Cores From Green Bay and Lake Michigan. *J. Great Lakes Res.*, 17(1):94-108.
- Hillery, B.L., I. Basu, C.W. Sweet, and R.A. Hites. 1997. Temporal and Spatial Trends in a Long-Term Study of Gas-Phase PCB Concentrations Near the Great Lakes. *Environ. Sci. Technol.*, 31(6):1811-1816.
- Hillery, B.L., M.F. Simcik, I. Basu, R.M. Hoff, W.M.J. Strachan, D. Burniston, C.H. Chan, K.A. Brice, C.W. Sweet, and R.A. Hites. 1998. Atmospheric Deposition of Toxic Pollutants to the Great Lakes as Measured by the Integrated Atmospheric Deposition Network. *Environ. Sci. Technol.*, 32(15):2216-2221.
- Limno Tech, Incorporated. 2002. Recent Data Collection Efforts and Trends in Data. A presentation at the Fox River Group Comment Meeting.
- Marti, E.A. and D.E. Armstrong. 1990. Polychlorinated Biphenyls in Lake Michigan Tributaries. *J. Great Lakes Res.*, 16(3):396-405.
- McCarty, H.B.; J. Schofield, K. Miller, R.N. Brent, P. Van Hoof, and B. Eadie. 2004. Results of the Lake Michigan Mass Balance Study: Polychlorinated Biphenyls and *trans*-Nonachlor Data Report. U.S. Environmental Protection Agency, Great Lakes National Program Office, Chicago, Illinois. EPA-905/R/01-011, 289 pp.
- Miller, S.M., M.L. Green, J.V. DePinto, and K.C. Hornbuckle. 2001. Results From the Lake Michigan Mass Balance Study: Concentrations and Fluxes of Atmospheric Polychlorinated Biphenyls and *trans*-Nonachlor. *Environ. Sci. Technol.*, 35(2):278-285.
- Neidermyer, W.J. and J.J. Hickey. 1976. Chronology of Organochlorine Compounds in Lake Michigan Fish, 1929-1966. *Pest. Monit. J.*, 10(3):92-95.

-
- Rossmann, R. and D.N. Edgington. 2000. Mercury in 1987-1990 Green Bay, Lake Michigan Surficial Sediments. *J. Great Lakes Res.*, 26(3):323-339.
- Rossmann, R. 2002. Lake Michigan 1994-1996 Surficial Sediment Mercury. *J. Great Lakes Res.*, 28(1):65-76.
- Schneider, A.R., H.M. Stapleton, J. Cornwell, and J.E. Baker. 2001. Recent Declines in PAH, PCB, and Toxaphene Levels in the Northern Great Lakes as Determined From High Resolution Sediment Cores. *Environ. Sci. Technol.*, 35(19):3809-3815.
- Simcik, M.F., I. Basu, C.W. Sweet, and R.A. Hites. 1999. Temperature Dependence and Temporal Trends of Polychlorinated Biphenyl Congeners in the Great Lakes Atmosphere. *Environ. Sci. Technol.*, 33(12):1991-1995.
- Swackhamer, D.L. and D.E. Armstrong. 1988. Horizontal and Vertical Distribution of PCBs in Southern Lake Michigan Sediments and the Effect of Waukegan Harbor as a Point Source. *J. Great Lakes Res.*, 14(3):277-290.
- Velleux, M.L. and D. Endicott. 1994. Development of a Mass Balance Model for Estimating PCB Export From the Lower Fox River to Green Bay. *J. Great Lakes Res.*, 20(2):416-434.
- Wethington, D.M. and K.C. Hornbuckle. 2005. Milwaukee, WI as a Source of Atmospheric PCBs to Lake Michigan. *Environ. Sci. Technol.*, 39(1):57-63.

PART 2

LM3-EUTRO

James J. Pauer and Katie W. Taunt
Welso Federal Services, LLC
and
Wilson Melendez
Computer Sciences Corporation
Large Lakes Research Station
9311 Groh Road
Grosse Ile, Michigan 48138

Chapter 1. Conclusions (Executive Summary)

LM3-Eutro was developed in conjunction with several other mathematical models as part of the Lake Michigan Mass Balance Project (LMMBP). These models work together to determine contaminant concentrations in Lake Michigan fish predators under present and future conditions.

LM3-Eutro was based on the CE-QUAL-ICM model transport framework (Cercio and Cole, 1995) and used state-of-the-science eutrophication kinetics to simulate the interactions between plankton and nutrients. LM3-Eutro is a high-resolution framework containing 44,042 water column segments. The model is driven by the Princeton Ocean hydrodynamics Model (POM) (Schwab and Beletsky, 1998). A sediment model is under development. Until developed, LM3-Eutro includes user-defined fluxes to simulate sediment-water interactions. The model has 17 state variables, including a single zooplankton class, two phytoplankton classes, and several particulate and dissolved nutrient (including carbon) states.

LM3-Eutro has several advantages over historical Great Lakes models:

- A high-resolution segmentation framework (44,042 cells and 19 sigma layers), enabling a better description of areas such as nearshore and offshore zones, bays, river confluences, and the thermocline.
- Use of POM to simulate water movement is a significant improvement over historical models which traditionally used tracers, chloride, and temperature to estimate diffusive and advective flows.
- The model is carbon-based, which is an improvement over chlorophyll *a* due to high variability of this pigment in phytoplankton.
- The expansion of nutrient variables to include dissolved, labile particulate, and refractory particulate forms allows for more realistic description of phytoplankton-nutrient interactions.

-
- Important improvements were made to the light calculation by using a three-hour rather than 24-hour (one day) average estimate of solar radiation. The 24-hour average approach has been criticized by some scientists.

Another advantage of this modeling effort was the large supporting data set. These data were used to establish atmospheric and tributary loads, estimate initial conditions, perform model calibration and confirmation and, to a lesser extent, assist in estimating a number of kinetic coefficients. Most of the data were collected during eight sampling cruises in 1994-1995 (U.S. Environmental Protection Agency, 1997). Limited data were also collected in 1998 and 2000. The data went through rigorous quality assurance (QA) and quality control (QC) procedures (Richardson *et al.*, 2004). In general, most of the emphasis was placed on the main lake as relatively little field data were collected from Green Bay. Supplemental data were gathered for loads such as shoreline erosion and internal sediment fluxes (Monteith and Sonzogni, 1976; Hall and Robertson, 1998). Most of the kinetic model coefficients were derived from the literature and historical Great Lakes models (e.g., Thomann and Di Toro, 1975; Ambrose *et al.*, 1993).

The model was calibrated on the high-resolution (44,042 cells) Level 3 framework as well as the 41 segment Level 2 framework. The Level 2 calibration enabled us to visually observe known spatial and temporal trends such as the spring diatom bloom and phytoplankton concentration gradients between the epilimnion and hypolimnion. The Level 3 calibration was performed on a whole-lake basis. Model output was compared to field data for different calibration runs using simple statistical parameters such as slope and squares of the correlation coefficient. The 1994-1995 LMMP field data were used to calibrate the model. The final calibration was chosen based on the best Level 3 calibration, but Level 2 output was visually inspected to ensure that expected phytoplankton and nutrients trends were reflected. Overall, the calibrated model fits the data well. We were especially satisfied with how well the model was able to mimic the particulate organic carbon (POC) field data because providing carbon production for use in LM2-Toxic was the most important objective of this modeling effort. The phytoplankton fit was not as good, but could be partly explained by the uncertainty

in using an *in situ* fluorometer (Seabird Instrument) to estimate phytoplankton concentrations and the large natural variation in phytoplankton communities (Clesceri *et al.*, 1998).

Model confirmation was performed by comparing the model to limited total phosphorus data for 1998 and 2000 and to a historical model, MICH1, which was developed and calibrated in the 1970s and modified more recently. All comparisons were done on a whole-lake basis, and LM3-Eutro fits the 1998 and 2000 data well. LM3-Eutro and MICH1 compared surprisingly well, especially given the fact that they are based on very different frameworks, kinetics, and segmentation. Compared to field data and LM3-Eutro predicted, MICH1 underpredicted both total phosphorus concentrations. This was probably due to the fact that MICH1 does not have any phosphorus internal sediment recycle. Lower phosphorus values also caused MICH1 to underpredict chlorophyll *a* concentrations in the lake.

Several model forecast scenarios were performed, and long-term total phosphorus, POC, and phytoplankton predictions were observed. One scenario utilized alternating 1994 and 1995 tributary and atmospheric phosphorus loads for 30 years. The autochthonous solid (primary production carbon) output from this model was used in the contaminant fate and transport polychlorinated biphenyl (PCB) model. The model predicted a steady-state total phosphorus concentration of 4.3 µg/L, a steady-state POC concentration of 0.2 mg/L, and an epilimnetic spring chlorophyll *a* peak of 2.36 µg/L. Steady-state was reached within 28 years. Several load reduction scenarios were performed, and total phosphorus, POC, and chlorophyll *a* concentrations were predicted. The Great Lakes Water Quality Agreement (GLWQA) target total phosphorus load of 5,600 MT was revisited and the impact of increasing the load to this level was predicted for total phosphorus and chlorophyll *a* concentrations in the lake (International Joint Commission, 1978). Under the GLWQA loading levels, total phosphorus concentrations were predicted to reach 7.5 µg/L, and spring epilimnetic chlorophyll *a* peaked at 4.0 µg/L. The model was used to estimate the total phosphorus loading required to reach the International Joint Commission's (IJC) total phosphorus concentration guideline of 7 µg/L (Great Lakes Research Advisory Board, 1978). The model

predicted that an annual load of 5,020 maximum total (or a Total Maximum Daily Load (TMDL) of 14 maximum total/day) would result in the 7 µg/L steady-state total phosphorus concentration and a spring maximum epilimnetic chlorophyll *a* concentration of 3.7 µg/L.

References

- Ambrose, R.B., Jr., T.A. Wool, and J.L. Martin. 1993. The Water Quality Analysis Simulation Program, WASP5; Part A: Model Documentation. U.S. Environmental Protection Agency, Environmental Research Laboratory, Athens, Georgia. 202 pp.
- Cerco, C. and T. Cole. 1995. User's Guide to the CE-QUAL-ICM Three-Dimensional Eutrophication Model. U.S. Army Corps of Engineers, U.S. Army Engineer Waterways Experiment Station, Vicksburg, Mississippi. Technical Report EL-95-15, 2,420 pp.
- Clesceri, L.S., A.E. Greenberg, and A.D. Eaton (Eds.). 1998. Standard Methods for the Examination of Water and Waste Water, 20th Edition. American Public Health Association, American Water Works Association, and Water Environment Federation, Hanover, Maryland. 1,205 pp.
- Great Lakes Research Advisory Board. 1978. Annual Report to the International Joint Commission. International Joint Commission, Windsor, Ontario, Canada. 44 pp.
- Hall, D. and D. Robertson. 1998. Estimation of Contaminant Loading from Monitored and Unmonitored Tributaries to Lake Michigan for the USEPA Lake Michigan Mass Balance Study. Quality Systems and Implementation Plan. Submitted October 23, 1998. U.S. Environmental Protection Agency, Great Lakes National Program Office, Chicago, Illinois. 19 pp.
- International Joint Commission. 1978. Great Lakes Water Quality Agreement of 1978, with Annexes and Terms of Reference, Between the United States and Canada. Signed at Ottawa, November 22, 1978. International Joint Commission, Windsor, Ontario, Canada. 60 pp.
- Monteith, T.J. and W.C. Sonzogni. 1976. U.S. Great Lakes Shoreline Erosion Loadings. Great Lakes Basin Commission, Ann Arbor, Michigan. 223 pp.
- Richardson, W.L., D.D. Endicott, R.G. Kreis, Jr., and K.R. Rygwelski (Eds.). 2004. The Lake Michigan Mass Balance Project Quality Assurance Plan for Mathematical Modeling. Prepared by the Modeling Workgroup. U.S. Environmental Protection Agency, Office of Research and Development, National Health and Environmental Effects Research Laboratory, MED-Duluth, Large Lakes Research Station, Grosse Ile, Michigan. EPA/600/R-04/018, 233 pp.
- Schwab, D.J. and D. Beletsky. 1998. Lake Michigan Mass Balance Study: Hydrodynamic Modeling Project. National Oceanic and Atmospheric Administration, Great Lakes Environmental Research Laboratory, Ann Arbor, Michigan. NOAA Technical Memorandum ERL GLERL-108, 53 pp.
- Thomann, R.V., D.M. Di Toro, R.P. Winfield, and D.J. O'Connor. 1975. Mathematical Modeling of Phytoplankton in Lake Ontario, Part 1 - Model Development and Verification. U.S. Environmental Protection Agency, Office of Research and Development, ERL-Corvallis, Large Lakes Research Station, Grosse Ile, Michigan. EPA/660/3-75/005, 177 pp.
- U.S. Environmental Protection Agency. 1997. Lake Michigan Mass Balance Study (LMMB) Methods Compendium, Volume 1: Sample Collection Techniques. U.S. Environmental Protection Agency, Great Lakes National Program Office, Chicago, Illinois. EPA/905/R-97/012a, 1,440 pp.

PART 2

LM3-EUTRO

Chapter 2. Recommendations

LM3-Eutro captured nutrient and phytoplankton trends in Lake Michigan and fit the project field data relatively well. This built confidence in how well the model will be able to describe the system and predict total phosphorus, phytoplankton, and particulate organic carbon (POC) concentrations under different loading scenarios. However, LM3-Eutro has a number of limitations and there are several improvements that can be made to improve the accuracy and predictive capability of the model.

- Presently the framework does not include a sediment sub-model and instead uses user-defined fluxes. A sediment model is recommended to describe nutrient interactions between the sediment and water column. A sediment submodel, coupled with the present water column model, would provide an integrated framework that conserves mass in both the water and sediments.
- The initial conditions were estimated on the Level 2 segmentation scheme. Because the model is sensitive to the initial conditions, especially over the first few years of predictions, it would be preferable to calculate initial condition on the high-resolution Level 3 segmentation scheme.
- Few laboratory and field measurements were performed to estimate kinetic coefficients. Limited laboratory production experiments were conducted for use in the model. Measurements estimating Lake Michigan specific coefficients, especially the phytoplankton growth coefficients, would improve the reliability of the model.
- Additional field and laboratory data would have benefitted the construction, calibration, and confirmation of the LM3-Eutro model.
- Although the lake was sampled eight times during the 1994-1995 period as part of the Lake Michigan Mass Balance Project (LMMBP), additional field measurements would have allowed this high-resolution model to be better constrained.
- Additional sampling during the spring phytoplankton bloom period would improve our understanding of Lake Michigan phytoplankton dynamics and thus assist in construction and calibration of the model.
- Laboratory chlorophyll *a* measurements, in addition to Seabird fluorescence estimates, should be used for future phytoplankton estimates.
- No zooplankton concentration estimates below the thermocline were available for this study. Hypolimnetic or whole water column zooplankton tows would improve the accuracy of the model.
- Limited soluble reactive phosphorus (SRP) data were collected for this study and most of the results were below the detection limit of 1 µg/L. A more complete SRP data set, using an analytical method with a lower detection limit, would be helpful.

-
- Access to an independent data set(s) to confirm the model would improve the credibility of the model.
 - Relatively few samples were taken in Green Bay during this project. Examination of the Green Bay Mass Balance Project (GBMBP) data set suggests that these data are already “out-of-date” due to improvements in conditions in the bay. A more complete recent data set for Green Bay would improve the model’s ability to describe the bay and, to a lesser extent, benefit the overall mathematical framework.
 - The hydrodynamics for the project year were incomplete. A constant overall lake temperature was assumed for the first three months of 1994 in the Princeton Ocean Model (POM) hydrodynamics calculation. No hydrodynamics exist beyond December 21, 1995. A complete two-year hydrodynamics data set would be useful during model calibration and forecast scenario simulations.
 - Limited sensitivity analyses (not included in this document) have been performed to date. No uncertainty analyses have been performed.

Sensitivity and uncertainty analyses will identify the effect of the many processes and coefficients on the model and indicate how accurate the model predictions are. However, both of these procedures are a major undertaking in a high-resolution model like LM3-Eutro due to the large number of segments and time required to complete a single simulation. Commonly used methods such as Monte Carlo analysis are almost impossible to perform due to the time and disk space requirements for a single simulation (and hundreds, if not thousands, of simulations will probably be necessary). In addition, these methods provide only an estimate of parameter uncertainty and do not address issues such as structure or scenario uncertainty.

- A longer record of hydrodynamics data for Lake Michigan (e.g. 1983-1995) would be useful in running forecast scenarios. This would allow determination of “typical” hydrodynamics data for use in longer model simulations.
- Updated phosphorus loading data (and to a lesser extent nitrogen and silica) would allow for a more accurate estimation of future loading trends used in longer model scenarios.

PART 2

LM3-EUTRO

Chapter 3. Model Description

The LM3-Eutro model offers the current “state-of-the-science” in modeling and is capable of providing the type of spatial information lacking in the MICH1 model (Rodgers and Salisbury, 1981a,b) and many other historical Great Lakes frameworks (Di Toro and Connolly, 1980; Thomann and Di Toro, 1975). The model is based on the standard eutrophication kinetics used in the WASP family of models (Thomann and Di Toro, 1975; Ambrose *et al.*, 1993) as well as the U.S. Army Corps of Engineers’ QUAL models (Cercio and Cole, 1995). Important improvements over earlier Great Lakes models include the high-resolution segmentation and the use of a sophisticated hydrodynamics model (Princeton Ocean Model [POM], Schwab and Beletsky, 1998) to drive the lake’s hydrodynamics. Earlier models used tracers such as chloride or temperature to calibrate water movement and account for the transport within a system. These approaches frequently introduced large uncertainties which are, for the most part, avoided with the implementation of the POM.

2.3.1 Transport Scheme for Lake Michigan

Considerable attention had been paid to correctly simulate water column transport in the Lake Michigan Mass Balance Project (LMMBP). The correct implementation of hydrodynamics flow and dispersion and the simulation of concentration gradients had been identified as key elements of water quality analysis for the Lake Michigan System, and they were given particular emphasis throughout the model development.

The computational transport scheme for the LMMBP consisted of three linked submodels in which the output of one submodel was used as input for another submodel. The models consisted of a hydrodynamics model that simulated three-dimensional velocity and temperature fields in the lake, a wave model, and a particle transport model.

The hydrodynamics model was based on the POM which was adapted to Lake Michigan by David Schwab (Schwab and Beletsky, 1998). This model simulated currents, dispersion coefficients, and water temperature over a 5 km grid. The grid was three-dimensional and consisted of 2,318 horizontal cells and 19 vertical layers that resulted in a total of 44,042 water column segments. This 5 km grid was also used in LM3-Eutro. Tributary inflows, the Chicago River outflow, and the Straits of Mackinac were incorporated into POM by David Schwab as part of the hydrodynamics simulation. The POM output consisted of water temperature, horizontal and vertical dispersion, and horizontal and vertical currents for each segment in the water column. This output was used as input for LM3-Eutro. The 1994-1995 POM simulation assumed a constant uniform water temperature of 2°C for the period January 1 to March 31, 1994, while no hydrodynamics data were available after December 21, 1995. In order to obtain hydrodynamics data for the complete 1994-1995 period (used in model calibration and long-term simulations), the first three months of 1994 were replaced with January to March 1995 data (including temperatures), while the corresponding 1994 data was used for the last 10 days in 1995.

The transport model was fairly complex and was incorporated within LM3-Eutro itself. This transport model was based on the ULTIMATE QUICKEST transport scheme, originally developed by Leonard (1991) and subsequently augmented for use with variable grid sizes by Chapman *et al.* (1997). ULTIMATE QUICKEST was also modified by Chapman *et al.* (1997) to incorporate particle settling velocities into the vertical transport calculation, resulting in a more realistic simulation of settling in Lake Michigan. The resulting transport algorithm has been coded in Fortran and applied to the Chesapeake Bay (CE-QUAL-ICM) model (Cercio and Cole, 1994, 1995). A linkage between POM and LM3-Eutro was developed by Chapman *et al.* (1997). The linkage was essentially a mapping of POM cell numbers with ULTIMATE QUICKEST flow face numbers and the relationship between horizontal and vertical components. The LM3-Eutro model calculation performed numerical integration of spatially varying particle concentrations using quadratic interpolation of the concentration to infer its value at flow faces. It also performed analytic integration over space and time to account for changes in the concentration at the cell wall during each time step. Further details of the dimensional derivation of ULTIMATE QUICKEST transport method can be found in Settles *et al.* (2002).

2.3.2 Sediments

The sediments are leaky sinks of nutrients and carbon in Lake Michigan. Phytoplankton and particulate detrital matter containing carbon, nitrogen, phosphorus, and silica settle to the lake bed and are recycled back to the water column *via* resuspension, diagenesis, and diffusion. The ultimate goal of the eutrophication modeling effort was to develop a coupled water column and sediment transport framework. As a short-term approach, the model code was modified to incorporate user-specified sediment fluxes. Although the framework has the flexibility to specify fluxes for any of the state variables, we only used fluxes of the dissolved nutrients (soluble reactive phosphorus [SRP], ammonia [NH₄], dissolved silica [DSi]) and dissolved organic carbon (DOC). These fluxes, in effect, are loads that are evenly distributed over the bottom sediments. These loads were input into the cells of the lowest water column layer, with each cell

receiving exactly the same load value. The loads were, thus, independent of time and space. It is well documented that the majority of nutrient mass is recycled within the lake on an annual basis (Meyers and Eadie 1993). Using this knowledge, nutrient sediment fluxes were calculated. These values compared favorably to limited published nutrient fluxes (Quigley and Robbins, 1986; Conley, *et al.*, 1988).

2.3.3 Formulation of Eutrophication Equations

Two important features of eutrophication models were the multiple interactions among nutrients, plankton, and sediments and the complexity of the transformation reactions describing the conversions between dissolved and particulate phases. The model simulated two phytoplankton classes, diatoms and “non-diatoms,” a single herbivorous zooplankton class, and several nutrient state variables (Table 2.3.1). In a modeling framework, each interaction was described as a mathematical equation and the challenge was to define a relatively simple expression to approximate complex biochemical processes. Most of the equations formulated and used here were based on the WASP family of models (Thomann and Di Toro, 1975; Ambrose *et al.*, 1993) and the CE-QUAL-ICM model (Cercio and Cole, 1995).

Table 2.3.1. Nutrient State Variables

Nutrient	Dissolved Species	Particulate Organic Species
Phosphorus	Soluble reactive, dissolved organic	Labile, refractory
Nitrogen	Ammonia, nitrate, dissolved organic	Labile, refractory
Silica	Biogenic silica	Unavailable silica
Carbon	Dissolved carbon	Labile, refractory

The complete set of mathematical equations used in this model can be found in Appendix 2.3.1. Here we provide a brief explanation of the changes made in formulating the equations describing algal light

dependence, as this was a significant improvement over previous eutrophication modeling approaches.

The general equation for expressing net phytoplankton production is given below.

Net production = gross production - mortality

$$\frac{dp}{dt} = (k_g - k_d) P - k_{gz} Z \quad (2.3.1)$$

where

P = phytoplankton concentration (mass/volume)

t = time

k_g = phytoplankton growth rate (time⁻¹)

k_d = phytoplankton mortality rate (time⁻¹)

k_{gz} = predation rate (time⁻¹)

Z = zooplankton concentration (mass/volume)

The growth rate can be written as:

$$k_g = k_{gmax} f(N) f(T) f(I) \quad (2.3.2)$$

where

k_{gmax} = optimum growth rate (time⁻¹)

$f(N)$ = nutrient growth dependency

$f(I)$ = light growth dependency

$f(T)$ = temperature growth dependency

A number of equations had been proposed to describe the effect of light intensity on phytoplankton production. Steele's equation (Steele, 1962) is one of the most commonly used expressions, while a light saturation equation (similar to the Monod equation) is also frequently used (Di Toro *et al.*, 1971). We described light dependency in this model according to Steele's equation:

$$f(I) = \frac{I}{I_s} \exp \left[\frac{-I}{I_s} + 1 \right] \quad (2.3.3)$$

where

$f(I)$ = light limitation (fraction between 0 and 1)

I = solar light intensity (energy/time/area)

I_s = saturating light intensity (energy/time/area)

The Beer-Lambert equation was used to estimate the light penetration in the water:

$$I_z = I_o \exp(-k_e z) \quad (2.3.4)$$

where

I_z = the light intensity at depth z (energy/time/area)

I_o = the surface light intensity (energy/time/area)

k_e = light extinction coefficient (1/length)

z = depth (length)

Substituting this equation into the previous equation yields:

$$f(I(z)) = \frac{I_o \exp(-k_e z)}{I_s} \exp \left[\frac{I_o \exp(-k_e z)}{I_s} + 1 \right] \quad (2.3.5)$$

This equation calculates the light limitation at an instantaneous time and at a specific depth. However, for models like ours, light limitation must be estimated in a certain cell (with a given depth range) and over a time period (the time step). Thus, we needed to integrate this equation over time and depth. Di Toro *et al.* (1971) formulated an equation assuming a constant light intensity over the photoperiod. They integrated Steele's equation over a 24-hour period and the total depth of a segment.

$$f(I_a) = \frac{2.718 fd}{k_e \Delta z} [\exp(-\alpha_1) - \exp(-\alpha_0)] \quad (2.3.6)$$

where

$$\alpha_0 = \frac{I_a}{I_s} \exp(-k_e z_1)$$

$$\alpha_1 = \frac{I_a}{I_s} \exp(-k_e z_2)$$

where

fd = the photoperiod

I_a = average light intensity over the photoperiod (energy/time/area)

This approach is still commonly used, although it has been criticized for losing the power to represent midday surface inhibition (Di Toro *et al.*, 1971; Kremer and Nixon, 1978). LM3-Eutro had the luxury of performing variable time averaging from hourly to 12-hour averages and it allowed observation of the differences in time steps. However, if one wanted to estimate the light limitation for less than a day and the average light intensity of that period is known, one can solve Steele's equation as follows (note: it is only integrated over depth, but not over time):

$$f(I_a) = \int_{z_1}^{z_2} \frac{1}{z} \left(\frac{I_a \exp(-k_e z)}{I_s} \exp \left[\frac{-I_a \exp(-k_e z)}{I_s} + I \right] \right) dz \quad (2.3.7)$$

The solution is almost the same as before, without the fraction of daylight in the equation.

$$f(I_a) = \frac{2.718}{k_e \Delta z} [\exp(-\alpha_1) - \exp(-\alpha_0)] \quad (2.3.8)$$

The average light intensity (I_a) can be calculated as follows:

$$I_a = \frac{\int I_0(t) dt}{\int dt} \quad (2.3.9)$$

where

I_0 = measured incident solar radiation (energy/time/area)

t = time

and can, thus, be approximated by

$$I_a = \frac{1}{n} \sum_{i=1}^n I_0(t_n) \quad (2.3.10)$$

where

n = number of discrete time intervals at which I_0 is measured

The ability to estimate light limitation on a three-hour basis (the time interval used in LM3-Eutro) rather than an average daily basis allowed a more accurate portrayal of the environment in which phytoplankton grow. The frequency of light measurements in the LMMBP allowed an important model improvement.

References

- Ambrose, R.B., Jr., T.A. Wool, and J.L. Martin. 1993. The Water Quality Analysis Simulation Program, WASP5: Part A: Model Documentation. U.S. Environmental Protection Agency, Environmental Research Laboratory, Athens, Georgia. 202 pp.
- Cerco, C. and T. Cole. 1994. Three-Dimensional Eutrophication Model of Chesapeake Bay. U.S. Army Corps of Engineers, U.S. Army Engineer Waterways Experiment Station, Vicksburg, Mississippi. Technical Report EL-94-4, 658 pp.
- Cerco, C. and T. Cole. 1995. User's Guide to the CE-QUAL-ICM Three-Dimensional Eutrophication Model. U.S. Army Corps of Engineers, U.S. Army Engineer Waterways Experiment Station, Vicksburg, Mississippi. Technical Report EL-95-15, 2,420 pp.

-
- Chapman, R.S., T.M. Cole, and T.K. Gerald. 1997. Development of Hydrodynamic/Water Quality (POM-IPXMT) Linkage for the Lake Michigan Mass Balance Project. Final Report. U.S. Environmental Protection Agency, Office of Research and Development, ERL-Duluth, Large Lakes Research Station, Grosse Ile, Michigan. 63 pp.
- Conley, D.J., M.A. Quigley, and C.L. Schelske. 1988. Silica and Phosphorus Flux From Sediments: Importance of Internal Recycling in Lake Michigan. *Canadian J. Fish. Aquat. Sci.*, 45(6):1030-1035.
- Di Toro, D.M., D.J. O'Connor, and R.V. Thomann. 1971. A Dynamic Model of the Phytoplankton Population in the Sacramento-San Joaquin Delta. *Adv. Chem.*, 106:131-180.
- Di Toro, D.M. and J.P. Connolly. 1980. Mathematical Models of Water Quality in Large Lakes. Part 2: Lake Erie. U.S. Environmental Protection Agency, Office of Research and Development, ERL-Duluth, Large Lakes Research Station, Grosse Ile, Michigan. EPA/600/3-80/065, 97 pp.
- Kremer, J. and S. Nixon. 1978. *A Coastal Marine Ecosystem Simulation and Analysis*. Springer Verlag, New York, New York. 210 pp.
- Leonard, B. 1991. The ULTIMATE Conservative Difference Scheme Applied to Unsteady One-Dimensional Advection. *Comp. Methods Appl. Mechan. Engin.*, 88(1):17-74.
- Meyers, P.A. and B.J. Eadie. 1993. Sources, Degradation and Recycling of Organic Matter Associated with Sinking Particles in Lake Michigan. *Org. Geochem.*, 20:47-56.
- Quigley, M.A. and J.A. Robbins. 1986. Phosphorus Release Processes in Nearshore Southern Lake Michigan. *Canadian J. Fish. Aquat. Sci.*, 43(6):1201-1207.
- Rodgers, P.W. and D. Salisbury. 1981a. Modeling of Water Quality in Lake Michigan and the Effect of the Anomalous Ice Cover of 1976-1977. Great Lakes Environmental Planning Study, Great Lakes Basin Commission, Ann Arbor, Michigan. Contribution Number 44, 53 pp.
- Rodgers, P.W. and D. Salisbury. 1981b. Water Quality Modeling of Lake Michigan and Consideration of the Anomalous Ice Cover of 1976-1977. *J. Great Lakes Res.*, 7(4):467-480.
- Schwab, D.J. and D. Beletsky. 1998. Lake Michigan Mass Balance Study: Hydrodynamic Modeling Project. National Oceanic and Atmospheric Administration, Great Lakes Environmental Research Laboratory, Ann Arbor, Michigan. NOAA Technical Memorandum ERL GLERL-108, 53 pp.
- Settles, M., W. Melendez, and J. Pauer. 2002. LM3: The Lake Michigan Mass Balance Model. Internal Report. U.S. Environmental Protection Agency, Office of Research and Development, National Health and Environmental Effects Research Laboratory, MED-Duluth, Large Lakes Research Station, Grosse Ile, Michigan. 203 pp.
- Steele, J.H. 1962. Environmental Control of Photosynthesis in the Sea. *Limnol. Oceanogr.*, 7:137-150.
- Thomann, R.V., D.M. Di Toro, R.P. Winfield, and D.J. O'Connor. 1975. Mathematical Modeling of Phytoplankton in Lake Ontario, Part 1 - Model Development and Verification. U.S. Environmental Protection Agency, Office of Research and Development, ERL-Corvallis, Large Lakes Research Station, Grosse Ile, Michigan. EPA/660/3-75/005, 177 pp.

PART 2

LM3-EUTRO

Appendix 2.3.1. Development of LM3-Eutro Equations

Important characteristics of eutrophication modeling are the many interactions among nutrients, plankton, and sediments and the transformation reactions describing the conversions between dissolved and particulate phases. In a modeling framework, each interaction is described as a mathematical equation, and the challenge is to define a relatively simple expression to approximate more complex biochemical processes. The model equations used in LM3-Eutro are described here.

A2.3.1 Phytoplankton Growth

Although several phytoplankton groups are present in Lake Michigan, the lake is dominated by diatoms and flagellates. The major differences between these classes are silica dependence by the diatoms, settling rates, carbon content, and growth rates at different times of the year. It has been speculated that diatoms grow faster than “non-diatoms” and that they grow better at cold temperatures because their blooms are usually observed during the spring in the Great Lakes. The kinetic equations used in this model are based on the WASP family of models (Thomann and Di Toro, 1975; Di Toro and Connolly, 1980; Rodgers and Salisbury, 1981a, b) and CEQUAL-ICM, developed by the U.S. Army Corps of Engineers (Cerco and Cole, 1993). These equations do not include settling rates. Settling was included as part of the model transport in the LM3 model framework. The basic phytoplankton growth equation can be written as:

Net Production = Gross Production - Mortality

$$\frac{dP}{dt} = (k_g - k_d) P - k_{gz} Z \quad (\text{A2.3.1.1})$$

where

P = phytoplankton concentration (mass/volume)

t = time

k_g = phytoplankton growth rate (1/time)

k_d = phytoplankton mortality rate (1/time)

k_{gz} = predation rate (1/time)

Z = zooplankton concentration (mass/volume)

The growth rate can be written as:

$$k_g = k_{gmax} f(N) f(T) f(I) \quad (\text{A2.3.1.2})$$

where

k_{gmax} = optimum growth rate (1/time)

$f(N)$ = nutrient growth dependency

$f(I)$ = light growth dependency

$f(T)$ = temperature growth dependency

For the nutrient growth dependency, we used the standard Monod equation, but treated diatoms slightly differently than non-diatoms. Assuming that

a fraction of the dissolved organic phosphorus (DOP) was readily available for algal uptake, available phosphorus, P_{av} , was defined as follows:

$$P_{av} = SRP + f_{DOP} DOP \quad (A2.3.1.3)$$

where

f_{DOP} = fraction of available DOP

DOP = dissolved organic phosphorus concentration (mass/volume)

For the non-diatoms, the Liebig's law of minimum applied with no silica dependency.

$$f(N) = \min \left[\left(\frac{NH_4 + NO_3}{k_{sat-N} + NH_4 + NO_3} \right), \left(\frac{P_{av}}{k_{sat-P} + P_{av}} \right) \right] \quad (A2.3.1.4)$$

where

NH₃ = ammonia concentration (mass/volume)

NO₃ = nitrate concentration (mass/volume)

k_{sat-N} = half-saturation coefficient for nitrogen uptake (mass/volume)

k_{sat-P} = half-saturation coefficient for phosphorus uptake (mass/volume)

The diatoms were described using the product of the silica limitation and the minimum of nitrogen and phosphorus:

$$f(N) = \left(\frac{Si}{k_{sat-Si} + Si} \right) \min \left[\left(\frac{NH_4 + NO_3}{k_{sat-N} + NH_4 + NO_3} \right), \left(\frac{P_{av}}{k_{sat-P} + P_{av}} \right) \right] \quad (A2.3.1.5)$$

where

k_{sat-Si} = half-saturation coefficient for silica uptake

The temperature dependency was expressed using an equation analogous to the Arrhenius temperature correction. Thus:

$$f(T) = \begin{cases} \exp^{-ktg1 (T - T_m)^2} & \text{where } T \leq T_M \\ \exp^{-ktg2 (T_m - T)^2} & \text{where } T > T_M \end{cases} \quad (A2.3.1.6)$$

where

k_{tg1} = temperature effect below optimum temperature (°C)

k_{tg2} = temperature effect above optimum temperature (°C)

T_M = optimum temperature for phytoplankton growth (°C)

T = temperature (°C)

A number of equations had been proposed to describe the effect of light intensity on phytoplankton production. Steele's equation (Steele, 1962) is one of the most commonly used expressions, while a light saturation equation (similar to the Monod equation) is also frequently used (Di Toro *et al.*, 1971). In this model, light dependency is described according to Steele's equation.

$$f(I) = \frac{I}{I_s} \exp \left[\frac{-I}{I_s} + 1 \right] \quad (A2.3.1.7)$$

where

$f(I)$ = light limitation (fraction between 0 and 1)

I = incident solar light intensity (energy/time/area)

I_s = saturating light intensity (energy/time/area)

The Beer-Lambert equation was used to estimate the light penetration in the water:

$$I_z = I_0 \exp(-k_e z) \quad (A2.3.1.8)$$

where

I_z = the light intensity at depth z (energy/time/area)

I_0 = the surface light intensity (energy/time/area)

k_e = light extinction coefficient (1/length)

z = depth (length)

Substituting Equation (A2.3.1.8) into Equation (A2.3.1.7):

$$f(I(z)) = \frac{I_0 \exp(-k_e z)}{I_s} \exp\left[\frac{I_0 \exp(-k_e z)}{I_s} + 1\right] \quad (\text{A2.3.1.9})$$

This equation calculated the light limitation at an instantaneous time and at a specific depth. However, the need to estimate the light limitation at a certain cell (with a given depth range) and over a time period (the time step) was desired. Thus, it was necessary to integrate this equation over time and depth. Di Toro *et al.* (1971) formulated an equation assuming a constant light intensity over photoperiod. They integrated Steele's equation (Equation A2.3.1.9) over a 24-hour period and the total depth of a segment.

$$f(I_a) = \frac{2.718 fd}{k_e \Delta z} [\exp(-\alpha_1) - \exp(-\alpha_0)] \quad (\text{A2.3.1.10})$$

where

$$\alpha_0 = \frac{I_a}{I_s} \exp(-k_e z_1) \quad (\text{A2.3.1.11})$$

$$\alpha_1 = \frac{I_a}{I_s} \exp(-k_e z_2) \quad (\text{A2.3.1.12})$$

and

fd = the photoperiod (time)

I_a = average light intensity over the photoperiod (energy/time/area)

This approach is still very commonly used, although it has been criticized for losing the power to represent midday surface inhibition (Di Toro *et al.*, 1971;

Kremer and Nixon, 1978). In our model, we had the luxury of performing variable time averaging from hourly to 12-hour averages and observing the difference.

However, if one wanted to estimate the light limitation for less than a day and the average light intensity of that period was known, one can solve Steele's equation as follows (note: it is only integrated over depth, but not over time):

$$f(I_a) = \int_{z_1}^{z_2} \frac{1}{z} \left(\frac{I_a \exp(-k_e z)}{I_s} \exp\left[\frac{-I_a \exp(-k_e z)}{I_s} + 1\right] \right) dz \quad (\text{A2.3.1.13})$$

The solution was almost the same as Equation (A2.3.1.10), without the fraction of daylight in the equation.

$$f(I_a) = \frac{2.718}{k_e \Delta z} [\exp(-\alpha_1) - \exp(-\alpha_0)] \quad (\text{A2.3.1.14})$$

The average light intensity (I_a) here can be calculated as follows:

$$I_a = \frac{\int I_0(t) dt}{\int dt} \quad (\text{A2.3.1.15})$$

where

I_0 = measured incident solar radiation (energy/time/area)

t = time

and can, thus, be approximated by:

$$I_a = \frac{1}{n} \sum_{i=1}^n I_0(t_n) \quad (\text{A2.3.1.16})$$

where

n = number of discrete time intervals at which I_0 is measured.

A2.3.2 Zooplankton Kinetics

Zooplankton predation is important in regulating the phytoplankton densities in Lake Michigan, especially during the stratified summer months (Scavia *et al.*, 1988). Lake Michigan zooplankton are dominated by herbivorous species, with copepods making up the majority of the total biomass for most of the year. However, cladocerans exhibit significant peaks in the late summer and fall. Due to the limited zooplankton data reported for the lake and the lack of kinetic laboratory and field studies for Lake Michigan zooplankton populations, we avoided complex zooplankton equations (e.g., Bowie *et al.*, 1985), and chose a relatively simple formulation. The equations describing herbivorous zooplankton growth were based on formulations from the literature (Bowie *et al.*, 1985; Di Toro and Connolly, 1980; Di Toro and Matystik, 1980; Thomann and Mueller, 1987). Carnivorous zooplankton were not directly simulated here, but were represented in a herbivorous zooplankton mortality term.

The following equation was used:

$$\frac{dZ}{dt} = (\varepsilon k_{gz} - k_{dz}) Z \quad (\text{A2.3.1.17})$$

where

Z = zooplankton concentration (mass/volume)

t = time

k_{gz} = growth rate (1/time)

k_{dz} = mortality (1/time)

ε = growth efficiency

$$k_{gz} = k_{gzmax} \left(\frac{P}{k_s + P} \right) \theta^{T - T_{rz}} \quad (\text{A2.3.1.18})$$

where

k_{gzmax} = maximum growth rate (1/time)

P = diatom and greens concentration (mass/volume)

k_s = half-saturation coefficient (mass/volume)

θ = temperature correction factor

T_{rz} = reference temperature ($^{\circ}\text{C}$)

The maximum growth rate is a term that lumps the filtration and assimilation rates into a single term. The mortality term lumps respiration, excretion, and higher predation in a single term. We can, thus, write the overall equation:

$$\frac{dZ}{dt} = \left[\varepsilon k_{gzmax} \frac{P}{k_s + P} \theta^{T - T_{rz}} - k_{dz} \right] Z \quad (\text{A2.3.1.19})$$

A2.3.3 Carbon Interactions

Several carbon interactions were described in the model, including phytoplankton and zooplankton carbon, carbon loads from tributaries, shoreline erosion, and detrital carbon from plankton. The carbon state variables in this model were diatom, non-diatom, and zooplankton carbon; labile detrital carbon; refractory detrital carbon; and dissolved organic carbon (DOC). Carbon dioxide (CO_2) was not simulated, although a mineralization reaction was included. Diatom and non-diatom carbon were simulated, as described in the previous section. Labile detrital carbon referred to the organic detrital carbon from the phytoplankton species which breaks down, as the name implies, relatively rapidly. In contrast, the refractory detrital carbon is the combination of the fraction of the plankton breaking down, as well as other forms of organic carbon in the system, e.g., carbon from tributaries, the sediments, etc. These forms of carbon break down slowly, but are not totally refractory. In the equation, we specify the fractions of labile and refractory carbon. We assumed that phytoplankton utilizes CO_2 as the carbon source during photosynthesis and releases carbon as dissolved (CO_2 and DOC) and particulate (refractory organic carbon [ROC] and labile organic carbon [LOC]) forms.

Phytoplankton Mortality and Decay

Phytoplankton respiration and non-predatory mortality were grouped together in the model as a "mortality" term. The release of carbon as CO_2 from these processes was split into different fractions of DOC and POC.

$$\frac{dDOC}{dt} = f_{cdm} k_d P \quad (A2.3.1.20)$$

where

f_{cdm} = fraction of DOC from mortality

$$\frac{dROC}{dt} = f_{crm} k_d P \quad (A2.3.1.21)$$

where

f_{crm} = fraction of ROC from mortality

$$\frac{dLOC}{dt} = f_{clm} k_d P \quad (A2.3.1.22)$$

where

f_{clm} = fraction of LOC from mortality

However, phytoplankton carbon was also converted to detrital and DOC through predation (messy feeding) and zooplankton-imposed mortality.

$$\frac{dDOC}{dt} = f_{cdp} (1 - \varepsilon) k_{gz} Z \quad (A2.3.1.23)$$

where

f_{cdp} = fraction of DOC from predation

$$\frac{dROC}{dt} = f_{crp} (1 - \varepsilon) k_{gz} Z \quad (A2.3.1.24)$$

where

f_{crp} = fraction of ROC from predation

$$\frac{dLOC}{dt} = f_{clp} (1 - \varepsilon) k_{gz} Z \quad (A2.3.1.25)$$

where

f_{clp} = fraction of LOC from predation

Zooplankton Mortality and Decay

The zooplankton mortality term included respiration, non-predatory mortality, and predation (we did not

simulate any higher predation such as carnivorous zooplankton). We assumed that the detrital zooplankton carbon consisted of dissolved, labile, particulate, and refractory particulate fractions.

$$\frac{dDOC}{dt} = f_{cdz} k_{dz} Z \quad (A2.3.1.26)$$

where

f_{cdz} = fraction of DOC from zooplankton mortality

$$\frac{dLOC}{dt} = f_{clz} k_{dz} Z \quad (A2.3.1.27)$$

where

f_{clz} = fraction of LOC from zooplankton mortality

$$\frac{dROC}{dt} = f_{crz} k_{dz} Z \quad (A2.3.1.28)$$

where

f_{crz} = fraction of ROC from zooplankton mortality

Particulate fractions (both labile and refractory) were hydrolyzed to DOC, while DOC mineralized to CO₂.

Since we did not explicitly model bacteria in this model, their breakdown of carbon was modeled by including a dependency on the phytoplankton, which acted as a surrogate of the heterotrophic bacterial activity in the lake. We also calculated a temperature limitation to the hydrolysis and mineralization. The equations can be written as follows:

$$Tf_{mnl} = \exp [Tk_{mnl} (T - Tr_{mnl})] \quad (A2.3.1.29)$$

$$Tf_{hdr} = \exp [Tk_{hdr} (T - Tr_{hdr})] \quad (A2.3.1.30)$$

where

Tf_{mnl} = temperature correction for mineralization (°C)

Tf_{hdr} = temperature correction for hydrolysis (°C)

Tk_{mnl} = mineralization temperature coefficient (°C⁻¹)

Tk_{hdr} = hydrolysis temperature coefficient (°C⁻¹)

Tr_{mnl} = optimum temperature correction for mineralization (°C)

Tr_{hdr} = optimum temperature correction for hydrolysis (°C)

$$- \frac{dDOC}{dt} = Tf_{mnl} (k_{dc} + k_{dcp}) P DOC \quad (A2.3.1.31)$$

$$- \frac{dROC}{dt} = Tf_{hdr} (k_{rc} + k_{rcp}) P ROC \quad (A2.3.1.32)$$

$$- \frac{dLOC}{dt} = Tf_{hdr} (k_{lc} + k_{lcp}) P LOC \quad (A2.3.1.33)$$

where

k_{dc} = DOC minimum mineralization rate (1/time)

k_{dcp} = DOC mineralization relating to phytoplankton (volume/mass/time)

k_{rc} = ROC minimum hydrolysis rate (1/time)

k_{rcp} = ROC hydrolysis relating to phytoplankton (volume/mass/time)

k_{lc} = LOC minimum hydrolysis rate (time⁻¹)

k_{lcp} = LOC hydrolysis relating to phytoplankton (volume/mass/time)

Examining the last two equations, we calculated that the gain in DOC equaled the sum of the loss of ROC and LOC.

A2.3.4 Phosphorus

In our model, phosphorus existed as one of four species (in addition to being tied up in the phytoplankton). Note that all four forms were in the same oxidation state, thus, no oxidation reactions occurred. The forms were soluble reactive phosphorus (SRP), DOP, and two forms of particulate organic phosphorus (POP) – a labile (LOP) and a refractory (ROP) form. SRP and a small fraction of the DOP were taken up by the phytoplankton during production (photosynthesis). It was released due to mortality and predation.

Particulate phosphorus was hydrolyzed to DOP and DOP to SRP.

Phosphorus Uptake by Phytoplankton

Soluble Reactive Phosphorus Uptake:

$$\frac{dSRP}{dt} = - r_{pc} k_g P \frac{SRP}{SRP + f_{DOP} DOP} \quad (A2.3.1.34)$$

where

r_{pc} = the P:C ratio

Dissolve Organic Phosphorus Uptake:

$$\frac{dDOP}{dt} = - r_{pc} k_g P \frac{f_{DOP} DOP}{f_{DOP} DOP + SRP} \quad (A2.3.1.35)$$

where

r_{pc} = the P:C ratio

An interesting concept, common in many phytoplankton models, is the way in which the nutrients, including phosphorus, are accounted for within the phytoplankton. The model kept track of the carbon and used a constant carbon:nutrient relationship to make these determinations.

Phytoplankton in the water column were hydrolyzed and mineralized to all four phosphorus forms. During algal metabolic/mortality processes, phytoplankton-phosphorus was converted to particulate and dissolved organic forms as well as directly to SRP.

$$\frac{dSRP}{dt} = r_{pc} f_{srp} k_d P \quad (A2.3.1.36)$$

$$\frac{dDOP}{dt} = r_{pc} f_{dop} k_d P \quad (A2.3.1.37)$$

$$\frac{dLOP}{dt} = r_{pc} f_{lop} k_d P \quad (A2.3.1.38)$$

$$\frac{dROP}{dt} = r_{pc} f_{rop} k_d P \quad (A2.3.1.39)$$

where

f_{srp} = fraction SRP from metabolic processes

f_{dop} = fraction DOP from metabolic processes

f_{lop} = fraction of LOP from metabolic processes

f_{rop} = fraction of ROP from metabolic processes

During the phytoplankton predation, zooplankton assimilated only a fraction of the phytoplankton and the remainder of the detrital phytoplankton was released directly to the water. This process is commonly referred to as "messy feeding." The phosphorus was released in both the dissolved and particulate forms.

$$\frac{dSRP}{dt} = f_{pip} (1 - \varepsilon) r_{pc} k_{gz} Z \quad (A2.3.1.40)$$

$$\frac{dDOP}{dt} = f_{pdp} (1 - \varepsilon) r_{pc} k_{gz} Z \quad (A2.3.1.41)$$

$$\frac{dROP}{dt} = f_{prp} (1 - \varepsilon) r_{pc} k_{gz} Z \quad (A2.3.1.42)$$

$$\frac{dLOP}{dt} = f_{plp} (1 - \varepsilon) r_{pc} k_{gz} Z \quad (A2.3.1.43)$$

where

f_{pip} = fraction of SRP from predation

f_{pdp} = fraction of DOP from predation

f_{plp} = fraction of LOP from predation

f_{prp} = fraction of ROP from predation

The model also included equations to describe zooplankton mortality. Phosphorus was released to the water column in both the dissolved and particulate forms.

$$\frac{dSRP}{dt} = f_{plz} r_{pc} k_{dz} Z \quad (A2.3.1.44)$$

$$\frac{dDOP}{dt} = f_{pdz} r_{pc} k_{dz} Z \quad (A2.3.1.45)$$

$$\frac{dLOP}{dt} = f_{plz} r_{pc} k_{dz} Z \quad (A2.3.1.46)$$

$$\frac{dROP}{dt} = f_{prz} r_{pc} k_{dz} Z \quad (A2.3.1.47)$$

where

f_{piz} = fraction of SRP from zooplankton mortality

f_{pdz} = fraction of DOP from zooplankton mortality

f_{plz} = fraction of LOP from zooplankton mortality

f_{prz} = fraction of ROP from zooplankton mortality

Particulate phosphorus was hydrolyzed to DOP and DOP was mineralized back to SRP as follows:

$$- \frac{dDOP}{dt} = k_{dp} + \left(k_{dpa} P \frac{k_{sat-pt}}{SRP + k_{sat-pt}} \right) \quad (A2.3.1.48)$$

$$- \frac{dLOP}{dt} = k_{lp} + \left(k_{lpa} P \frac{k_{sat-pt}}{SRP + k_{sat-pt}} \right) \quad (A2.3.1.49)$$

$$- \frac{dROP}{dt} = k_{rp} + \left(k_{rpa} P \frac{k_{sat-pt}}{SRP + k_{sat-pt}} \right) \quad (A2.3.1.50)$$

where

k_{dp} = DOP mineralization coefficient (1/time)

k_{lp} = LOP hydrolysis coefficient (1/time)

k_{rp} = ROP hydrolysis coefficient (1/time)

k_{dpa} = DOP mineralization coefficient algal dependence (volume/mass/time)

k_{lpa} = LOP hydrolysis coefficient algal dependence (volume/mass/time)

k_{rpa} = ROP hydrolysis coefficient algal dependence (volume/mass/time)

k_{sat-pt} = mean saturation coefficient of algal classes for SRP

A2.3.5 Nitrogen

The transformation of nitrogen was similar to phosphorus, although nitrogen existed in more than one oxidation state. Algal nitrogen was released as two forms of particulate organic nitrogen (labile [LON], refractory [RON]), dissolved organic nitrogen (DON), and ammonia (NH_4). Particulate forms were hydrolyzed to DON. DON was further mineralized to NH_4 and NH_4 is oxidized to nitrate (NO_3).

In our model, we assumed that phytoplankton had no preference between NH_4 and NO_3 as a nitrogen source.

$$\frac{dDIN}{dt} = -r_{nc} k_g P \quad (\text{A2.3.1.51})$$

where

$$DIN = \text{NH}_4 + \text{NO}_3$$

$$r_{nc} = \text{N:C ratio}$$

Because we assumed no preference, then

$$\frac{d\text{NH}_4}{dt} = -\left[\frac{\text{NH}_4}{DIN}\right] r_{nc} k_g P \quad (\text{A2.3.1.52})$$

$$\frac{d\text{NO}_3}{dt} = -\left[\frac{\text{NO}_3}{DIN}\right] r_{nc} k_g P \quad (\text{A2.3.1.53})$$

Similar to phosphorus, nitrogen bound to phytoplankton can be released as particulate organic, dissolved organic and NH_4 forms.

$$\frac{d\text{NH}_4}{dt} = r_{nc} f_{din} k_d P \quad (\text{A2.3.1.54})$$

$$\frac{dDON}{dt} = r_{nc} f_{don} k_d P \quad (\text{A2.3.1.55})$$

$$\frac{dLON}{dt} = r_{nc} f_{lon} k_d P \quad (\text{A2.3.1.56})$$

$$\frac{dRON}{dt} = r_{nc} f_{ron} k_d P \quad (\text{A2.3.1.57})$$

where

$$f_{din} = \text{fraction } \text{NH}_4 \text{ from metabolic processes}$$

$$f_{don} = \text{fraction DON from metabolic processes}$$

$$f_{lon} = \text{fraction LON from metabolic processes}$$

$$f_{ron} = \text{fraction RON from metabolic processes}$$

As described for carbon and phosphorus, the nitrogen balance was affected by the zooplankton through “messy feeding” and zooplankton mortality.

$$\frac{d\text{NH}_4}{dt} = f_{nlp} (1 - \epsilon) r_{nc} k_{gz} Z \quad (\text{A2.3.1.58})$$

$$\frac{dDON}{dt} = f_{ndp} (1 - \epsilon) r_{nc} k_{gz} Z \quad (\text{A2.3.1.59})$$

$$\frac{dLON}{dt} = f_{nlp} (1 - \epsilon) r_{nc} k_{gz} Z \quad (\text{A2.3.1.60})$$

$$\frac{dRON}{dt} = f_{nrp} (1 - \epsilon) r_{nc} k_{gz} Z \quad (\text{A2.3.1.61})$$

where

$$f_{nlp} = \text{fraction of } \text{NH}_4 \text{ from predation}$$

$$f_{ndp} = \text{fraction of DON from predation}$$

$$f_{nlp} = \text{fraction of LON from predation}$$

$$f_{nrp} = \text{fraction of RON from predation}$$

The release of nitrogen during zooplankton mortality can be expressed similarly to the phosphorus.

$$\frac{d\text{NH}_4}{dt} = f_{niz} r_{nc} k_{dz} Z \quad (\text{A2.3.1.62})$$

$$\frac{dDON}{dt} = f_{ndz} r_{nc} k_{dz} Z \quad (\text{A2.3.1.63})$$

$$\frac{dLON}{dt} = f_{niz} r_{nc} k_{dz} Z \quad (\text{A2.3.1.64})$$

$$\frac{dRON}{dt} = f_{nrz} r_{nc} k_{dz} Z \quad (\text{A2.3.1.65})$$

where

f_{niz} = fraction of NH_4 from zooplankton mortality

f_{ndz} = fraction of DON from zooplankton mortality

f_{nlz} = fraction of LON from zooplankton mortality

f_{nrz} = fraction of RON from zooplankton mortality

A2.3.6 Silica

The behavior of silica was similar to that of phosphorus and nitrogen. Two silica species, biogenic silica (SU) and available silica (SA), were simulated in the lake. Dissolved silica was utilized by phytoplankton, while both dissolved and biogenic silica were released *via* phytoplankton mortality, predation upon phytoplankton by zooplankton, and zooplankton mortality. The major difference from the other nutrients was that only diatoms had a silica dependency.

The diatom silica consumption can be written as follows:

$$\frac{dSA}{dt} = - r_{sc} k_g P \quad (\text{A2.3.1.66})$$

where

r_{sc} = Si:C ratio

Note that in all the silica equations, the variable phosphorus refers only to the diatom concentration. Like the other nutrients, silica was released *via* diatom mortality.

$$\frac{dSU}{dt} = - r_{sc} k_d P \quad (\text{A2.3.1.67})$$

Both classes of silica could be released *via* zooplankton predation.

$$\frac{dSA}{dt} = - f_{sap} r_{sc} k_{gz} \quad (\text{A2.3.1.68})$$

$$\frac{dSU}{dt} = - f_{sup} r_{sc} k_{gz} \quad (\text{A2.3.1.69})$$

where

f_{sap} = fraction of SA from predation

f_{sup} = fraction of SU from predation

We assumed that no silica accumulated within the zooplankton so there were no terms for silica release from zooplankton mortality.

References

- Bowie, G.L., W.B. Mills, D.B. Porcella, C.L. Campbell, J.R. Pagenkopf, G.L. Rupp, K.M. Johnson, P.W.H. Chan, S.A. Gherini, and C.E. Chamberlin. 1985. Rates, Constants and Kinetic Formulations in Surface Water Quality Modeling, 2nd Edition. U.S. Environmental Protection Agency, Environmental Research Laboratory, Athens, Georgia. EPA/600/3-85/040, 455 pp.
- Cerco, C.F. and T. Cole. 1993. Three-Dimensional Eutrophication Model of Chesapeake Bay. J. Environ. Engin., 119(6):1006-1025.
- Di Toro, D.M., D.J. O'Connor, and R.V. Thomann. 1971. A Dynamic Model of the Phytoplankton Population in the Sacramento-San Joaquin Delta. Adv. Chem., 106:131-180.
- Di Toro, D.M. and J.P. Connolly. 1980. Mathematical Models of Water Quality in Large Lakes. Part 2: Lake Erie. U.S. Environmental Protection Agency, Office of Research and Development, ERL-Duluth, Large Lakes Research Station, Grosse Ile, Michigan. EPA/600/3-80/065, 97 pp.
- Di Toro, D.M. and W.F. Matystik, Jr. 1980. Mathematical Models of Water Quality in Large Lakes. Part 1: Lake Huron and Saginaw Bay. U.S. Environmental Protection Agency, Office of Research and Development, ERL-Duluth, Large Lakes Research Station, Grosse Ile, Michigan. EPA/600/3-80/056, 180 pp.

-
- Kremer, J. and S. Nixon. 1978. *A Coastal Marine Ecosystem Simulation and Analysis*. Springer-Verlag, New York, New York. 210 pp.
- Rodgers, P.W. and D. Salisbury. 1981a. Modeling of Water Quality in Lake Michigan and the Effect of the Anomalous Ice Cover of 1976-1977. Great Lakes Environmental Planning Study, Great Lakes Basin Commission, Ann Arbor, Michigan. Contribution Number 44, 53 pp.
- Rodgers, P.W. and D. Salisbury. 1981b. Water Quality Modeling of Lake Michigan and Consideration of the Anomalous Ice Cover of 1976-1977. *J. Great Lakes Res.*, 7(4):467-480.
- Scavia, D., G.A. Lang, and J.F. Kitchell. 1988. Dynamics of Lake Michigan Plankton: A Model Evaluation of Nutrient Loading, Competition, and Predation. *Canadian J. Fish. Aquat. Sci.*, 45(1):165-177.
- Steele, J.H. 1962. Environmental Control of Photosynthesis in the Sea. *Limnol. Oceanogr.*, 7:137-150.
- Thomann, R.V., D.M. Di Toro, R.P. Winfield, and D.J. O'Connor. 1975. *Mathematical Modeling of Phytoplankton in Lake Ontario, Part 1 - Model Development and Verification*. U.S. Environmental Protection Agency, Office of Research and Development, ERL-Corvallis, Large Lakes Research Station, Grosse Ile, Michigan. EPA/660/3-75/005, 177 pp.
- Thomann, R.V. and J.A. Mueller. 1987. *Principles of Water Quality Modeling and Control*. Harper and Row Publishers, New York, New York. 644 pp.

PART 2

LM3-EUTRO

Chapter 4. Model Input and Field Data

2.4.1 Loading and Sediment-Water Interactions

2.4.1.1 Atmospheric Loads

Measurements were made at eight locations around Lake Michigan (Miller *et al.*, 2000; U.S. Environmental Protection Agency, 1997) and loads were calculated for total phosphorus, total Kjeldahl nitrogen (TKN), and nitrate (NO₃). Monthly total loads were available for March 1994 through October 1995 (Table 2.4.1). Table 2.4.1 shows the phosphorus loads for this period. In order to obtain a complete two-year record (necessary for model calibration and forecast simulations), January and February of 1994 were assumed to be the same as January and February of 1995, while November and December of 1995 were assumed to be the same as November and December of 1994. The total phosphorus loads were split between labile organic phosphorus (LOP) (67% of total phosphorus) and soluble reactive phosphorus (SRP) (33% of total phosphorus). All other forms were assumed to be insignificant. We assumed that the TKN atmospheric loading is split evenly between labile organic nitrogen (LON) and refractory organic nitrogen (RON) forms.

2.4.1.2 Tributary Loads

Loads from 11 monitored tributaries were calculated using the stratified Beale ratio estimator model (Hall and Robertson, 1998). Loads from 18 unmonitored tributaries (two of which represented portions of monitored tributaries) were also estimated based on

results from monitored watersheds and individual watershed and flow attributes (Hall and Robertson, Part 7, Appendix 2). Monitored tributaries were sampled at sites as far downstream as possible to provide the most accurate load estimates. Composite samples were prepared from two depths at three points along a cross-sectional transect of the river. Most samples were taken during high flow

Table 2.4.1. 1994-1995 Monthly Atmospheric Total Phosphorus Loads

1994 Atmospheric Total Phosphorus Loads (kg/month)	
March	17552
April	34665
May	27465
June	14429
July	38184
August	38303
September	29908
October	17334
November	32418
December	7937
1995 Atmospheric Total Phosphorus Loads (kg/month)	
January	22748
February	8430
March	17552
April	34665
May	27465
June	14429
July	26457
August	39458
September	18893
October	43254

periods (Hall and Robertson, 1998). Loads provided in the original Great Lakes National Program Office (GLNPO) data set included chlorophyll *a*, dissolved organic carbon (DOC), particulate organic carbon (POC), total phosphorus, SRP, TKN, ammonia-N (NH₄), NO₃, and dissolved silica (DSi). Daily loads were provided in units of kg/d for the period of January 1, 1994 to December 1, 1995. Table 2.4.2 provides a summary of the total phosphorus loads for the 11 monitored tributaries.

Loads provided for each tributary were used to calculate additional parameters of interest. Chlorophyll *a* loads were converted to phytoplankton carbon by assuming a 40:1 carbon-to-chlorophyll ratio. This ratio was chosen to maintain consistency within the model (see Section 2.4.2.2). This carbon value was then converted into diatom carbon and non-diatom carbon by assuming that tributary phytoplankton populations were 75% diatom and 25% non-diatom (Allan, 1995). Labile particulate organic carbon (LOC) and refractory particulate organic carbon (ROC) were estimated by subtracting total algal carbon from POC and multiplying by 0.55 for LOC and 0.45 for ROC. Algal phosphorus was estimated by assuming a phosphorus:carbon ratio of 0.01 (algal carbon multiplied by .01). Organic phosphorus was taken to be total phosphorus minus

the sum of algal phosphorus and SRP. From the estimate of organic phosphorus, dissolved organic phosphorus (DOP) was assumed to be 10% and LOP and refractory organic phosphorus (ROP) were both assumed to be 45%. Algal nitrogen was estimated using a nitrogen:carbon ratio of 0.2 (algal carbon multiplied by 0.2). Organic nitrogen was calculated as TKN minus the sum of algal nitrogen and NH₄. As in the case of phosphorus, dissolved organic nitrogen (DON) was represented by 10% of organic nitrogen, while labile organic nitrogen (LON) and refractory organic nitrogen (RON) were each represented as 45% of organic nitrogen.

2.4.1.3 Shoreline Erosion

Shoreline erosion, mainly along the western shore, contributes significantly to the solids concentration in Lake Michigan. The shoreline erosion estimates were based on the long-term, county-level estimates of Monteith and Sonzogni (1976). David Schwab, National Oceanic and Atmospheric Administration (NOAA), Great Lakes Environmental Research Laboratory (GLERL), Ann Arbor, Michigan, used these estimates to calculate erosion loads of coarse-

Table 2.4.2. Tributary Total Phosphorus Loads (kg/year)

River	1994	1995	Two-Year Average
Menominee	83753	127281	105517
Fox	562865	595991	579428
Sheboygan	28424	21703	25063
Milwaukee	33731	31320	32525
Calumet	44710	39782	42246
St. Joseph	275772	264341	270057
Kalamazoo	176318	137918	157118
Grand	663972	351250	507611
Muskegon	62490	43497	52993
Pere Marquette	34937	26828	30882
Manistique	25966	25367	25667
Total Monitored Tributaries	1992937	1665276	1829107
Total Unmonitored Tributaries	683544	650424	666984
Total	2676481	2315700	2496091

and fine-grained particles (personal communication). Organic carbon makes up a very small fraction of the bluff material (Monteith and Sonzogni, 1976) so we used a carbon fraction of 0.5% for the fine-grain material in estimating the POC erosion loads to the lake. We assume this POC is in the refractory form.

2.4.1.4 Sediment

A brief description of the sediment component of the model was previously provided in the model description section (Part 2, Chapter 3). A summary of the phosphorus fluxes, settled masses, and reported literature values can be found in Table 2.4.3.

Table 2.4.3. Sediment Masses, Fluxes, and Loads

State Variable	Mass Settled (kg/year)	Mass Recycled (kg/year)	Literature Comparison (kg/year)
Phosphorus	7×10^6	4×10^6	$3.6-12 \times 10^{6*}$ $1.1 \times 10^{6**}$

* Quigley and Robbins, 1986.

**Conley *et al.*, 1988.

2.4.2 Field Data

Large amounts of data were collected between April 1994 and October 1995 during eight sampling cruises (Table 2.4.4). Sampling stations were scattered throughout the lake (Figure 2.4.1). The data sets included lake nutrient concentrations; physical measurements such as solar radiation and temperature; and biological data related to phytoplankton, zooplankton, and fish communities in the lake. These data have been used to describe the current state-of-the-lake and to gain a better understanding of the lake as a whole and the processes affecting it. They were also useful in model calibration. Many of the samples collected were analyzed *in situ* or on the ship immediately following collection, while others were carefully preserved and sent out for analysis by several laboratories around the country. Detailed descriptions of sampling techniques and sample analyses used can be found in the Lake Michigan

Table 2.4.4. The LMMBP Sampling Cruises

Cruise Number	Start Date	End Date
Cruise 1	April 24, 1994	May 11, 1994
Cruise 2	June 17, 1994	June 26, 1994
Cruise 3	August 3, 1994	August 26, 1994
Cruise 4	October 14, 1994	November 7, 1994
Cruise 5	January 16, 1995	January 25, 1995
Cruise 6	March 23, 1995	April 18, 1995
Cruise 7	August 3, 1995	August 16, 1995
Cruise 8	September 16, 1995	October 13, 1995

Mass Balance Project (LMMBP) Methods Compendium (U.S. Environmental Protection Agency, 1997).

All LMMBP data were subjected to rigorous water quality assurance (QA) procedures (U.S. Environmental Protection Agency, 2004). Once available to the modelers, data were examined for completeness and content. Any data which seemed suspect (unusually high or low values as compared to historical data, missing values or codes, etc.) were resubmitted to GLNPO for additional examination. Data which appeared reasonable and complete were subjected to a standardized data assessment protocol by individual modelers. This data assessment provided basic statistical information about the data (mean, minimum, maximum, median, standard deviation), identified outliers, and evaluated sample normality. In some cases, data averaging and grouping were necessary before adequate assessment could be performed. Once the data assessment was completed by the modeling team, data were imported into the modeling database and kept unchanged for the rest of the data evaluation, model development, and model validation. Summary statistics for the nutrient data are shown in Table 2.4.5. Due to the limited number of Green Bay samples, the table includes only the open lake statistics.

2.4.2.1 Open Lake Nutrient and Carbon Data

2.4.2.1.1 Total Phosphorus

Total phosphorus represented the sum of all phosphorus species in the sample, including the

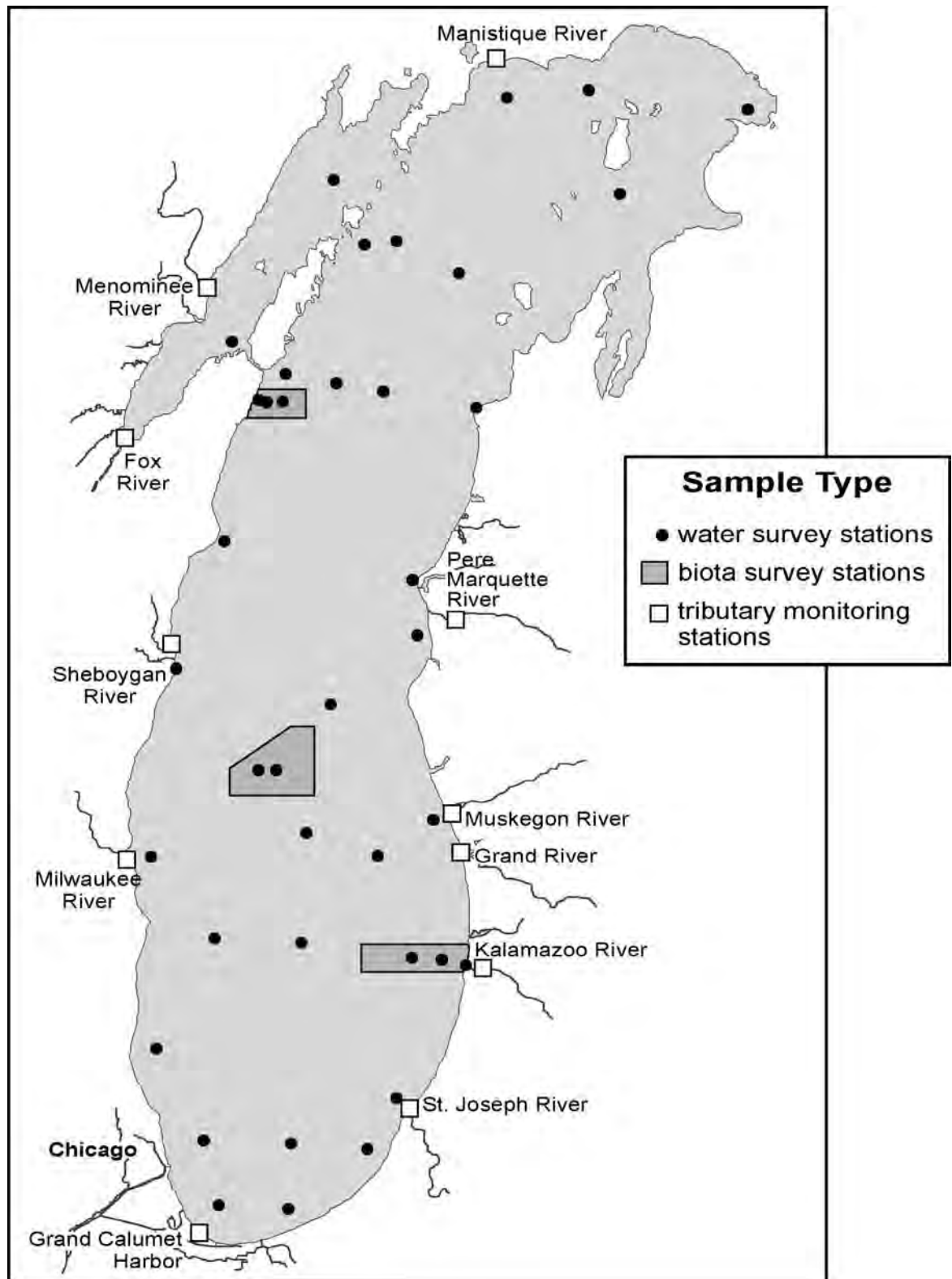

Figure 2.4.1. The LMMBP sampling locations.

Table 2.4.5. The LMMBP Open Lake Nutrient Data Summary Statistics

	Number of Samples	Minimum	Maximum	Median	Mean	Standard Deviation	Outliers*
Nitrate	847	0.01	0.45	0.28	0.27	0.064	None
SRP	504	0.0	6.70	0.60	0.71	0.69	19
Total Phosphorus	846	1.8	28.7	4.6	5.0	2.1	31
DSi	847	0.038	2.11	0.52	0.54	0.29	10
TKN	845	0.01	0.43	0.15	0.16	0.07	10
NH ₄	505	0.0	0.30	0.01	0.02	0.03	13
POC	363	36.15	989.26	201.7	203.0	92.0	6
DOC	364	1.05	2.9	1.54	1.55	0.19	9

Note: POC, SRP, and total phosphorus are expressed in µg/L, all others are in mg/L.

*Larger than twice the standard deviation.

phosphorus dissolved in the water; phosphorus sorbed to particles such as iron, calcium, and magnesium; and the phosphorus contained within the phytoplankton, zooplankton, and detrital particles. Large spatial and temporal changes were not expected in the lake over the project years (1994-1995) because of the conservative nature of total phosphorus. Changes were typically limited to particulate settling and incoming and outgoing loads. It appeared that the LMMBP data verified this, suggesting small, if any, changes in concentration and no apparent nearshore/offshore or north/south trends in the lake. Seasonal trends were observed, with complete mixing early in the year and slightly higher total phosphorus in surface waters during the spring/early summer bloom. Total phosphorus was lower in the surface waters later in the summer, possibly due to settling out of the algal phosphorus. Higher concentrations were observed at the bottom. On a few occasions, unexpectedly high total phosphorus values were observed. These may result from local inputs (tributary) or natural or sediment disturbances during sampling.

2.4.2.1.2 Dissolved Phosphorus

Dissolved phosphorus was defined as the concentration of phosphorus found in a sample after filtration through a membrane filter. SRP, the preferred form of phosphorus used by algae, was some portion of dissolved phosphorus. A general

seasonal concentration trend in dissolved phosphorus was observed on a lake-wide basis. Early in spring, the concentration was relatively low, with values just above 2 µg/L. There was a slight increase in early summer, followed by a decrease in summer to a level frequently below detection limits. Dissolved phosphorus increased in the fall and the pattern repeated for the following year.

2.4.2.1.3 Soluble Reactive Phosphorus

SRP is one of the most important nutrients because it is widely considered to be the driving force for algal primary productivity in Lake Michigan (Tarapchak and Nalewajko, 1987). There has been considerable discussion in the literature about the meaning, measurement, and role of SRP, but most agree that SRP levels can be used to predict algal growth (Tarapchak and Nalewajko, 1987). SRP was not analyzed for samples collected during the first three cruises and the majority of the data from the other five cruises fell below the detection limit of 1 µg/L (U.S. Environmental Protection Agency, 1997). The remarkably good correlation between SRP and dissolved phosphorus, which was previously discussed, was useful in making estimates of SRP for the first two cruises. However, because of the lack of actual SRP data, we did not speculate about trends in the lake. This weakness in this important data set made the analysis and subsequent modeling exercise difficult.

2.4.2.1.4 Nitrate

Nitrate analysis methods actually measure the sum of NO₃ and nitrite (NO₂). Nitrite values were assumed to be low enough to be considered negligible. No obvious nitrate spatial trends were observed (nearshore versus offshore or northern basin versus southern basin), but it appeared that the concentration, on average, was slightly lower in the summer than in the winter. This was probably due to the uptake of dissolved nitrogen during phytoplankton production in the summer.

2.4.2.1.5 Ammonia

Ammonia is the most reduced nitrogen form and is, therefore, the most available for algal uptake. It occurred in the lake at very low concentrations, often below the detection limit of 20 µg N/L. Though the data set was incomplete because no samples for ammonia analysis were taken during the first three sampling cruises, no obvious spatial or temporal trends were observed.

2.4.2.1.6 Total Kjeldahl Nitrogen

TKN is a measure of all of the reduced nitrogen present in the water, including organic nitrogen (particulate and dissolved) and ammonia. No spatial or temporal trends were observed for the TKN values but noticeably higher values were observed throughout the lake during the August 1994 cruise.

2.4.2.1.7 Dissolved Silica

Only the dissolved form of silica (DSi) was measured in this study. A reasonably good representation of the open lake concentration could be constructed. Silica concentrations followed a distinct pattern, with highest observed values occurring uniformly in the lake early in the year. The silica was depleted during the spring and summer by diatom consumption in the epilimnion, while silica increased in the lake's hypolimnion during this part of the year, mainly due to diatom settling and detrital silica (Laird *et al.*, 1988). Toward the end of the summer and early fall, silica, in the strongly stratified epilimnion, decreased to approximately 0.2 mg/L, while it was greater than 1 mg/L in the hypolimnion. This seasonal trend was observed for both project years. No obvious differences could be observed between the Michigan

or Wisconsin shores or between the southern and northern parts of the lake. Epilimnion values tended to be higher during the summer in shallow nearshore sites than in deeper open lake sites.

2.4.2.1.8 Dissolved Organic Carbon

DOC remained remarkably constant in Lake Michigan over the two-year period. We observed few spatial or temporal trends in the lake, although significantly higher and lower concentrations were observed at individual stations in the lake.

2.4.2.1.9 Particulate Organic Carbon

As expected, there was a large variation in POC concentrations in the lake. Typical concentrations for the open lake ranged from 100 to 300 µg/L. In Lake Michigan, POC consisted mainly of phytoplankton carbon, detrital carbon, and to a lesser extent, zooplankton carbon. High POC was strongly related to the timing and locations of phytoplankton blooms. In general, POC was higher in the euphotic zone during the warmer summer months. Early in the spring, POC was higher in the nearshore, probably due to higher temperatures which resulted in early spring phytoplankton production.

2.4.2.1.10 Green Bay Nutrient Data

While Lake Michigan is classified as an oligotrophic system, Green Bay is eutrophic and has drastically different properties than the Lake Michigan proper. Green Bay exhibited much higher concentrations of nutrients and large phytoplankton and zooplankton populations (and, thus, higher carbon concentrations). Most state variables had a concentration gradient, with highest levels (several times higher than the open lake) close to the Fox River mouth and lowest concentrations close to the confluence with the lake. This gradient was especially prominent for phosphorus, phytoplankton, and carbon. During the LMMBP (1994-1995), Green Bay was only sampled in two locations (Figure 2.4.1). This lack of data complicated the estimation of many state variables. Available historical data and scaling of open lake data were used to estimate concentrations in many instances (Bierman *et al.*, 1992; DeStasio and Richman, 1998; Sager and Richman, 1991).

2.4.2.2 Plankton

2.4.2.2.1 Phytoplankton

Data were collected during eight cruises between April 1994 and October 1995. Samples represented composites of 1, 5, 10, and 20 m sub-samples. Data were communicated by group densities and biovolumes (diatoms, “all else” (primarily flagellates), greens, non-nitrogen fixers, and nitrogen-fixers) and species densities and biovolumes. Sampling stations were distributed through the lake (Figure 2.4.1).

Sampled phytoplankton populations differed in overall density and biovolume in 1994 and 1995. Diatoms and “all else” occurred in higher numbers in 1994 than 1995, while greens and blue-greens occurred in similar numbers during both years. This density difference was reflected in the 1994 and 1995 biovolume data. Overall, phytoplankton biovolume was much higher in 1994 as a result of higher diatom and “all else” biovolume. This finding could be the result of sampling which was not evenly divided across the calendar year, with 1994 being spring-weighted and 1995 being fall-weighted.

Blue-green algae (non-nitrogen fixers and nitrogen-fixers categories) dominated the samples in the total number of cells present. Blue-greens were the dominant cell type present in all months. Peak densities of blue-greens occurred in August-October 1994 and August-September 1995. Peak densities of diatoms were observed in May-June 1994 and April-August 1995. “All else” category phytoplankton peaked in number in May-June 1994, again in October-November 1994, and then remained stable throughout the 1995 sampling months.

Diatoms dominated phytoplankton biovolume in April-June 1994 and again in January-August 1995. “All else” phytoplankton dominated total biovolume in October 1994, November 1994, and September 1995. Diatoms and “all else” contributed similarly to total phytoplankton biovolume in August 1994 and October 1995. Green algae and blue-green algae contributed slightly more to total biovolume in August-October 1994 and August-October 1995 but never contributed more than approximately 20% and 15%, respectively. In general, diatoms and “all else” composed >75% of the total phytoplankton biovolume every month, while the blue-greens

contributed approximately 6% of the phytoplankton biomass.

Average sizes for each phytoplankton category further supported the biovolume data. Diatoms averaged 898.6 $\mu\text{m}^3/\text{cell}$, “all else” 574.3 $\mu\text{m}^3/\text{cell}$, greens 374.4 $\mu\text{m}^3/\text{cell}$, non-nitrogen fixers 12.2 $\mu\text{m}^3/\text{cell}$ and nitrogen-fixers 167.7 $\mu\text{m}^3/\text{cell}$. Because total carbon content was expressed as a function of cell biovolume and diatoms and “all else” dominated the total biovolume of the epilimnetic waters, it was safe to assume that the major phytoplankton carbon source would be the diatom and “all else” phytoplankton categories. The blue-greens, although high in numbers, made up an insignificant percentage of phytoplankton carbon mass.

2.4.2.2.2 Chlorophyll a

Chlorophyll a data were provided by GLNPO for the 1994-1995 LMMBP field season. Data were collected using a Seabird fluorometer and calibrated to extracted chlorophyll a data. Due to laboratory error, extracted chlorophyll a data from all cruises except Cruise 8 (September-October 1995) were declared invalid. Thus, Seabird data for the 1994-1995 sampling season were calibrated with fall 1995 and 1997 extracted chlorophyll a data (Goldsmith, 1999). This was accepted as the best alternative, and the chlorophyll a profiles generated from the calibrated data generally agreed with trends and overall concentration levels expected for the lake.

Raw, station-specific chlorophyll a data files contained information such as station code and location, date, time, depth of measurement, chlorophyll a (mg/L), and percent transmissivity. Most chlorophyll a depth profile measurements were taken in 0.1-0.5 m increments, although occasionally only 1 m increments were provided. Some level of “cleaning” was required for all files. All data with depth measurements less than or equal to zero meters were discarded in the analysis, as were data reporting a measurement of -0.18. Both of these values were utilized as data flags by GLNPO. In addition, chlorophyll a data near the surface or bottom were frequently reported as a long-series of identical measurements. The chlorophyll a profile used in the analysis included the last of these “repeats” and its coordinating depth if the repeats occurred at surface depths, or the first of the

“repeats” and coordinating depth if occurring at lake bottom. These repeating values were likely the result of equipment limitations and sampling error (hitting bottom, etc.) and could not be deemed reliable.

2.4.2.2.3 Phytoplankton Carbon

The eutrophication model required phytoplankton to be expressed as carbon and divided into diatom and non-diatom classes. Multiple data transformations were necessary to satisfy these requirements. The determination of which approach should be used to estimate phytoplankton carbon was a complicated first step. The LMMBP data set included phytoplankton biovolume data from 0-20 m integrated samples as well as chlorophyll *a* depth profiles. Biovolume data could be converted to phytoplankton carbon using equations published by Strathmann (1967) and Rocha and Duncan (1985). While this approach is generally accepted in the scientific community, some researchers question whether it is possible to avoid propagating error using this method (Sicko-Goad *et al.*, 1984). In calculating biovolume, organism dimensions are measured and then multiplied to yield cubic volume. Any measurement error is, thus, cubed and then further compounded by inclusion of the erroneous value in the volume-to-carbon equation. The microscopic nature of phytoplankton makes some degree of measurement error inevitable. Another issue was the presence of vacuoles and thick walls in some phytoplankton species. These would be included in a microscopic measurement of an organism as biovolume but contribute relatively little to the carbon content of the organisms (Sicko-Goad *et al.*, 1984). In addition to methodological difficulties, the limitation of phytoplankton biovolume data to integrated samples from the top 20 m of the water column made it difficult to estimate phytoplankton carbon for discrete depths and deeper waters using these data.

Another method of estimating phytoplankton carbon is converting chlorophyll *a* using a carbon-to-chlorophyll *a* ratio. This approach also has shortcomings. Carbon-to-chlorophyll ratios may vary with species and light and nutrient conditions. Some researchers have found that the variation was greatest under nutrient limitation, a common occurrence in Lake Michigan (Riemann *et al.*, 1989). The chlorophyll *a* calibration difficulties encountered during the LMMBP, and discussed earlier, further

complicated the issue, as the chlorophyll *a* data set was not as reliable as desired. The LMMBP chlorophyll *a* data set, however, was quite thorough and any error contained within it as a result of actual measurement or calibration was probably consistent across the entire data set. The chlorophyll *a* data set also lent itself to comparison with the large volume of historical data from Lake Michigan, as well as measurements taken in Green Bay as part of the Green Bay Mass Balance Project (GBMBP) modeling effort (Bierman *et al.*, 1992).

A cruise-by-cruise comparison of biovolume and chlorophyll *a* derived carbon data for the entire lake was made (Figure 2.4.2). Chlorophyll *a* values from the top 20 m of the water column were averaged and converted to carbon using several commonly cited carbon-to-chlorophyll *a* ratios (35:1, 40:1, and 50:1) (Riemann *et al.*, 1989; Montagnes *et al.*, 1994; Cloern *et al.*, 1995). Visual analysis of the results presented in Figure 2.4.2 suggested that a 40:1 carbon-to-chlorophyll ratio provided the best fit with biovolume carbon data over all eight sampling cruises. It was our belief that this chlorophyll *a* carbon estimation approach provided the greatest consistency among integrated 0-20 m samples, deeper water samples, and Green Bay estimates, and it provided the best fit to biovolume carbon estimation methods.

The 40:1 carbon-to-chlorophyll relationship was used to generate carbon values for model fitting exercises. Chlorophyll *a* values for each station and cruise were converted to carbon at each depth along the depth profile, and then separate average carbon values were calculated for the 0-10 m and 11-20 m intervals. Diatom/non-diatom proportions were taken from the corresponding 0-20 m phytoplankton biovolume data and used to divide the total average carbon value into diatom and non-diatom categories. Estimates of phytoplankton carbon deeper in the water column were also calculated from chlorophyll *a* data. Set depths of 25 m and 40 m were chosen, and the total depth between 50 m and the bottom for each station was split into thirds, and the midpoint of each third was used for carbon estimation. When total depth was less than 65 m, a few set depths were used instead (50 m, 60 m, etc.). Occasionally, an additional depth was added to allow better representation of the deep chlorophyll layer. Phytoplankton carbon at these depths was estimated

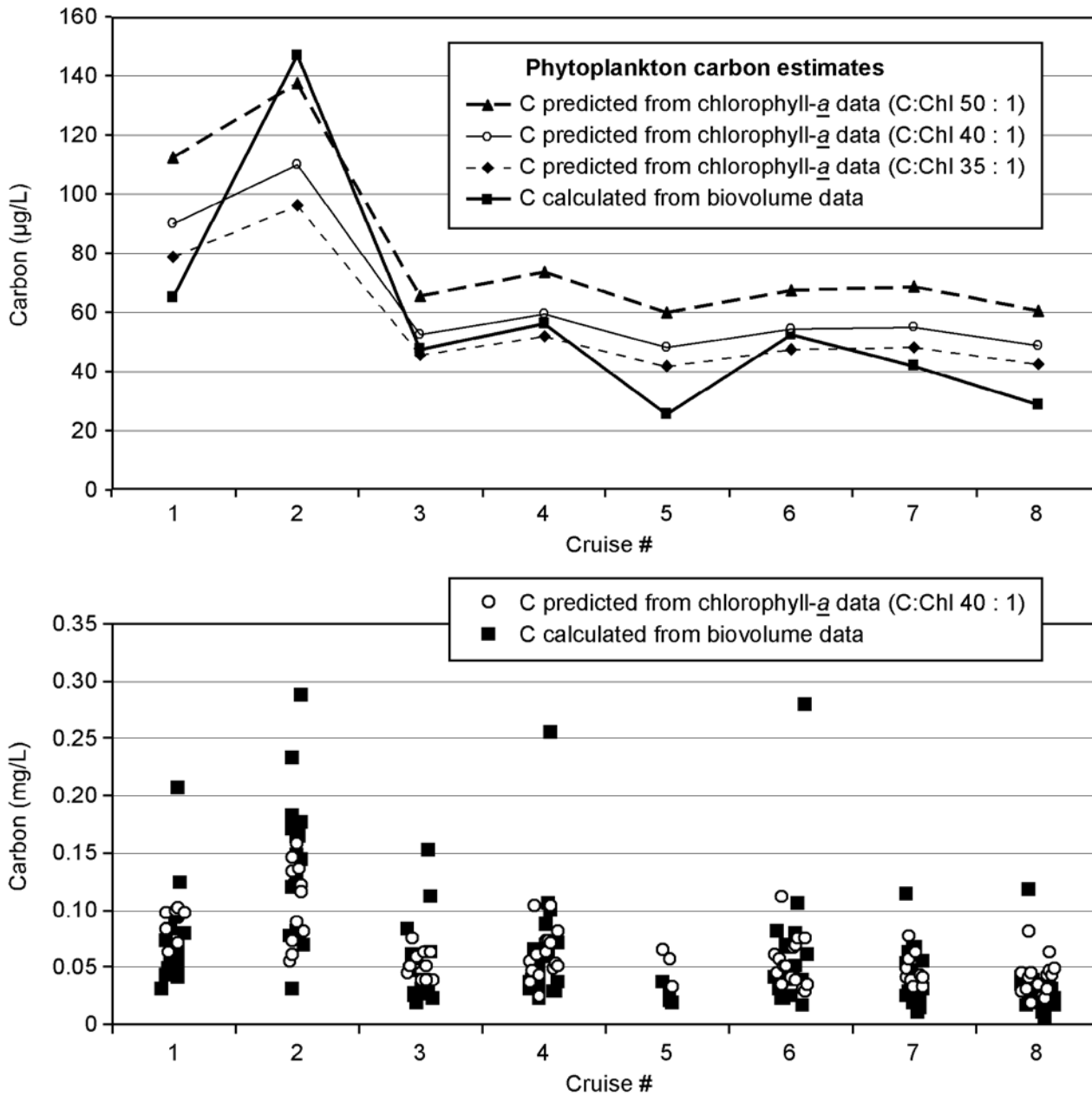

Figure 2.4.2. Lake-wide phytoplankton carbon calculated from biovolume data and carbon-to-chlorophyll a ratios for the eight LMMBP cruises.

by again assuming a carbon:chlorophyll ratio of 40:1. Total carbon was then split into diatom and non-diatom carbon using station- and cruise-specific 0-20 m diatom proportions. Biovolume data were not available for many stations and some station/cruise combinations and cruise average diatom proportions were used in these instances.

2.4.2.2.4 Zooplankton

Zooplankton were collected with plankton net tows from 20 m to the surface. At stations that were less than 20 m in depth, the zooplankton tow was done from 1 m above the bottom to the surface. Data were communicated by group densities and biovolumes (*Bythotrephes*, carnivores, detritivores, *Dreissena* veligers, herbivores, and *Mysis*) and species densities and biovolumes. Sampling stations were distributed throughout the lake.

Zooplankton species level analyses revealed that several species had high average abundances. *Conochilus unicornis*, *Polyarthra vulgaris*, *Polyarthra major*, *Dreissena* veliger, copepod nauplii, *Keratella cochlearis*, *Synchaeta*, *Kellicottia longispina*, and *Diaptomus* copepodites all occurred at average densities greater than 5,000/m³. Of these organisms, only *Dreissena*, copepod nauplii, and *Diaptomus* are not rotifers. Other species were found in virtually all of the samples and were well distributed throughout the lake, regardless of season. These included copepod nauplii, *Cyclops* copepodites, *Diaptomus* copepodites, *Diaptomus minutus*, *Keratella cochlearis*, *Synchaeta*, *Cyclops bicuspidatus*, *Diaptomus ashlandi*, *Kellicottia longispina*, and *Polyarthra vulgaris*.

Zooplankton were further divided into groups by class (rotifer, copepod, and cladocera). As suggested by the species level data, rotifers dominated the overall zooplankton abundance, although copepods were more important in early spring and winter (April-June 1994, January-May 1995). Rotifer abundance peaked in July-August 1994 and July-August 1995 while copepods seemed to peak in August of both years. Cladocerans experienced a brief but significant peak in number in mid-August and September of each year. Total zooplankton abundance peaked at 400,000 organisms/m³ in 1994 and 700,000 organisms/m³ in 1995. This annual difference may be the result of differential

reproductive success between years or the timing of sampling, as discussed for the phytoplankton data.

Copepods overwhelmingly dominated zooplankton biomass throughout most of the year, with peaks from August to mid-October 1994 and August to September 1995. Cladocerans did experience seasonal peaks, however, in which they accounted for most of the zooplankton biomass present in the lake over a very short period of time. These cladoceran biomass peaks coincided with peaks in the *Daphnia galeata* population at the sampling stations. The peaks occurred in mid-August 1994 and early-August 1995, with a smaller peak in October 1995. Rotifer biomass was always quite low despite peaks in abundance and generally high numbers. Overall, total zooplankton biomass peaked in the 225,000 to 275,000 mg/m³ range in August 1994 and August 1995.

In order to better understand the impact of zooplankton on phytoplankton populations, trends of carnivorous species versus herbivorous species were examined. Detritivores and *Dreissena* did account for 10-30% of the total zooplankton abundance during several sampling months, but no biomass data were available for these organisms. Carnivores accounted for less than 25% of the total zooplankton biomass and abundance during all months sampled. Carnivore abundance and biomass, in fact, were relatively static, with only small peaks in each observed in August of 1994 (around 46,000 mg/m³ and 12,000 organisms/m³) and 1995 (around 48,000 mg/m³ and 4,000 organisms/m³). Herbivore abundance increased from April 1994 to August 1994 and then began to decline. The same abundance peak was observed in 1995, but with a slight resurgence in October of 1995. Herbivore biomass increased from April 1994 through August 1994 and slowly declined through December 1994. Herbivore biomass began to increase again in April 1995 and followed a similar pattern to that of 1994 over the rest of 1995. Herbivore abundance peaked at approximately 210,000 organisms/m³ in 1994 and 275,000 organisms/m³ in 1995, while biomass peaked at around 225,000 mg/m³ both years.

Differences in carnivore and herbivore abundance and biomass among sampling stations were analyzed using a one-way ANOVA. No significant differences were found among stations for herbivore abundance

or biomass, but significant differences did exist among stations for carnivore abundance and biomass. Statistical differences in carnivore biomass arose primarily from a difference between Stations 47M and MB19M. Carnivore abundance differed between many stations and Station GB24M. This was not unexpected since GB24M is located in Green Bay rather than the open lake.

2.4.2.2.5 Zooplankton Carbon

LMMBP zooplankton data were provided as dry weight biomasses (mg/m^3). Data corresponding to herbivorous species were extracted from the data set for further analysis. Herbivorous species were selected because their grazing activities directly impacted phytoplankton and were, thus, important to the eutrophication model. Herbivore data were converted to units of g/L and then converted to carbon by assuming that carbon accounted for 50% of the dry weight (Baudouin and Ravera, 1972; Hessen, 1990; Andersen and Hessen, 1991). Carbon data were incorporated into the model with accompanying station and date information. No zooplankton carbon values were estimated for segments below 20 m due to the lack of applicable LMMBP or historical data.

2.4.3 Initial Conditions

The model simulation started in January 1994, but no field data were available until late April 2004. Seasonal changes of the state variables were much larger than changes (increases or decreases) over a one-year period. We, therefore, based our initial conditions for the nutrients, carbon, and plankton on January 1995 (LMMBP Cruise 5) field data. The carbon estimates were derived from the LMMBP chlorophyll *a* data for the 41 segments in the LM2 model. Level 2 segmentation is detailed in Figure 2.4.3. A 40:1 carbon:chlorophyll *a* ratio was assumed and used throughout. Diatom/non-diatom proportions were taken from the 0-20 m phytoplankton biovolume data wherever possible, and the same diatom/non-diatom proportions were maintained throughout the water column. When insufficient phytoplankton biovolume data existed (as was the case for many segments in Cruise 5), a cruise average value (52% diatoms) was used. When no chlorophyll *a* profiles were available for a given segment for Cruise 5, values from neighboring

segments were used. In general, if no values were available for segments 4, 5, and 6, the average of total phytoplankton carbon for segments 1, 2, and 3 were used (diatom/non-diatom carbon proportions were assigned later based on segment specifics). If values were available for segment 6 but 4 and 5 were missing, segment 6 values were assigned to segment 5 and segment 3 values were assigned to segment 4. These estimated surface segment values were then mirrored throughout the water column.

Inadequate Green Bay data existed to follow the previously described approach for assigning initial conditions. After review of the LMMBP chlorophyll *a* profiles available for Green Bay stations, January chlorophyll *a* was estimated to be $1 \mu\text{g}/\text{L}$ for segments 7 and 8, $2 \mu\text{g}/\text{L}$ for segment 9, and $3 \mu\text{g}/\text{L}$ for segment 10. Using Green Bay specific diatom/non-diatom proportions estimated from the literature and a 40:1 carbon-to-chlorophyll ratio, these values were converted to diatom and non-diatom carbon initial conditions (Sager and Richman, 1991; DeStasio and Richman, 1998). Values for deeper segments mirrored the surface values.

Carbon data for zooplankton collected from waters 0-20 m depth in January 1995 (Cruise 5), March 1995, and April 1994 and 1995 (Cruises 1 and 6) were examined in order to estimate initial conditions for the lake. No zooplankton samples existed for several surface segments within the lake and most estimates for these segments follow from estimated values of neighboring segments. Carbon values varied with segment, but, generally, the same value was assigned to the 0-10 m, 10-20 m, and 20-30 m segments within each surface segment sector, and a value of 150% of this 0-10 m carbon value was assigned to the 30-50 m depth segment. The bottom segment (50 m maximum depth) was assigned a carbon value equal to the 0-10 m carbon value.

Many of the non-biological field measured variables did not directly relate to the state variables used in the model. As a result, assumptions were made and calculations were performed to determine the appropriate initial conditions for the modeled state variables. Table 2.4.6 lists the field measurements and modeled state variables for the nutrients and carbon. Specific assumptions and calculations used in estimating these model state variables from field

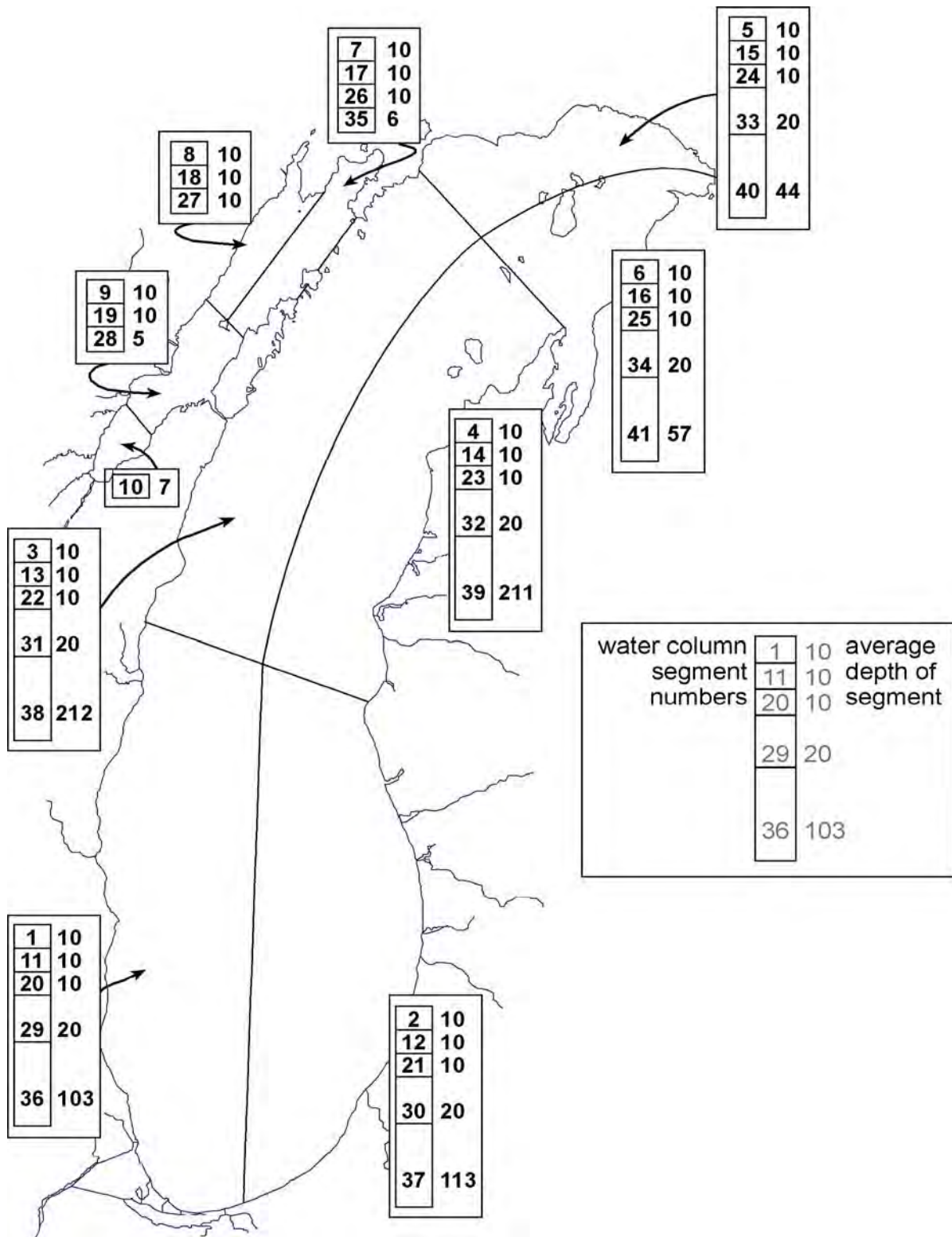

Figure 2.4.3. Level 2 model segmentation for LM3-Eutro.

Table 2.4.6. Relationship of Field Measurements and Model State Variables

Variable	Field Measurements	Model State Variable
Phosphorus	Total Phosphorus Dissolved Phosphorus Soluble Reactive (SRP)	Labile Organic (LOP) Refractory Organic (ROP) Soluble Reactive (SRP) Dissolved Organic (DOP)
Nitrogen	Total Kjeldahl (TKN) Ammonium (NH ₄) Nitrate (NO ₃)	Labile Organic (LON) Refractory (RON) Dissolved Organic (DON) Ammonium (NH ₄) Nitrate (NO ₃)
Silica	Dissolved (DSi)	Dissolved (DSi) Biogenic (BSi)
Carbon	Particulate Organic (POC) Dissolved Organic (DOC)	Labile Organic (LOC) Refractory Organic (ROC) Dissolved Organic (DOC)

measurements can be found in Appendix 2.4.1. It was assumed that the particulate forms for carbon, phosphorus, and nitrogen were split evenly between the labile and refractory forms. It was also assumed that the DON was insignificant.

2.4.4 Parameter Estimation

One of the most challenging tasks in the model development process was the estimation of the different model coefficients. A limitation of this project was the lack of field and laboratory experiments to determine values for the many coefficients. Some physical data were available for model coefficient estimation, and these instances are detailed below. In addition, the use of primary productivity experiments to assist with the estimation of production-related coefficients will be discussed. Values for all other parameters were obtained

initially from the literature, with further refinement *via* calibration.

2.4.4.1 Physical Measurements

2.4.4.1.1 Secchi Disk

Secchi disk measurements were performed during the eight sampling cruises in 1994-1995 to obtain an estimate of water clarity. Cruise averages for all available stations were calculated and are shown in Figure 2.4.4. Secchi disk values were used in an empirical equation (Thomann and Mueller, 1987) to estimate the light extinction coefficients used in the eutrophication model.

2.4.4.1.2 Solar Radiation and Temperature

Primary productivity was strongly affected by both available light (solar radiation) and temperature. As part of the output of the hydrodynamics model (Princeton Ocean Model [POM]) used to generate Lake Michigan hydrodynamic parameters, lake-wide short wave solar radiation and temperature data were generated (Schwab and Beletsky, 1998). Solar radiation was one of the forcing functions driving the phytoplankton growth. In the model, it was referred to as incident solar light intensity (I_0).

2.4.4.2 Primary Production Estimates

The rates at which phytoplankton grow and utilize available nutrients are among the most important and complex processes in any eutrophication model. Primary productivity laboratory experiments were conducted as part of the LMMBP. However, due to the difficulty in converting laboratory production rates into reasonable *in situ* primary production information, the model production rates were generated using coefficients gleaned from published literature and the model calibration process (Table 2.4.7). The laboratory primary production experiments were used to verify the overall production rates in the model (Figure 2.5.2). Laboratory productivity data were provided by GLNPO for the 1994-1995 project field season. The ¹⁴C incubation productivity determination method was utilized. This method calls for the inoculation of water sub-samples with ¹³C radiotracer followed by incubation at varying light intensities for two to four hours. Sub-samples were filtered and radioactivity

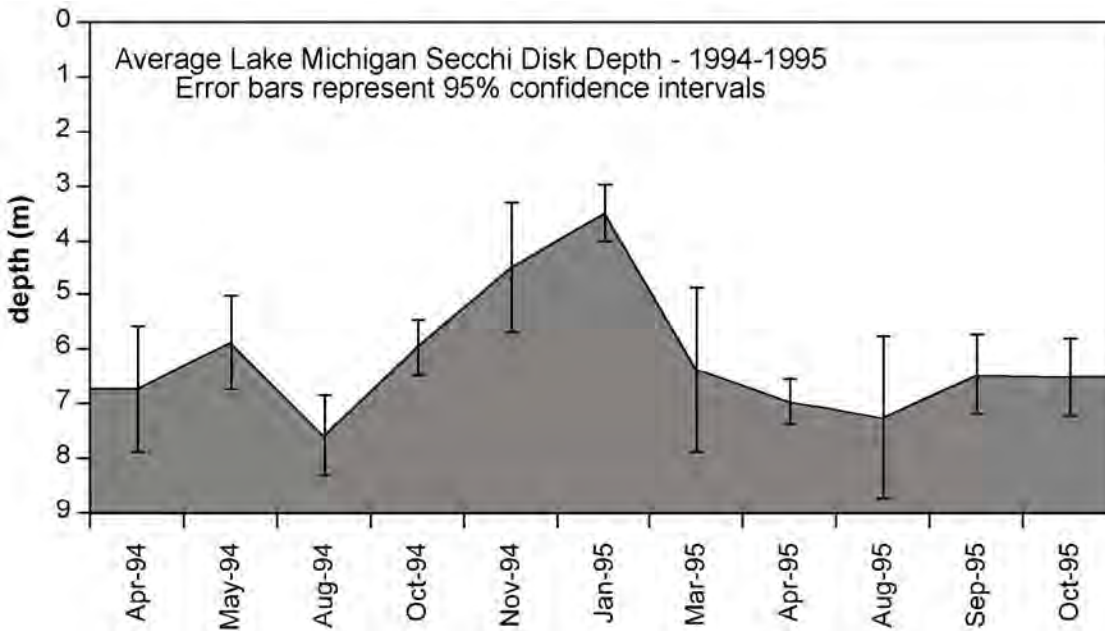

Figure 2.4.4. Lake-wide Secchi depths for the eight LMMBP cruises.

Table 2.4.7. Important LM3 Model Coefficients

Parameter	Unit	Value	Literature Values	Description
CCHLD	No Unit	40	10-100 ^{2,3,4}	Carbon:chlorophyll ratio (diatoms)
CCHLG	No Unit	40	10-100 ¹⁻⁴	Carbon:chlorophyll ratio (non-diatoms)
KHPD	µg/L	0.5	0.5 - 1.0 ^{2,3,4}	Phosphorus half-saturation coefficients for diatoms
KHPG	µg/L	0.5	0.5 - 1.0 ¹⁻⁴	Phosphorus half-saturation coefficients for non-diatoms
KHSD	mg/L	0.03	0.03 - 0.06 ^{2,3,4}	Si half-saturation coefficient for diatoms
PMD	1/day	2.5	0.58 - 8.0 ^{2,3,4}	Diatom growth coefficient
PMG	1/day	2.1	0.58 - 8.0 ¹⁻⁴	Non-diatom growth coefficient
TMD		20	20 ^{2,3,4}	Optimum diatom growth temperature
TMG		20	20 ¹⁻⁴	Optimum non-diatom growth temperature

¹Rodgers and Salisbury, 1981

²Di Toro and Connolly, 1980

³Bowie *et al.*, 1985

⁴Thomann and Di Toro, 1975

of algal cells was measured (U.S. Environmental Protection Agency, 1997). Measured radioactivity should be proportional to the amount of carbon fixed by the algae. Other variables used in calculating the final productivity estimate include light intensity, length of incubation, temperature, and basic information about carbon and chlorophyll levels in the water samples. Variables reported included station code, date, sample depth, temperature, sample identification number, productivity results (mg C/L/h), total incubation time and incubation light level (mE/m²/s). Each station was sampled several times from April 1994 to October 1995, and 12 sub-samples were incubated (at different light intensities) for each station/date/depth combination. Discrete and integrated samples were collected, and efforts were made to include hypolimnetic samples during stratification.

Most of the analysis effort was devoted to determine how productivity changes with light, temperature, phytoplankton carbon, chlorophyll *a*, etc., and to compare these changes with the output of the model equation. Data appeared to follow typical irradiance versus production curves, with production increasing with increasing light levels and then reaching a plateau. Limited light ranges, however, prevented determination of the presence/absence or degree of light inhibition. For purposes of further analysis of laboratory versus model productivity predictions, optimum light levels were designated. For each set of experiments, optimum light was taken to be that light at which maximum production (mgC/L/h) was reported.

There was some degree of uncertainty associated with all estimates of phytoplankton production derived from incubation experiments. It is well-known that results from short experiments (< 6 hours) are frequently higher than those estimated from longer experiments (24 hours). It is generally believed that short-term ¹⁴C incubations measure something between gross and net production (Fahnenstiel and Scavia, 1987). This is a factor which must be considered when comparing laboratory data to predictions from model equations.

References

- Allan, J.D. 1995. Stream Ecology: Structure and Function of Running Waters. Chapman and Hall, London, England. 104 pp.
- Andersen, T. and D.O. Hessen. 1991. Carbon, Nitrogen, and Phosphorus Content of Freshwater Zooplankton. *Limnol. Oceanogr.*, 36(4):807-814.
- Badouin, M.F. and O. Ravera. 1972. Weight, Size and Chemical Composition of Some Freshwater Zooplankters: *Daphnia hyalina* (Leydig). *Limnol. Oceanogr.*, 17(4):645-649.
- Bierman, V.J., Jr., J.V. DePinto, T.C. Young, P.W. Rodgers, S.C. Martin, and R. Raghunathan. 1992. Development and Validation of an Integrated Exposure Model for Toxic Chemicals in Green Bay, Lake Michigan. Final Report. U.S. Environmental Protection Agency, Office of Research and Development, ERL-Duluth, Large Lakes Research Station, Grosse Ile, Michigan. 381 pp.
- Bowie, G.L., W.B. Mills, D.B. Porcella, C.L. Campbell, J.R. Pagenkopf, G.L. Rupp, K.M. Johnson, P.W.H. Chan, S.A. Gherini, and C.E. Chamberlin. 1985. Rates, Constants and Kinetic Formulations in Surface Water Quality Modeling, 2nd Edition. U.S. Environmental Protection Agency, Environmental Research Laboratory, Athens, Georgia. EPA/600/3-85/040, 455 pp.
- Cloern, J.E., C. Grenz, and L. Videgar-Lucas. 1995. An Empirical Model of the Phytoplankton Chlorophyll:Carbon Ratio – The Conversion Factor Between Productivity and Growth Rate. *Limnol. Oceanogr.*, 40(7):1313-1321.
- Conley, D.J., M.A. Quigley, and C.L. Schelske. 1988. Silica and Phosphorus Flux From Sediments: Importance of Internal Recycling in Lake Michigan. *Canadian J. Fish. Aquat. Sci.*, 45(6):1030-1035.

-
- DeStasio, B.T., Jr. and S. Richman. 1998. Phytoplankton Spatial and Temporal Distributions in Green Bay, Michigan, Prior to Colonization by the Zebra Mussel (*Dreissena polymorpha*). *J. Great Lakes Res.*, 24(3):620-628.
- Fahnenstiel, G.L. and D. Scavia. 1987. Dynamics of Lake Michigan Phytoplankton: Primary Production and Growth. *Canadian J. Fish. Aquat. Sci.*, 44(3):499-508.
- Goldsmith, J.C. 1999. Calibration of *In Vivo* Fluorometer Response Measurements With Known Amounts of Extracted Chlorophyll *a*. Internal report and presentation. U.S. Environmental Protection Agency, Great Lakes National Program Office, Chicago, Illinois. April 29, 1999.
- Hall, D. and D. Robertson. 1998. Estimation of Contaminant Loading from Monitored and Unmonitored Tributaries to Lake Michigan for the USEPA Lake Michigan Mass Balance Study. Quality Systems and Implementation Plan. Submitted October 23, 1998. U.S. Environmental Protection Agency, Great Lakes National Program Office, Chicago, Illinois. 19 pp.
- Hessen, D.O. 1990. Carbon, Nitrogen and Phosphorus Status in *Daphnia* at Varying Food Conditions. *J. Plankton Res.*, 12(6):1239-1249.
- Laird, G.A., D. Scavia, G.L. Fahnenstiel, L.A. Strong, and G.A. Lang. 1988. Dynamics of Lake Michigan Phytoplankton: Relationship to Nitrogen and Silica Fluxes. *Canadian J. Fish. Aquat. Sci.*, 45(8):1459-1466.
- Miller, S.M., C.W. Sweet, J.V. DePinto, and K.C. Hornbuckle. 2000. Atrazine and Nutrients in Precipitation: Results from the Lake Michigan Mass Balance Study. *Environ. Sci. Technol.*, 34(1):55-61.
- Montagnes, D.J.S., J.A. Berges, P.J. Harrison, and F.J.R. Taylor. 1994. Estimating Carbon, Nitrogen, Protein, and Chlorophyll *a* From Volume in Marine Phytoplankton. *Limnol. Oceanogr.*, 39(5):1044-1060.
- Monteith, T.J. and W.C. Sonzogni. 1976. U.S. Great Lakes Shoreline Erosion Loadings. Great Lakes Basin Commission, Ann Arbor, Michigan. 223 pp.
- Quigley, M.A. and J.A. Robbins. 1986. Phosphorus Release Processes in Nearshore Southern Lake Michigan. *Canadian J. Fish. Aquat. Sci.*, 43(6):1201-1207.
- Richardson, W.L., D.D. Endicott, R.G. Kreis, Jr., and K.R. Rygwelski (Eds.). 2004. The Lake Michigan Mass Balance Project Quality Assurance Plan for Mathematical Modeling. Prepared by the Modeling Workgroup. U.S. Environmental Protection Agency, Office of Research and Development, National Health and Environmental Effects Research Laboratory, MED-Duluth, Large Lakes Research Station, Grosse Ile, Michigan. EPA/600/R-04/018, 233 pp.
- Riemann, B., P. Simonsen, and L. Stensgaard. 1989. The Carbon and Chlorophyll Content of Phytoplankton From Various Nutrient Regimes. *J. Plankton Res.*, 11(5):1037-1045.
- Rocha, O. and A. Duncan. 1985. The Relationship Between Cell Carbon and Cell Volume in Freshwater Algal Species Used in Zooplanktonic Studies. *J. Plankton Res.*, 7(2):279-294.
- Rodgers, P.W. and D. Salisbury. 1981. Modeling of Water Quality in Lake Michigan and the Effect of the Anomalous Ice Cover of 1976-1977. Great Lakes Environmental Planning Study, Great Lakes Basin Commission, Ann Arbor, Michigan. Contribution Number 44, 53 pp.
- Sager, P.E. and S. Richman. 1991. Functional Interactions of Phytoplankton and Zooplankton Along the Trophic Gradient in Green Bay, Lake Michigan. *Canadian J. Fish. Aquat. Sci.*, 48(1):116-122.
- Schwab, D.J. and D. Beletsky. 1998. Lake Michigan Mass Balance Study: Hydrodynamic Modeling Project. National Oceanic and Atmospheric Administration, Great Lakes Environmental Research Laboratory, Ann Arbor, Michigan. NOAA Technical Memorandum ERL GLERL-108, 53 pp.

-
- Sicko-Goad, L.M., C.L. Schelske, and E.F. Stoermer. 1984. Estimation of Intracellular Carbon and Silica Content of Diatoms From Natural Assemblages Using Morphometric Techniques. *Limnol. Oceanogr.*, 29(6):1170-1178.
- Strathmann, R.R. 1967. Estimating the Organic Carbon Content of Phytoplankton From Cell Volume or Plasma Volume. *Limnol. Oceanogr.*, 12:411-418.
- Tarapchak, S.J. and C. Nalewajko. 1987. A Review: Phosphorus-Plankton Dynamics and Phosphorus Cycling in Aquatic Systems. National Oceanic and Atmospheric Administration, Great Lakes Environmental Research Laboratory, Ann Arbor, Michigan. NOAA Technical Memorandum ERL GLERL-60, 57 pp.
- Thomann, R.V., D.M. Di Toro, R.P. Winfield, and D.J. O'Connor. 1975. Mathematical Modeling of Phytoplankton in Lake Ontario, Part 1 - Model Development and Verification. U.S. Environmental Protection Agency, Office of Research and Development, ERL-Corvallis, Large Lakes Research Station, Grosse Ile, Michigan. EPA/660/3-75/005, 177 pp.
- Thomann, R.V. and J.A. Mueller. 1987. Principles of Water Quality Modeling and Control. Harper and Row Publishers, New York, New York. 644 pp.
- U.S. Environmental Protection Agency. 1997. Lake Michigan Mass Balance Study (LMMB) Methods Compendium, Volume 1: Sample Collection Techniques. U.S. Environmental Protection Agency, Great Lakes National Program Office, Chicago, Illinois. EPA/905/R-97/012a, 1,440 pp.

PART 2

LM3-EUTRO

Appendix 2.4.1. Modeled Versus Measured Variables

Not all model output variables could be directly compared to the field measurements. In order to compare these model variables to the field data, the following calculations were performed:

Total Phosphorus

$$TP = LOP + ROP + DOP + SRP + APCP(DIA + GRE + ZOO) \quad (A2.4.1.1)$$

where

Field measurements (expressed as mass/volume)

TP = total phosphorus

SRP = soluble reactive phosphorus (also a model output variable)

Model output variables (expressed as mass/volume)

LOP = labile particulate organic phosphorus

ROP = refractory particulate organic phosphorus

DOP = dissolved organic phosphorus

DIA = diatoms (expressed as carbon)

GRE = non-diatoms (expressed as carbon)

ZOO = zooplankton (expressed as carbon)

APCP = phosphorus to carbon ratio (a constant value of 0.01)

Dissolved Phosphorus

$$DP = DOP + SRP \quad (A2.4.1.2)$$

where

DP = dissolved phosphorus (expressed as mass/volume)(field measurement)

Total Kjeldahl Nitrogen

$$TKN = LON + RON + DON + NH_3 + ANCP(DIA + GRE + ZOO) \quad (A2.4.1.3)$$

where

Field measurements (expressed as mass/volume)

TKN = total Kjeldahl nitrogen

NH₃ = ammonia (also a model output variable)

Model output variables (expressed as mass/volume)

LON = labile particulate organic nitrogen

RON = refractory particulate organic nitrogen

DON = dissolved organic nitrogen

ANCP = nitrogen-to-carbon ratio (a constant value of 0.25)

Particulate Organic Carbon

$$POC = LOC + ROC + DIA + GRE + ZOO \quad (A2.4.1.4)$$

where

Field measurements (expressed in mass/volume)

POC = particulate organic carbon

Model output variables (expressed as mass/volume)

LOC = labile particulate organic carbon

ROC = refractory particulate organic carbon

Total Algal Carbon

$$Total\ algal\ carbon = DIA + GRE \quad (A2.4.1.5)$$

Total algal carbon was neither a field nor a model variable. It was a summed total of the diatoms and greens (performed for both the field and model output).

PART 2

LM3-EUTRO

Chapter 5. Calibration

2.5.1 Description of Process

After model equations were formulated and coded as a computer program, model calibration was the next step. The goal of calibrating water quality models was to adjust the model coefficients in order to obtain the best possible fit between the model output and the field data. Challenges of calibrating eutrophication models included the many degrees of freedom (independent model coefficients) and the uncertainty of many of these model coefficients. A traditional model calibration approach was used for LM3-Eutro. The model coefficients were initially estimated using values and ranges reported in the literature (see Table 2.4.7) and these parameters were then adjusted to provide the best model fit to the field data. In this study, values for many coefficients were derived from available Lake Michigan and Great Lakes historical data collected by reputable agencies such as the United States Environmental Protection Agency's (USEPA) Great Lakes National Program Office (GLNPO), National Oceanic and Atmospheric Administration's (NOAA) Great Lakes Environmental Research Laboratory (GLERL) and the University of Michigan. Very few field and laboratory experiments were performed to estimate kinetic coefficients for LM3-Eutro. Limited ^{14}C primary production experiments were performed and used in determining phytoplankton growth coefficients. Phytoplankton (diatoms and non-diatoms), particulate organic carbon (POC), total phosphorus, and dissolved silica (DSi) were the most important state variables in model

calibration. However, all variables were evaluated during the calibration process.

The model was calibrated on the Level 3 segmentation framework (Figure 2.5.1). The main calibration emphasis was placed on the main lake due to inadequate Green Bay data. The high-resolution (Level 3) segments were also collapsed to the Level 2 segmentation scheme to provide a visual representation of how well the model reflected the field data in different areas of the lake and captured expected trends, such as spring epilimnetic diatom peaks and nutrient depletion. It was not

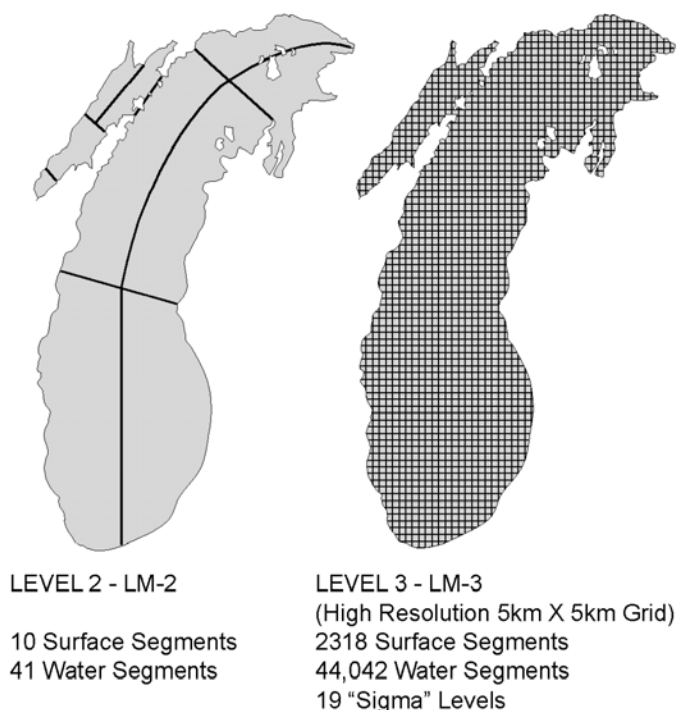

Figure 2.5.1. Level 2 and Level 3 model segmentation.

feasible to visually compare model output versus field data on the Level 3 segmentation framework due to the large number (44,042) of 5 km² cells. Instead, we regressed model output versus field data for each of the 5 km² cells where a field data point was available. This enabled calculation of simple statistical parameters such as square of the correlation coefficient (r^2) and slope and direct comparison of the different model calibration runs.

During the calibration process, small changes to the model initial conditions were made to observe the effect on the model fit. This was done because of the uncertainty of the initial condition estimates and the fact that the initial conditions have a significant influence on the model output.

Data from laboratory primary productivity experiments were used to constrain and confirm values for the growth coefficients that were used in the model. Productivity experiment results; light and temperature parameters; and the Lake Michigan Mass Balance Project (LMMBP) field data were applied to LM3-Eutro productivity equations to generate model production estimates comparable to those generated in the laboratory experiments. Model constants were then adjusted in order to best reflect the primary production trends observed in the laboratory experiments (Figure 2.5.2).

2.5.2 Selection of Best Calibration

After performing several hundred model simulations, we selected our best run based on statistical parameters including square of correlation coefficient (r^2) and slope. The coefficients of the final run were constrained to ensure that all model coefficients fell within reasonable and reported ranges. The best model fit was also evaluated visually on the Level 2 segmentation scheme. Important criteria included the model fit with the overall field data, ability to capture observed and expected phytoplankton peaks, and how well hypolimnetic and epilimnetic nutrient, carbon, and plankton trends and concentrations were predicted. The calibrated final model coefficients are listed in Table 2.5.1. Figure 2.5.3 shows the overall Level 3 fit for phytoplankton, total phosphorus, POC, and DSi. Statistical results are summarized in Table 2.5.2. Figure 2.5.4 shows model versus field data plots for selected Level 2 segments. Selected Level 3 5 km² cells representing

nearshore regions and offshore regions are presented in Figure 2.5.5. Model output for the 5 km² cells was much more dynamic than for the larger Level 2 segments and there were far fewer data points for model fit determination. The model appeared to fit the available data very well in some of the cells and not as well in others. Level 3 model versus data comparisons in individual 5 km² cells were not used in our calibration exercise.

Although we attempted to calibrate all of the state variables, less emphasis was placed on the nitrogen states because Lake Michigan is phosphorus and silica-limited. We also did not perform any comparison of model output with the field data for particulate silica (SU) or soluble reactive phosphorus (SRP), since there was no SU field data and more than 80% of the SRP field data fell below the detection limit. As stated, we did not spend much time calibrating Green Bay because of the limited sampling done in the bay. As a consequence, the final Green Bay calibration was not as good as the rest of the lake. This was especially true for the portion of the bay closest to the Fox River.

With the exception of zooplankton, the final model calibration was reasonably good, and the model was able to fit the field data well and capture important spatial and seasonal trends. A brief discussion of individual calibration results for phytoplankton, POC, total phosphorus, and DSi follows.

2.5.2.1 Phytoplankton

The model somewhat underestimated the field data for phytoplankton. Seabird chlorophyll *a* data were used for all phytoplankton field values. Part of the explanation for the underestimation was poor chlorophyll *a* field data. The Seabird fluorescence instrument, like many *in vivo* fluorescence methods, is notorious for its inaccuracy in measuring chlorophyll *a* (U.S. Environmental Protection Agency, 1997; Clesceri *et al.*, 1998). The square of the correlation coefficient of 0.37 was acceptable, especially given the inherent variation in phytoplankton communities over space and time. Our fit was in-range of other published eutrophication models (Thomann, 1982; Cerco and Cole, 1994). The model was able to capture spatial and temporal trends such as the spring diatom blooms (Figure 2.5.4) and earlier phytoplankton blooms in the

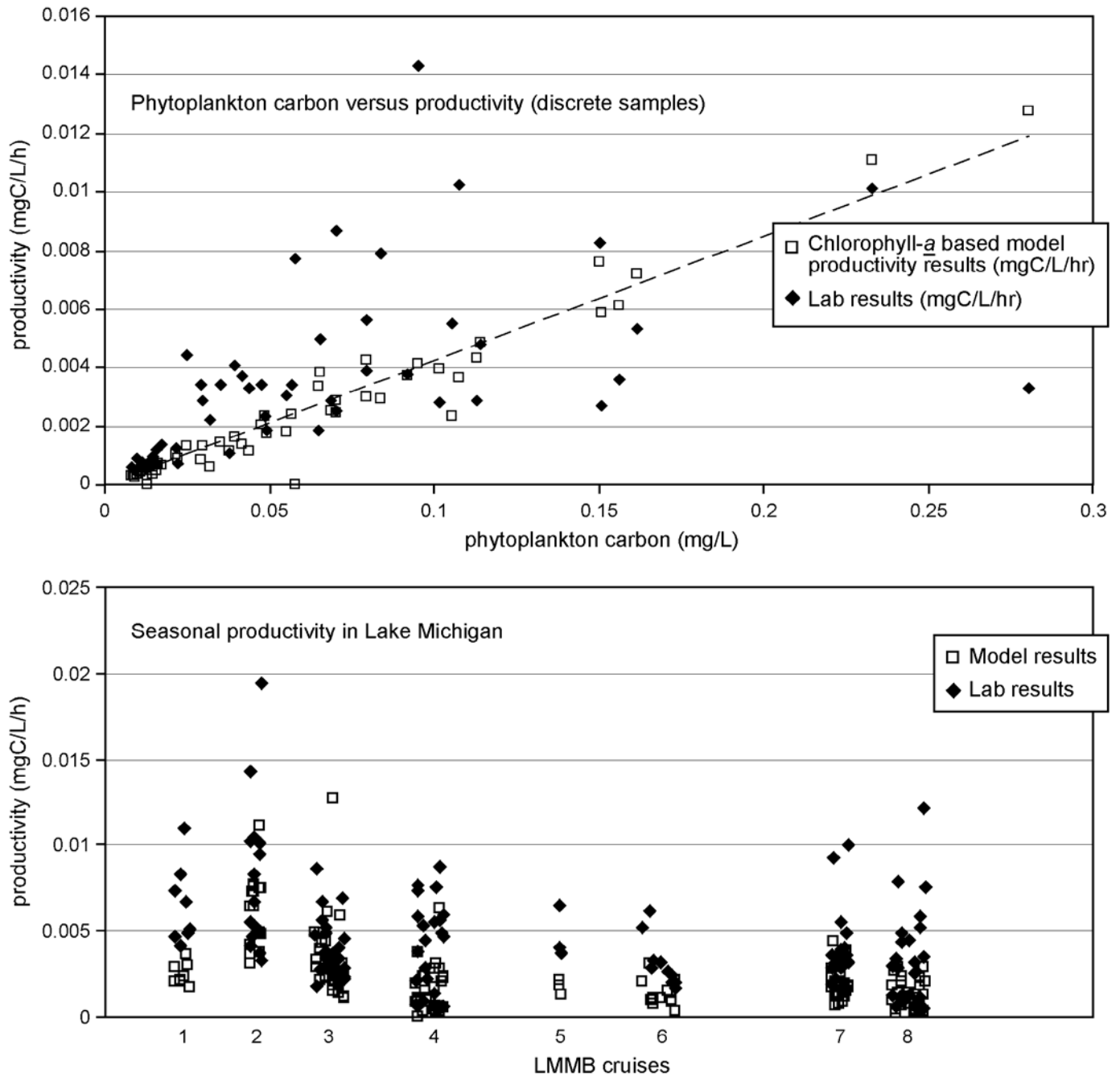

Figure 2.5.2. LM3-Eutro model versus laboratory primary production.

Table 2.5.1. Coefficients Used in the LM3 Model (Units Correspond to Required LM3 Model Output)

Coefficient	Value	Unit	Description
ANCP	0.25		Nitrogen:carbon ratio (mass basis)
APCP	0.01		Phosphorus:carbon ratio (mass basis)
ASCD	2.3		Silica:carbon ratio (mass basis)
BMRD	8.6E-07	1/s	Diatom mortality
BMRG	8.6E-07	1/s	Greens mortality
CCHLD	40		Carbon:chlorophyll ratio (diatoms)
CCHLG	40		Carbon:chlorophyll ratio (greens)
CGZ	3.1E-06	m ³ /kg/s	Zooplankton grazing rate coefficient
FCDD	0.05		Dissolved organic carbon fraction from diatom mortality
FCDG	0.05		Dissolved organic carbon fraction from greens mortality
FCLD	0.3		Labile organic carbon fraction from diatom mortality
FCLG	0.3		Labile organic carbon fraction from greens mortality
FCRD	0.3		Refractory organic carbon fraction from diatom mortality
FCRG	0.3		Refractory organic carbon fraction from greens mortality
FCDP	0.35		Dissolved organic carbon fraction from algal predation
FCDZ	0		Dissolved organic carbon fraction from zooplankton mortality
FCLP	0.5		Labile particulate dissolved carbon fraction from algal predation
FCLZ	0.4		Labile particulate dissolved carbon fraction from zooplankton mortality
FCRP	0.15		Refractory particulate dissolved carbon fraction from algal predation
FCRZ	0.1		Refractory particulate dissolved carbon from zooplankton mortality
FNDD	0.5		Dissolved organic nitrogen from diatom mortality
FNDG	0.5		Dissolved organic nitrogen fraction from greens mortality
FNDP	0		Dissolved organic nitrogen fraction from algal predation
FNDZ	0		Dissolved organic nitrogen fraction from zooplankton mortality
FNID	0.5		Dissolved inorganic nitrogen fraction from diatom mortality
FNIG	0.5		Dissolved inorganic nitrogen fraction from greens mortality
FNIP	0.5		Dissolved inorganic nitrogen fraction from algal predation
FNIZ	0.5		Dissolved inorganic nitrogen fraction from zooplankton mortality
FNLD	0		Labile organic nitrogen fraction from diatom mortality
FNLG	0		Labile organic nitrogen fraction from greens mortality
FNLP	0.4		Labile organic nitrogen fraction from algal predation
FNLZ	0.4		Labile organic nitrogen fraction from zooplankton mortality
FNRD	0		Refractory organic nitrogen fraction from diatom mortality
FNRG	0		Refractory organic nitrogen fraction from greens mortality
RNRP	0.1		Refractory organic nitrogen fraction from algal predation
RNRZ	0.1		Refractory organic nitrogen fraction from zooplankton mortality
FPDD	0.1		Dissolved organic phosphorus fraction from diatom mortality
FPDG	0.1		Dissolved organic phosphorus fraction from greens mortality
FPDP	0.2		Dissolved organic phosphorus fraction from algal predation
FPDZ	0.2		Dissolved organic phosphorus fraction from zooplankton mortality
FPID	0.3		Dissolved inorganic phosphorus fraction from diatom mortality
FPIG	0.3		Dissolved inorganic phosphorus fraction from greens mortality
FPIP	0.5		Dissolved inorganic phosphorus fraction from algal predation
FPLD	0.5		Dissolved inorganic phosphorus fraction from zooplankton mortality
FPLG	0.3		Labile organic phosphorus fraction from greens mortality
FPLP	0.15		Labile organic phosphorus fraction from algal predation
FPLZ	0.15		Labile organic phosphorus fraction from zooplankton mortality
FPRD	0.3		Refractory organic phosphorus fraction from diatom mortality
FPRG	0.3		Refractory organic phosphorus fraction from greens mortality
FPRP	0.15		Refractory organic phosphorus fraction from algal predation
FPRZ	0.15		Refractory organic phosphorus fraction from zooplankton mortality

Table 2.5.1. Coefficients Used in the LM3 Model (Continued)

Coefficient	Value	Units	Description
FSAP	0		Dissolved silica fraction from diatom predation
GREFF	0.6		Zooplankton grazing coefficient
ILUMO	25	W/m ²	Constant illumination (first 90 days)
ISMIN	400	W/m ²	Optimum light illumination
KDC	1.16E-08	1/s	Dissolved organic carbon mineralization coefficient
KDCALG	0.00E+00	m ³ /kg/s	Dissolved organic carbon algal dependency coefficient
KDN	1.74E-07	1/s	Dissolved organic nitrogen mineralization coefficient
KDNALG	0.00E+00	m ³ /kg/s	Dissolved organic nitrogen algal dependency coefficient
KDP	1.16E-09	1/s	Dissolved organic phosphorus mineralization coefficient
KDPALG	6.0E-03	m ³ /kg/s	Dissolved organic phosphorus algal dependency coefficient
KE	0.15	1/m	Background light attenuation
KECHL	1.7E+04	m ² /kg	Light attenuation for chlorophyll a
KHND	2.50E-05	kg/m ³	Nitrogen half-saturation coefficients for diatoms
KHNG	2.50E-05	kg/m ³	Nitrogen half-saturation coefficients for greens
KHNNT	0.0000	kg/m ³	Nitrate half-saturation coefficient for nitrification
KHPD	5.0E-07	kg/m ³	Phosphorus half-saturation coefficients for diatoms
KHPG	5.0E-07	kg/m ³	Phosphorus half-saturation coefficients for greens
KHSD	6.0E-05	kg/m ³	Silica half-saturation coefficients for diatoms
KLC	1.0E-07	1/s	Labile organic carbon hydrolysis coefficient
KLCALG	0.00E+00	m ³ /kg/s	Labile organic carbon algal dependency coefficient
KLN	3.47E-07	1/s	Labile organic carbon hydrolysis coefficient
KLNALG	0.00E+00	m ³ /kg/s	Labile organic nitrogen algal dependency coefficient
KLP	1.00E-09	1/s	Labile organic phosphorus hydrolysis coefficient
KLPALG	6.00E-03	m ³ /kg/s	Labile organic phosphorus algal dependency coefficient
KRC	1.00E--07	1/s	Refractory organic carbon hydrolysis coefficient
KRCALG	0.00E+00	m ³ /kg/s	Refractory organic carbon algal dependency coefficient
KRN	3.47E-08	1/s	Refractory organic nitrogen hydrolysis coefficient
KRNALG	00E+00	m ³ /kg/s	Refractory organic nitrogen algal dependency coefficient
KRP	1.0E-09	1/s	Refractory organic phosphorus hydrolysis coefficient
KRPALG	6.0E+03	m ³ /kg/s	Refractory organic phosphorus algal dependency coefficient
KSUA	2.5E-07	1/s	Biogenic silica dissolution rate
KSZ	1.0E-04	kg/m ³	Zooplankton half-saturation (for algae)
KTBD	0.074	1/°C	Diatom mortality temperature coefficient
KTBG	0.074	1/°C	Greens mortality temperature coefficient
KTGD1	0.0025	1/°C ²	Diatom growth temperature coefficient (< optimum)
KTGD2	0.006	1/°C ²	Diatom growth temperature coefficient (> optimum)
KTGG1	0.0025	1/°C ²	Greens growth temperature coefficient (< optimum)
KTGG2	0.006	1/°C ²	Greens growth temperature coefficient (> optimum)
KTHDR	9.9E-02	1/°C	Hydrolysis temperature dependency coefficient
KTMNL	7.4E-02	1/°C	Mineralization temperature dependency coefficient
KTNT1	0.004	1/°C ²	Nitrification temperature coefficient (< optimum)
NTNT2	0.004	1/°C ²	Nitrification temperature coefficient (> optimum)
KTSUA	0.069	1/°C	Silica dissolution temperature coefficient
NTM	0.074	1/°C	Diatom mortality temperature coefficient
NTM	2.50E-11	kg/m ³ /s	Nitrification rate coefficient
PMD	2.90E-05	1/s	Diatom growth coefficient
PMG	2.60E-05	1/s	Greens growth coefficient
TMD	18	°C	Optimum diatom growth temperature
TMG	18	°C	Optimum greens growth temperature
TMNT	30	°C	Optimum nitrification temperature
TRD	20	°C	Optimum diatom mortality temperature

Table 2.5.1. Coefficients Used in the LM3 Model (Continued)

Coefficient	Value	Units	Description
TRG	20	°C	Optimum greens mortality temperature
TRHDR	20	°C	Optimum hydrolysis temperature
TRMNL	20	°C	Optimum mineralization temperature
TRSUA	20	°C	Optimum silica dissolution temperature
TZREF	20	°C	Optimum predation temperature
ZDTH	5.0E-07	1/s	Zooplankton mortality rate coefficient
ZTHET	1.0		Arrhenius temperature coefficient for predation
VDIA	1.15E-06	m/s	Diatoms settling coefficient
VGRE	0.85E-06	m/s	Greens settling coefficient
VLOC	2.0E-06	m/s	Labile organic carbon settling coefficient
VROC	2.0E-06	m/s	Refractory organic carbon settling coefficient
VLON	2.0E-06	m/s	Labile organic nitrogen settling coefficient
VRON	2.0E-06	m/s	Refractory organic nitrogen settling coefficient
VLOP	2.0E-06	m/s	Labile organic phosphorus settling coefficient
VROP	2.0E-06	m/s	Refractory organic phosphorus settling coefficient
VSU	2.0E-06	m/s	Biogenic silica settling coefficient

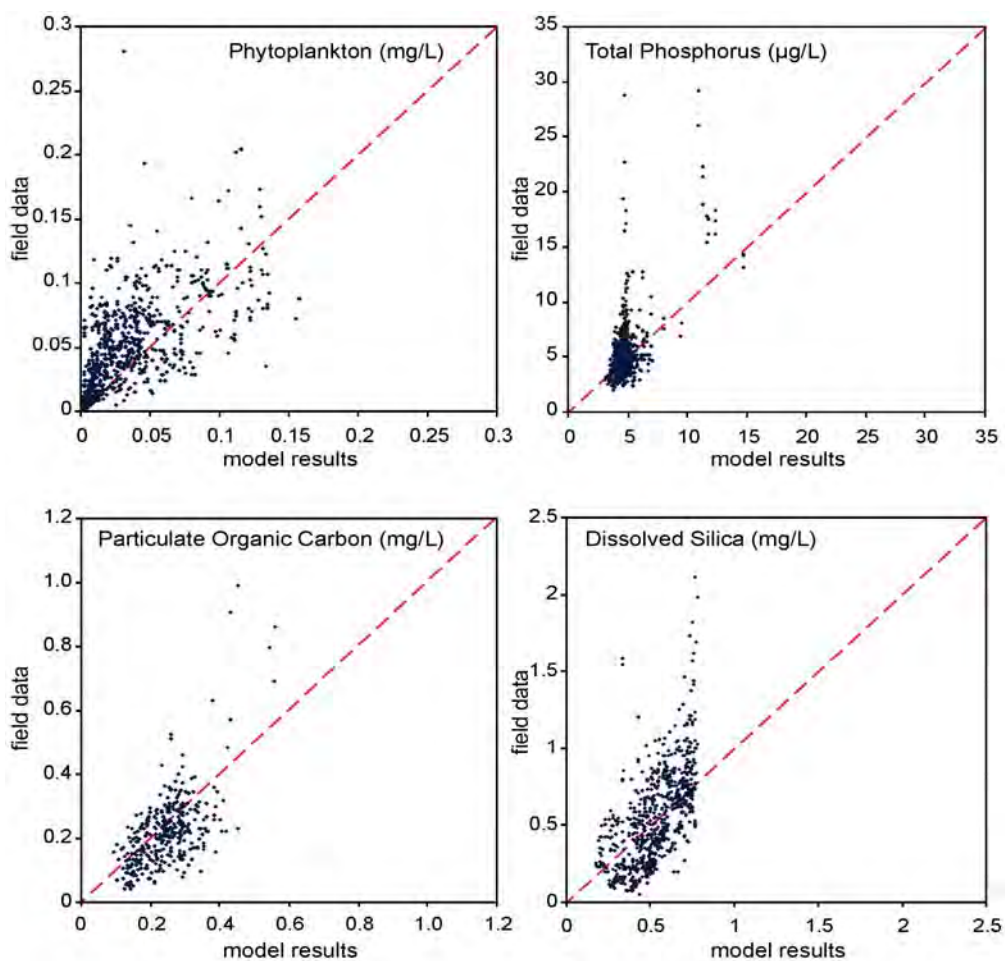

Figure 2.5.3. Level 3 LM3-Eutro model predictions versus field data, lake-wide.

Table 2.5.2. Summary of Statistical Results of the Calibration

Variable	Regression Coefficient (r^2)	Slope
Phytoplankton	0.37	0.67
Particulate Organic Carbon	0.39	0.95
Total Phosphorus	0.37	1.4
Dissolved Silica	0.37	1.2
Zooplankton	0.13	0.43

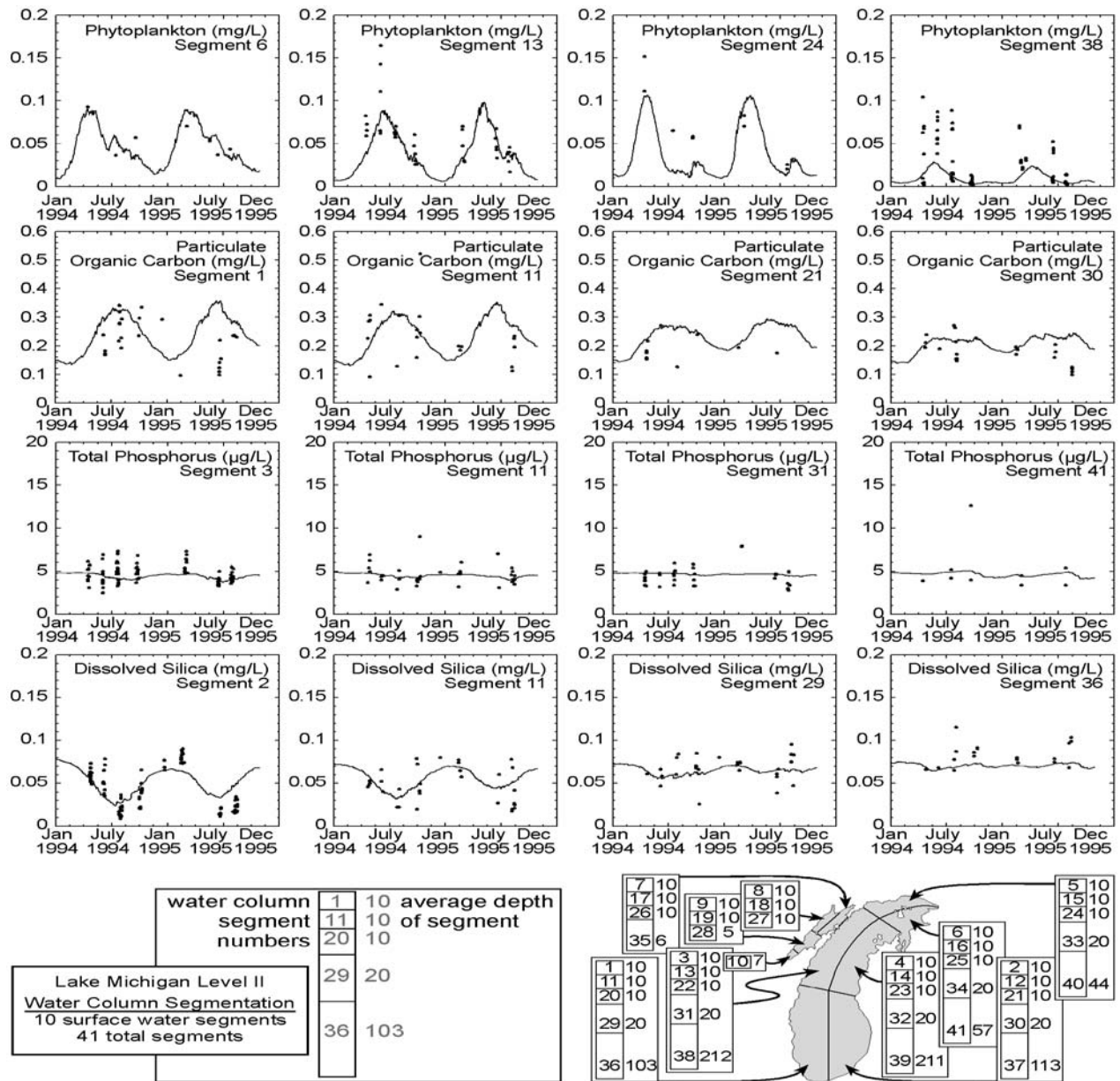

Figure 2.5.4. Level 2 LM3-Eutro model output versus field data for selected segments.

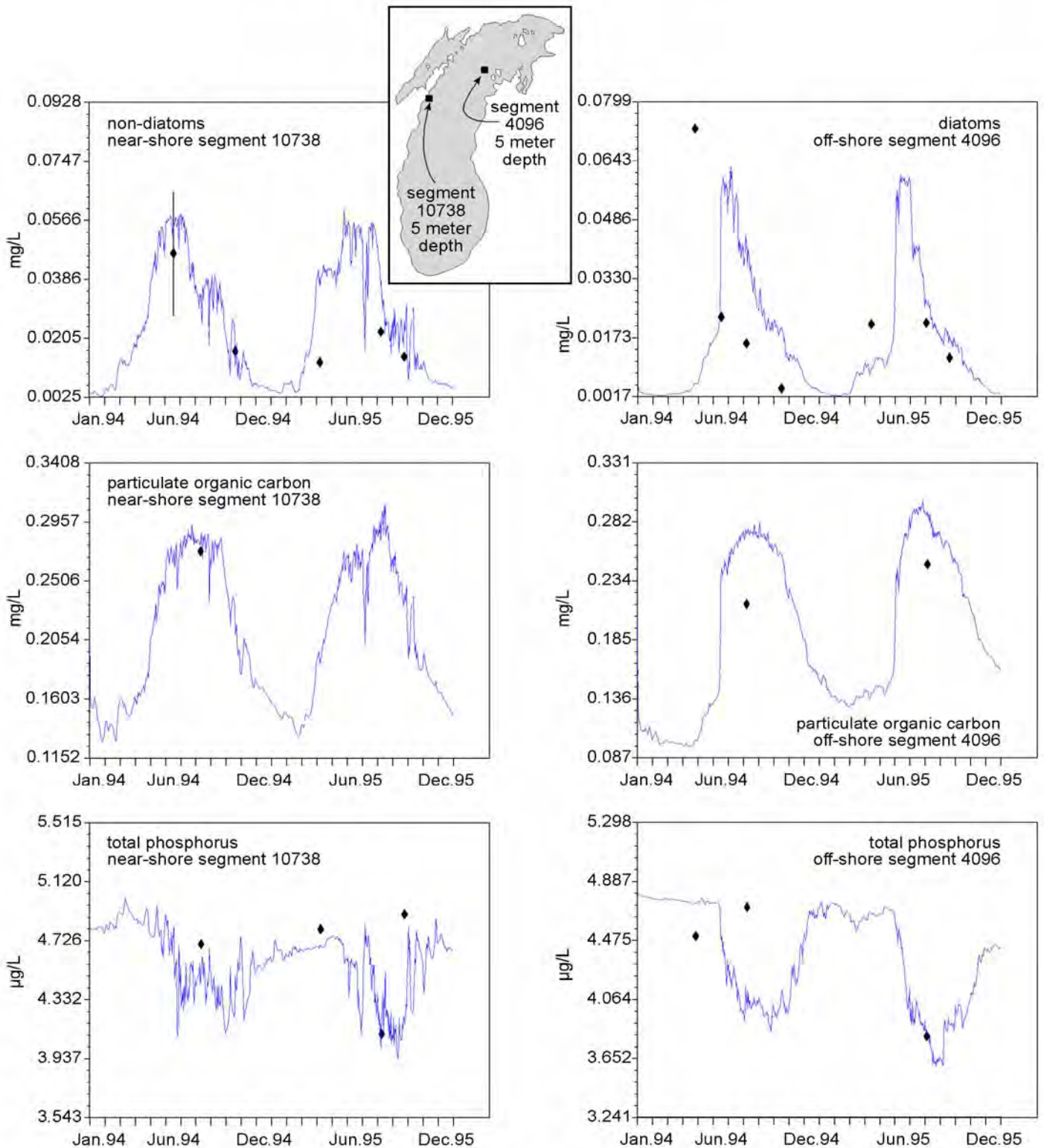

Figure 2.5.5. Level 3 LM3-Eutro model output versus field data for selected nearshore and offshore cells.

nearshore cells than in the offshore cells (Figure 2.5.5).

2.5.2.2 Particulate Organic Carbon

The model fits the field data well (Figure 2.5.3), with a slope of almost one (0.95) and a square of the correlation coefficient of almost 0.4 ($r^2 = 0.39$). The POC data exhibited less scatter than the other variables and were reflective of the phytoplankton in the lake. Additionally, we had a great deal of confidence in the POC data measurement technique. The ability of the model to capture the POC data trend increased our confidence in the model's overall eutrophication predictions. Examination of Level 2 segments showed that the model captured important trends, such as higher POC concentrations during the spring diatom bloom (Figure 2.5.4).

2.5.2.3 Total Phosphorus

The model fits the total phosphorus data reasonably well with a slope of 1.4 and a square of the correlation coefficient of 0.37. In general, the total phosphorus concentrations in the lake were fairly constant, with most measurements falling between 4 and 5 $\mu\text{g/L}$ and little seasonal variation observed. The overall model fit was acceptable (Figure 2.5.4). However, there were several higher total phosphorus values measured in Green Bay close to the Fox River and at other nearshore stations close to rivers and/or areas where there were significant sediment resuspension. In these cases, the model was not able to mimic the data, probably due to initial conditions that were too low and the lack of a sediment resuspension term.

2.5.2.4 Dissolved Silica

The dissolved silica model fits the field data well, with a slope of 1.2 (influenced by several very high silica field data points) and a regression coefficient of 0.37.

The model predicted the expected trends, with highest silica in the winter, a steep decline in the epilimnion in the spring coinciding with the diatom bloom, and a recovery toward the end of the year (Figure 2.5.4).

In general, the model fit the field data reasonably well. Seasonal and spatial trends for important variables, such as phytoplankton and silica, were captured. There were difficulties in accurately predicting Green Bay phytoplankton and nutrient concentrations, but this was not unexpected.

References

- Cerco, C. and T. Cole. 1994. Three-Dimensional Eutrophication Model of Chesapeake Bay. U.S. Army Corps of Engineers, U.S. Army Engineer Waterways Experiment Station, Vicksburg, Mississippi. Technical Report Number EL-94-4, 658 pp.
- Clesceri, L.S., A.E. Greenberg, and A.D. Eaton (Eds.). 1998. Standard Methods for the Examination of Water and Wastewater, 20th Edition. American Public Health Association, American Water Works Association, and Water Environment Federation, Hanover, Maryland. 1,205 pp.
- Thomann, R.V. 1982. Verification of Water Quality Models. *J. Environ. Engin.*, 108(EE5):933-940.
- U.S. Environmental Protection Agency. 1997. Lake Michigan Mass Balance Study (LMMB) Methods Compendium, Volume 1: Sample Collection Techniques. U.S. Environmental Protection Agency, Great Lakes National Program Office, Chicago, Illinois. EPA/905/R-97/012a, 1,440 pp.

PART 2

LM3-EUTRO

Chapter 6. Model Confirmation

The most common approach to model confirmation is the comparison of the model output to an independent field data set. Ideally, this independent field data set describes a different year or years than the calibration field data. We did not have the luxury of access to a second field data set as thorough as the 1994-1995 Lake Michigan Mass Balance Project (LMMBP) data used in model calibration. However, limited total phosphorus field data were available. In addition, we were able to compare LM3-Eutro to the historical MICH1 model, which was calibrated and applied in the 1970s and 1980s (Rodgers and Salisbury, 1981a,b) and recently extended to predict more recent chlorophyll and phosphorus concentrations in Lake Michigan (Pauer *et al.*, Submitted).

2.6.1 Additional Field Data

Limited Great Lakes National Program Office (GLNPO) monitoring data were available for comparison to model predictions. GLNPO data were collected on an annual basis for the purpose of monitoring long-term trends in the Great Lakes (Barbiero *et al.*, 2002). Samples were collected from a set of stations that formed a north-south transect through Lake Michigan (Barbiero *et al.*, 2002). Green Bay was not sampled as part of this lake monitoring effort. Samples were taken from discrete depths throughout the water column (Barbiero *et al.*, 2002). Data from the entire water column were averaged to produce 1998 spring total phosphorus and 1998 summer total phosphorus lake-wide values. The 1998 spring and summer chlorophyll *a* data were

averaged to provide seasonal epilimnion (0-20 m in depth) chlorophyll *a* values.

2.6.2 MICH1 Model

The Lake Michigan eutrophication model (MICH1) was developed as part of the International Joint Commission's (IJC) Great Lakes International Surveillance Plan. The framework was constructed by Rodgers and Salisbury (1981a, b) based on the Great Lakes model LAKE1 which was originally developed and tested for Lake Ontario (Thomann *et al.*, 1975). It is a four-segment model, simulating two zooplankton classes, a single phytoplankton class (as chlorophyll), and several nutrient species. However, it does not have a sediment component and the segmentation excludes Green Bay. MICH1 was calibrated using field data from the Lake Michigan intensive survey of 1976-1977 (Rockwell *et al.*, 1980). This model was recently resurrected and extended to run from 1976 through 1995 and compared to the LMMBP field data. Changes were also made to the MICH1 model by reducing the detrital settling rate by 20%, which results in a better model fit with the LMMBP field data (Pauer *et al.*, Submitted).

2.6.3 Comparison of LM3-Eutro to the MICH1 Model and Field Data

In order to compare LM3-Eutro to the historical MICH1 model, some modifications and qualifications were necessary. The 1994 and 1995 loads were repeated for the period 1996-2000 in both models. However, the total phosphorus loads were averaged for MICH1, while the loads were alternated in LM3-

Eutro. Although the two approaches did not result in any significant long-term differences, we observed short-term differences. Because the two models used very different segmentation schemes, all comparisons were made on a lake-wide basis, excluding Green Bay. LM3-Eutro algal carbon was converted to chlorophyll *a* using a 40:1 carbon-to-chlorophyll *a* ratio. All MICH1 simulations started in 1976 and ran through 2000, while LM3-Eutro was only simulated from 1994 to 2000.

The results are shown in Figure 2.6.1. In general, the two models compared reasonably well, which was remarkable because the models are very different in structure. MICH1 total phosphorus output was lower than that of LM3-Eutro and the 1994-1995, 1998, and 2000 field data. The revised MICH1 (20% reduced settling rate) compared more favorably with the field data and LM3-Eutro.

The epilimnetic chlorophyll *a* concentration also compared reasonably well between the models, although LM3-Eutro predictions were higher than both MICH1 predictions. The lower MICH1 output values (as compared to LM3-Eutro) were probably due to the absence of a sediment phosphorus recycle mechanism. It was difficult to compare the model versus field data for the chlorophyll due to the steep peaks and large seasonal variation in the chlorophyll *a* data.

The overall strength of the comparison between the models and the model fit with limited 1998 and 2000 field data built confidence in the LM3-Eutro framework and confirmed that the model was able to represent the eutrophication state variables in Lake Michigan.

References

- Barbiero, R.P., M.L. Tuchman, G.J. Warren, and D.C. Rockwell. 2002. Evidence of Recovery from Phosphorus Enrichment in Lake Michigan. *Canadian J. Fish. Aquat. Sci.*, 59(10):1639-1647.
- Pauer, J.J., K.W. Taunt, W. Melendez, and R.G. Kreis, Jr. Submitted. Resurrection of the Lake Michigan Eutrophication Model, MICH1. *J. Great Lakes Res*, Submitted for publication.
- Rockwell, D.C., D.S. DeVault, III; M.F. Palmer, C.V. Marion, and R.J. Bowden. 1980. Lake Michigan Intensive Survey, 1976-1977. U.S. Environmental Protection Agency, Great Lakes National Program Office, Chicago, Illinois. EPA/905/4-80/003A, 155 pp.
- Rodgers, P.W. and D. Salisbury. 1981a. Modeling of Water Quality in Lake Michigan and the Effect of the Anomalous Ice Cover of 1976-1977. Great Lakes Environmental Planning Study, Great Lakes Basin Commission, Ann Arbor, Michigan. Contribution Number 44, 53 pp.
- Rodgers, P.W. and D. Salisbury. 1981b. Water Quality Modeling of Lake Michigan and Consideration of the Anomalous Ice Cover of 1976-1977. *J. Great Lakes Res.*, 7(4):467-480.
- Thomann, R.V., D.M. Di Toro, R.P. Winfield, and D.J. O'Connor. 1975. Mathematical Modeling of Phytoplankton in Lake Ontario, Part 1: Model Development and Verification. U.S. Environmental Protection Agency, Office of Research and Development, ERL-Corvallis, Large Lakes Research Station, Grosse Ile, Michigan. EPA/660/3-75/005, 177 pp.

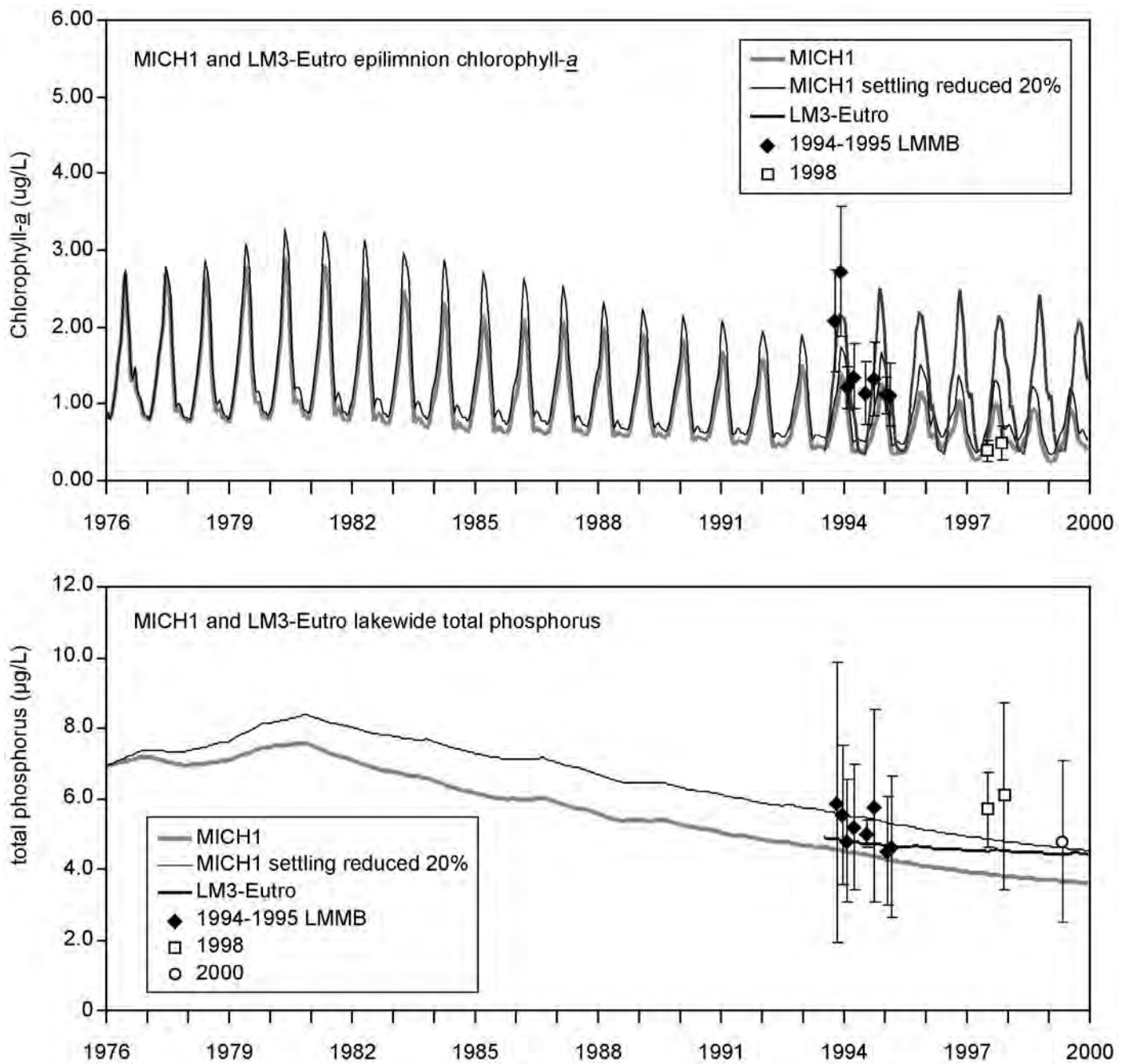

Figure 2.6.1. MICH1 versus LM3-Eutro model predictions and available field data.

PART 2

LM3-EUTRO

Chapter 7. Results – Application of Model

A total of seven model scenarios were run to evaluate future lake conditions under different total phosphorus loads. Because total phosphorus is not a model state variable, the individual phosphorus state variables (soluble reactive phosphorus [SRP], dissolved organic phosphorus [DOP], labile organic phosphorus [LOP], and refractory organic phosphorus [ROP]) were scaled accordingly to accomplish the total phosphorus load increases or reductions. The assumptions and conditions for each model scenario are briefly described followed by a Results and Discussion section. We evaluated future lake-wide total phosphorus and particulate organic carbon (POC) concentrations as well as epilimnetic and hypolimnetic chlorophyll concentrations (assuming a 20 m thermocline). Model simulation time for the scenarios ranged between 20 and 30 years, with scenarios starting in 1994 and load increases and decreases beginning in 2005.

2.7.1 Scenario 1 – Constant Conditions

2.7.1.1 Description of Assumptions

The scenario was started on January 1, 1994. A constant user-specified net sediment total phosphorus flux was applied in both space and time. Total phosphorus tributary and atmospheric loads for 1994 and 1995 were repeated in a two-year cycle. Hydrodynamics for 1994 and 1995 were similarly repeated. The model was run until steady-state was achieved.

2.7.1.2 Results and Discussion

The model reached steady-state within 28 years (2021). The steady-state lake-wide concentrations for total phosphorus and maximum POC were 4.3 µg/L and 0.2 mg/L, respectively (Figure 2.7.1), while the values for the spring maximum chlorophyll a concentrations were 2.36 µg/L for the epilimnion and 1.07 µg/L for the hypolimnion (Figure 2.7.1).

2.7.2 Scenario 2 – Virtual Elimination (Lower Bound)

2.7.2.1 Description of Assumptions

The scenario was started on January 1, 1994. A constant user-specified net sediment total phosphorus flux was applied in both space and time. The Constant Conditions scenario (Scenario 1) was run from January 1, 1994 to December 31, 2004. Beginning on January 1, 2005, tributary and atmospheric total phosphorus loads were reduced by 100% and the sediment total phosphorus fluxes were assumed to be zero. The model was run for a total of 30 years (through December 2023).

2.7.2.2 Results and Discussion

As expected, the total phosphorus concentration significantly declined once the atmospheric and tributary total phosphorus loads were turned off. The model predicted that after 30 years (December 2023), the lake-wide total phosphorus concentration would be 0.54 µg/L (Figure 2.7.2). The epilimnetic maximum chlorophyll a concentration after 30 years would be less than 0.1 µg/L, while the hypolimnetic

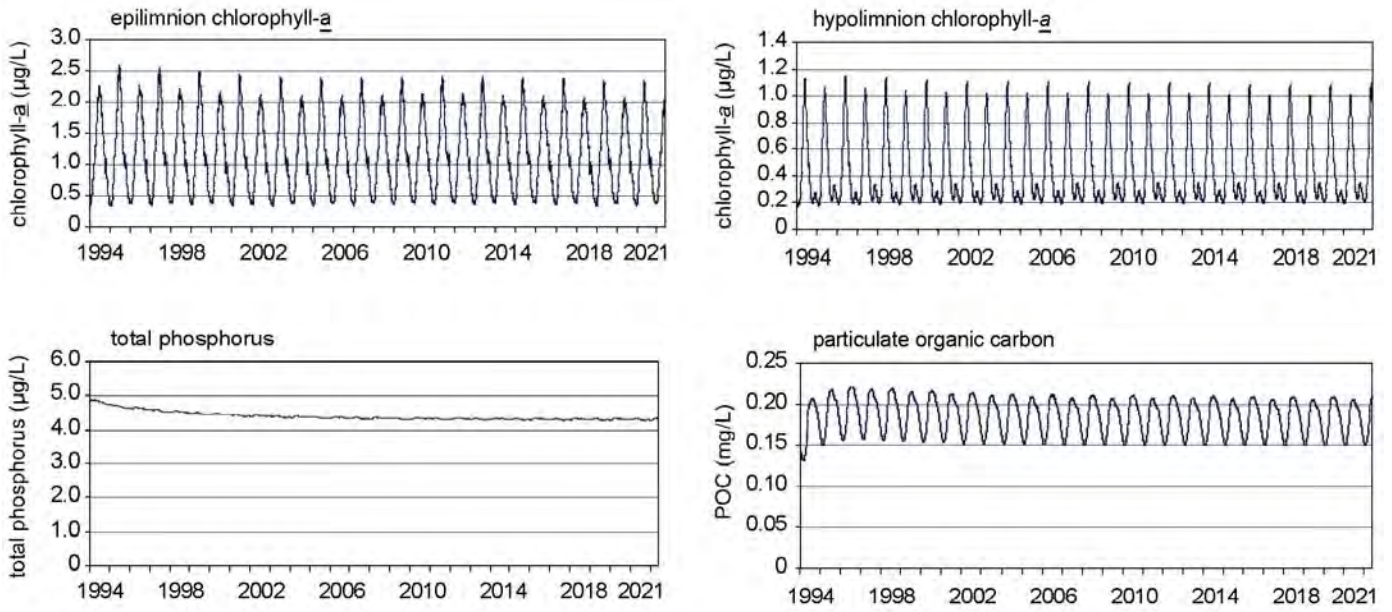

Figure 2.7.1. Scenario 1: Constant Conditions.

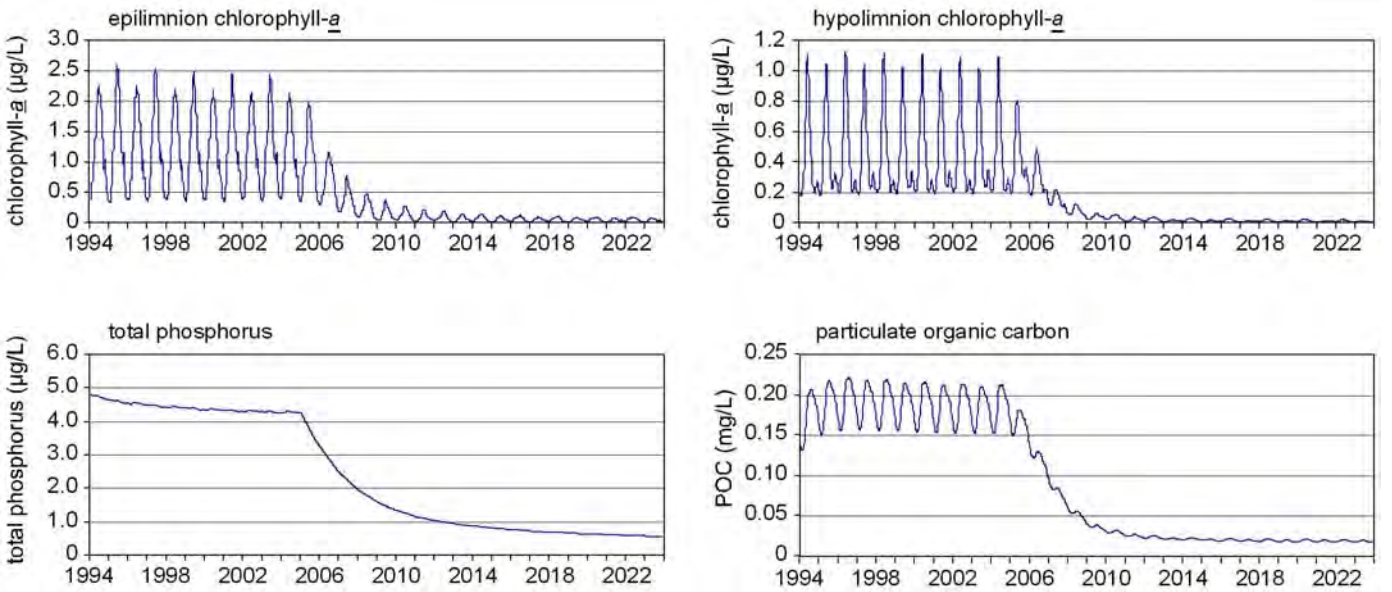

Figure 2.7.2. Scenario 2: Virtual elimination.

concentration would be approaching zero (Figure 2.7.2). In 2023, the lake-wide POC concentration maximum was around 0.02 mg/L (Figure 2.7.2).

2.7.3 Scenario 3 – Best Estimate of Current Trends Resulting From Previous Actions

2.7.3.1 Description of Assumptions

The scenario was started on January 1, 1994. A constant user-specified net sediment total phosphorus flux was applied in both space and time. Tributary and atmospheric total phosphorus loads declined at rates observed over the last two decades (1981-1995). The model was run for a total of 20 years (through December 2013).

The rate of total phosphorus decay was based on the downward trend of total phosphorus in Lake Michigan since the 1980s. In order to calculate the decay, it was assumed that the total phosphorus equation was an exponential. Figure 2.7.3 shows the Lake Michigan historical total phosphorus loading. Although historical total phosphorus loading data

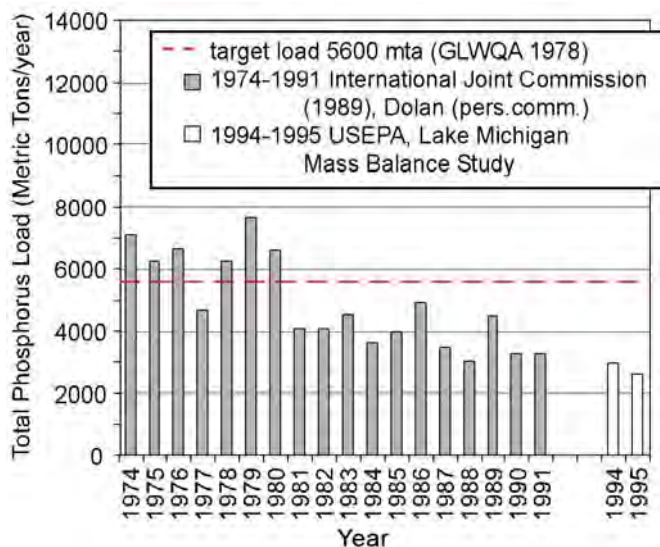

Figure 2.7.3. Historical total phosphorus loading – Lake Michigan.

prior to 1981 were available, only the loading values between 1981 and 1995 were used because it was believed this provided the most realistic picture of the

present loading trend. No loading data were available after 1995. Total phosphorus loads were assumed to follow the equation:

$$L(t) = L(t_0) \exp [k(t - t_0)] \quad (2.7.1)$$

where

t = time in units of years

t_0 = initial time (1981)

$L(t)$ = total phosphorus load at time t

$L(t_0)$ = total phosphorus load at time t_0

k = total phosphorus decay rate in units of 1/year.

The decay rate k was calculated by applying the Least Squares Fitting method and has a value of -2.21×10^{-2} /year.

2.7.3.2 Results and Discussion

The total phosphorus concentration steadily declined over 20 years to approximately 3.5 $\mu\text{g/L}$ (Figure 2.7.4). The epilimnetic chlorophyll a reached a value of approximately 2.0 $\mu\text{g/L}$, while the hypolimnion fell below 0.9 $\mu\text{g/L}$ (Figure 2.7.4). In 2013, the lake-wide POC maximum concentration was around 0.18 mg/L (Figure 2.7.4).

2.7.4 Scenario 4 – Scenario 1 With Instantaneous Reduction of Tributary Loads to Zero

2.7.4.1 Description of Assumptions

The scenario was started on January 1, 1994. A constant user-specified net sediment total phosphorus flux was applied in both space and time. The Constant Conditions scenario (Scenario 1) was run from January 1, 1994 to December 31, 2004. Beginning on January 1, 2005, tributary total phosphorus loads were reduced by 100%. The 1994 and 1995 atmospheric load cycle was continued. The model was run for a total of 30 years (through December 2023).

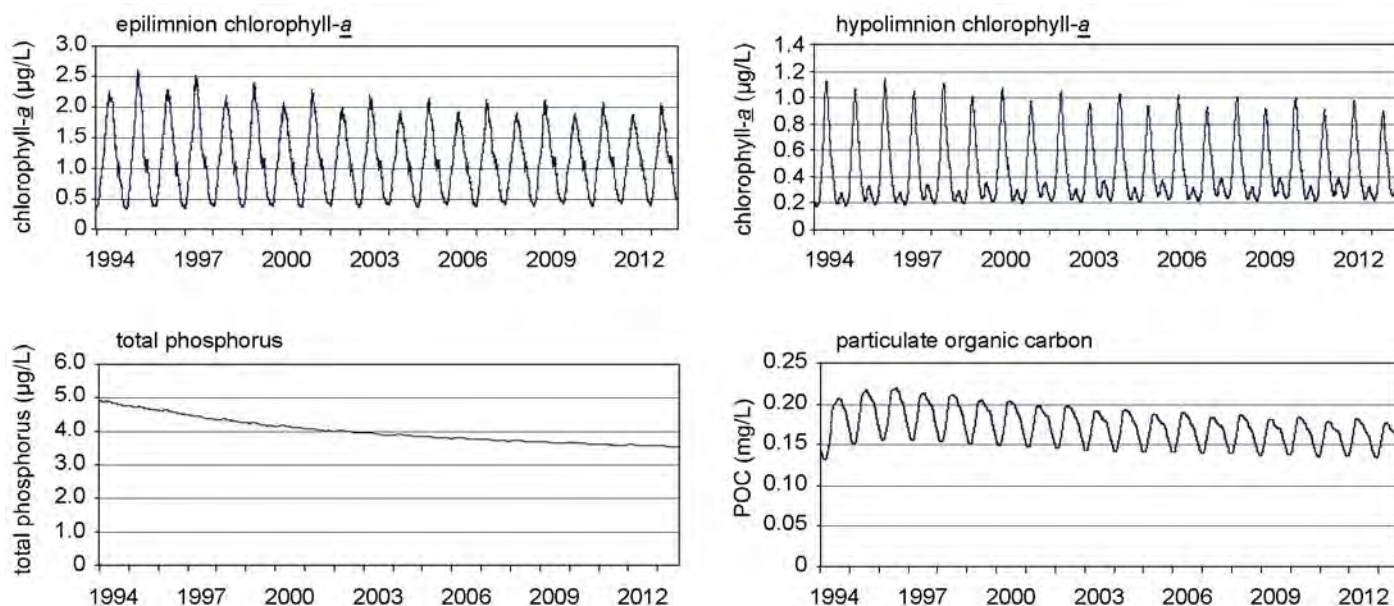

Figure 2.7.4. Scenario 3: Best estimate of current trends resulting from previous actions.

2.7.4.2 Results and Discussion

There was a significant decline in the total phosphorus concentration when the tributary loads were turned off in January 2005 (Figure 2.7.5).

However, this decline was not as steep as that observed in Scenario 2 (Virtual Elimination). The total phosphorus concentration at the end of 2023 was 0.91 µg/L, which was higher than the 0.54 µg/L observed in the Virtual Elimination scenario (Scenario 2). Similarly, after 30 years, the maximum chlorophyll a concentration fell to approximately 0.4 µg/L and less than 0.1 µg/L for the epilimnion and hypolimnion, respectively (Figure 2.7.5), and the lake-wide POC maximum was 0.03 mg/L (Figure 2.7.5). These values were all somewhat higher than their equivalents in Scenario 2.

2.7.5 Scenario 5 – Scenario 1 With Instantaneous Reduction of Atmospheric Loads to Zero

2.7.5.1 Description of Assumptions

The scenario was started in January 1, 1994. A constant user-specified net sediment total

phosphorus flux was applied in both space and time. The Constant Conditions scenario (Scenario 1) was run from January 1, 1994 to December 31, 2004. Beginning on January 1, 2005, atmospheric total phosphorus loads were reduced by 100%. The 1994 and 1995 tributary load cycle was continued. The model was run for a total of 20 years (through December 2013).

2.7.5.2 Results and Discussion

Turning off the atmospheric total phosphorus loads had little effect on the total phosphorus, chlorophyll a, and POC concentration (Figure 2.7.6) as compared to the Constant Conditions scenario (Figure 2.7.1).

2.7.6 Scenario 6 – Scenario 1 With Tributary and Atmospheric Loads Increased 20%

2.7.6.1 Description of Assumptions

The scenario was started on January 1, 1994. A constant user-specified net sediment total phosphorus flux was applied in both space and time. The Constant Conditions scenario (Scenario 1) was run from January 1, 1994 to December 31, 2004.

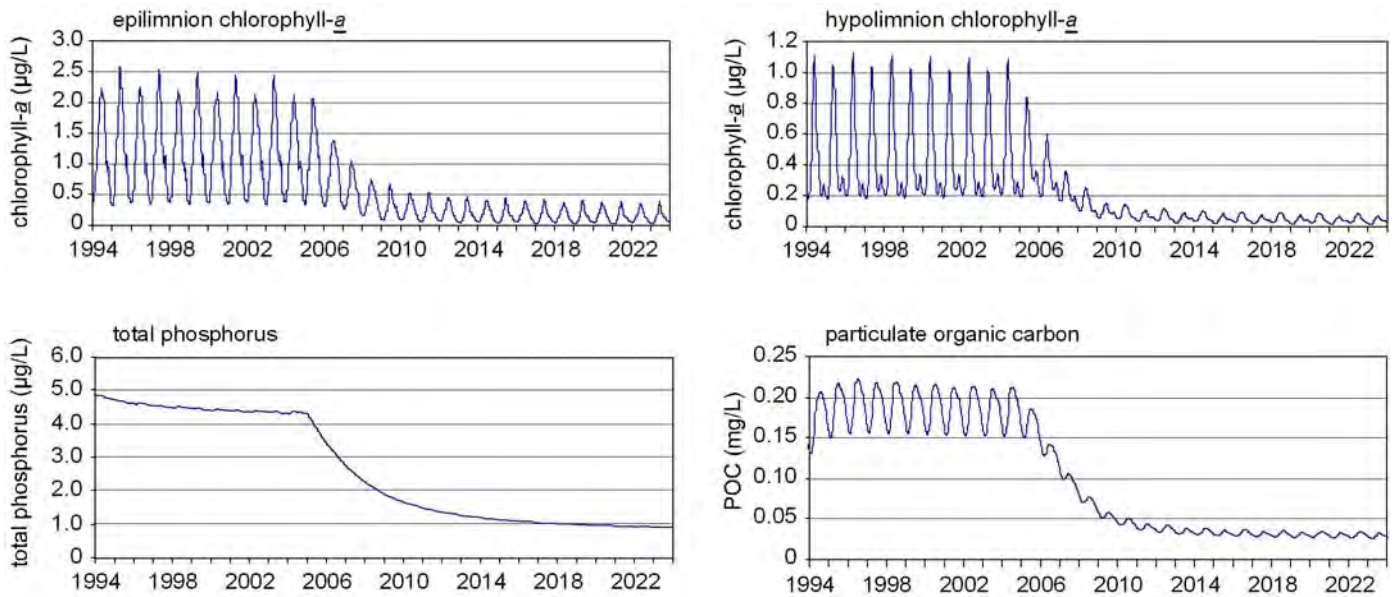

Figure 2.7.5. Scenario 4: Scenario 1 with tributary load elimination.

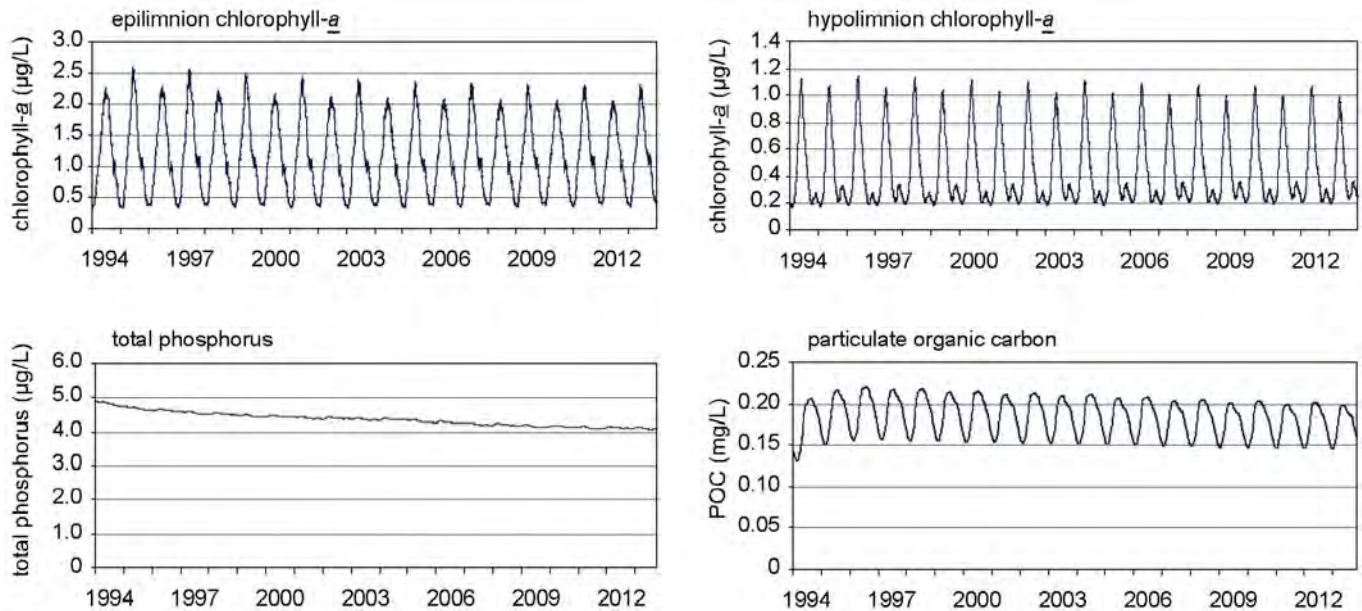

Figure 2.7.6. Scenario 5: Scenario 1 with atmospheric load elimination.

Beginning on January 1, 2005, tributary and atmospheric total phosphorus loads were increased by 20%. The model was run for a total of 20 years (through December 2013).

2.7.6.2 Results and Discussion

The 20% increase in total phosphorus loads had a relatively small influence on the total phosphorus concentration, the epilimnetic chlorophyll *a* concentration, and the POC concentration (compare Figure 2.7.7 [20% load increase] with Figure 2.7.1 [Constant Conditions]). The lake-wide total phosphorus concentration after 20 years was 4.6 $\mu\text{g/L}$ (Figure 2.7.7). Maximum chlorophyll *a* concentrations after 20 years were 2.2-2.5 $\mu\text{g/L}$ (epilimnion) and 1.1 $\mu\text{g/L}$ (hypolimnion) (Figure 2.7.7). The lake-wide POC maximum concentration was 0.22 mg/L (Figure 2.7.7).

2.7.7 Scenario 7 – Application of Great Lakes Water Quality Agreement Loads to Model

2.7.7.1 Description of Assumptions

The scenario was started on January 1, 1994. A constant user-specified net sediment total phosphorus flux was applied in both space and time. The Constant Conditions scenario (Scenario 1) was run from January 1, 1994 to December 31, 2004. Beginning on January 1, 2005, the 1978 Great Lakes Water Quality Agreement (GLWQA) specified total phosphorus target loading of 5,600 MT/year was applied (International Joint Commission, 1978). The 1994 and 1995 atmospheric load cycle was continued. A new user-defined net sediment total phosphorus flux was estimated, assuming that approximately 95% of the phosphorus load was retained in the sediment and 5% was recycled back to the water column. The model was run to steady-state.

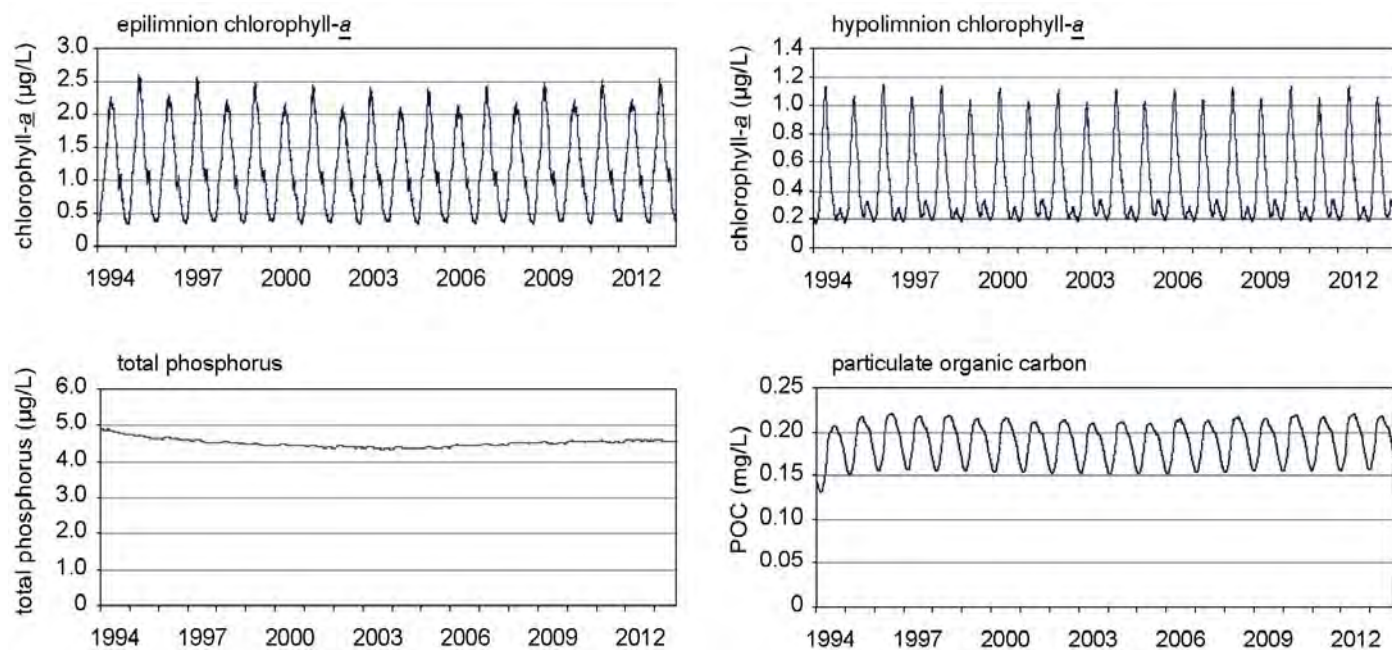

Figure 2.7.7. Scenario 6: Scenario 1 with tributary and atmospheric loads increased 20%.

2.7.7.2 Results and Discussion

Applying the GLWQA total phosphorus load of 5,600 MT/year resulted in a lake-wide steady-state total phosphorus concentration of 7.5 µg/L and an epilimnetic chlorophyll *a* maximum of 4.0 µg/L (Figure 2.7.8). The hypolimnetic chlorophyll *a* maximum at steady-state was 1.6 µg/L (Figure 2.7.8). Steady-state lake-wide maximum POC was approximately 0.28 mg/L (Figure 2.7.8). Steady-state was reached within 30 years.

2.7.8 Scenario 8 – Estimate of Total Maximum Daily Loads to Reach International Joint Commission’s Target Total Phosphorus Concentration

2.7.8.1 Description of Assumptions

The scenario was started on January 1, 1994. A constant user-specified net sediment total phosphorus flux was applied in both space and time. The Constant Conditions scenario (Scenario 1) was run from January 1, 1994 to December 31, 2004. Through trial-and-error, a total phosphorus load (tributary and atmospheric) that resulted in steady-state total phosphorus concentration of 7 µg/L (the lake-wide International Joint Commission’s [IJC] target) was determined (Great Lakes Research Advisory Board, 1978). A new user-defined net sediment total phosphorus flux was estimated, assuming that approximately 95% of the phosphorus load was retained in the sediment and 5% was recycled back to the water column. The IJC total phosphorus concentration target was chosen with the goal of returning Lake Michigan to its “natural oligotrophic state” under the GLWQA (International Joint Commission, 1978). The model was run to steady-state.

2.7.8.2 Results and Discussion

An average annual total phosphorus load of 5,020 MT resulted in a steady-state lake-wide total phosphorus concentration of 7 µg/L (Figure 2.7.9). This equated to a total phosphorus total maximum daily load (TMDL) of 14 MT/d. This also resulted in a spring epilimnetic maximum chlorophyll *a* concentration of 3.7 µg/L and a spring hypolimnetic chlorophyll *a* concentration of 1.6 µg/L (Figure 2.7.9).

Steady-state lake-wide maximum POC was around 0.33 mg/L (Figure 2.7.9). Steady-state was reached within approximately 30 years.

2.7.9 Scenario Comparison and Discussion

A summary of the final total phosphorus, chlorophyll *a*, and POC concentrations is shown in Table 2.7.1. Examining the scenarios revealed a number of interesting conclusions regarding Lake Michigan. It was apparent from comparing Scenarios 1, 4, and 5 that tributary loading was considerably more important than atmospheric loading in driving Lake Michigan total phosphorus and chlorophyll *a* (Figures 2.7.1, 2.7.5, and 2.7.6). However, as Scenario 6 revealed, a small increase in loading (tributary and atmospheric) does not have a large impact on the lake (Figure 2.7.7). Scenario 2 confirmed that Lake Michigan’s reaction to significant loading changes is immediate but buffered by the large water volume and slow retention time of the lake (Figure 2.7.2). Scenario 3 suggested that if current loading trends continue, lake-wide total phosphorus and chlorophyll *a* will continue to slowly decline (Figure 2.7.4). Scenarios 7 and 8 demonstrated the drastic increases in chlorophyll *a*, total phosphorus, and POC that would occur if loading to Lake Michigan were allowed to increase to GLWQA/IJC limits (Figures 2.7.8 and 2.7.9).

2.7.10 Mass Budget

The sources, sinks, and lake inventory of total phosphorus was estimated. Figure 2.7.10 is a graphical representation of the average annual loads, sinks, and total phosphorus inventory for Lake Michigan based on 1994 and 1995 modeled and measured data. It was clear that the internal recycle (settling and sediment feedback) accounted for the majority of total phosphorus dynamics occurring in the lake. A significant mass of phosphorus settled to the lake bed, but a large percentage (~ 60%) is recycled back to the water column. The monitored tributaries made up the largest external total phosphorus source to the lake, while the unmonitored tributaries and atmospheric loads were relatively small components. The total phosphorus export at the Straits of Mackinac and the Chicago diversion were estimated to be a small fraction of the

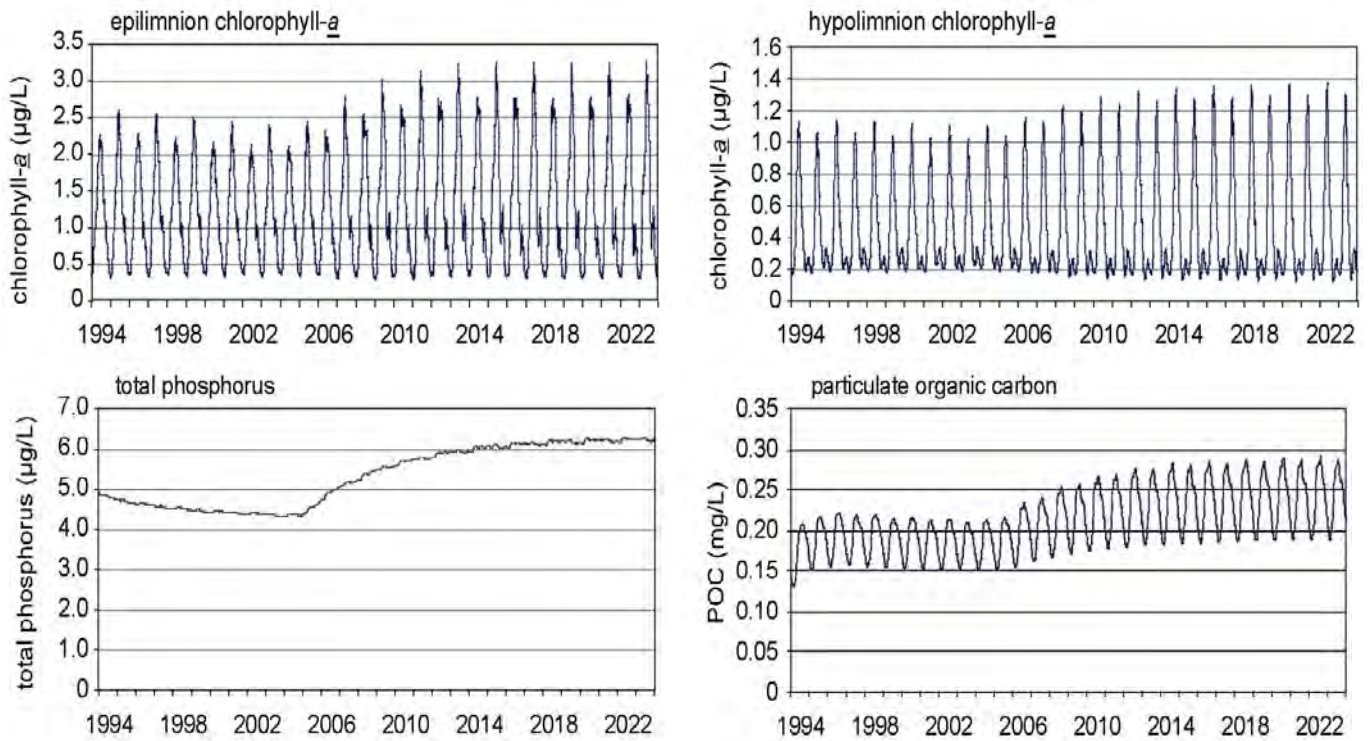

Figure 2.7.8. Scenario 7: Application of the GLWQA loads to the model.

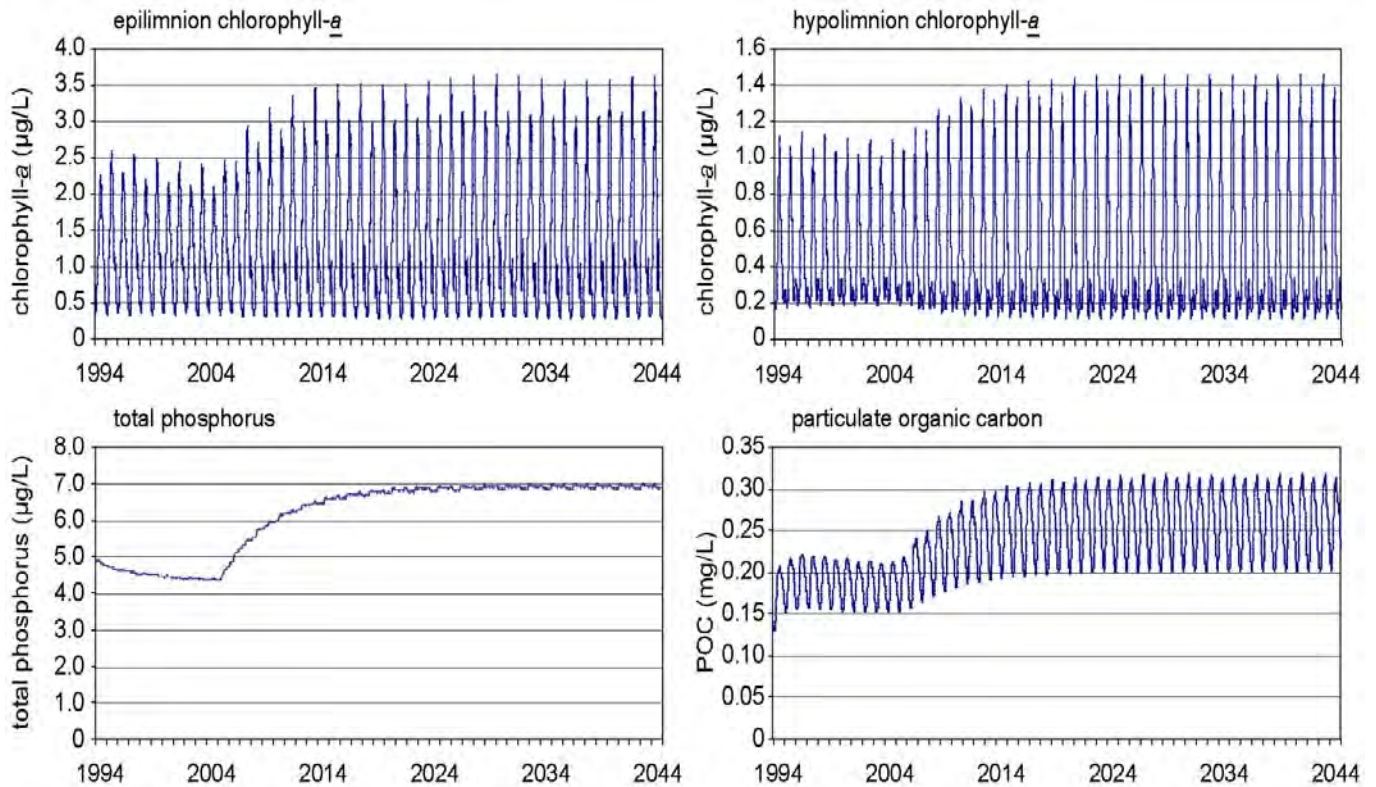

Figure 2.7.9. Scenario 8: Estimate of the TMDL to reach the IJC's target total phosphorus concentration.

Table 2.7.1. Final Eutrophication Scenario Results

Scenario and Length	Description	Spring Maximum		Total Phosphorus (µg/L)	Maximum Particulate Organic Carbon (mg/L)
		Epilimnion Chlorophyll <i>a</i> (µg/L)	Hypolimnion Chlorophyll <i>a</i> (µg/L)		
1 (28 years)	Constant Conditions Remain From 1994-1995	2.4	1.1	4.3	0.20
2 (30 years)	Virtual Elimination (Lower Bound)	0.1	~0	0.54	0.02
3 (20 years)	Best Estimate of Current Trends Resulting From Previous Actions	2.0	0.9	3.5	0.18
4 (30 years)	Scenario 1 With Instantaneous Reductions of Tributary Loads to Zero	0.4	0.1	0.91	0.03
5 (30 years)	Scenario 1 With Instantaneous Reductions of Atmospheric Loads to Zero	2.3	1.1	4.1	0.20
6 (20 years)	Scenario 1 With Tributary and Atmospheric Loads Increased 20%	2.5	1.1	4.6	0.22
7 (30 years)	Application of GLWQA Loads to Model	4.0	1.6	7.5	0.34
8 (30 years)	Estimate of TMDL to Reach IJC Target Total Phosphorus Concentration	3.7	1.6	7.0	0.33

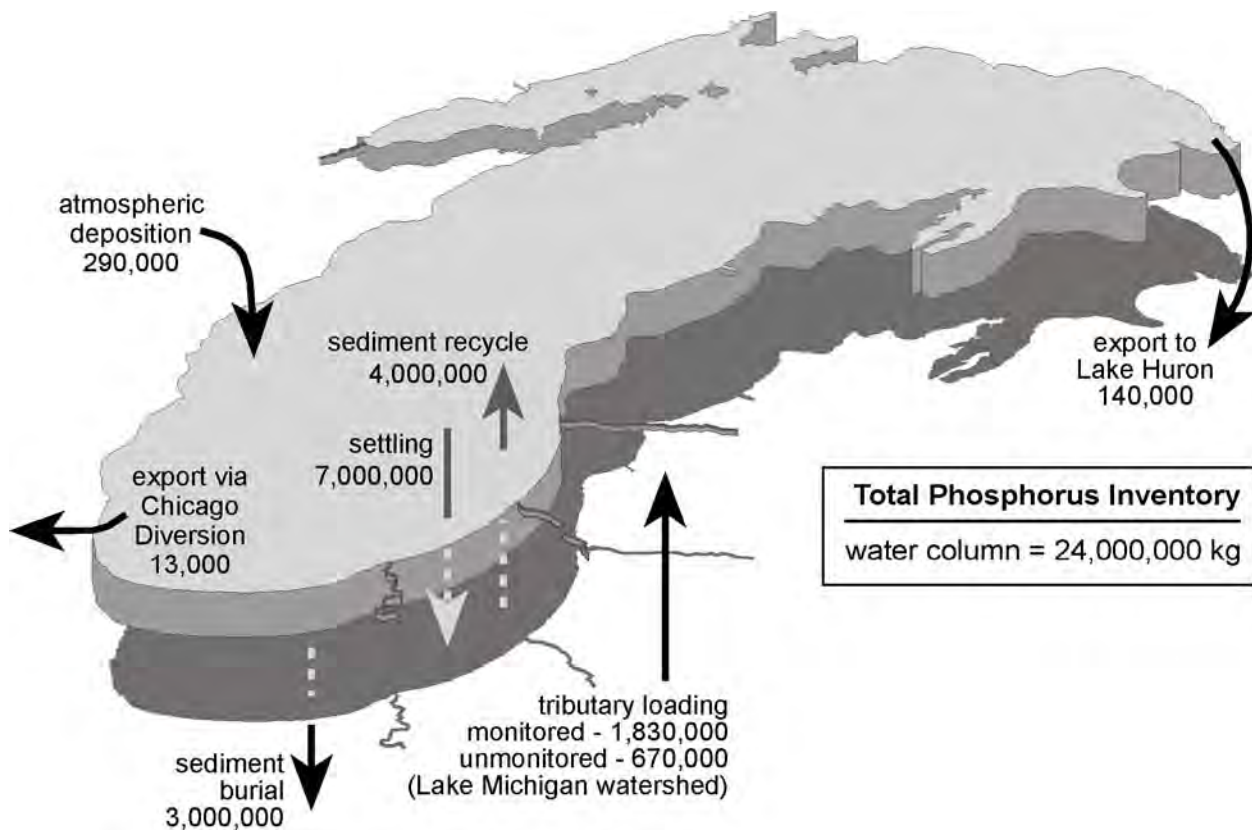

Figure 2.7.10. Annual average (1994-1995) Lake Michigan total phosphorus loading (kg/year).

total export. Overall, the best estimate using the average of the 1994-1995 loads was that there was a 5% annual loss of total phosphorus in the lake, which suggested that there would be a small, but steady, decrease in the total phosphorus lake concentration given constant total phosphorus loads. Figure 2.7.11 is a breakdown of the total phosphorus loads and inventory of the main lake and Green Bay. It depicts the loads entering the bay and lake separately and the phosphorus exchange between these two system. Phosphorus from Green Bay accounted for approximately 13% of the total phosphorus input into Lake Michigan. The bulk of the Green Bay total phosphorus load was from the Fox River.

References

- Great Lakes Advisory Board. 1978. Annual Report to the International Joint Commission. International Joint Commission, Windsor, Ontario, Canada. 44 pp.
- International Joint Commission. 1978. Great Lakes Water Quality Agreement of 1978, with Annexes and Terms of Reference, Between the United States and Canada, Signed at Ottawa, November 22, 1978. International Joint Commission, Windsor, Ontario, Canada. 60 pp.

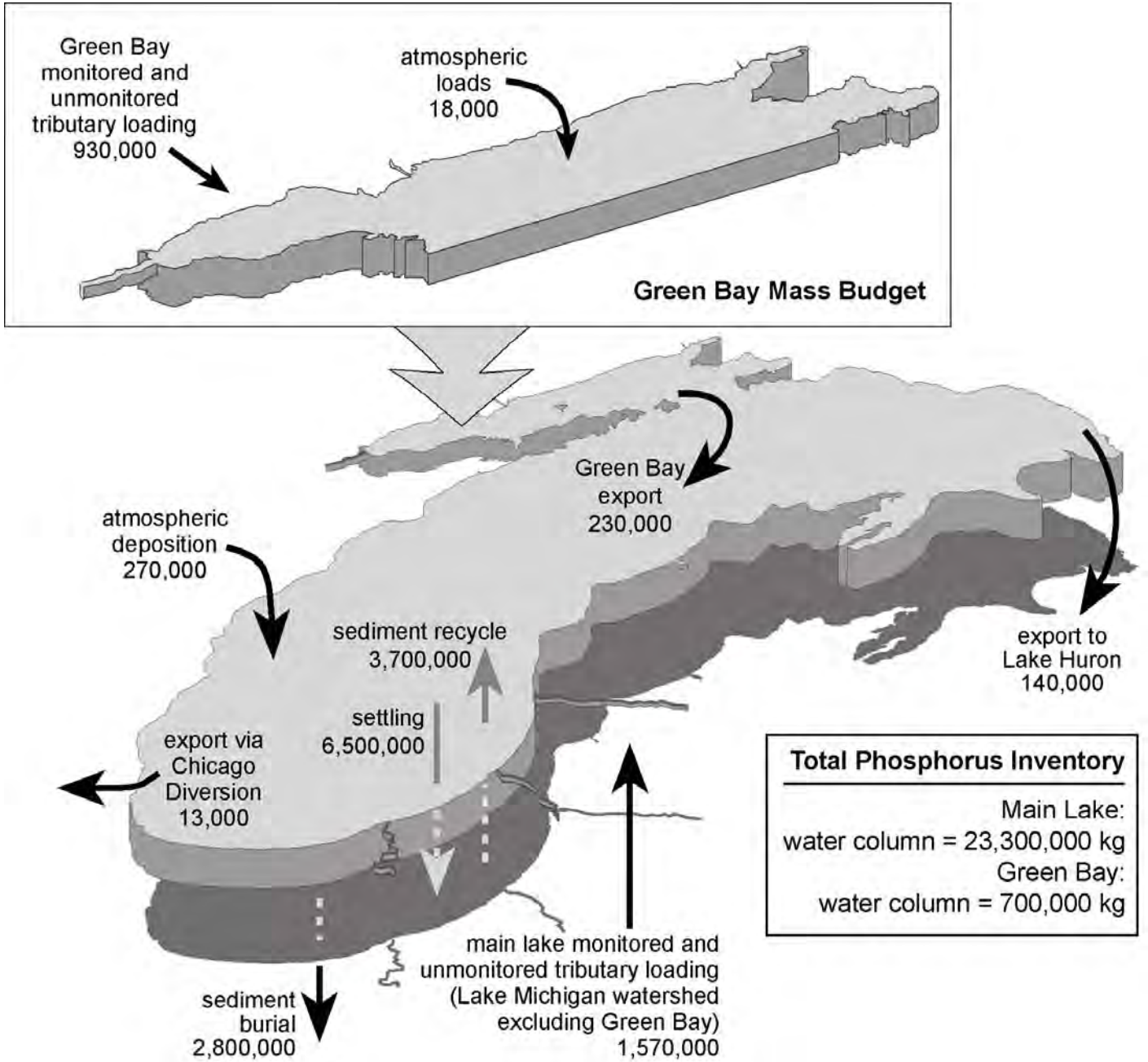

Figure 2.7.11. Annual average (1994-1995) Lake Michigan and Green Bay total phosphorus loading (kg/year).

PART 2

LM3-EUTRO

Chapter 8. Results Provided for LM2-Toxic

2.8.1 Description

LM2-Toxic was developed to simulate congener-specific polychlorinated biphenyl (PCB) state variables. Due to the importance of organic carbon in the fate and transport of PCBs, the model also simulated three carbon states: biotic carbon (BIC), particulate detrital carbon (PDC), and dissolved organic carbon (DOC). LM2-Toxic relied on external calculations (measured or modeled) to estimate the autochthonous and allochthonous carbon loads. The internally produced carbon made up the majority of carbon entering the lake. Thus, a reliable estimate of this internal load was of utmost importance in accurately simulating the organic carbon in the system. The main purpose of the eutrophication model (LM3-Eutro) in the Lake Michigan Mass Balance Project (LMMBP) was to provide autochthonous (internally produced) phytoplankton carbon to the PCB fate and transport model (LM2-Toxic).

2.8.2 Manipulation of Results

LM3-Eutro and LM2-Toxic utilize very different modeling frameworks, with different segmentation schemes, hydrodynamics, and transport mechanisms. Several modifications were made to LM3-Eutro to ensure data compatibility when exporting the autochthonous carbon to LM2-Toxic. Because all necessary changes were made within LM3-Eutro code, no post-processing was necessary. LM3-Eutro generated carbon from primary production at each model time step. The model used a variable time step of approximately three hours. The carbon was totaled on a daily basis, and the high-resolution LM3-Eutro 5 km² segments were collapsed to the Level 2 segmentation scheme to generate daily allochthonous carbon loads for each of the 41 Level 2 segments. These loads were generated for the 1994-1995 calibration years, as well as a long-term simulation where the 1994 and 1995 loading and hydrodynamics data were repeated for approximately 28 years (see Part 2, Chapter 7, Section 2.7.1 – Constant Conditions Remain From 1994-1995).

PART 3

LEVEL 1 MODELS

Douglas D. Endicott
Great Lakes Environmental Center
Traverse City, Michigan
and

Timothy J. Feist
Gregory Gerstner
Welso Federal Services, LLC
Large Lakes Research Station
9311 Groh Road
Grosse Ile, Michigan 48138
and

Kenneth R. Rygwelski
U.S. Environmental Protection Agency
Office of Research and Development
National Health and Environmental Effects Research Laboratory
Mid-Continent Ecology Division
Large Lakes and Rivers Forecasting Research Branch
Large Lakes Research Station
9311 Groh Road
Grosse Ile, Michigan 48138

Chapter 1. MICHTOX PCB Model Executive Summary

MICHTOX is a toxic chemical mass balance and food chain bioaccumulation model. In this project, the model was used to provide a screening-level analysis of the potential future trends in total polychlorinated biphenyl (PCB) concentrations in Lake Michigan water, sediment, and fish under a variety of contaminant load scenarios. The model also provided a comparison of an older, “off-the-shelf” model with the more complex models developed as part of the Lake Michigan Mass Balance Project (LMMBP). Results of the MICHTOX modeling indicate that atmospheric exchange is a dominant

loss process of total PCBs in Lake Michigan, and that the reservoir of total PCBs in the sediment has a significant impact on the future trends in concentrations of total PCBs in lake trout.

MICHTOX was developed in the early 1990s to provide guidance for the Lake Michigan Lake-wide Management Plan (LaMP) and to assist with the planning of the LMMBP (Endicott *et al.*, 2005). During the early part of the LMMBP, MICHTOX was updated and used as a preliminary assessment tool of the LMMBP PCB data (Endicott, 2005). For the present study, the updated fate and transport submodel was used to provide exposure concentrations to the food chain submodel under

seven scenarios of future PCB loadings to Lake Michigan.

Chapter 3 summarizes the work with the MICHTOX fate and transport submodel. This includes the evaluation of historical loading trends in the earlier project (Endicott, 2005). The preliminary modeling suggested that the scenario of historical PCB loads to the lake that best fit the available data was one in which loads increased from zero at a start date of 1940, peaked in 1961-1963, and then declined to present levels. This hindcast was later updated using the LM2-Toxic model, as described in Part 4.

A Bayesian Monte Carlo (BMC) uncertainty analysis was also conducted in the earlier project that demonstrated that MICHTOX predicted PCB concentrations should be within a factor of two of the measured data.

For the present study, atmospheric and tributary loads, including unmonitored tributary inputs, were calculated for the 1994-1995 LMMP sampling period. The model was run using these inputs and the previously developed parameterization, and the applicability of MICHTOX as a screening model for predicting Lake Michigan total PCB concentrations in water, sediment, and fish was reconfirmed.

Chapter 4 summarizes the work with the MICHTOX food chain submodel and the application of the model for predicting potential total PCB concentrations under different loading scenarios. Data to parameterize the food chain model was obtained from the LMMP sampling effort. The applicability of the food chain model was confirmed by applying it to the previous hindcast scenarios and to 1994-2000 Lake Michigan lake trout data.

MICHTOX was run for seven scenarios to help evaluate future loading trends and the impacts on PCB concentrations of various loading sources. These scenarios included:

- ▶ Continued loading at 1994-1995 levels
- ▶ Continued recovery - fast rate
- ▶ Continued recovery - slow rate
- ▶ Zero atmospheric deposition
- ▶ Zero tributary loads

- ▶ Zero atmospheric deposition and zero tributary loads
- ▶ Lake-wide sediment cleanup

The scenario model runs indicated that if declining trends in loading sources occurred at the faster of rates found in the scientific literature, the total PCB concentrations in an average 5-6 year-old lake trout in southern Lake Michigan would be reduced below the fish consumption advisory target level by approximately the year 2025. If loading sources declined at the slower rates found in the literature, total PCB concentrations in an average 5-6 year-old lake trout would be reduced below the target level by approximately 2053. The sensitivity scenarios indicated that the system was more affected by atmospheric vapor concentration and deposition than tributary loadings, and that the sediment reservoir of total PCBs played a large role in the concentrations observed in lake trout.

References

- Endicott, D.D. 2005. 2002 Lake Michigan Mass Balance Project: Modeling Total PCBs Using the MICHTOX Model. In: R. Rossmann (Ed.), MICHTOX: A Mass Balance and Bioaccumulation Model for Toxic Chemicals in Lake Michigan, Part 2. U.S. Environmental Protection Agency, Office of Research and Development, National Health and Environmental Effects Research Laboratory, MED-Duluth, Large Lakes Research Station, Grosse Ile, Michigan. EPA/600/R-05/158, 140 pp.
- Endicott, D.D., W.L. Richardson, and D.J. Kandt. 2005. 1992 MICHTOX: A Mass Balance and Bioaccumulation Model for Toxic Chemicals in Lake Michigan. In: R. Rossmann (Ed.), MICHTOX: A Mass Balance and Bioaccumulation Model for Toxic Chemicals in Lake Michigan, Part 1. U.S. Environmental Protection Agency, Office of Research and Development, National Health and Environmental Effects Research Laboratory, MED-Duluth, Large Lakes Research Station, Grosse Ile, Michigan. EPA/600/R-05/158, 140 pp.

PART 3

LEVEL 1 MODELS

Chapter 2. MICHTOX Recommendations

MICHTOX was adapted from the general model, WASP4, and has served well as a screening-level model for Lake Michigan over the past several decades. Much of the model development took place prior to the availability of an extensive data set collected for the Lake Michigan Mass Balance Project (LMMBP) during 1994-1995 and, therefore, depended heavily on existing historical data. In contrast, the LM2-Toxic model and LM Food Chain model were constructed using the most recent data from the LMMBP. Some of the advantages of using LM2-Toxic instead of MICHTOX as a screening-level model for future contaminants of interest include the following:

- LM2-Toxic has a significant amount of documentation.
- LM2-Toxic algorithms are all contained within the WASP code, whereas MICHTOX utilizes Excel spreadsheets for some of the calculations. This makes code modifying in LM2-Toxic easier.
- LM2-Toxic automatically corrects the Henry's Law Constant for temperature.
- LM2-Toxic has a better treatment of carbon (including having biotic and abiotic carbon and carbon decay).

- LM2-Toxic is as easy and fast as MICHTOX in preparing model runs for similar numbers of state variables.
- LM2-Toxic utilizes output from the hydrodynamic model to compute advective flows and vertical exchanges.
- LM2-Toxic carbon state variables are from the LM3-Eutro model for defining autochthonous carbon generation.
- LM2-Toxic handles sediment as a limited source for resuspension; whereas, MICHTOX does not.
- LM Food Chain has more organisms in its food web.
- LM2-Toxic has a higher spatial resolution in both the water and sediment. This higher resolution allows one to utilize this resolution if data sets related to a new contaminant of interest are well-populated.

Therefore, future enhancements of MICHTOX are not warranted.

PART 3

LEVEL 1 MODELS

Chapter 3. MICHTOX PCB Fate and Transport Modeling

MICHTOX is a toxic chemical mass balance and bioaccumulation model for Lake Michigan. The model was developed to simulate the transport and fate of polychlorinated biphenyls (PCBs) and other toxic chemicals in Lake Michigan, and it has served as the screening-level model in the United States Environmental Protection Agency (USEPA), Large Lakes Research Station's (LLRS) suite of PCB models.

MICHTOX contains both a fate and transport submodel and a food chain bioaccumulation submodel. The fate and transport submodel predicts water and sediment concentrations that are used as exposure concentrations by the food chain submodel.

MICHTOX was developed in the early 1990s to provide guidance for the Lake Michigan Lake-wide Management Plan (LaMP) and to assist with the planning of the Lake Michigan Mass Balance Project (LMMBP) (Endicott *et al.*, 2005). The model was later updated and used as a tool for a rapid, preliminary assessment of LMMBP PCB data (Endicott, 2005).

The focus of the MICHTOX modeling in the present study was to provide a screening-level evaluation of the effects of different loading scenarios on lake trout PCB concentrations, using the MICHTOX food chain submodel and the LMMBP data for organisms in the lake trout food chain. The organism data and descriptions of the scenarios are included in Chapter 4. For the present study, the same MICHTOX fate

and transport submodel parameterization was used as that used for the early LMMBP preliminary mass balance modeling assessment conducted by Endicott (2005). Loads were adjusted to reflect later findings of the LMMBP. This chapter summarizes this work to provide background for the food chain modeling assessments presented in Chapter 4. The MICHTOX modeling also provided an opportunity to compare an established, "off-the-shelf" model to the more complex Level 2 models developed during the LMMBP.

The following chapter contains a brief description of MICHTOX, a description of the data used in the modeling, a discussion of the hindcast model confirmation, a comparison of model results to the 1994-1995 data, and a discussion of the evaluation of uncertainty in the model results using Bayesian Monte Carlo (BMC) methods. A more complete description of the model, the hindcast confirmation, and the BMC evaluation can be found in Endicott *et al.* (2005) and Endicott (2005).

3.3.1 Description

MICHTOX was implemented using the USEPA WASP4 modeling framework (Ambrose *et al.*, 1988). The model was modified by the USEPA to run on Hewlett-Packard (HP) Alphas running Tru64 Unix. As part of the early LMMBP data assessment (Endicott, 2005), MICHTOX was revised to reflect updated information on the chemical properties of PCBs and fate processes. In addition to using the new PCB data, the following modifications or additions were made at that time: the water balance was corrected to maintain continuity for long model runs, the

boundary condition at the Straits of Mackinac was enhanced, the segment-specific atmospheric vapor concentrations were specified, and the chemical volatilization rate formulations and Henry's Law Constant parameterizations were updated. This is the version of the model used for the hindcast study described in Sections 3.3.3.1 and 3.3.3.2. For the most recent study discussed in Section 3.3.3.3 and Chapter 4, MICHTOX predictions were improved by updating atmospheric deposition PCB loadings and adding unmonitored tributary PCB loadings.

MICHTOX used differential equations and the concept of mass balance to solve for concentrations of contaminants, in this case PCBs, both temporally and spatially in the water column and sediments. Water movement, contaminant transport, and

contaminant fate processes were used in the model to track the mass of PCBs from sources (tributary and atmospheric) to sinks. The mass balance equation for PCBs included terms for loads to the system, advective transport, vertical and horizontal dispersive exchange, settling, resuspension, atmospheric deposition, vapor exchange with the atmosphere (volatilization and absorption), sediment water diffusion, and burial from the surficial sediment segments to deep sediment (Figure 3.3.1). Contaminant concentrations were accounted for both in their dissolved and particulate states. The complete coupled mass balance equations for the contaminant concentrations can be found in "1992 MICHTOX: A Mass Balance and Bioaccumulation Model for Toxic Chemicals in Lake Michigan" (Endicott *et al.*, 2005).

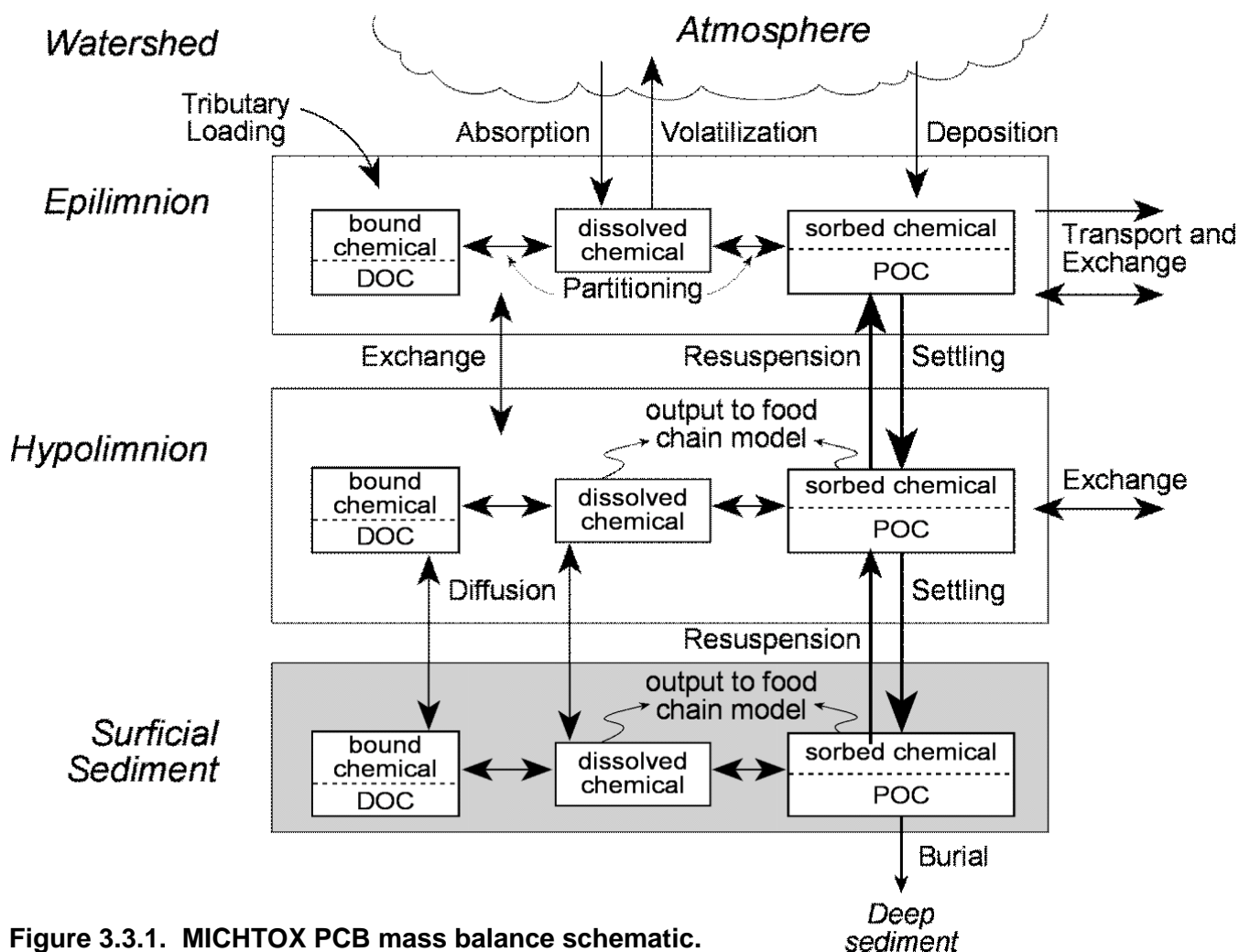

Figure 3.3.1. MICHTOX PCB mass balance schematic.

MICHTOX simulates total PCBs as the sum of two homologs (tetrachlorobiphenyl [PCB4] and pentachlorobiphenyl [PCB5]). Although this is technically incorrect (there are ten homologs), this representation of total PCBs as two PCB homologs was considered a reasonable compromise between pre-LMMBP loading and concentration data, mostly quantified as total PCBs or Aroclors, and congener-specific estimates available for physicochemical model parameters. Loads of total PCBs to the model were evenly divided between the two homologs.

MICHTOX model segmentation included both water column and surficial sediment segments. The water column segmentation included ten segments of varying geometry (Table 3.3.1), consisting of three epilimnetic segments in the main lake, three corresponding hypolimnetic segments in the main lake, three water column segments in Green Bay, and one segment for the lower Fox River (segment 4) that was not used for the LMMBP modeling (Figure 3.3.2). There were seven sediment segments; each corresponded to an epilimnetic/hypolimnetic segment in the water column. The Fox River sediment segment (segment 14), underlying the unused water column segment, was not used for the LMMBP modeling.

Table 3.3.1. MICHTOX Segment Geometry

Segment	Volume (m ³)	Depth (m)
1	2.61E+11	10
2	2.11E+11	10
3	7.49E+10	10
4	1.46E+07	2.22
5	2.23E+09	5.87
6	1.89E+10	13.3
7	4.61E+10	16.3
8	1.70E+12	65.3
9	2.27E+12	108
10	1.91E+11	25.5
11	5.81E+08	0.033
12	4.09E+08	0.033
13	4.95E+07	0.033
14	1.97E+05	0.10
15	7.60E+06	0.04
16	4.20E+07	0.04
17	3.51E+07	0.04

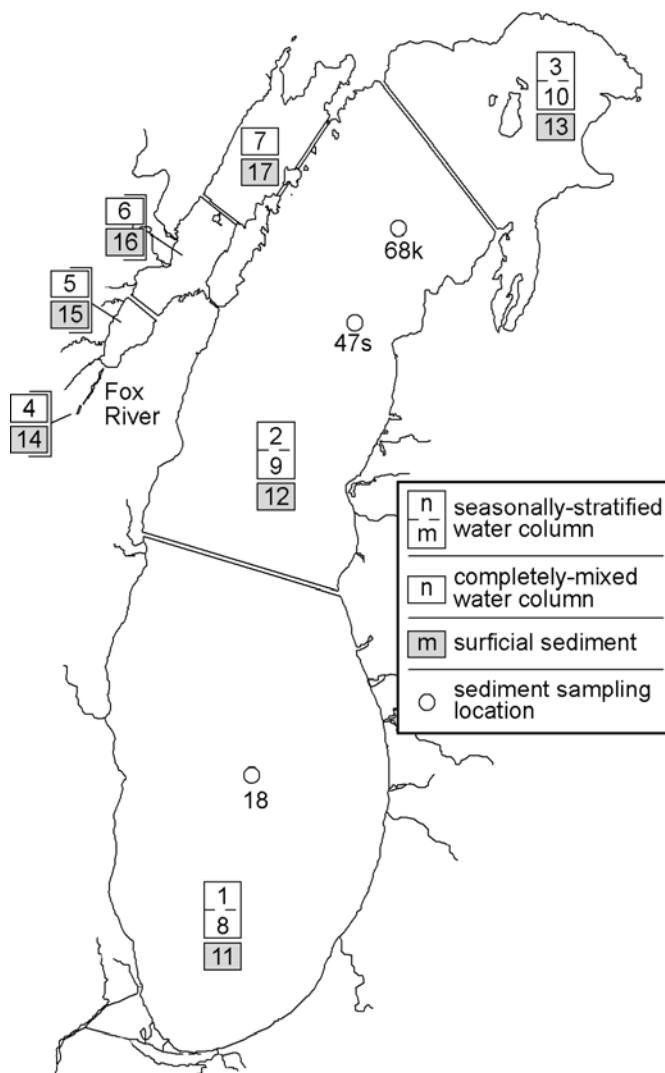

Figure 3.3.2. MICHTOX model segmentation.

The parameters used for all MICHTOX model runs are shown in Table 3.3.2. Volatilization rates were input as a monthly time series and were based on the Wanninkhoff (1992) formulation for water mass transfer resistance and the Schwarzenbach *et al.* (1993) formulation for gas mass transfer resistance. Henry's Law Constants were also input as a monthly time series as a function of average monthly surface water temperatures (Bamford *et al.*, 2000). Endicott (2005) contains a complete description of the revised gas exchange equations in MICHTOX.

Table 3.3.2. Model Parameters and Coefficients

Parameter	Value	Unit
Particle settling velocity	1.5	m/day
Pore water diffusion coefficient	1.8e-5	m ² /day
Monthly fraction organic carbon:		
for surface segments 1-7	0.127-0.290	
for deep segments 8-10	0.039-0.090	
for sediment segments 11-17	0.023-0.052	
Log(organic carbon partition coefficient)(K _{oc}):		
-PCB4	6.18	
-PCB5	6.46	
Monthly water temperatures	1.7-19.2	°C
Monthly temperature-dependent Henry's Law Constants		atm-m ³ /mol
-PCB4	1.2e-4 - 2.6e-4	
-PCB5	1.5e-4 - 3.2e-4	
Monthly volatilization rates:		m/day
-PCB4	0.55-1.72	
-PCB5	0.56-2.02	

3.3.2 Description of Data Used in MICHTOX

The following is a description of the data used in the MICHTOX PCB modeling for the LMMBP.

3.3.2.1 Water Column PCB Concentrations

Water-column total PCB concentrations (McCarty *et al.*, 2004) were averaged for each water column segment and cruise of the LMMBP using a volume-weighted averaging (VWA) procedure (Appendix 4.4.1). Dissolved (filtered) and particulate total PCB concentrations were averaged separately. Average dissolved total PCB concentrations are presented in Table 3.3.3, and particulate total PCB concentrations are presented in Table 3.3.4.

3.3.2.2 Surficial Sediment PCB Concentrations

Sediment total PCB concentrations were measured in 133 surficial sediment samples; 50 were collected

from the top 1 cm increment of box cores, and 65 were Ponar samples (McCarty *et al.*, 2004). All total PCB data were interpolated onto a uniform grid using a natural-neighbor algorithm and averaged for each MICHTOX surficial sediment segment (Appendix 4.4.1). Average total PCB concentrations were also calculated for the box core samples in each main lake sediment segment (Segments 11-13). Relatively few sediment samples were collected in Green Bay; therefore, surficial sediment total PCB concentrations from cores collected during the 1989-1990 Green Bay Mass Balance Project (GBMBP) (Manchester-Neesvig *et al.*, 1996) were used to calculate average concentrations in Green Bay sediment (Segments 15-17). Segment-specific average total PCB sediment concentrations are presented in Table 3.3.5. Model runs that started in 1994 used the segment-average box core data for initial conditions.

3.3.2.3 Atmospheric and Tributary Loads

Forcing functions used in MICHTOX consisted of atmospheric vapor concentrations, atmospheric (wet and dry) deposition, and tributary loads. The forcing functions developed for PCBs by the LMMBP were believed to be accurate estimates for the 1994-1995 period, based upon the data quality objectives and well-developed estimation procedures. Previous studies (Endicott *et al.*, 2005; Endicott, 2005), including the hindcast scenarios described below, used tributary loads from the major river systems. The present study, including the 1994-1995 model runs and the forecast scenarios, also included load estimates from unmonitored tributaries.

A number of sources were available to characterize trends of the usage and release of PCBs in the Great Lakes during the 20th Century, and these were used to extrapolate the LMMBP forcing functions both backward in time for estimates of historical loading trends (Endicott, 2005) and forward in time for model scenarios (the present study, Chapter 4). The total PCB forcing functions were based upon the LMMBP estimated long-term trends in PCB usage and loadings to and concentrations in Lake Michigan and the Great Lakes (McCarty *et al.*, 2004). Estimation of hindcast forcing functions is described in the next section, Section 3.3.3. Estimation of the forecast forcing functions is discussed in Chapter 4.

Table 3.3.3. Cruise and Segment-Specific Average Dissolved Total PCB Concentrations (ng/L)

Date	Segment 1	Segment 2	Segment 3	Segment 5	Segment 6	Segment 7	Segment 8	Segment 9	Segment 10
May 94	0.173	0.145	0.072	0.912	0.916	0.152	0.133	0.121	0.064
Jun 94	0.124	0.114	0.110				0.131	0.106	0.100
Aug 94	0.167	0.172	0.129	0.567	0.565	0.348	0.181	0.167	0.138
Oct 94	0.204	0.184	0.146	0.404	0.400	0.190	0.214	0.194	0.154
Jan 95	0.162	0.160	0.160						
Apr 95	0.196	0.169	0.141	0.478	0.473	0.261	0.173	0.150	0.137
Aug 95	0.216	0.183	0.189	0.234	0.234	0.234	0.270	0.221	0.210
Sep 95	0.244	0.172	0.127	0.253	0.253	0.142	0.254	0.176	0.138

Table 3.3.4. Cruise and Segment-Specific Average Particulate Total PCB Concentrations (ng/L)

Date	Segment 1	Segment 2	Segment 3	Segment 5	Segment 6	Segment 7	Segment 8	Segment 9	Segment 10
May 94	0.147	0.137	0.132	1.653	1.659	0.272	0.114	0.120	0.123
Jun 94	0.088	0.065	0.071				0.090	0.070	0.072
Aug 94	0.031	0.030	0.024	0.574	0.577	0.103	0.080	0.055	0.045
Oct 94	0.102	0.042	0.030	0.608	0.598	0.121	0.099	0.045	0.030
Jan 95	0.138	0.136	0.138						
Apr 95	0.099	0.084	0.075	0.805	0.789	0.245	0.089	0.073	0.071
Aug 95	0.046	0.026	0.025	0.048	0.050	0.064	0.111	0.058	0.050
Sep 95	0.036	0.023	0.020	0.572	0.571	0.126	0.052	0.026	0.025

Table 3.3.5. Segment-Specific Average Surficial Sediment Total PCB Concentrations (ng/g)

Segment	All LMMBP Sediment Samples	Surficial Samples From LMMBP Box Cores	Surficial Samples From GBMBP Box Cores
11	56.2	103	
12	35.2	63.4	
13	4.99	27.9	
15	17.1		695
16	127		643
17	52.9		97.3

3.3.3 Model Confirmation

A thorough recalibration of MICHTOX was not conducted after the enhancements were made to the model as part of the preliminary assessment modeling described in this chapter (Endicott, 2005). However, the model predictions were confirmed against data using two methods. Hindcast simulations were produced to confirm the suitability of and to establish confidence in MICHTOX model parameters and model predictions over a long-term model run. In addition, MICHTOX was run for the 1994-1995 LMMBP study period and model results were compared to the LMMBP data. This section contains discussion of the hindcast and comparison to the LMMBP data for both of the MICHTOX submodels.

3.3.3.1 Description of Hindcast Process

For the hindcast simulations developed by Endicott (2005), estimated long-term trends were used to develop the continuous total PCB forcing functions from an uncontaminated initial condition in 1940. Although somewhat speculative, a similar procedure was demonstrated for PCBs in Lake Ontario (Mackay, 1989; Gobas *et al.*, 1995). The hindcast forcing functions and model runs described in this section were developed early in the LMMBP, before the availability of the LMMBP sediment core data used to develop the more rigorous hindcast forcing functions (Part 1, Chapter 7) used for the LM2-Toxic hindcast (Part 4, Chapter 5).

The development of hindcast forcing functions required estimates of the date when contamination began, the rate of increase in the magnitude of the forcing function, the date and duration of the loading/forcing function peak, and the rate of decline in the magnitude of the forcing function. The assumptions were that PCB contamination of Lake Michigan commenced in 1940, the rate of increase in vapor concentrations and tributary loadings was the same as the rate of decline, atmospheric deposition loadings followed the same long-term trends as vapor concentrations, and monthly variability in the magnitude of forcing functions followed the 24-month pattern established by the LMMBP estimates.

Rates of change in vapor phase PCB concentrations for Lake Michigan and the Great Lakes region have

been published by a number of researchers (Hillery *et al.*, 1997, 1998; Baker and Eisenreich, 1990; Green *et al.*, 2000; Schneider *et al.*, 2001). Although there is some disagreement as to whether atmospheric measurements support the belief that vapor phase PCB concentrations are declining over Lake Michigan, Schneider *et al.* (2001) indicate that PCB concentration profiles in highly-resolved sediment cores from Grand Traverse Bay located in northeastern Lake Michigan support the view that vapor phase PCB concentrations have been declining at a rate of about 0.115/year, which corresponds to a six-year half-life, over the past 25 years.

Similarly, rates of change in PCB tributary loadings were determined from loading estimates based upon measurements for the Fox River in 1989-1990 (Velleux and Endicott, 1994) and from similar estimates for other Lake Michigan tributaries for 1982 (Marti and Armstrong, 1990) and 1994-1995 (McCarty *et al.*, 2004). This information yielded estimates for the rate of decline in tributary loadings of 0.053 to 0.054/year, corresponding to a 12- to 13-year half-life.

The date and duration of the peak in the PCB forcing function was not easily defined. Schneider *et al.* (2001) suggested that forcing functions peaked in 1972 and declined with the decline in chemical production after 1972 and a halt of production in 1977. On the other hand, Gobas *et al.* (1995) estimated that PCB loadings to Lake Ontario peaked in 1962. The reason for such a difference between the lakes is unclear and perhaps reflects the subjectivity of these estimates. Ultimately, three different estimates for long-term hindcast total PCB forcing functions were developed:

- Scenario A - Total PCB forcing functions peaked in 1970 and declined after 1972.
- Scenario B - Total PCB forcing functions peaked in 1961 and declined after 1963.
- Scenario C - Total PCB forcing functions peaked in 1961 and declined after 1972.

Plots of the three forcing function scenarios were provided on a whole-lake basis for vapor concentrations (Figure 3.3.3), atmospheric

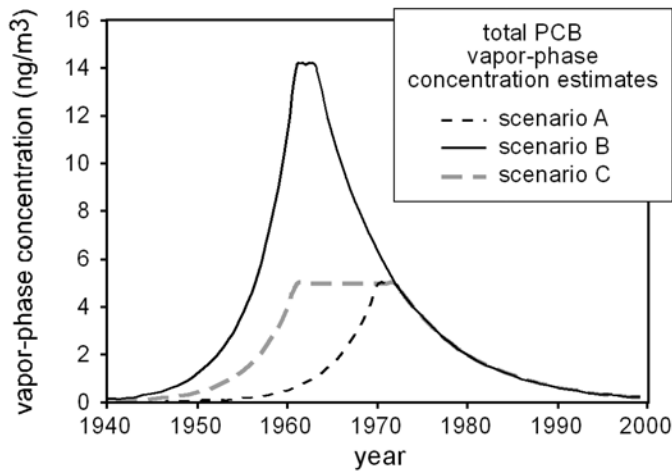

Figure 3.3.3. Long-term estimates of Lake Michigan total PCB vapor concentrations.

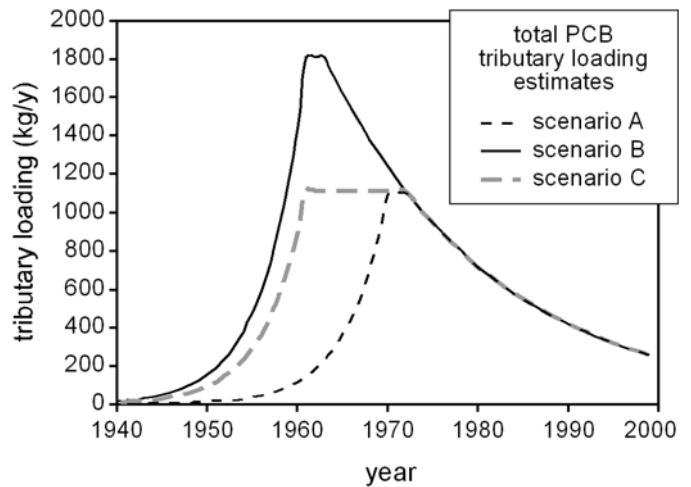

Figure 3.3.5. Long-term estimates of Lake Michigan total PCB tributary loadings.

deposition (Figure 3.3.4), and tributary loadings (Figure 3.3.5).

3.3.3.2 Hindcast Results

Hindcast simulations, commencing in 1940 from zero concentration (i.e., clean) initial conditions for total PCBs, were conducted for each of the three long-term forcing function scenarios (Endicott, 2005). The results of these simulations were compared to the LMMBP data (1994-1995) and long-term PCB concentration data with the goals of confirming parameters and determining which long-term loading scenario simulated the data most accurately.

Predictions for Scenario A were plotted and compared to available data in Figures 3.3.6-3.3.9. Predictions in the main Lake Michigan segments were compared to whole lake volume-weighted average water column concentrations in Figure 3.3.6. Clearly, the model predictions of total PCB concentrations in the water column were low for this scenario. Predicted surficial sediment total PCB concentrations were also low in comparison to the data (Figure 3.3.7) (see Figure 3.3.2 for sediment core locations). The same tendency of Scenario A to underpredict total PCBs concentrations occurred with

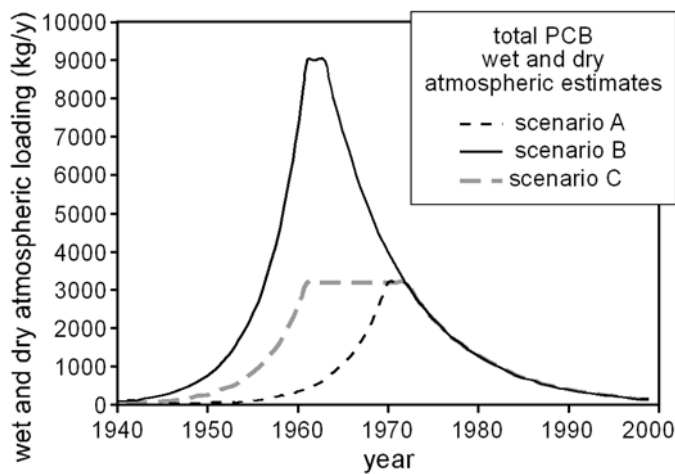

Figure 3.3.4. Long-term estimates of Lake Michigan total PCB atmospheric deposition loadings.

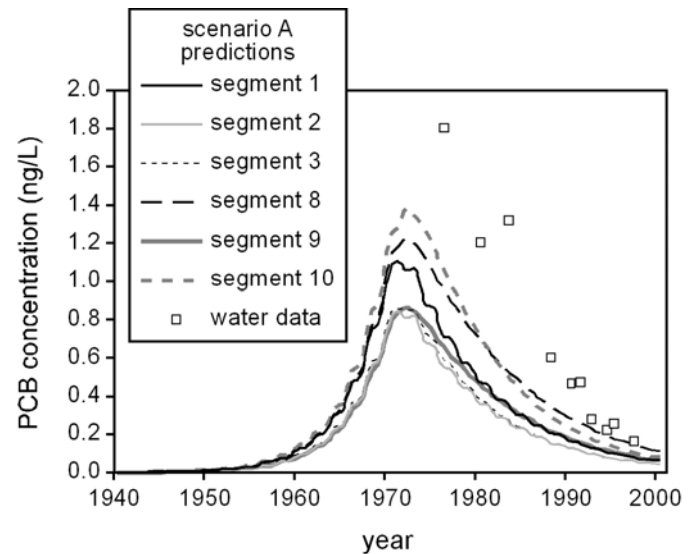

Figure 3.3.6. Long-term Scenario A predictions of main lake total PCB concentrations.

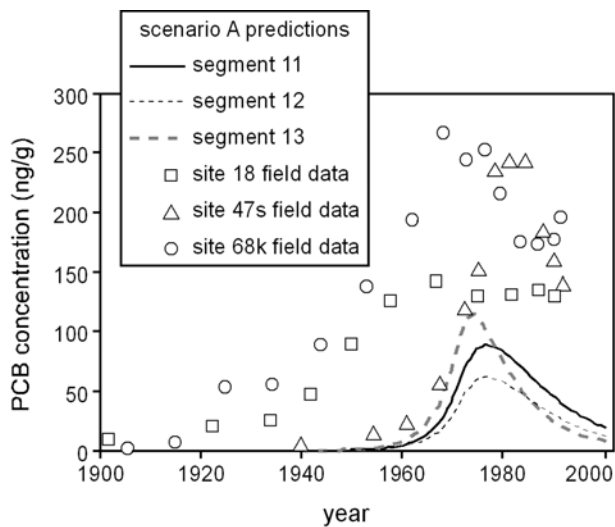

Figure 3.3.7. Comparison of long-term Scenario A predictions to main lake sediment total PCB concentrations (sediment cores collected in 1991-1992).

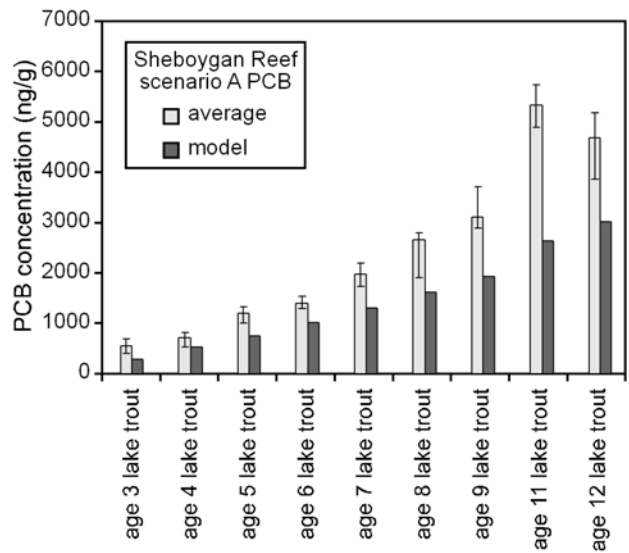

Figure 3.3.9. Comparison of MICHTOX Scenario A total PCB concentrations to Sheboygan Reef data.

demonstrated that the forage fish collected may have had significantly different contamination concentrations than the forage fish on the reef that the lake trout were feeding upon.

Predictions for Scenario B (PCB forcing functions assumed to peak in 1961-1963) were plotted and compared to data in Figures 3.3.10 to 3.3.15.

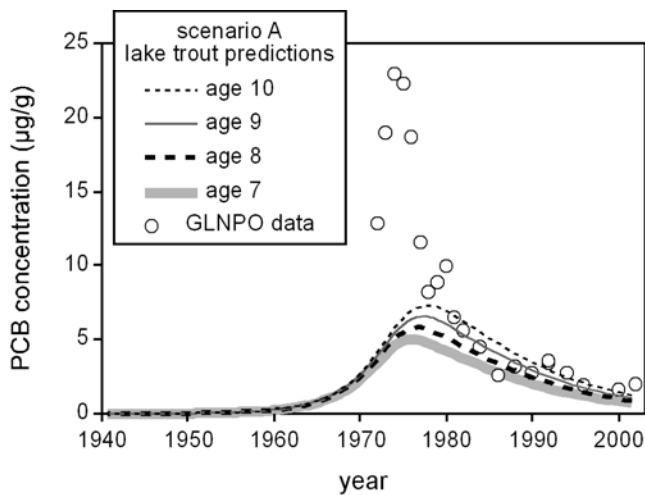

Figure 3.3.8. Comparison of long-term Scenario A predictions to GLNPO lake trout data.

the long-term fish data provided by the USEPA Great Lakes National Program Office (GLNPO) (DeVault *et al.*, 1996) (Figure 3.3.8) and the LMMBP age-class specific fish data (Figure 3.3.9). Model comparisons to LMMBP Sheboygan Reef fish data were limited to the lake trout data. Subsequent to the work summarized in this chapter, an analysis of the Sheboygan Reef forage fish data, which was not collected on the reef but closer to the shore,

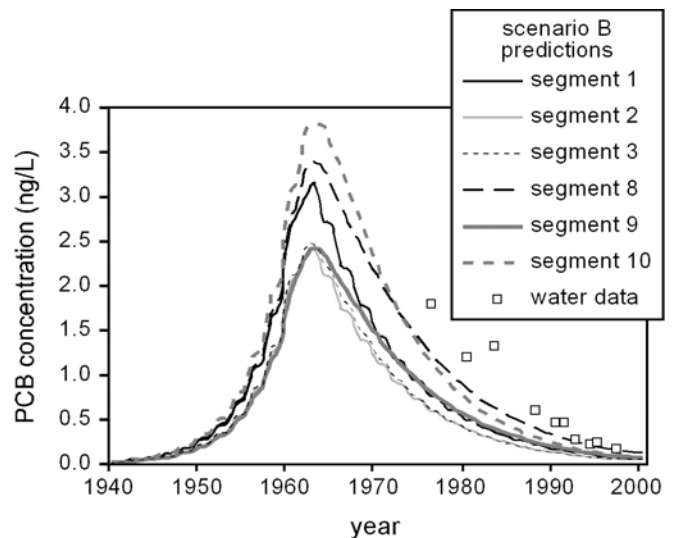

Figure 3.3.10. Long-term Scenario B predictions of main lake total PCB concentrations.

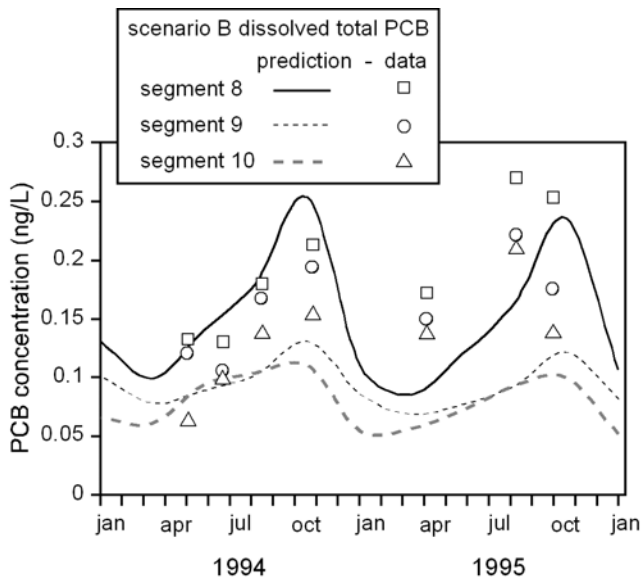

Figure 3.3.11. Comparison of long-term Scenario B predictions to the LMMBP deep water dissolved total PCB concentrations.

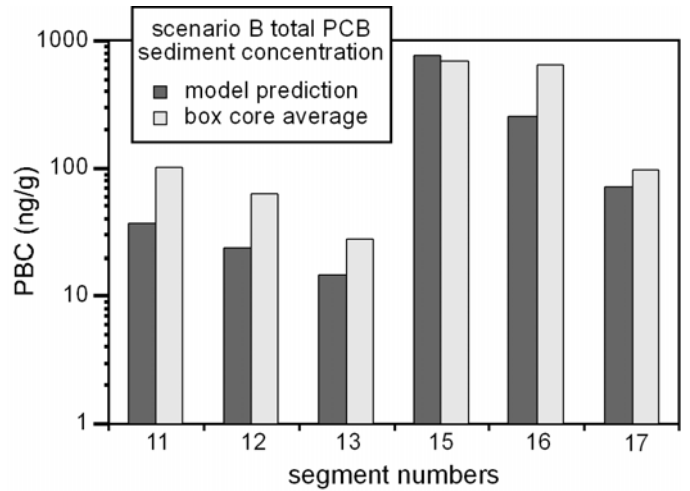

Figure 3.3.13. Comparison of long-term Scenario B predictions to average total PCB sediment concentrations (LMMBP and GBMBP box core samples).

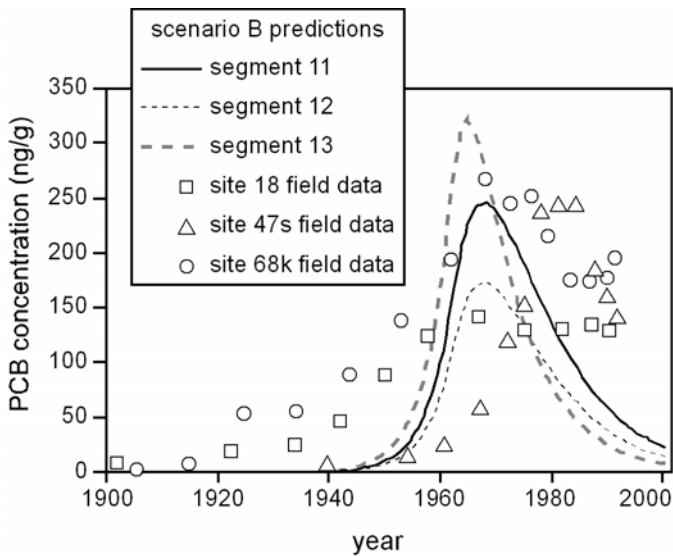

Figure 3.3.12. Comparison of Scenario B predictions to main lake sediment total PCB concentrations (sediment cores collected in 1991-1992).

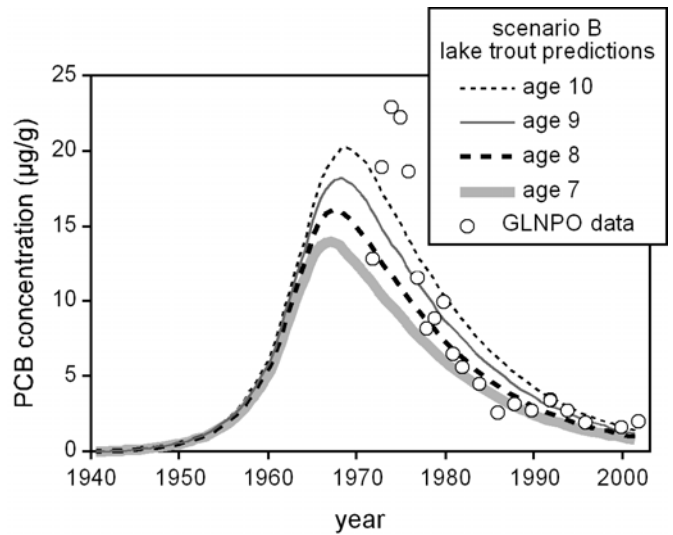

Figure 3.3.14. Comparison of long-term Scenario B predictions to GLNPO lake trout data.

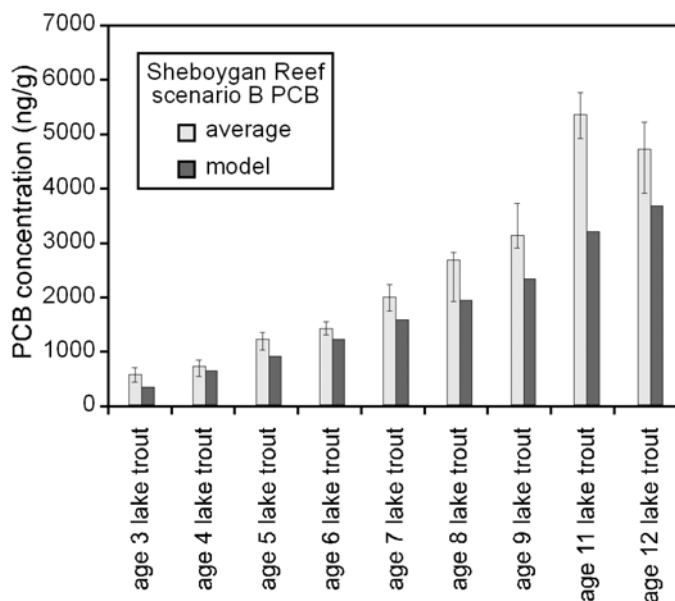

Figure 3.3.15. Comparison of long-term Scenario B total PCB concentrations to Sheboygan Reef fish data.

Predictions in the main Lake Michigan segments were compared to available water column measurements in Figure 3.3.10. Although still somewhat low, Scenario B predictions were definitely an improvement over Scenario A. Figure 3.3.11 compares the deep water (hypolimnetic) predicted dissolved total PCB concentrations to segment-average data for the eight LMMBP cruises. The model accurately predicted both the trend of decreasing dissolved total PCB concentrations moving from south-to-north in the lake as well as the build-up of deep water dissolved total PCB concentrations during the stratified period of each year. The accuracy of the deep water predictions was important for the present study because these were the exposure concentrations used in the MICHTOX food chain submodel.

Predicted surficial sediment total PCB concentrations for Scenario B were compared to dated sediment core concentrations in Figure 3.3.12. Comparisons of model predictions to present day average surficial sediment concentrations from LMMBP sediment box core samples are shown in Figure 3.3.13. Surficial sediment total PCB concentrations in southern and central Lake Michigan and in the middle of Green

Bay were about 60% lower compared to the data, while predicted sediment concentrations measured in other sediment segments were much closer to average data concentrations.

Scenario B predictions of total PCB concentrations in fish were compared to long-term data (DeVault *et al.*, 1996) (Figure 3.3.14) and the LMMBP age-class specific data for Sheboygan Reef (Figure 3.3.15). In general, this simulation compared well with both the long-term and the LMMBP data, although aspects of both simulations deserve comment. The Scenario B lake trout predictions agreed well with long-term data after the mid-1970s; however, the model predicted total PCB concentrations peaked about five years earlier than observed in the long-term data set. The lake trout total PCB predictions were also 20-30% lower than the data for most of the Sheboygan Reef age-class data.

Predictions for Scenario C were plotted and compared to field data in Figures 3.3.16-3.3.19. Although Scenario C forcing functions were substantially different, the predictions were qualitatively similar to those for Scenario B for the period during which data were available.

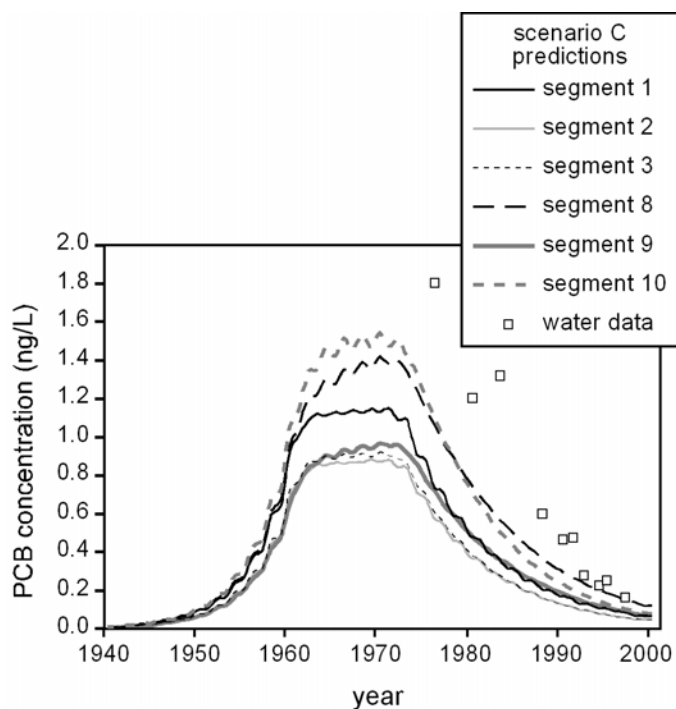

Figure 3.3.16. Long-term Scenario C predictions of main lake total PCB concentrations.

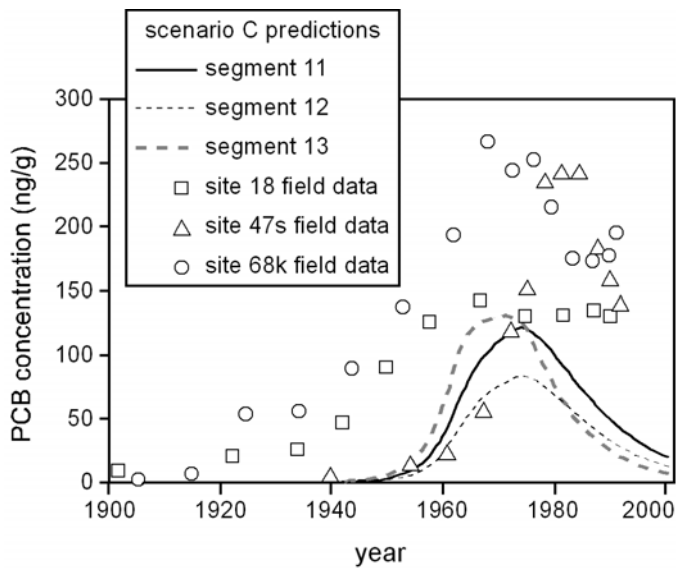

Figure 3.3.17. Comparison of Scenario C predictions to main lake sediment total PCB concentrations (sediment cores collected in 1991-1992).

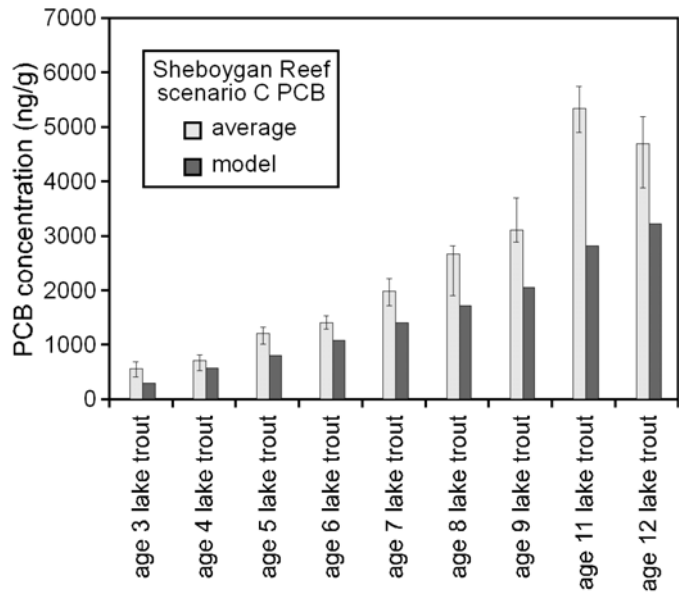

Figure 3.3.19. Comparison of MICHTOX Scenario C total PCB concentrations to Sheboygan Reef fish data.

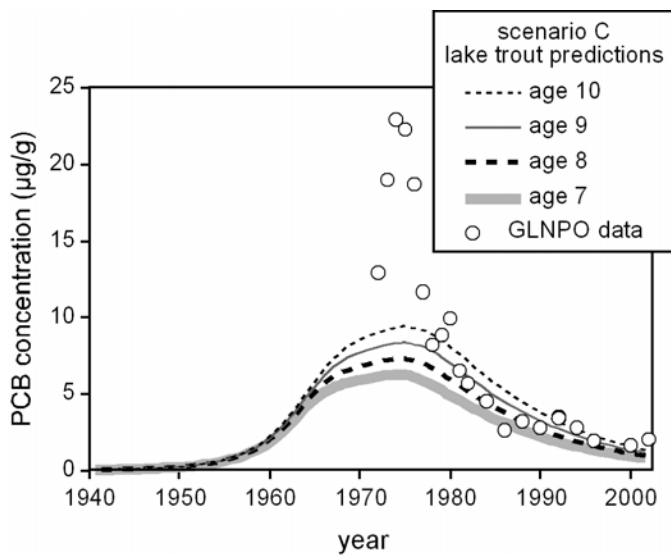

Figure 3.3.18. Comparison of long-term Scenario C predictions to GLNPO lake trout data.

In general, the Scenario B long-term simulations tend to agree most favorably with the available PCB data. The model predictions for this scenario were probably at least as accurate as the forcing functions themselves; this was judged to be an adequate level of model confirmation for this assessment. However, further refinement of forcing functions and model parameters could improve the agreement between data and predictions.

3.3.3.3 Comparison to the LMMBP Data

For the most recent study, MICHTOX simulations were conducted for the 1994-1995 LMMBP period as a check on model performance and in preparation for the forecast scenarios discussed in Part 3, Chapter 4.

The total PCB forcing functions used for this model run included both monitored and unmonitored tributary loads and the revised atmospheric deposition estimates. They were calculated following the same procedure used for the LM2-Toxic forcing functions described in Section 4.4.3.1 and Section 4.6.3. For comparison to model-predicted water column PCB concentrations, the LMMBP cruise sample data were extrapolated using the natural

neighbor method and aggregated to the MICHTOX water column segments (Appendix 4.4.1).

Differences between model predictions and sampling data concentrations were evident, although the differences were probably reasonable for a screening-level model application. Modeled total PCB concentrations for the main lake epilimnetic segments were consistently lower than observed data (Figure 3.3.20). Model-predicted main lake epilimnetic total PCB concentrations averaged over the 1994-1995 period were 30-40% lower than sample data average concentrations.

Predicted hypolimnetic PCB concentrations were important as these were passed to the MICHTOX food chain submodel as exposure concentrations. Modeled main lake hypolimnetic total PCB concentrations exhibited substantial seasonal variation, but the data showed little seasonal variation (Figure 3.3.21). While the baseline concentrations predicted by the model were in general agreement with the observed data, the seasonal peaks resulted in study-period averaged total PCB concentrations from the model being 50% higher in southern Lake Michigan, 7% higher in central Lake Michigan, and 25% higher in northern Lake Michigan.

The results of the model simulations for the 1994-1995 period were also interrogated in terms of total PCB mass transport fluxes and inventories (Figures 3.3.22-3.3.23). Mass balance diagnostics demonstrated that air-water fluxes clearly dominated the transport pathways for PCBs in Lake Michigan.

The net volatilization (gross volatilization minus gas absorption) of 3,078 kg/year was the most significant net gain or net loss to the system. Particulate settling and resuspension resulted in large amounts of PCBs cycling between the water column and sediments.

The general agreement between model and data, coupled with the hindcast simulation conducted in the Endicott (2005) study, confirmed the applicability of MICHTOX for screening-level modeling assessments of PCBs in Lake Michigan. A robust calibration of the model should be conducted if it is desired to use MICHTOX in a future management context. The results from this study suggested that important areas for future review included MICHTOX

parameterization related to partitioning, settling/resuspension, and volatilization/absorption.

Further confirmation of the model is presented in the following discussion of the MICHTOX food chain submodel, which uses the fate and transport submodel water-column and sediment PCB output as exposure concentrations.

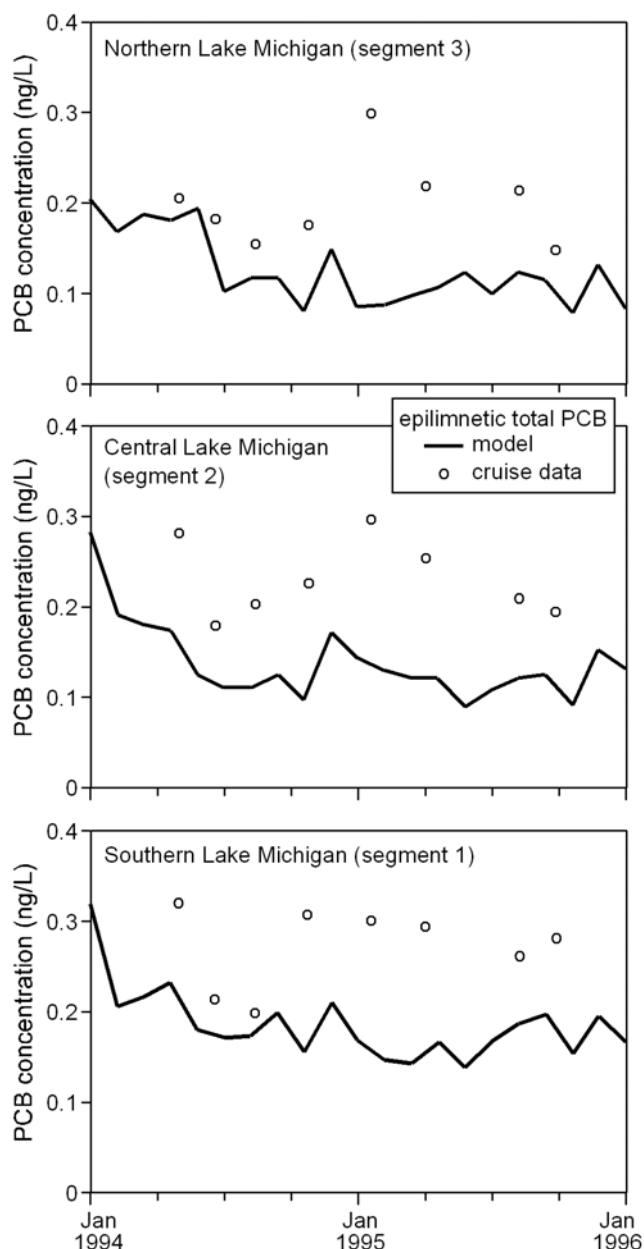

Figure 3.3.20. Comparison of MICHTOX epilimnetic total PCB concentrations to the LMMBP cruise data.

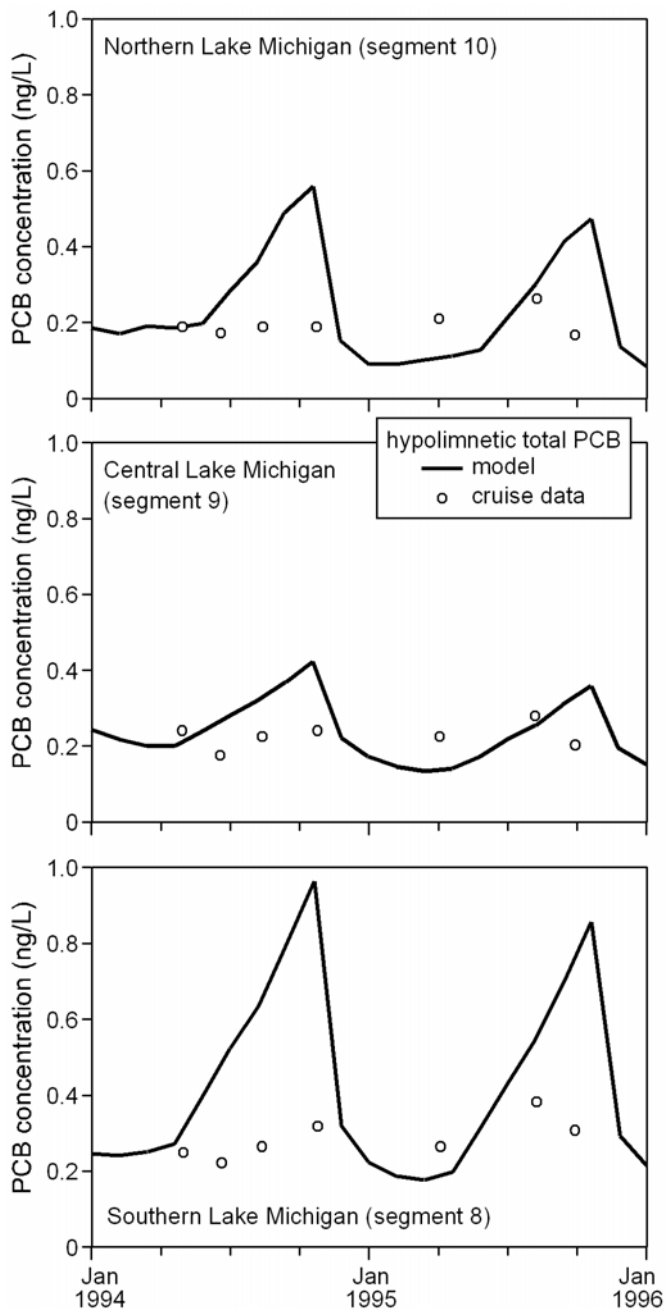

Figure 3.3.21. Comparison of MICTOX hypolimnetic total PCB concentrations to the LMMBP cruise data.

3.3.4 Model Uncertainty

Model predictions contain uncertainty for numerous reasons: conceptual errors and/or simplifications, errors in parameterization, uncharacterized system variability, and systematic errors in forcing functions and calibration data. Peer review and quality control

during model development reduced the errors associated with model conceptualization and coding. Errors associated with model parameterization and forcing functions can be examined through an uncertainty analysis.

Uncertainty in MICTOX model predictions had been examined through both conventional Monte Carlo analyses (Endicott *et al.*, 2005) and Bayesian Monte Carlo (BMC) analyses (Endicott, 2005). The uncertainty analyses were conducted on a steady-state version of the model because of run time limitations. Both analyses were conducted before the availability of the LMMBP data; however, the results should be representative. The BMC analyses indicated that total PCB concentrations should be well within a factor of two of model predictions (Endicott, 2005). It is possible that repeating the BMC analysis with the LMMBP data and forcing functions would result in smaller confidence intervals for prediction, and less uncertainty.

References

- Ambrose, R.B., T.A. Wool, J.P. Connolly, and R.W. Schanz. 1988. WASP4, a Hydrodynamic and Water Quality Model - Model Theory, User's Manual and Programmer's Guide. U.S. Environmental Protection Agency, Office of Research and Development, Environmental Research Laboratory, Athens, Georgia. EPA/600/3-87/039, 297 pp.
- Baker, J.E. and S.J. Eisenreich. 1990. Concentrations and Fluxes of Polycyclic Aromatic Hydrocarbons and Polychlorinated Biphenyls Across the Air-Water Interface of Lake Superior. *Environ. Sci. Technol.*, 24(3):342-352.
- Bamford, H.A., D.L. Poster, and J.E. Baker. 2000. Henry's Law Constants of Polychlorinated Biphenyl Congeners and Their Variation with Temperature. *J. Chem. Engin.*, 45:1069-1074.
- DeVault, D.S., R. Hesselberg, P.W. Rodgers, and T.J. Feist. 1996. Contaminant Trends in Lake Trout and Walleye From the Laurentian Great Lakes. *J. Great Lakes Res.*, 22(4):884-895.

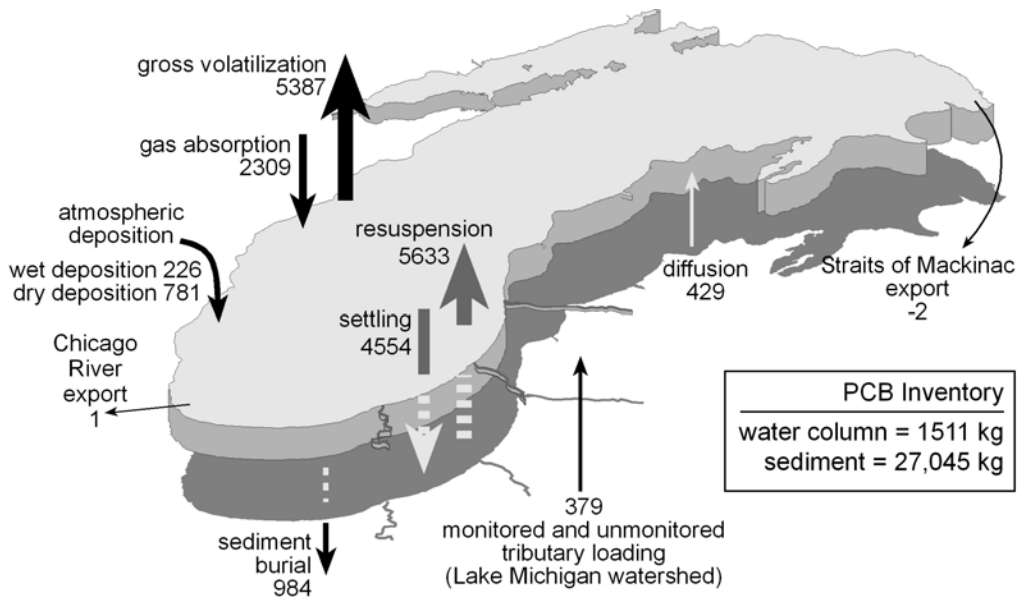

Figure 3.3.22. MICHTOX predicted mass balance fluxes and inventories (kg/year) for 1994-1995, whole lake results.

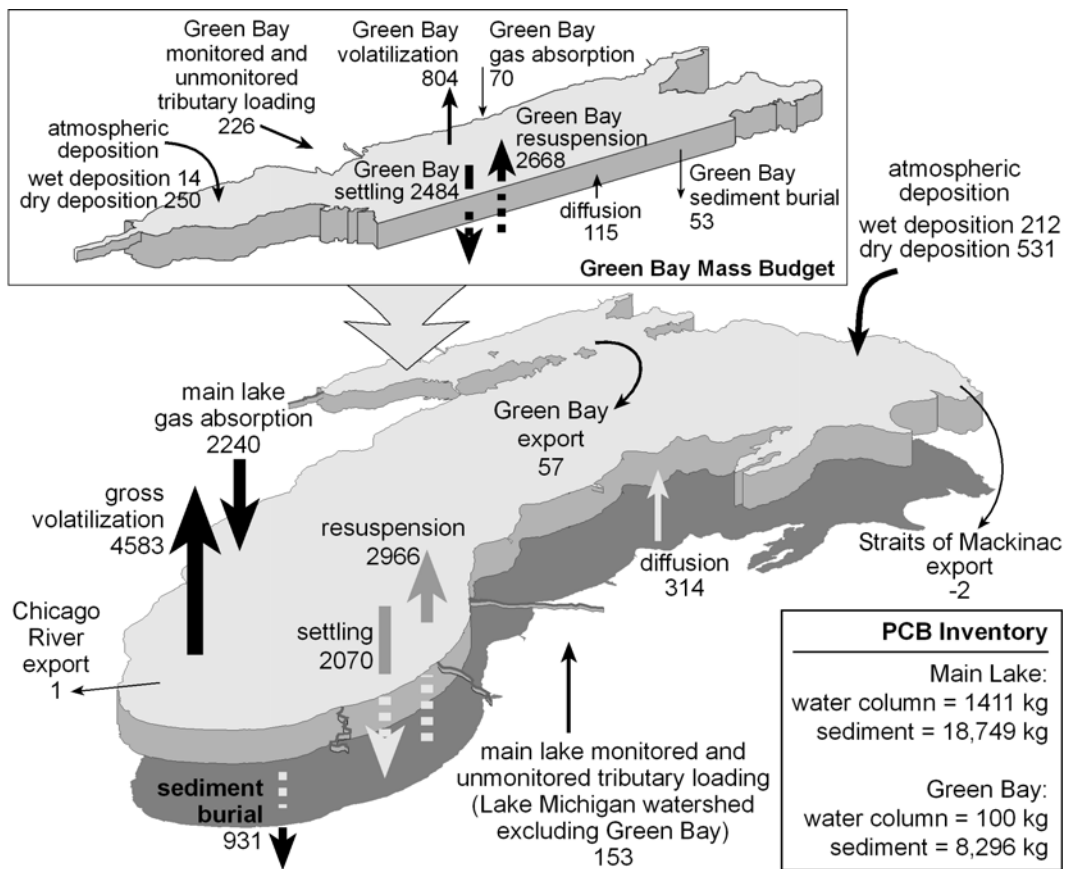

Figure 3.3.23. MICHTOX predicted mass balance fluxes and inventories (kg/year) for 1994-1995, Green Bay and main lake results.

-
- Endicott, D.D. 2005. 2002 Lake Michigan Mass Balance Project: Modeling Total Polychlorinated Biphenyls Using the MICHTOX Model. In: R. Rossmann (Ed.), MICHTOX: A Mass Balance and Bioaccumulation Model for Toxic Chemicals in Lake Michigan, Part 2. U.S. Environmental Protection Agency, Office of Research and Development, National Health and Environmental Effects Research Laboratory, MED-Duluth, Large Lakes Research Station, Grosse Ile, Michigan. EPA/600-R-05/158, 140 pp.
- Endicott, D.D., W.L. Richardson, and D.J. Kandt. 2005. 1992 MICHTOX: A Mass Balance and Bioaccumulation Model for Toxic Chemicals in Lake Michigan. In: R. Rossmann (Ed.), MICHTOX: A Mass Balance and Bioaccumulation Model for Toxic Chemicals in Lake Michigan, Part 1. U.S. Environmental Protection Agency, Office of Research and Development, National Health and Environmental Effects Research Laboratory, MED-Duluth, Large Lakes Research Station, Grosse Ile, Michigan. EPA/600-R-05/158, 140 pp.
- Gobas, F.A.P.C., M.N.Z. Graggen, and X. Zhang. 1995. Time Response of the Lake Ontario Ecosystem to Virtual Elimination of PCBs. *Environ. Sci. Technol.*, 29(8):2038-2046.
- Green, M.L., J.V. DePinto, C.W. Sweet, and K.C. Hornbuckle. 2000. Regional Spatial and Temporal Interpolation of Atmospheric PCBs: Interpretation of Lake Michigan Mass Balance Data. *Environ. Sci. Technol.*, 34(9):1833-1841.
- Hillery, B.L., I. Basu, C.W. Sweet, and R.A. Hites. 1997. Temporal and Spatial Trends in a Long-Term Study of Gas-phase PCB Concentrations Near the Great Lakes. *Environ. Sci. Technol.*, 31(6):1811-1816.
- Hillery, B.L., M.F. Simcik, I. Basu, R.M. Hoff, W.M.J. Strachan, D. Burniston, C.H. Chan, K.A. Brice, C.W. Sweet, and R.A. Hites. 1998. Atmospheric Deposition of Toxic Pollutants to the Great Lakes as Measured by the Integrated Atmospheric Deposition Network. *Environ. Sci. Technol.*, 32(15):2216-2221.
- Mackay, D. 1989. Modeling the Long-Term Behavior of an Organic Contaminant in a Large Lake: Application to PCBs in Lake Ontario. *J. Great Lakes Res.*, 15(2):283-297.
- Manchester-Neesvig, J.B, A.W. Andren, and D.N. Edgington. 1996. Patterns of Mass Sedimentation and of Deposition of Sediment Contaminated by PCBs in Green Bay. *J. Great Lakes Res.*, 22(2):444-462.
- Marti, E.A. and D.E. Armstrong. 1990. Polychlorinated Biphenyls in Lake Michigan Tributaries. *J. Great Lakes Res.*, 16(3):396-405.
- McCarty, H.B., J. Schofield, K. Miller, R.N. Brent, P. Van Hoff, and B. Eadie. 2004. Results of the Lake Michigan Mass Balance Study: Polychlorinated Biphenyls and *trans*-Nonachlor Data Report. U.S. Environmental Protection Agency, Great Lakes National Program Office, Chicago, Illinois. EPA/905/R-01/011, 289 pp.
- Schneider, A.R., H.M. Stapleton, J. Cornwell, and J.E. Baker. 2001. Recent Declines in PAH, PCB, and Toxaphene Levels in the Northern Great Lakes as Determined from High Resolution Sediment Cores. *Environ. Sci. Technol.*, 35(19):3809-3815.
- Schwarzenbach, R.P., P.M. Gschwend, and D.M. Imboden. 1993. *Environmental Organic Chemistry*. John Wiley and Sons, Incorporated, New York, New York. 681 pp.
- Velleux, M.L. and D. Endicott. 1994. Development of a Mass Balance Model for Estimating PCB Export from the Lower Fox River to Green Bay. *J. Great Lakes Res.*, 20(2):416-434.
- Wanninkhoff, R.J. 1992. Relationship Between Gas Exchange and Wind Speed Over the Ocean. *J. Geophys. Res.*, 97:7373-7381.

PART 3

LEVEL 1 MODELS

Chapter 4. MICTOX Food Chain Modeling

MICTOX is a toxic chemical mass balance and bioaccumulation model. The model was used at the beginning of the Lake Michigan Mass Balance Project (LMMBP) as a planning tool (Endicott *et al.*, 2005). After the LMMBP data were collected, the model provided preliminary mass balance modeling assessments for polychlorinated biphenyls (PCBs) in Lake Michigan (Endicott, 2005). For the present phase of the LMMBP, MICTOX was used to provide a screening-level analysis of the effects of various pollutant loading sources on bioaccumulation in Lake Michigan lake trout, and to predict the length of time until PCB concentrations in lake trout declined below health advisory target levels under different forecast scenarios. Chapter 4 discusses this aspect of the MICTOX application. MICTOX also provided a comparison of an established “off-the-shelf” model to the more complex Level 2 models developed during the LMMBP.

MICTOX contains both a fate and transport submodel and a food chain bioaccumulation submodel. This chapter provides information on the application of the MICTOX food chain bioaccumulation submodel to Lake Michigan. The food chain submodel is briefly described, with a complete description included in Endicott *et al.* (2005). The model coefficients and data are also briefly described. The remainder of the chapter includes a discussion of seven model scenarios that were conducted as a screening-level assessment of the fate and sources of PCBs in the system, as a preliminary evaluation of the potential range of future

PCB concentrations in Lake Michigan under different possible loading scenarios, and for a comparison to predictions of the Level 2 models.

3.4.1 Model Development

MICTOX was originally developed in the early 1990s as a screening model for the Lake Michigan Lake-wide Management Plan (LaMP) and for development of the LMMBP (Endicott *et al.*, 2005). The model was later updated with newer process formulations, parameters, and the LMMBP data (Endicott, 2005), as described in Part 3, Chapter 3.

The screening-level food chain bioaccumulation modeling for Part 3 was completed using the food chain submodel of MICTOX. This submodel was essentially unchanged from the original version (Endicott *et al.*, 2005), except for adaptations to the program code to accommodate 62-year model runs for the forecast modeling.

The MICTOX food chain bioaccumulation submodel was adapted from version 3.20 of the Manhattan College Food Chain Model, which was based upon the WASTOXv4 food chain model (Connolly and Thomann, 1985; Connolly, 1991). It used the time-variable water column dissolved and particulate PCB concentrations output from the MICTOX fate and transport submodel as the PCB exposure concentrations for the trophic levels of the food chain. The MICTOX food chain submodel was applied separately to paired water column and sediment segment output from the fate and transport submodel for each area of interest. As with the fate and transport submodel, the food chain submodel

simulated total PCBs as the sum of two homologs: tetrachlorobiphenyl (PCB4) and pentachlorobiphenyl (PCB5).

MICHTOX treats bioaccumulation as a chemical mass balance within individual organisms, and a bioaccumulation differential equation was solved for each individual age class of organism (Equation 3.4.1) (Endicott *et al.*, 2005):

$$\frac{dv_i}{dt} = k_{ui} c f_d + \sum_{j=1}^n p_{ij} \alpha_{ij} C_{ij} v_j - K'_i v_i \quad (3.4.1)$$

where

i = the organism of interest

j = the prey organism

v_i = chemical concentration in organism *i* ($M_{\text{chem}}/M_{\text{wet}}$)

k_{ui} = uptake rate ($L^3/T/M_{\text{wet}}$)

c = chemical concentration in water (M/L^3)

f_d = dissolved chemical fraction in the water column

p_{ij} = feeding preference factor $\sum_{j=1}^n (p_{ij} = 1)$ of organism *i* for organism *j*

α_{ij} = chemical assimilation efficiency across gut

C_{ij} = food consumption rate ($M_{\text{prey,wet}}/M_{\text{pred,wet}}$)

K'_i = chemical elimination rate (1/T)

In general, PCB concentrations in an organism was equal to the sum of the PCB uptake from water (across the gill) and from consumption minus the PCB concentrations lost through elimination (excretion and dilution through growth). Equations for the consumption rate, PCB uptake rate, and PCB excretion rate are fully described in "1992 MICHTOX: A Mass Balance and Bioaccumulation Model for Toxic Chemicals in Lake Michigan" (Endicott, 2005).

For phytoplankton, PCB accumulation was assumed to be a partitioning process, assuming 2% organic

carbon composition on a wet weight basis. The PCB concentrations in detritus, the food source for benthic organisms, was assumed to be equal to that of the surficial sediment.

3.4.2 Description of the Data Used in MICHTOX Food Chain

3.4.2.1 Description of Data

Fish and lower food chain organism data used for MICHTOX modeling were collected in three biota zones (Figure 3.4.1) (McCarty *et al.*, 2004). The biota zones were geographical areas on the lake chosen to compare and contrast the fish population characteristics in different regions of Lake Michigan.

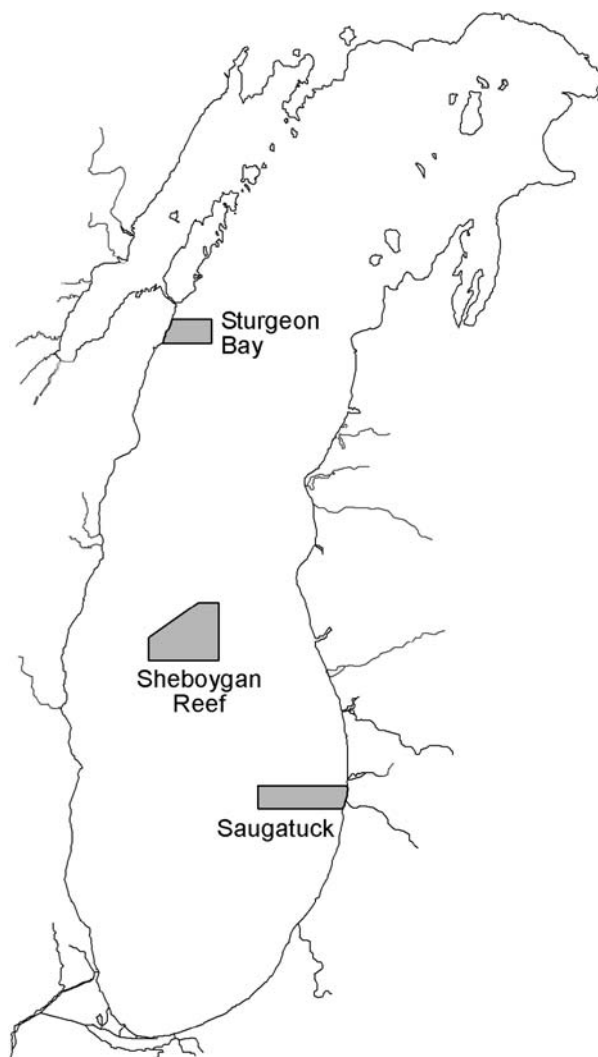

Figure 3.4.1. The LMMBP biota sampling zones.

The Saugatuck biota zone is located on the eastern side of Lake Michigan (MICHTOX water column segments 1 and 8). The Sturgeon Bay biota zone is located east of the Door Peninsula (MICHTOX water column segments 2 and 9). The Sheboygan Reef biota zone in southern Lake Michigan is located just south of the segment partition between MICHTOX water column segments 1 and 2. The Sheboygan Reef data are only shown for information purposes. Because forage fish were collected in a substantially different location than the lake trout at this site and were possibly not representative of prey items on the reef, the Sheboygan Reef data were not used for model confirmation. Tables 3.4.1, 3.4.2, and 3.4.3 show the biota data for their respective zones. In the higher trophic levels, it can be seen that Saugatuck organisms had a consistently higher amount of total PCB concentrations than organisms at other locations (Figure 3.4.2).

The representation of the Lake Michigan food chain in the MICHTOX food chain modeling included five organisms: phytoplankton, *Mysis*, *Diporeia*, alewife, and lake trout.

3.4.2.2 Sources and Choice of Constants

For the most recent study, LMMBP data were used to update alewife growth rates and biota zone-specific lipid concentrations. In addition, biota zone-specific growth rates and biota zone-specific lipid concentrations were used for lake trout. The age- and species-specific weight, growth rate, and lipid concentrations for all organisms are shown in Table 3.4.4. Table 3.4.5 includes the food assimilation efficiencies and the chemical assimilation coefficients for the organisms and PCB homologs used in the MICHTOX food chain model.

3.4.3 Model Confirmation

In previous work with the MICHTOX model and the LMMBP data (Endicott, 2005), a hindcast confirmation of the MICHTOX fate and transport submodel and the food chain submodel was conducted to establish confidence in the model and model parameters. The hindcast simulations of both submodels were discussed in Part 3, Chapter 3.3. The food chain organism weights, specific growth rates, and lipid concentrations were subsequently

Table 3.4.1. Average Total PCB Concentrations in Fish in the Saugatuck Biota Zone

Species	Age (Years)	Average PCB Concentrations (ng/g)	PCB Standard Deviation (ng/g)
Alewife < 120 mm	1-2	304	167
Alewife > 120 mm	3-7	592	140
Lake Trout	1	175	
Lake Trout	2	904	171
Lake Trout	3	883	288
Lake Trout	4	1287	241
Lake Trout	5	2068	532
Lake Trout	6	3185	1126
Lake Trout	7	3609	809
Lake Trout	8	4511	921
Lake Trout	9	5728	1645
Lake Trout	10	8209	4101
Lake Trout	11	7477	2515
Lake Trout	12	8116	2997
Lake Trout	13	6666	872
Lake Trout	14	6799	794
Lake Trout	15	4014	3268

Table 3.4.2. Average Total PCB Concentrations in Fish in the Sheboygan Reef Biota Zone

Species	Age (Years)	Average PCB Concentrations (ng/g)	PCB Standard Deviation (ng/g)
Lake Trout	3	547	184
Lake Trout	4	706	217
Lake Trout	5	1202	204
Lake Trout	6	1395	192
Lake Trout	7	1974	320
Lake Trout	8	2668	1001
Lake Trout	9	3102	1022
Lake Trout	11	5322	1215
Lake Trout	12	4692	1234
Lake Trout	13	4466	217
Lake Trout	14	3483	

Table 3.4.3. Average Total PCB Concentrations in Fish in the Sturgeon Bay Biota Zone

Species	Age (Years)	Average PCB Concentrations (ng/g)	PCB Standard Deviation (ng/g)
Alewife < 120 mm	1-2	170	71
Alewife > 120 mm	3-7	589	171
Lake Trout	1	350	163
Lake Trout	2	395	107
Lake Trout	3	889	159
Lake Trout	4	1268	270
Lake Trout	5	1707	309
Lake Trout	6	2487	577
Lake Trout	7	2656	509
Lake Trout	8	3360	559
Lake Trout	9	4211	757
Lake Trout	10	5283	1168
Lake Trout	11	5939	1543
Lake Trout	12	4420	1185
Lake Trout	13	4324	438
Lake Trout	14	5254	1345
Lake Trout	15	7192	683

Table 3.4.4. MICHTOX Food Chain Age- and Species-Specific Weight, Growth Rate, and Lipid Concentrations

MYSIS			
Age	Weight (g)	Growth Rate (1/day)	Lipid %
1	0.00021	0.0193	4
2	0.0022	0.0107	4
3	0.00811	0.0073	4
4	0.01977	0.0056	4

DIPOREIA			
Age	Weight (g)	Growth Rate (1/day)	Lipid %
1	0.00007	0.00398	3
2	0.00300	0.00203	3
3	0.00630	0.00313	3

ALEWIFE					
Age	Weight (g)	Growth Rate (1/day)	Average Lipid % Sheboygan Reef	Average Lipid % Saugatuck	Average Lipid % Sturgeon Bay
1	3	0.00441	7.2	5.5	4
2	15	0.00161	8.5	5.5	6
3	27	0.00086	9.0	6.0	6
4	37	0.00054	10.5	7.5	6
5	45	0.00029	11.5	9.0	6
6	50	0.00016	12.0	10.0	6
7	53	0.00010	12.2	11.0	6

STOCKED TROUT									
Age	Weight (g) Sheboygan Reef	Growth Rate (1/day) Sheboygan Reef	Lipid % Sheboygan Reef	Weight (g) Saugatuck	Growth Rate (1/day) Saugatuck	Lipid % Saugatuck	Weight (g) Sturgeon Bay	Growth Rate (1/day) Sturgeon Bay	Lipid % Sturgeon Bay
1	20	0.005082	2.30	90	0.001898	2.30	98	0.000554	4.80
2	128	0.001766	3.66	180	0.003058	3.66	120	0.002931	4.68
3	244	0.001909	7.90	550	0.001898	7.13	350	0.002263	9.21
4	490	0.001665	9.36	1100	0.001704	9.52	800	0.001721	11.81
5	900	0.001166	12.48	2050	0.000902	14.77	1500	0.001609	17.04
6	1378	0.000879	15.56	2850	0.000483	18.96	2700	0.000465	18.30
7	1900	0.000859	18.60	3400	0.000445	21.05	3200	0.000397	19.13
8	2600	0.000734	19.36	4000	0.000322	18.56	3700	0.000474	20.52
9	3400	0.000445	19.34	4500	0.000499	19.12	4400	0.000350	20.15
10	4000	0.000261	19.10	5400	0.000508	20.68	5000	0.000261	22.63
11	4400	0.000181	20.73	6500	0.000164	22.00	5500	0.000049	22.50
12	4700	0.000114	22.40	6900	0.000078	23.00	5600	0.000096	20.53

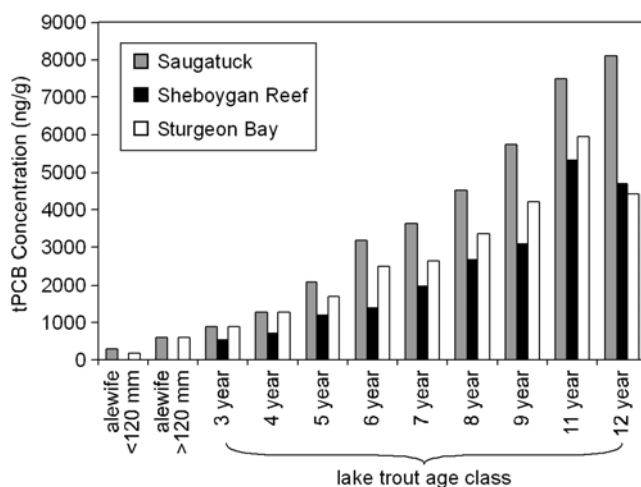

Figure 3.4.2. Total PCB concentrations of organisms in Lake Michigan biota zones.

Table 3.4.5. MICHTOX Food Chain Model Parameters and Coefficients

Parameter	Value (Unitless)
<i>Mysis</i> Assimilation of Ingested Food	0.400
<i>Diporeia</i> Assimilation of Ingested Food	0.0288
Alewife Assimilation of Ingested Food	0.800
Stocked Lake Trout Assimilation of Ingested Food	0.800
<i>Mysis</i> Chemical Assimilation (PCB4)	0.800
<i>Diporeia</i> Chemical Assimilation (PCB4)	0.405
Alewife Chemical Assimilation (PCB4)	0.800
Stocked Lake Trout Chemical Assimilation (PCB4)	0.600
<i>Mysis</i> Chemical Assimilation (PCB5)	0.575
<i>Diporeia</i> Chemical Assimilation (PCB5)	0.165
Alewife Chemical Assimilation (PCB5)	0.575
Stocked Lake Trout Chemical Assimilation (PCB5)	0.600

updated as described in Section 3.4.2. Estimates of unmonitored tributary PCB loads were also added. The hindcast model runs were repeated with the new food chain parameterization, and the results were again in general agreement with the available data.

While previous applications of MICHTOX used hindcast model runs to confirm model performance and evaluate past loading (Endicott *et al.*, 2005; Endicott, 2005), the most recent application of the model focused on forecast model runs. For the latest study, the model performance representing Lake Michigan food chain PCB dynamics was confirmed by comparing forecast model predictions to lake trout data collected from the Saugatuck biota zone. The

forecast confirmation model run was compared against the same Saugatuck biota zone historical lake trout data (1970 to 2002) as the hindcast runs previously described (DeVault *et al.*, 1996; Swackhamer, 2003). For these studies, lake trout were collected in a specific size range with an average weight of 2,600 grams, which is approximately the average weight of the five year-old and six year-old lake trout at Saugatuck (Table 3.4.4) collected during the LMMBP. The average of the five year-old and six year-old lake trout will be referred to as “5.5 year-old” lake trout. The MICHTOX model was set up with Constant Conditions for the 1994-2050 time frame: vapor concentrations, tributary loadings, and atmospheric

loads were repeated from those measured during 1994-1995. The original food chain model coefficients were found to give an acceptable fit between model and the 5.5 year-old lake trout total PCB data (Figure 3.4.3). Chemical assimilation efficiencies were adjusted to see if a better fit could be obtained, but no substantial improvement was obtained.

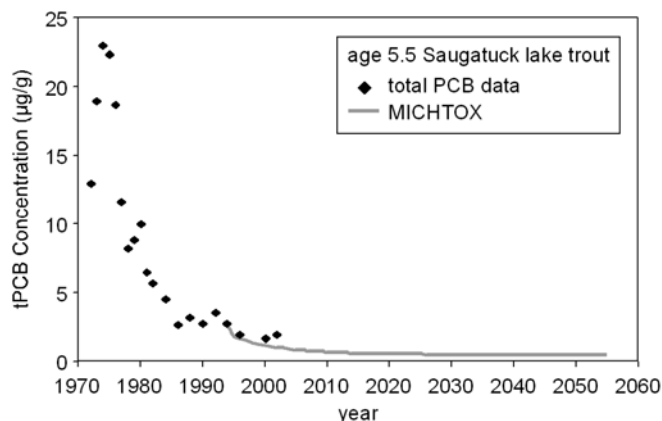

Figure 3.4.3. Total PCB concentrations in 5.5 year-old lake trout at Saugatuck biota zone.

3.4.4 Results – Forecast Scenarios

The ability to forecast future pollutant concentrations based upon changes in pollutant loadings is one of the most useful capabilities of models. MICHTOX was used to forecast the reduction in total PCB concentrations in the Lake Michigan food chain, especially those trophic levels that would impact human health risk by consumption such as lake trout.

The forecast simulations in Sections 3.4.4 and 3.4.5 were run for 62 years, from January 1, 1994 through December 31, 2055. Measured LMMBP PCB concentrations were used to define initial conditions in water, sediment, and fish (McCarty *et al.*, 2004). All simulations used the 1994-1995 forcing functions for the first two years of the model run. The forcing functions were determined from measured values of the LMMBP and included atmospheric vapor concentration, wet and dry atmospheric deposition loads, and monitored and unmonitored tributary loads. These forcing functions were the same as those used in the MICHTOX model run for Section 3.3.3.3 and were calculated in the same manner as the congener-specific functions of the LM2-Toxic

model. The calculation procedures are described in Sections 4.4.3.1 and 4.6.3. After January 1, 1996, forcing functions were varied according to the specified conditions of the forecast scenario.

The scenario results were evaluated against a fish advisory consumption guideline target level for the total PCB body burden in lake trout. The Protocol for a Uniform Great Lakes Sport Fish Consumption Advisory (Great Lakes Sport Fish Advisory Task Force, 1993) derived a target concentration in the edible portion of lake trout of 0.05 ppm. For comparison to the LMMBP model output, this value was converted to a whole fish concentration of 0.075 µg total PCBs/g fish (Appendix 3.4.1). Model output for the average of five and six year-old lake trout (“5.5 year-old fish”) was selected for evaluation against the target level to be consistent with the size range of fish in the long-term data set (DeVault *et al.*, 1996).

In this section, MICHTOX was applied to three loading scenarios. The first scenario assumed constant loads at the 1994-1995 level. The second and third scenarios had decreasing loads based upon decline rates observed in the literature. The results of the scenario simulations for Saugatuck are displayed in Figures 3.4.4a and 3.4.4b, and the Sturgeon Bay results are displayed in Figures 3.4.5a and 3.4.5b. The figures include an expanded concentration scale to allow a comparison of predicted total PCB concentrations to the 0.075 µg total PCBs/g fish consumption advisory target concentration. While the model results are referenced to data from the Saugatuck and Sturgeon Bay biota zones, MICHTOX has relatively coarse segmentation and the model results only represent the southern and middle sections of Lake Michigan.

3.4.4.1 Conditions Remain the Same as 1994-1995 (Constant Conditions)

For this scenario, 1994-1995 forcing functions (tributary loads, atmospheric deposition loads, and atmospheric vapor concentrations) were assumed to remain constant from January 1, 1994 through December 31, 2055. The two-year cycle of forcing functions was repeated for the entire 62-year period of the scenario. This scenario provides insight into the equilibrium status of the system to the 1994-1995 conditions, but it likely overestimates future

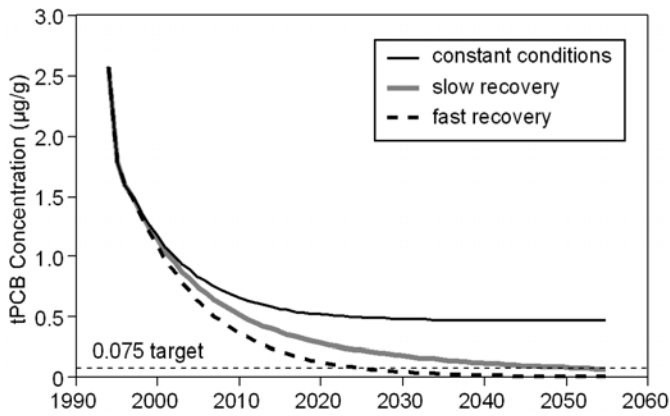

Figure 3.4.4a. Sensitivity scenario predicted total PCB concentrations in 5.5 year-old lake trout from Saugatuck biota zone.

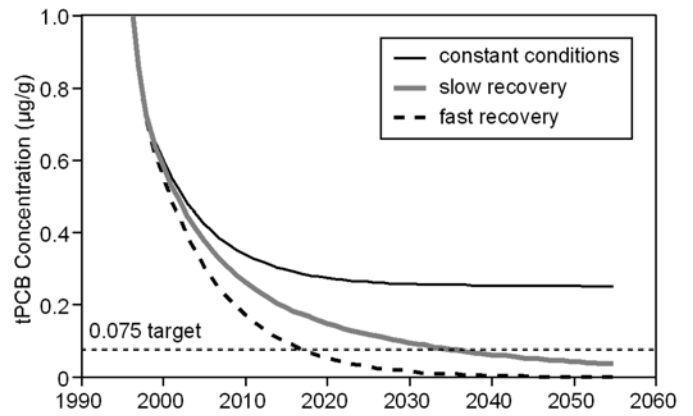

Figure 3.4.5b. Application scenario total PCB predictions and the fish consumption target level.

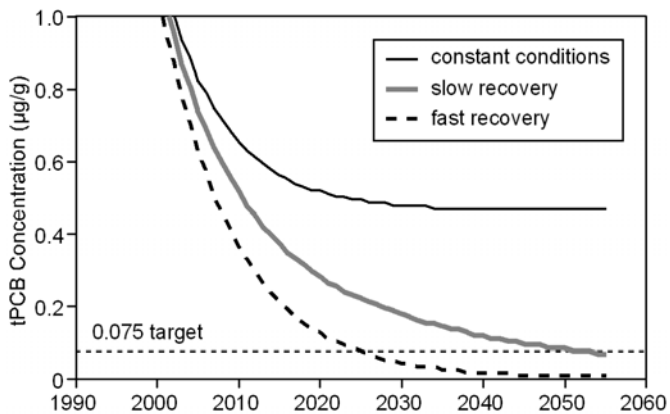

Figure 3.4.4b. Sensitivity scenario total PCB predictions and the fish consumption target level.

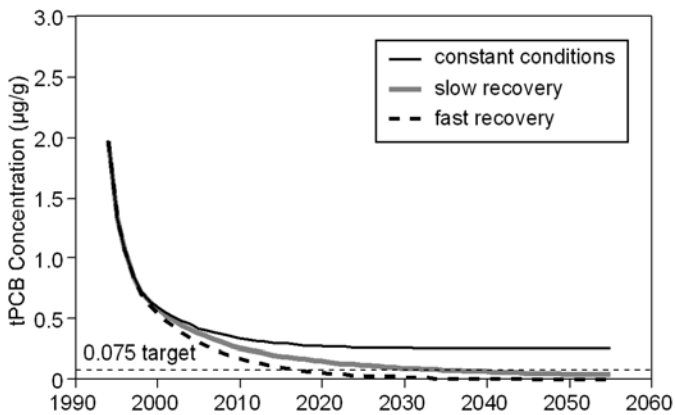

Figure 3.4.5a. Model application scenario total PCB predictions in 5.5 year-old lake trout from the Saugatuck biota zone.

concentrations because current declining trends of forcing functions resulting from historical clean-up efforts were not taken into account.

The 5.5 year-old lake trout total PCB concentrations decreased until reaching approximate steady-state concentrations of 0.47 µg/g at Saugatuck and 0.25 µg/g at Sturgeon Bay (Figures 3.4.4a and 3.4.5a) in roughly 40 years. The initial decline in lake trout concentrations suggests that the 1994-1995 state of the Lake Michigan system was not in equilibrium with previous PCB reduction efforts. Total PCB concentrations in 5.5 year-old lake trout at both sites were significantly above the 0.075 µg total PCBs/g fish consumption advisory target (Figure 3.4.4b and 3.4.5b), and reductions in 1994-1995 loads and concentrations would be necessary to achieve the target fish concentrations.

3.4.4.2 Continued Recovery – Fast

This scenario simulated total PCB concentrations in lake trout as the system responded to declines in PCB loads and atmospheric concentrations. This scenario assumed that the faster of the observed decline rates of PCB loadings (Section 1.7.2) will continue for the entire 62-year simulation period. Forcing functions were assumed to decrease from 1994-1995 levels at a six-year half-life for atmospheric components (vapor phase PCB concentrations and wet and dry atmospheric deposition loadings) and a 13-year half-life for PCB tributary loadings).

Total PCB concentrations in lake trout were predicted to decrease at an exponential rate (Figures 3.4.4a and 3.4.5a). Total PCB concentrations in 5.5 year-old lake trout were predicted to be less than the 0.075 µg total PCBs/g fish consumption advisory target concentration in the year 2025 for Saugatuck and 2018 for Sturgeon Bay (Figures 3.4.4b and 3.4.5b).

Recent studies (Buehler *et al.*, 2002) have suggested that historical rates of decline have recently slowed, and thus this scenario, while realistic, may overestimate the future rate of decline.

3.4.4.3 Continued Recovery – Slow

This scenario also simulated the system response to declines in PCB loads and atmospheric concentrations, but assumed that a slower observed decline rate of PCB loadings (Section 1.7.2) will continue for the 62-year simulation period. Forcing functions were assumed to decrease from 1994-1995 levels at a 20-year half-life for atmospheric components (vapor phase PCB concentrations and wet and dry atmospheric deposition loadings) and a 13-year half-life for PCB tributary loadings).

Total PCB concentrations in lake trout again declined exponentially but at a slower rate than in the previous scenario (Figures 3.4.4a and 3.4.5a). Total PCB concentrations in 5.5 year-old lake trout were predicted to take 28 years longer to reach the consumption advisory target concentration at Saugatuck. The 0.075 µg total PCBs/g fish target concentration was achieved in the year 2053 for Saugatuck and 2037 for Sturgeon Bay (Figures 3.4.4b and 3.4.5b).

The atmospheric vapor and deposition decline rate selected for this scenario was on the conservative side of possible rates, and the predicted dates of compliance with the consumption advisory target are likely the upper bound of possible dates.

3.4.5 Model Sensitivity

Four model sensitivity runs were conducted to analyze the importance of different total PCB loading sources to the Lake Michigan system. Each sensitivity run eliminated one or more loading sources to determine the impact of the sources on

PCB concentrations in the water and lake trout. The remaining loading sources repeated the 1994-1995 values, similar to the constant conditions scenario. The loading sources removed included all tributary loads, atmospheric deposition loads, the combination of tributary and atmospheric deposition loads, and internal loads from the sediment. Results were displayed for the Saugatuck area, but the trends were similar for all areas of the main lake.

3.4.5.1 No Atmospheric Wet and Dry Deposition Loadings

This simulation analyzed the sensitivity of MICHTOX to the elimination of atmospheric wet and dry deposition loadings. The first two years of the simulation used the 1994-1995 forcing functions. After January 1, 2005, the atmospheric deposition loadings were set to zero for the remaining 60 years of the model run. The remainder of the forcing functions repeated the two-year 1994-1995 values.

The 5.5 year-old lake trout total PCB concentrations decreased at a rate considerably faster than the Constant Conditions Scenario and achieved a significantly lower steady-state concentration (Figure 3.4.6). The scenario with no atmospheric deposition was predicted to reach an approximate steady-state total PCB concentrations in lake trout of 0.30 µg/g, compared to the constant conditions steady-state concentration of 0.47 µg/g.

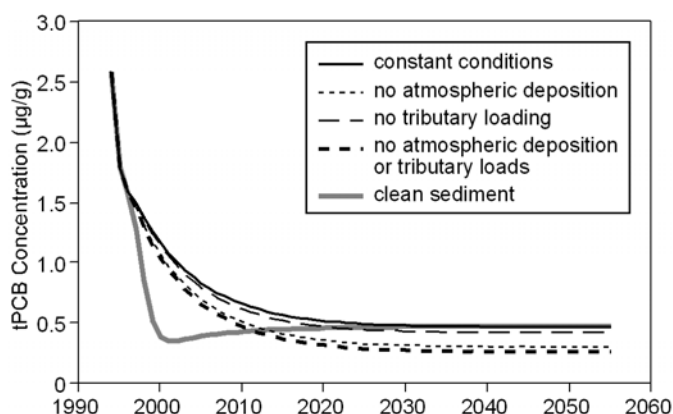

Figure 3.4.6. Sensitivity scenario total PCB concentration predictions for 5.5 year-old lake trout at Saugatuck.

3.4.5.2 No Tributary Loadings

This simulation analyzed the sensitivity of MICHTOX to the elimination of total PCB tributary loads to the Lake Michigan system. The first two years of the simulation used the 1994-1995 forcing functions, but after January 1, 2005, the tributary loadings were set to zero for the remainder of the model run. All other forcing functions repeated the two-year 1994-1995 values.

Compared to the Constant Conditions Scenario, the 5.5 year-old lake trout total PCB concentrations declined faster and reached a lower steady-state concentration, but the reduction was small (Figure 3.4.6). The scenario with no tributary loadings reached an approximate steady-state total PCB concentrations of 0.42 µg/g, compared to the constant conditions steady-state concentration of 0.47 µg/g.

Based upon these results, the system is predicted to have a greater sensitivity to wet and dry atmospheric deposition loadings than to tributary loadings. This result was not surprising, because MICHTOX treats tributary loadings and atmospheric deposition loadings in the same manner and the atmospheric deposition loadings were more than 2.6 times greater than tributary loadings in 1994-1995.

However, the relative magnitudes of tributary and atmospheric deposition loads were confounded by the available load estimate methodologies. The atmospheric deposition loads included estimates of the coarse particle loads, which were not directly measured. While comprising a large portion of the total load, the estimate of the coarse particle load is only approximate and may be subject to significant error.

The results of this scenario do not suggest that tributary loadings are not important. While they have a relatively small impact when looking at Lake Michigan on a large scale, such as MICHTOX does, tributary loadings have a large impact on the local receiving waters which they enter. Tributary loadings and their watershed sources may also have a significant effect on atmospheric vapor concentrations and deposition to the lake. Thus, clean-up of watershed PCB sources may have an

effect on loadings which are not directly quantified by the water quality model.

3.4.5.3 No Atmospheric Deposition and No Tributary Loadings

This simulation combined the removal of tributary loadings and atmospheric deposition loadings. The first two years of the simulation used the 1994-1995 forcing functions. After January 1, 2005, the atmospheric deposition loadings and the tributary loadings were set to zero. Other forcing functions repeated the 1994-1995 values throughout the simulation period.

The 5.5 year-old lake trout total PCB concentrations decreased at a rate and achieved a steady-state concentration only slightly below those of the scenario with only atmospheric deposition loads removed (0.25 µg/g versus 0.30 µg/g) (Figure 3.4.6). As with the previous two scenarios, this suggested that atmospheric components had a greater effect on MICHTOX-predicted total PCB concentrations in Lake Michigan lake trout than tributary loadings.

3.4.5.4 Sediment Total PCB Concentration Initial Conditions Set to Zero

This scenario was conducted to evaluate the sensitivity of the total PCB concentrations in lake trout to the reservoir of total PCBs in the sediment of Lake Michigan. Measured LMMBP PCB concentrations were used to define initial conditions in water, sediment, and fish (McCarty *et al.*, 2004). The 1994-1995 forcing functions were repeated for the entire period of the model run. On January 1, 1996, the sediment total PCB concentrations were re-set to zero, after which the model simulation was allowed to run normally for a 60-year period.

The shape of the lake trout PCB concentration curves over time was influenced by PCB dynamics in the water column and sediments and a time lag in the MICHTOX food chain. Water column concentrations dropped for two years as PCBs in the water column settled out and volatilized faster than loadings entering the system. After two years, however, water column concentrations began to recover due to tributary and atmospheric deposition loadings, resuspension of newly contaminated sediments, and absorption of PCBs from the atmosphere.

While the lower levels of the food chain immediately responded to the reduced PCBs in water and sediment, the higher food chain organisms had a residual body burden, and the response was slower. MICHTOX predicted a drop in the 5.5 year-old lake trout total PCB concentrations for a period of six years, then the concentrations steadily increased until reaching the same steady-state concentration as the Constant Conditions Scenario (Figure 3.4.6). The lake trout total PCB concentrations were within 5% of the concentrations of the Constant Conditions Scenario within a period of 30 years, and reached steady-state concentration about 45 years after the sediment clean-up. This was about the same time period required for the Constant Conditions Scenario to reach steady-state concentrations.

This scenario demonstrated the importance of the reservoir of total PCBs in the sediments on the total PCB concentrations in the higher levels of the food chain. Response time would be greatly influenced by the sediment settling and resuspension dynamics in the model.

References

- Buehler, S.S., I. Basu, and R.A. Hites. 2002. Gas-Phase Polychlorinated Biphenyl and Hexachlorocyclohexane Concentrations Near the Great Lakes: A Historical Perspective. *Environ. Sci. Technol.*, 36(23):5051-5056.
- Connolly, J.P. and R.V. Thomann. 1985. WASTOX, A Framework for Modeling the Fate of Toxic Chemicals in Aquatic Environments. Project Report. U.S. Environmental Protection Agency, Office of Research and Development, ERL-Duluth, Large Lakes Research Station, Grosse Ile, Michigan. 52 pp.
- Connolly, J.P. 1991. Documentation for Food Chain Model, Version 4.0. Manhattan College, Riverdale, New York.
- DeVault, D.S., R. Hesselberg, P.W. Rodgers, and T.J. Feist. 1996. Contaminant Trends in Lake Trout and Walleye From the Laurentian Great Lakes. *J. Great Lakes Res.*, 22(4):884-895.
- Endicott, D.D. 2005. 2002 Lake Michigan Mass Balance Project: Modeling Total Polychlorinated Biphenyls Using the MICHTOX Model. In: R. Rossmann (Ed.), MICHTOX: A Mass Balance and Bioaccumulation Model for Toxic Chemicals in Lake Michigan, Part 2. U.S. Environmental Protection Agency, Office of Research and Development, National Health and Environmental Effects Research Laboratory, MED-Duluth, Large Lakes Research Station, Grosse Ile, Michigan. EPA/600/R-05/158, 140 pp.
- Endicott, D.D., W.L. Richardson, and D.J. Kandt. 2005. 1992 MICHTOX: A Mass Balance and Bioaccumulation Model for Toxic Chemicals in Lake Michigan. In: R. Rossmann (Ed.), MICHTOX: A Mass Balance and Bioaccumulation Model for Toxic Chemicals in Lake Michigan, Part 1. U.S. Environmental Protection Agency, Office of Research and Development, National Health and Environmental Effects Research Laboratory, MED-Duluth, Large Lakes Research Station, Grosse Ile, Michigan. EPA/600/R-05/158, 140 pp.
- Great Lakes Sport Fish Advisory Task Force. 1993. Protocol for a Uniform Great Lakes Sport Fish Consumption Advisory. 86 pp.
- McCarty, H.B., J. Schofield, K. Miller, R.N. Brent, P. Van Hoff, and B. Eadie. 2004. Results of the Lake Michigan Mass Balance Study: Polychlorinated Biphenyls and *trans*-Nonachlor Data Report. U.S. Environmental Protection Agency, Great Lakes National Program Office, Chicago, Illinois. EPA/905/R-01/011, 289 pp.
- Swackhamer, D. 2003. Personal communication. University of Minnesota, Madison, Wisconsin.

PART 3

LEVEL 1 MODELS

Appendix 3.4.1 Derivation of a Hypothetical Lake Michigan Lake Trout Fish Consumption Criteria for PCBs

Brent Burman
Welso Federal Services, LLC
Large Lakes Research Station
9311 Groh Road
Grosse Ile, Michigan 48138
and
Kenneth R. Rygwelski
U.S. Environmental Protection Agency
Office of Research and Development
National Health and Environmental Effects
Research Laboratory
Mid-Continent Ecology Division
Large Lakes and Rivers Forecasting Research
Branch
Large Lakes Research Station
9311 Groh Road
Grosse Ile, Michigan 48138

The hypothetical fish consumption criteria that we derived for Lake Michigan lake trout has not been officially adopted by any Federal, State, or local authorities. We proceeded to calculate this target concentration because we could not find any other polychlorinated biphenyl (PCB) consumption concentrations for Lake Michigan lake trout that we could readily relate to our model-predicted concentrations in whole fish. This fish consumption criteria was used in our hypothetical PCB forecast scenarios for Lake Michigan found elsewhere in this report.

A reduction factor to convert whole fish PCB concentrations to fillet PCB concentrations was needed for the comparison of model output data to fish consumption advisories. The data gathered for the Lake Michigan Mass Balance Project (LMMBP) for lake trout PCB concentrations was based on the whole body of the fish, less the stomachs. Available consumption advisories are based on the edible portion of the fish (Great Lakes Sport Fish Advisory Task Force, 1993). The edible portion refers to a fillet which includes all flesh from the back of the head to the tail, including the skin and fatty belly flap. The Health Protection Value for this fillet portion has been established at 0.05 µg PCBs/(kg/day) and is sufficient to keep cancer incidence at less than 1 per 10,000. Using a standard of 225 meals per year, the amount of PCBs allowable in the edible portion for a 70 kg individual is 0.05 ppm. The derivation of this figure is described in the Protocol for a Uniform Great Lakes Sport Fish Consumption Advisory (Great Lakes Sport Fish Advisory Task Force, 1993).

Research was necessary to determine if PCBs are concentrated equally in the fillet and whole body of lake trout. If it was determined that PCBs are concentrated either higher or lower in the fillet than in the whole fish, then the target level of 0.05 ppm would have to be adjusted accordingly.

Limited research was performed on Lake Michigan lake trout in this regard. Relevant research was done on Lake Superior lake trout (Miller and Schram, 2000) and Lake Michigan rainbow trout and coho salmon (Amrhein *et al.*, 1999), but nothing was found that specifically looked at Lake Michigan lake trout. Amrhein *et al.* (1999) found whole fish:fillet derived

ratios of 2.47 for rainbow trout, and 2.7 for coho salmon, but it was uncertain as to whether the ratio would be similar for lake trout. Miller and Schram (2000) found a whole fish:fillet ratio for siscowet lake trout of 2.5, but the lipid content of siscowet and Lake Michigan lake trout are vastly different. A data set of lean lake trout from Lake Superior was provided by the Michigan Department of Environmental Quality (MDEQ) which had PCB concentrations for both whole fish and fillets (Day, 1997). The fish in the data set provided were nearly identical in length, weight, and lipid content, so we believed that they would be sufficient to use in our comparison to the Lake Michigan data set (Table A3.4.1).

Statistical analysis of the MDEQ data set resulted in a whole fish:fillet ratio of 1.525; that is, PCB levels were found to be 1.525 times higher in the whole fish than in the fillets. Based upon this calculation, we concluded that a factor of 1.5 would be justified in converting the target level of 0.05 ppm PCBs for fillets to 0.075 ppm PCBs as the new target level for comparison of our model output for whole fish. Further examination of the MDEQ data set revealed that the whole fish:fillet PCB ratio was closely related to the whole fish:fillet lipid ratio. A ratio of 1.50 was found for the lipid concentrations and is shown in Figure A.3.4.1. The result was not surprising as it is known that PCBs are concentrated in the lipids.

Further research was initiated to validate the factor of 1.5 for lake trout in light of the work of Amrhein *et al.* (1999). Coho salmon and rainbow trout were both found to have much higher ratios, which if used for lake trout, would raise the target level for a fish consumption advisory to 1.25 ppm of PCBs, or even higher. To add validity to the factor we had calculated, a review of several common Great Lakes sport fish was conducted. Because the PCB ratio in question was shown in Figure 3.4.1 to be closely related to lipid concentrations, a comparison was

made between eight Great Lakes sport fish using additional data. The lake trout from the MDEQ data set and the rainbow trout and coho salmon from Amrhein *et al.* (1999) were compared with five additional species of fish from the Fox River and Green Bay. The additional species examined were carp, walleye, northern pike, smallmouth bass, and yellow perch (Fox River Model Evaluation Workgroup, 1999). It was found that as whole fish lipid concentrations decreased, that the relative ratio of whole fish:fillet PCBs increased (Figure 3.4.2). It can be reasoned that fish with higher lipid contents store more lipids in the fillet portion than comparatively less fatty fish, which store most of their lipids in the viscera and head which are not included in the edible portion. Because Lake Michigan lake trout have higher lipid contents than the rainbow trout and coho salmon studied by Amrhein *et al.* (1999), they will also have a relatively lower whole fish:fillet PCBs ratio.

References

Amrhein, J.F., C.A. Stow, and C. Wible. 1999. Whole-Fish Versus Fillet Polychlorinated Biphenyl Concentrations: An Analysis Using Classification and Regression Tree Models. *Environ. Toxicol. Chem.*, 18(8):1817-1823.

Day, R. 1997. Michigan Fish Contaminant Monitoring Program Annual Report. Surveillance Water Quality Division, Michigan Department of Environmental Quality, Surface Water Quality Division, Lansing, Michigan. Report Number MI/DEQ/SWQ-97-125.

Fox River Model Evaluation Workgroup. 1999. Analysis of Bioaccumulation in the Fox River. Technical Memorandum Document, Number 8600B6A.001 1001 0299 DN08, 24 pp.

Table A3.4.1. Comparison of the LMMBP Lake Trout to MDEQ Lake Superior Lake Trout

	Length (cm)	Weight (g)	Whole Fish PCBs	Lipid (%)
Lake Superior (MDEQ)	58.1	1519	0.24075	15.63
Lake Michigan (LMMBP)	57.83	1943.34	2.03646	16.07

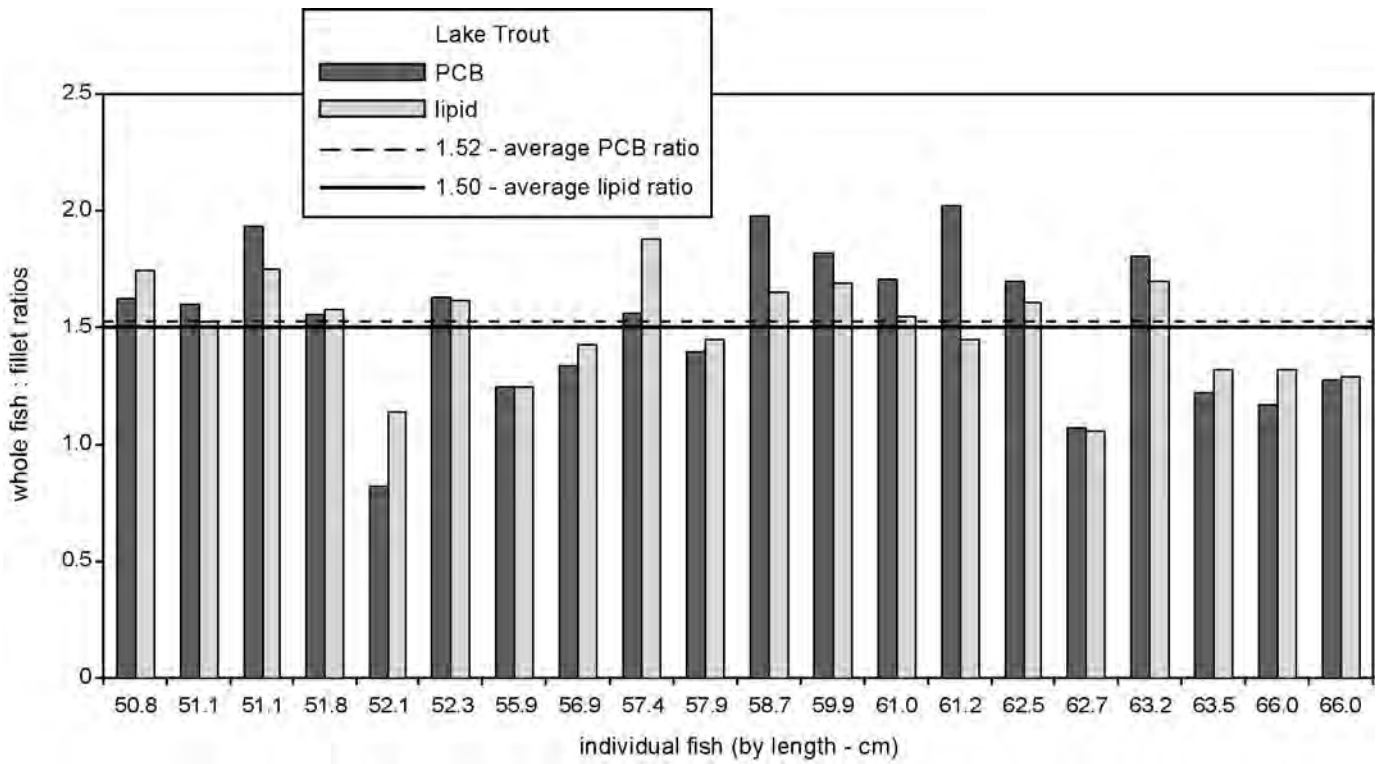

Figure A3.4.1. Whole fish to edible portion of fish PCBs and lipid ratios for lake trout.

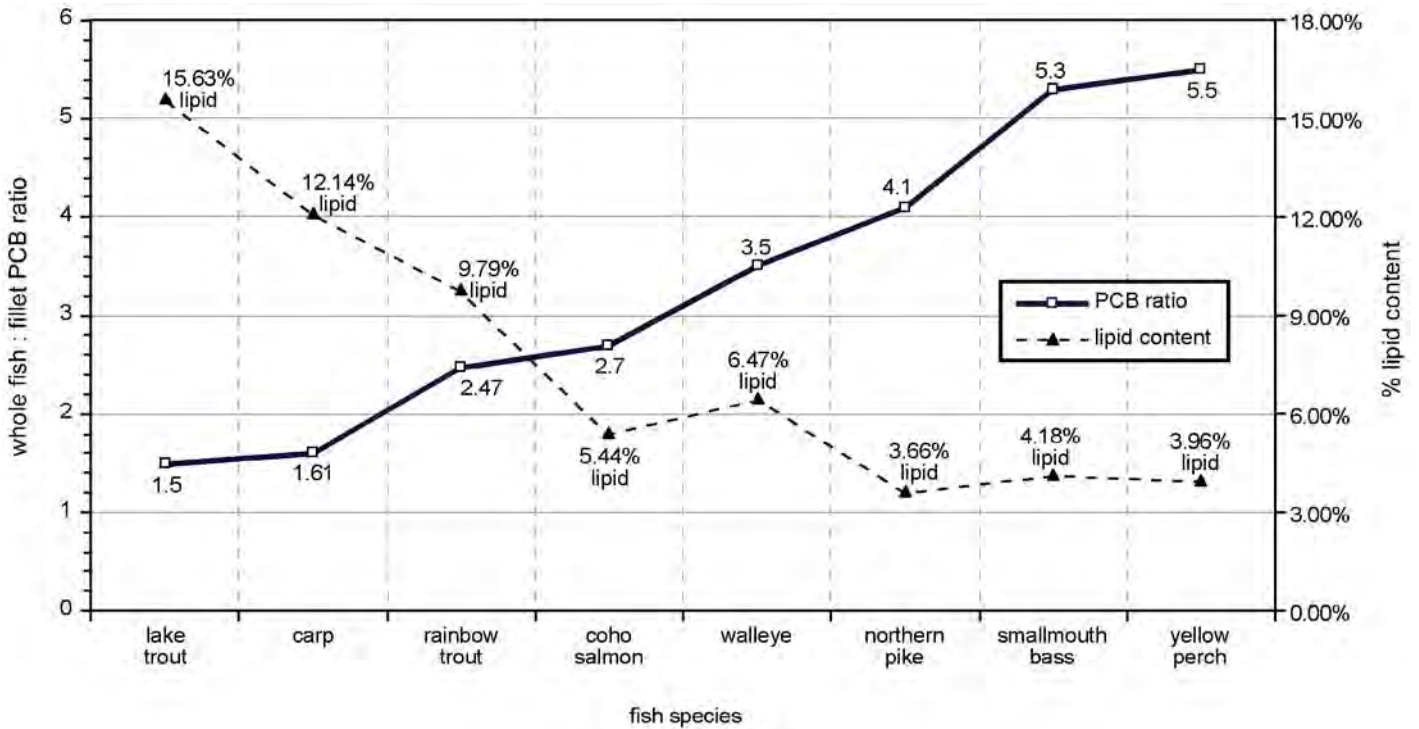

Figure A3.4.2. Comparison of whole fish to fillet PCB ratios and lipid content for various fish species.

Great Lakes Sport Fish Advisory Task Force. 1993. Protocol for a Uniform Great Lakes Sport Fish Consumption Advisory. 86 pp.

Miller, M.A. and S.T. Schram. 2000. Growth and Contaminant Dynamics of Lake Superior Lake Trout. *J. Great Lakes Res.*, 26(1):102-111.

PART 4

LM2-TOXIC

Xiaomi Zhang
Welso Federal Services, LLC
Large Lakes Research Station
9311 Groh Road
Grosse Ile, Michigan 48138

Chapter 1. Executive Summary

As one of the components in the overall Lake Michigan Mass Balance Project (LMMBP) modeling framework, a comprehensive polychlorinated biphenyl (PCB) congener-based water quality model, LM2-Toxic, was developed to simulate fate and transport of PCBs in both water and sediment of Lake Michigan. The main focus of this model was to address the relationship between sources of toxic chemicals and their concentrations in water and sediments of Lake Michigan, and provide the PCB exposure concentrations to the bioaccumulation model (LM2 Food Chain) to predict PCB concentrations in lake trout tissue. This report provides detailed model description and development, model input and field data, model calibration procedures and confirmation, PCB mass budget analysis, the results of model predictions, and sensitivity analyses.

LM2-Toxic is a revision of the United States Environmental Protection Agency (USEPA)-supported WASP4 water quality modeling framework. It incorporates the organic carbon dynamics featured in GBTOX and the sediment transport scheme, a quasi-Lagrangian framework, used in the IPX. Both GBTOX and IPX were WASP4-type models and major components in the Green Bay Mass Balance

Project (GBMBP) modeling framework. Another important modification was the addition of updated air-water exchange formulations to the model.

There were 94 segments in the spatial segmentation for the LM2-Toxic. Forty-one of them were water column segments, and 53 of them were surficial sediment segments. Temporal resolution for the model input was on a daily time scale. Most of the kinetic functions were segment-specific time functions. Good representation of water circulation was essential for the accuracy of outputs from the water quality model. The results at 5 x 5 km² grid generated by Princeton Ocean Model (POM) for the Great Lakes were linked to the transport fields for LM2-Toxic. Due to an affinity of PCBs for organic carbon, three organic carbon sorbents were simulated as state variables in LM2-Toxic. They were biotic carbon (BIC), particulate detrital carbon (PDC), and dissolved organic carbon (DOC). The model simulated 54 PCB congeners which accounted for roughly 70% of the total PCB mass in Lake Michigan. Four phases were simulated in LM2-Toxic for the congeners. The four phases were dissolved, sorbed to PDC, sorbed to BIC, and bound to DOC.

LM2-Toxic is a coupled mass balance of organic carbon solids and toxic chemical (PCBs) dynamics. Prior to the organic carbon dynamics and PCB

dynamic calibrations, vertical dispersion coefficients were determined using a thermal balance model. Using the LMMBP-generated field data, the organic carbon solids dynamics were first calibrated. This was followed by the independent calibration of PCB dynamics. The temporal variations of both BIC and PDC resulted from an algal bloom in late spring and early summer. Primary production was the dominant organic carbon load to Lake Michigan. The eutrophication model (LM3-Eutro)-generated primary production accounted for over 90 percent of the total particulate organic carbon (POC) load to the lake. The PCB concentrations in the dissolved phase was about double the concentration in the particulate phase in the main lake. There was some degree of temporal variation in the water column PCB concentration controlled by a combination of seasonal variation of external loads, atmospheric concentrations, and sediment resuspension events. There was also a slight longitudinal concentration gradient throughout the main lake. The highest concentrations were found in the southern segments due to higher PCB atmospheric deposition and concentrations observed in the area close to Chicago. There was little vertical gradient of PCB concentrations found based on main lake cruise mean data. As an important part of the modeling effort to reduce uncertainties associated with water transport, settling, resuspension, and sedimentation, a chloride model, a long-term simulation using a ^{137}Cs and $^{239,240}\text{Pu}$ model, a long-term organic carbon simulation, and a 47-year PCB hindcast simulation using LM2-Toxic were developed and run for LM2-Toxic confirmation. These confirmation steps were crucial and laid down a credible foundation for long-term projections using LM2-Toxic.

After calibration of organic carbon and PCB congener dynamics and model confirmation, a mass budget analysis was done for the LMMBP period (1994-1995) to identify the critical contaminant sources, sinks, and key environmental processes in Lake Michigan. Figure 4.1.1 provides a summary of the results of the total PCB mass budget diagnosis in Lake Michigan. The average masses of total PCBs presented in the water column and the surficial sediments (0-1 cm) of the lake during 1994-1995 were 1,216 kg and 13,085 kg, respectively. The inventories divided by the volumes of the water and the surficial sediment layer of the lake lead to an average concentration of total PCBs equal to 0.259

ng/L in the water column and 12,037 ng/L in the surficial sediment layer. The information on the fluxes of total PCBs in Figure 4.1.1 shows the single largest flux leaving the Lake Michigan system was gross volatilization. This flux was countered by the flux from gas absorption as the largest source to the lake. The air-water exchange was the most important process for Lake Michigan. It produced the largest PCB net loss out from the lake. Resuspension was a major influx of PCBs to the water column offset by the flux from settling. Resuspension and settling were very important processes in the lake system. The results of these processes made the net flux between resuspension and settling the second largest net source. The total external load (tributary loads + atmospheric loads) to the water column of the lake was the largest net PCB source to the lake water column. The flux by burial was the largest net loss from the surficial sediment layer. There was a net loss of 1,863 kg/year of total PCBs for the entire Lake Michigan system (the water column + the surficial sediment layer of both Green Bay and Lake Michigan). This indicated both the water column and the surficial sediment layer of the lake were not at steady-state during the LMMBP period.

The model was also applied for forecasting the long-term responses (62-year simulation, starting on January 1, 1994) of the PCBs in Lake Michigan under various forcing functions and load reduction scenarios. Seven PCB forecast and sensitivity scenarios were conducted. These seven long-term forecast and sensitivity scenarios were:

- A. Constant Conditions (Upper Bound) – Repeat 1994-1995 conditions.
- B. Continued Recovery (Fast) – Atmospheric components (vapor phase concentration, dry and wet depositions) decline with a six-year half-life (Hillery *et al.*, 1997; Schneider *et al.*, 2001). Tributary loads decline with a 13-year half-life (Endicott, 2005; Marti and Armstrong, 1990).
- C. Continued Recovery (Slow) – Atmospheric components (vapor phase concentration, dry and wet depositions) decline with a 20-year half-life (Buehler *et al.*, 2002). Tributary loads decline with a 13-year half-life.

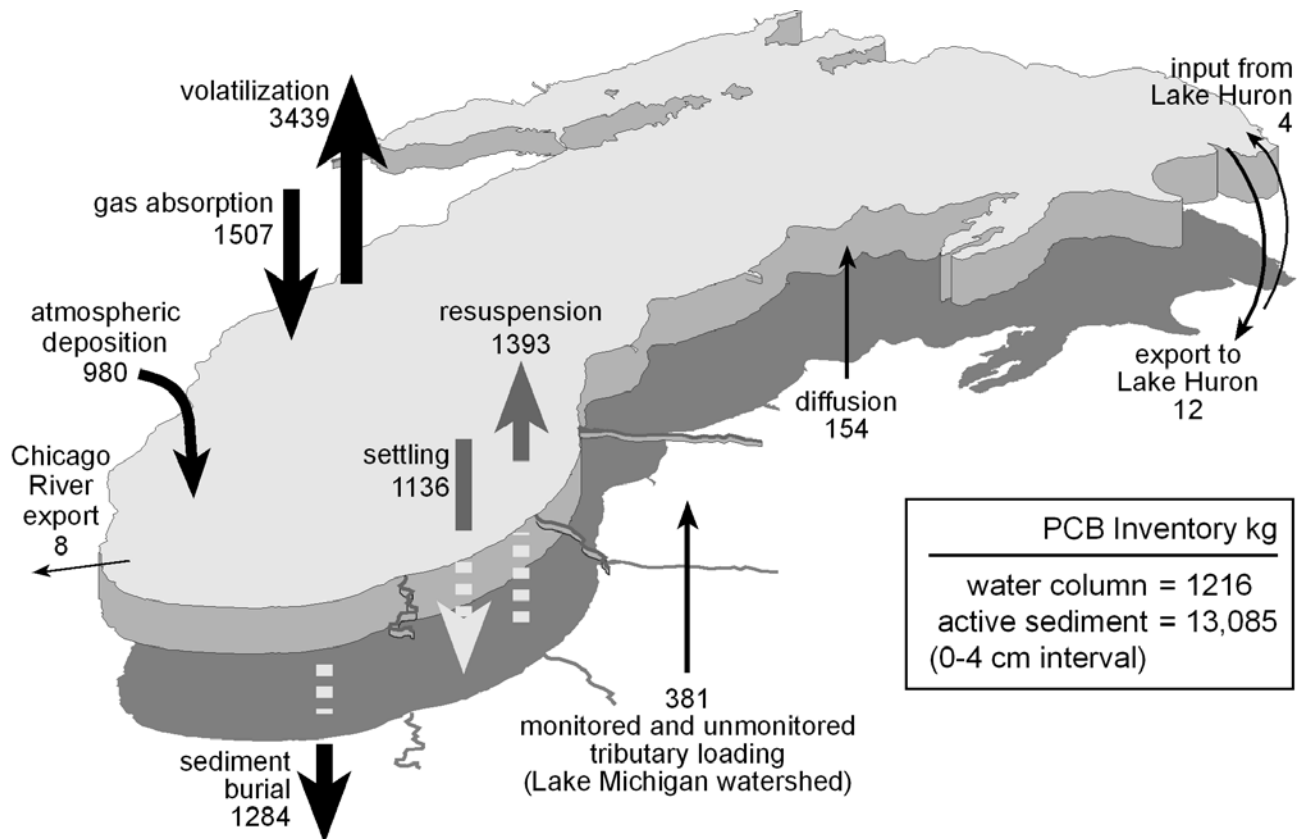

Figure 4.1.1. Mass budget average for 1994-1995 total PCBs in the Lake Michigan system (including Green Bay). Unit of the masses transported (arrows) is in kg/year.

- D. No Atmospheric Deposition – Stop all PCB atmospheric deposition (dry and wet).
- E. No Tributary Loadings – Stop all tributary PCB loads.
- F. Lake Sediment Clean-up – Remove all PCB mass from the surficial sediments.
- G. No Atmospheric Deposition and No Tributary Loadings – Stop all PCB atmospheric deposition (dry and wet) and tributary loads.

All of the control actions started on January 1, 1996. Figure 4.1.2 presents the long-term responses of total PCBs in the water column of Lake Michigan under the seven forecast and sensitivity scenarios. The results from the Constant Conditions Scenario simulation clearly demonstrated that, during the

LMMBP period, the Lake Michigan system was not at steady-state with respect to the 1994-1995 loads, vapor phase concentrations, and the level of sediment total PCB inventory. The results from this scenario also indicate that, if there is no decline in the current (1994-1995) forcing conditions, the water column PCB concentration in the future will never meet the USEPA water quality criteria for the protection of wildlife (0.12 ng/L) (U.S. Environmental Protection Agency, 2005) and human health (0.026 ng/L) (U.S. Environmental Protection Agency, 1997) in the Lake Michigan system. The long-term response from Scenario B – Continue Recovery (Fast) shows that it takes about five years for the water column concentration to reach the USEPA water quality criterion for the protection of wildlife and more than two decades to reach the USEPA water quality criterion for the protection of human health. The water column PCB concentrations predicted in

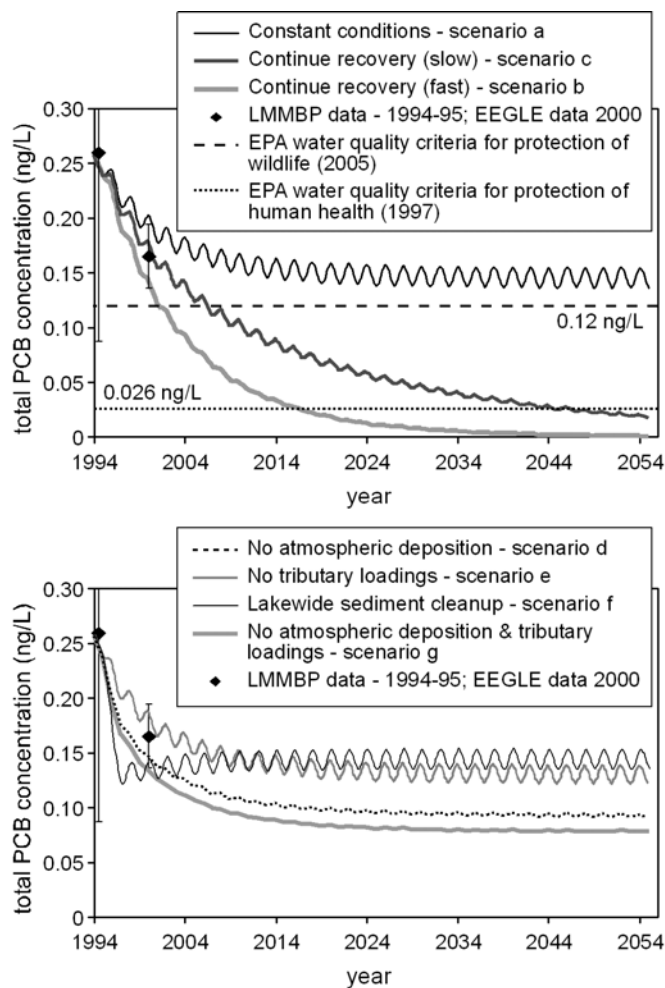

Figure 4.1.2. Annual long-term responses of total PCB concentrations in the water column of Lake Michigan for the forecast and sensitivity scenarios.

Scenario C – Continue Recovery (Slow) declined at a much slower pace. The model results indicated that it takes about 12 years for the water column PCB concentrations in the lake to reach the USEPA water quality criterion for the protection of wildlife and that the water column PCB concentration will reach the USEPA water quality criterion for the protection of human health around 2046 (five decades after 1996). The rates used in Scenarios B and C may not be realistic rates for the Great Lakes in the future. With the addition of more recent data, it appears that the rate of decline in the atmospheric components could be slower than the decline rate used in Scenario C.

The results from the sensitivity scenarios (Scenarios D, E, F, and G) suggested that the long-term PCB

concentrations in the water column are more sensitive to atmospheric deposition (dry and wet) than to tributary loads. By eliminating PCB total inventory in the lake sediments on January 1, 1996, the water column concentration had a steep drop initially, and then gradually increased and reached a value close to the steady-state concentration predicted by Scenario A – Constant Condition.

LM2-Toxic is a sophisticated and state-of-the-art toxic chemical fate and transport model for Lake Michigan. There are still many improvements that can be made to the modeling framework and more systematic tests could be conducted to address the impacts of each process conceptualized in the LM2-Toxic on the model outcomes. The results and

predictions from the LM2-Toxic clearly demonstrate the ability of the model to quantitatively analyze the behavior of PCBs in the Lake Michigan system and to forecast the long-term PCB dynamics under various external forcing conditions.

References

- Buehler, S.S., I. Basu, and R.A. Hites. 2002. Gas-Phase Polychlorinated Biphenyl and Hexachlorocyclohexane Concentrations Near the Great Lakes: A Historical Perspective. *Environ. Sci. Technol.*, 36(23):5051-5056.
- Endicott, D.D. 2005. 2002 Lake Michigan Mass Balance Project: Modeling Total PCBs Using the MICHTOX Model. In: R. Rossmann (Ed.), *MICHTOX: A Mass Balance and Bioaccumulation Model for Toxic Chemicals in Lake Michigan, Part 2*. U.S. Environmental Protection Agency, Office of Research and Development, National Health and Environmental Effects Research Laboratory, MED-Duluth, Large Lakes Research Station, Grosse Ile, Michigan. EPA/600/R-05/158, 140 pp.
- Hillery, B.L., I. Basu, C.W. Sweet, and R.A. Hites. 1997. Temporal and Spatial Trends in a Long-Term Study of Gas-Phase PCB Concentrations Near the Great Lakes. *Environ. Sci. Technol.*, 31(6):1811-1816.
- Marti, E.A. and D.E. Armstrong. 1990. Polychlorinated Biphenyls in Lake Michigan Tributaries. *J. Great Lakes Res.*, 16(3):396-405.
- Schneider, A.R., H.M. Stapleton, J. Cornwell, and J.E. Baker. 2001. Recent Declines in PAH, PCB, and Toxaphene Levels in the Northern Great Lakes as Determined From High Resolution Sediment Cores. *Environ. Sci. Technol.*, 35(19):3809-3815.
- U.S. Environmental Protection Agency. 1997. Revocation of the Polychlorinated Biphenyl Human Health Criteria in the Water Quality Guidance for the Great Lakes System. Federal Register, October 9, 1997, Volume 62, Number 196. [DOCID:fr09oc97-9]. From the Federal Register Online via GPO Access [wais.access.gpo.gov].
- U.S. Environmental Protection Agency. 2005. Water Quality Guidance for the Great Lakes System. Code of Federal Regulations, Title 40, Volume 21, Chapter 1, Part 132. <http://www.access.gpo.gov/nara/>.

PART 4

LM2-TOXIC

Chapter 2. Recommendations

LM2-Toxic was developed for its efficient conduct of model calibrations and its capability to forecast long-term impacts resulting from a variety of control actions applied to an aquatic system. There are still quite a few improvements that can be done to enhance the credibility of the model predictions. The recommendations for the further improvements and tests are listed below.

1. The results from the long-term cesium hindcast simulation should not be limited to comparison to the water column concentration and total sediment cesium inventory. They should include comparisons with the available ^{137}Cs sediment core profiles. This will provide an additional confirmation on the solid vertical transport dynamics (settling, resuspension, and burial rates) in Lake Michigan.
2. Instead of the empirical approach to estimate sediment resuspension of each sediment segment, a more sophisticated mechanistic sediment transport model (e.g., SEDZL or SEDZLJ), should be used to provide a more accurate and realistic sediment resuspension.
3. Model verification (a post-audit) should continue using the latest field data collected around Lake Michigan to verify 1) parameters and rates used in the model and 2) some of the conclusions made from the long-term forecast scenarios.
4. As an extended confirmation process, 1) comparison between net settling fluxes of organic carbon generated from the model with available sediment trap data, and 2) more research conducted on carbon:chlorophyll a ratio including its spatial variation in the lake are needed.
5. To investigate the potential impacts on the outcomes of the model by critical environmental processes and under different physical, chemical, and meteorological conditions, more systematic analyses are needed, including:
 - A. Sensitivity analysis of the fluxes across the air-water interface by using different gas and liquid transfer formulations.
 - B. Sensitivity analysis of model responses by changing surficial sediment initial conditions.
 - C. Investigation of model responses in both water column and sediment to various mass fluxes across the sediment-water interface by changing diffusion coefficient and/or mixing length between the water column and surficial sediment.
 - D. Investigation of potential impacts of ice-cover and water surface elevation on the model outcome.
 - E. Investigation of the impacts of carbon internal loads on the results of LM2-Toxic PCB hindcast.
 - F. Investigation of system responses to different hydrodynamic transport fields.

G. Sensitivity analysis of organic carbon decay rates in the surficial sediment.

All of the above analyses should be conducted on both short-term and long-term scales to see the short-term and long-term effects on the model simulation results.

6. Explore the effect of a huge resuspension event on outcomes of the model hindcast and forecast.
7. Addition of a benthic nepheloid layer (BNL) to the model configuration to address the importance, effects, and benefits of this compartment on the overall organic carbon and hydrophobic organic chemicals cycling in the lake system.
8. Expand the model to more applications and additional contaminants including a) mercury and *trans*-nonachlor modeling for Lake Michigan and b) finer model resolutions (e.g., Level 3) in both spatial and kinetic processes.
9. Couple an air model to the LM2-Toxic to compute vapor phase concentration dynamically for more accurate calculation of the fluxes across the interface between air and water.
10. Collect a higher density of sediment samples from shallow high-energy areas of Lake Michigan that will greatly enhance the representativeness of carbon sorbent or toxic chemical dynamics in these zones. These may significantly influence sediment-water exchange and toxic chemical dynamics in Lake Michigan.
11. Apply a different segmentation (still similar to the spatial resolution as the current

segmentation used in LM2-Toxic) to the model to 1) more efficiently utilize nearshore and offshore data, 2) document nearshore and offshore gradients observed in the data collected for the Lake Michigan Mass Balance Project (LMMBP) for most congeners, and 3) investigate the impacts of using different segmentations (even on the same spatial resolution) on the model outcomes.

12. Conduct sensitivity analysis on potential polychlorinated biphenyl (PCB) decay rates in both water column and sediments of Lake Michigan. The model currently assumes no PCB decay in both compartments.
13. Investigate the uncertainty associated with the selected parameters for specific processes conceptualized in the LM2-Toxic using Monte Carlo or other uncertainty analyses.

Considering the feasibility of these recommendations, they can be categorized as follows:

- A. The recommendations that can be done in a relatively short time period with limited effort include Numbers 5A, B, C, G; and 12.
- B. The recommendations that can be done within a relatively moderate time frame and effort once the necessary data are available include Numbers 3; 4; 5D, E, F; and 6.
- C. The recommendations that can be done in a long time frame and significant effort include Numbers 1, 2, 8, and 13.
- D. The recommendations that can be done in a very long time period and demand full effort include Numbers 7, 9, 10, and 11.

PART 4

LM2-TOXIC

Chapter 3. Model Description

As one of the submodels in the overall Lake Michigan Mass Balance Project (LMMBP) modeling framework, LM2-Toxic was specifically developed to simulate transport and fate of toxic chemicals, such as polychlorinated biphenyl (PCB) congeners, in both the water and sediment of Lake Michigan. The principal focus of this model was to quantitatively define the relationship among external carbon and toxic chemical loads, internal cycling of organic carbon and toxic chemicals, and toxic chemical concentrations in the water and sediments of the lake. The PCB exposure concentrations predicted from the LM2-Toxic model were then used as a forcing function to compute PCB concentrations in fish tissue.

LM2-Toxic evolved by combining the IPX and GBTOX models in an attempt to better represent and integrate processes considered to be important in Lake Michigan (Velleux *et al.*, 2000; Settles, 1997; Bierman *et al.*, 1992). Both the IPX and GBTOX are descendants from the WASP4 water quality modeling framework (Ambrose *et al.*, 1988). LM2-Toxic incorporates the organic carbon dynamics highlighted in GBTOX and the sediment transport scheme, a quasi-Lagrangian framework, used in the IPX model. It allows decay and transformation between organic carbon states in both the water column and sediment bed and variation of the surficial sediment layer thickness in response to net settling or net resuspension of sediments. In addition to the above features, an updated air-water exchange formulation (Bamford *et al.*, 1999; Wanninkhof *et al.*, 1991;

Schwarzenbach *et al.*, 1993) was implemented in the model.

4.3.1 Model Framework

LM2-Toxic was based on the principle of conservation of mass. It used the same finite segment modeling approach used in the United States Environmental Protection Agency (USEPA)-supported WASP4 modeling framework. The mass of a chemical or solid in each segment of a water system is controlled by water movement between adjacent segments, solid dynamics and chemical dynamics within the system, internal and external loads, and boundary concentrations. A group of mass balance equations representing the above processes was used in the model to compute change of mass for a state variable (constituent) in a segment at a certain time. The model traced and described where and how a mass of constituent was transported and transformed. The general time-dependent finite differential equation in a given segment can be written to describe the change of mass for a state variable at a certain time.

In a water column segment:

$$V_j \frac{dC_j}{dt} = \sum_i^n Q_{ij} C_{ij} + \sum_i^n R_{ij} (C_i - C_j) + W_j + S_{aw,j} + S_{sw,j} + S_{k,j} \quad (4.3.1.)$$

In a sediment segment (assume mixing only in vertical direction):

$$V_j \frac{dC_j}{dt} = \sum_i^n R_{ij} (C_i - C_j) + S_{sw,j} + S_{b,j} + S_{k,j} \quad (4.3.2)$$

where

- V_j = volume of segment j (L^3)
- C_j = concentration of water quality constituent in segment j (M/L^3)
- C_{ij} = concentration of water quality constituent at the interface between segment i and j (M/L^3)
- Q_{ij} = net flow across the interface between segment i and j (defined as positive when entering segment j and negative when leaving segment j) (L^3/T)
- n = number of adjacent segments
- R_{ij} = $(E_{ij}A_{ij}/\Delta X_{ij})$, bulk dispersion/diffusion coefficient (L^3/T)
- E_{ij} = mixing (dispersion/diffusion) coefficient (L^2/T)
- A_{ij} = interfacial area between segment i and j (L^2)
- ΔX_{ij} = characteristic mixing length between segments i and j (L)
- W_j = internal and external loading rate of segment j (M/T)
- $S_{aw,j}$ = mass change rate due to air-water exchange process between segment j and air directly above segment j (M/T)
- $S_{sw,j}$ = mass change rate due to sediment-water exchange processes between segment j and adjacent sediment segments (M/T). The processes include settling and resuspension
- S_k = mass change rate due to sum of kinetic transformation processes within segment j (M/T), positive is source, negative is sink

S_b = mass change rate due to burial process from surficial mixing layer to deeper sediment layer (M/T)

Note: L = length; M = mass; T = time.

The following sections of this chapter will provide a detailed description of model segmentation, water circulation, solid dynamics, and chemical dynamics. The direct loads, including external and internal loads, and boundary conditions are discussed in detail in Chapter 4.

4.3.2 Model Configuration

4.3.2.1 Spatial Resolution – Segmentation

Compared to MICHTOX (Level 1 contaminant transport and fate model developed for Lake Michigan) segmentation (Figure 3.3.2), the LM2-Toxic Level 2 model had finer resolution. Most water column segments in the LM2-Toxic model segmentation share the same or portion of the segment boundaries used in the MICHTOX-Toxic model. Green Bay segments had similar features as those used in GBTOX (Bierman *et al.*, 1992) and MICHTOX (Endicott *et al.*, 2005). The significant differences between Level 1 and Level 2 models were with respect to model structure, state variables, and related physical and chemical processes. They are discussed in detail in the following sections.

The spatial segmentation for the LM2-Toxic model was developed from digitized bathymetric (5 x 5 km² grid) and shoreline data for Lake Michigan provided by Dr. David Schwab, National Oceanic and Atmospheric Administration (NOAA) (Schwab and Beletsky, 1998). The lake, including Green Bay, was divided into 10 horizontal columns, five water column layers, and one surficial sediment layer. A detailed spatial and cross sectional segmentation of the LM2-Toxic model is illustrated in Figures 4.3.1 to 4.3.3. There are 94 segments in total. Segments 1-41 were water column segments. Most of them had an interface with surficial sediments. Segments 1-10 were surface water segments with an interface with the atmosphere. Segments 42-94 were the surficial sediment segments with sizes not identical to the upper water column segments. The sediment segmentation of the LM2-Toxic model was very

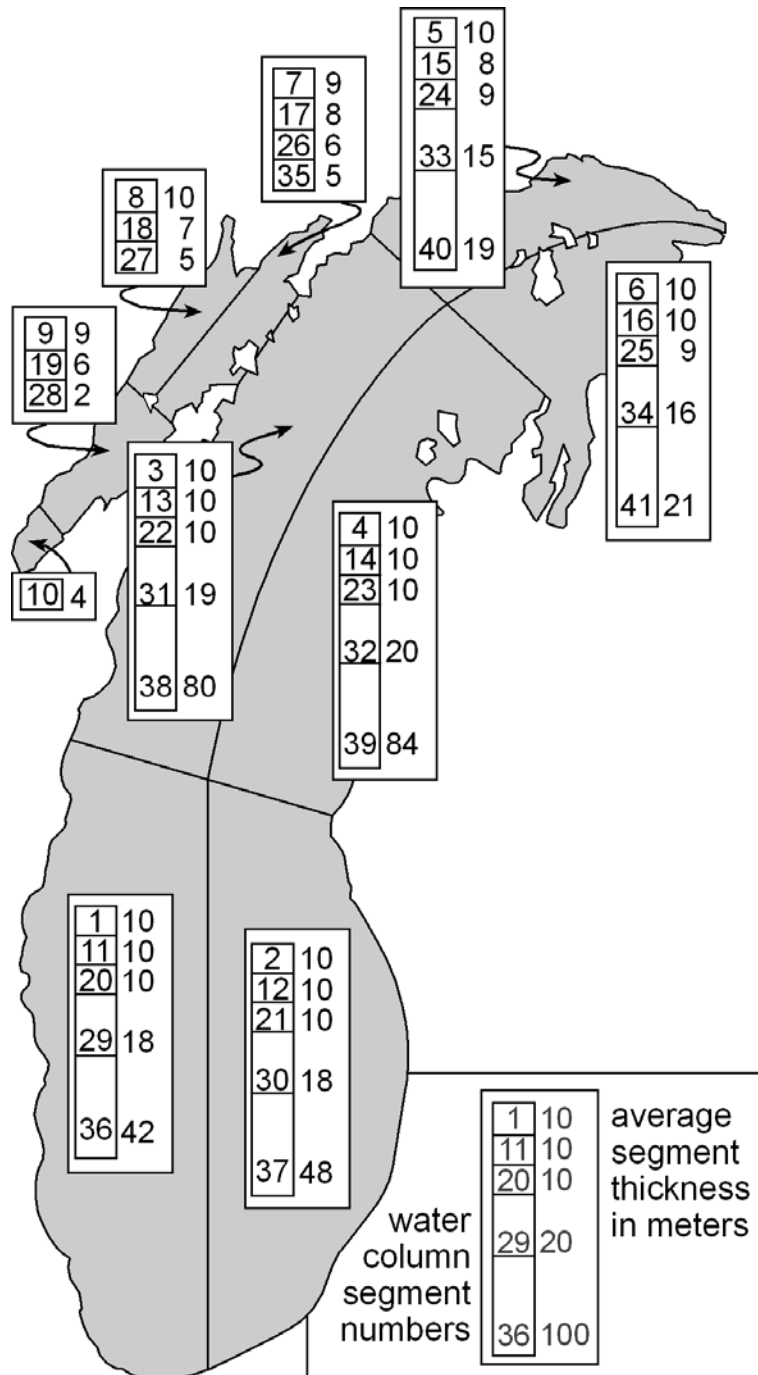

Figure 4.3.1. Water column segmentation for the LM2-Toxic model.

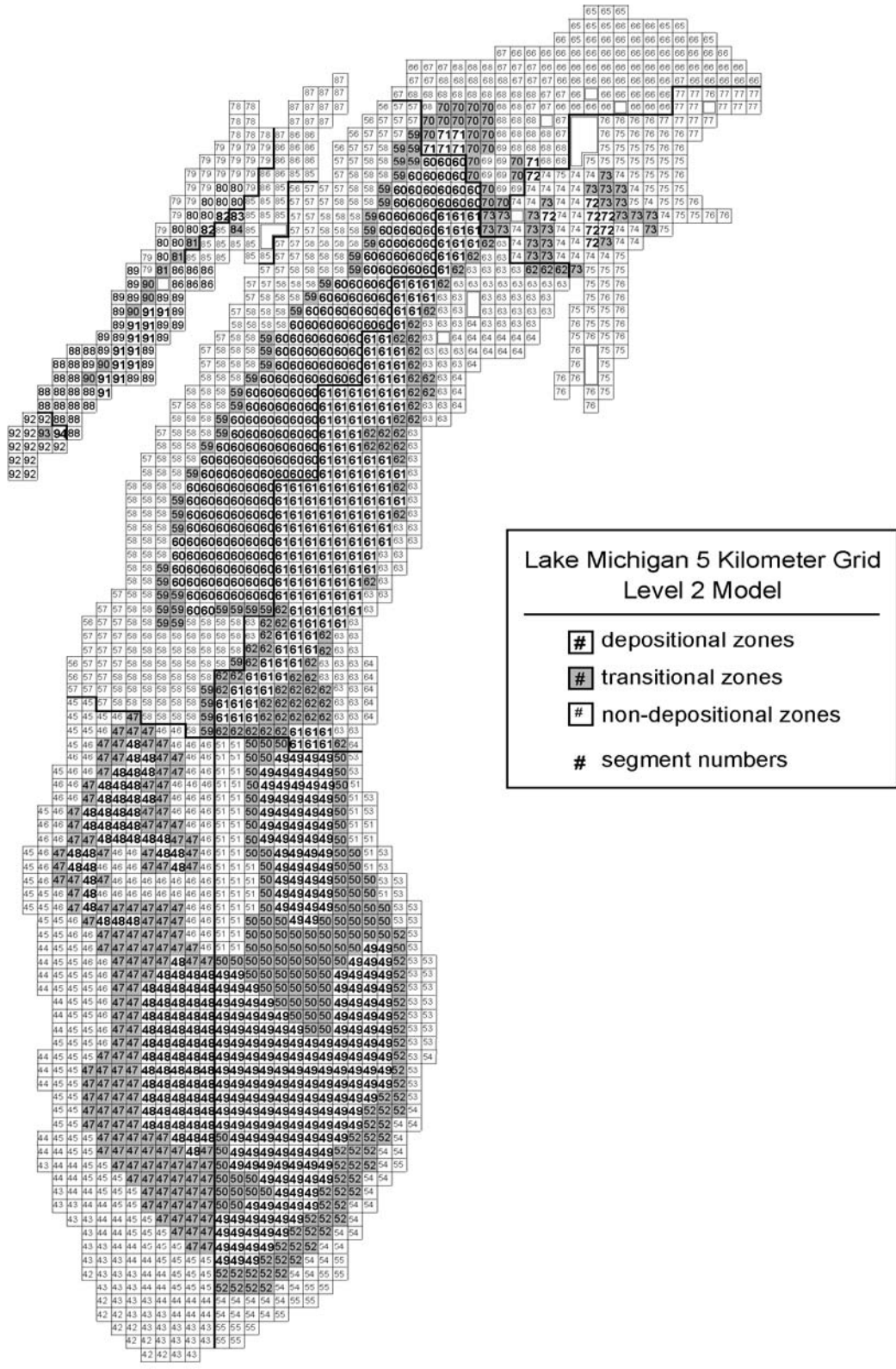

Figure 4.3.2. Surface sediment segmentation for the LM2-Toxic model.

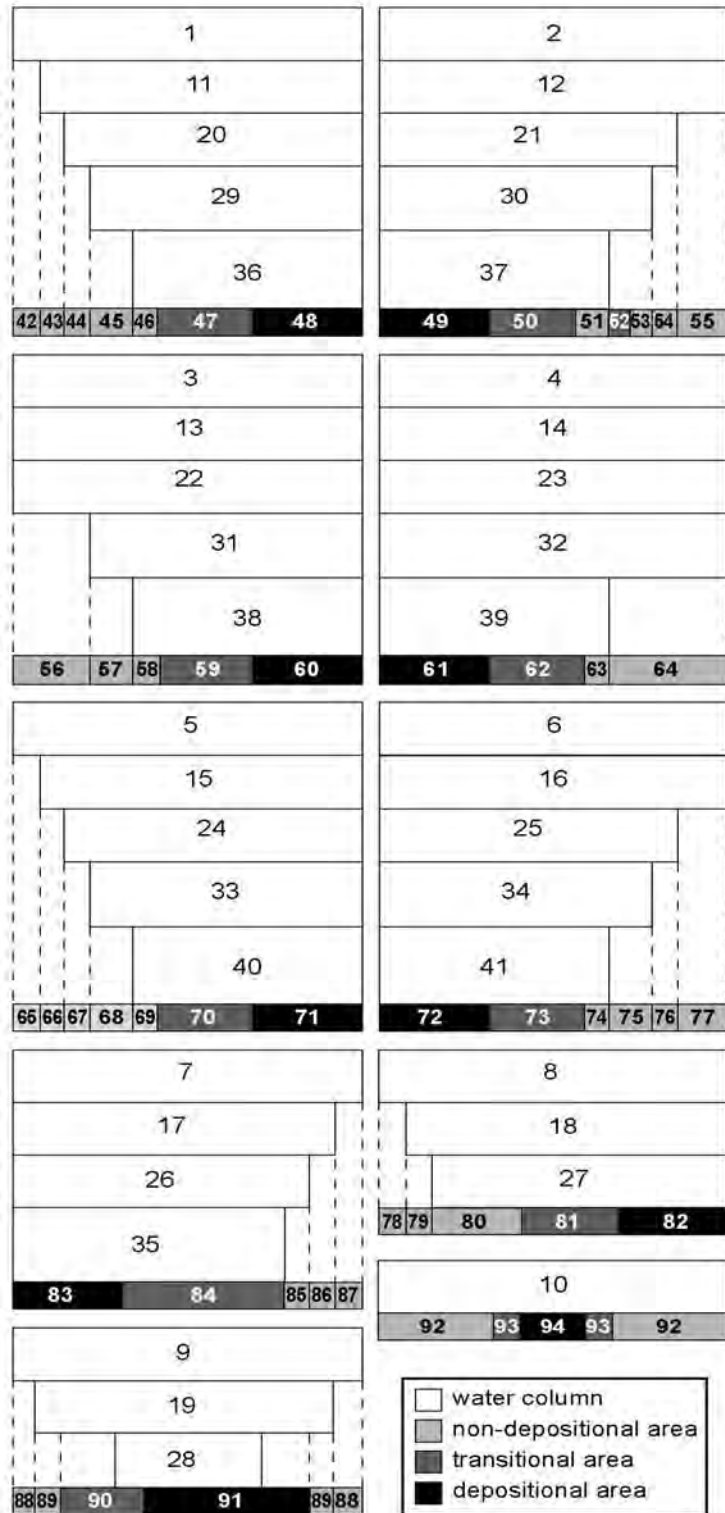

Figure 4.3.3. Cross-sectional sediment segmentation and overlying water column segments for 10 Lake Michigan and four Green Bay water columns.

different from the one used in MICHTOX. The surficial sediment was differentiated into non-depositional areas, transitional areas, and depositional areas (Figure 4.3.2). The areas in a surficial sediment segment were not necessarily adjacent to each other. The surficial mixing sediment layer was not uniformly distributed and its thickness varied from 1 to 4 cm in transitional and depositional areas.

The principal criteria considered for the LM2-Toxic model water column segmentation were the following:

1. Circulation patterns (Schwab and Beletsky, 1998).
2. Bathymetry (Schwab and Beletsky, 1998).
3. Horizontal and vertical gradients of temperature and concerned constituent concentrations.
4. Comparability to MICHTOX segmentation and its results.

The principal criteria considered for the LM2-Toxic model surficial sediment segmentation were the following:

1. Bathymetry data – 5 x 5 km grid (Schwab and Beletsky, 1998).
2. Distribution of sediment characteristics (Cahill, 1981; Robbins *et al.*, 1999).
3. Results generated from the LMMBP sediment measurements – box cores, ponar, and gravity samples (Robbins *et al.*, 1999; Eadie and Lozano, 1999).

Geometry-related data used in the LM2-Toxic model such as volumes, surface areas, and average thickness of all segments are listed in Tables 4.3.1 and 4.3.2.

4.3.2.2 Temporal Resolution

Two levels of temporal resolution for model inputs and outputs were applied to LM2-Toxic. One was a daily time scale that was used for the LM2-Toxic calibrations. Another was a monthly time scale that

was used for the purpose of long-term forecasts to be used as a lake management tool. Both temporal resolutions were detailed enough for physical and chemical processes in the lake that occur at monthly or seasonal time scales, such as thermal stratification, general water circulation patterns, carbon internal loads (primary production), PCB atmospheric concentrations, and resuspension. Final interpretation of carbon and PCB mass budgets and the results from long-term load reduction scenarios on a lake-wide basis were at an annual time scale using annually averaged results.

4.3.3 Water Balance

Water balance is one of the major components in a traditional water quality modeling framework. Water movement directly controls the transport of solids and chemicals in dissolved and particulate phases in a water system. In terms of LM2-Toxic model inputs, the data in transport fields such as advective flows and dispersive exchanges or mixing were used to describe the water balance in the model. The components and their sources used in LM2-Toxic model transport fields are listed below:

1. Bi-direction horizontal advective flows (provided by David Schwab, NOAA; originally based on Schwab and Beletsky, 1998).
2. Net vertical advective flows (provided by David Schwab, NOAA; originally based on Schwab and Beletsky, 1998).
3. Tributary flows and flows across the Straits of Mackinaw (Endicott *et al.*, 2005; Quinn, 1977).
4. Water balancing flows.
5. Vertical dispersion coefficients.

Components such as precipitation, evaporation, and groundwater infiltration were not considered in the water transport fields used in the LM2-Toxic model.

Correct water circulation is essential for the accuracy of outputs from the LM2-Toxic model. The Princeton Ocean Model (POM) has been demonstrated for its ability to accurately simulate water movement for a given large water body (Schwab and Beletsky, 1997; Blumberg and Mellor, 1987). Using an extensively

Table 4.3.1. Geometry Data for Water Column Segments and Lake Michigan (Total)

Segment Number	Volume (m³)	Average Thickness (m)	Surface Area (m²)	Water Segment Above
1	1.2729E+11	9.97	1.2750E+10	
2	1.3000E+11	10	1.3000E+10	
3	1.1475E+11	10	1.1475E+10	
4	8.6000E+10	10	8.6000E+09	
5	4.0850E+10	9.95	4.1000E+09	
6	3.8500E+10	10	3.8500E+09	
7	1.1925E+10	9.25	1.2750E+09	
8	1.1475E+10	9.7	1.1750E+09	
9	1.3213E+10	9.49	1.3750E+09	
10	1.7250E+09	4.36	3.5000E+08	
11	1.2123E+11	9.66	1.2500E+10	1
12	1.2924E+11	9.93	1.3000E+10	2
13	1.1475E+11	10	1.1475E+10	3
14	8.6000E+10	10	8.6000E+09	4
15	3.1775E+10	8.05	3.8500E+09	5
16	3.7263E+10	9.63	3.8500E+09	6
17	8.4125E+09	8.44	9.7500E+08	7
18	7.7625E+09	7.48	1.0000E+09	8
19	6.4375E+09	6.34	9.5000E+08	9
20	1.1214E+11	9.6	1.1625E+10	11
21	1.2303E+11	9.69	1.2650E+10	12
22	1.1444E+11	9.97	1.1475E+10	13
23	8.6000E+10	10	8.6000E+09	14
24	1.9625E+10	8.99	2.1500E+09	15
25	3.1988E+10	9.1	3.4750E+09	16
26	3.7625E+09	6.36	5.5000E+08	17
27	2.1500E+09	4.53	4.2500E+08	18
28	5.3750E+08	2.13	2.0000E+08	19
29	1.9198E+11	18.01	1.0600E+10	20
30	2.1649E+11	18.22	1.1825E+10	21
31	2.1339E+11	18.85	1.1275E+10	22
32	1.6908E+11	19.63	8.6000E+09	23
33	2.4813E+10	14.55	1.6750E+09	24
34	4.2725E+10	15.63	2.7000E+09	25
35	2.8750E+08	4.5	5.0000E+07	26
36	3.6038E+11	42.01	8.4750E+09	29
37	4.6783E+11	48.1	9.6250E+09	30
38	7.8266E+11	79.58	9.8000E+09	31
39	6.8133E+11	84.05	8.0750E+09	32
40	1.6913E+10	19.38	8.5000E+08	33
41	3.4625E+10	21.11	1.6000E+09	34
Total	4.8148E+12		5.7950E+10	

Table 4.3.2. Initial Geometry Data for Surficial Sediment Segments and Surficial Sediment Layer (Total)

Segment Number	Volume (m³)	Average Thickness (m)	Surface Area (m²)	Water Segment Above
42	2.5000E+05	0.001	2.5000E+08	1
43	8.7500E+05	0.001	8.7500E+08	11
44	1.0250E+06	0.001	1.0250E+09	20
45	2.1250E+06	0.001	2.1250E+09	29
46	2.6975E+07	0.013	2.0750E+09	36
47	6.8850E+07	0.018	3.8250E+09	36
48	6.4375E+07	0.025	2.5750E+09	36
49	1.8058E+08	0.031	5.8250E+09	37
50	7.6850E+07	0.029	2.6500E+09	37
51	2.1850E+07	0.019	1.1500E+09	37
52	1.6500E+07	0.012	1.3750E+09	30
53	8.2500E+05	0.001	8.2500E+08	30
54	8.2500E+05	0.001	8.2500E+08	21
55	3.5000E+05	0.001	3.5000E+08	12
56	2.0000E+05	0.001	2.0000E+08	22
57	1.4750E+06	0.001	1.4750E+09	31
58	4.9725E+07	0.013	3.8250E+09	38
59	2.1850E+07	0.019	1.1500E+09	38
60	1.3510E+08	0.028	4.8250E+09	38
61	1.0985E+08	0.026	4.2250E+09	39
62	5.0375E+07	0.031	1.6250E+09	39
63	3.5600E+07	0.016	2.2250E+09	39
64	5.2500E+06	0.010	5.2500E+08	32
65	2.5000E+05	0.001	2.5000E+08	5
66	1.7000E+06	0.001	1.7000E+09	15
67	4.7500E+05	0.001	4.7500E+08	24
68	8.2500E+05	0.001	8.2500E+08	33
69	1.7500E+06	0.010	1.7500E+08	40
70	1.2600E+07	0.024	5.2500E+08	40
71	4.5000E+06	0.030	1.5000E+08	40
72	2.0000E+06	0.010	2.0000E+08	41
73	6.8750E+06	0.011	6.2500E+08	41
74	7.7500E+06	0.010	7.7500E+08	41
75	1.1000E+06	0.001	1.1000E+09	34
76	7.7500E+05	0.001	7.7500E+08	25
77	3.7500E+05	0.001	3.7500E+08	16
78	7.0000E+06	0.04	1.7500E+08	8
79	2.3000E+07	0.04	5.7500E+08	18
80	1.2000E+07	0.04	3.0000E+08	27
81	3.0000E+06	0.04	7.5000E+07	27
82	2.0000E+06	0.04	5.0000E+07	27
83	1.0000E+06	0.04	2.5000E+07	35
84	1.0000E+06	0.04	2.5000E+07	35
85	2.0000E+07	0.04	5.0000E+08	26
86	1.7000E+07	0.04	4.2500E+08	17
87	1.2000E+07	0.04	3.0000E+08	7
88	1.7000E+07	0.04	4.2500E+08	9
89	2.0000E+07	0.04	5.0000E+08	19
90	5.0000E+06	0.04	1.2500E+08	19,28
91	1.3000E+07	0.04	3.2500E+08	19,28
92	1.2000E+07	0.04	3.0000E+08	10
93	1.0000E+06	0.04	2.5000E+07	10
94	1.0000E+06	0.04	2.5000E+07	10
Total	1.0871E+09		5.7950E+10	

tested version of POM for the Great Lakes (POMGL), transport fields were generated for Lake Michigan at different spatial and temporal resolutions for use in a series of mass balance models adapted for LMMBP (Schwab and Beletsky, 1998). The hydrodynamic model for Lake Michigan had 20 vertical levels and a uniform horizontal grid size of 5 km (Schwab and Beletsky, 1998). Because the LM2-Toxic model segmentation was constructed based on the 5 x 5 km² grid used in the POMGL for Lake Michigan, the hydrodynamic model results were easily aggregated to the resolution used in LM2-Toxic (Schwab and Beletsky, 1998). The aggregated horizontal bi-direction flows at each interface provided a good approximation of horizontal advective and dispersive transport components at the interface. The advantage of using bi-direction flows at an interface was that it bypassed the tedious and necessary horizontal dispersion coefficient calibration procedure required when only net flow is available at the interface.

The vertical transport field was calculated in the form of net vertical flow (provided by David Schwab, NOAA; originally based on Schwab and Beletsky, 1998). Therefore, vertical exchange coefficients were calculated and calibrated to define the vertical mixing process between vertically adjacent segments. A summer period of strong stratification and a non-stratified period of intense vertical mixing were the most important limnological features of the Great Lakes (Chapra and Reckhow, 1983; Thomann and Mueller, 1987). Therefore, determining the dynamics of vertical mixing was considered as an important task in modeling development for the LMMBP. A thermal balance model was constructed to calibrate the vertical exchange coefficients at the interfaces (Zhang *et al.*, 1998, 2000). The coefficients were calibrated using 250 observed vertical temperature profiles collected at 40 stations in Lake Michigan during the 1994-1995 LMMBP period. The model calibration results versus temperature measurements in each water column segment and temporal plots of calibrated exchange coefficients are listed in Appendix 4.5.1. A detailed discussion on how the thermal model was run can be found in Part 4, Chapter 4.

Water balancing flow was another advective component added into the water transport field for LM2-Toxic. The aggregated advective flows

provided by NOAA were not balanced in individual segments over the two-year LMMBP period. However, the total water mass was perfectly balanced on a whole lake basis. Over the two-year LMMBP period, some segments lost or gained a certain amount of water. This problem could be very significant for long-term simulations for the LM2-Toxic. It stops the model simulation once the volume of a segment reached zero. To counter the amount lost or gained in each segment, a balancing flow was introduced to keep the volume of water unchanged in each segment at any time during the simulation. The balancing flows were generated based on the aggregated advective flows (provided by David Schwab, NOAA; originally based on Schwab and Beletsky, 1998), original volume of each segment, and the general water circulation patterns during the LMMBP period.

Tributary flows and flows through the Straits of Mackinac were based on MICHTOX model inputs (Endicott *et al.*, 2005), literature (Quinn, 1977), and water circulation patterns during the LMMBP period (provided by David Schwab, NOAA; originally based on Schwab and Beletsky, 1998).

After vertical exchange coefficients were calibrated, a conservative constituent, chloride, was simulated using the LM2 model configuration to verify that the water transport components described above were a good representation of the overall water transport field for the LM2-Toxic. The chloride model was run just once without adjusting any parameter or coefficient. The model results had very good agreement with the observations during the LMMBP period (Appendix 4.5.4). A detailed discussion of the chloride results can be found in Part 4, Chapters 4 and 5.

4.3.4 Solid Balance

PCBs have an affinity for organic carbon. Each type of organic carbon sorbs PCBs differently. Settling rates and resuspension rates, decay rates, etc., impact the organic carbon fractions. Figure 4.3.4 shows the conceptual framework and the processes related to organic carbon sorbent dynamics in Lake Michigan. Three organic carbon sorbents were simulated as state variables in LM2-Toxic. They were biotic carbon (BIC), particulate detrital carbon (PDC), and dissolved organic carbon (DOC). BIC

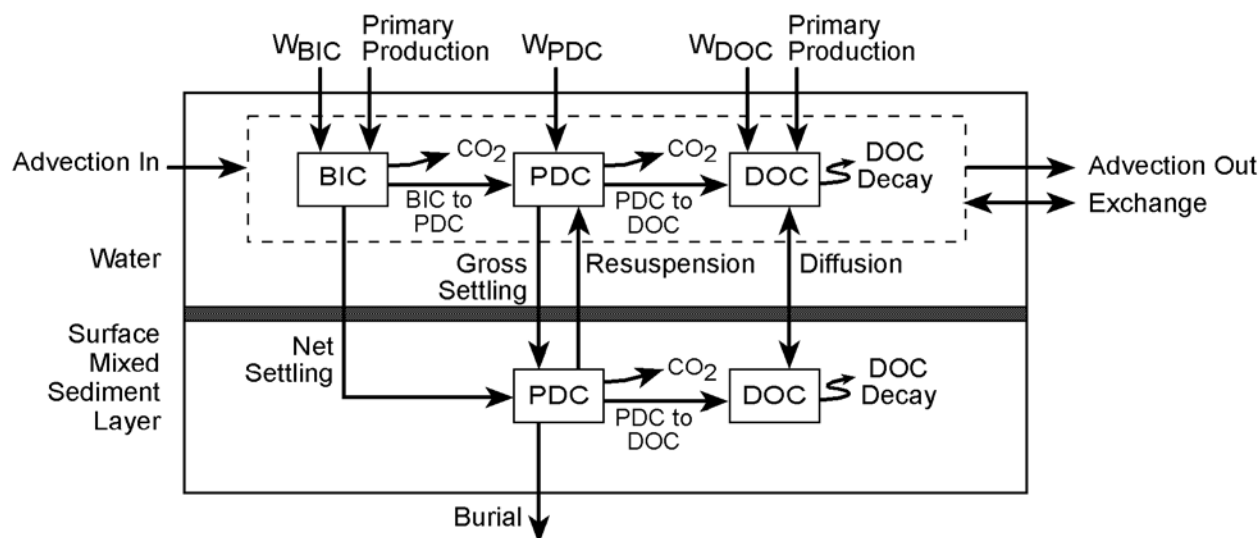

BIC = Biotic Carbon; PDC = Particulate Detrital Carbon;
 DOC = Dissolved Organic Carbon; W = Load

Figure 4.3.4. Conceptual framework of organic carbon sorbent dynamics used in the LM2-Toxic model.

represented particulate organic carbon (POC) in live phytoplankton biomass. PDC represented particulate detrital carbon derived from phytoplankton decomposition, zooplankton excretion, and allochthonous sources. DOC represented colloidal-sized particles that pass through ashed 47 mm diameter glass fibers (U.S. Environmental Protection Agency, 1997).

Other than the components related to the water transport field, numerous processes were considered important in controlling the three organic carbon solids concentrations in either the water column or sediment or both (Table 4.3.3).

The segment-specific internal primary production load generated from the eutrophication model (LM3-Eutro) was a crucial input to the LM2-Toxic. Primary production is the dominant organic carbon load to Lake Michigan. LM3-Eutro generated primary production accounted for over 90 percent of the total POC load to the lake. Further discussions on parameterization of processes such as organic carbon sorbent decay and resuspension are presented in the following sections. In Chapter 4, detailed discussion of the input data used in the processes related to organic carbon dynamics will be provided.

4.3.4.1 Solid Kinetics

Decay of organic carbon sorbent was the only kinetic process considered for solid dynamics in the LM2-Toxic. This process transforms significant amounts of carbon species in both the water column and sediment segments. To capture general carbon sorbent loss mechanisms in the water column without introducing too much complication, pseudo-first-order carbon decay rates for BIC, PDC, and DOC were formulated as Michaelis-Menten functions of respective carbon concentrations and then temperature-corrected according to an Arrhenius relationship with a temperature coefficient, $\theta = 1.05$ (Bierman *et al.*, 1992). The decay equations for the three organic carbon sorbents in water column are:

$$K_{d(BIC)} = \left(\frac{\hat{K}_{d(BIC)} * C_{BIC}}{K_{1/2(BIC)} + C_{BIC}} \right) * \theta^{(T-20)} \quad (4.3.3)$$

$$K_{d(PDC)} = \left(\frac{\hat{K}_{d(PDC)} * C_{PDC}}{K_{1/2(PDC)} + C_{PDC}} \right) * \theta^{(T-20)} \quad (4.3.4)$$

Table 4.3.3. Processes Considered in Organic Carbon Sorbent Dynamics Constructed for the LM2-Toxic

Biotic Carbon (BIC)	Particulate Detrital Carbon (PDC)	Dissolved Organic Carbon (DOC)
External Tributary Loads	External Tributary Loads	External Tributary Loads
Internal Primary Production Loads	Yield From BIC Decay	Internal Loads Derived From Primary Production Loads
Net Settling	Gross Settling	Yield From PDC Decay
Decay and Yield to PDC	Resuspension	Diffusion at Sediment-Water Interface
	Decay and Yield to DOC in Both Water Column and Sediments	Decay in Both Water Column and Sediments
	Burial to Deeper Subsurface Sediment Layer	

$$k_{d(DOC)} = \left(\frac{\hat{k}_{d(DOC)} * C_{DOC}}{k_{1/2(DOC)} + C_{DOC}} \right) * \theta^{(T-20)} \quad (4.3.5)$$

where

k_d = decay rate of a carbon sorbent in water column (d^{-1})

\hat{k}_d = substrate saturated decay rate of a carbon sorbent in water column at 20°C (d^{-1})

$k_{1/2}$ = Michaelis-Menten half-saturation constant for a carbon sorbent in water column (mg C/L); where C = carbon, L = liter

C = segment-specific concentration of a carbon sorbent in water column (mg C/L); where C = carbon, L = liter

θ = Arrhenius temperature coefficient (dimensionless)

T = measured segment-specific temperature (°C)

Therefore, the final decay rates for the carbon sorbents were temperature- and spatially-dependent.

The rates were calculated at each time step during the model simulation period. Simpler equations were used for decay of carbon species in the surficial segments. BIC in sediments was assumed to be zero. The equations used for PDC and DOC decay in sediments were:

$$\begin{aligned} k_{ds(DOC)} &= \bar{k}_{ds(DOC)} * \theta^{(T-20)} \\ k_{ds(PDC)} &= \bar{k}_{ds(PDC)} * \theta^{(T-20)} \end{aligned} \quad (4.3.6)$$

where

k_{ds} = segment-specific and temperature-dependent decay rate of a carbon sorbent in sediments (d^{-1})

\bar{k}_{ds} = decay rate of a carbon sorbent in sediment at 20°C

T = measured segment-specific temperature (°C)

4.3.4.2 Sediment Transport

The transport and fate of PCBs in natural waters and sediments are governed by the transport and fate of POC. Based on the data collected during the

LMMBP period, sediment PCB concentrations were approximately four or five orders of magnitude higher than water column PCB concentrations. The interaction between the water column and surficial sediments for POC was critical to PCB dynamics, mass budget, and especially long-term concentration in the lake. Therefore, it was necessary to describe the important processes involved in vertical particle transport, including settling velocity, resuspension rate, and burial rate within the LM2-Toxic. There is no unique set of carbon solids transport rates that could be determined without the aid of a solids tracer compound (Thomann and Di Toro, 1983; DePinto, 1994). Even though the burial rate could be fixed based on the Pb-210 core dating technique, there still was an infinite set of settling and resuspension rates that could close the solids mass balance for vertical particle transport.

4.3.4.2.1 Steady-State Resuspension Calibration

The overall modeling design for the LM2-Toxic was intended to minimize the parameters needing to be calibrated. It was originally planned not to calibrate any particle transport parameters, including the sediment resuspension rate. The original plan was that LM3-Eutro and SEDZL would provide carbon sorbent settling velocities and estimate POC resuspension rates, respectively. However, it was not clear in late 1999 that the particle transport rates would be available in time for the LM2-Toxic execution due to the departures of key project personnel. After a series of discussion among staff, it was decided that a steady-state PDC mass balance approach would be used. A similar approach was used for the Green Bay Mass Balance Project (GBMBP) (Bierman *et al.*, 1992). This approach was used to estimate the segment-specific sediment POC resuspension. In the water column, POC = BIC + PDC, while in the sediment, POC = PDC.

There was only one sediment layer specified in LM2-Toxic model segmentation (Figure 4.3.3). The thickness of each surficial mixing sediment segment was estimated based on the surficial sediment mixing layer thickness derived from the LMMBP box cores (Robbins *et al.*, 1999). Figure 4.3.5 shows a schematic of the concepts used for the steady-state PDC mass balance analysis. Due to the simple sediment segmentation within the LM2-Toxic, the procedure for determining the segment-specific

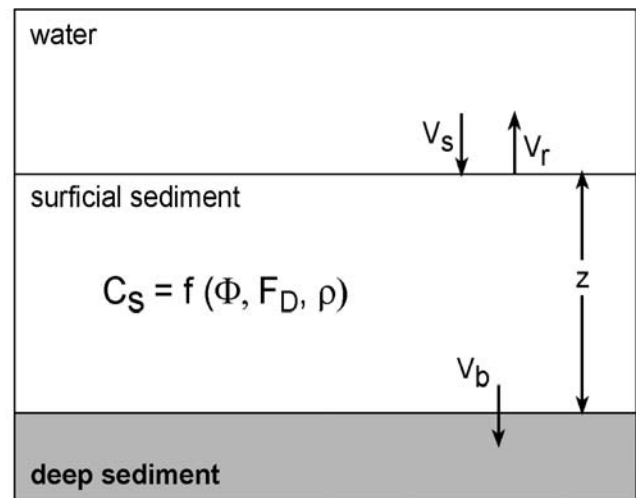

Figure 4.3.5. Schematic of conceptualization for the steady-state mass balance analysis for PDC vertical transport where ϕ = porosity (dimensionless), F_D = fraction of organic carbon, g_{dw}/g , ρ = bulk density of surficial sediments, wet weight, g/cm^3 .

sediment PDC resuspension velocities was much more simplified. The set of PDC mass balance equations for each sediment segment for PDC vertical transport was reduced to only one. The simplified equation can be written as:

$$V_s \frac{dC_s}{dt} = v_s * A * C_w - v_r * A * C_s - v_b * A * C_s - k_{ds} * V_s * C_s \quad (4.3.7)$$

At steady-state, $\frac{dC_s}{dt} = 0$, and $V_s = A * z$, the resuspension velocity can be solved as:

$$v_r = \frac{v_s * C_w - v_b * C_s - k_{ds} * z * C_s}{C_s} \quad (4.3.8)$$

where

V_s = volume of the surficial sediment segment (m^3)

C_s = bulk concentration of PDC in the surficial sediment segment ($mg C/m^3$); where C = carbon

v_s = PDC gross settling velocity (m/d)

A = PDC settling area for a surficial sediment segment (m²)

C_w = effective PDC concentration in water column segment right above the sediment segment (mg C/m³); where C = carbon. $C_w = C_{wPDC} + (v_{sBIC}/v_{sPDC}) * C_{wBIC}$, where v_{sBIC} = BIC gross settling velocity, m/d; $v_{sPDC} = v_s$ = PDC gross settling velocity, m/d; C_{wPDC} = PDC concentration in the water column segment, mg C/m³; C_{wBIC} = BIC concentration in the water column segment, mg C/m³.

v_r = PDC resuspension velocity (m/d)

v_b = sediment (PDC) burial rate (m/d)

k_{ds} = PDC decay rate in sediments (d⁻¹)

z = thickness of the surficial sediment mixing layer (m)

Equation 4.3.8 was manipulated differently for different sediment zones. In the areas where the water depth was greater than 100 m, resuspension was considered as non-wave-induced resuspension. The resuspension rates in these areas were directly calculated using Equation 4.3.8. Although it is arguable that there is any resuspension in the area above which the water is deeper than 100 m (Part 1, Chapter 4), the resuspension rate used in LM2-Toxic was estimated. This was because of a lack of available sediment transport models that were well tested for not only accurately computing sediment resuspension rate, but also satisfying the particle mass balance in both water column and sediments under this kind of coarse spatial resolution used in LM2-Toxic. After combining wave height information for Lake Michigan estimated for the LMMBP period, resuspension velocities in non-depositional areas were computed using empirical wave-induced resuspension derived from Equation 4.3.8. Further detailed data reductions and discussion of the parameters used in Equation 4.3.8 will be provided in Chapters 4 and 5.

4.3.4.2.2 Empirical Wave-Induced Resuspension Calculation

An equation similar to the one used in the GBMBP (Bierman *et al.*, 1992) was developed for LM2-Toxic

to estimate the resuspension rates in non-depositional zones. The equation is:

$$v_r = \alpha(W - W_{cr}) \quad (4.3.9)$$

where

v_r = estimated daily, segment-specific resuspension velocity (m/d)

W = segment-specific surface daily average wave height (m)

W_{cr} = segment-specific critical wave height for the segment below which there is no wave-induced resuspension (m)

α = segment-specific empirical wave coefficient (d⁻¹)

Due to lack of accurate ice cover information and winter concentrations of BIC and PDC during the LMMBP period, it was not feasible to estimate the segment-specific base ($W < W_{cr}$) resuspension velocity (v_{r0} , i.e., non-wave-induced resuspension in non-depositional area) formulated in the original wind-induced resuspension calculation presented in the GBMBP report (Bierman *et al.*, 1992). Therefore, v_{r0} was removed from the original formula used in the GBMBP report (Bierman *et al.*, 1992). This made the resuspension in the non-depositional areas a function of wave heights, as shown in Equation 4.3.9.

As part of the LMMBP, Schwab and Beletsky, using the NOAA/Great Lakes Environmental Research Laboratory (GLERL) Donelan wave model, generated surface wave heights (Schwab and Beletsky, 1998). These values were made available on a high-resolution grid of 5 x 5 km² and on time scales of one-hour. These data were then averaged and aggregated on a daily basis for the 53 sediment segments used in LM2-Toxic. The segment-specific empirical wave coefficient (α) was estimated using the following equation:

$$\bar{v}_r = \alpha \left[\frac{1}{n} \sum_j^n (W_j - W_{cr}) \right] \quad (4.3.10)$$

where

\bar{v}_r = segment-specific average resuspension velocity calculated for Equation 4.3.8 (m/d)

n = number of days during LMMBP period

W_j = segment-specific daily wave height (m)

Note: The term $(W_j - W_{cr})$ in the Equation 4.3.10 becomes zero when $W_j < W_{cr}$.

The Equation 4.3.10 was derived under the assumption that the cumulative resuspension flux computed from Equation 4.3.9 on a daily basis for the LMMBP period was equal to the total resuspension flux computed for the same period from the steady-state sediment carbon mass balance in Equation 4.3.8. The empirical wave coefficient (α) was then formulated as:

$$\alpha = \frac{\bar{v}_r}{\frac{1}{n} \sum_j^n (W_j - W_{cr})} \quad 4.3.11$$

The segment-specific critical wave height (W_{cr}) was a very crucial parameter for calculating wave-induced resuspension flux. The availability of field data relating local resuspension to surface critical wave heights was extremely important for defining the segment-specific or depth-specific critical wave heights in this approach. Fortunately, a relatively good set of the wave-induced resuspension field data (Appendix 4.3.1) was available to use with a great deal of help from Nathan Hawley at NOAA/GLERL (Hawley, 1999). The data set included the critical wave heights required for resuspension and the water depths at which local sediment resuspension was observed. These data were based on 30 deployments during 1994-2000 for which sediment concentration near the bed were plotted against the wave heights from the GLERL/Donelan wave model (Schwab and Beletsky, 1998). Figure 4.3.6 shows deployment locations in Lake Michigan during this period (Lesht and Hawley, 1987; Hawley, 1999; Hawley, 2001). The details on this method are discussed in Lesht and Hawley (1987) and Hawley (1999, 2001). The deployment locations were limited to the southwest region of the lake and the number of the deployments were relatively small. There were

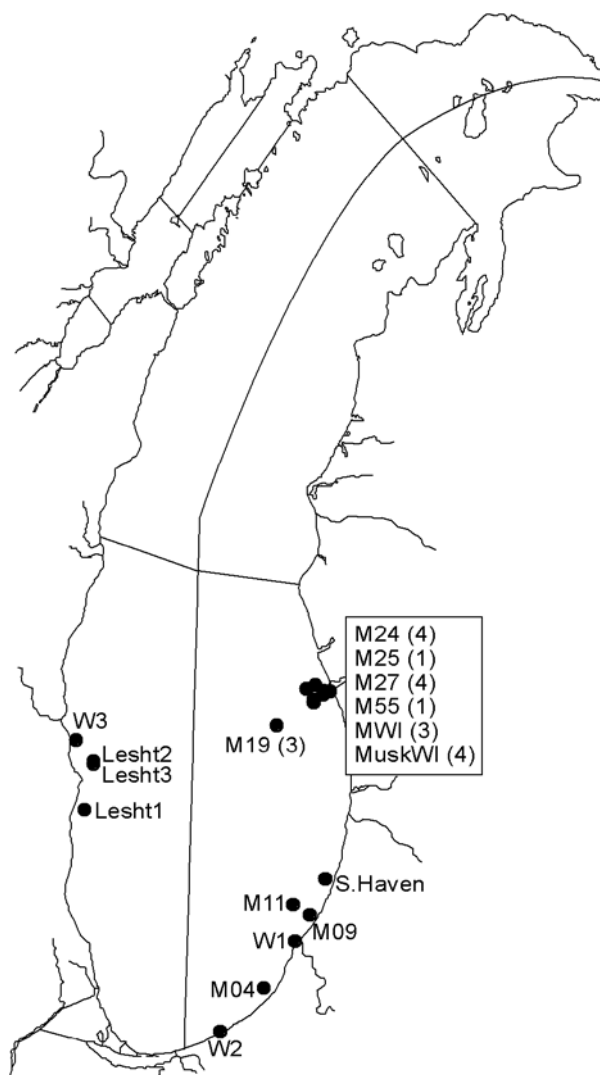

Figure 4.3.6. Locations of the 30 deployments between 1994 and 2000.

indications that for similar water depths, different surface critical wave heights were required to resuspend sediment in different regions of the lake (Hawley, 2001). However, the data set was the best available data (Appendix 4.3.1) and was applied to the sediment segments within the depositional area.

Based on this data set, a simple linear regression was performed on the data (deployment depth, critical wave height) for stations at which local resuspension occurred (Figure 4.3.7). Visual examination of Figure 4.3.7 revealed that the linear regression line was a reasonable approximation of

Relation b/w Critical Wave Height and Station Depth

(Data provided by Nathan Hawley, NOAA, GLERL)

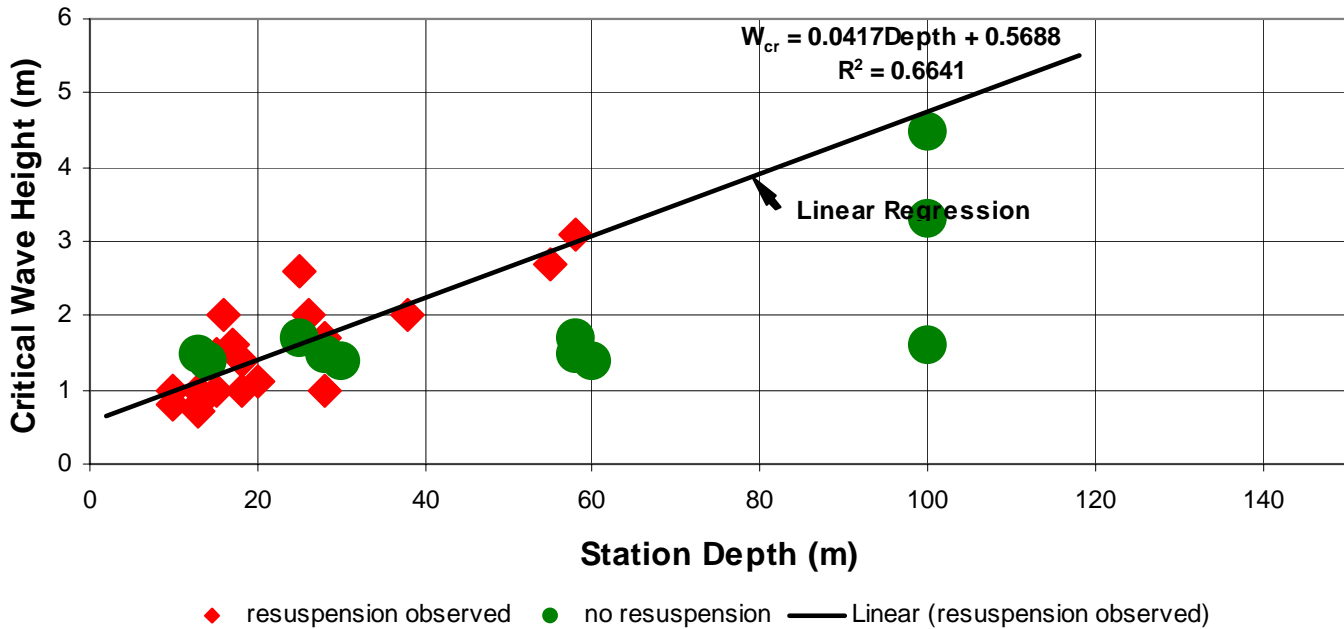

Figure 4.3.7. Regression analysis on the data set (resuspension observed only). For the convenience of the viewer, the data at the stations with no resuspension observed are also put on this plot.

the relationship between water depth and critical wave heights.

Assuming this linear relationship between the critical wave height and water depth, the parameterization of the segment-specific critical wave height (W_{cr}) is:

$$W_{cr} = 0.0417 * \text{Depth} + 0.5688 \quad (4.3.12)$$

where

Depth = deployment depth at the resuspension station (m)

Therefore, the daily wave-induced resuspension in the non-depositional area was calculated using Equation 4.3.9 given the segment-specific parameters α and W_{cr} .

For the 30 deployments used to calculate the relationship, there were 11 cases with no resuspension observed. These deployments were either at very large depths or occurred during the

stratified period. Previous observations (Lesht and Hawley, 1987; Hawley, 1999; Hawley and Lesht, 1995; Hawley and Murthy, 1995), combined with those listed in Appendix 4.3.1, lead to the conclusion that resuspension events during the stratified period are confined to shallow water regions (< 13 m) where the epilimnion was the entire water column. It is arguable whether Equation 4.3.12 should be applied to both unstratified and stratified periods. Based on Nathan Hawley's suggestion (Hawley, 2001) and data in Appendix 4.3.1, separate criteria for unstratified and stratified periods were unnecessary. Therefore, it was decided that the Equation 4.3.12 would be used in the wave-induced resuspension calculation without considering seasonal variability.

4.3.4.2.3 The Sediment Bed – Semi-Lagrangian Option

Another important aspect related to sediment transport was constructing the sediment bed. The Semi-Lagrangian sediment bed option in IPX Version 2.74 (Velleux *et al.*, 2000) was incorporated into the

LM2-Toxic model by taking advantage of the flexibility in IPX, which allows a moving sediment-water interface. Unlike the Eulerian option, the Semi-Lagrangian option does not allow material to move into or out of the modeled system across the sediment bottom boundary. Therefore, the system being modeled would not be artificially introducing or losing mass through the sediment bed, especially for cases when the total inventory of sediments is not well-defined. In this option, the solids concentration in all sediment segments was held constant. The volume (thickness) of all surficial sediment segments was allowed to vary from their initial values in response to net settling and net resuspension fluxes. In response to net settling (deposition), the thickness of the surficial sediment segment increased, and the segment was split into two vertically adjacent segments when its maximum thickness was reached. In response to net resuspension (scouring), the thickness of the surficial sediment segment decreased, and the subsurface sediment segment replaced the surficial sediment segment when its minimum thickness was reached. When there was not enough sediment to be resuspended, the

resuspension was stopped regardless of the resuspension velocity specified. Once sediment was deposited, the resuspension was resumed in the surficial sediment segment.

4.3.5 Chemical Balance

The transport and fate of hydrophobic organic chemicals such as PCBs are closely linked to the movement of carbon sorbents. The approaches used in the past to model PCBs for the Great Lakes were based on either homolog or total PCBs. LM2-Toxic is a PCB congener-based model. It simulates 54 PCB congeners that accounted for roughly 70% of the total PCB mass in Lake Michigan. Figure 4.3.8 shows the conceptual framework and processes related to PCB dynamics in Lake Michigan. Four phases were simulated in the LM2-Toxic for the congeners. The four phases were dissolved, sorbed to PDC, sorbed to BIC, and bound to DOC. The processes considered important for PCB dynamics in Lake Michigan water column and sediments are:

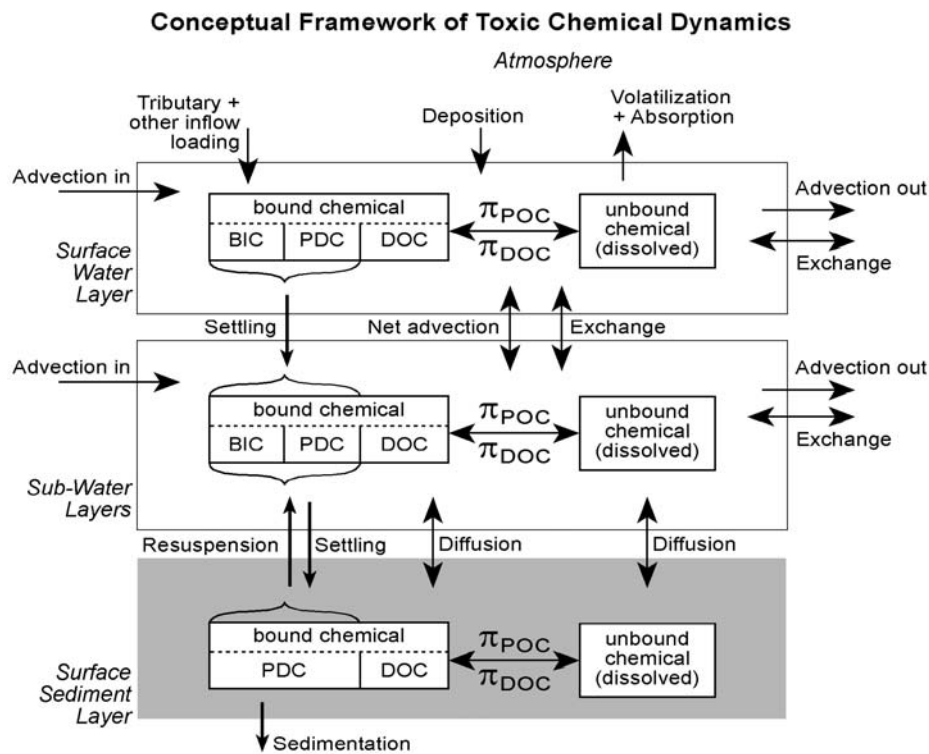

Figure 4.3.8. Conceptual framework used by the LM2-Toxic model for PCB congeners in Lake Michigan.

- Equilibrium partitioning between dissolved phase and sorbed phases of PCBs.
- Air-water exchange of dissolved PCBs including both volatilization and absorption.
- External loadings of PCBs including tributary loads and atmospheric wet and dry deposition.
- Gross settling of particulate PCBs.
- Resuspension of particulate PCBs.
- Pore-water diffusion of dissolved PCBs at the sediment-water interface.
- Advection across interfaces between water segments.
- Dispersion of PCBs across interfaces between water segments.
- Sediment burial of PCBs.

The following subsections present detailed descriptions of PCB equilibrium partitioning, PCB air-water exchange, and parameters associated with these processes.

4.3.5.1 PCB Partitioning

Due to PCBs' hydrophobic nature, the partitioning process and the movement of organic carbon particles were very important for describing the transport and fate of PCBs in Lake Michigan. Therefore, estimation of PCB partitioning coefficients was one of the major steps to secure a successful calibration of LM2-Toxic.

Partitioning of a hydrophobic organic contaminant such as PCBs in a dilute water system is, in general, governed by the following relationship (Eadie *et al.*, 1990, 1992; Bierman *et al.*, 1992):

$$K_p = \frac{C_p}{mC_d} \quad (4.3.13)$$

where

K_p = partitioning coefficient (L/kg)

C_p = particle associated contaminant (PCBs) concentration (kg/L)

m = sorbent (either total suspended solid, total suspended matter (TSM), or POC in LM2-Toxic concentration (kg/L)

C_d = dissolved PCBs concentration (kg/L)

Based on this fundamental equation, two of the many partition theories have been widely used to describe the distribution of PCBs in a diluted water system such as a lake or a river. These were a two-phase PCB partitioning model and a three-phase PCB partitioning model (Swackhamer and Armstrong, 1987; Eadie *et al.*, 1990, 1992; Bierman *et al.*, 1992).

In the two-phase PCB partitioning model, PCBs is either in dissolved phases or in a particulate phase. The dissolved phases include both dissolved PCBs and PCBs sorbed to DOC. The particulate phase is the PCBs sorbed to POC (POC = BIC + PDC). The partition coefficient is described as:

$$K'_{POC,\alpha} = \frac{C_{POC}}{[POC] C_{d,\alpha}} \quad (4.3.14)$$

where

$K'_{POC,\alpha}$ = *in situ* partition coefficient for PCBs on POC (L/kg OC)

C_{POC} = concentration of PCBs bound to POC (kg/L)

$[POC]$ = concentration of POC (kg OC/L)

$C_{d,\alpha}$ = concentration of PCBs in an analytically defined dissolved phase (i.e., dissolved and sorbed to DOC) (kg/L)

The two-phase model is a very simple, straightforward method and most commonly used to quickly compute the *in situ* POC partition coefficients ($K'_{POC,\alpha}$) for PCB congeners without using sophisticated statistical analysis. The computed $K'_{POC,\alpha}$ can then be conveniently compared to the measured octanol-water partition coefficient K_{OW} (Karickhoff, 1981; Baker and Eisenreich, 1986; Swackhamer and Armstrong, 1987; Bierman *et al.*, 1992).

In the three-phase PCB partitioning model, PCBs was distributed between the dissolved, POC particulate, and DOC particulate phases. The partition coefficients are defined as follows:

$$K_{DOC} = \frac{C_{DOC}}{[DOC] C_d} \quad (4.3.15)$$

and

$$K'_{POC} = \frac{C_{POC}}{[POC] C_d} \quad (4.3.16)$$

where

K_{DOC} = partition coefficient for PCBs on DOC (L/kg OC)

K'_{POC} = *in situ* partition coefficient for PCBs on POC (L/kg OC)

$[DOC]$ = DOC concentration (kg OC/L)

C_{DOC} = concentration of PCBs bound to DOC (kg/L)

C_d = dissolved PCB concentrations (kg/L)

The total concentration of PCBs (C_T) equals the sum of the three phases:

$$\begin{aligned} C_T &= C_d + C_{DOC} + C_{POC} \\ &= C_d(1 + K_{DOC}[DOC] + K'_{POC}[POC]) \end{aligned} \quad (4.3.17)$$

Because of the difficulty of directly measuring dissolved PCB concentrations (C_d), the POC (K'_{POC}) partition coefficients had to be estimated using either a simple linear regression technique (Brannon *et al.*, 1991; Bierman *et al.*, 1992) or a statistical analysis such as a combination of the Levenberg-Marquardt nonlinear least squares routine and root mean square error algorithm (Bierman *et al.*, 1992). The initial estimation of the K'_{POC} and K_{DOC} for each selected PCB congener (total 40 congeners) was done by applying the simple linear regression technique to the following equation for the LMMBP-generated data (see Karickhoff *et al.*, 1979 and

Bierman *et al.*, 1992 for detailed derivation of this equation).

$$\frac{C_{d,\alpha} [POC]}{C_{POC}} = \frac{K_{DOC}}{K'_{POC}} [DOC] + \frac{1}{K'_{POC}} \quad (4.3.18)$$

The terms on the left-hand side and $[DOC]$ on the right-hand side are the measured concentrations for each water column sample. The simple linear regression was applied to the above equation to yield a slope of K_{DOC}/K'_{POC} and an intercept of $1/K'_{POC}$. From this, both partition coefficients K'_{POC} and K_{DOC} were calculated. Pairs of partition coefficients were estimated by repeating the regression analysis for each PCB congener selected.

After a thorough analysis of the PCB congener partitioning coefficient results estimated using both the two- and three-phase partitioning models, the two-phase partitioning model was selected as the approach to initially compute the POC partition coefficients ($K'_{POC,\alpha}$) that would be used in LM2-Toxic. It was selected because 1) the two-phase partitioning model was simple and very efficient in terms of data analysis procedure; 2) though the regression technique used in the three-phase partitioning model worked well for a well-behaved system, it was not applicable to a natural water system with heterogeneous organic carbon concentrations, PCB characteristics, and PCB concentrations; and 3) the three-phase model-estimated PCB congener partitioning coefficients on DOC (K_{DOC}) did not have similar trends as the ones on POC (K'_{POC}). Previous publications suggested that the K_{DOC} and K'_{POC} of PCB congeners should have similar variation trends, and that the value of K_{DOC} should be within 1 to 2 orders of magnitude less than the value of K'_{POC} (Carter and Suffet, 1982; Landrum *et al.*, 1984, 1987; Hassett and Milicic, 1985; Chiou *et al.*, 1986, 1987; Eadie *et al.*, 1990, 1992; Bierman *et al.*, 1992).

4.3.5.2 PCB Air-Water Exchange

Previous studies (Endicott *et al.*, 2005; Endicott, 2005; DePinto *et al.*, 2003) have suggested that net volatilization to the atmosphere may be the predominant loss mechanism for hydrophobic organic contaminants such as PCBs in Great Lakes. Therefore, it was very important to precisely compute

the net PCB mass transfer across the water-air interface in order to satisfy the overall PCBs inventory and mass budget in the Lake Michigan system for the LMMBP period, and forecast PCB concentrations in both the water column and sediments with a certain degree of confidence. The mass change rate term ($S_{\alpha w,j}$) for PCBs due to air-water exchange processes in Equation 4.3.19 was calculated as a product of the overall net mass exchange flux and surface area of the water segment j.

$$S_{\alpha w,j} = \left[k_{ol} * (C_{dw,j} - \frac{C_{\alpha,j}}{H'}) \right] * A_j \quad (4.3.19)$$

where

k_{ol} = the overall mass exchange rate coefficient (m/d)

C_{dw} = dissolved PCB concentrations in water (ng/m³)

C_{α} = atmospheric PCB concentrations (ng/m³)

H' = temperature dependent Henry's Law Constant for a PCB congener (dimensionless)

A_j = surface area of the water segment j (m²)

The overall mass exchange rate coefficient (k_{ol}) was calculated using the Whitman two-film theory formulation (Whitman, 1923) given as:

$$k_{ol} = \frac{1}{\frac{1}{k_l} + \frac{1}{K_g * H'}} \quad (4.3.20)$$

where

k_l = the liquid film mass transfer rate coefficient (m/d)

k_g = the gas film mass transfer rate coefficient (m/d)

The LMMBP Atmospheric Workgroup recommended that the Wanninkhoff (Wanninkhoff, 1992) formulation for water mass transfer resistance and the

Schwarzenbach (Schwarzenbach *et al.*, 1993) formulation for gas mass transfer resistance were the most appropriate for modeling the air-water exchange of PCBs in Lake Michigan. The Wanninkhoff equation for k_l , with correction for PCBs molecular diffusivity in reference to carbon dioxide (CO₂) molecular diffusivity across the air-water interface, is given as:

$$k_l = 0.45 * \left(\frac{D_w}{D_{L_{CO_2}}} \right)^{\frac{1}{2}} * u_{10}^{1.64} \quad (4.3.21)$$

where

D_w = chemical molecular diffusivity in water (cm²/s)

$D_{L_{CO_2}}$ = CO₂ molecular diffusivity in water (cm²/s)

u_{10} = wind velocity measured at 10 m above water surface (m/s)

The Schwarzenbach formulation for k_g with correction of PCB molecular diffusivity in reference to water vapor molecular diffusivity across the air-water interface is given as:

$$k_g = (0.2 * u_{10} + 0.3) * \left(\frac{D_{\alpha}}{D_{g_{H_2O}}} \right)^{0.61} \quad (4.3.22)$$

where

D_{α} = chemical molecular diffusivity in air (cm²/m)

$D_{g_{H_2O}}$ = water vapor molecular diffusivity in gas phase (cm²/m)

Another recommendation from the LMMBP Atmospheric Workgroup was to use the equation of Henry's Law Constant for PCB congeners updated by Bamford using recently developed data (Bamford *et al.*, 2000). The equation originated from the Gibbs-Helmholtz equation as:

$$\ln H' = - \frac{\Delta H_H}{R * T} + \frac{\Delta S_H}{R} \quad (4.3.23)$$

Afer rearranging the equation, the temperature dependent Henry's Law constant is given as:

$$H' = e^{\left(-\frac{\Delta H_H}{R \cdot T} + \frac{\Delta S_H}{R}\right)} \quad (4.3.24)$$

where

H' = temperature dependent Henry's Law Constant (dimensionless)

ΔH_H = the enthalpy of phase change for a PCB congener (kJ/mol)

ΔS_H = the entropy of phase change for a PCB congener (kJ/mol)

R = the ideal gas constant, 8.315×10^{-3} kJ/(mol)(°K)

T = interfacial temperature (°K)

These volatilization formulas were coded into subroutines of LM2-Toxic, and the parameters H' , k_r , and k_g were calculated at every time step for each LM2-Toxic segment.

4.3.5.3 PCB-Specific Parameterization

PCB congener-specific parameters input into LM2-Toxic model included PCB congener partitioning coefficients, molecular weight, enthalpy, and entropy. Chapter 4 of this part provides detailed information on the values used in the LM2-Toxic for these parameters, their data sources, and parameterization procedures.

4.3.6 Modification

LM2-Toxic features some important updates from both the IPX and GBTOX models. The project-specific modifications were:

- Incorporation of organic carbon sorbent dynamics used in GBMBP (Bierman *et al.*, 1992).
- Organic carbon kinetic processes and biotransformation.
- Incorporation of the quasi-Lagrangian framework for sediment transport scheme used in the IPX model.

- Added the Gibbs-Helmholtz formulation (Bamford *et al.*, 2000) to compute the Henry's Law Constant for PCB congeners.

- Added the Wanninkhoff formulation for liquid film mass transfer rate coefficient and the Schwarzenbach formulation for gas film transfer rate coefficient in the PCB overall volatilization equations.

- Para meterization of segment-specific resuspension velocity of carbon sorbent (PDC) as a function of daily average wave height.

- Added subroutines for performing segment-specific and lake-wide mass budget calculations, a very useful tool to identify programming errors, to identify artificial gain/loss of solid/chemical mass to a water system, and to construct overall mass budget for the system simulated.

- Capability for specifying segment-specific and daily water temperature time functions.

- Capability for specifying segment-specific and daily air temperature time functions.

- Capability for specifying segment-specific and daily wind speed time functions.

- Capability for specifying segment-specific, PCB congener-specific, and daily atmospheric PCB concentration time functions.

- Reorganization/rewrite of many subroutines and minor bug fixes to Euler integration. Use of utility libraries and organized error handling (UT library) in the codes. Modification to input format - using FIREAD.

LM2-Toxic was developed and tested on both the Unix and the Linux platforms and used both FORTRAN 77 and FORTRAN 90 compilers.

References

- Ambrose, R.B., T.A. Wool, J.P. Connolly, and R.W. Shanz. 1988. WASP4, A Hydrodynamic and Water Quality Model - Model Theory, User's Manual and Programmer's Guide. U.S. Environmental Protection Agency, Office of Research and Development, Environmental Research Laboratory, Athens, Georgia. EPA/600/3-87/039, 297 pp.
- Baker, J.E. and S.J. Eisenreich. 1986. Influence of Colloids on Sediment-Water Partition Coefficients of Polychlorobiphenyl Congeners in Natural Waters. *Environ. Sci. Technol.*, 20(11):1136-1143.
- Bamford, H.A., J.H. Offenberg, R.K. Larsen, F.C. Ko, J.E. Baker. 1999. Diffusive Exchange of Polycyclic Aromatic Hydrocarbons Across the Air-Water Interface of the Patapsco River, An Urbanized Subestuary of the Chesapeake Bay. *Environ. Sci. Technol.*, 33(13):2138-2144.
- Bamford, H.A., D.L. Poster, and J.E. Baker. 2000. Henry's Law Constant of Polychlorinated Biphenyl Congeners and Their Variation With Temperature. *J. Chem. Engin.*, 45:1069-1074.
- Bierman, V.J., Jr., J.V. DePinto, T.C. Young, P.W. Rodgers, S.C. Martin, and R. Raghunathan. 1992. Development and Validation of an Integrated Exposure Model for Toxic Chemicals in Green Bay, Lake Michigan. U.S. Environmental Protection Agency, Office of Research and Development, ERL-Duluth, Large Lakes Research Station, Grosse Ile, Michigan. 381 pp.
- Blumberg, A.F. and G.L. Mellor. 1987. A Description of a Three-Dimensional Coastal Ocean Circulation Model. In: N.S. Neaps (Ed.), *Three Dimensional Coastal Ocean Models, Coastal and Estuarine Sciences*, pp. 1-16. American Geophysical Union, Washington, D.C.
- Brannon, J.M., T.E. Myers, D. Gunnison, and C.B. Price. 1991. Nonconstant Polychlorinated Biphenyl Partitioning in New Bedford Harbor Sediment During Sequential Batch Leaching. *Environ. Sci. Technol.*, 25(6):1082-1087.
- Cahill, R.A. 1981. *Geochemistry of Recent Lake Michigan Sediments*. Illinois Geological Survey, Champaign, Illinois. Circular 517, 94 pp.
- Carter, C.W. and I.H. Suffett. 1982. Binding of DDT to Dissolved Humic Materials. *Environ. Sci. Technol.*, 16(11):735-740.
- Chapra, S.C. and K.H. Reckhow (Eds.). 1983. *Engineering Approaches for Lake Management, Volume 2: Mechanistic Modeling*. Ann Arbor Science Publishers, Ann Arbor, Michigan. 492 pp.
- Chiou, C.T., R.L. Malcolm, T.I. Brinton, and D.E. Kile. 1986. Water Solubility Enhancement of Some Organic Pollutants and Pesticides by Dissolved Humic and Fulvic Acids. *Environ. Sci. Technol.*, 20(5):502-508.
- Chiou, C.T., D.E. Kile, E.I. Brinton, R.L. Malcolm, and J.A. Leenheer. 1987. A Comparison of Water Solubility Enhancements of Organic Solutes by Aquatic Humic Materials and Commercial Humic Acids. *Environ. Sci. Technol.*, 21(12):1231-1234.
- DePinto, J.V. 1994. Role of Mass Balance Modeling in Research and Management of Toxic Chemicals in the Great Lakes. *The Green Bay Mass Balance Study. Great Lakes Res. Rev.*, 1(1):1-8.
- DePinto, J.V., W.M. Larson, J. Kaur, and J. Atkinson. 2003. *LOTOX2 Model Documentation - In Support of Development of Load Reduction Strategies and a TMDL for PCBs in Lake Ontario*. Submitted to New England Interstate Water Pollution Control Commission, Boott Mills South, Lowell, Massachusetts. 122 pp.
- Eadie, B.J., N.R. Morehead, and P.F. Landrum. 1990. Three-Phase Partitioning of Hydrophobic Organic Compounds in Great Lakes Waters. *Chemosphere*, 20(1/2):161-178.
- Eadie, B.J., N.R. Morehead, J.V. Klump, and P.F. Landrum. 1992. Distribution of Hydrophobic Organic Compounds Between Dissolved and Particulate Organic Matter in Green Bay Waters. *J. Great Lakes Res.*, 18(1):91-97.

-
- Eadie, B.J. and S. Lozano. 1999. Grain Size Distribution of the Surface Sediments Collected During the Lake Michigan Mass Balance and Environmental Mapping and Assessment Programs. National Oceanic and Atmospheric Administration, Great Lakes Environmental Research Laboratory, Ann Arbor, Michigan. NOAA Technical Memorandum ERL GLERL-111, 42 pp.
- Endicott, D.D. 2005. 2002 Lake Michigan Mass Balance Project: Modeling Total PCBs Using the MICHTOX Model. In: R. Rossmann (Ed.), MICHTOX: A Mass Balance and Bioaccumulation Model for Toxic Chemicals in Lake Michigan, Part 2. U.S. Environmental Protection Agency, Office of Research and Development, National Health and Environmental Effects Research Laboratory, MED-Duluth, Large Lakes Research Station, Grosse Ile, Michigan. EPA/600/R-05/158, 140 pp.
- Endicott, D.D., W.L. Richardson, and D.J. Kandt. 2005. 1992 MICHTOX: A Mass Balance and Bioaccumulation Model for Toxic Chemicals in Lake Michigan. In: R. Rossmann (Ed.), MICHTOX: A Mass Balance and Bioaccumulation Model for Toxic Chemicals in Lake Michigan, Part 1. U.S. Environmental Protection Agency, Office of Research and Development, National Health and Environmental Effects Research Laboratory, MED-Duluth, Large Lakes Research Station, Grosse Ile, Michigan. EPA/600/R-05/158, 140 pp.
- Hassett, J.P. and E. Milicic. 1985. Determination of Equilibrium and Rate Constants for Binding of a Polychlorinated Biphenyl Congener by Dissolved Humic Substances. Environ. Sci. Technol., 19(7):638-643.
- Hawley, N. and B.M. Lesht. 1995. Does Local Resuspension Maintain the Benthic Boundary Layer in Lake Michigan? J. Sediment. Res., 65:69-76.
- Hawley, N. and C.R. Murthy. 1995. The Response of the Benthic Nepheloid Layer to a Downwelling Event. J. Great Lakes Res., 21(4):641-651.
- Hawley, N. 1999. Sediment Resuspension and Transport in Lake Michigan. Final Report. U.S. Environmental Protection Agency, Office of Research and Development, ERL-Duluth, Large Lakes Research Station, Grosse Ile, Michigan. 240 pp.
- Hawley, N. 2001. Critical Wave Heights. National Oceanic and Atmospheric Administration, Great Lakes Environmental Research Laboratory, Ann Arbor, Michigan. E-mail sent to Xiaomi Zhang on February 1, 2001 (Appendices 4.3.1 and 4.3.2).
- Karickhoff, S.W., D.S. Brown, and T.A. Scott. 1979. Sorption of Hydrophobic Pollutants on Natural Sediments. Water Res., 13(3):241-248.
- Karickhoff, S.W. 1981. Semi-Empirical Estimation of Hydrophobic Pollutants on Natural Sediments and Soils. Chemosphere, 10(8):833-846.
- Landrum, P.F., S.R. Nihart, B.J. Eadie, and W.S. Gardner. 1984. Reverse-Phase Separation Method for Determining Pollutant Binding to Aldrich Humic Acid and Dissolved Organic Carbon of Natural Waters. Environ. Sci. Technol., 18(3):187-192.
- Landrum, P.F., S.R. Nihart, B.J. Eadie, and L.R. Herche. 1987. Reduction in Bioavailability of Organic Contaminants to the Amphipod *Pontoporeia hoyi* by Dissolved Organic Matter of Sediment Interstitial Waters. Environ. Toxicol. Chem., 6(1):11-20.
- Lesht, B.M. and N. Hawley. 1987. Near-Bottom Currents and Suspended Sediment Concentrations in Southeastern Lake Michigan. J. Great Lakes Res., 13(3):375-386.
- Quinn, F.H. 1977. Annual and Seasonal Flow Variations Through the Straits of Mackinac. Water Resources Res., 13(1):137-144.

-
- Robbins, J.A., N.R. Morehead, R.W. Rood, D.N. Edgington, and S. Meyer. 1999. Accumulation and Near-Surface Mixing of Sediments in Lake Michigan as Determined for the Lake Michigan Mass Balance Program, Volumes 1 and 2. Project Report. U.S. Environmental Protection Agency, Office of Research and Development, ERL-Duluth, Large Lakes Research Station, Grosse Ile, Michigan. 503 pp.
- Schwab, D.J. and D. Beletsky. 1997. Modeling Thermal Structure and Circulation in Lake Michigan. In: Estuarine and Coastal Modeling, pp. 511-522. Proceedings of the 5th International Conference of the American Society of Civil Engineers, Alexandria, Virginia. October 22-24, 1997.
- Schwab, D. and D. Beletsky. 1998. Lake Michigan Mass Balance Study: Hydrodynamic Modeling Project. National Oceanic and Atmospheric Administration, Great Lakes Environmental Research Laboratory, Ann Arbor, Michigan. NOAA Technical Memorandum ERL GLERL-108, 53 pp.
- Schwarzenbach, R.P., P.M. Gschwend, and D.M. Imboden. 1993. Environmental Organic Chemistry. John Wiley and Sons, Incorporated, New York, New York. 681 pp.
- Settles, M. 1997. IPX: A Review of Planning and Development. U.S. Environmental Protection Agency, Office of Research and Development, ERL-Duluth, Large Lakes Research Station, Grosse Ile, Michigan. Technical Note TEC-16, 11 pp.
- Swackhamer, D.L. and D.E. Armstrong. 1987. Distribution and Characterization of PCBs in Lake Michigan Water. *J. Great Lakes Res.*, 13(1):24-36.
- Thomann, R.V. and D.M. Di Toro. 1983. Physico-Chemical Model of Toxic Substances in the Great Lakes. *J. Great Lakes Res.*, 9(4):474-496.
- Thomann, R.V. and J.V. Mueller. 1987. Principles of Water Quality Modeling and Control. Harper and Row Publishers, New York, New York. 644 pp.
- U.S. Environmental Protection Agency. 1997. Lake Michigan Mass Balance Study (LMMB) Methods Compendium, Volume 1: Sample Collection Techniques. U.S. Environmental Protection Agency, Great Lakes National Program Office, Chicago, Illinois. EPA/905/R-97/012a, 1,440 pp.
- Velleux, M., S. Westenbroek, J. Ruppel, M. Settles, and D.D. Endicott. 2000. A User's Guide to IPX, The In-Place Pollutant Export Water Quality Modeling Framework, Version 2.7.4. U.S. Environmental Protection Agency, Office of Research and Development, National Health and Environmental Effects Research Laboratory, MED-Duluth, Large Lakes Research Station, Grosse Ile, Michigan. 179 pp.
- Wanninkhoff, R., J.R. Ledwell, and J. Crusius. 1991. Gas Transfer Velocities on Lakes Measured with Sulfur Hexafluoride. In: S.C. Wilhelm and J.S. Culliver (Eds.), *Air-Water Mass Transfer*, pp. 441-458. American Society of Civil Engineers, New York, New York.
- Wanninkhoff, R.J. 1992. Relationship Between Gas Exchange and Wind Speed Over the Ocean. *J. Geophys. Res.*, 97:7373-7381.
- Whitman, W.G. 1923. A Preliminary Experimental Confirmation of the Two-Film Theory of Gas Absorption. *Chem. Metall. Eng.*, 29:146-148.
- Zhang, X., D. Endicott, and W. Richardson. 1998. Transport Calibration Model With Level 2 Model Segmentation Scheme. First Lake Michigan Mass Balance Project Science Panel Review, Southgate, Michigan. June 23, 1998. 12 pp.
- Zhang, X., W. Richardson, and K. Rygwelski. 2000. Preparation and Verification Transport Field for LMMBP Level 2 Contaminant: Transport and Fate Models. Second Lake Michigan Mass Balance Project Science Panel Review, Southgate, Michigan. September 27, 2000. 15 pp.

PART 4

LM2-TOXIC

Appendix 4.3.1. Lake Michigan Resuspension Field Data Set (One of the Two Attachments in Nathan Hawley's E-Mail on February 2, 2001)

Station	Deployed	Retrieved	Latitude	Longitude	Depth	Wave Height	Comments
Musk WI	01.11.1994	24.05.1995	43 12.30'N	86 20.83'W	13	0.7	
M24	01.11.1994	24.05.1995	43 13.75'N	86 25.46'W	28	1	
M27	01.11.1994	25.05.1995	43 09.50'N	85 25.87'W	58	3.1	
M19	01.11.1994	24.05.1995	42 02.93'N	86 38.57'W	100	>4.5	No resuspension
Musk WI	25.05.1995	12.07.1995	43 12.30'N	86 20.83'W	13	1	
Musk WI	12.07.1995	21.08.1995	43 12.30'N	86 20.83'W	13	>1.5	No resuspension
M24	12.07.1995	21.08.1995	43 13.75'N	86 25.46'W	28	">1,5"	No resuspension
M27	12.07.1995	21.08.1995	43 09.50'N	86 25.87'W	58	>1.5	No resuspension
M19	12.07.1995	21.08.1995	43 02.93'N	86 38.57'W	100	>1.6	No resuspension
Musk WI	31.08.1995	17.11.1995	43 12.30'N	86 20.83'W	13	0.8	
M24	31.08.1995	17.11.1995	43 13.75'N	86 25.46'W	28	1.7	
M27	31.08.1995	12.10.1995	43 09.50'N	86 25.87'W	58	>1.7	No resuspension
M19	31.08.1995	12.10.1995	43 02.93'N	86 38.57'W	100	>3.3	No resuspension
Lesht1	02.04.1998	30.04.1998	42 39.90'N	87 44.89'W	15	1.5	
Lesht2	23.07.1998	24.08.1998	42 52.22'N	87 42.41'W	25	>1.7	No resuspension
Lesht3	28.10.1998	01.12.1998	42 52.18'N	87 42.41'W	25	2.6	
MWI	24.07.1998	13.08.1998	43 12.32'N	86 20.44'W	14	>1.4	No resuspension
M24	24.07.1998	13.08.1998	43 11.33'N	86 22.76'W	30	>1.4	No resuspension
M27	24.07.1998	13.08.1998	43 10.04'N	86 25.87'W	60	>1.4	No resuspension
W1	15.10.1998	11.11.1999	42 08.09'N	86 29.50'W	10	1	
W2	15.10.1998	20.04.1999	41 44.14'N	86 54.45'W	10	0.8	
W3	27.10.1998	10.05.1999	42 57.50'N	87 48.79'W	16	2	
S Haven	15.10.1999	17.11.1999	42 24.23'N	86 19.68'W	18	1.4	
MO4	03.03.2000	22.05.2000	41 55.58'N	86 39.92'W	20	1.1	
MO9	03.03.2000	22.05.2000	42 14.87'N	86 24.74'W	18	1	
M11	03.03.2000	22.05.2000	42 17.36'N	86 30.60'W	38	2	
MWI	07.04.2000	29.05.2000	43 12.21'N	86 21.00'W	15	1	
MWI	13.09.2000	30.10.2000	43 12.23'N	86 21.32'W	17	1.6	
M25	13.09.2000	30.10.2000	43 12.24'N	86 22.90'W	26	2	
M55	13.09.2000	27.11.2000	43 12.73'N	86 28.65'W	55	2.7	

PART 4

LM2-TOXIC

Appendix 4.3.2. Notes (One of the Two Attachments in Nathan Hawley's E-Mail on February 2, 2001) From Nathan Hawley on the Data Set in Appendix 4.3.1

Dear Xiaomi:

As you requested, I am attaching the spreadsheet with the critical wave heights required for resuspension. These were determined for the thirty deployments by plotting the sediment concentration near the bed against the wave heights from the GLERL wave model. This method was used by Barry and I in our paper analyzing a data set from 1981 (Lesht and Hawley, 1987, Journal of Great Lakes Research, v. 13, 375-386, see fig 6 for an example). In the present case this method assumes that a) high sediment concentrations are caused only by local resuspension, and b) that local resuspension is caused mainly by wave action. If both these assumptions are true then high sediment concentrations will occur only when the wave height exceeds a certain value. For the thirty deployments listed in the spreadsheet, these assumptions appear to hold in about 1/3 of the cases. In another 1/3 of the cases no resuspension occurred at all, in these cases the maximum waves during the deployment can be used as a lower bound for the critical height (the height required for resuspension must exceed the height listed). These deployments were either at a very large depth (M19, 100m) or occurred during the stratified period. In the remaining cases there was no clear critical wave height but resuspension did occur. In these cases, I determined the wave height by visually examining the time series observations of concentration and wave height and then estimating the critical height as best I could. In most cases the results aren't totally consistent (there are instances where waves larger than the critical height do not correlate with increased sediment concentrations), but I did the best I could.

We might do a bit better if we used the combined (waves plus currents) bottom stress as the forcing parameter, but this depends upon the wave period as well, and the wave model doesn't do a real good job of calculating the wave period.

If you look at the data carefully, there are indications that for similar water depths larger waves are required to resuspend sediment on the western side of the lake than on the eastern side. There is also some indication that the sediment properties at a given location vary somewhat throughout the year, but I don't think that there is enough data to say anything more. I did a rough plot of the data and fitted a straight line by eye. My line suggests that a wave height of about 4.8 m would be required to resuspend sediment at 100m.

PART 4

LM2-TOXIC

Chapter 4. Model and Field Data

The inputs necessary for running LM2-Toxic came from two major sources. One was the Lake Michigan Mass Balance Project (LMMBP)-generated data collected between 1994 and 1995. Another was historical data. These were primarily physical, chemical, and biotransformation data. Most of the parameters initially selected for the LM2-Toxic input were from the Green Bay Mass Balance Project (GBMBP) (DePinto *et al.*, 1993). All project-generated data were subjected to quality assurance (QA)/quality control (QC) coordinated by the United States Environmental Protection Agency (USEPA), Great Lakes National Program Office (GLNPO) (McCarty *et al.*, 2004). Detailed descriptions of sampling collection and sample analysis techniques can be found in the LMMB Methods Compendium (U.S. Environmental Protection Agency, 1997). Further analysis and preprocessing of these data followed the guidance detailed in the LMMBP Quality Assurance Project Plan (QAPP) for Mathematical Modeling (Richardson *et al.*, 2004). Descriptions of model input, data analysis procedures to generate the model inputs, and sources of data are described in the following sections.

4.4.1 Water Transport

Advective flows and bulk dispersion between water segments drive the transport of all constituents among water column segments of Lake Michigan. Water transport data was among the major critical inputs for the LM2-Toxic. Water transport fields and associated data sources were provided in Chapter 3.

The following subsections provide additional information on the transport field.

4.4.1.1 Circulation

The advective components of water transport in the LM2-Toxic input consisted of bi-directional horizontal flows, net vertical flows, balancing flows, and tributary and boundary flows. Other than the tributary and boundary flows, all of the flows were expressed as daily time series for the model. Bi-direction horizontal flows and net vertical flows were aggregated and provided by Dr. David Schwab (National Oceanic and Atmospheric Administration [NOAA], Great Lakes Environmental Research Laboratory [GLERL]) based on the 5 x 5 km² grid results from the Princeton Ocean Model for Great Lakes (POMGL, Schwab and Beletsky, 1998). Balancing flows were computed at each interface based on the residual flows for the adjacent segments. The horizontal and vertical flows provided by Dr. David Schwab were 10 days short of the complete two-year LMMBP period. For consistency with other model input time series and convenience to conduct long-term management scenario simulations, a complete two-year time function for advective flows was preferred and necessary. To avoid unnecessary complication, the flows of the last 10 days of 1994 were duplicated at the end of 1995.

Ten tributary flows (Figure 4.4.1) were input into the model input as annual averaged flows. Tributary flows are listed in Table 4.4.1. The boundary flows across the Straits of Mackinac were input into the LM2-Toxic as monthly average flows. The lower returning flows at the boundary entered from segments 15 and 16 and were routed out from



Figure 4.4.1. Locations of 10 tributaries whose flows were considered a part of the water transport used in the LM2-Toxic.

Table 4.4.1. Average Annual Flows of the 10 Monitored Tributaries

Tributary Name	Flow (m³/s)
Milwaukee River	19
Sheboygan River	11
Fox River	199
Menominee River	166
Manistique River	84
Pere Marquette River	30
Muskegon River	98

(Figures 4.3.1 and 4.3.3). Table 4.4.2 presents the monthly boundary flows (i.e., the lower returning flows). Both the tributary and boundary flows were assembled based on the flows used in MICHTOX (Endicott *et al.*, 2005).

4.4.1.2 Vertical Dispersion

Another major component of the water transport field defined/used in the LM2-Toxic input is the vertical dispersion. In order to reasonably estimate the vertical exchange coefficients for the interfaces between vertically adjacent segments, a thermal balance model with the same Level 2 spatial segmentation was used to simulate temperature using LMMBP-generated temperature field measurements. Instead of chloride, temperature was the state variable being simulated. The same data reduction and interpolation procedures used for chloride were used for temperature. Table 4.4.3 lists the initial temperature for 41 segments in the thermal balance model inputs. Table 4.4.4 contains cruise-segment mean temperatures generated using inverse distance weighted interpolated matrix (IDW) and volume-weighted average (VWA). The values listed in Table 4.4.4 were used for comparison with the thermal balance model output. Heat fluxes provided by Dr. David Schwab (Schwab and Beletsky, 1998) were input as loads in the model. The initial estimation of vertical exchange coefficients was computed using a simple equation (Chapra and Reckhow, 1983) presented below.

$$v_t = \frac{V * (dT_l / dt)}{A_t * (T_u - T_l)} \quad (4.4.1)$$

$$E_t = v_t * z_t \quad (4.4.2)$$

where

v_t = vertical heat exchange coefficient across the interface between upper segment and lower segment (m/d)

V = average volume of the upper and lower segments (m³)

T_l = temperature in lower segment (°C)

T_u = temperature in upper segment (°C)

A_t = surface area of the interface between upper segment and lower segment (m²)

t = time, d - days

E_t = vertical exchange coefficient (m²/d)

z_t = mixing length for the upper segment and lower segment (m)

Following a substantial calibration effort, the final set of vertical dispersion coefficients was determined. The calibration results of the thermal balance model were very good. Further discussion on the results will be provided in Chapter 5. The complete calibration results from the thermal balance model and the final set of vertical dispersion coefficient plots are presented in Appendix 4.5.1.

4.4.1.3 Verification of Water Transport Fields

The inputs for the water transport field used in the LM2-Toxic were composed of advective flows and vertical dispersion. The water transport field was verified by simulating chloride, a conservative constituent, in Lake Michigan for the LMMBP period. In addition to the data related to water transport field, chloride tributary loads and segment-specific initial chloride concentrations were the only necessary input data to run the chloride model. Daily chloride tributary loads for the complete two-year period from 11 monitored tributaries (Figure 4.4.2) were calculated using the stratified Beale ratio model (Hall and Robertson, 1998; Beale, 1962; Baun, 1982; Cohn *et al.*, 1989; Richards, 1998). The 18 unmonitored tributary loads were not input into the chloride model because they were not available by the time (June 1999) model executions were finished.

Eight field sampling cruises occurred between April 1994 and October 1995 at 41 water survey stations throughout Lake Michigan, Green Bay, and Lake Huron (Figure 4.4.3). The eight field cruise sampling periods are listed in Table 4.4.5. Multiple field samples were collected at different depths at most of the water survey stations. Some of the samples were duplicates. The segment-specific chloride initial conditions (Table 4.4.6) and eight cruise-segment mean chloride concentrations (Table 4.4.7) were generated using an interpolation procedure that combined the IDW interpolation formulation and a

Table 4.4.2. Monthly Average Flows Across the Straits of Mackinac

Month	Lower Return Flow (m³/s) From Segment 16	Lower Return Flow (m³/s) From Segment 15
January	40	36
February	452	400
March	0	0
April	0	0
May	0	0
June	1500	1034
July	3000	2096
August	2000	1726
September	1000	989
October	0	0
November	0	0
December	0	0

Table 4.4.3. Initial Temperatures in Water Column Segments for the Thermal Balance Model

Segment	Temperature (°C)	Segment	Temperature (°C)
1	2.01	20	2.01
2	2.01	21	2.01
3	1.99	22	2.00
4	1.99	23	2.00
5	2.00	24	2.01
6	2.00	25	2.01
7	1.99	26	2.02
8	1.99	27	2.03
9	2.01	28	2.04
10	2.05	29	2.01
11	2.01	30	2.01
12	2.01	31	2.01
13	2.00	32	2.01
14	2.00	33	2.01
15	2.01	34	2.01
16	2.01	35	2.01
17	2.02	36	2.50
18	2.02	37	2.50
19	2.03	38	2.50
		39	2.50
		40	2.00
		41	2.00

Table 4.4.4. Cruise-Segment Mean Temperatures for the LMMBP Project Period

Segment	Cruise 1	Cruise 2	Cruise 3	Cruise 4	Cruise 6	Cruise 7	Cruise 8
1	3.93	18.95	21.04	2.82	2.37	11.32	15.22
2	4.51	19.02	23.22	3.14	2.36	12.13	15.25
3	2.54	16.29	21.16	2.96	2.30	11.01	15.57
4	2.64	15.28	21.27	2.93	2.50	12.18	14.90
5	1.99	18.02	21.20	2.94	2.05	12.59	17.07
6	1.93	17.86	21.17	2.94	2.01	12.92	16.80
7	2.70	15.61	21.83	0.00	1.56	12.45	16.58
8	2.78	16.06	22.12	0.00	1.48	12.84	16.68
9	4.74	17.07	21.53	0.00	1.26	13.39	16.72
10	4.65	17.03	21.48	0.00	1.26	13.33	16.72
11	3.56	16.28	10.54	2.86	2.38	10.76	13.74
12	3.77	16.26	13.70	3.15	2.38	11.91	14.77
13	2.49	13.50	14.71	2.96	2.31	10.36	14.78
14	2.57	12.25	13.95	2.93	2.51	11.75	14.34
15	2.01	16.47	14.47	2.94	2.06	12.40	16.99
16	1.90	16.17	14.36	2.94	2.00	12.67	16.62
17	2.71	12.41	14.89	0.00	1.57	11.57	16.40
18	2.83	13.19	14.79	0.00	1.48	12.16	16.57
19	4.54	12.20	15.00	0.00	1.27	12.87	16.63
20	3.23	8.23	6.34	2.92	2.35	9.79	8.90
21	3.41	8.89	6.36	3.17	2.34	11.27	10.37
22	2.54	7.63	8.03	2.96	2.33	8.70	11.77
23	2.59	7.13	7.31	2.93	2.53	10.49	11.80
24	2.10	11.08	8.00	2.95	2.06	11.78	14.49
25	1.93	10.05	7.80	2.94	1.98	11.80	13.61
26	2.66	8.15	9.49	0.00	1.59	9.01	13.02
27	2.79	9.00	9.56	0.00	1.49	9.64	13.46
28	4.30	8.82	9.43	0.00	1.29	11.60	14.64
29	2.94	5.40	5.44	3.43	2.34	6.65	5.14
30	2.93	5.64	5.20	3.80	2.24	7.13	5.08
31	2.20	5.41	6.16	3.75	2.40	5.77	6.93
32	2.33	5.04	5.67	3.81	2.57	5.95	6.91
33	2.06	7.60	5.69	3.68	2.08	9.17	9.18
34	1.86	6.39	5.58	3.70	1.88	7.21	7.44
35	2.52	8.65	6.75	0.00	1.39	7.32	8.59
36	2.68	4.13	4.11	4.13	2.42	4.18	4.07
37	2.72	4.05	4.12	4.12	2.40	4.14	4.05
38	2.55	4.04	4.32	4.13	2.58	4.19	4.18
39	2.62	4.03	4.23	4.13	2.59	4.15	4.10
40	2.14	5.31	4.25	4.12	2.01	5.62	5.12
41	1.96	4.51	4.19	4.12	1.80	4.89	4.78

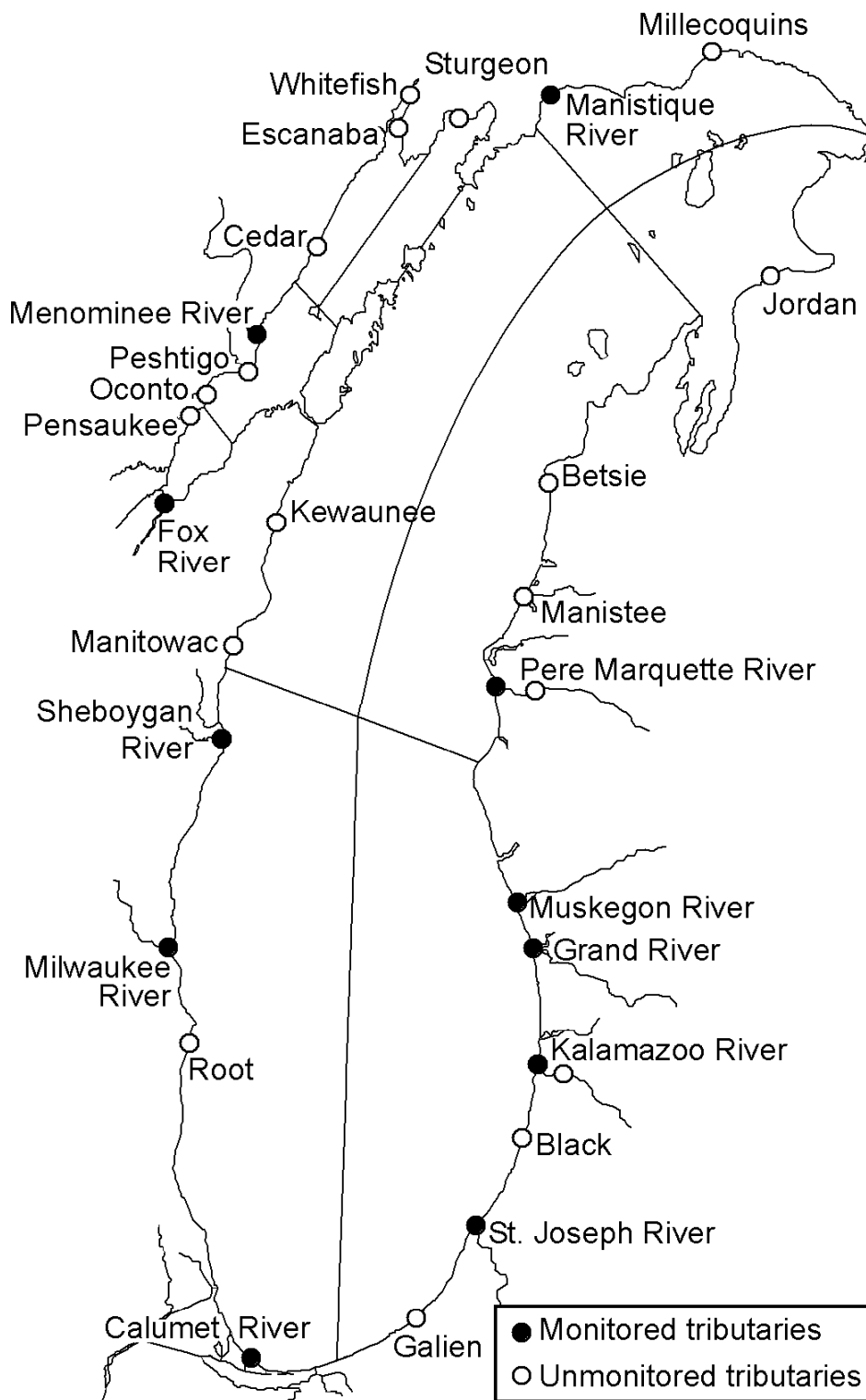

Figure 4.4.2. Locations of monitored and unmonitored tributaries during the LMMBP.

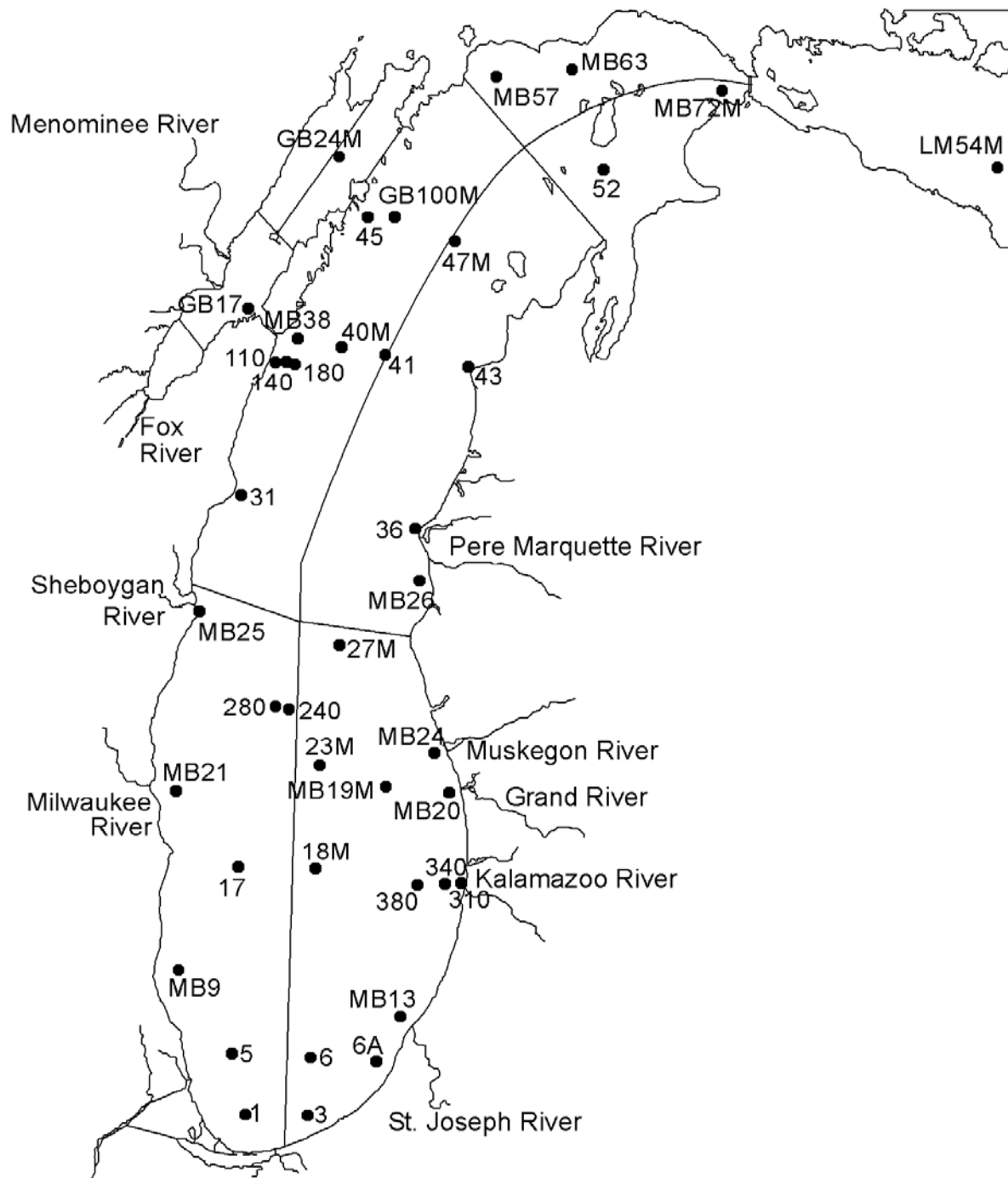

Figure 4.4.3. Lake Michigan water sampling sites during the LMMBP.

Table 4.4.5. The LMMBP Sampling Cruises

Cruise Number	Start Date	End Date
Cruise 1	April 24, 1994	May 11, 1994
Cruise 2	June 17, 1994	June 26, 1994
Cruise 3	August 3, 1994	August 26, 1994
Cruise 4	October 14, 1994	November 7, 1994
Cruise 5	January 16, 1995	January 26, 1995
Cruise 6	March 23, 1995	April 18, 1995
Cruise 7	August 3, 1995	August 16, 1995
Cruise 8	September 16, 1995	October 13, 1995

Table 4.4.6. Initial Chloride Concentrations in Water Column Segments for the Chloride Model

Segment	Chloride (mg/L)	Segment	Chloride (mg/L)
1	10.39	20	10.17
2	10.78	21	10.18
3	10.25	22	10.21
4	10.33	23	10.21
5	9.93	24	10.08
6	9.94	25	9.82
7	10.55	26	10.45
8	10.65	27	10.49
9	12.66	28	10.40
10	12.55	29	10.15
11	10.38	30	10.14
12	10.68	31	10.21
13	10.24	32	10.19
14	10.32	33	10.26
15	9.82	34	10.23
16	9.80	35	10.51
17	10.56	36	10.17
18	10.67	37	10.18
19	12.51	38	10.17
		39	10.16
		40	10.12
		41	10.09

Table 4.4.7. Cruise-Segment Mean Chloride Concentrations for the LMMP Period

Segment	Cruise 1	Cruise 2	Cruise 3	Cruise 4	Cruise 6	Cruise 7	Cruise 8
1	10.39	10.25	10.47	10.45	10.30	10.46	10.40
2	10.78	10.46	10.57	10.55	10.61	10.38	10.47
3	10.25	10.19	10.36	10.23	10.24	10.24	10.36
4	10.33	10.20	10.44	10.30	10.27	10.27	10.39
5	9.93	10.22	10.12	9.79	9.99	10.16	10.22
6	9.94	10.23	10.28	9.86	10.01	10.16	10.27
7	10.55	10.20	10.63	10.45	10.44	10.47	10.53
8	10.65	10.20	10.74	10.51	10.49	10.56	10.58
9	12.66	10.19	11.61	11.09	11.54	10.38	10.94
10	12.55	10.19	11.56	11.05	11.52	10.36	10.92
11	10.38	9.98	10.36	10.43	10.51	10.15	10.34
12	10.68	10.24	10.46	10.58	11.11	10.14	10.46
13	10.24	10.19	10.36	10.26	10.30	10.07	10.33
14	10.32	10.20	10.36	10.32	10.37	9.98	10.36
15	9.82	10.23	10.42	9.74	9.95	8.34	10.16
16	9.80	10.24	10.44	9.80	10.02	8.33	10.20
17	10.56	10.20	10.53	10.43	10.47	10.17	10.53
18	10.67	10.20	10.53	10.49	10.54	10.18	10.59
19	12.51	10.19	11.18	11.01	11.51	10.15	10.91
20	10.17	10.13	10.27	10.39	10.56	10.17	10.23
21	10.18	10.16	10.41	10.58	11.17	10.14	10.32
22	10.21	10.16	10.24	10.23	10.37	10.03	10.26
23	10.21	10.14	10.25	10.31	10.42	10.00	10.32
24	10.08	10.17	9.91	9.76	10.16	8.61	10.03
25	9.82	10.16	9.45	9.41	10.11	8.27	9.90
26	10.45	10.17	10.40	10.39	10.34	9.99	10.36
27	10.49	10.17	10.40	10.48	10.39	10.02	10.45
28	10.40	10.18	10.40	10.90	10.30	10.12	10.87
29	10.15	10.12	10.24	10.29	10.14	10.20	10.21
30	10.14	10.16	10.31	10.28	10.13	10.19	10.24
31	10.21	10.13	10.23	10.18	10.24	10.40	10.26
32	10.19	10.12	10.23	10.18	10.25	10.35	10.28
33	10.26	10.13	10.08	10.05	10.14	10.50	10.31
34	10.23	10.13	10.17	10.14	10.17	10.45	10.29
35	10.51	10.13	10.14	10.22	10.41	10.49	10.36
36	10.17	9.99	10.19	10.19	10.09	10.22	10.15
37	10.18	10.00	10.24	10.24	10.05	10.19	10.17
38	10.17	10.12	10.25	10.19	10.16	10.37	10.26
39	10.16	10.11	10.25	10.20	10.13	10.35	10.25
40	10.12	10.13	10.10	10.14	10.08	10.45	10.31
41	10.09	10.12	10.15	10.17	10.04	10.42	10.31

VWA algorithm (Appendix 4.4.1). The major advantages of this interpolation approach were its convenience and effectiveness. The subroutines/programs of IDW and VWA are widely available in many major software packages. On the other hand, the conventional approach of calculating the arithmetic mean and standard deviation of actual field measurements is constrained by a data theory that is only valid for a randomly sampled data set with normal distribution. Most environmental field samples, including water quality samples, were collected based on biased sampling designs. Appendix 4.4.1 and publications (Lesht, 1988a, b; Bierman *et al.*, 1992) provided further details on the interpolation approach. Lake Michigan chloride distribution was simulated once for the LMMBP period without adjustment on any parameter or coefficient. The results were very good. Further details are presented in Chapter 5. Appendix 4.5.4 provides the complete simulation results from the chloride model.

4.4.2 Organic Carbon

Three carbon sorbents were simulated as principal state variables in the LM2-Toxic. They were dissolved organic carbon (DOC), biotic carbon (BIC), and particulate detrital carbon (PDC). Measured data used for directly generating carbon sorbent concentrations and estimating their loadings were DOC and particulate organic carbon (POC). POC was then divided into BIC and PDC by first applying a fixed carbon/chlorophyll *a* ratio (C:Chl) to estimate BIC (BIC is equal to the product of the ratio and measured chlorophyll *a*). PDC was calculated by subtracting BIC from POC. Negative values were not allowed during the derivation. A final value (see Part 2, LM3-Eutro) Pauer *et al.*, 2005) was selected for splitting BIC and PDC from POC. DOC was characterized as colloidal-sized particles that did not settle. It was assumed that BIC did not accumulate in sediment. Instead, BIC settling to the sediment surface would instantly convert to PDC. DOC had very little variation spatially and temporally throughout the lake. The concentration of DOC was about five times higher than POC (BIC + PDC). The typical concentration of DOC in the lake was 1.6 mg/L. BIC was strongly controlled by seasonal and local phytoplankton blooms and associated dynamics. The typical range of BIC concentrations for the lake was between 0.05 and 0.25 mg/L. PDC

in the lake was highly controlled by phytoplankton decomposition and settling and resuspension processes. Therefore, the variation of PDC in the lake was also seasonally and spatially characterized. The typical range of PDC concentrations varied from 0.1 to 0.25 mg/L in Lake Michigan. The concentration of PDC was doubled or tripled in Green Bay where carbon loads from tributaries and resuspension fluxes were more dominant components than in the main lake. The average PDC concentration range in sediments was from 2,000 to 7,000 mg/L.

4.4.2.1 Loads

Loads of organic carbon sorbents were classified as external and internal. External loads entered the lake from tributaries. Internal loads were generated from gross primary production of phytoplankton within Lake Michigan.

Segment-specific primary production was aggregated from the high-resolution eutrophication model LM3-Eutro. The gross primary production had strong seasonal variations. Figure 4.4.4 shows the seasonal fluctuation of gross primary production generated from the LM3-Eutro for the lake during the LMMBP period. By assuming 20% of gross primary production released from phytoplankton was DOC, the internal loads were then further divided into BIC and DOC (Bierman *et al.*, 1992).

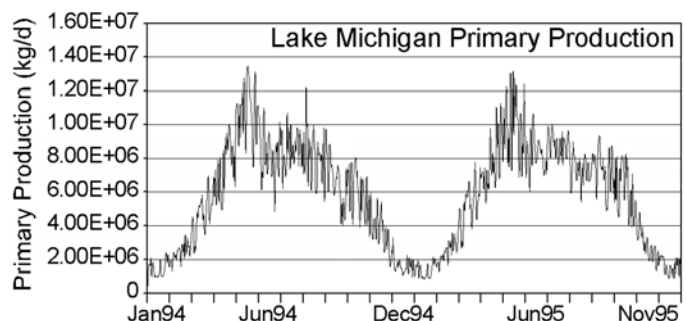

Figure 4.4.4. Primary production generated from the LM3-Eutro for Lake Michigan, including Green Bay.

External loads provided by the United States Geological Survey (USGS) included loads from 11 monitored tributaries and 18 unmonitored tributaries (Hall and Robertson, 1998). Tributary loads were

received as DOC, POC, and chlorophyll loads. A carbon/chlorophyll ratio of 40 was then used to split POC loads into BIC and PDC loads.

Both external and internal loads were input into the LM2-Toxic as daily time functions. Summaries of the annual average organic carbon external and internal loads are presented in Tables 4.4.8, 4.4.9, and 4.4.10. During the two-year LMMBP period, virtually all of BIC load (98.6%) came from internal primary production, virtually all of the POC load (POC = BIC + PDC, 97.3%) came from internal primary production, and 88% of total organic carbon load (TOC = DOC + BIC + PDC) came from internal primary production. Therefore, the internal primary production dictates the level of all three organic carbon concentrations in the lake, and thus, it also influences observed polychlorinated biphenyl (PCB) concentrations in the system, including sediments.

4.4.2.2 Field Data and Initial Conditions

By including some field data (sediment data) collected during the GBMBP, the LMMBP-generated data were used to generate segment-specific water column initial concentrations, sediment concentrations, and cruise-segment mean concentrations for the three organic carbon sorbents simulated in the LM2-Toxic. Samples for water column DOC and POC were collected at 41 water survey stations (Figure 4.4.3) between April 1994 and October 1995. The original POC cruise data were split into BIC and PDC by applying a carbon and chlorophyll *a* ratio of 40. Both the inverse distance and natural-neighbor algorithms (Appendix 4.4.1) were used for interpolation of all three organic carbon concentrations in the water column. In order to choose the best interpolation for the water column carbon data set, the results from both interpolation methods were compared. The two interpolation methods gave quite different results when there were not enough samples and poor spatial resolution. The inverse distance algorithm was selected for the interpolation of the organic carbon sorbents because the interpolation results using the inverse distance algorithm showed more realistic organic carbon distributions in the water column than the ones from the natural-neighbor algorithm. Table 4.4.11 presents the water column initial concentrations of all three organic sorbent state variables used in the LM2-Toxic. The cruise-segment mean

concentrations for DOC, BIC, and PDC are listed in Tables 4.4.12, 4.4.13, and 4.4.14, respectively.

Sediments were collected during the LMMBP sampling period of 1994 and 1995, and sediment organic carbon data were collected and analyzed (Eadie and Robbins, 2004). A total of 116 sediment samples (Figure 4.4.5) were used to generate sediment segment-specific organic carbon concentrations, including 53 box core samples, 60 Ponar grab samples, and three gravity core samples. Among these sediment samples, only four stations (15B1, 41B1, 86B1, and 112B1) had complete vertical profile analysis done for organic carbon; the rest of the stations had only the top 1 cm of sediment analyzed. The reported sediment organic carbon (POC) concentrations were reported as mg carbon per g dry sediment (mg/g_{dw}). In order to convert the unit (mg/g_{dw}) into the standard unit (mg/L, i.e., bulk concentration) used in LM2-Toxic, the following equation was used for the calculation:

$$C_{sPOC}^a = C_{sPOC}^b * \rho * F_D * 10^3 \quad (4.4.3)$$

where

C_{sPOC}^a = POC concentration in surficial sediments (mg/L), the unit required for the LM2-Toxic

C_{sPOC}^b = POC concentration in surficial sediments (mg/g_{dw}), the unit of field measurements

ρ = bulk density of surficial sediments, wet weight (g/cm³). To convert cm³ to L (liter), a factor of 10³ is needed in the equation.

F_D = fraction of organic carbon (g_{dw}/g)

The sediment POC data from the GBMBP were incorporated into the data set to generate the sediment POC contour maps for Lake Michigan, including Green Bay. Figures 4.4.6 and 4.4.7 show the distribution of POC in Lake Michigan sediments in units of mg/g_{dw} and mg/L, respectively. The natural-neighbor algorithm (Appendix 4.4.1) was used for the interpolation and the segment-specific

Table 4.4.8. Annual Average Organic Carbon Loads From 11 Monitored Tributaries to Lake Michigan During the LMMBP

Tributary (Monitored)	DOC (ton/year)	BIC (ton/year)	PDC (ton/year)
Milwaukee River	2508.50	284.13	225.91
Sheboygan River	1549.45	237.09	169.43
Calumet River	1974.49	61.85	426.65
St. Joseph River	18202.45	2688.78	2801.15
Kalamazoo River	10205.13	1585.62	1827.60
Grand River	31922.79	4646.54	3496.82
Muskegon River	13191.20	394.89	881.68
Pere Marquette River	3990.09	104.17	738.60
Manistique River	11502.03	95.80	1232.81
Menominee River	25727.66	621.73	2477.21
Fox River	33972.50	7059.93	4743.01
Total	154746.30	17780.53	19020.87

Table 4.4.9. Annual Average Organic Carbon Loads From 18 Unmonitored Tributaries to Lake Michigan During the LMMBP

Tributary (Unmonitored)	DOC (ton/year)	BIC (ton/year)	PDC (ton/year)
Manitowac	4507.49	689.71	492.89
Root	1188.18	134.58	107.01
Galien	2530.82	373.84	389.47
Black	3132.23	486.67	560.94
Kalamazoo-Minor	268.82	41.77	48.14
Kewaunee	4106.73	853.43	573.35
Pere Marquette-Minor	6841.12	204.79	457.25
Manistee	11095.82	289.68	2053.92
Betsie	3909.74	117.04	261.32
Millecoquins	4406.39	36.70	472.28
Jordan	8012.93	239.87	535.57
Sturgeon	4385.19	36.52	470.01
Whitefish	3997.10	96.59	384.86
Escanaba	5815.29	140.53	559.93
Cedar	6544.03	158.14	630.10
Peshtigo	7236.21	174.87	696.74
Oconto	5568.69	1157.25	777.46
Pensaukee	2702.66	561.65	377.33
Total	86249.43	5793.65	3896.44

Table 4.4.10. Annual Average Organic Carbon Internal Loads Generated From the LM3-Eutro for Lake Michigan During the LMMBP

Segment	DOC (ton/year)	BIC (ton/year)
1	700929.10	2803716.40
2	689189.92	2756759.68
3	518083.37	2072333.48
4	403259.87	1613039.48
5	189956.41	759825.64
6	170745.86	682983.44
7	68920.37	275681.48
8	69189.01	276756.05
9	124169.03	496676.11
10	78248.13	312992.51
11	250457.73	1001830.93
12	246500.23	986000.92
13	188306.18	753224.70
14	145633.10	582532.39
15	53584.35	214337.41
16	56110.59	224442.38
17	15072.21	60288.86
18	14053.69	56214.78
19	13520.81	54083.22
20	50927.44	203709.77
21	49818.55	199274.20
22	39893.25	159573.00
23	31062.96	124251.84
24	6879.84	27519.37
25	10523.70	42094.79
26	1388.52	5554.07
27	816.87	3267.48
28	213.29	853.14
29	9827.70	39310.79
30	9681.05	38724.21
31	8149.94	32599.76
32	6621.80	26487.18
33	1017.37	4069.47
34	1648.21	6592.86
35	19.20	76.80
36	293.42	1173.68
37	314.62	1258.48
38	276.19	1104.74
39	244.65	978.61
40	18.65	74.59
41	33.69	134.75
Total	422560.09	1690240.34

Table 4.4.11. Initial Concentrations of Organic Carbon Sorbents in Water Column Segments for the LM2-Toxic

Segment	DOC (mg/L)	BIC (mg/L)	PDC (mg/L)
1	1.5694	0.038332	0.1484
2	1.7768	0.038024	0.1383
3	1.5311	0.030031	0.1818
4	1.6138	0.029434	0.168
5	1.6464	0.033097	0.1763
6	1.6113	0.030774	0.1768
7	1.7583	0.034256	0.2616
8	1.968	0.036219	0.2616
9	3.6044	0.035715	0.2616
10	3.6154	0.07318	0.2616
11	1.5338	0.036831	0.1544
12	1.6015	0.036452	0.1441
13	1.532	0.029746	0.1802
14	1.6247	0.029355	0.1651
15	1.5429	0.032192	0.1761
16	1.4676	0.030419	0.1753
17	1.7187	0.033151	0.2616
18	2.0062	0.03439	0.2616
19	3.4877	0.034217	0.2616
20	1.5442	0.035098	0.1294
21	1.5581	0.034508	0.1218
22	1.6276	0.029078	0.1598
23	1.6385	0.028811	0.151
24	1.5571	0.030666	0.2015
25	1.763	0.029705	0.1699
26	1.8679	0.031902	0.1865
27	1.8811	0.03355	0.1959
28	1.8553	0.034123	0.1777
29	1.5242	0.031241	0.1246
30	1.5286	0.03062	0.1222
31	1.7129	0.026917	0.1411
32	1.6961	0.026645	0.146
33	1.8431	0.027635	0.1538
34	1.87	0.027417	0.1575
35	1.8	0.031769	0.1388
36	1.415	0.024359	0.0833
37	1.3966	0.024124	0.0811
38	1.6693	0.019674	0.1144
39	1.6572	0.020367	0.1169
40	1.7343	0.023314	0.1183
41	1.7286	0.024052	0.1182

Table 4.4.12. Cruise-Segment Mean Concentrations of DOC (mg/L) for the LMMBP Period

Segment	Cruise 1	Cruise 2	Cruise 3	Cruise 4	Cruise 5	Cruise 6	Cruise 7	Cruise 8
1	1.569	1.574	1.623	1.611	1.503	1.559	1.594	1.709
2	1.777	1.593	1.577	1.635	1.482	1.637	1.611	1.681
3	1.531	1.565	1.707	1.596	1.496	1.515	1.676	1.691
4	1.614	1.594	1.637	1.609	1.499	1.511	1.639	1.724
5	1.646	1.569	1.608	1.349	1.497	1.484	1.646	1.701
6	1.611	1.573	1.629	1.401	1.497	1.483	1.624	1.821
7	1.758		2.285	1.930		1.672	2.108	1.789
8	1.968		2.378	1.948		1.797	2.248	1.852
9	3.604		2.885	2.432		2.770	1.965	2.149
10	3.615		2.858	2.427		2.776	1.939	2.135
11	1.534	1.519	1.720	1.622		1.561	1.604	1.668
12	1.602	1.575	1.615	1.635		1.592	1.620	1.690
13	1.532	1.558	1.742	1.593		1.569	1.683	1.633
14	1.625	1.587	1.716	1.613		1.535	1.647	1.683
15	1.543	1.559	1.632	1.363		1.505	1.663	1.606
16	1.468	1.563	1.688	1.412		1.504	1.630	1.738
17	1.719		2.408	1.883		1.649	2.111	1.691
18	2.006		2.468	1.924		1.820	2.244	1.780
19	3.488		2.755	2.331		2.700	1.976	2.037
20	1.544	1.440	1.461	1.650		1.535	1.385	1.540
21	1.558	1.417	1.470	1.619		1.487	1.391	1.578
22	1.628	1.379	1.618	1.517		1.605	1.348	1.483
23	1.639	1.388	1.587	1.518		1.530	1.326	1.551
24	1.557	1.388	1.514	1.338		1.524	1.284	1.436
25	1.763	1.391	1.461	1.349		1.543	1.253	1.466
26	1.868		1.698	1.496		1.730	1.430	1.419
27	1.881		1.662	1.457		1.730	1.430	1.444
28	1.855		1.733	1.534		1.730	1.430	1.395
29	1.524	1.438	1.459	1.555		1.531	1.354	1.471
30	1.529	1.404	1.473	1.547		1.550	1.375	1.481
31	1.713	1.620	1.633	1.592		1.453	1.377	1.392
32	1.696	1.572	1.606	1.585		1.474	1.345	1.416
33	1.843	1.582	1.566	1.557		1.382	1.318	1.488
34	1.870	1.567	1.591	1.568		1.371	1.318	1.687
35	1.800		1.661	1.448			1.397	1.445
36	1.415	1.433	1.540	1.584		1.476	1.433	1.443
37	1.397	1.422	1.475	1.539		1.480	1.400	1.439
38	1.669	1.446	1.451	1.565		1.457	1.433	1.464
39	1.657	1.433	1.419	1.554		1.440	1.409	1.489
40	1.734	1.305	1.406	1.388		1.383	1.311	1.542
41	1.729	1.312	1.387	1.317		1.371	1.320	1.713

Table 4.4.13. Cruise-Segment Mean Concentrations of BIC (mg/L) for the LMMBP Period

Segment	Cruise 1	Cruise 2	Cruise 3	Cruise 4	Cruise 5	Cruise 6	Cruise 7	Cruise 8
1	0.092	0.087	0.041	0.065	0.046	0.058	0.026	0.050
2	0.093	0.094	0.044	0.064	0.048	0.063	0.024	0.047
3	0.090	0.106	0.046	0.052	0.046	0.056	0.038	0.041
4	0.090	0.107	0.050	0.053	0.046	0.047	0.037	0.044
5	0.098	0.104	0.045	0.055	0.047	0.069	0.040	0.043
6	0.095	0.104	0.048	0.053	0.047	0.062	0.038	0.044
7	0.100		0.071	0.097		0.088	0.080	0.087
8	0.100		0.077	0.103		0.092	0.090	0.094
9	0.100		0.184	0.141		0.122	0.069	0.217
10	0.100		0.179	0.141		0.122	0.068	0.214
11	0.093	0.181	0.037	0.067		0.054	0.026	0.049
12	0.093	0.151	0.044	0.066		0.055	0.023	0.048
13	0.088	0.129	0.053	0.048		0.065	0.040	0.043
14	0.083	0.137	0.059	0.052		0.051	0.038	0.044
15	0.097	0.133	0.050	0.054		0.070	0.042	0.044
16	0.089	0.135	0.055	0.052		0.064	0.039	0.045
17	0.100		0.076	0.084		0.081	0.080	0.073
18	0.100		0.082	0.095		0.082	0.089	0.085
19	0.100		0.158	0.128		0.115	0.070	0.187
20	0.093	0.104	0.077	0.070		0.053	0.052	0.021
21	0.095	0.090	0.088	0.065		0.053	0.046	0.019
22	0.091	0.096	0.111	0.041		0.059	0.044	0.029
23	0.084	0.096	0.130	0.047		0.045	0.046	0.031
24	0.127	0.094	0.088	0.051		0.076	0.052	0.026
25	0.105	0.094	0.092	0.049		0.064	0.057	0.027
26	0.101		0.082	0.045		0.075	0.037	0.028
27	0.101		0.078	0.047		0.075	0.037	0.031
28	0.102		0.086	0.043		0.075	0.037	0.026
29	0.095	0.078	0.079	0.015		0.051	0.047	0.010
30	0.093	0.069	0.092	0.014		0.049	0.044	0.009
31	0.091	0.079	0.108	0.017		0.063	0.048	0.018
32	0.083	0.079	0.128	0.018		0.059	0.047	0.017
33	0.098	0.077	0.090	0.026		0.058	0.047	0.015
34	0.099	0.077	0.096	0.023		0.057	0.047	0.010
35	0.102		0.078	0.043			0.040	0.031
36	0.064	0.049	0.023	0.009		0.041	0.021	0.007
37	0.067	0.043	0.020	0.009		0.039	0.018	0.006
38	0.046	0.063	0.027	0.005		0.030	0.025	0.012
39	0.042	0.058	0.023	0.006		0.031	0.023	0.010
40	0.049	0.066	0.029	0.004		0.045	0.027	0.013
41	0.049	0.065	0.034	0.004		0.051	0.024	0.009

Table 4.4.14. Cruise-Segment Mean Concentrations of PDC (mg/L) for the LMMPB Period

Segment	Cruise 1	Cruise 2	Cruise 3	Cruise 4	Cruise 5	Cruise 6	Cruise 7	Cruise 8
1	0.148	0.202	0.221	0.222	0.113	0.139	0.135	0.144
2	0.138	0.203	0.231	0.207	0.113	0.152	0.130	0.139
3	0.182	0.224	0.206	0.210	0.118	0.178	0.187	0.162
4	0.168	0.221	0.204	0.202	0.119	0.142	0.178	0.151
5	0.176	0.220	0.159	0.239	0.119	0.202	0.195	0.150
6	0.177	0.219	0.175	0.227	0.120	0.188	0.186	0.147
7	0.262		0.283	0.357		0.237	0.372	0.272
8	0.262		0.306	0.356		0.248	0.438	0.295
9	0.262		0.525	0.397		0.332	0.306	0.480
10	0.262		0.514	0.397		0.333	0.293	0.474
11	0.154	0.165	0.210	0.222		0.127	0.133	0.138
12	0.144	0.187	0.222	0.209		0.135	0.129	0.130
13	0.180	0.215	0.204	0.197		0.177	0.174	0.166
14	0.165	0.210	0.206	0.198		0.144	0.170	0.152
15	0.176	0.210	0.141	0.242		0.203	0.200	0.144
16	0.175	0.208	0.162	0.225		0.189	0.186	0.143
17	0.262		0.295	0.321		0.255	0.374	0.239
18	0.262		0.317	0.333		0.266	0.436	0.272
19	0.262		0.439	0.374		0.320	0.311	0.427
20	0.129	0.114	0.145	0.185		0.118	0.158	0.114
21	0.122	0.126	0.102	0.185		0.120	0.140	0.111
22	0.160	0.147	0.144	0.152		0.163	0.177	0.144
23	0.151	0.137	0.128	0.168		0.128	0.162	0.141
24	0.202	0.144	0.146	0.223		0.196	0.170	0.149
25	0.170	0.141	0.145	0.220		0.176	0.168	0.144
26	0.187		0.167	0.146		0.270	0.183	0.180
27	0.196		0.185	0.142		0.270	0.183	0.196
28	0.178		0.149	0.149		0.270	0.183	0.165
29	0.125	0.091	0.149	0.177		0.122	0.113	0.080
30	0.122	0.108	0.120	0.196		0.124	0.127	0.077
31	0.141	0.086	0.141	0.126		0.159	0.135	0.094
32	0.146	0.087	0.130	0.134		0.155	0.134	0.083
33	0.154	0.089	0.148	0.142		0.193	0.148	0.096
34	0.158	0.090	0.148	0.142		0.198	0.145	0.069
35	0.139		0.186	0.140			0.173	0.196
36	0.083	0.078	0.122	0.103		0.096	0.106	0.074
37	0.081	0.077	0.105	0.097		0.095	0.108	0.074
38	0.114	0.080	0.079	0.072		0.088	0.091	0.062
39	0.117	0.079	0.083	0.076		0.093	0.089	0.059
40	0.118	0.079	0.059	0.064		0.149	0.094	0.079
41	0.118	0.079	0.057	0.065		0.176	0.091	0.061

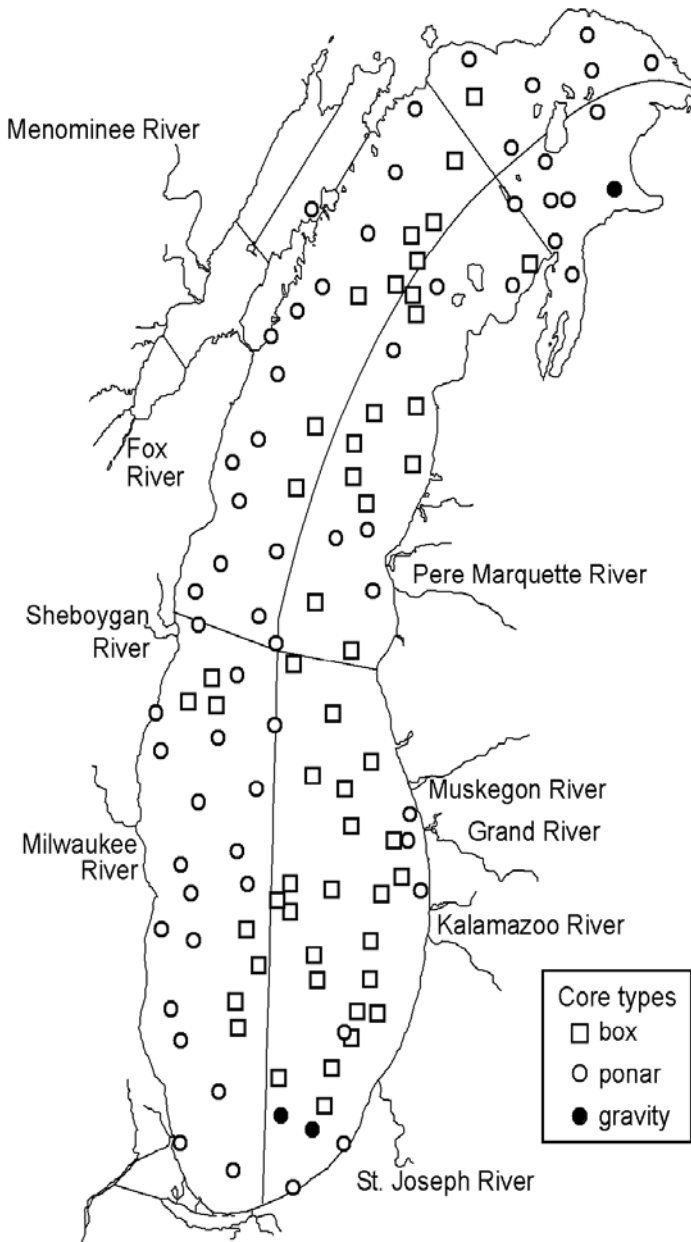

Figure 4.4.5. Lake Michigan sediment sampling sites for organic carbon during the LMMBP.

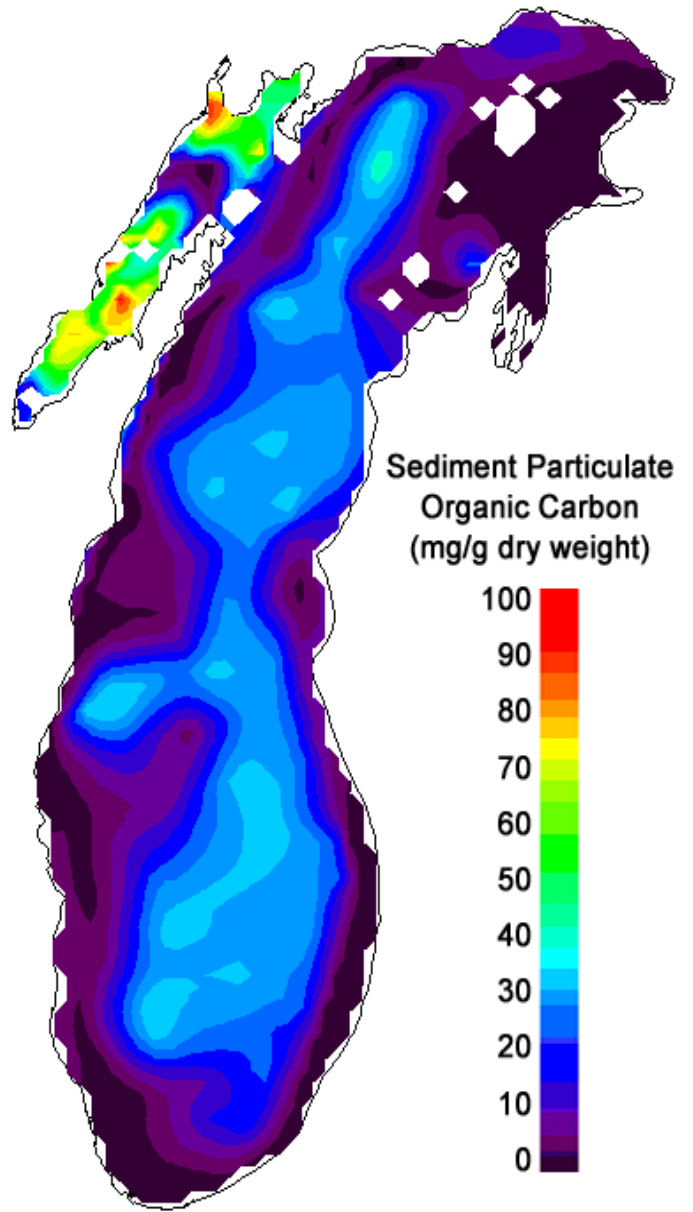

Figure 4.4.6. Distribution of POC in Lake Michigan surficial sediments (mg/g_{dw}).

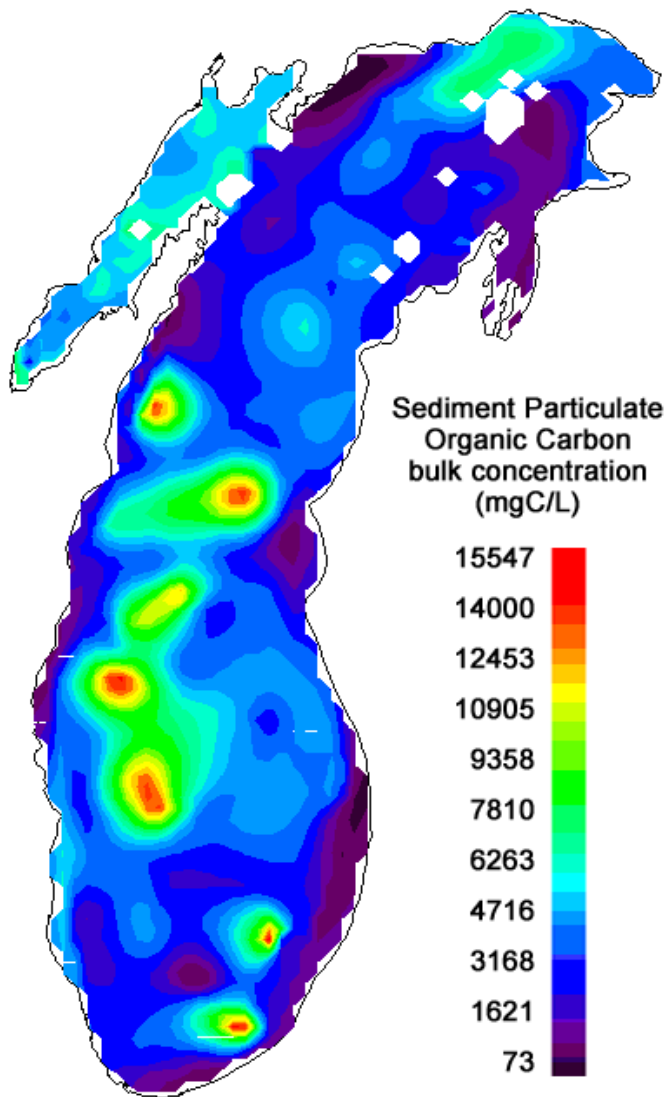

Figure 4.4.7. Distribution of POC in Lake Michigan surficial sediments (mg/L).

averaged sediment organic carbon concentrations are presented in Table 4.4.15.

4.4.2.3 Parameterization

There were a number of organic carbon sorbent-specific parameters that had to be specified as input for the LM2-Toxic. These parameters included carbon biotransformation parameters (carbon decay and yield), carbon sorbent vertical transport parameters (settling velocities, resuspension rates,

burial rates), and parameters derived during empirical wave-induced resuspension (critical wave height and empirical wave coefficient). Most of these parameters were not project-generated parameters. Initial values of these parameters were specified based on values from the literature or were derived from empirical relationships. Their values could have a large variation, and results from the LM2-Toxic are very sensitive to some of these parameters. Therefore, final values of these parameters were defined by calibration. Tables 4.4.16 through 4.4.19 present final lists of carbon sorbent-specific parameters, definitions, units, their final values, and data sources used in the LM2-Toxic.

The carbon biotransformation parameters are listed in Table 4.4.16. Initial values of the parameters in this table were from the GBMBP (Bierman *et al.*, 1992; DePinto *et al.*, 1993). Table 4.4.17 presents segment-specific settling velocities for both BIC and PDC, respectively. All of the settling velocities were calibration parameters. More detailed discussion of the LM2-Toxic model calibration can be found in Chapter 5. The water column segment-specific effective PDC concentrations (C_w) used in the steady-state resuspension calculation (Equation 4.3.8) were computed by averaging the eight cruise segment-mean concentrations derived from samples collected during the LMMBP. The PDC concentrations (C_w) are presented in Table 4.4.18. An accurate estimation of the burial rate was essential in computing the steady-state resuspension rate and calibrating organic carbon sorbent dynamics. A reliable burial rate could reduce one degree of freedom in Equation 4.3.8, making the carbon settling velocity the only calibration parameter in the equation. Table 4.4.19 provides the segment-specific burial rates along with the thickness of mixing layer for the surficial sediment segments based on the analyzed results of the LMMBP-generated sediment core samples (Robbins *et al.*, 1999). Table 4.4.20 lists the segment-specific critical wave heights and empirical wave coefficients for calculating wave-induced resuspension based on the LMMBP-generated data using linear-regression (see Section 3.4.2 for discussion and details). The final segment-specific resuspension rates were computed as daily time functions and input into the LM2-Toxic.

Table 4.4.15. Concentration of Organic Carbon Sorbents in Surficial Segments for the LM2-Toxic

Segment	DOC (mg/L)	PDC (mg/L)	Segment	DOC (mg/L)	PDC (mg/L)
42	1.6	2981.3	69	1.7	3634.1
43	1.6	3342.3	70	1.7	4120.2
44	1.6	4190.0	71	1.7	4340.0
45	1.6	3782.3	72	1.7	2712.5
46	1.6	6384.2	73	1.7	2642.3
47	1.6	6056.2	74	1.7	2626.8
48	1.6	7040.6	75	1.7	2172.5
49	1.6	4561.8	76	1.7	2433.5
50	1.6	4688.9	77	1.7	4322.5
51	1.6	5354.8	78	2	6147.7
52	1.6	4058.7	79	2	5817.2
53	1.6	1942.4	80	2	5705.1
54	1.6	3009.7	81	2	6422.5
55	1.6	1709.3	82	2	5699.2
56	1.7	1778.6	83	1.9	5831.2
57	1.7	2906.6	84	1.9	5987.4
58	1.7	4447.1	85	1.9	6665.9
59	1.7	5557.6	86	1.9	6354.6
60	1.7	4768.6	87	2	5672.5
61	1.7	4968.2	88	3.4	5040.1
62	1.7	4770.0	89	3.4	5877.2
63	1.7	3519.9	90	3.4	6611.8
64	1.7	3024.3	91	3.4	5917.6
65	1.7	6175.6	92	3.6	6399.6
66	1.7	5771.8	93	3.6	5460.0
67	1.7	4533.5	94	3.6	5293.0
68	1.7	3970.2			

Table 4.4.16. Organic Carbon Sorbent Biotransformation Parameters Specified for the LM2-Toxic

Parameter	Definition and Units	Value	Source
$\hat{k}_{d(DOC)}$	Substrate saturated decay rate of DOC in water column at temperatures equal to 20°C, d ⁻¹	0.005	DePinto <i>et al.</i> , 1993; Calibration
$k_{1/2(DOC)}$	Michaelis-Menten half-saturation constant for DOC decay in water column, mg/L	3.4	DePinto <i>et al.</i> , 1993; Calibration
$k_{ds(DOC)}$	Decay rate for DOC in surficial sediments at temperature equal to 20°C, d ⁻¹	0.015	DePinto <i>et al.</i> , 1993; Calibration
$\hat{k}_{d(BIC)}$	Substrate saturated decay rate of BIC in water column at temperature equal to 20°C, d ⁻¹	0.56	DePinto <i>et al.</i> , 1993; Calibration
$k_{1/2(BIC)}$	Michaelis-Menten half-saturation constant for BIC decay in water column, mg/L	0.4	DePinto <i>et al.</i> , 1993; Calibration
$Y_{(BIC \ PDC)}$	Yield coefficient (percentage) of PDC during BIC decay in water column, dimensionless	90%	DePinto <i>et al.</i> , 1993; Calibration
$\hat{k}_{d(PDC)}$	Substrate saturated decay rate of PDC in water column at temperature equal to 20°C, d ⁻¹	0.04	DePinto <i>et al.</i> , 1993; Calibration
$k_{1/2(PDC)}$	Michaelis-Menten half-saturation constant for PDC decay in water column, mg/L	0.55	DePinto <i>et al.</i> , 1993; Calibration
$Y_{(PDC \ DOC)}$	Yield coefficient (percentage) of DOC during PDC decay in water column, dimensionless	60%	DePinto <i>et al.</i> , 1993; Calibration
$k_{ds(PDC)}$	Decay rate for PDC in surficial sediments at temperature equal to 20°C, d ⁻¹	0.0001	DePinto <i>et al.</i> , 1993; Calibration
$Y_{S(PDC \ DOC)}$	Yield coefficient (percentage) of PDC decay in surficial sediments, dimensionless	60%	DePinto <i>et al.</i> , 1993; Calibration

Table 4.4.17. Segment-Specific Settling Rates (m/d) for Organic Carbon Sorbents (BIC and PDC) Specified for LM2-Toxic

Segment	BIC Settling Velocity	PDC Settling Velocity	Source
1	0.15	0.15	Calibration
2	0.15	0.15	Calibration
3	0.15	0.15	Calibration
4	0.15	0.15	Calibration
5	0.15	0.15	Calibration
6	0.15	0.15	Calibration
7	0.2	0.2	Calibration
8	0.2	0.2	Calibration
9	0.2	0.2	Calibration
10	0.2	0.2	Calibration
11	0.15	0.15	Calibration
12	0.15	0.15	Calibration
13	0.15	0.15	Calibration
14	0.15	0.15	Calibration
15	0.15	0.15	Calibration
16	0.15	0.15	Calibration
17	0.2	0.2	Calibration
18	0.2	0.2	Calibration
19	0.2	0.2	Calibration
20	0.06	0.25	Calibration
21	0.06	0.25	Calibration
22	0.06	0.25	Calibration
23	0.06	0.25	Calibration
24	0.06	0.25	Calibration
25	0.06	0.25	Calibration
26	0.2	0.8	Calibration
27	0.2	0.8	Calibration
28	0.2	0.8	Calibration
29	0.06	0.4	Calibration
30	0.06	0.4	Calibration
31	0.06	0.4	Calibration
32	0.06	0.4	Calibration
33	0.06	0.4	Calibration
34	0.06	0.4	Calibration
35	0.08	0.75	Calibration
36	0.06	0.75	Calibration
37	0.06	0.75	Calibration
38	0.06	0.75	Calibration
39	0.06	0.75	Calibration
40	0.06	0.75	Calibration
41	0.06	0.75	Calibration

Table 4.4.18. Segment-Specific Effective PDC Concentrations (C_w) Used in the Steady-State Resuspension Calculation Based on the LMMBP Data

Segment	C_w (mg/L)	Segment	C_w (mg/L)
1	223.63	20	153.59
2	223.74	21	145.00
3	242.84	22	171.26
4	232.14	23	161.49
5	245.25	24	193.38
6	240.86	25	182.99
7	384.32	26	204.06
8	410.02	27	210.65
9	522.45	28	197.85
10	515.67	29	130.39
11	236.60	30	132.76
12	233.70	31	135.10
13	253.99	32	133.21
14	243.83	33	147.27
15	257.86	34	144.40
16	252.19	35	190.47
17	373.12	36	97.10
18	402.88	37	93.47
19	386.85	38	86.09
		39	87.14
		40	94.54
		41	95.34

Table 4.4.19. Segment-Specific Sediment Accumulation Rates (v_b) and Thickness of Mixing Layer (z) Used in the Steady-State Resuspension Calculation (Original Data Source: Robbins *et al.*, 1999)

Segment	v_b (m/d)	z (m)	Segment	v_b (m/d)	z (m)
42	0	0.001	69	1.49E-06	0.001
43	0	0.001	70	3.19E-06	0.024
44	6.12E-09	0.001	71	5.31E-06	0.03
45	1.59E-07	0.001	72	0	0.001
46	4.97E-07	0.013	73	4.18E-07	0.011
47	1.36E-06	0.018	74	9.05E-08	0.01
48	3.11E-06	0.025	75	1.47E-07	0.001
49	9.94E-06	0.031	76	3.36E-07	0.001
50	7.29E-06	0.029	77	4.94E-07	0.001
51	3.96E-06	0.019	78	1.36E-06	0.04
52	6.37E-06	0.012	79	1.36E-06	0.04
53	1.36E-06	0.001	80	1.36E-06	0.04
54	1.28E-06	0.001	81	1.36E-06	0.04
55	1.87E-07	0.001	82	1.36E-06	0.04
56	0	0.001	83	1.36E-06	0.04
57	9.87E-08	0.001	84	1.36E-06	0.04
58	7.56E-07	0.013	85	1.36E-06	0.04
59	2.90E-06	0.019	86	1.36E-06	0.04
60	6.06E-06	0.028	87	1.36E-06	0.04
61	7.47E-06	0.026	88	2.72E-06	0.04
62	7.58E-06	0.031	89	2.72E-06	0.04
63	5.06E-06	0.016	90	2.72E-06	0.04
64	3.76E-06	0.001	91	2.72E-06	0.04
65	3.65E-08	0.001	92	2.60E-06	0.04
66	8.78E-08	0.001	93	2.60E-06	0.04
67	9.83E-09	0.001	94	2.60E-06	0.04
68	4.83E-07	0.001			

Table 4.4.20. Segment-Specific Critical Wave Heights (W_{cr}) and Empirical Wave Coefficients (α) Used in the Wave-Induced Resuspension Calculation Based on the LMMBP Data

Segment	W_{cr} (m)	α	Segment	W_{cr} (m)	α
42	0.93	52	69	3.49	0
43	1.20	70	70	3.33	0
44	1.63	131	71	3.90	0
45	2.24	565	72	3.57	0
46	3.75	0	73	3.76	0
47	4.01	0	74	3.35	0
48	5.52	0	75	2.21	0
49	4.83	0	76	1.65	0
50	4.50	0	77	1.24	214
51	4.15	0	78	0.90	99
52	2.28	61	79	1.22	207
53	2.22	257	80	1.57	0
54	1.62	56	81	1.60	0
55	1.29	88	82	1.69	0
56	1.74	0	83	2.07	0
57	2.29	0	84	1.94	0
58	3.84	0	85	1.65	0
59	5.02	0	86	1.25	142
60	7.89	0	87	0.85	175
61	7.66	0	88	0.92	273
62	5.47	0	89	1.22	0
63	3.81	0	90	1.31	0
64	2.40	0	91	1.33	0
65	0.95	96	92	0.74	142
66	1.22	143	93	0.82	157
67	1.63	520	94	0.82	146
68	2.19	0			

4.4.3 PCBs

Thirty-six PCB state variables representing a total of 54 PCB congeners were modeled in the LM2-Toxic as either individual PCB congeners or co-eluting PCB congeners. The mass for the sum of all 54 PCB congeners (Σ PCB) accounted for approximately 70% of total PCB mass in Lake Michigan. Table 4.4.21 provides a list of these PCB congeners by IUPAC numbers. Because of the huge amount of PCB congener data generated during the LMMBP, it was impossible to provide summaries of field data for each modeled PCB congener. Thus, PCB loadings, field data, and related information in the following subsections are reported only as the sum of the 54

congeners (Σ PCBs). Organic carbon sorbent dynamics, PCB partitioning, and PCB air-water exchange dictated the variation of PCB concentrations in Lake Michigan. The lake-wide average concentrations for vapor phase Σ PCBs varied from 0.28 to 0.42 ng/m³. The average concentrations in the main lake for dissolved and particulate Σ PCBs were 0.15 and 0.07 ng/L, respectively. In Green Bay, the average concentrations of dissolved and particulate Σ PCBs were almost double or triple, and their values were 0.3 and 0.36 ng/L, respectively. The average Σ PCB concentrations in the surficial sediments ranged from 650 to 25,000 ng/L. Data requirements for PCB input to the LM2-Toxic included loads

Table 4.4.21. List of PCB State Variables Modeled in the LM2-Toxic

PCB Congeners	PCB Congeners	PCB Congeners	PCB Congeners
PCB8+5	PCB49	PCB92+84	PCB170+190
PCB15+17	PCB52	PCB89	PCB172+197
PCB16+32	PCB56+60	PCB99	PCB180
PCB18	PCB66	PCB101	PCB187+182
PCB26	PCB70+76	PCB118	PCB195+208
PCB28+31	PCB74	PCB123+149	PCB196+203
PCB33	PCB77+110	PCB105+132+153	PCB201
PCB37+42	PCB81	PCB151	PCB85
PCB44	PCB87	PCB163+138	PCB146

(tributary and atmospheric), boundary conditions (Straits of Mackinac and atmospheric gas phase concentrations), initial conditions in both the water column and surficial sediments, process related parameters, and kinetic time functions such as temperature and wind speed. The segment-mean concentration for each cruise, generated by IDW data interpolation with VWA, was an essential part of field data analysis used to calibrate the LM2-Toxic. See Part 4, Appendix 4.4.1.

4.4.3.1 Loading

Tributary and atmospheric sources were the two major external loads of PCBs to Lake Michigan. Tributary loads included loads from 11 monitored tributaries and 18 unmonitored tributaries (Hall and Robertson, 1998). Atmospheric loads were derived from monthly atmospheric dry and wet deposition fluxes (McCarty *et al.*, 2004; Miller *et al.*, 2001). Tributary loads were input as daily time functions into the LM2-Toxic. The seasonal variation of the Σ PCB tributary load represents the sum of the tributary loads including 11 monitored and 18 unmonitored tributaries (Figure 4.4.8). There were 18 months of atmospheric dry deposition measurements during the LMMBP period. The data set provided for the modeling was organized for the period from April 1994 to March 1995. For consistency with other input loading time series in the model, the loads for the first three months of 1995 were used as the loads for the same period of 1994. The loads for April-December of 1995 were assumed to be identical to the loads for the same period of 1994. Eighteen

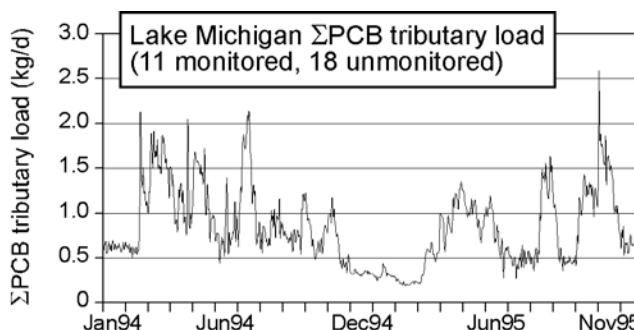

Figure 4.4.8. Σ PCB tributary (11 monitored and 18 unmonitored tributaries) loads to Lake Michigan during the LMMBP period.

months of monthly atmospheric wet deposition were available starting in April 1994 and ending in September 1995. Among the 18 months, the loads in April and May of 1994 were significantly higher (about 10 times higher) than the monthly loads of the remaining 16 months. Therefore, the approach used in the first three months of 1994 for dry loads was not applicable for wet deposition. In order to construct a complete two-year atmospheric wet load time series, monthly wet loads for January, February, and March of 1994 were assumed to be the same as that for April 1994, and the loads for the last three months in 1995 were assumed to be the same as the loads for the last three months of 1994. Figure 4.4.9 provides the information on lake-wide temporal variation of total atmospheric deposition (dry + wet) for the Σ PCBs. Based on the loads generated for the two-year LMMBP period, the annual average tributary

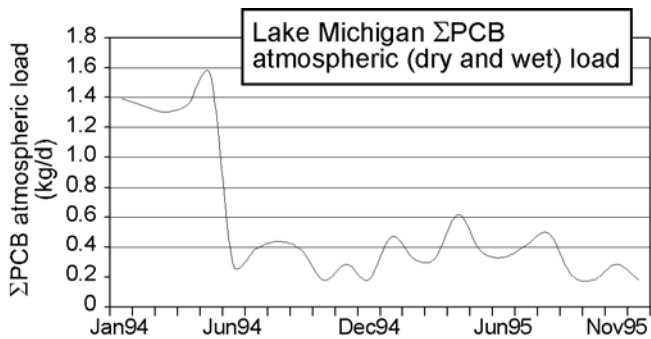

Figure 4.4.9. Estimated ΣPCB atmospheric loads including dry and wet deposition into Lake Michigan during the LMMBP period.

and atmospheric loads of the ΣPCBs are presented in Tables 4.4.22 and 4.4.23, respectively. For the two-year LMMBP period, the ΣPCB external loads to Lake Michigan from tributary and atmospheric loads were roughly equal.

4.4.3.2 Field Data, Initial Conditions, and Boundary Conditions

PCB congener level data were collected at eight shoreline sites (Figure 4.4.10), 41 water column stations (Figure 4.4.3), and about 120 sediment locations (Figure 4.4.5) during the LMMBP. The LMMB Methods Compendium provides detailed descriptions of sampling methods and analysis procedures (U.S. Environmental Protection Agency, 1997). The LM2-Toxic required inputs of PCB congener concentrations in air, water, and sediments. Daily vapor phase PCB boundary concentrations were interpolated and calculated at a spatial resolution of 5 x 5 km² grid cells (Green *et al.*, 2000; Miller *et al.*, 2001) based on air samples collected at eight shoreline sites and 14 over-water sites (Figure 4.4.10). These results were aggregated to the LM2-Toxic segmentation for input into the model. Strong seasonal variation was observed for PCB vapor phase concentrations during the study period (Figure 4.4.11). Table 4.4.24 presents the segment-specific annual average ΣPCB vapor phase concentrations above the 10 surface segments of the LM2-Toxic. The same interpolation methods and averaging procedures used for organic carbon species were applied to individual PCB congeners in both the water column and sediments. One hundred and sixteen sediment samples (Figure 4.4.12) were

used to generate segment-specific sediment concentrations of individual PCB congeners. Equation 4.4.4 was used to convert sediment PCB measurements from the unit of ng/g_{dw} to the standard unit (ng/L, i.e., bulk concentration) used in the LM2-Toxic.

$$C_s^a = C_s^b * \rho * (1 - \phi) * 10^3 \quad (4.4.4)$$

where

C_s^a = PCB concentrations in surficial sediments (ng/L), the unit required for LM2-Toxic

C_s^b = PCB concentrations in surficial sediments (ng/g_{dw}), the unit of field measurements

ρ = bulk density of surficial sediments (g_{dw}/cm³) constant (2.45 g_{dw}/cm³). To convert cm³ to L (liter), a factor of 10³ is needed in the equation.

ϕ = porosity (dimensionless)

PCB concentrations for the sediment segments in Green Bay were estimated based on only four sediment samples (SD89, 95G1, SD106P, and 113G1) collected during the two-year LMMBP period. Figures 4.4.13 and 4.4.14 show the distribution of ΣPCBs in Lake Michigan sediments in units of ng/g_{dw} and ng/L, respectively. Table 4.4.25 presents the water column initial concentrations expressed as the sum (ΣPCBs) of the individual PCB congener initial concentrations used in the LM2-Toxic. The cruise-segment mean concentrations for ΣPCBs are listed in Table 4.4.26. The segment-specific sediment concentrations for ΣPCBs are provided in Table 4.4.27. The boundary conditions for individual PCB congeners used the measurements taken at a sampling location in Lake Huron, LM54M.

4.4.3.3 Parameterization

The PCB congener-specific parameters that must be specified for input to the LM2-Toxic include partition coefficients, molecular weights, enthalpy, and entropy. The POC partition coefficients, $K'_{POC,a}$, were computed initially using the two-phase partitioning model (Equation 4.3.14) for each selected PCBs computed initially using the two-phase

Table 4.4.22. Annual Average Σ PCB Loads From 11 Monitored and 18 Unmonitored Tributaries to Lake Michigan During the LMMBP

Tributary (Monitored)	ΣPCB Loads (kg/year)	Tributary (Unmonitored)	ΣPCB Loads kg/year)
Milwaukee River	9.00	Manitowac	1.20
Sheboygan River	9.40	Root	4.26
Calumet River	29.86	Galien	1.22
St. Joseph River	8.79	Black	9.30
Kalamazoo River	30.31	Kalamazoo-Minor	0.80
Grand River	8.60	Kewaunee	0.75
Muskegon River	1.71	Pere Marquette-Minor	0.89
Pere Marquette River	0.51	Manistee	1.41
Manistique River	1.17	Betsie	0.51
Menominee River	4.01	Millecoquins	0.45
Fox River	174.62	Jordan	1.04
		Sturgeon	0.45
Total	277.98	Whitefish	0.62
		Escanaba	0.91
		Cedar	1.02
		Peshtigo	1.13
		Oconto	1.02
		Pensaukee	0.50
		Total	21.84

Table 4.4.23. Annual Average Σ PCB Atmospheric Dry and Wet Loads in the 10 Surface Water Column Segments of Lake Michigan During the LMMBP

Segment	ΣPCB Atmospheric Dry Loads (kg/year)	ΣPCB Atmospheric Wet Loads (kg/year)
1	18.13	35.67
2	13.90	34.69
3	12.27	22.29
4	9.20	16.89
5	4.38	9.04
6	4.12	8.46
7	1.36	2.54
8	1.26	2.34
9	1.47	2.79
10	0.37	0.65
Total Loads	66.46	135.35

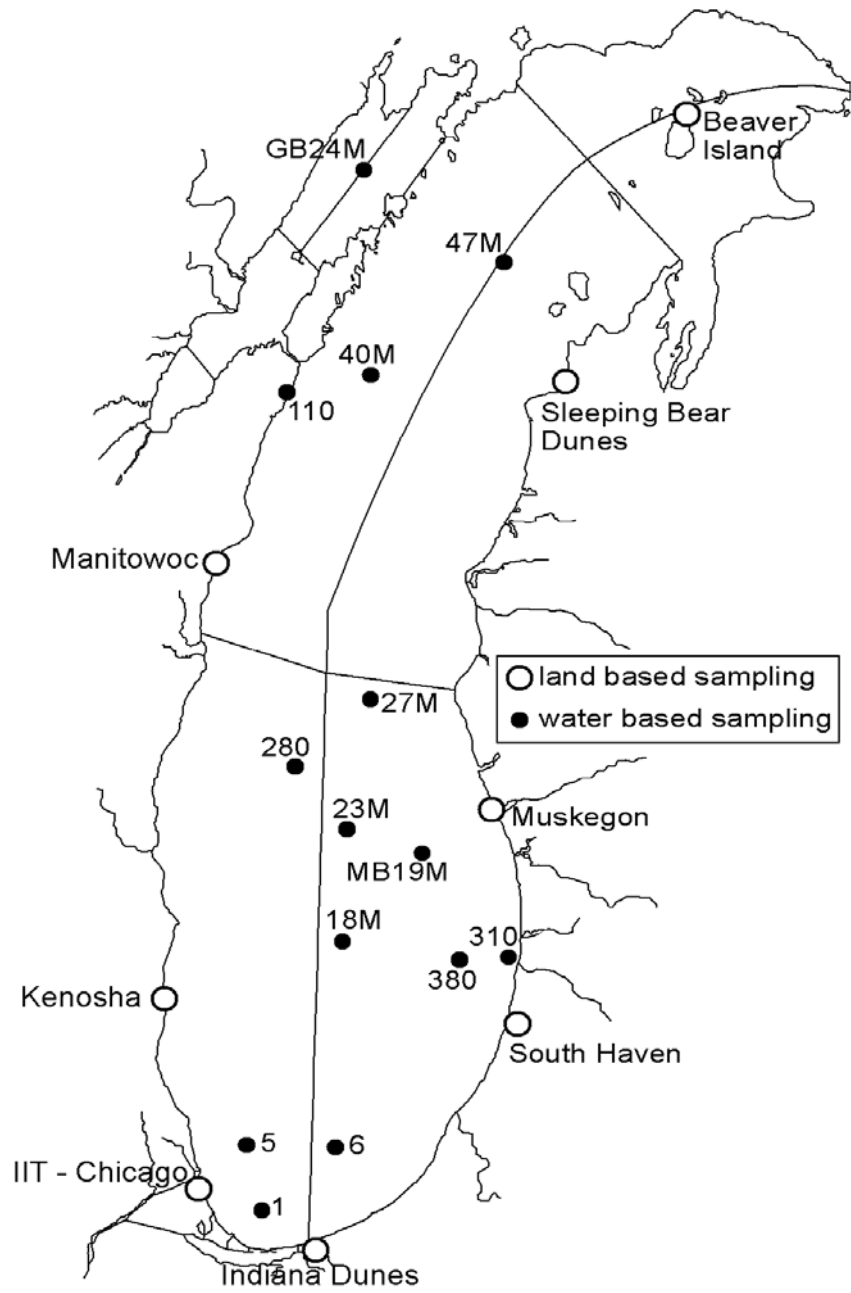

Figure 4.4.10. Lake Michigan atmospheric sampling sites during the LMMBP.

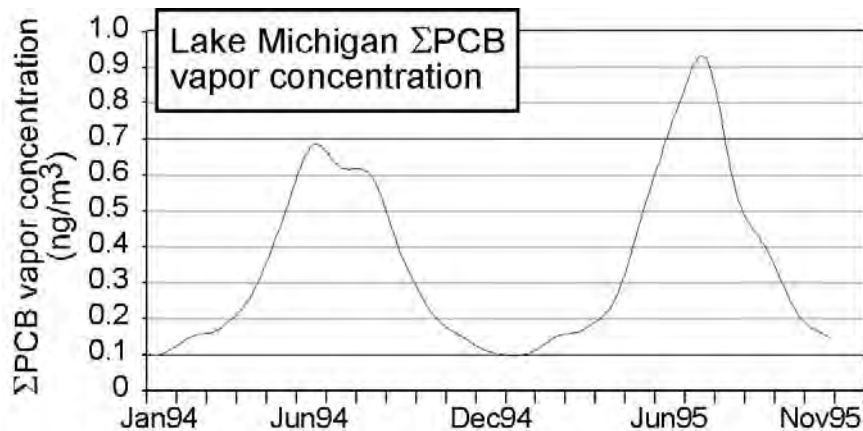

Figure 4.4.11. Seasonal variation of Σ PCB vapor phase concentrations observed during the LMMBP.

Table 4.4.24. Annual Average Boundary Conditions of Σ PCB Vapor Phase Concentrations for Lake Michigan During the LMMBP

Segment	Σ PCBs (ng/m ³)
1	0.418367
2	0.374108
3	0.297252
4	0.284844
5	0.299123
6	0.282733
7	0.30676
8	0.307972
9	0.312705
10	0.300599

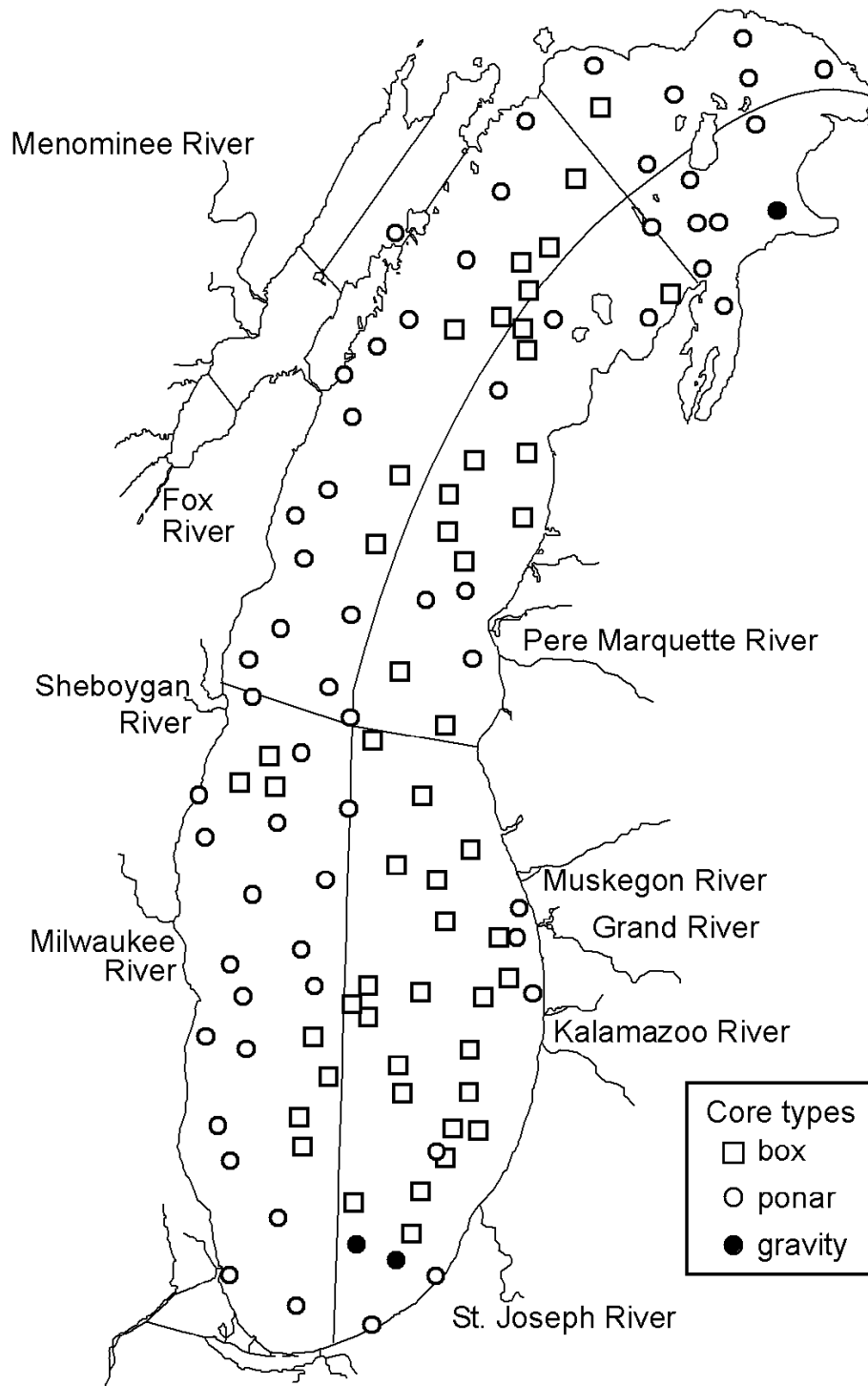

Figure 4.4.12. Lake Michigan sediment sampling sites for PCBs during the LMMBP.

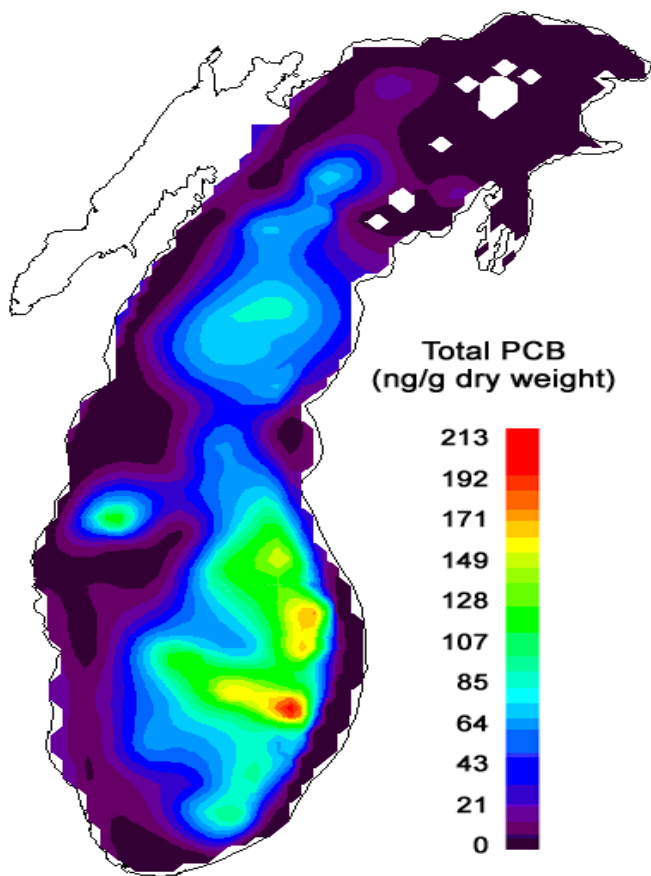

Figure 4.4.13. Distribution of Σ PCBs in Lake Michigan surficial sediments (ng/g_{dw}).

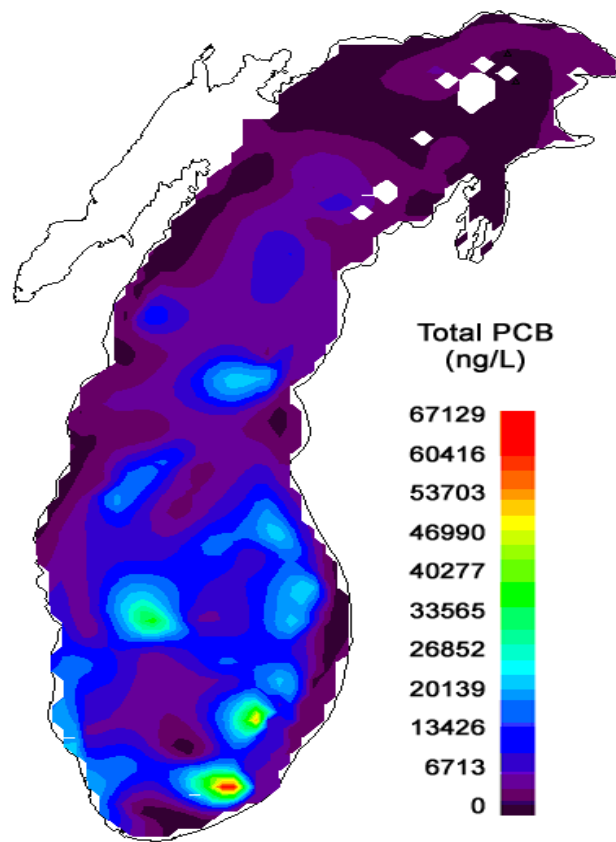

Figure 4.4.14. Distribution of Σ PCBs in Lake Michigan surficial sediments (ng/L).

Table 4.4.25. Initial Concentrations of Σ PCBs in Water Column Segments for Lake Michigan

Segment	Σ PCBs (ng/L)	Segment	Σ PCBs (ng/L)
1	0.1903	20	0.1401
2	0.2414	21	0.1872
3	0.2264	22	0.2053
4	0.2680	23	0.1438
5	0.1597	24	0.1621
6	0.2350	25	0.1604
7	0.5910	26	0.1388
8	0.6349	27	0.1639
9	2.4938	28	0.1643
10	2.5051	29	0.1492
11	0.1141	30	0.2039
12	0.1888	31	0.1663
13	0.2106	32	0.1148
14	0.1682	33	0.1560
15	0.1859	34	0.1531

Table 4.4.26. Cruise-Segment Mean Concentration of Σ PCBs (ng/L) for the LMMBP Period

Segment	Cruise 1	Cruise 2	Cruise 3	Cruise 4	Cruise 5	Cruise 6	Cruise 7	Cruise 8
1	0.192	0.124	0.136	0.199	0.241	0.214	0.183	0.233
2	0.372	0.172	0.136	0.241	0.230	0.249	0.211	0.154
3	0.227	0.136	0.112	0.158	0.232	0.181	0.169	0.143
4	0.269	0.138	0.103	0.157	0.232	0.206	0.171	0.109
5	0.214	0.148	0.078	0.116	0.233	0.130	0.166	0.117
6	0.236	0.150	0.083	0.123	0.233	0.155	0.166	0.114
7	0.591		0.195	0.211		0.376	0.199	0.170
8	0.807		0.186	0.221		0.452	0.199	0.185
9	2.494		0.486	0.839		1.039	0.199	0.660
10	2.505		0.475	0.833		1.043	0.199	0.648
11	0.154	0.133	0.129	0.190		0.217	0.184	0.240
12	0.194	0.180	0.145	0.240		0.236	0.211	0.138
13	0.212	0.138	0.113	0.168		0.171	0.169	0.091
14	0.227	0.140	0.107	0.160		0.199	0.171	0.088
15	0.196	0.150	0.084	0.119		0.132	0.167	0.092
16	0.199	0.152	0.085	0.125		0.155	0.166	0.094
17	0.550		0.293	0.196		0.362	0.199	0.154
18	0.847		0.321	0.221		0.465	0.199	0.179
19	2.373		1.327	0.733		0.997	0.199	0.564
20	0.184	0.146	0.179	0.136		0.219	0.296	0.350
21	0.188	0.180	0.173	0.170		0.216	0.281	0.296
22	0.212	0.145	0.142	0.168		0.194	0.235	0.179
23	0.181	0.152	0.128	0.155		0.218	0.221	0.286
24	0.170	0.154	0.122	0.111		0.185	0.239	0.197
25	0.179	0.157	0.122	0.116		0.196	0.217	0.217
26	0.550		0.293	0.196		0.362	0.199	0.154
27	0.847		0.321	0.221		0.465	0.199	0.179
28	2.373		1.327	0.733		0.997	0.199	0.564
29	0.210	0.166	0.178	0.359		0.171	0.251	0.341
30	0.204	0.206	0.174	0.410		0.177	0.259	0.243
31	0.167	0.144	0.143	0.213		0.145	0.241	0.178
32	0.162	0.150	0.130	0.224		0.151	0.228	0.194
33	0.162	0.154	0.126	0.189		0.136	0.269	0.162
34	0.161	0.157	0.127	0.197		0.135	0.260	0.161
35	0.847		0.293	0.196		0.362	0.199	0.154
36	0.170	0.137	0.200	0.226		0.156	0.189	0.289
37	0.178	0.146	0.201	0.229		0.161	0.200	0.194
38	0.111	0.112	0.116	0.201		0.126	0.146	0.140
39	0.117	0.113	0.125	0.202		0.126	0.149	0.143
40	0.117	0.108	0.103	0.147		0.128	0.151	0.151
41	0.118	0.108	0.102	0.132		0.130	0.149	0.156

Table 4.4.27. Initial Concentration of ΣPCBs in Sediment Segments for Lake Michigan

Segment	ΣPCBs (ng/L)	Segment	ΣPCBs (ng/L)
42	11238.3	69	2178.5
43	10438.8	70	2453.6
44	8680.7	71	1740.4
45	9765.4	72	1711.2
46	8451.6	73	1877.1
47	8349.3	74	1501.6
48	12396.8	75	1556.9
49	14131.3	76	1802.7
50	9141.6	77	2855.3
51	9960.8	78	12509.3
52	13205.0	79	13727.2
53	2528.2	80	7267.3
54	8925.6	81	10515.1
55	3730.8	82	9084.9
56	626.7	83	7084.6
57	1447.1	84	9136.2
58	3814.2	85	10282.1
59	4599.3	86	11444.5
60	6756.3	87	11787.7
61	8685.5	88	21459.7
62	5617.1	89	15602.5
63	4717.8	90	25096.6
64	3818.2	91	20717.4
65	2183.8	92	7957.1
66	3071.1	93	9250.4
67	2872.5	94	8975.4
68	2148.1		

partitioning model (Equation 4.3.14) for each selected PCB congener. A number of studies have shown a strong relationship between measured organic carbon partition coefficients and the octanol-water partition coefficient (K_{OW}) for PCBs in natural water systems (Karickhoff, 1981; Hassett *et al.*, 1980; Di Toro, 1985; Thomann and Mueller, 1987). For the purpose of comparison in general variation trend, the set of estimated POC partition coefficients, $K'_{POC,a}$, were plotted (Figure 4.4.15) against the K_{OW} calculated by Hawker and Connell (1988) for 209 PCB congeners. Figure 4.4.15 illustrates the strong relationship between the POC partition coefficients estimated from the two-phase partitioning model and K_{OW} computed by Hawker and Connell (1988). This result supported the conclusion of Eadie *et al.* (1990) that “ambient Great Lakes POC is similar to octanol as a substrate for binding” and indicated the

reasonable accuracy of the initially estimated $K'_{POC,a}$ coefficients from the two-phase partitioning model. There were some exceptions for less-chlorinated and high-chlorinated congeners. Assuming the DOC partition coefficients (K_{DOC}) has a similar variation trend as $K'_{POC,a}$ and that it is about two orders magnitude less than $K'_{POC,a}$ (Carter and Suffet, 1982; Landrum *et al.*, 1984, 1987; Hassett and Milicic, 1985; Chiou *et al.*, 1986, 1987; Eadie *et al.*, 1990, 1992; Bierman *et al.*, 1992), the K_{DOC} for each PCB congener were estimated by multiplying the value of $K'_{POC,a}$ by a factor of 10^{-2} . When necessary, the values of the pair of partition coefficients for a PCB congener were adjusted during the course of the LM2-Toxic PCB calibration. Table 4.4.28 presents the final values of POC and DOC partition coefficients used in the LM2-Toxic.

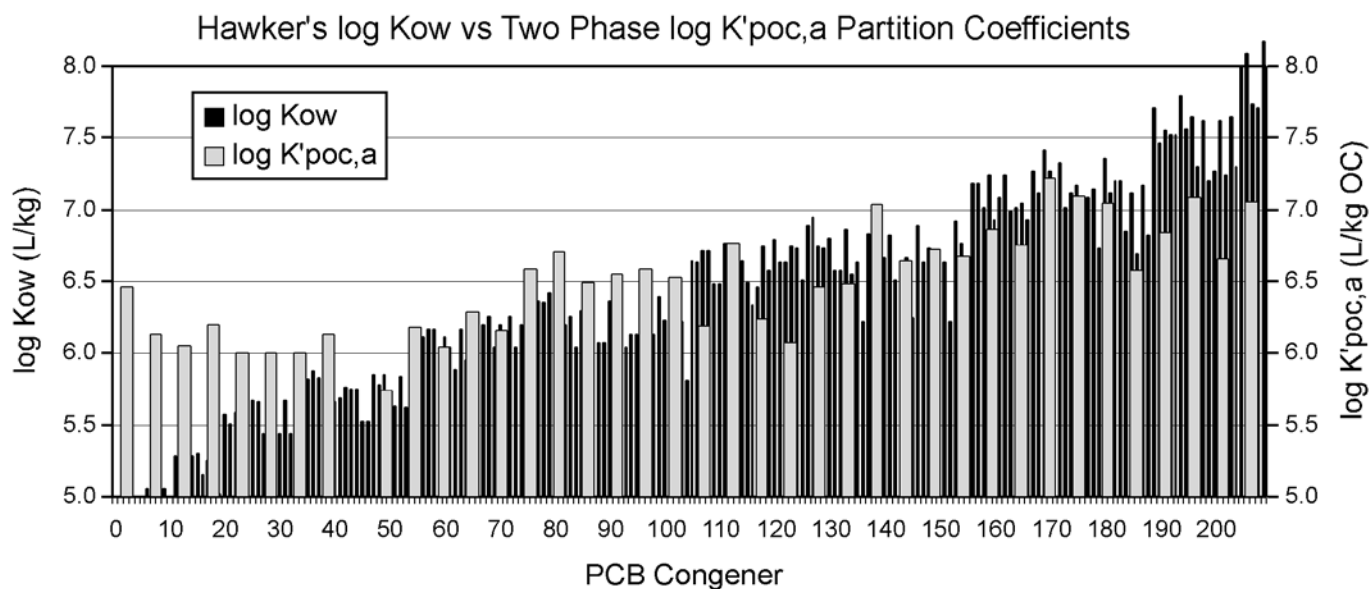

Figure 4.4.15. Comparison between the estimated $\log K'_{POC,\alpha}$ for the LMMBP selected PCB congeners based on the two-phase partitioning model and K_{OW} calculated by Hawker and Connell (1988) for all 209 PCB congeners.

Air-water exchange was another crucial process affecting PCB concentrations in Lake Michigan. Parameters related to volatilization were molecular weight, enthalpy, and entropy of each PCB congener. Table 4.4.29 provides a listing of molecular weights, enthalpy, and entropy, including their sources for each PCB congener or co-eluting PCB congeners required for the LM2-Toxic. During the LM2-Toxic PCB calibration, the values of enthalpy for some PCB state variables were adjusted within their allowed ranges (i.e., one standard error). It is worth noting that the enthalpy and entropy for co-eluting PCB congeners were estimated by simple arithmetic averaging of the values for the individual congeners. Because quantitative information for the mass of each PCB congener in a co-eluting PCB mixture was lacking, a certain amount of uncertainty was associated with their estimated enthalpy and entropy. Thus, some adjustments on these parameters were done during the LM2-Toxic PCB calibration.

4.4.3.4 Kinetic Time Functions

The kinetic time functions for the LM2-Toxic included reaeration, segment-specific wind speed time functions, segment-specific water temperature time functions, and segment-specific air temperature time functions (Schwab and Beletsky, 1998).

References

- Bamford, H.A., D.L. Poster, R.E. Huie, and J.E. Baker. 2002. Using Extrathermodynamic Relationships to Model the Temperature Dependence of Henry's Law Constants of 209 PCB Congeners. *Environ. Sci. Technol.*, 36(20):4395-4402.
- Baun, K. 1982. Alternative Methods of Estimating Pollutant Loads in Flowing Water. Wisconsin Department of Natural Resources, Madison, Wisconsin. Technical Bulletin 133, 11 pp.
- Beale, E.M.L. 1962. Some Uses of Computers in Operational Research. *Industrielle Organisation*, 31:51-52.
- Bierman, V.J., Jr., J.V. DePinto, T.C. Young, P.W. Rodgers, S.C. Martin, and R. Raghunathan. 1992. Development and Validation of an Integrated Exposure Model for Toxic Chemicals in Green Bay, Lake Michigan. Final Report. U.S. Environmental Protection Agency, Office of Research and Development, ERL-Duluth, Large Lakes Research Station, Grosse Ile, Michigan. 381 pp.

Table 4.4.28. Final Partition Coefficients for the LMMBP Selected PCBs Used in the LM2-Toxic

PCB Congeners	log K' _{POC,α} ¹ (L/kg C)	log K _{DOC} ² (L/kg C)
5+8	6.00	4.00
15+17	6.10	4.10
16+32	5.70	3.70
18	6.00	4.00
26	6.15	4.15
28+31	6.25	4.25
33	5.85	3.85
37+42	6.10	4.10
44	6.30	4.30
49	6.40	4.40
52	6.25	4.25
56+60	6.70	4.70
66	6.75	4.75
70+76	6.49	4.49
74	6.70	4.70
77+110	6.65	4.65
81	6.53	4.53
92+84	6.19	4.19
85	6.90	4.90
87	6.40	4.40
89	6.07	4.07
99	6.46	4.46
101	6.60	4.60
105+132+153	7.15	5.15
118	6.80	4.80
123+149	6.90	4.90
163+138	6.93	4.93
146	7.10	5.10
151	6.90	4.90
170+190	7.05	5.05
172+197	6.80	4.80
180	7.05	5.05
187+182	6.40	4.40
195+208	6.70	4.70
196+203	6.90	6.90
201	6.65	4.65

¹Initially estimated based on two-phase partitioning model and then calibrated during the LM2-Toxic calibration.

²Computed based on the assumption of $K_{DOC} = 0.01 K'_{POC\alpha}$.

Table 4.4.29. Values of Parameters Used for Air-Water Exchange in the LM2-Toxic for the LMMBP Selected PCB Congeners (Bamford *et al.*, 2002)

PCB Congeners	Molecular Weight (g/mol)	Enthalpy (kJ/mol)	Entropy (kJ/mol °K)
5+8	223.10	46.0	0.115
15+17	240.30	46.5	0.120
16+32	257.54	44.5	0.110
18	257.54	35.0	0.080
26	257.54	41.0	0.100
28+31	257.54	34.0	0.085
33	257.54	43.0	0.110
37+42	274.77	41.0	0.095
44	291.99	26.0	0.050
49	291.99	25.0	0.050
52	291.99	32.5	0.070
56+60	291.99	28.5	0.065
66	291.99	27.5	0.060
70+76	291.99	27.0	0.060
74	291.99	25.0	0.050
77+110	309.21	35.0	0.090
81	291.99	33.0	0.070
92+84	326.43	25.0	0.040
85	326.43	21.0	0.050
87	326.43	33.0	0.070
89	326.43	27.0	0.040
99	326.43	22.0	0.020
101	326.43	30.0	0.070
105+132+153	349.40	61.0	0.190
118	326.43	44.0	0.130
123+149	343.66	47.5	0.135
163+138	360.88	80.0	0.250
146	360.88	61.0	0.170
151	360.88	32.0	0.100
170+190	395.32	145.0	0.485
172+197	412.55	137.0	0.460
180	395.32	137.0	0.450
187+182	395.32	97.0	0.295
195+208	446.99	146.0	0.250
196+203	446.99	143.0	0.490
201	429.77	138.0	0.460

-
- Carter, C.W. and I.H. Suffet. 1982. Binding of DDT to Dissolved Humic Materials. *Environ. Sci. Technol.*, 16(11):735-740.
- Chapra, S.C. and K.H. Reckhow (Eds.). 1983. *Engineering Approaches for Lake Management, Volume 2: Mechanistic Modeling*. Ann Arbor Science Publishers, Ann Arbor, Michigan. 492 pp.
- Chiou, C.T., R.L. Malcolm, T.I. Brinton, and D.E. Kile. 1986. Water Solubility Enhancement of Some Organic Pollutants and Pesticides by Dissolved Humic and Fulvic Acids. *Environ. Sci. Technol.*, 20(5):502-508.
- Chiou, C.T., D.E. Kile, E.I. Brinton, R.L. Malcolm, and J.A. Leenheer. 1987. A Comparison of Water Solubility Enhancements of Organic Solutes by Aquatic Humic Materials and Commercial Humic Acids. *Environ. Sci. Technol.*, 21(12):1231-1234.
- Cohn, T.A., L.L. DeLong, E.J. Gilroy, R.M. Hirsch, and D.K. Wells. 1989. Estimating Constituent Loads. *Water Resources Res.*, 25:937-942.
- DePinto, J.V., R. Raghunathan, P. Sierzenga, X. Zhang, V.J. Bierman, Jr., P.W. Rodgers, and T.C. Young. 1993. Recalibration of GBTOX: An Integrated Exposure Model for Toxic Chemicals in Green Bay, Lake Michigan. Final Report. U.S. Environmental Protection Agency, Office of Research and Development, ERL-Duluth, Large Lakes Research Station, Grosse Ile, Michigan. 132 pp.
- Di Toro, D.M. 1985. A Particle Interaction Model of Reversible Organic Chemical Sorption. *Chemosphere*, 14(10):1503-1538.
- Eadie, B.J., N.R. Morehead, and P.F. Landrum. 1990. Three-Phase Partitioning of Hydrophobic Organic Compounds in Great Lakes Water. *Chemosphere*, 20(1/2):161-178.
- Eadie, B.J., N.R. Morehead, J.V. Klump, and P.F. Landrum. 1992. Distribution of Hydrophobic Organic Compounds Between Dissolved and Particulate Organic Matter in Green Bay Waters. *J. Great Lakes Res.*, 18(1):91-97.
- Eadie, B.J. and J.A. Robbins. 2004. Composition and Accumulation of Lake Michigan Sediments. In: M. Munawar and T. Edsall (Eds.), *The State of Lake Michigan*. In press.
- Endicott, D.D., W.L. Richardson, and D.J. Kandt. 2005. 1992 MICHTOX: A Mass Balance and Bioaccumulation Model for Toxic Chemicals in Lake Michigan. In: R. Rossmann (Ed.), *MICHTOX: A Mass Balance and Bioaccumulation Model for Toxic Chemicals in Lake Michigan, Part 1*. U.S. Environmental Protection Agency, Office of Research and Development, National Health and Environmental Effects Research Laboratory, MED-Duluth, Large Lakes Research Station, Grosse Ile, Michigan. EPA/600/R-05/158, 140 pp.
- Green, M.L., J.V. DePinto, C.W. Sweet, and K.C. Hornbuckle. 2000. Regional Spatial and Temporal Interpolation of Atmospheric PCBs: Interpretation of Lake Michigan Mass Balance Data. *Environ. Sci. Technol.*, 34(9):1833-1841.
- Hall, D. and D. Robertson. 1998. Estimation of Contaminant Loading from Monitored and Unmonitored Tributaries to Lake Michigan for the USEPA Lake Michigan Mass Balance Study. Quality Systems and Implementation Plan. Submitted October 23, 1998. U.S. Environmental Protection Agency, Great Lakes National Program Office, Chicago, Illinois. 19 pp.
- Hassett, J.P., J.C. Means, W.L. Barnwart, and S.G. Wood. 1980. Sorption Properties of Sediments and Energy-Related Pollutants. U.S. Environmental Protection Agency, Environmental Research Laboratory, Athens, Georgia. EPA/600/3-80/041, 133 pp.
- Hasset, J.P. and E. Milicic. 1985. Determination of Equilibrium and Rate Constants for Binding of a Polychlorinated Biphenyl Congener by Dissolved Humic Substances. *Environ. Sci. Technol.*, 19(7):638-643.
- Hawker, D.W. and D.W. Connell. 1988. Octanol-Water Partition Coefficients of Polychlorinated Biphenyl Congeners. *Environ. Sci. Technol.*, 22(4):382-387.

-
- Karickhoff, S.W. 1981. Semi-Empirical Estimation of Hydrophobic Pollutants on Natural Sediments and Soils. *Chemosphere*, 10(8):833-846.
- Landrum, P.F., S.R. Nihart, B.J. Eadie, and W.S. Gardner. 1984. Reverse-Phase Separation Method for Determining Pollutant Binding to Aldrich Humic Acid and Dissolved Organic Carbon of Natural Waters. *Environ. Sci. Technol.*, 18(3):187-192.
- Landrum, P.F., S.R. Nihart, B.J. Eadie, and L.R. Herche. 1987. Reduction in Bioavailability of Organic Contaminants to the Amphipod *Pontoporeia hoyi* by Dissolved Organic Matter of Sediment Interstitial Waters. *Environ. Toxicol. Chem.*, 6(1):11-20.
- Lesht, B.M. 1988a. Comparison of Two Computer Programs for Volume-Weighted Averaging of Limnological Data. Final Report. U.S. Environmental Protection Agency, Great Lakes National Program Office, Chicago, Illinois.
- Lesht, B.M. 1988b. Nonparametric Evaluation of the Size of Limnological Sampling Networks: Application to the Design of a Survey of Green Bay. *J. Great Lakes Res.*, 14(3):325-337.
- McCarty, H.B., J. Schofield, K. Miller, R.N. Brent, P. Van Hoff, and B. Eadie. 2004. Results of the Lake Michigan Mass Balance Study: Polychlorinated Biphenyls and *trans*-Nonachlor Data Report. U.S. Environmental Protection Agency, Great Lakes National Program Office, Chicago, Illinois. EPA/905/R-01/011, 289 pp.
- Miller, S.M., M.L. Green, J.V. DePinto, and K.C. Hornbuckle. 2001. Results from the Lake Michigan Mass Balance Study: Concentrations and Fluxes of Atmospheric Polychlorinated Biphenyls and *trans*-Nonachlor. *Environ. Sci. Technol.*, 35(2):278-285.
- Richards, *R.P. 1998. Estimation of Pollutant Loads in Rivers and Stream: A Guidance Document for NPS Programs. U.S. Environmental Protection Agency, Region VIII, Denver, Colorado. 108 pp.
- Richardson, W.L., D.D. Endicott, R.G. Kreis, Jr., and K.R. Rygwelski (Eds.). 2004. The Lake Michigan Mass Balance Project Quality Assurance Plan for Mathematical Modeling. Prepared by the Modeling Workgroup. U.S. Environmental Protection Agency, Office of Research and Development, National Health and Environmental Effects Research Laboratory, MED-Duluth, Large Lakes Research Station, Grosse Ile, Michigan. EPA/600/R-04/018, 233 pp.
- Robbins, J.A., N.R. Morehead, R.W. Rood, D.N. Edgington, and S. Meyer. 1999. Accumulation and Near-Surface Mixing of Sediments in Lake Michigan as Determined for the Lake Michigan Mass Balance Program, Volumes 1 and 2. Project Report. U.S. Environmental Protection Agency, Office of Research and Development, ERL-Duluth, Large Lakes Research Station, Grosse Ile, Michigan. 503 pp.
- Schwab, D. and D. Beletsky. 1998. Lake Michigan Mass Balance Study: Hydrodynamic Modeling Project. National Oceanic and Atmospheric Administration, Great Lakes Environmental Research Laboratory, Ann Arbor, Michigan. NOAA Technical Memorandum ERL GLERL-108, 53 pp.
- Thomann, R.V. and J.A. Mueller. 1987. Principles of Water Quality Modeling and Control. Harper and Row Publishers, New York, New York. 644 pp.
- U.S. Environmental Protection Agency. 1997. Lake Michigan Mass Balance Study (LMMB) Methods Compendium, Volume 1: Sample Collection Techniques. U.S. Environmental Protection Agency, Great Lakes National Program Office, Chicago, Illinois. EPA/905/R-97/012a, 1,440 pp.

PART 4

LM2-TOXIC

Appendix 4.4.1 Sample Data Interpolation for the LMMBP

Xiangsheng Xia
Computer Sciences Corporation
Large Lakes Research Station
9311 Groh Road
Grosse Ile, Michigan 48138

Many sample data sets of physical and chemical parameters collected for the Lake Michigan Mass Balance Project (LMMBP) were often sparse and occurred on irregular grids. For modeling purposes, values of these parameters were needed on a 5 x 5 km grid. This presented a problem of using sample data to estimate or predict values in areas which were not sampled. Thus, some interpolation mechanisms based on "insufficient" samples were needed to bridge the gap between the desired and the reality world of data collection. Distance square inverse and natural-neighbor interpolation methods were carefully studied and applied to sample data analysis for this project.

The distance-weighted-averaging approach determines the estimated values at grid points as the sum of weighted values of the individual sample datum. In general, the closer a datum point to the grid point to be estimated, the greater influence the datum at that point exerts. It is a method characterized as a global approach. The distance-weighted-averaging method is well understood and widely accepted by scientists in various fields. It is also easy to implement. The major disadvantage of this method has been its tendency to smooth out all small variations in the relatively small local area.

Therefore, it is not very well suited to find the trend of samples in small local areas. The distance-weighted-averaging interpolation is compromised by its essentially one-dimensional nature. Although the interpolating surface is smooth, it cannot, for instance, form ridges or domes from sparse data. Furthermore, distance-weighted-averaging is unable to infer (or extrapolate) a surface lying above or below the range of sample values. In general, the estimation computed by distance-weighted-averaging lies between the maximum and minimum of the sample data.

Neighborhood-based interpolation, on the other hand, is a local approach which utilizes all the (natural) neighbors of the sample points. The natural-neighbor method can infer values outside the known range. It is unique for a given data configuration and choice of blending function parameters. If used properly on dense data sets, neighborhood-based interpolation can provide much richer information such as rapid changes, ridges, or dams in smaller areas. However, neighborhood-based interpolation, in contrast to distance-based methods, is much more complicated to implement and harder to understand. In case an ambiguity or unexpected phenomena arise from a neighborhood-based interpolation, it may require a knowledgeable person to make reasonable interpretation of results.

During the course of the LMMBP data analysis process, distance square inverse interpolation combined with application codes written in Interactive Data Language (IDL) were used intensively to find the interpolated values of a 5 x 5 km grid of Lake Michigan for various parameters,

such as polychlorinated biphenyls (PCBs), atrazine, nutrients, etc. On the other hand, natural-neighbor interpolation was primarily used for sediment data analysis where sample locations were relatively dense.

More details of distance square inverse and natural-neighbor interpolations are presented in the next two sections. Many applications of interpolation have been developed, including contour plots, volume-weighted averages, and others. These are discussed in Section 4.4.1.4. Some problems applying natural-neighbor interpolation are discussed in Section 4.4.1.5.

4.4.1.1 The Distance Square Inverse Method

The inverse distance to a power method is a weighted-average interpolation. Data are weighted during interpolation such that the influence of one sample point relative to another declines with increasing distance from the grid node. Weighting is assigned to data using a weighting power that controls how the weighting factor drops off as distance from a grid node increases. As the power increases, the grid node value approaches the value of the neighboring data points. The weighting power determines how quickly weighting falls off with distance from the grid node. As the power approaches zero, the generated surface approaches a horizontal planar surface through the average of all observations from the data file. As the power increases, the generated surface is a “nearest neighbor” interpolation, and the resultant surface becomes polygons which represent the nearest observation to the interpolated node. Power values are usually between one and three to avoid extreme results. Distance square inverse is the distance-weighted method with the power chosen as two.

The smoothing factor parameter allows one to incorporate an uncertainty factor associated with sample data. The larger the smoothing factor parameter, the less influence a particular observation has in computing a neighboring grid. The smoothing factor for this study was 2.5 (miles).

The equation in the inverse distance square method is:

$$v_i = \frac{\sum_{j=1}^n \left(\frac{1}{d_{ij}^2 + r_o^2} \cdot C_j \right)}{\sum_{j=1}^n \left(\frac{1}{d_{ij}^2 + r_o^2} \right)} \quad (\text{A4.4.1.1})$$

where

j = runs for all samples

v_i = interpolated value at grid point i ,

C_j = value of sample j ,

d_{ij} = distance between grid point i and sample location j ,

r_o = smoothing factor

n = total number of samples being considered in the interpolation

An IDL code which implements the inverse distance square interpolation scheme was received from David Schwab (National Oceanic and Atmospheric Administration, Great Lakes Environmental Research Laboratory). This was further developed for the LMMBP data analysis.

4.4.1.2 The Natural-Neighborhood Method

Natural-neighbor interpolation offers a different approach to spatial interpolation and extrapolation. It has good mathematical properties and offers more flexibility than the distance square inverse method.

All interpolation methods involve, to some extent, the idea that the value of the interpolated point should depend more on data values at nearby data sites than at distant ones. In natural-neighbor interpolation, the idea of neighbors in a spatial configuration is formalized in a natural way and made quantitative, and the properties of the method depend on an apparently new geometrical identity relating this quantitative measure of neighbors to position.

Any two data are natural-neighbors if there is a location or region that is equally close to each of the pair, and no other datum is closer. Any three or more data on the plane are natural-neighbors if no other datum lies within their circum-circle. The spatial relationships determined by a set of natural-neighbors circles have two common and widely known graphical representations. These are Voronoi tessellation (of Voronoi polygons) and Delaunay triangulations. The Voronoi tessellation illustrates that each datum has a unique natural-neighbor region associated with it and is bounded by halfway interfaces of that datum with its natural-neighbor. Neighborhood coordinates are local coordinates relating the position of the interpolation point to reach a datum in the neighborhood subset. These coordinates (weights for the interpolation), ranging between zero and one, are proportional to areas defined on natural-neighbor regions for each of the data. Such coordinates are superior to distance-based coordinates. Distance-based coordinates make no allowance for the distances to the other data; that is, distance-based interpolation is not sensitive to a changing spatial context. Finally, natural-neighbor interpolation is a linear-weighted average of natural-neighbor coordinates. The basic equation used in natural-neighbor interpolation can be defined as follows:

$$V_i = \sum_{j=1}^k (W_j \cdot S_j) \quad (\text{A4.4.1.2})$$

where

V_i = interpolated value at grid point i ,

k = number of samples inside the natural-neighborhood of V_i ,

S_j = value of sample j ,

W_j = weight associated with S_j .

The c-code `nngridr`, a complete commercial package of the natural-neighbor algorithm, from David Watson (Watson, 1994), with some modification by in-house developers, was used for developing applications of natural-neighbor interpolation at the Large Lakes Research Station (LLRS).

4.4.1.3 Application

Interpolations, distance square inverse or natural-neighbor, were needed to build two-dimensional estimates of a 5 x 5 km grid of Lake Michigan from a limited number of samples of various parameters. Other applications could then be applied based on the interpolated grid data.

4.4.1.3.1 Contouring Plots

Interpolated grid data is a list of numbers representing the estimates of physical parameters on the grid for each grid point. Contour plots connect points in the grid having the same value with lines. An incredible amount of information about the data can be revealed by contour plots. These include plateaus and canyons, trends, the existence and location of high and low concentrations, etc.

Contour plots are very effective visualization tools for analyzing data. Contours in this study were created by using IDL and other tools. There were a surprising variety of approaches used to generate contours. The various techniques that were applied possess their own advantages and disadvantages. IDL's standard `CONTOUR` procedure uses grid contouring which is the most widely used contouring technique (Research Systems, Inc., 1995, see Section 15-1). `CONTOUR` generates plots from data stored in a rectangular array (grid data) which usually is generated by interpolation and extrapolation. Some other information such as the boundary of Lake Michigan, sample locations, and the maximum and minimum values for samples were also produced.

4.4.1.3.2 Volume-Weighted Averaging With Formulations

One way to evaluate and validate the performance of mathematical models is to compare the model output and the measured data at the same time (cruises) and same location (segments). Volume-weighted average (VWA) is a method to compute the estimated field data associated with a segment and a cruise. Depending on the model and segmentation scheme used, a segment consists of cells of 5 x 5 km at certain depth range called a layer. The locations of cells associated with segments are normally

provided by segmentation files. The volume concentration for one cell can be computed by multiplying interpolated concentration of this cell by its volume. The volume concentration for a segment is the sum of volume concentration of all cells in this segment. And finally, VWA can be computed by dividing the volume concentration of the segment by the total segment volume. The equation for computing VWA is :

$$A_n = \frac{\sum_{i=1}^n (V_i \cdot C_i)}{\sum_{i=1}^n V_i} \quad (\text{A4.4.1.3})$$

where

A_n = volume-weighted average of segment n ,

V_i = volume of cell i ,

C_i = concentration associated with cell i .

n = total number of cells

Besides the VWAs, statistical information (mean, variance, standard error) is also generated for the users. VWAs were generated by IDL programs developed in-house. The interpolated grid field data were generated by either distance square inverse or natural-neighbor from samples collected for the LMMBP project.

4.4.1.4 Discussion

It has been observed and documented that extrapolations generated by using the natural-neighbor c-code `nngridr` could cause problems. Extrapolation sometimes is necessary to estimate values for grid points located outside the convex hull, which is a polygon bounded by the outermost sample data points. At the beginning of the interpolation process of running `nngridr`, a very large triangle is established which encloses all data being used for interpolation. Then, a pseudo datum is assigned to each of the three vertices of the triangle. Extrapolation, if needed, is performed based on the pseudo data. This process is doomed to be unreliable due to the unpredictable nature of the

pseudo numbers and the large triangle used in this process.

This problem can be remedied by adding some extra reasonable pseudo samples at the corners outside the gridding data area so all interpolated grid points will be inside the expanded convex hull. By doing this, `nngridr` is forced to use interpolation, rather than extrapolation, to calculate estimations based on the original and pseudo samples. This is a more reliable estimation process. The choice of pseudo samples, if necessary, should be based on experience and nearby samples.

Another limitation of `nngridr` is that it can only handle two-dimensional interpolation. There are occasions when three-dimensional interpolation is needed. One example is the sediment PCB concentration estimations to be used for fish uptake. This is much better represented if the depth of samples could be utilized to define the neighborhood. The neighborhood becomes a three-dimensional ball instead of a two-dimensional circle. Because `nngridr` is a relatively large program, there was no easy way to add a three-dimensional interpolation.

4.4.1.5 Steps to Run `nngridr`

The c-code from David Watson, `nngridr`, was used to generate the natural-neighbor interpolation. Often, `nngridr` was called within an IDL program to generate the interpolation. Sample data were reformatted to the required IDL format. The interpolation on the 5 km grid was then used for data analysis and visualization (post-process) applications.

Details about how to initialize and run `nngridr` together with IDL application programs at LLRS follow.

1. Change the c-code

In `nngridr.c`, comment out the statement `'Instring()'` right after the statement `'printf'` ("Change parameters or Make the grid? C or M"), to prevent the read option from a terminal. Therefore, the c-code `nngridr` to generate the grid is run by using the default option 'M'.

2 Initialization

- A. Change the make file and then use the command: `%make -f makefile` to generate the executable code.
 - B. The `nngridr` is run first to generate the initial file and setup parameters (file names, grid configurations, etc.). The result will be in `nngridr.ini`, which can be used for successive runs without changing parameters again. The most important aspect of initialization is to generate a two-dimensional grid. The southwest corner with longitude -87.9721 and latitude 41.5845 is used as the origin of the grid coordinates. The northeast corner is at longitude -84.7206 and latitude 46.1069 which is the grid coordinate of (53, 102). There is an option to output the grid south-north or north-south. The orientation of output should be set from south-to-north. Otherwise, the image will be upside down. See Watson (1994) for more details.
3. Raw data files are pre-processed to prepare the input data for IDL code. The formats of data files should be the same.
 4. The configuration of segmentation should be stored in a file for the segmentation classification.
 5. IDL programs are coded to generate data files similar to `jdavis.dat` by reading the pre-processed data. Coordinates are converted from longitude and latitude coordinates to 5 km grid coordinates.

6. Once the `jdavis.dat` is established, `nngridr` is run by the following commands within IDL programs:

`'SPAWN, 'nngridr', Results, /NOSHELL'`.

This creates a child process under the Unix operating system and stores all messages generated by this code into the character array `Results`.

7. After a successful run (need error checking if run fails), the grid data should be generated and named as `nngridr.grd`. This file is called in IDL programs to generate contour plots, VWA results, and statistics.
8. For the Unix system, both `jdavis.dat` and `nngridr.grd` will be destroyed automatically when new ones are created. For other operating systems, Microsoft Windows, for example, these files need to be deleted.
9. Green Bay data need to be processed separately from open lake data.

References

- Research Systems, Incorporated. 1995. IDL User's Guide: Interactive Data Language, Version 4. Research Systems, Incorporated, Boulder, Colorado. 544 pp.
- Watson, D. 1994. `nngridr` - An Implementation of Natural Neighbor Interpolation. Claremont, Australia. 170 pp.

PART 4

LM2-TOXIC

Chapter 5. LM2-Toxic Calibration and Confirmation

For diagnosis of system behavior and reasonable prediction of long-term reactions of a water system, it is very important that a water quality model is well-calibrated and confirmed under a conceptually well-constructed solid and toxic chemical dynamics. Two of the main objectives in developing the Level 2 contaminant transport and fate model (LM2-Toxic) were to calibrate and confirm the model using the Lake Michigan Mass Balance Project (LMMBP)-generated data and to apply the model for long-term forecasts of the polychlorinated biphenyl (PCB) concentrations in water and sediment of the lake for different forcing functions and loading scenarios. The advantages of calibrating a coarse spatial grid water quality model like LM2-Toxic are its efficiency and quickness.

LM2-Toxic is a coupled mass balance of organic carbon solids and toxic chemical (PCBs) dynamics. Because of no feedback mechanisms from PCB behavior to organic carbon behavior in the model, the calibration of the LM2-Toxic was done using two separate calibration stages. The first stage was the calibration of organic carbon dynamics without considering any behavior of PCBs in the system and the second stage was the calibration of PCB dynamics without adjusting any parameters associated with organic carbon dynamics.

Prior to the organic carbon and PCB dynamic calibrations, the LM2-Toxic was used as a thermal balance model to calibrate the vertical dispersion coefficients between the water column layers. A

detailed description of inputs used in the thermal balance model can be found in Part 4, Chapter 4, Section 4.4.1.2.

The data collected for the LMMBP were spatially averaged using a volume-weighted averaging algorithm to generate segment-specific cruise mean concentrations (Appendix 4.4.1). The averaging algorithm also computed the statistical standard error that was expressed as error bars related to the mean. The cruise mean concentrations were compared with the predicted concentrations from the LM2-Toxic for the vertical dispersion coefficients calibration, the organic carbon dynamics calibration, and the PCB dynamics calibration.

4.5.1 Vertical Dispersion Coefficients Calibration

Vertical dispersion coefficients at the interfaces between LM2-Toxic water column layers were very important to overall water transport in Lake Michigan. The vertical mixing defined by the vertical dispersion coefficients moves large amounts of mass vertically in the lake and is strongly influenced by water temperature that has a distinct seasonal variation. A thermal balance model was applied to calibrate the predefined vertical dispersion coefficients. The results in Appendix 4.5.1 demonstrate excellent agreement between observed temperature and the model simulation for the LMMBP period. The results from the thermal balance model were also compared to the results from the Princeton Ocean Hydrodynamic Model (POM) (Schwab and Beletsky, 1998) for selected segments (Figure 4.5.1). Both

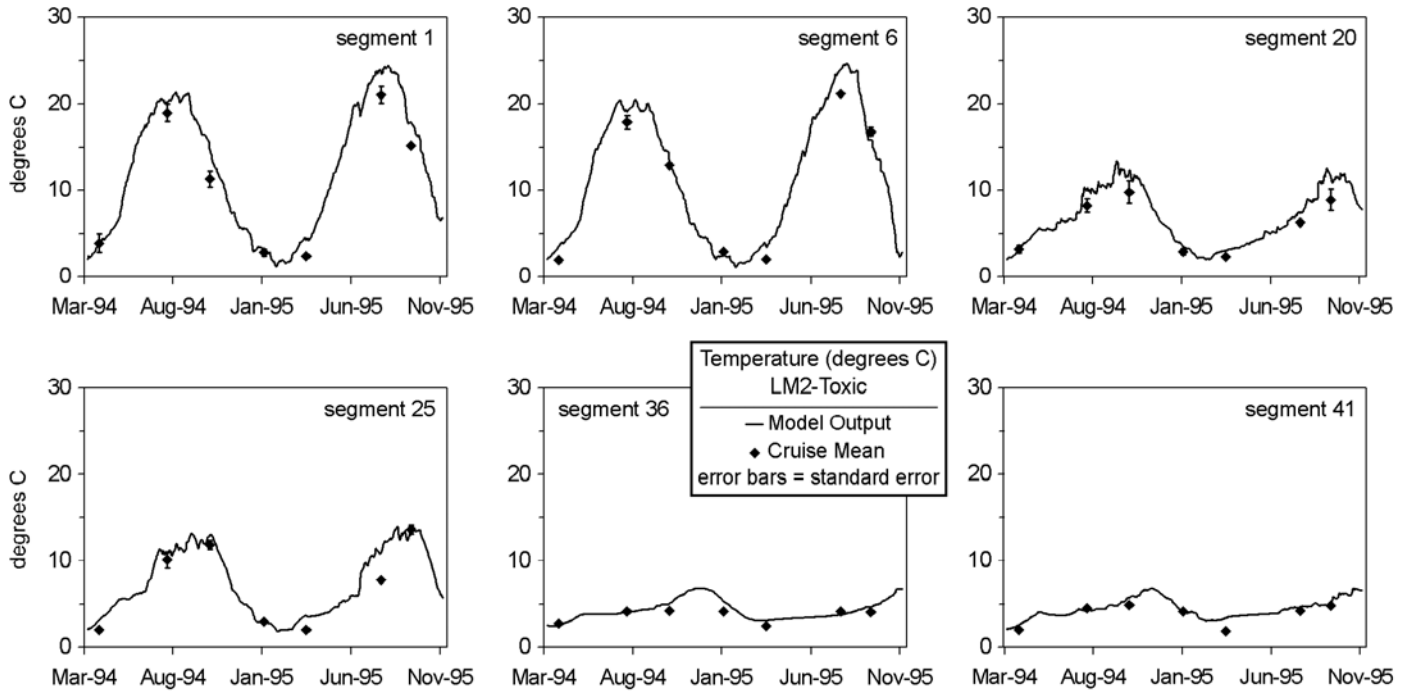

Figure 4.5.1a. Comparison between the temporal profiles for temperature results from the LM2-Toxic.

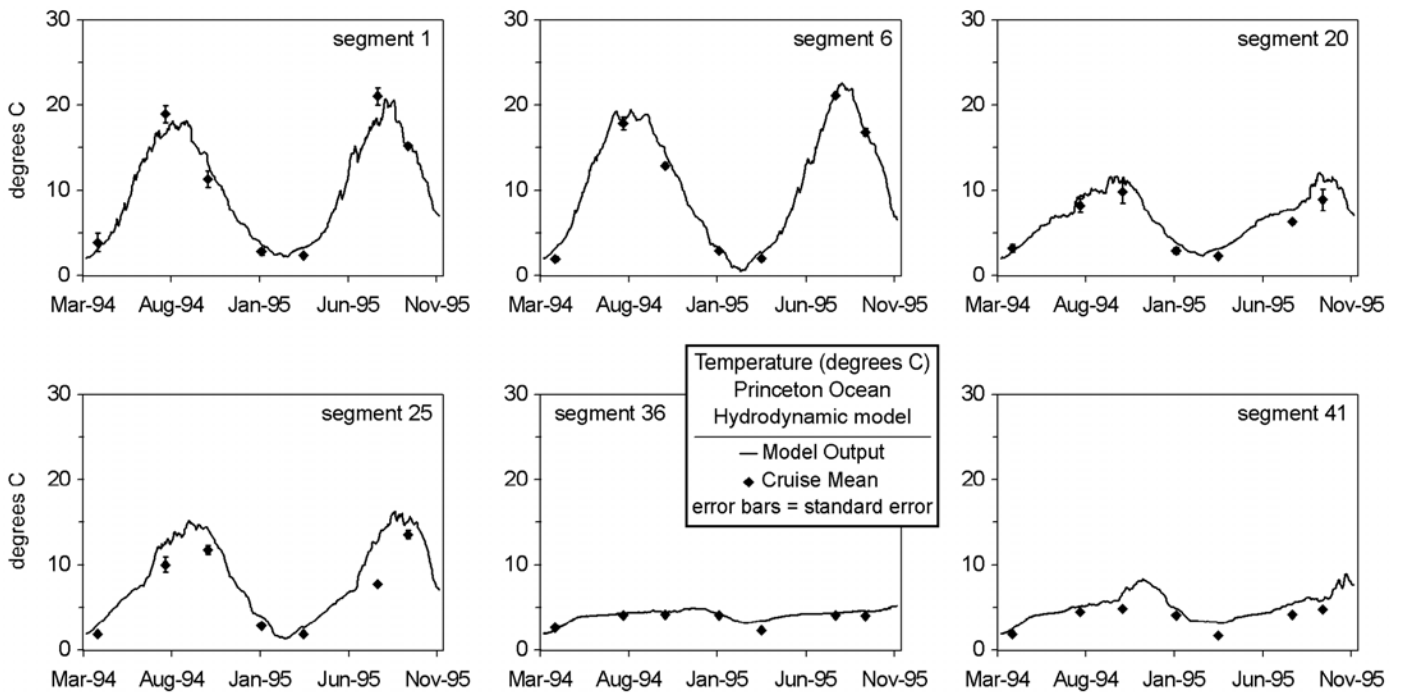

Figure 4.5.1b. Comparison between the temporal profiles for temperature results from the Princeton Ocean Hydrodynamic model.

models did a good job of simulating temperature in the lake.

4.5.2 Organic Carbon Dynamics Calibration

Because the movement of particulate organic carbon (POC) (POC = PDC + BIC, where PDC = particulate detrital carbon, BIC = biotic carbon) dominates the transport and fate of the PCBs in a natural water system, the quality of the calibration of the organic carbon sorbent dynamics was very crucial for a successful subsequent calibration of PCB dynamics. The calibration strategy for the organic carbon dynamics was to 1) fix as many independent parameters used in the model as possible based on literature, field measurements, and analytical results from the field samples, and 2) adjust the parameters considered to be the most uncertain and site-specific without using values exceeding their range constrained by literature.

4.5.2.1 Calibration Process/Procedure

The procedures taken in the organic carbon dynamics calibration for the LM2-Toxic were the following:

1. Fixing segment-specific sediment burial rates (v_b) and thickness of surficial sediment mixing layer based on analyzed results from the LMMBP sediment core measurements (Robbins *et al.*, 1999).
2. Fixing the dissolved organic carbon (DOC) diffusion coefficient between the surficial sediment layer and the overlying water column at $1.73 \times 10^{-4} \text{ m}^2/\text{d}$ (DePinto *et al.*, 1993).
3. Fixing segment-specific critical wave heights using Equation 4.3.12.
4. Assigning initial segment-specific settling velocities for BIC and PDC based on values from the literature (DePinto *et al.*, 1993; Eadie *et al.*, 1990; Baker *et al.*, 1991; Eadie, 1997, Eadie *et al.*, 1984; Thomann and Di Toro, 1983).
5. Estimating segment-specific empirical wave coefficients (α) using Equation 4.3.11.

6. Computing segment-specific daily resuspension rates using procedures described in Sections 4.3.4.2.1 (Steady-State Resuspension Calculation) and 4.3.4.2.2 (Empirical Wave-Induced Resuspension Calculation).
7. Executing the LM2-Toxic, examining model outputs (carbon concentrations), and adjusting segment-specific settling velocities and resuspension rates accordingly by repeating steps 4-6 as necessary.
8. Adjusting biochemical organic carbon transformation rates and yield coefficients listed in Table 4.4.16.

Most of the organic carbon decay rates (transformation rates) and yield coefficients were initially given the same values used in the Green Bay Mass Balance Project (GBMBP) and were adjusted during the LM2-Toxic organic carbon dynamics calibration. The principal parameters adjusted during the organic carbon dynamics calibration were rates related to carbon vertical transport such as settling and resuspension velocities, carbon decay rates, and yield coefficients. The final values for these rates had to be consistent with available literature data and limnological theory.

4.5.2.2 Results and Discussion

The final values for the biochemical transformation rates and yield coefficients are presented in Table 4.4.16. The carbon decay rates and yield coefficients shown in this table are quite consistent with the limnological theory of organic carbon cycling in a natural water system. It was expected that the final carbon decay rates (left-hand side of Equations 4.3.3 - 4.3.5) in pelagic freshwater systems would decrease in the order of BIC, PDC, and DOC. Therefore, the values of substrate saturated decay rates and Michaelis-Menten half-saturation constants for the organic carbon would have the following sequences:

$$\hat{k}_{d(\text{BIC})} > \hat{k}_{d(\text{PDC})} > \hat{k}_{d(\text{DOC})} \text{ and } k_{1/2(\text{DOC})} > k_{1/2(\text{PDC})} > k_{1/2(\text{BIC})}, \text{ respectively.}$$

The lake-wide concentrations (including Green Bay) in surface water layers (epilimnion) for DOC, PDC,

and BIC could be as high as 1.8, 0.30, and 0.20 mg/L, respectively. It is favorable and reasonable to have the value of Michaelis-Menten half-saturation constant for each organic carbon state variable close to double that of its concentration. The final sediment PDC decay rate used in the LM2-Toxic was within the range of the value ($5.7 \times 10^{-5} \text{ d}^{-1}$ at 20°C) used in GBMBP (DePinto *et al.*, 1993) and the value (0.001 d^{-1}) from other literature (Gardiner *et al.*, 1984). The values of yield coefficients ($Y_{(\text{BIC} \rightarrow \text{PDC})}$, $Y_{(\text{PDC} \rightarrow \text{DOC})}$) in Table 4.4.16 indicated less loss to carbon dioxide (CO_2) during the conversion from BIC to PDC than during the conversion from PDC to DOC.

The model results of organic carbon dynamics calibration for the LM2-Toxic are presented in Figures 4.5.2 to 4.5.4 for temporal profiles of all 41 water column segments. The complete set of calibration plots for the organic carbon including temporal profiles in the sediments are provided in Appendix 4.5.2.

Figure 4.5.2 shows slight temporal variation of DOC in the main lake and outer Green Bay (see Figure 4.3.1 for Level 2 segmentation). This temporal change of DOC concentration was closely related to the strong seasonal variation of PDC concentration and was more evident in the epilimnion of the lake. Other than the inner Green Bay area, there was almost no horizontal or vertical spatial variation for DOC.

The temporal profiles based on the model outputs for both BIC and PDC (Figures 4.5.3 and 4.5.4) showed very strong seasonal variation throughout the lake, especially in the epilimnion segments. Excluding the inner shallow water of Green Bay segments where BIC concentration was controlled by its load from the Fox River and very localized algal growth, there was not much horizontal spatial variation for BIC in the lake. The peaks of the BIC temporal profiles for the epilimnion segments resulted from an algal bloom in late spring and early summer. Compared with the epilimnion segments, having a similar temporal variation, the concentration of BIC decreased dramatically in the hypolimnion segments.

The temporal profiles of PDC (Figure 4.5.4) indicated that the main lake and Green Bay were two very different systems. It appeared that the PDC

concentration in Green Bay was more dominated by sediment-water interactions (i.e., resuspension events evidenced by the spikes on the plots) than other components or processes such as tributary loads, decomposition of BIC, and its own decay. In the main lake where water segments were larger and thicker, there was little evidence of resuspension events from the PDC temporal profiles, with the exception of a couple of main lake segments at the end of 1995. Algal primary production and BIC-to-PDC decay were obvious control processes for PDC concentration in the main lake, especially in the epilimnion. An almost constant concentration of PDC (0.12 mg/L) in the large bottom water column segments indicated that, without much contribution from BIC decay to PDC in these segments, there were persistent and substantial PDC fluxes entering these segments by settling from the upper water column layer, resuspension from the surficial sediments, and/or focusing process from the adjacent shallower area (segments) in order to maintain this concentration of PDC.

Figures 4.5.5a to 4.5.5c show a comparison between the model predictions and observed data (cruise-segment mean concentration) of DOC, BIC, and PDC for the entire calibration (i.e., the LMMPB study period). In general, there was good agreement between the data and model predictions for all organic carbons. There was a slight overprediction of BIC concentration indicated by the low slope of the regression line. Though the results from the regression (Figure 4.5.5b) indicated a poorer quality of fit to the observed data and overprediction of BIC, visual examination of temporal profiles of BIC concentration (Figure 4.4.3) suggested the fit was good for most of the segments.

4.5.3 PCB Dynamics Calibration

Because of no feedback mechanisms from PCB dynamics to organic carbon dynamics, only a limited number of parameters associated with PCB dynamics needed to be slightly adjusted. Due to the significant influence of organic carbon movement on the transport and fate of PCBs in Lake Michigan, the PCB partitioning coefficient became one of the very crucial parameters for the LM2-Toxic PCB dynamics calibration. Mass budget analysis for ΣPCBs (see Chapter 6 for details) based on the outputs of the LM-2 Toxic for the two-year LMMPB period indicated

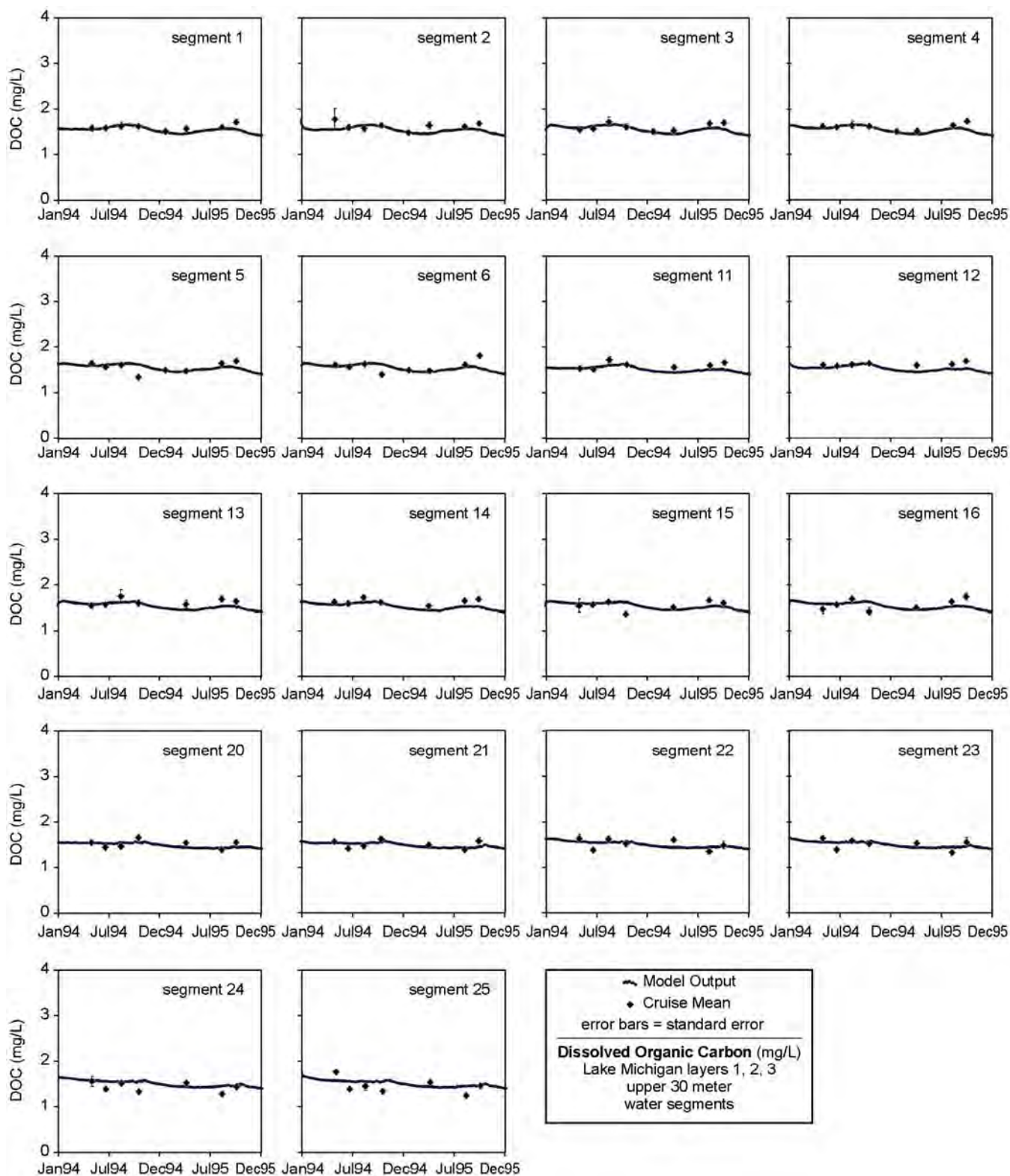

Figure 4.5.2. Temporal profiles of DOC in the Lake Michigan water column segments for the organic carbon dynamics calibration of the LM2-Toxic and the LMMBP cruise mean data.

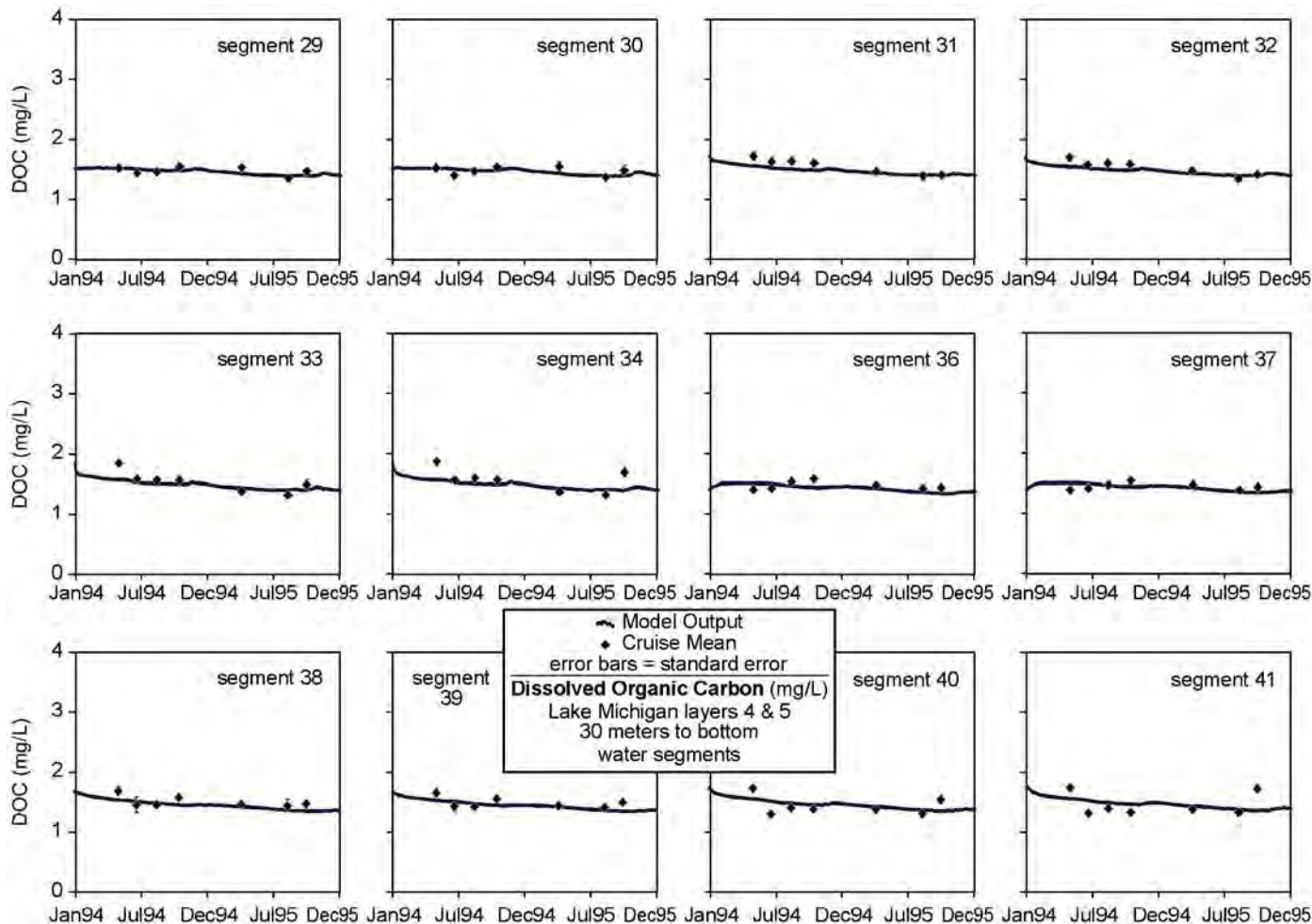

Figure 4.5.2. Temporal profiles of DOC in the Lake Michigan water column segments for the organic carbon dynamics calibration of the LM2-Toxic and the LMMBP cruise mean data (Continued).

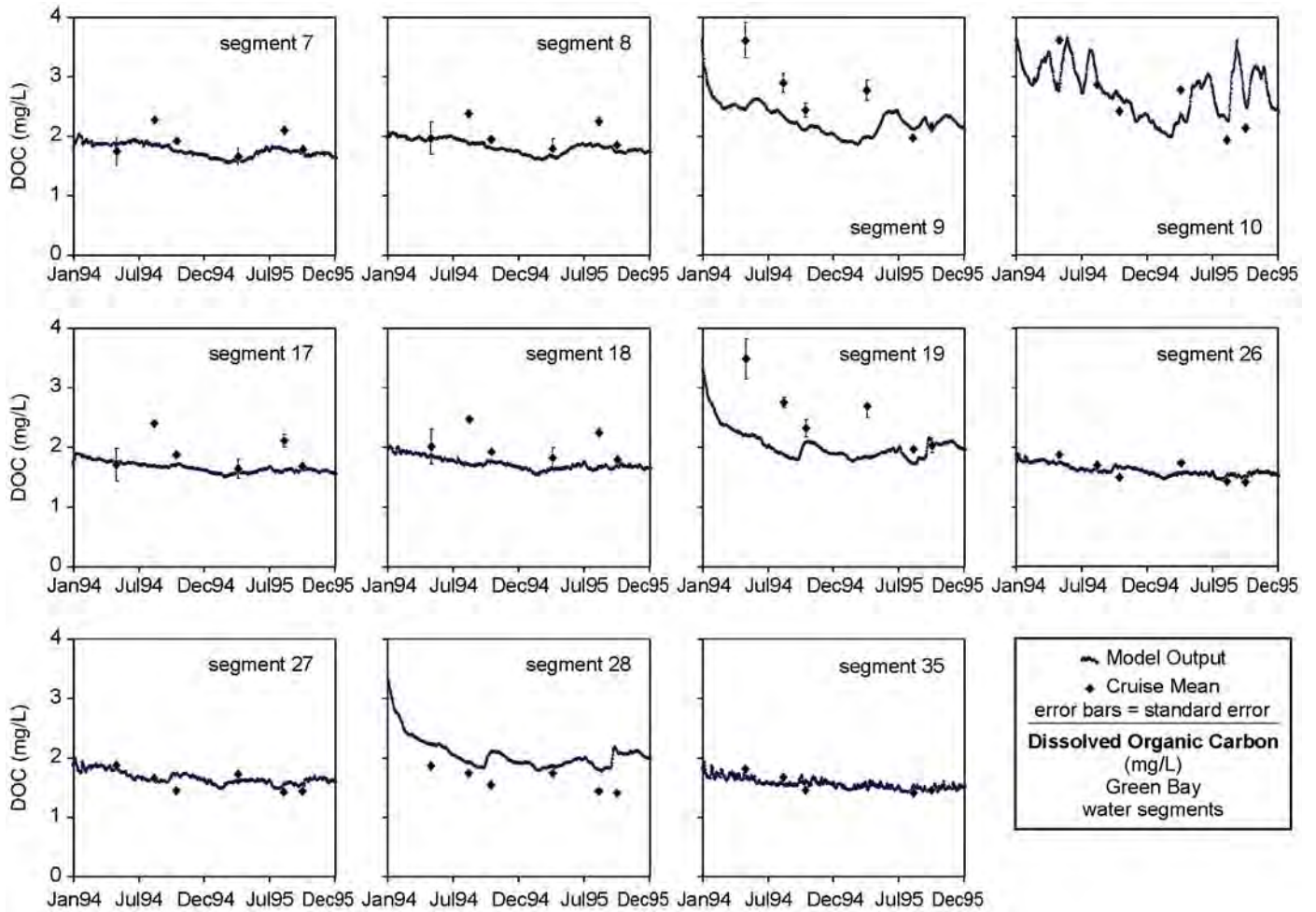

Figure 4.5.2. Temporal profiles of DOC in the Lake Michigan water column segments for the organic carbon dynamics calibration of the LM2-Toxic and the LMMBP cruise mean data (Continued).

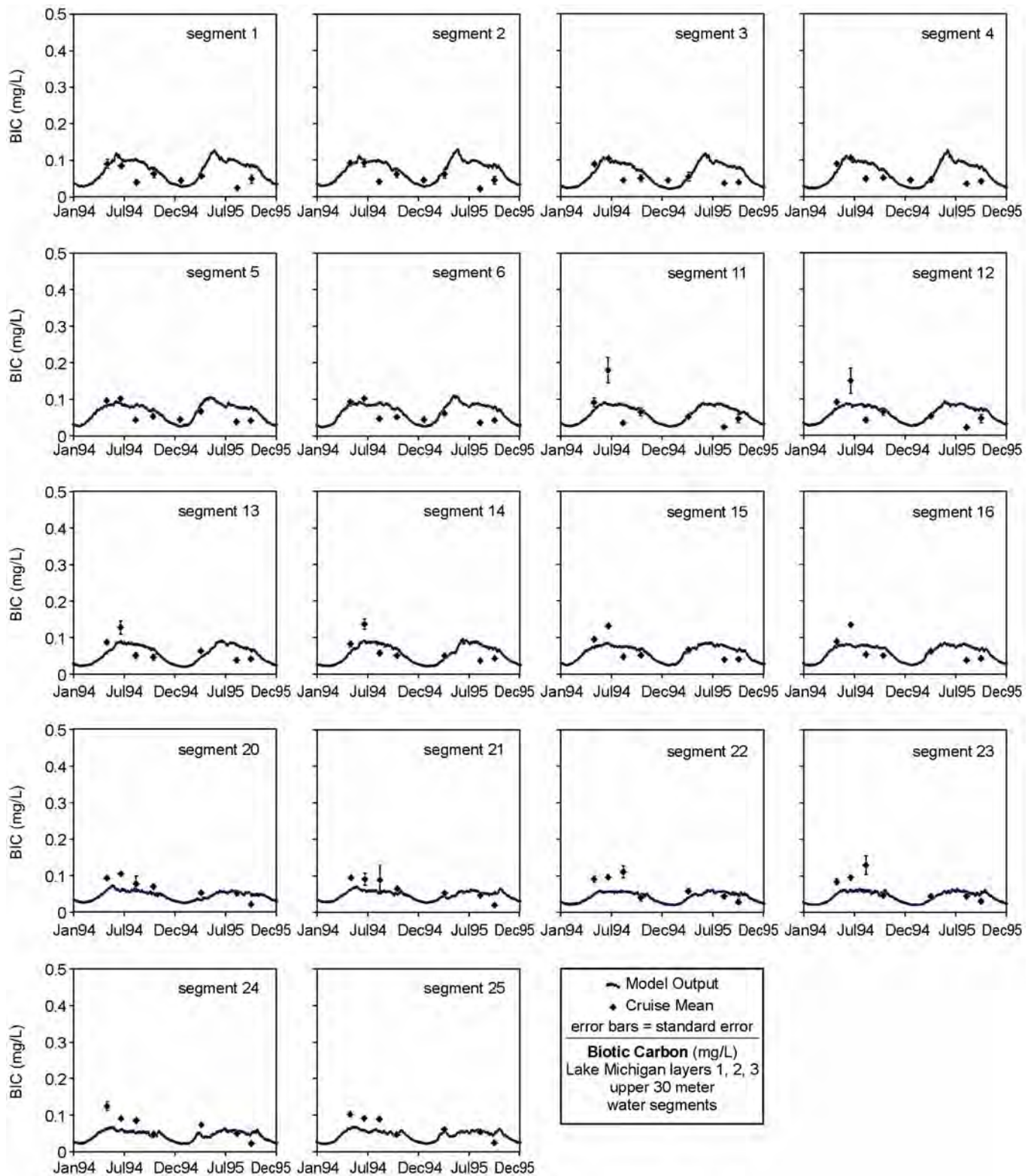

Figure 4.5.3. Temporal profiles of BIC in the Lake Michigan water column segments for the organic carbon dynamics calibration of the LM2-Toxic and the LMMBP cruise mean data.

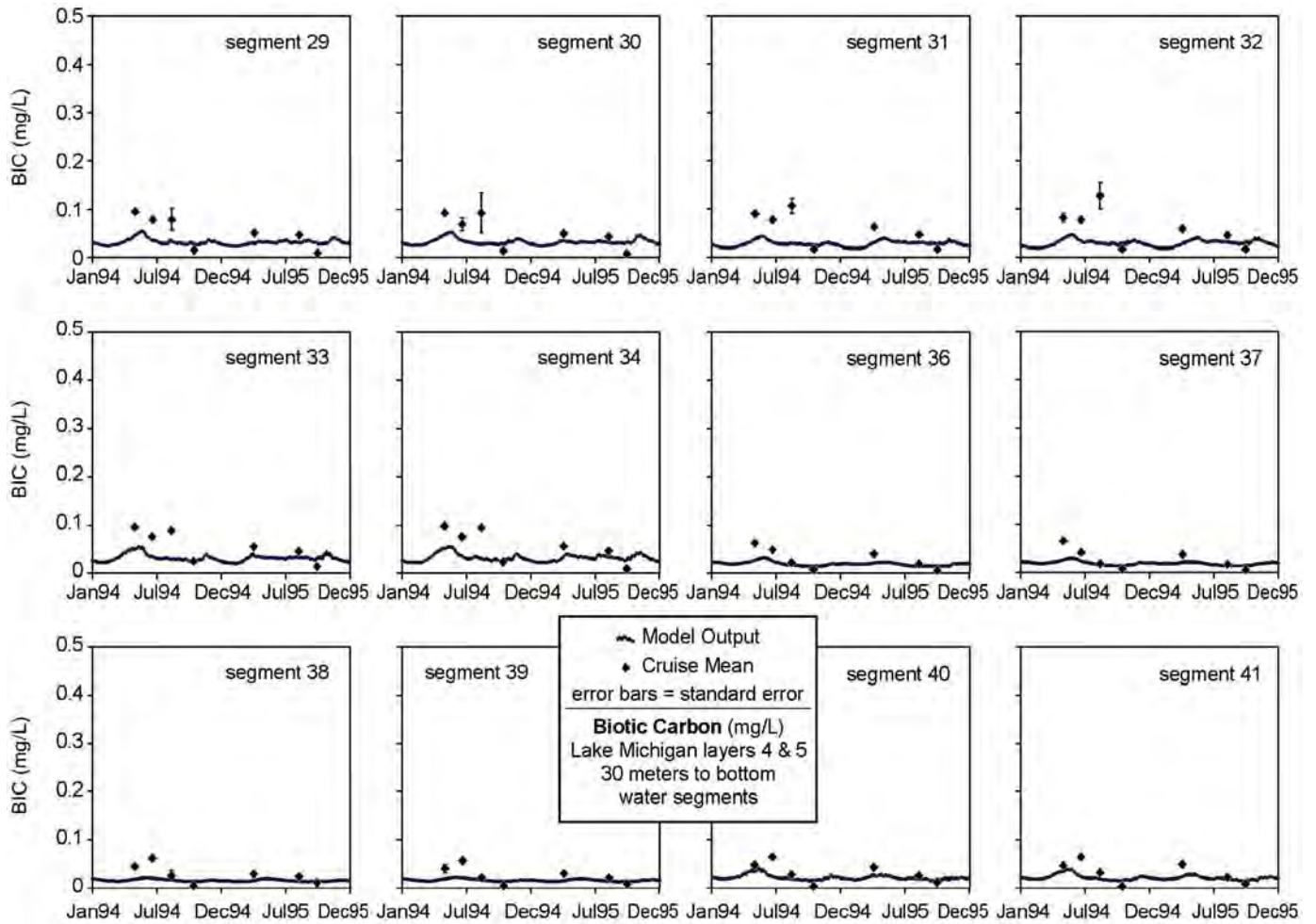

Figure 4.5.3. Temporal profiles of BIC in the Lake Michigan water column segments for the organic carbon dynamics calibration of the LM2-Toxic and the LMMBP cruise mean data (Continued).

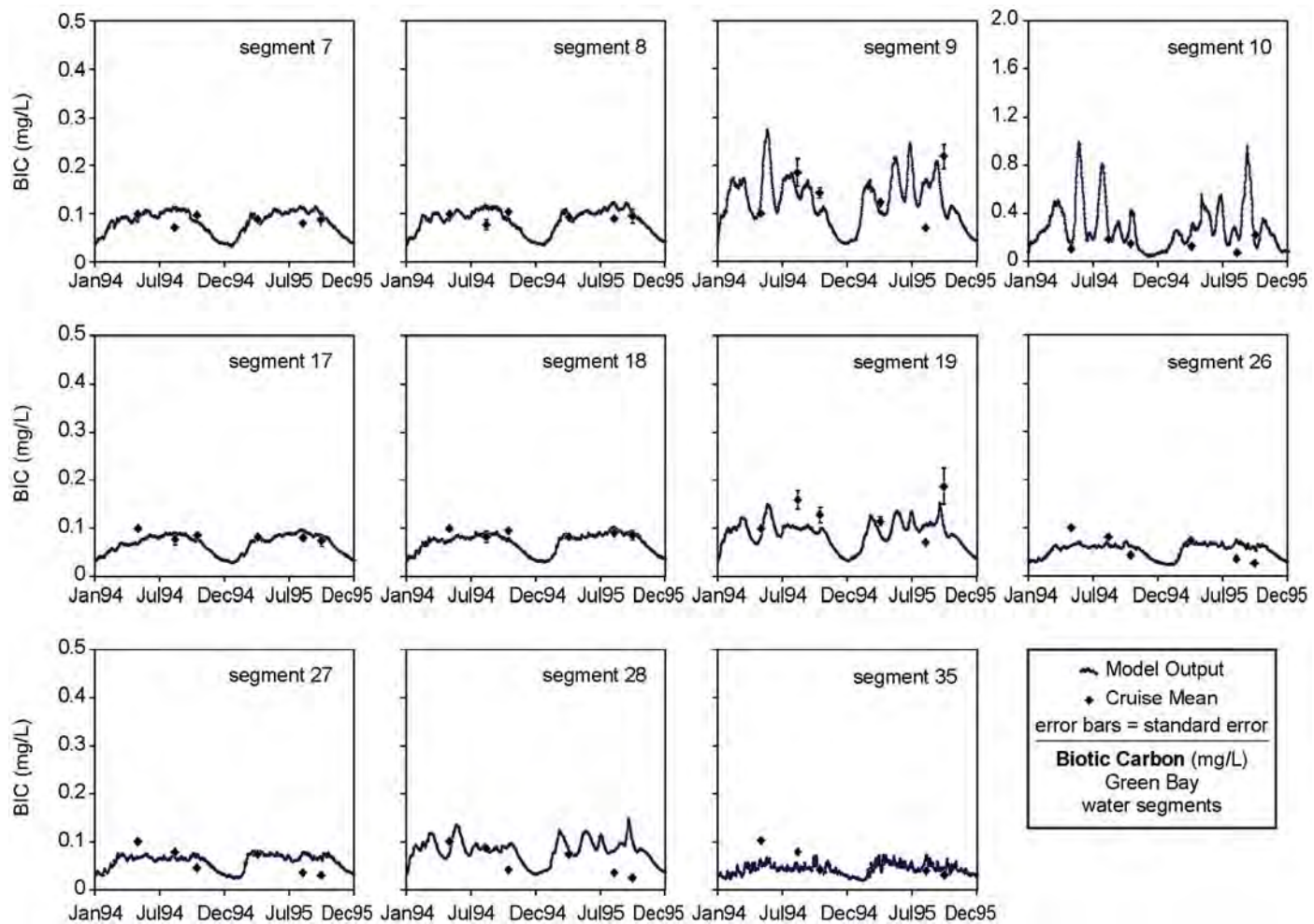

Figure 4.5.3. Temporal profiles of BIC in the Lake Michigan water column segments for the organic carbon dynamics calibration of the LM2-Toxic and the LMMBP cruise mean data (Continued).

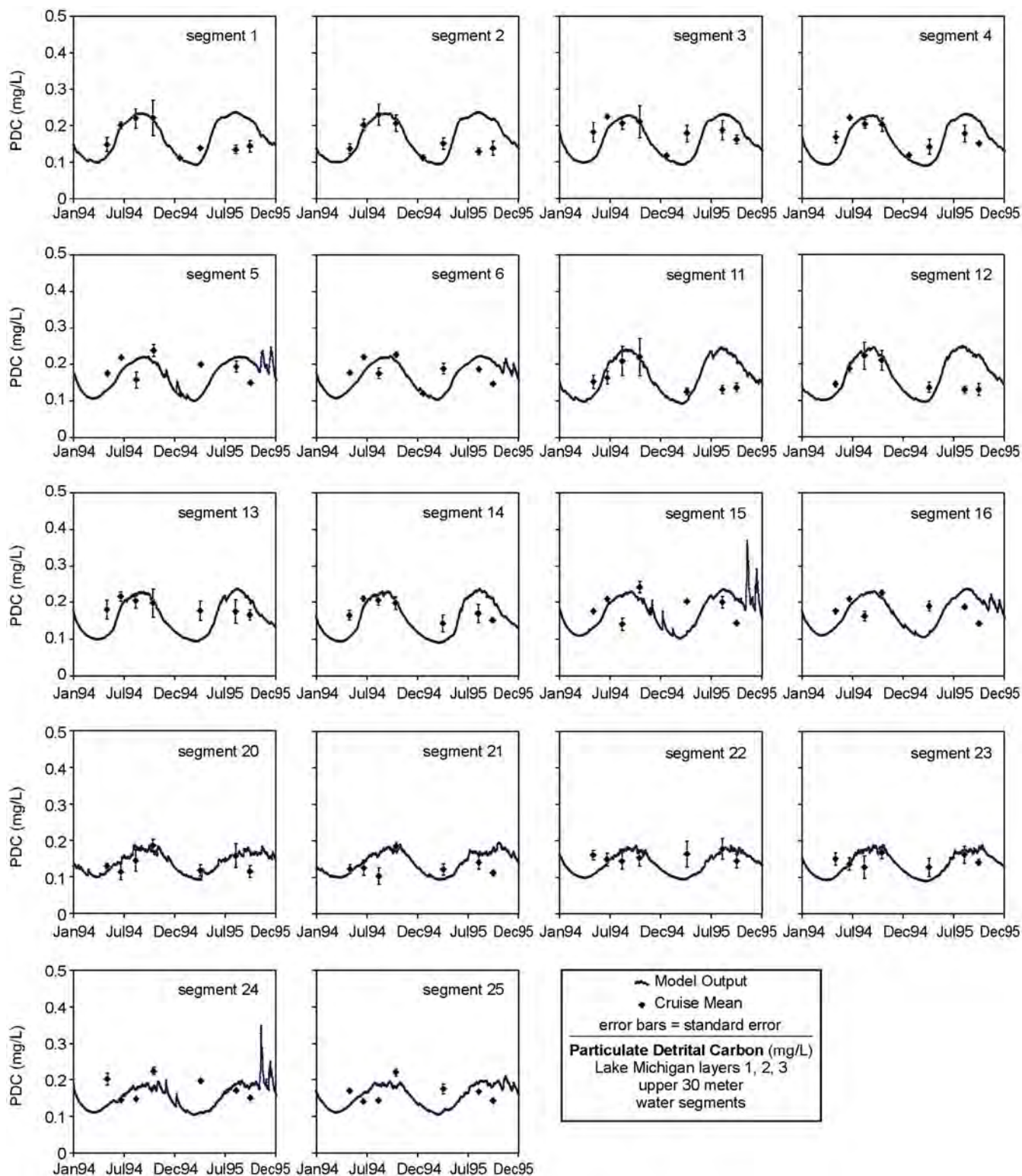

Figure 4.5.4. Temporal profiles of PDC in the Lake Michigan water column segments for the organic carbon dynamics calibration of the LM2-Toxic and the LMMBP cruise mean data.

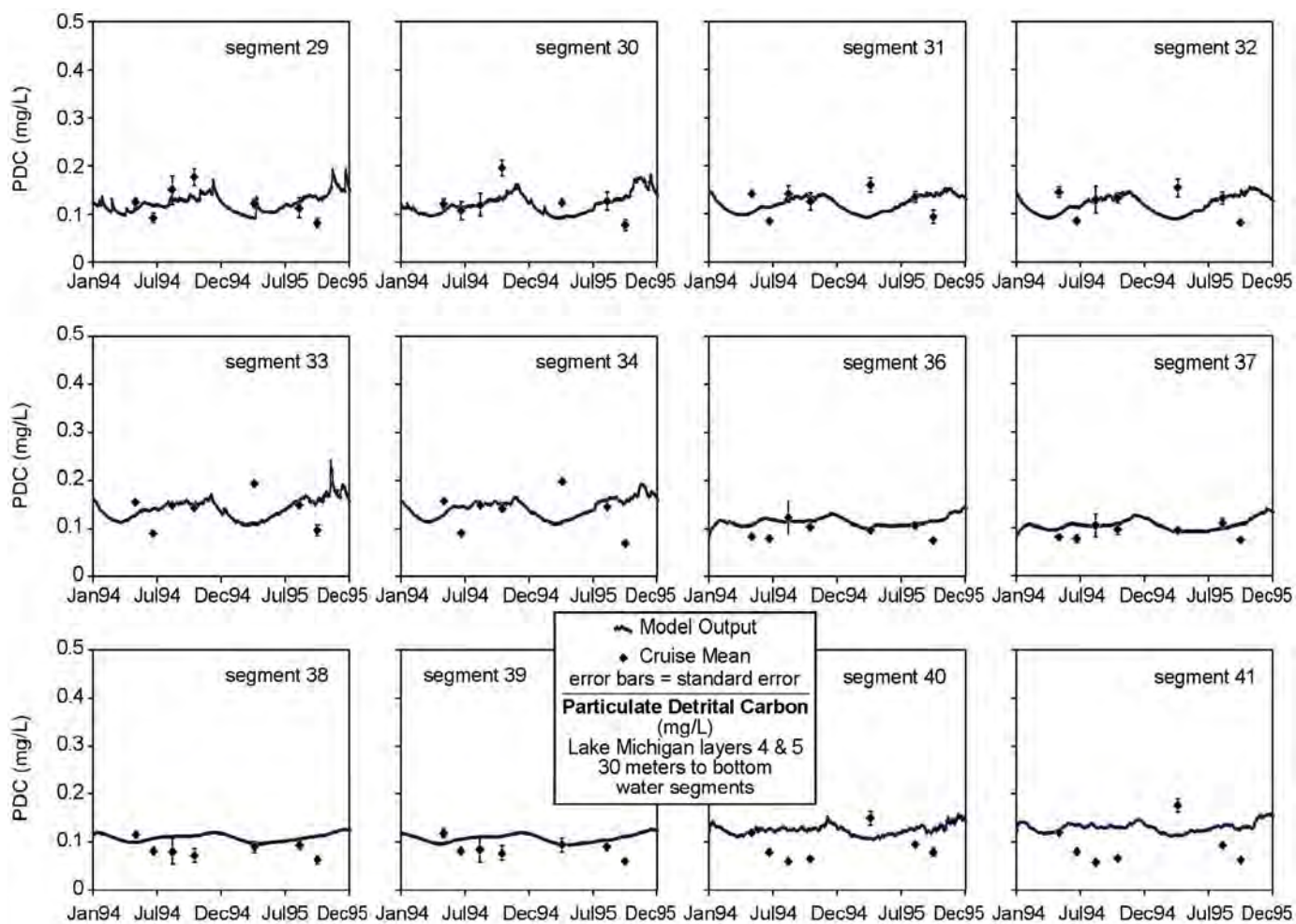

Figure 4.5.4. Temporal profiles of PDC in the Lake Michigan water column segments for the organic carbon dynamics calibration of the LM2-Toxic and the LMMBP cruise mean data (Continued).

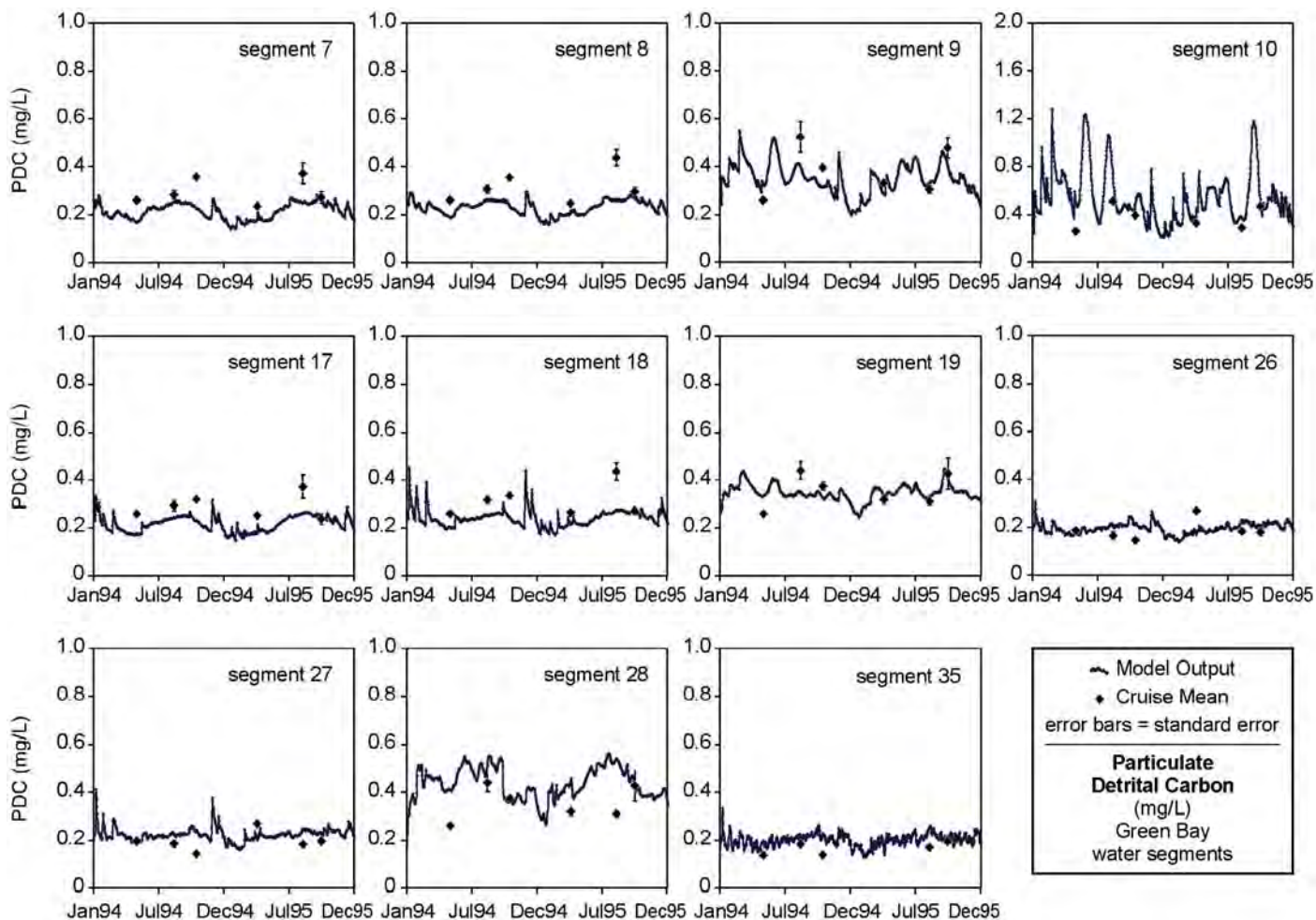

Figure 4.5.4. Temporal profiles of PDC in the Lake Michigan water column segments for the organic carbon dynamics calibration of the LM2-Toxic and the LMMBP cruise mean data (Continued).

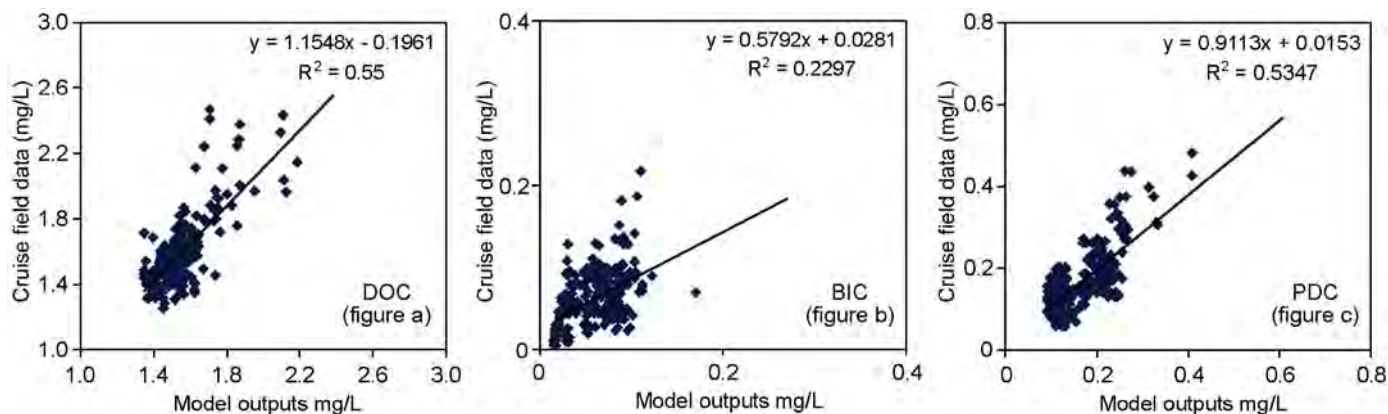

Figure 4.5.5. Observed data versus the LM2-Toxic predictions for DOC, BIC, and PDC for the LMMBP period.

Michigan. Enthalpy in Equation 4.3.24 was one of the volatilization parameters to which the PCB concentrations in the main lake were very sensitive to, and it was slightly adjusted during the PCB dynamics calibration. In addition to adjustments of these two parameters, the initial conditions in some of the Green Bay sediment segments were adjusted for some of the PCB congeners. This was considered acceptable because PCB concentrations initially used in the LM2-Toxic for both the water column and the sediment segments of Green Bay were very questionable. Previous studies (Bierman *et al.*, 1992, DePinto *et al.*, 1993) of the Green Bay system have shown that strong PCB gradients exist in both the water column and the sediments. Small number of samples of that system would not, therefore, be able to capture the details of these gradients. Also, the system is vulnerable to resuspension events that can contribute to high variability in observed PCB concentrations in the water column. The initial PCB concentrations for the Green Bay water column segments were derived from interpolations based on samples from only two water stations (GB17 and GB24M). The initial PCB concentrations for the Green Bay sediment segments were arithmetic averages of samples collected at only four sediment stations (two Ponar sampling locations: SD89P and SD106P; two gravity core sampling locations: 95GI and 113GI) during the LMMBP period.

The segment-specific cruise mean concentrations for each PCB congener were generated using the same inverse distance and volume-weighted averaging algorithm (Appendix 4.4.1) based on the 1994-1995 LMMBP samples collected during the eight cruises. These mean concentrations were then used for the LM2-Toxic PCB dynamics calibration and comparison with the LM2-Toxic outputs.

4.5.3.1 Calibration Procedures

The specific procedures taken in PCB congener dynamics in the lake for the LM2-Toxic were the following:

1. Fixing the PCB diffusion coefficient between the surficial sediment layer and the overlying water column at $1.73 \times 10^{-4} \text{ m}^2/\text{d}$ (DePinto *et al.*, 1993).
2. Assigning estimated initial partition coefficients for each PCB congener computed by using a two-phase partitioning model based on data from the LMMBP collected field samples.
3. Assigning volatilization-related parameters such as enthalpy and entropy of each PCB congener as derived by Bamford *et al.* (2002).
4. Slightly adjusting, within the bounds of literature values and/or acceptable variation in field observations, sediment PCB initial conditions for the Green Bay sediment segments, partition

coefficients, and enthalpy for the PCB congeners as necessary to improve the fit between observed data and model outputs.

4.5.3.2 Results and Discussion

The values for the final set of partition coefficients ($\log K'_{\text{POC},a}$ and $\log K_{\text{DOC}}$ in Table 4.4.28) for the LMMBP selected individual and co-eluting PCB congeners were close to the octanol-water partition coefficient (K_{OW}) calculated by Hawker and Connell (1988). As shown in Figure 4.4.15, the partition coefficients for some of the low and high chlorinated PCB congeners were adjusted the most during the LM2-Toxic PCB calibration. Based on the PCB dynamics calibration procedure outlined in the previous section along with the parameters listed in Tables 4.4.28 and 4.4.29, the PCB congener dynamics in the LM2-Toxic were calibrated for the two-year LMMBP period. Due to the extremely large amount of output from the model on a congener basis, the results and discussion in this section will be focused on only one PCB congener (PCB_{28+31}) and the sum of all the LMMBP modeled PCB congeners (ΣPCBs) for the purpose of demonstrating the calibration outcomes. PCB_{28+31} had the highest external loads, and its concentration in the Lake Michigan system was easily double that of the next closest PCB congener. The mass of ΣPCBs accounted for approximately 70-75% of total PCB mass.

Figures 4.5.6 and 4.5.7 show that temporal calibration profiles of all 41 water column segments for PCB_{28+31} and ΣPCBs (dissolved phase + particulate phase). Appendix 4.5.3 provides a complete set of calibration plots for PCB_{28+31} and ΣPCBs , including temporal profiles in sediments, total dissolved phase (unbound and DOC bound), and particulate phase (sorbed to PDC and BIC).

Although complete sets of calibration plots for each PCB congener are available, it is impossible to put all of them in this report.

Based on cruise mean data and model outputs in Appendix 4.5.3, PCB concentration in the dissolved phase was approximately double its concentration in the particulate phase in the main lake. The temporal profiles (Figures 4.5.6 and 4.5.7) show some degree of temporal variation controlled by a combination of

seasonal variation of external loads, atmospheric concentration, and sediment resuspension events. The separate dissolved and particulate PCB temporal plots (Appendix 4.5.3) also illustrate that the seasonal variation of particulate PCBs was much more prominent than the seasonal variation of dissolved PCBs.

The temporal profiles (Figures 4.5.6 and 4.5.7) indicate that there was a slight longitudinal concentration gradient throughout the main lake. The highest concentrations were found in the southern segments due to higher PCB atmospheric deposition (dry + wet) and much higher PCB atmospheric concentrations observed in the area close to Chicago. There was little vertical gradient found based on main lake cruise mean data. This indicated that vertical transport such as vertical advective flows, vertical mixing, and resuspension strongly influenced the PCB concentrations in Lake Michigan water column. On the other hand, the model output predicted higher concentrations in the bottom layer of the main lake. Possible explanations of this difference between predicted and observed include: 1) segment-specific resuspension rates for the depositional area were not setup properly for the model, 2) the initial average PCB concentrations in surficial sediments were too high, or 3) there should be a bottom layer with a large pool of resuspended materials (benthic nepheloid layer, BNL) containing PCBs added into the model segmentation (Baker *et al.*, 1991; Eadie *et al.*, 1984; Eadie *et al.*, 1990; Eadie, 1997). The BNL, with much higher carbon and PCB concentrations, could serve as a buffer between the hypolimnion layer and the surficial sediment. The LM2-Toxic PCB dynamics calibration was conducted on the PCB congener level. Therefore, the calibration was a tedious and very time-consuming task. The PCB calibration strategy was to adjust only those parameters that definitely needed to be adjusted. The PCB concentrations in the water column, especially the hypolimnion, were very sensitive to the PCB initial conditions in the sediments. Sediment samples collected by box coring may be biased on the high side due to the selection of sites that could be cored (fine-grained sediment). In the deep depositional areas of the lake, it is unlikely that resuspension occurs. To avoid controversy and excessive effort on the model calibration, the segment-specific resuspension rates were not adjusted independently during the

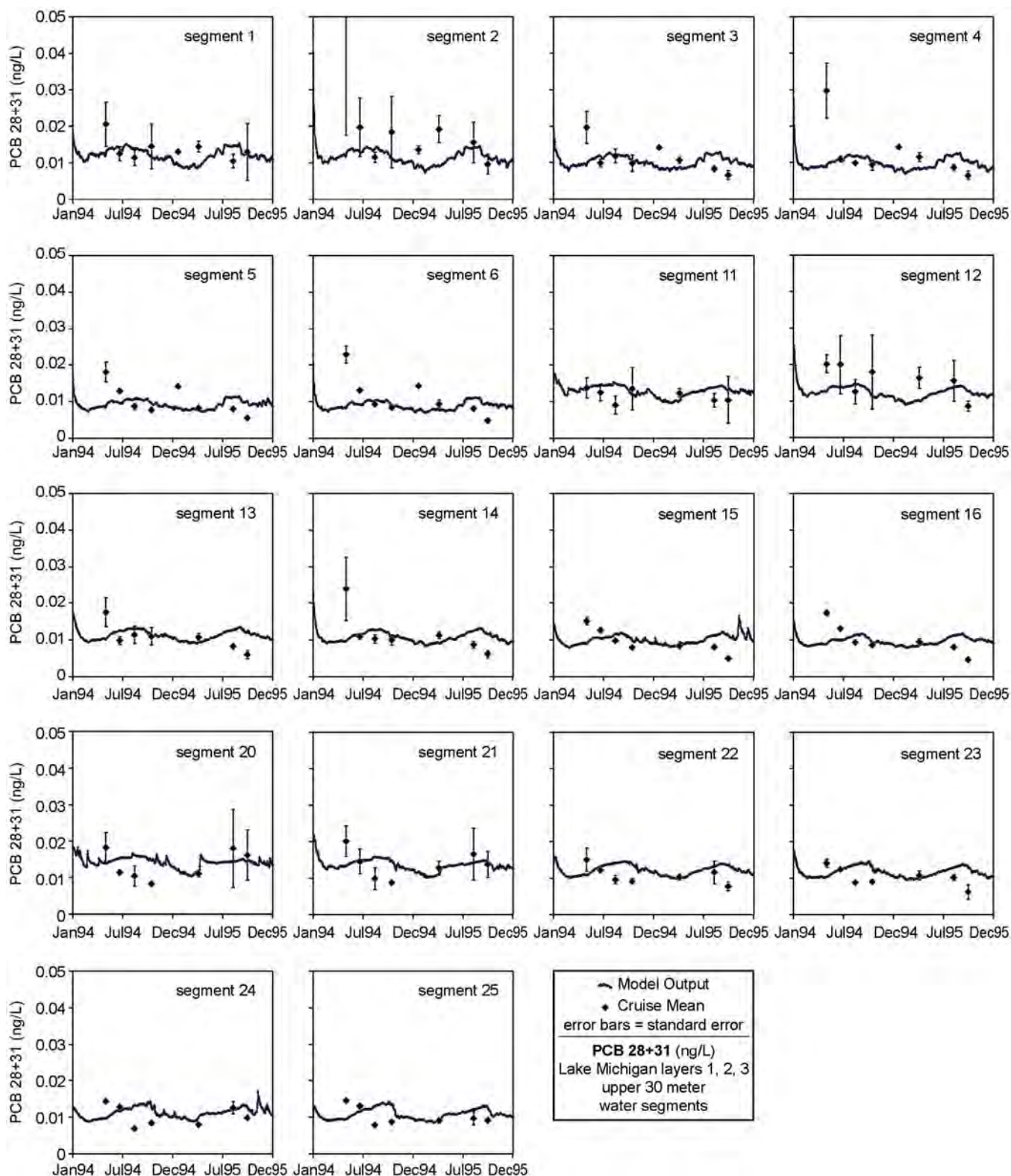

Figure 4.5.6. Temporal profiles of PCB₂₈₊₃₁ (dissolved phase + particulate phase) in Lake Michigan water column segments for PCB dynamics calibration of the LM2-Toxic and the LMMBP cruise mean data.

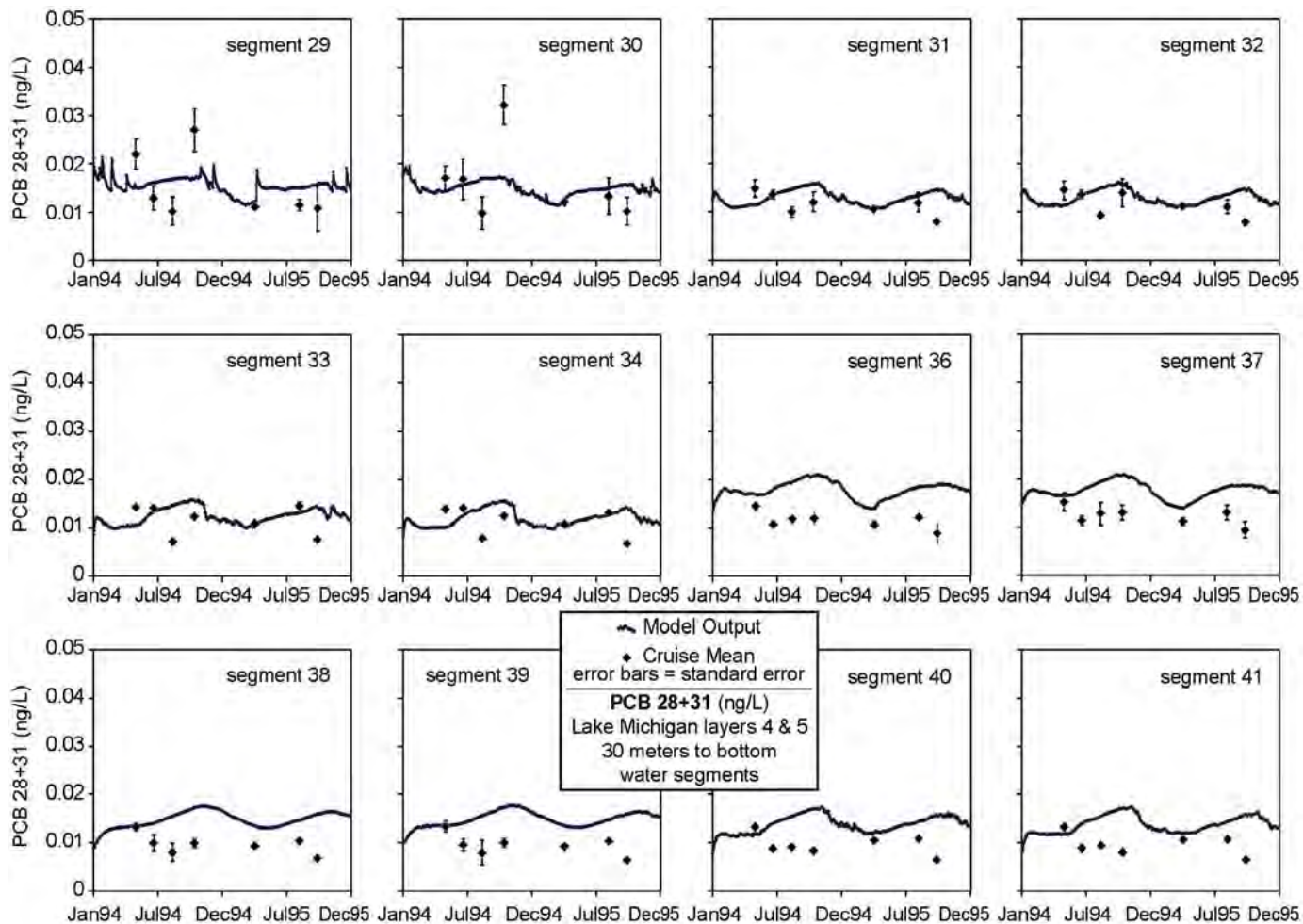

Figure 4.5.6. Temporal profiles of PCB₂₈₊₃₁ (dissolved phase + particulate phase) in Lake Michigan water column segments for PCB dynamics calibration of the LM2-Toxic and the LMMBP cruise mean data (Continued).

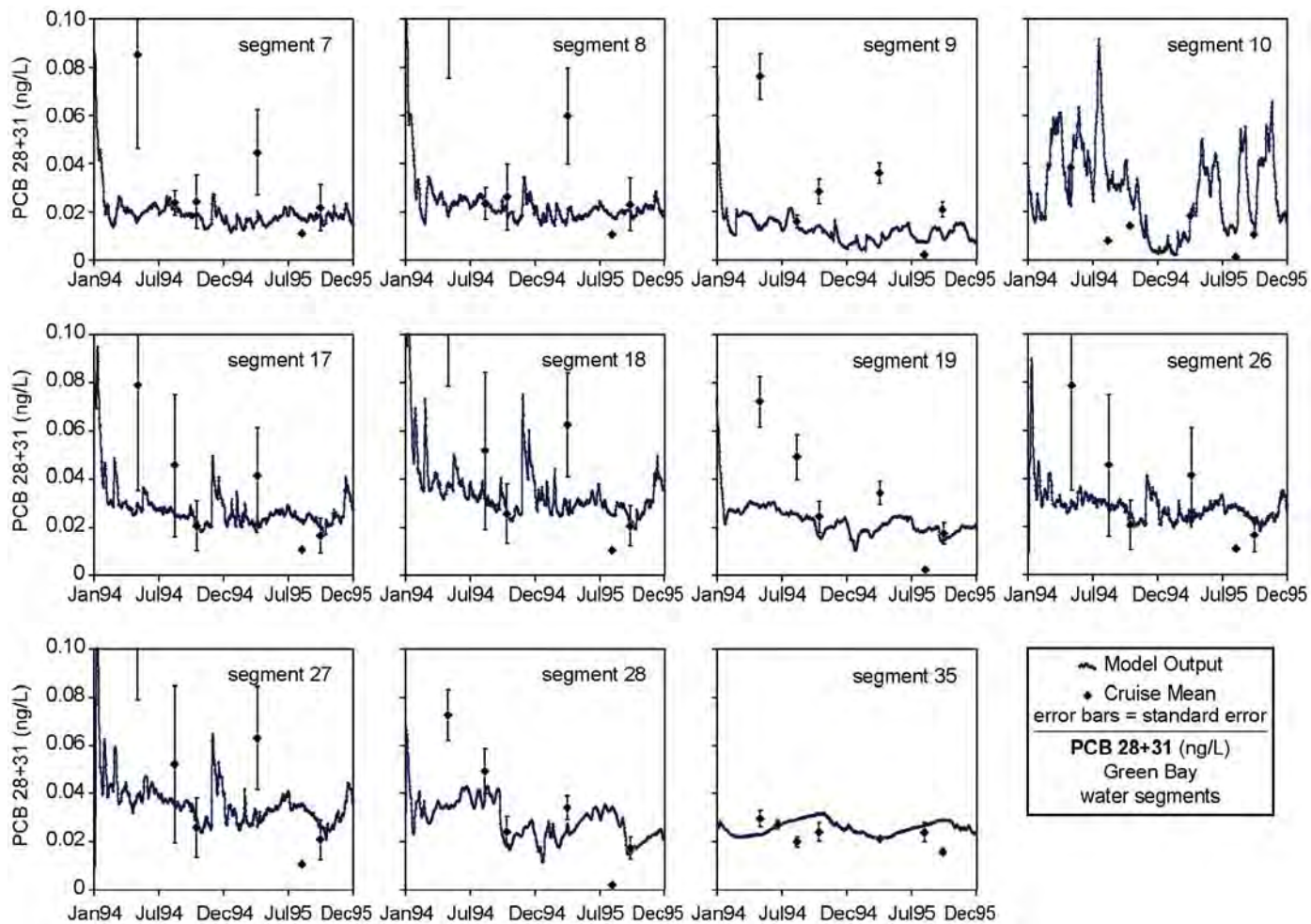

Figure 4.5.6. Temporal profiles of PCB₂₈₊₃₁ (dissolved phase + particulate phase) in Lake Michigan water column segments for PCB dynamics calibration of the LM2-Toxic and the LMMPB cruise mean data (Continued).

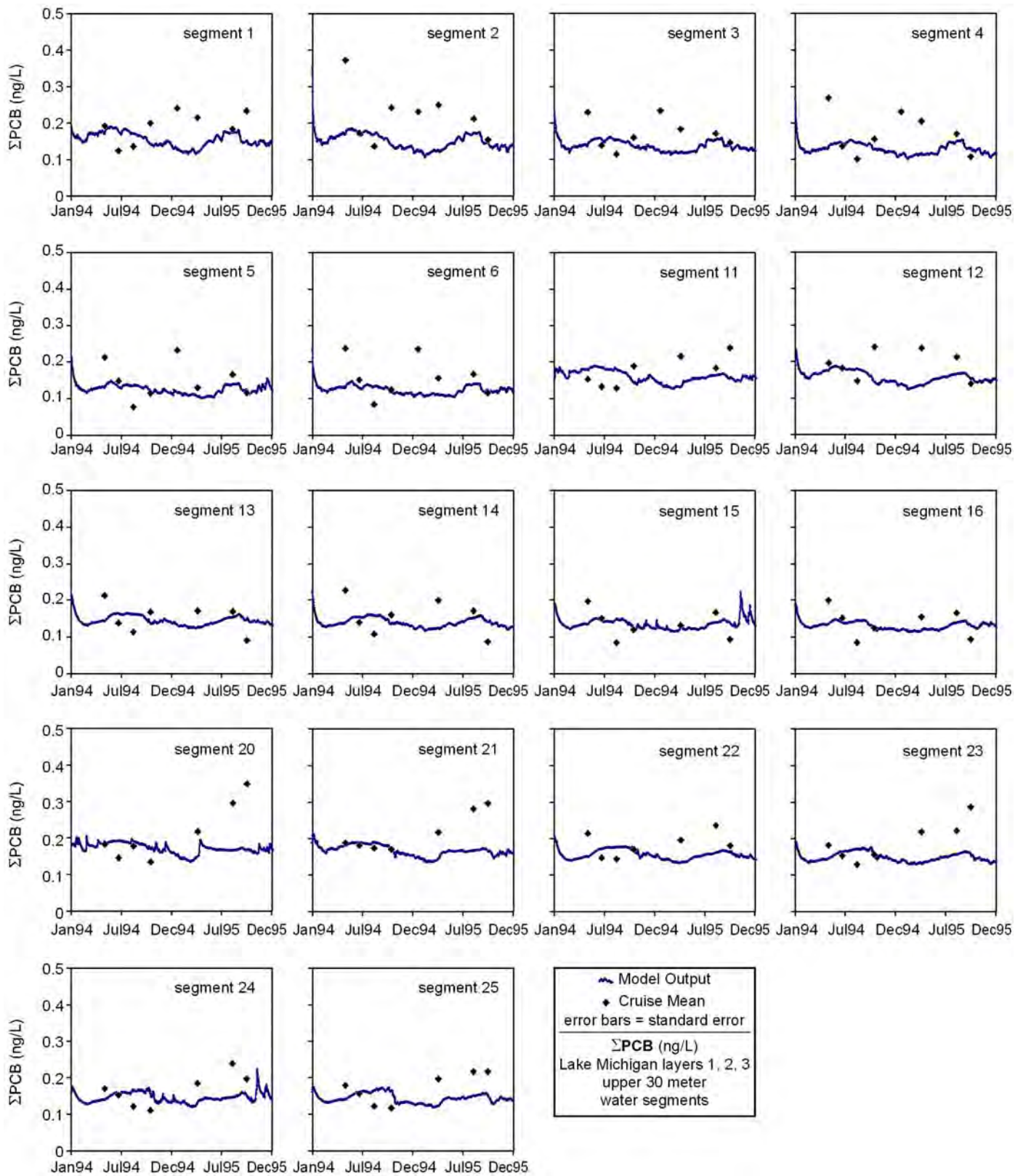

Figure 4.5.7. Temporal profiles of Σ PCBs (dissolved phase + particulate phase) in Lake Michigan water column segments for PCB dynamics calibration of the LM2-Toxic and the LMMBP cruise mean data.

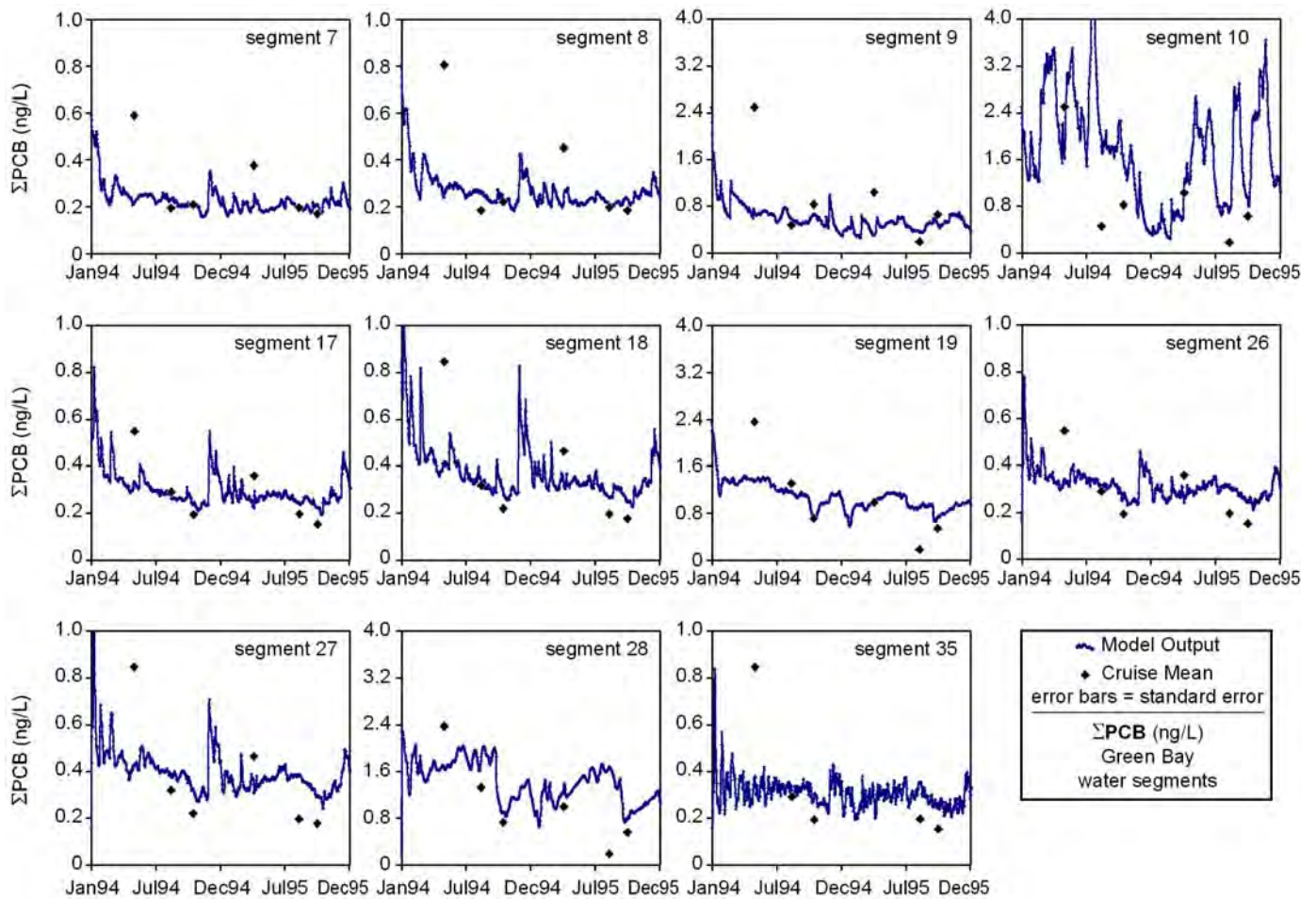

Figure 4.5.7. Temporal profiles of ΣPCBs (dissolved phase + particulate phase) in Lake Michigan water column segments for PCB dynamics calibration of the LM2-Toxic and the LMMBP cruise mean data (Continued).

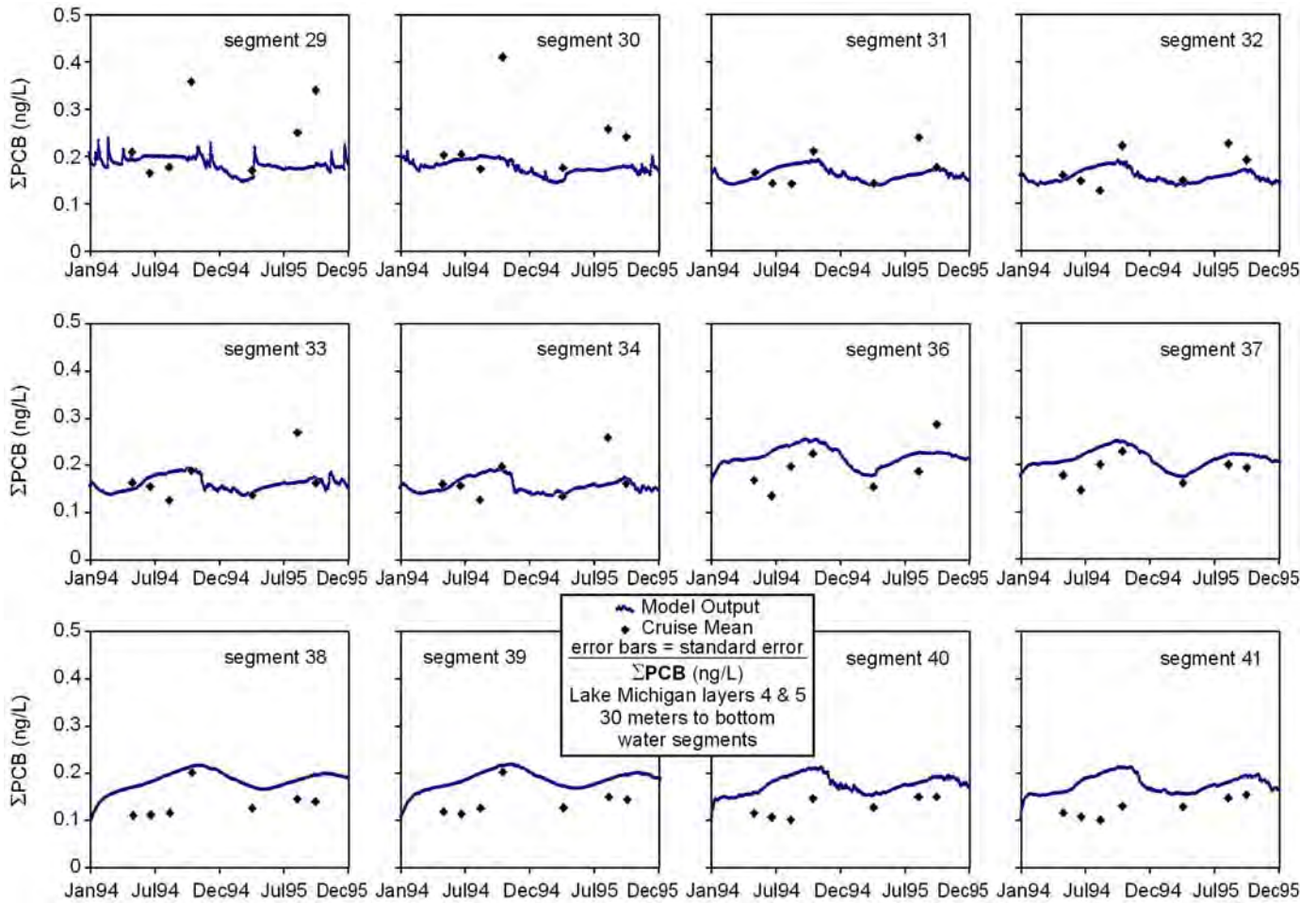

Figure 4.5.7. Temporal profiles of ΣPCBs (dissolved phase + particulate phase) in Lake Michigan water column segments for PCB dynamics calibration of the LM2-Toxic and the LMMBP cruise mean data (Continued).

calibration, and the PCB initial sediment concentrations in the main lake were kept as the original results of the interpolation based on surficial sediment field data.

Temporal variations of PCBs in Green Bay were much different from those in the main lake. PCB concentrations in Green Bay were dominated by the particulate phase (Appendix 4.5.3), especially for the water column segments in the inner bay. Dissolved PCBs were about 1.5 to 2.0 times higher than the particulate PCBs for the water column segments in the main lake. From visual examination of the temporal profiles (Figures 4.5.6 and 4.5.7), calibration results for Green Bay segments were better than those for the main lake. This was unexpected because observational data for the Green Bay water segments were based on only two water stations (GB17 and GB24M). The PCB concentrations in Green Bay were about 5 to 10

times higher than that in the main lake. It appears that it was much easier for a water quality model to simulate and get a good fit with observed data for a chemical constituent with a much higher concentration than for cases when the concentration was close to the detection limit.

The distribution of PCBs between dissolved and particulate phases during the PCB calibration was very sensitive to the adjustment of the POC partition coefficients ($K_{POC,\alpha}$). This distribution was not sensitive to the DOC partition coefficient due to its value being two orders of magnitude lower, even though the DOC concentration was about 5 to 10 times higher than the POC concentration in the main lake. Figures 4.5.8a and 4.5.8b show a comparison between the cruise mean concentrations and model simulation results for PCB_{28+31} and $\Sigma PCBs$ for the calibration period. The plots illustrate that there was

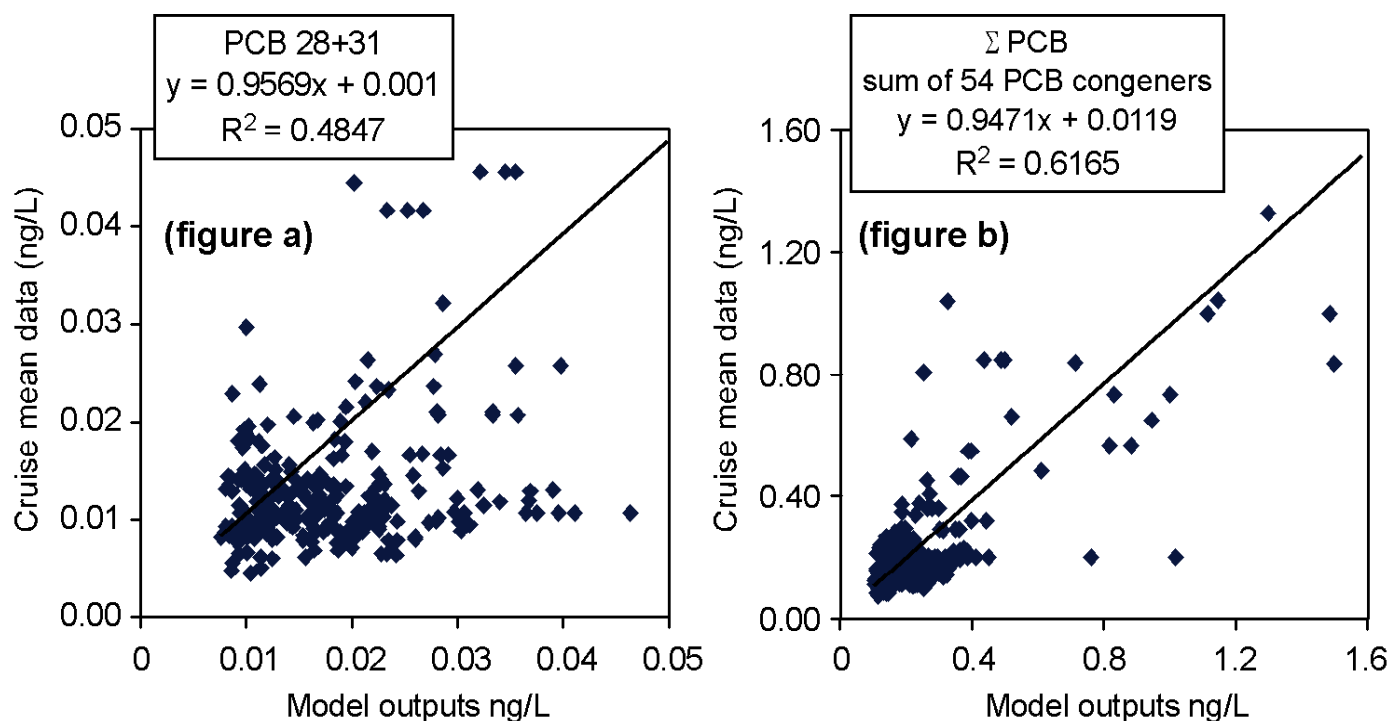

Figure 4.5.8. Observed data versus the LM2-Toxic predictions for PCB_{28+31} and ΣPCB for the LMMBP period.

a good correspondence between model simulation results and cruise mean data. Most of the overpredictions were for segments in the bottom layer of the main lake.

Table 4.5.1 presents the coefficients (slope, intercept, and R squares) of the regression equations based on the results of a comparison between cruise mean concentration and the LM2-Toxic simulated concentration for all the LMMBP selected PCB congeners. In general, the results from the regression for the PCB congeners were reasonably good. The results would be much better if the original initial conditions in the Lake Michigan sediment segments for the PCB congeners were slightly adjusted (initial conditions were adjusted down to maximum of 20%). The calibration strategy was to devote only limited effort to fine-tune the calibration and to adjust as few parameters as possible during the calibration.

4.5.4 The LM-2 Toxic Confirmation

As for any mass balance model, the results of the LM2-Toxic calibration and the outcomes of long-term model prediction have some degree of uncertainty. As the framework of a water quality model becomes more complex, the credibility of the model does not necessarily increase. When the model complexity increases, the dimensions of the associated uncertainties will increase, and the ability to describe model performance will also become increasingly difficult. Other than the uncertainties associated with the numerical algorithms and equations used to describe physical and biochemical processes in the model, data entered into the model are subject to a certain error, and this error propagates into the model results. Due to time constraints, qualitative evaluation of the model was the focus for the LM2-Toxic verification. The following modeling effort was made for the LM2-Toxic confirmation in order to reduce uncertainties associated with water transport, settling and resuspension, and sedimentation. These processes are crucial to long-term projections using any water quality model.

4.5.4.1 Mass Balance Checking

It is important to check the mass balance on an individual segment basis for a state variable simulated in a model. This can ensure that there is

no excessive mass increase or decrease in a segment due to programming error(s) and error(s) associated with the numerical method used in the model. The task was completed very successfully. Three organic carbon solids (BIC, PDC, and DOC) and a conservative tracer (any assumed conservative tracer) were designated as the only state variables. With initial and boundary concentrations of the conservative tracer set equal to 1 mg/L in both the water column and sediment segments and with no external loads, gas exchange, partitioning processes, or any kinetic processes, LM2-Toxic was run for short-term (two years) and long-term (62 years) simulations. The results from the short-term run showed almost no change in all media. For the long-term run, an extremely small change was found in water segments, and a maximum change of 1% was found in a couple of the sediment segments. Table 4.5.2 shows the mass balance checking results for the long-term model run in each segment. Considering the small volumes of surficial sediment segments (average thickness about 1-2 cm), a one percent change in concentrations over 62 years is an acceptable variation in terms of conserving mass.

4.5.4.2 Chloride Model

A chloride model was applied as another confirmation step to ensure that the overall water transport components, including both advection and dispersion, used in the LM2-Toxic were reasonably accurate. With the same model input structure as the temperature balance model, chloride was simulated as a state variable without adjusting any parameter. The resulting temporal profiles in Appendix 4.3.2 confirmed the credibility of the water transport used in LM2-Toxic.

4.5.4.3 ¹³⁷Cs and ^{239,240}Pu Simulation and Results

Based on particle (PDC) net burial in sediments using Pb-210 core dating results (Robbins *et al.*, 1999), a set of settling and resuspension velocities were adjusted simultaneously to maintain the net burial during the LM2-Toxic carbon dynamics calibration. The best-fit values were selected for BIC and PDC. These rates yielded a rate of cycling of particulate matter between the sediments and overlying water. Errors in specifying the settling and resuspension rates can have a significant impact on the model calibrations and the resulting long-term predictions.

Table 4.5.1. Results of the Regression Between the LM2-Toxic Calibration Results and the Cruise Mean Data for the LMMBP Selected PCB Congeners

Congener	Slope	Intercept	R ²
PCB8+5	0.9512	0.0022	0.1845
PCB15+17	0.6072	0.0034	0.3995
PCB16+32	0.9255	0.0122	0.0628
PCB18	0.6271	0.0023	0.4112
PCB26	0.5238	0.0009	0.4188
PCB28+31	0.9569	0.001	0.4847
PCB33	0.4931	0.0054	0.2811
PCB37+42	0.7625	0.0041	0.3332
PCB44	0.8514	0.0012	0.5210
PCB49	1.1693	0.0006	0.3165
PCB52	0.8729	0.0042	0.4145
PCB56+60	0.5822	0.0008	0.5976
PCB66	0.8250	- 0.002	0.5896
PCB70+76	0.7159	- 5E-05	0.5146
PCB74	0.6659	0.0008	0.5769
PCB77+110	0.5593	0.0018	0.4219
PCB81	0.4079	0.0013	0.0160
PCB87	0.5492	0.0020	0.4007
PCB92+84	0.4801	0.0087	0.1896
PCB89	0.0825	0.0012	0.0029
PCB99	0.3746	0.0055	0.1153
PCB101	0.8253	0.0006	0.4186
PCB118	0.4403	0.0020	0.4540
PCB123+149	0.5762	0.0011	0.4723
PCB105+132+153	0.7421	0.0002	0.6205
PCB151	0.4629	9E-05	0.5125
PCB163+138	0.5649	0.0028	0.4258
PCB170+190	0.5879	4E-05	0.3735
PCB172+197	0.3501	0.0001	0.2309
PCB180	0.4372	8E-05	0.3545
PCB187+182	0.7757	0.0012	0.2425
PCB195+208	0.1696	9E-05	0.4053
PCB196+203	0.2402	0.0007	0.1035
PCB201	0.0911	0.0046	0.0004
PCB85	0.5099	0.0006	0.5194
PCB146	0.3329	0.0013	0.2261
ΣPCBs ^a	0.9471	0.0119	0.6165

^aSum of all the LMMBP selected PCB congeners.

Table 4.5.2. Results of the LM2-Toxic Mass Balance Checking for a 62-Year Simulation of an Assumed Conservative Tracer (Set the Model Initial Conditions and Boundary Concentrations of the Conservative Trace = 1)

Water Column Segment	Initial Concentration (mg/L)	Concentration at the End of Simulation (mg/L)	Change (%)
1	1.00000	1.00003	0.003
2	1.00000	1.00003	0.003
3	1.00000	1.00002	0.002
4	1.00000	1.00002	0.002
5	1.00000	1.00002	0.002
6	1.00000	1.00002	0.002
7	1.00000	1.00002	0.002
8	1.00000	1.00003	0.003
9	1.00000	1.00004	0.004
10	1.00000	1.00007	0.007
11	1.00000	1.00003	0.003
12	1.00000	1.00003	0.003
13	1.00000	1.00001	0.001
14	1.00000	1.00002	0.002
15	1.00000	1.00002	0.002
16	1.00000	1.00002	0.002
17	1.00000	1.00002	0.002
18	1.00000	1.00004	0.004
19	1.00000	1.00001	0.001
20	1.00000	1.00003	0.003
21	1.00000	1.00003	0.003
22	1.00000	1.00001	0.001
23	1.00000	1.00001	0.001
24	1.00000	1.00002	0.002
25	1.00000	1.00002	0.002
26	1.00000	1.00002	0.002
27	1.00000	1.00002	0.002
28	1.00000	1.99999	-0.001
29	1.00000	1.00003	0.003
30	1.00000	1.00003	0.003
31	1.00000	1.00001	0.001
32	1.00000	1.00001	0.001
33	1.00000	1.00001	0.001
34	1.00000	1.00002	0.002
35	1.00000	1.00001	0.001
36	1.00000	1.00002	0.002
37	1.00000	1.00002	0.002
38	1.00000	1.00000	0.000
39	1.00000	1.00000	0.000
40	1.00000	1.00001	0.001
41	1.00000	1.00001	0.001
42	0.99959	0.99616	-0.343

Table 4.5.2. Results of the LM2-Toxic Mass Balance Checking for a 62-Year Simulation of an Assumed Conservative Tracer (Set the Model Initial Conditions and Boundary Concentrations of the Conservative Trace = 1) (Continued)

Water Column Segment	Initial Concentration (mg/L)	Concentration at the End of Simulation (mg/L)	Change (%)
43	0.99955	0.99496	-0.459
44	0.99944	0.99362	-0.582
45	0.99947	0.99387	-0.560
46	0.99939	0.99064	-0.876
47	0.99958	0.99103	-0.856
48	0.99965	0.98954	-1.011
49	0.99980	0.99263	-0.717
50	0.99979	0.99258	-0.721
51	0.99964	0.99187	-0.778
52	0.99953	0.99359	-0.594
53	0.99963	0.99585	-0.379
54	0.99958	0.99525	-0.433
55	0.99971	0.99772	-0.200
56	0.99979	0.99737	-0.242
57	0.99963	0.99603	-0.361
58	0.99955	0.99330	-0.626
59	0.99962	0.99160	-0.802
60	0.99977	0.99252	-0.725
61	0.99974	0.99215	-0.759
62	0.99979	0.99245	-0.734
63	0.99969	0.99430	-0.539
64	0.99960	0.99566	-0.394
65	0.99922	0.99102	-0.820
66	0.99926	0.99158	-0.768
67	0.99938	0.99318	-0.621
68	0.99950	0.99447	-0.504
69	0.99952	0.99442	-0.511
70	0.99977	0.99356	-0.621
71	0.99980	0.99317	-0.664
72	0.99963	0.99561	-0.402
73	0.99967	0.99563	-0.404
74	0.99964	0.99566	-0.398
75	0.99972	0.99711	-0.261
76	0.99970	0.99688	-0.282
77	0.99943	0.99359	-0.585
78	0.99980	0.99163	-0.817
79	0.99981	0.99284	-0.697
80	0.99982	0.99136	-0.846
81	0.99980	0.99035	-0.945
82	0.99982	0.99137	-0.845
83	0.99982	0.99134	-0.849
84	0.99982	0.99112	-0.870

Table 4.5.2. Results of the LM2-Toxic Mass Balance Checking for a 62-Year Simulation of an Assumed Conservative Tracer (Set the Model Initial Conditions and Boundary Concentrations of the Conservative Trace = 1) (Continued)

Water Column Segment	Initial Concentration (mg/L)	Concentration at the End of Simulation (mg/L)	Change (%)
85	0.99979	0.99032	-0.947
86	0.99979	0.99072	-0.907
87	0.99981	0.99184	-0.798
88	0.99983	0.99389	-0.595
89	0.99983	0.99146	-0.837
90	0.99980	0.98917	-1.063
91	0.99982	0.99063	-0.920
92	0.99979	0.99097	-0.883
93	0.99982	0.99202	-0.780
94	0.99982	0.99233	0.749

To confirm the settling and resuspension rates selected for the LM2-Toxic, a radionuclide model was developed. The radionuclides, ^{137}Cs and $^{239-240}\text{Pu}$, were used as state variables in the LM2-Toxic, and a 46-year hindcast (1950-1995) simulation was executed. Figure 4.5.9 presents cesium and plutonium lake-wide water column concentrations resulting from the radionuclide model 46-year hindcast simulation. The profiles of both ^{137}Cs and $^{239,240}\text{Pu}$ indicate that the water column concentration of the radionuclides decreased at a rate faster than the one suggested by the data. There are quite a few factors that can contribute to this discrepancy. Among them, loading history of total suspended solids, internal primary production history, partitioning coefficients, coarse segmentation, and the settling and resuspension rates could have a strong influence in the level of ^{137}Cs and $^{239,240}\text{Pu}$ concentration in the water column of the lake.

To determine the representativeness of the rate of sediment-water solids cycling used in the LM2-Toxic, the total sediment ^{137}Cs predicted and observed inventories were compared. There was a very good agreement in total sediment ^{137}Cs inventory for those sediment segments where the sediment core samples were collected (Figure 4.5.10). There was a large discrepancy in the comparison for segment 52. The model underestimated total sediment ^{137}Cs inventory in that segment. This underestimation may

be caused by the location of segment 52. It is a very narrow transitional area along the southeast shoreline of the lake with a steep slope. The LM2-Toxic, with a very coarse spatial resolution for the water column, was unable to predict the radionuclide sediment inventory in such a narrow transitional band. In general, the results from the LM2 ^{137}Cs and $^{239,240}\text{Pu}$ model imply that the combination of the settling, resuspension, and burial rates used in the LM2-Toxic were a reasonable representation of the rate of cycling of particulate matter between the sediments and overlying water column of the lake.

4.5.4.4 Long-Term Organic Carbon Simulations

For the purpose of providing another dimension of LM2-Toxic confirmation, a 40-year long-term organic carbon simulation was executed to produce the total sediment accumulation over the simulation period. Using the model, total sediment thickness (cm) accumulated over 40 years was calculated. It was converted to sediment accumulation rate (cm/year) by dividing by 40 years and comparing to the measured sediment accumulation rate. The three organic carbons (DOC, BIC, PDC) were the only state variables in the LM2-Toxic for the simulation. The set of sediment accumulation rates at each box core sampling location (Robbins *et al.*, 1999) were interpolated using a natural-neighbor interpolation algorithm (Appendix 4.4.1) to generate segment-

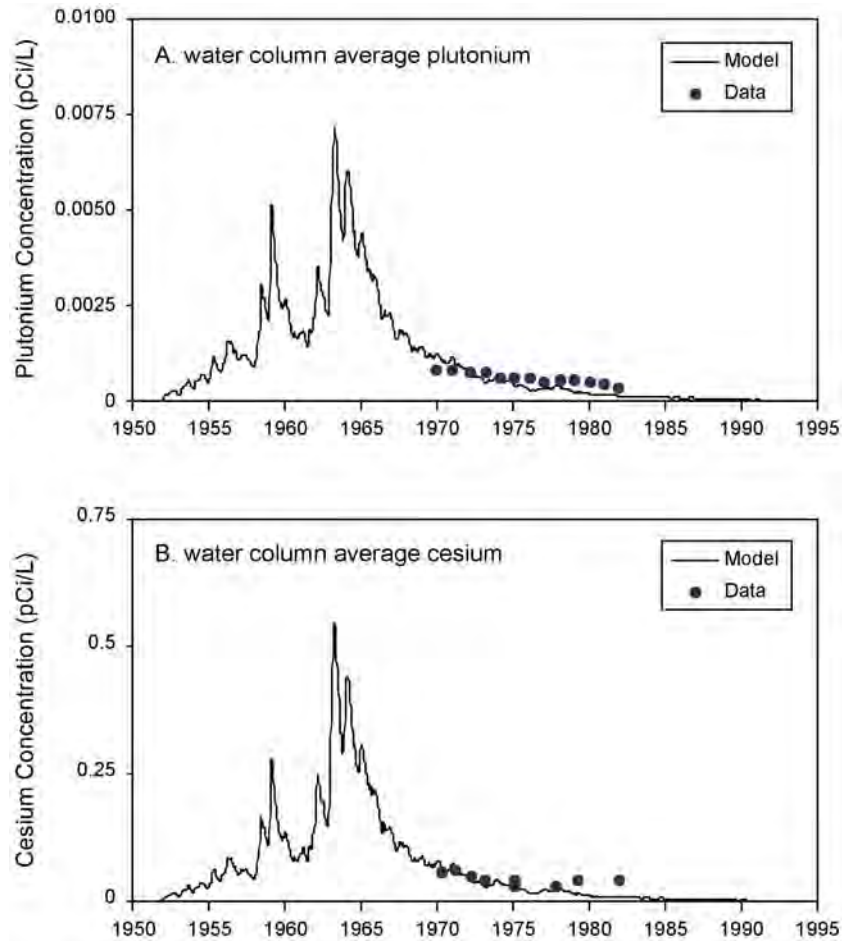

Figure 4.5.9. Lake-wide average concentrations of (a) ^{137}Cs and (b) $^{239,240}\text{Pu}$ computed by the LM2 radionuclide model over 46 years (1950-1995).

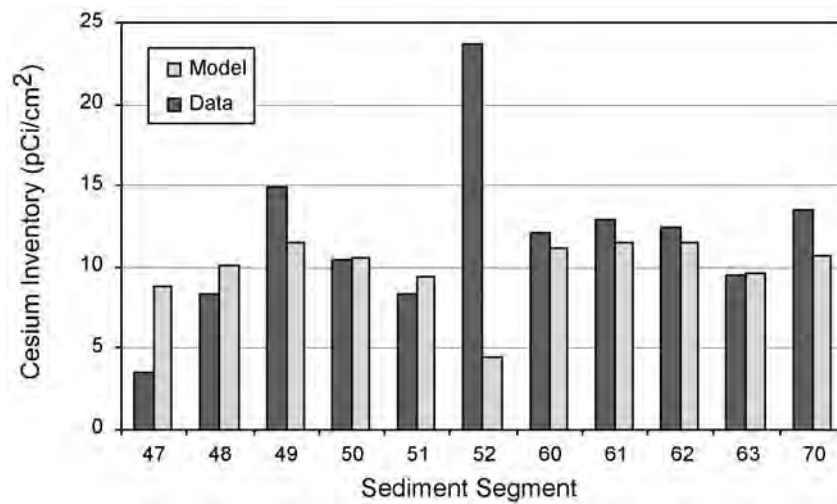

Figure 4.5.10. Sediment ^{137}Cs inventory comparison between the observed data (see Appendix 4.8 for details) and the LM2 radionuclide model outputs.

specific accumulation rates (cm/year). Table 4.5.3 presents comparisons between 1) the segment – specific sediment accumulation rates generated based on the data (Robbins *et al.*, 1999) and the segment-specific accumulation rates computed by the LM2-Toxic and 2) lake-wide average sediment accumulation rates generated from the data (Robbins *et al.*, 1999) and computed by the LM2-Toxic. The discrepancy between the field data and model output on a lake-wide basis was about 30%. A large portion of this difference was contributed by sediment segments under water columns 5 and 6 (segments 65-77) where the bottom geometry is complicated and by Green Bay sediment segments. Because there was only one sediment box core sample collected in the sediment segments under water columns 5 and 6 and no box core sample was taken in Green Bay, the interpolation of the LMMBP-generated accumulation rates could create substantial uncertainty in the interpolated segment-specific accumulation rates for the sediment segments under water columns 5 and 6 and in Green Bay. In general, the results in Table 4.5.3 showed reasonably good match between the field data and model predicted accumulation rates, especially in areas where a large number of box cores were collected.

4.5.4.5 PCB Hindcast

A hindcast used as either a calibration or a confirmation of a mathematical model is considered an important and preferred approach to assess the credibility of a model. It has been used for models such as MICHTOX (Endicott, 2002), LOTOX (DePinto *et al.*, 2003), HUDTOX (U.S. Environmental Protection Agency, 2000), and the Delaware River model (Delaware River Basin Commission, 2003). To gain confidence in the prediction of a toxic chemical model, a PCB hindcast is conducted to confirm the suitability of the processes conceptualized in the model and of the associated parameters used in the model.

A PCB hindcast was not one of the confirmation components proposed in the original LMMBP modeling work plan (U.S. Environmental Protection Agency, 1997). This modeling task was done in response to a suggestion from the 2004 peer review panel (summarized by Rygwelski in Part 7, Appendix 1). Because LM2-Toxic went through a very

thorough and successful short-term (two-year project period) calibration and a series of model confirmation efforts detailed in the previous sections, the main purpose of the LM2-Toxic PCB hindcast simulation was to confirm the representativeness of the calibration parameters determined from the short-term calibration and to check the consistency of the estimated historical PCB load with the available sediment core profiles and historical inventory data. A description of data and procedure used for the LM2-Toxic PCB hindcast and a discussion of the results and findings from the PCB hindcast are presented in the following sections.

4.5.4.5.1 Data and Procedure for the PCB Hindcast

In order to run the LM2-Toxic PCB hindcast, the following data were required: 1) PCB loading history; 2) historical atmospheric vapor phase PCB concentrations; 3) historical primary productivity; 4) the date when PCBs started being loaded into Lake Michigan; 5) physical conditions such as temperature, wind speed, and carbon and PCB transport and kinetic parameters; and 6) the estimated long-term carbon solid concentrations on which the resuspension rates should be adjusted to keep solid cycling rates balanced (see Section 4.3.4.2.1 – Steady-State Resuspension Calibration for details).

The minimum data needed to reasonably assess the performance of the LM2-Toxic PCB hindcast were 1) continuous long-term historical annual averaged water column observed PCB concentrations; 2) sediment PCB core profiles representative of the depositional area, and 3) the sediment total PCB inventory.

Among the data necessary for a successful PCB hindcast and to assess model performance, PCB loading history, historical PCB vapor phase concentrations, and a reliable estimation of sediment inventory are the most critical. PCB loading history and historical PCB vapor phase concentrations control in-flux and out-flux of PCB mass for the Lake Michigan system. Historical concentrations in the system are controlled by these fluxes. When compared to a reliable estimate of sediment PCB inventory, the model generated lake-wide sediment inventory can provide the confidence that there is no

Table 4.5.3. Comparison Between the LMMBP Field-Generated and the LM2-Toxic-Generated Sediment Accumulation Rates (cm/year)

Segment	Field Data^a (cm/year)	Model Output (cm/year)
42	0.0000	0.0000
43	0.0000	0.0000
44	0.0002	0.0000
45	0.0058	0.0000
46	0.0181	0.0650
47	0.0495	0.0900
48	0.1135	0.1250
49	0.3630	0.3875
50	0.2662	0.2900
51	0.1444	0.1900
52	0.2324	0.1800
53	0.0497	0.0000
54	0.0466	0.0250
55	0.0068	0.0000
56	0.0000	0.0000
57	0.0036	0.0000
58	0.0276	0.1300
59	0.1059	0.1900
60	0.2213	0.2800
61	0.2726	0.3250
62	0.2768	0.3100
63	0.1847	0.3200
64	0.1372	0.0250
65	0.0013	0.0000
66	0.0032	0.0000
67	0.0004	0.0000
68	0.0176	0.0000
69	0.0543	0.2750
70	0.1165	0.2400
71	0.1938	0.3000
72	0.0000	0.3000
73	0.0153	0.3575
74	0.0033	0.3250
75	0.0054	0.0000
76	0.0123	0.0000
77	0.0180	0.0000
78	0.0496	0.0000
79	0.0496	0.0000
80	0.0496	0.1000
81	0.0496	0.1000
82	0.0496	0.1000
83	0.0496	0.1000
84	0.0496	0.0000
85	0.0496	0.0000
86	0.0496	0.0000

Table 4.5.3. Comparison Between the LMMBP Field-Generated and the LM2-Toxic-Generated Sediment Accumulation Rates (cm/year) (Continued)

Segment	Field Data ^a (cm/year)	Model Output (cm/year)
87	0.0496	0.0000
88	0.0993	0.0000
89	0.0993	0.0000
90	0.0993	0.6000
91	0.0993	0.4000
92	0.0947	0.3000
93	0.0947	0.4000
94	0.0947	0.4000
Lake-Wide Average	0.1337	0.1742

^aSediment segment-specific accumulation rates computed based on sediment accumulation rates at each sediment box core sampling location estimated by John Robbins (Robbins *et al.*, 1999).

significant overestimation or underestimation by the LM2-Toxic for the total PCB mass in the lake sediments. The major challenge for the PCB hindcast was that these data are very limited for Lake Michigan. The following subsections provide the references for data sources and a brief description of each major data set used in the LM2-Toxic PCB hindcast.

4.5.4.5.1.1 PCB Loading Reconstruction – As is the case for most large water bodies, there is no long-term historical PCB load record available for the lake. Endicott *et al.* (2005) and Endicott (2005) are the only researchers who attempted to reconstruct the long-term PCB loading history of Lake Michigan using an approach similar to that applied to Lake Ontario by Mackay (1988) and Gobas *et al.* (1995). Endicott (2005) conducted three 55-five year total PCB hindcast simulations using MICHTOX and concluded that the results from Scenario B had the best-fit with the available historical PCB data. The year when PCB contamination began was assumed to be 1940. The PCB loading function of Scenario B peaked in 1961 and declined after 1963. The rates of increase in the loads including tributary and atmospheric loads were the same as the rates of decrease. Based on observations of the past 25 years, the rates of increase and decrease were

defined as 0.115/year and 0.0535/year for atmospheric loads and tributary loads, respectively.

In contrast to the procedure of reconstructing the historical PCB total loading function used in the MICHTOX (Endicott, 2005), the historical PCB loading estimation used in the LM2-Toxic PCB hindcast simulations was done by relating it to the results obtained from the analysis of a highly resolved sediment core (LM94-15A) collected during the LMMBP period (Details are in Part 1, Chapter 7 of this report). In doing so, some assumptions and professional judgments were made. One important assumption was that the total PCB inventory and the shape of the total PCB profile obtained from the sediment core represented the PCB loading history from all sources. Consequently, the following key elements that were used in reconstructing a historical PCB loading function were derived based on the core LM94-15A profile: 1) the starting date of the PCB loading time function (January 01, 1949); 2) the year in which the PCB loading function reached its peak which was determined to be 1967; and 3) the slopes on both the inclining and declining sides of the core profile curve were linear. The historical PCB loading time function was then back-projected based on the above elements and variations of the LMMBP estimated loads for 1994 reported by the United

States Geological Survey (USGS) (Hall and Robertson, 1998) for tributary loads and the LMMBP atmospheric working group (McCarty *et al.*, 2004; Miller *et al.*, 2001) for atmospheric loads. Details on the determination of the key elements and the procedure in reconstructing the PCB load history are further discussed in Part 1, Chapter 7. Figure 4.5.11 shows the final reconstructed total PCB historical loading function (January 01, 1949 – December 31, 1995) and the PCB profile from the sediment core (LM94-15A). The monthly variation pattern in the reconstructed long-term historical PCB load functions used in the LM2-Toxic model for each PCB congener followed the same monthly pattern established by the LMMBP estimated loads.

4.5.4.5.1.2 PCB Atmospheric Vapor Phase Concentration Reconstruction – Recent studies (Thomann and Di Toro, 1983; Rodgers *et al.*, 1988; Jeremiason *et al.*, 1994; DePinto *et al.*, 2003; Part 3 of this report; Part 4.6.2 of this report) have shown that the air-water exchange between dissolved PCBs in surface water and overlaying vapor phase PCBs is a very important and possibly the most significant loss/gain process, especially in recent years, for PCBs in the Great Lakes region. The gross volatilization and absorption fluxes transport large amounts of PCB mass in and out of the lakes due to the gradient of PCB concentrations between the air and surface water. These individual fluxes were usually greater than the sum of the external loads (tributary, atmospheric wet and dry deposition). Therefore, a reasonable representation of a reconstructed historical PCB atmospheric vapor phase concentration is critical to the success of the LM2-Toxic PCB hindcast for Lake Michigan. Following a similar approach used in the reconstruction of the loading time function, the starting date of the PCB vapor phase time function was January 01, 1949, the year for which the PCB vapor concentration reached its peak was 1967, and the slope on the inclining side of the time function is the same as the one indicated from the core LM94-15A profile. The only difference is that the vapor concentration on the declining side of the time function was back-projected based on the LMMBP (1994-1995) generated PCB vapor concentration and the decline rate that was carefully selected *via* a thorough review of research studies conducted on PCB vapor phase concentration and the data

collected within the Lake Michigan watershed for the 25 years prior to 1996.

The estimation of the declining rate in the vapor phase PCB concentrations is very subjective to the data set and number of data points used in the derivation of the rate. The half-life of the declining rate published in the literature ranges from 6 to 20 years for PCB vapor phase concentrations over Lake Michigan (Hillery *et al.*, 1997; Schneider *et al.*, 2001; and Buehler *et al.*, 2002, 2004). The individual data sets used by researchers to determine the PCB vapor concentrations declining rate were usually a subset of the historical PCB vapor concentrations measured between 1977 and 2001. Hillery *et al.* (1997) and Schneider *et al.* (2001) calculated a declining rate of six-year half-life based on the measurements collected before 1997, while a rate of half-life as high as 20 years was estimated by Buehler *et al.* (2002, 2004) using only the data from the Integrated Atmospheric Deposition Network (IADN), 1992-2001. In this study, a declining rate of 0.115/year, which corresponds to a six-year half-life, was chosen because the simulation period of the LM2-Toxic PCB hindcast was from 1949 through 1995 and overlapped the post-peak declining period used by Hillery *et al.* (1997) and Schneider *et al.* (2000). Similar to the PCB load reconstruction, the reconstructed PCB vapor phase concentration time function maintains the same monthly pattern observed during the LMMBP period. Figure 4.5.12 shows the reconstructed historical time function of total PCB vapor phase concentrations (January 01, 1949 – December 31, 1995) along with the reconstructed total loading function for Lake Michigan.

4.5.4.5.1.3 Estimation of Historical Primary Productivity – PCBs are hydrophobic organic chemicals and are closely associated with organic carbon in natural water systems. The movement and fate of organic carbon mass are very important to the distribution of PCBs in the Lake Michigan system. Therefore, a historical organic carbon loading function was necessary for a LM2-Toxic PCB hindcast. The carbon solid loads to the lake are primarily from tributaries (external loads) and primary production of phytoplankton (internal load). Both the measurements and outputs from the LM3-Eutro for the two-year project period (1994-1995) indicated that the internally-generated organic carbon load

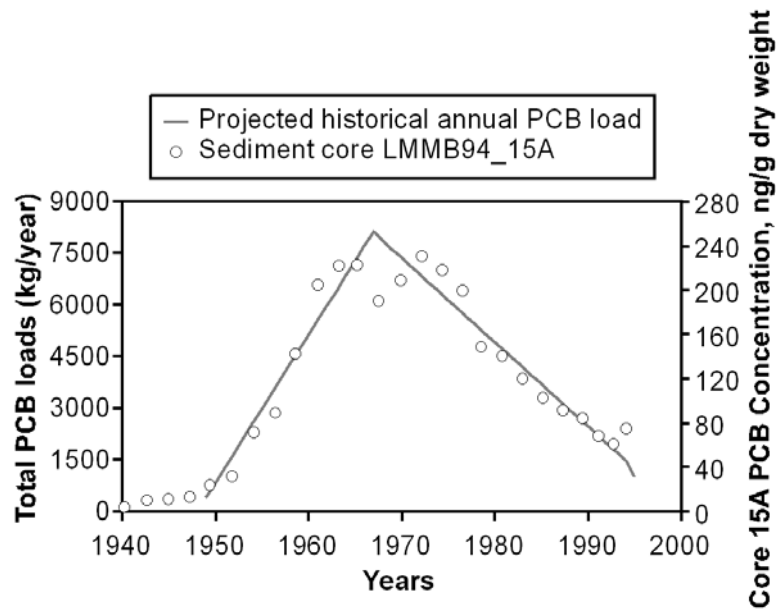

Figure 4.5.11. Reconstructed historical total PCB loading time functions and sediment core LM94-15A total PCB concentration profiles for Lake Michigan. Note: The total PCB loading time function was back-projected based on the estimated PCB load for 1994. The last data point of the load time function represents the estimated PCB load for 1995.

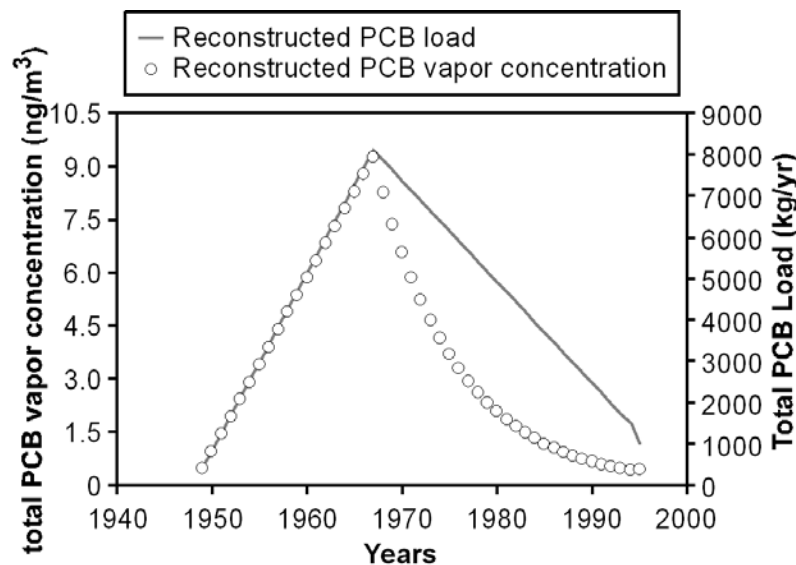

Figure 4.5.12. Reconstructed total PCB vapor phase concentrations and total PCB loading time functions for Lake Michigan. Note: The total PCB loading time function was back-projected based on the estimated PCB load for 1994. The last data point of the load time function represents the estimated PCB load for 1995.

(primary production) accounted for approximately 90% of the total carbon solid loads for Lake Michigan (details are in Part 4, Section 4.4.2). Consequently, it would be an adequate representation of the historical carbon solid loading function if the primary production history for Lake Michigan could be reasonably reconstructed. However, there are too few primary production data for Lake Michigan in the literature to permit creation of an organic carbon loading history. Due to time constraints, a simple relationship was established by correlating primary productivity with available historical total phosphorus loads (Appendix 4.5.5).

By establishing a relationship between total phosphorus loads and primary productivity, an estimation of historical primary productivity was constructed for Lake Michigan using an approach similar to the one by Vollenweider *et al.* (1974). Figure 4.5.5.1 in Appendix 4.5.5 shows the relationship between total phosphorus loads and lake area normalized primary productivity. Figure 4.5.13 presents the reconstructed total carbon solids loading time function used for the LM2-Toxic PCB hindcast simulations.

The reconstructed carbon solids loading history (Figure 4.5.13) indicated that the annual average internal carbon loads for Lake Michigan reached a peak value of approximately 3.5×10^9 kg/year in 1980 and then decreased to the current level (1994-1995) of 2.1×10^9 kg/year used in the LM2-Toxic model. The annual average carbon concentrations were expected to follow the same trend as the historical carbon solids loading function.

4.5.4.5.1.4 Other Physical and Kinetic Parameters – In terms of physical processes, one of the main assumptions made for the LM2-Toxic PCB hindcast was that the time functions for water transport, wind speed, wave heights, and temperature constructed for the two-year LMMBP period were representative of annual average conditions (see Part 1, Chapter 4 for details) that existed in the lake for the entire hindcast simulation period. Values of the kinetic parameters used in the model calibration were kept the same during the hindcast simulation.

Resuspension rate is a function of organic carbon concentration in the water column, assuming the other parameters in Equation 4.3.8 are constant (see

Part 4, Chapter 3 for details). By using the carbon concentration data generated during the LMMBP and the reconstructed carbon solids loading history, the annual average organic carbon concentrations in the water column were estimated (Appendix 4.5.5). The resuspension rates for each year throughout the hindcast simulation period were adjusted with the estimated annual organic carbon concentrations (see Section 4.3.4.2.1 – Steady-State Resuspension Calibration for details). The adjusted resuspension time function maintained the same monthly pattern that was derived from the observations made during the LMMBP period.

4.5.4.5.1.5 Historical Water Column PCB Concentrations and Sediment Core Profiles – Historical PCB concentrations in the water column and sediments are essential data to evaluate the results of a water quality model hindcast simulation. The available Lake Michigan water column data are listed in Table 4.5.4 together with their sources. Measurements made before 1994 LMMBP were taken at a very limited number of locations, within short-time periods and at depths less than 10 m in the water column. Thus they are biased and may not truly represent annual average water column PCB concentrations.

Table 4.5.5 provides the sediment PCB core profiles with depth and temporal information at three LMMBP sediment sampling locations (LM94-015A, LM95-061A, and LM95-086A). Two of the sediment cores (LM95-061A and LM95-086A) were taken within depositional zones as defined in Figure 4.3.2. Core LM94-015A was collected in the transitional zone. Figure 4.5.14 shows the locations of the three sediment cores taken during the LMMBP period. For more details about these three sediment cores, see section Part 1, Chapter 7.

4.5.4.5.1.6 PCB Inventory in Lake Michigan Sediments – An estimate of PCB inventory in the lake sediments is the final information needed to ultimately confirm the outcomes of the LM2-Toxic PCB hindcast and the applicability of the model for future predictions. Table 4.5.6 lists the available PCB sediment inventory data for Lake Michigan. The most recent estimate from Eadie and Van Hoof (see Part 1, Chapter 7 for details) showed that the PCB inventory for the lake is about 60,998 kg.

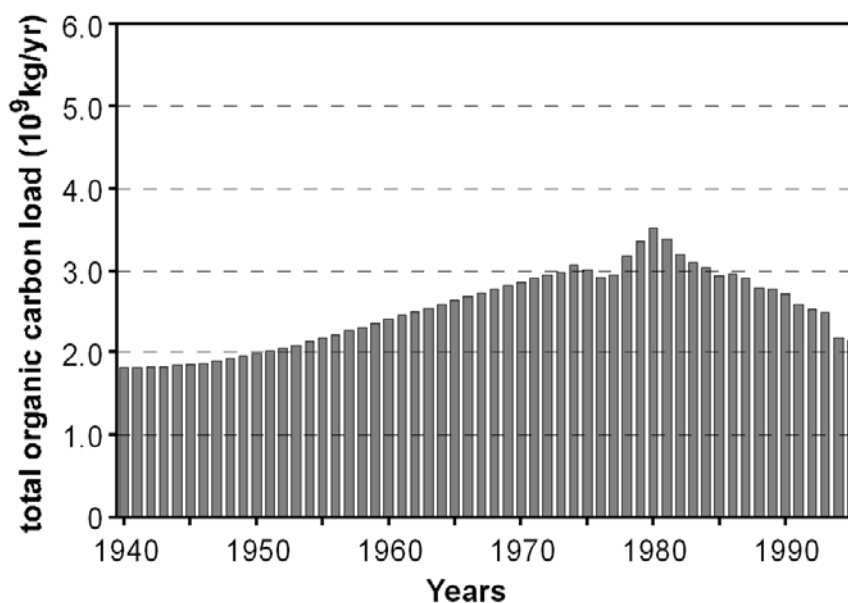

Figure 4.5.13. Reconstructed total organic carbon load (primary production + LMMBP tributary loads) for Lake Michigan.

Table 4.5.4. Available Historical Water Column Total PCB Concentrations for Lake Michigan

Year	Concentration (ng/L)	Standard Error/ Deviation (ng/L)	Depth (m)	Reference
1976	7.2	3.1		Chambers and Eadie, 1980
1979	2.88	3.37	1	Rice <i>et al.</i> , 1982
1980	5.66	1.12	1	Rice <i>et al.</i> , 1982
1980	6.36	1.3	1	Rice <i>et al.</i> , 1982
1980	1.2	0.5	5	Swackhamer and Armstrong, 1987
1981	0.28		1	Filkins <i>et al.</i> , 1983
1986	1.1	0.2		Lefkovitz, 1987
1991	0.64	0.43	8	Pearson, 1996
1992	0.424	0.058		Bicksler, 1996
1993	0.22	0.04	5	Anderson, 1999
1994-1995	0.259	0.172		LMMBP

Table 4.5.5. Sediment PCB Concentration Vertical Profiles Analyzed for Three Sediment Box Cores Taken During the LMMPB

LM94-015A			LM95-061A			LM95-086A		
Interval cm	Total PCBs ng/g Dry	Mid-Interval Date	Interval cm	Total PCBs ng/g Dry	Mid-Interval ng/g Dry	Interval cm	Total PCBs ng/g Dry	Mid-Interval Date
0-1	73.7	1994.16	0-0.5	91.1	1995.37	0-0.5	78.3	1994.90
1-2	60.7	1992.78	0.5-1	111	1994.78	0.5-1	64.6	1993.30
2-3	67.6	1991.16	1-1.5	110	1994.28	1-1.5	66.6	1991.40
3-4	83.7	1989.45	1.5-2	127	1993.89	1.5-2	75.7	1989.30
4-5	91.1	1987.37	2-2.5	117	1993.37	2-2.5	77.2	1987.10
5-6	102	1985.17	2.5-3	120	1992.63	2.5-3	77	1984.60
6-7	119	1983.07	3-3.5	122	1991.90	3-3.5	80.1	1982.00
7-8	140	1980.81	3.5-4	136	1991.12	3.5-4	76.6	1979.00
8-9	148	1978.61	4-5	100	1989.61	4-5	77.7	1974.20
9-10	199	1976.55	5-6	106	1987.43	5-6	102	1968.10
10-11	217	1974.43	6-7	103	1985.08	6-7	101	1961.90
11-12	230	1972.21	7-8	117	1982.53	7-8	97.2	1955.70
12-13	208	1969.91	8-9	119	1979.84	8-9	82	1949.50
13-14	190	1967.54	9-10	117	1977.08	9-10	34.6	1942.00
14-15	222	1965.35	10-11	144	1974.34	10-11	14.5	1933.80
15-16	221	1963.31	11-12	164	1971.69	11-12	7.84	1925.00
16-17	204	1961.05	12-13	159	1968.97	12-13	3.54	1916.50
17-18	142	1958.70	13-14	128	1966.30	13-14	2.61	1908.60
18-19	88.8	1956.47	14-15	86.9	1963.55	14-15	1.51	1900.50
19-20	71	1954.23	15-16	65	1960.58	15-16	0.893	1891.60
20-21	31.4	1951.82	16-17	50.4	1957.68			
21-22	23.5	1949.47	17-18	29.2	1954.65			
22-23	12.5	1947.27	18-19	17.6	1951.57			
23-24	10.5	1945.07	20-22	7.02	—			
24-25	9.52	1942.78	22-24	4.51	—			
25-26	3.58	1940.30	24-26	4.22	—			
26-27	2.19	1937.73	26-28	2.62	—			
27-28	1.37	1934.83	28-30	1.51	—			
28-30	1.62	1930.81						

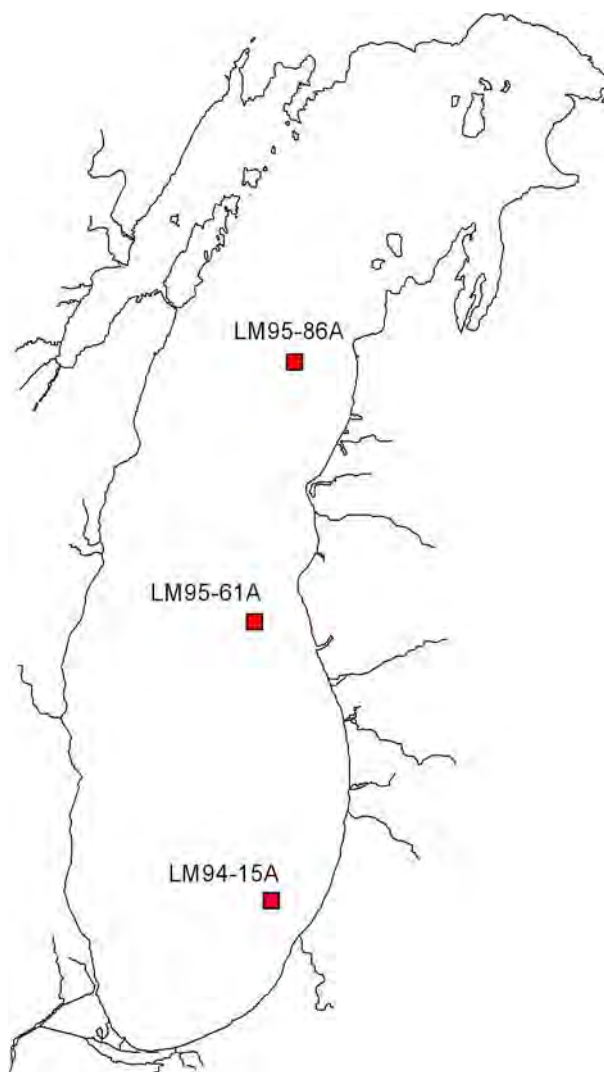

Figure 4.5.14. The sampling sites of the sediment box core samples (LM94-15A, LM95-61A, LM95-87A) taken during the LMMBP for which vertical PCB concentration profiles were analyzed and available.

Table 4.5.6. Available Inventories of PCBs in Lake Michigan Sediments

System	Inventory (kg)	Source
Lake Michigan	75,000	Golden <i>et al.</i> , 1993
Green Bay	14,565	Wisconsin Department of Natural Resources, 2003
Lake Michigan + Green Bay	60,000	Eadie and Van Hoof (personal communication, 2006)

4.5.4.5.2 Results From the LM2-Toxic PCB Hindcast

As mentioned previously, in order to ensure the predictability of a water quality model, a long-term PCB hindcast has conventionally been used for either confirming a set of key model parameters defined by the combination of literature sources and short-term model calibration or directly as a long-term calibration tool if a short-term model calibration has not been conducted. LM2-Toxic went through a very comprehensive and data intensive short-term calibration using LMMBP-generated field data. The PCB hindcast for this report is to confirm the model parameters defined by the short-term calibration and to provide confidence in modeling long-term predictions.

Results from the LM2-Toxic PCB hindcast presented and discussed in this section include 1) water column PCB concentrations from the hindcast versus available historical data, 2) sediment PCB concentrations from the hindcast versus sediment core profiles, 3) mass budget checking for the hindcast simulation period, and 4) a comparison between model-generated PCB sediment inventory and available sediment inventory estimations made by other researchers. In general, the results demonstrate the LM2-Toxic PCB hindcast is reasonably successful for reproducing PCB concentrations in both the water column and the sediments of Lake Michigan.

The results of the LM2-Toxic PCB hindcast are presented in Figures 4.5.15 through 4.5.17 for annual and monthly average concentrations in the water column and annual average concentrations in the sediments. In general, the results from the hindcast are reasonably good for both the water column and the sediment relative to the available historical water column field data and the three LMMBP sediment cores. The results demonstrate that the model is able to generate the temporal trends of PCB concentrations which closely match the observed trends.

Some of the historical data derived before and during 1980 (Chambers and Eadie, 1980; Rice *et al.*, 1982) are not shown in Figures 4.5.15 and 4.5.16. Due to the limitation of the analytical method, the objective of the research studies, and the water depth (≤ 1

meter below the water surface), the representativeness of these early measurements for the lake as a whole is questionable. Taking account of the possible variation in PCB concentrations with water depth, the open lake value of $1.2 \text{ ng/L} \pm 0.46$ (for surface water only - five meters) for 1980 from Swackhamer and Armstrong (1987) was considered to be more appropriate comparison with the lake-wide annual or monthly average concentration generated from the model hindcast.

It is important to consider temporal variation when comparing model results with historical data. For most of the historical data, sampling occurred during a two-week or less period during the year (usually summer). Compared to the annual lake-wide average water column concentration in Figure 4.5.15, the monthly lake-wide average concentration in Figure 4.5.16 demonstrates significant variation in the water column PCB concentrations for any given year. The monthly variation in the lake PCB concentrations becomes most intense in the top layer of the water column (within 10 meter depth) with the highest concentrations occurring in the summer months (July to September) and lowest concentrations in the winter months (December to February).

The vertical profile of PCB sediment concentrations assembled based on the LM2-Toxic PCB hindcast outputs for the depositional area of the lake was compared to the three sediment core profiles (LM94-015A, LM95-061A, and LM95-086A) measured and analyzed for the LMMBP. The concentration profile from the model is porosity normalized. Considering the fact that the model-generated vertical PCB sediment concentration profile is a lake-wide average vertical profile and based on the outputs of the model with a very coarse spatial segmentation, the model did a fairly good job of matching the general trend of the vertical profiles from the three sediment cores and had the closest match with core LM95-061.

There are certainly unmatched portions between the model-generated profile and the profiles from the sediment cores. But it is very important to understand that the common purpose of a hindcast is to provide confirmation of the general conceptualization and parameterization of a model. The successfulness of a model hindcast should not be judged only on whether the model output can match field

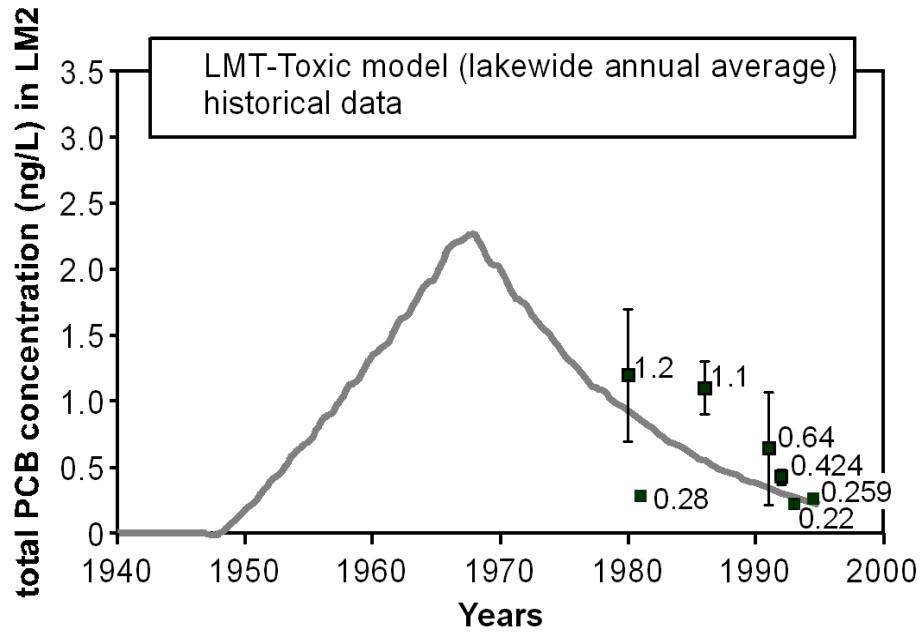

Figure 4.5.15. Annual lake-wide average total PCB water column concentrations from the LM2-Toxic PCB hindcast simulation.

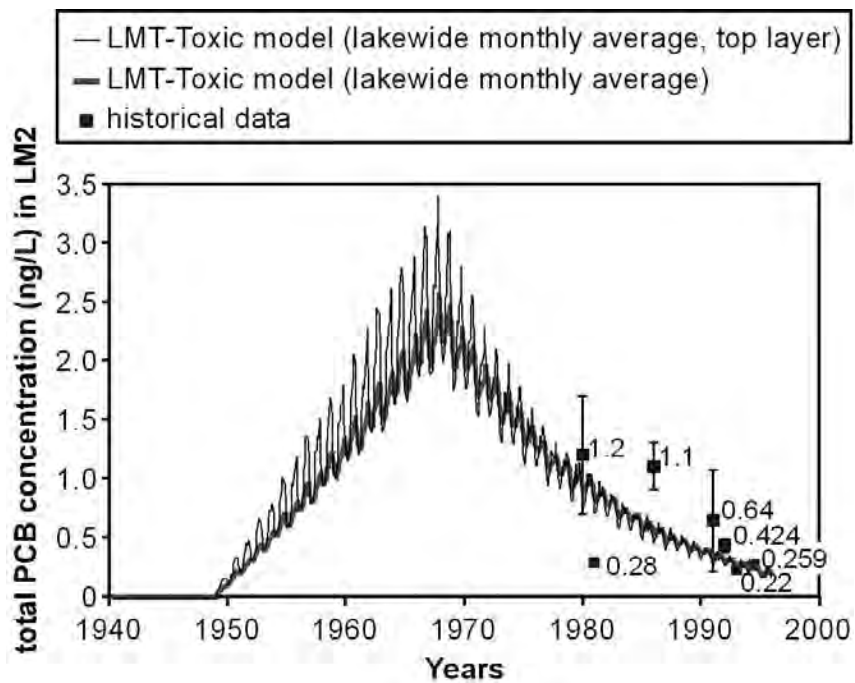

Figure 4.5.16. Monthly lake-wide average total PCB water column concentrations from the LM2-Toxic PCB hindcast simulation. High concentration in the summer months and low concentration in the winter months.

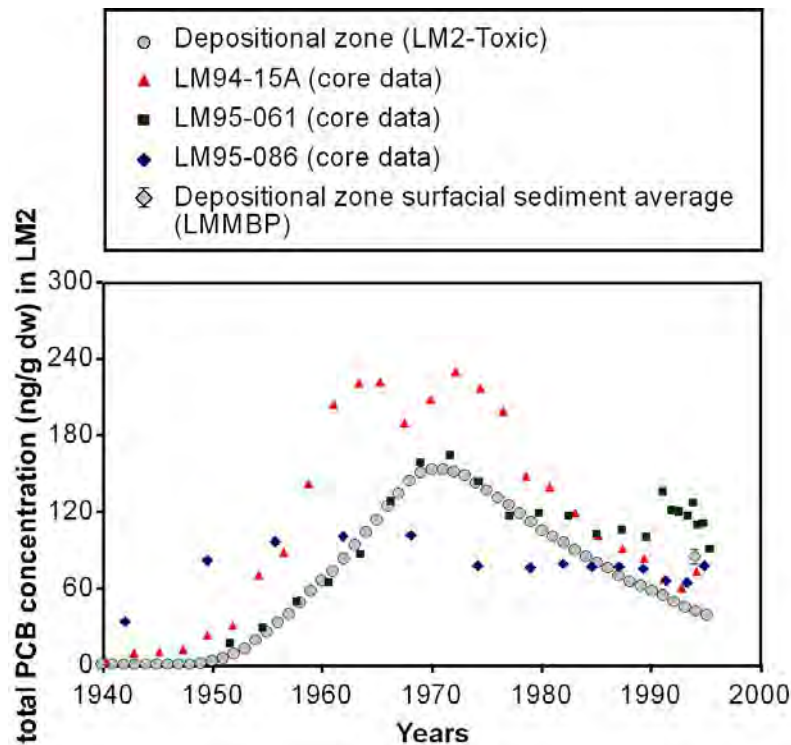

Figure 4.5.17. Annual average total PCB concentration profiles in the sediment depositional zone from the LM2-Toxic PCB hindcast simulation.

observation at one point or a short portion of the temporal profile.

The discrepancy between the LM2-Toxic PCB hindcast generated sediment profile and the profiles from the sediment cores becomes most noticeable for the portion after 1990. This is the part of the profiles that represents the unconsolidated portion – the surficial sediment mixed layer. The explanations for the discrepancy could be:

- 1) The model does not have adequately reconstructed historical physical conditions such as wave, water circulation, and temperature time functions. These time functions can dictate organic carbon and PCB concentrations in the lake and the solids cycling rates such as resuspension, burial, and settling. For example, a severe weather event could create a major localized resuspension event in the lake and, therefore, could elevate PCB concentrations in the local water column and surficial sediments along the path impacted by water transport. The

elevated concentrations could also remain for a long time after the major event. The recorded maximum wave heights from the southern National Oceanic and Atmospheric Administration’s (NOAA) buoy 45007 indicate that a major storm event occurred on September 23, 1989 which induced a maximum wave height of 5.6 meters. The sediment profile from core LM95-061A shows a step increase in PCB concentrations just after the event. The step increase would very likely be caused by re-depositing the sediments with higher PCB concentrations resuspended from a nearby area.

- 2) The unit for the sediment PCB concentration output from the LM2-Toxic is ng/L. In order to compare it with the PCB sediment profiles (ng/g dw) from the cores, porosity is used to convert the model-generated PCB sediment concentration from the unit of ng/L to ng/g dw. The converted PCB sediment concentration is extremely sensitive to the porosity used in the conversion. The value (0.953) for the porosity

used in the conversion is the average of the porosities at the sediment sampling sites located within the depositional area of the lake. The range of the porosities at these sediment sampling sites is between 0.943 and 0.966.

- 3) Some physical-chemical processes such as the BNL and its associated transport were not built in the LM2-Toxic model. A seasonal persistent BNL with high total suspended solid is not an uncommon phenomenon in the Great Lakes and has been observed and documented by numerous researchers (Chambers and Eadie, 1980, 1981; Eadie *et al.*, 1984; Baker and Eisenreich, 1985; Baker *et al.*, 1991; Eadie, 1997; Hawley, 2003). The BNL is usually formed in a large lake such as a Great Lake during summer stratification. The thickness of the BNL is from a few meters up to 10 meters above the bottom of the lake (Chambers and Eadie, 1980, 1981; Eadie *et al.*, 1984). Total suspended solids and associated chemicals in both particulate and dissolved phases increase exponentially from the top to the bottom of the BNL. The suspended solids in the hypolimnion with less attached pollutant will adsorb more PCBs when the solids settle through this layer to the lake bottom. The existence of the BNL and the physical-chemical processes associated with this layer could elevate the concentration of PCBs in the sediments. Compared to the hypolimnion, samples collected in the BNL during the LMMBP (August 1994, August 1995, and September 1995 cruises) show a 4 to 20 times higher particulate PCB concentrations and 1.5 times higher dissolved PCB concentrations. Because the BNL and the associated processes are not built in the LM2-Toxic, the PCB hindcast could underpredict PCB concentrations in certain areas of the lake sediments.
- 4) There are uncertainties associated with the derived historical primary production, PCB loading, and vapor-phase time functions.
- 5) The uncertainties related to model parameters including calibration parameters could also propagate through the model to the predicted sediment PCB concentrations.

Mass budget checking is a necessary step to ensure that a water quality model does not generate or lose mass through the entire simulation period. Figure 4.5.18 shows the mass budget of Σ PCB (sum of 54 PCB congeners for Lake Michigan during the simulation period of the LM2-Toxic PCB hindcast (1949-1995). The inventories in the mass budget diagram represent the Σ PCB masses left in both the water column and sediment at the end (last time step) of the model simulation. Each mass component with an arrow in Figure 4.5.18 indicates a mass flux in or out of the system during the entire simulation period. A simple mass budget check was done based on the numbers in Figure 4.5.18. Table 4.5.7 lists the Σ PCB inventories, the mass fluxes, and the calculation of the mass budget checking. The result of the mass budget checking shows that there is only about 0.66% of mass not being accounted for over the 47 years of the hindcast simulation period. This small amount of uncounted mass over the entire hindcast period should not have much of an impact on the accuracy of PCB concentrations computed by the LM2-Toxic.

The most reliable confirmation of the LM2-Toxic model comes from the comparison between the total PCB sediment inventory (total PCB = Σ PCB \times 1.1668 = 52,278 kg \times 1.1668 = 60,998 kg) calculated from the LM2-Toxic PCB hindcast and the latest estimation of the total PCB sediment inventory (about 60,000 kg) provided by Eadie and Van Hoof (personal communication, see Part 1, Chapter 7). The factor 1.1668 used to convert the Σ PCBs to the total PCBs was derived from the LMMBP data (Part 1, Chapter 3). The latest sediment inventory estimate from Eadie and Van Hoof was based on a large quantity of information collected during the LMMBP for Lake Michigan sediment, including more than 60 box core PCB sediment profiles and also roughly 60 ponar and gravity core samples. A few previous and most recent studies listed in Table 4.5.6 indicate that the lake-wide sediment inventory is likely between 60,000 kg and 75,000 kg. The sediment PCB inventory (60,988 kg) computed from the LM2-Toxic PCB hindcast is within the range provided in the literature.

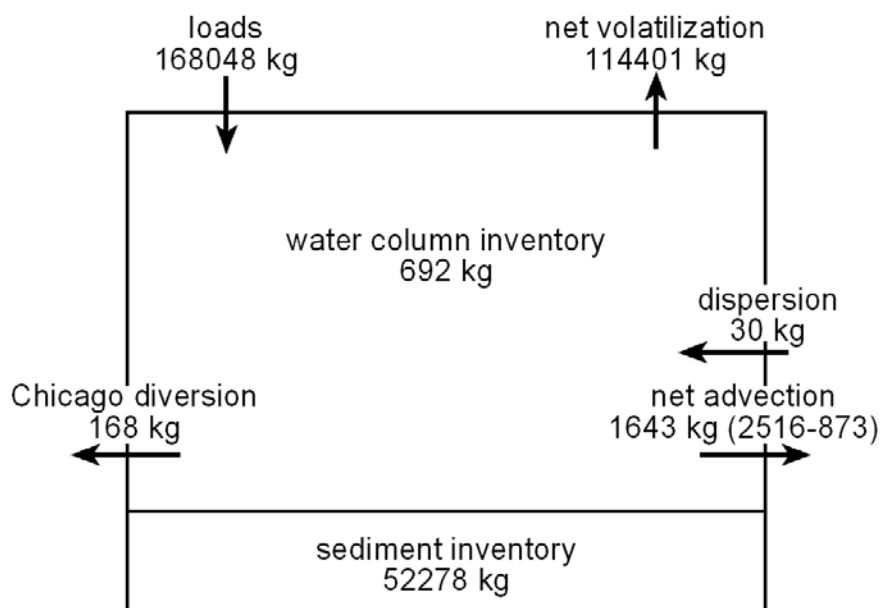

Figure 4.5.18. ΣPCB mass budget of Lake Michigan during the period of the LM2-Toxic PCB hindcast (1949-1995).

Table 4.5.7. Calculations in PCB Mass Budget Checking for the LM2-Toxic PCB Hindcast

Mass of In-Flux (kg)		Mass of Out-Flux (kg)		Inventory (Kg)	
Loads	16,048	Net Volatilization	114,401	Water Column	692
Dispersion	30	Net Advection	1,643	Sediment	52,278
		Chicago Diversion	168		

Difference in PCB mass over the hindcast simulation period (47 years) = (Inventory + Mass of out-flux) - (Mass of in-flux) = (692 + 52,278 + 114,401 + 1,643 + 168) - (168,048 + 30) = 169,182 - 168,078 = 1,104 kg

Percentage of the difference in PCB mass over the PCB total input into Lake Michigan = difference in PCB mass over the hindcast simulation/mass of in-flux = 1,104 kg/168,078 kg = 0.657%

Given the adequate level of reconstructed historical forcing functions including loading and vapor phase concentrations, the overall results from the LM2-Toxic PCB hindcast demonstrate that the model is able to generate PCB concentrations in both the water column and sediment that compare reasonably well with the available historical data and estimated sediment total PCB inventories.

References

- Anderson, D.J., T.B. Bloem, R.K. Blankenbaker, and T.A. Stanko. 1999. Concentrations of Polychlorinated Biphenyls in the Water Column of the Laurentian Great Lakes: Spring 1993. *J. Great Lakes Res.*, 25(1):160-170.
- Baker, J.E. and S.J. Eisenreich. 1985. Chlorinated Hydrocarbon Cycling in the Benthic Nepheloid Layer of Lake Superior. *Environ. Sci. Technol.*, 19(9):854-861.
- Baker, J.E., S.J. Eisenreich, and B.J. Eadie. 1991. Sediment Trap Fluxes and Benthic Recycling of Organic Carbon, Polycyclic Aromatic Hydrocarbon, and Polychlorobiphenyl Congeners in Lake Superior. *Environ. Sci. Technol.*, 25(3):500-509.
- Bamford, H.A., D.L. Poster, R.E. Huie, and J.E. Baker. 2002. Using Extrathermodynamic Relationships to Model the Temperature Dependence of Henry's Law Constants of 209 PCB Congeners. *Environ. Sci. Technol.*, 36(20):4395-4402.
- Bicksler, J. 1996. PCBs in the Spring-Time Water Column of the Great Lakes. M.S. Thesis, University of Minnesota, Minneapolis, Minnesota. 160 pp.
- Bierman, V.J., J.V. DePinto, T.C. Young, P.W. Rodgers, S.C. Martin, and R. Raghunathan. 1992. Development and Validation of an Integrated Exposure Model for Toxic Chemicals in Green Bay, Lake Michigan. U.S. Environmental Protection Agency, Office of Research and Development, ERL-Duluth, Large Lakes Research Station, Grosse Ile, Michigan. 381 pp.
- Buehler, S.S., I. Basu, and R.A. Hites. 2002. Gas-Phase Polychlorinated Biphenyl and Hexachlorocyclohexane Concentrations Near the Great Lakes: A Historical Perspective. *Environ. Sci. Technol.*, 36(23):5051-5056.
- Buehler, S.S., I. Basu, and R.A. Hites. 2004. Causes of Variability in Pesticide and PCB Concentrations in Air Near the Great Lakes. *Environ. Sci. Technol.*, 38(2):414-422.
- Chambers, R.L. and B.J. Eadie. 1980. Nearshore Chemistry in the Vicinity of the Grand River, Michigan. National Oceanic and Atmospheric Administration, Great Lakes Environmental Research Laboratory, Ann Arbor, Michigan. NOAA Technical Memorandum ERL GLERL-28, 28 pp.
- Chambers, R.L. and B.L. Eadie. 1981. Nepheloid and Suspended Particulate Matter in Southeastern Lake Michigan. *Sedimentology*, 28(3):439-447.
- Delaware River Basin Commission. 2003. Calibration of the PCB Water Quality Model for the Delaware Estuary for Penta-PCBs and Carbon. Delaware River Basin Commission, West Trenton, New Jersey. 147 pp. (Website: http://www.epa.gov/reg3wapd/tmdl/pa_tmdl/delaware%20river/ModelCalibrationReport.pdf).
- DePinto, J.V., R. Raghunathan, P. Sierzenga, X. Zhang, V.J. Bierman, Jr., P.W. Rodgers, and T.C. Young. 1993. Recalibration of GBTOX: An Integrated Exposure Model for Toxic Chemicals in Green Bay, Lake Michigan. Final Report. U.S. Environmental Protection Agency, Office of Research and Development, ERL-Duluth, Large Lakes Research Station, Grosse Ile, Michigan. 132 pp.
- DePinto, J.V., W.M. Larson, J. Kaur, and J. Atkinson. 2003. LOTOX2 Model Documentation - In Support of Development of Load Reduction Strategies and a TMDL for PCBs in Lake Ontario. Submitted to New England Interstate Water Pollution Control Commission, Boott Mills South, Lowell, Massachusetts. 122 pp.

-
- Eadie, B.J., R.L. Chambers, W.S. Gardner, and G.L. Bell. 1984. Sediment Trap Studies in Lake Michigan: Resuspension and Chemical Fluxes in the Southern Basin. *J. Great Lakes Res.*, 10(3):307-321.
- Eadie, B.J., H.A. Vanderploeg, J.A. Robbins, and G.L. Bell. 1990. Significance of Sediment Resuspension and Particle Settling. In: M.M. Tilzer and C. Serruya (Eds.), *Large Lakes: Ecological Structure and Function*, pp. 196-209. Springer-Verlag, New York, New York.
- Eadie, B.J. 1997. Probing Particle Processes in Lake Michigan Using Sediment Traps. *Water, Air, and Soil Pollut.*, 99:133-139.
- Endicott, D.D. 2005. 2002 Lake Michigan Mass Balance Project: Modeling Total PCBs Using the MICHTOX Model. In: R. Rossmann (Ed.), *MICHTOX: A Mass Balance and Bioaccumulation Model for Toxic Chemicals in Lake Michigan, Part 2*. U.S. Environmental Protection Agency, Office of Research and Development, National Health and Environmental Effects Research Laboratory, MED-Duluth, Large Lakes Research Station, Grosse Ile, Michigan. EPA/600/R-05/158, 140 pp.
- Endicott, D.D., W.L. Richardson, and D.J. Kandt. 2005. 1992 MICHTOX: A Mass Balance and Bioaccumulation Model for Toxic Chemicals in Lake Michigan. In: R. Rossmann (Ed.), *MICHTOX: A Mass Balance and Bioaccumulation Model for Toxic Chemicals in Lake Michigan, Part 1*. U.S. Environmental Protection Agency, Office of Research and Development, National Health and Environmental Effects Research Laboratory, MED-Duluth, Large Lakes Research Station, Grosse Ile, Michigan. EPA/600/R-05/158, 140 pp.
- Filkins, J.C., J.M. Townsend, and S.G. Rood. 1983. Organochlorines in Offshore Waters of the Great Lakes, 1981. U.S. Environmental Protection Agency, Office of Research and Development, ERL-Duluth, Large Lakes Research Station, Grosse Ile, Michigan. 12 pp.
- Gardiner, R.D., M.T. Auer, and R.P. Canale. 1984. Sediment Oxygen Demand in Green Bay (Lake Michigan). In: M. Pirbazari and J.S. Devinny (Eds.), *Proceedings of the 1984 Specialty Conference on Environmental Engineering*, pp. 514-519. American Society of Civil Engineers, New York, New York.
- Gobas, F.A.P.C., M.N.Z. Graggen, and X. Zhang. 1995. Time Response of the Lake Ontario Ecosystem to Virtual Elimination of PCBs. *Environ. Sci. Technol.*, 29(8):2038-2046.
- Golden, K.A., C.S. Wong, J.D. Jeremiason, S.J. Eisenreich, G. Sanders, J. Hallgren, D.L. Swackhamer, D.R. Engstrom, and D.T. Long. 1993. Accumulation and Preliminary Inventory of Organochlorines in Great Lakes Sediments. *Water Sci. Technol.*, 29(8-9):19-31.
- Hall, D. and D. Robertson. 1998. Estimation of Contaminant Loading from Monitored and Unmonitored Tributaries to Lake Michigan for the USEPA Lake Michigan Mass Balance Study. Quality Systems and Implementation Plan. Submitted October 23, 1998. U.S. Environmental Protection Agency, Great Lakes National Program Office, Chicago, Illinois. 19 pp.
- Hawker, D.W. and D.W. Connell. 1988. Octanol-Water Partition Coefficients of Polychlorinated Biphenyl Congeners. *Environ. Sci. Technol.*, 22(4):382-387.
- Hawley, N. 2003. Observations of the Intermediate and Benthic Nepheloid Layers in Southern Lake Michigan During the Summer of 1995. National Oceanic and Atmospheric Administration, Great Lakes Environmental Research Laboratory, Ann Arbor, Michigan. NOAA Technical Memorandum ERL GLERL-124, 30 pp.
- Hillery, B.L., I. Basu, C.W. Sweet, and R.A. Hites. 1997. Temporal and Spatial Trends in a Long-Term Study of Gas-Phase PCB Concentrations Near the Great Lakes. *Environ. Sci. Technol.*, 31(6):1811-1816.

-
- Jeremiason, J.D., K.C. Hornbuckle, and S.J. Eisenreich. 1994. PCBs in Lake Superior, 1978-1992: Decreases in Water Concentrations Reflect Loss by Volatilization. *Environ. Sci. Technol.*, 28(5):903-914.
- Lefkovitz, L.F. 1987. The Particle Mediated Fractionation of PCBs in Lake Michigan. M.S. Thesis, University of Wisconsin, Madison, Wisconsin. 238 pp.
- Mackay, D. 1988. A Model of PCB Behaviour in Lake Ontario. In: Report on Modeling the Loading-Concentration Relationship for Critical Pollutants in the Great Lakes, Appendix V. Task Force on Chemical Loadings, Water Quality Board, International Joint Commission, Windsor, Ontario, Canada. 275 pp.
- McCarty, H.B., J. Schofield, K. Miller, R.N. Brent, P. Van Hoff, and B. Eadie. 2004. Results of the Lake Michigan Mass Balance Study: Polychlorinated Biphenyls and *trans*-Nonachlor Data Report. U.S. Environmental Protection Agency, Great Lakes National Program Office, Chicago, Illinois. EPA/905/R-01/011, 289 pp.
- Miller, S.M., M.L. Green, J.V. DePinto, and K.C. Hornbuckle. 2001. Results from the Lake Michigan Mass Balance Study: Concentrations and Fluxes of Atmospheric Polychlorinated Biphenyls and *trans*-Nonachlor. *Environ. Sci. Technol.*, 35(2):278-285.
- Miller, S.M. 2003. The Effects of Large-Scale Episodic Sediment Resuspension on Persistent Organic Pollutants in Southern Lake Michigan. Ph.D. Thesis, The University of Iowa, Iowa City, Iowa. 194 pp.
- Pearson, R.F., K.C. Hornbuckle, S.J. Eisenreich, and D.L. Swackhamer. 1996. PCBs in Lake Michigan Water Revisited. *Environ. Sci. Technol.*, 30(5):1429-1436.
- Rice, C.P., B.J. Eadie, and K.M. Erstfield. 1982. Enrichment of PCBs in Lake Michigan Surface Films. *J. Great Lakes Res.*, 8(2):265-270.
- Robbins, J.A., N.R. Morehead, R.W. Rood, D.N. Edgington, and S. Meyer. 1999. Accumulation and Near-Surface Mixing of Sediments in Lake Michigan as Determined for the Lake Michigan Mass Balance Program, Volumes 1 and 2. Project Report. U.S. Environmental Protection Agency, Office of Research and Development, ERL-Duluth, Large Lakes Research Station, Grosse Ile, Michigan. 503 pp.
- Rodgers, P.W., T.A.D. Slaweki, J.V. DePinto, and W. Booty. 1988. LTI Toxics Model Application: PCBs in Lake Ontario - An Exploratory Application. In: Report on Modeling the Loading-Concentration Relationship for Critical Pollutants in the Great Lakes, Appendix III. Task Force on Chemical Loadings, Water Quality Board, International Joint Commission, Windsor, Ontario, Canada. 275 pp.
- Rygwelski, K.R. (Ed.). 2005. Lake Michigan Mass Balance Project (LMMBP) PCB Peer Review Report. U.S. Environmental Protection Agency, Office of Research and Development, National Health and Environmental Effects Research Laboratory, MED-Duluth, Large Lakes Research Station, Grosse Ile, Michigan. 31 pp.
- Schneider, A.R., H.M. Stapleton, J. Cornwell, and J.E. Baker. 2001. Recent Declines in PAH, PCB, and Toxaphene Levels in the Northern Great Lakes as Determined from High Resolution Sediment Cores. *Environ. Sci. Technol.*, 35(19):3809-3815.
- Schwab, D. and D. Beletsky. 1998. Lake Michigan Mass Balance Study: Hydrodynamic Modeling Project. National Oceanic and Atmospheric Administration, Great Lakes Environmental Research Laboratory, Ann Arbor, Michigan. NOAA Technical Memorandum ERL GLERL-108, 53 pp.
- Swackhamer, D.L. and D.E. Armstrong. 1987. Distribution and Characterization of PCBs in Lake Michigan Water. *J. Great Lakes Res.*, 13(1):24-36.
- Thomann, R.V. and D.M. Di Toro. 1983. Physico-Chemical Model of Toxic Substances in the Great Lakes. *J. Great Lakes Res.*, 9(4):474-496.

U.S. Environmental Protection Agency. 1997. Lake Michigan Mass Balance Project Modeling Work Plan. Final Report. U.S. Environmental Protection Agency, Office of Research and Development, ERL-Duluth, Large Lakes Research Station, Grosse Ile, Michigan. 30 pp.

U.S. Environmental Protection Agency. 2000. Hudson River PCBs Reassessment RI/FS Phase 3 Report: Feasibility Study, Books 1-6. U.S. Environmental Protection Agency, Region 2, New York, New York. 2,095 pp.

Vollenweider, R.A., M. Munawar, and P. Stadelmann. 1974. A Comparative Review of Phytoplankton and Primary Production in the Laurentian Great Lakes. J. Fish. Res. Board Canada, 31(5):739-762.

Wisconsin Department of Natural Resources. 2003. Estimates of PCB Mass, Sediment Volume, and Surface Sediment Concentrations in Operable Unit 5, Green Bay Using an Alternative Approach. Wisconsin Department of Natural Resources, Madison, Wisconsin. White Paper Number 19, 23 pp.

PART 4
LM2-TOXIC

Appendix 4.5.1. Results From Thermal Balance Model

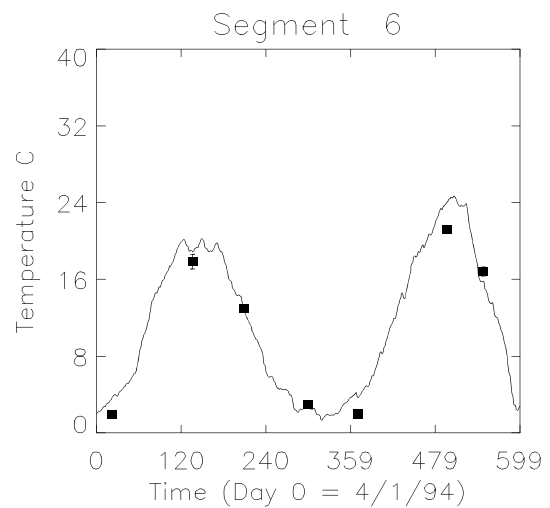
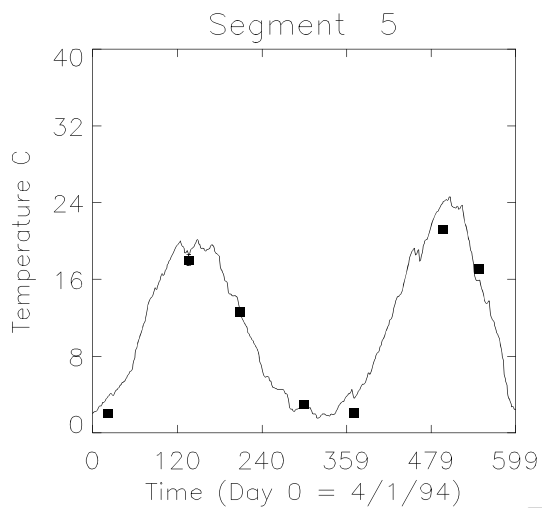
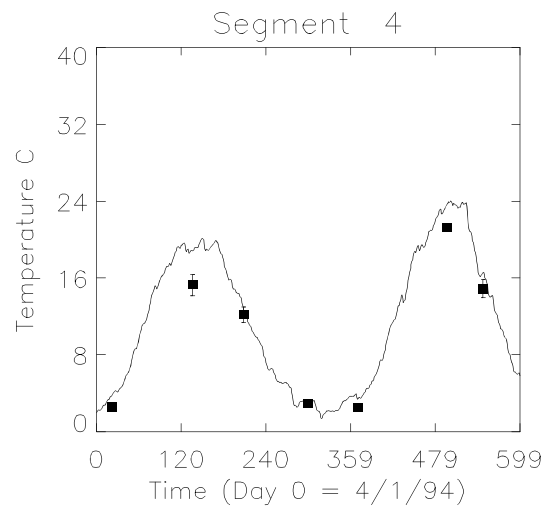
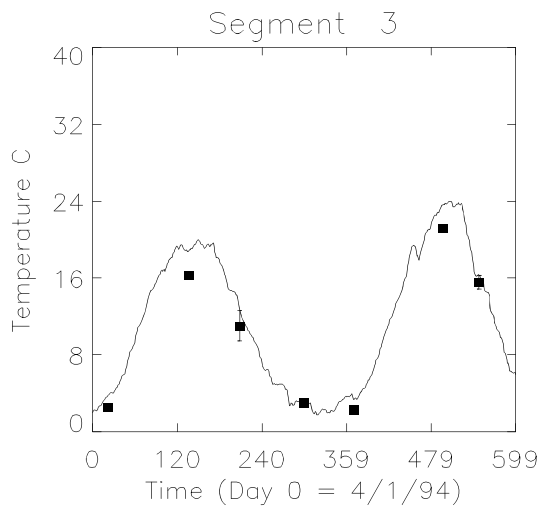
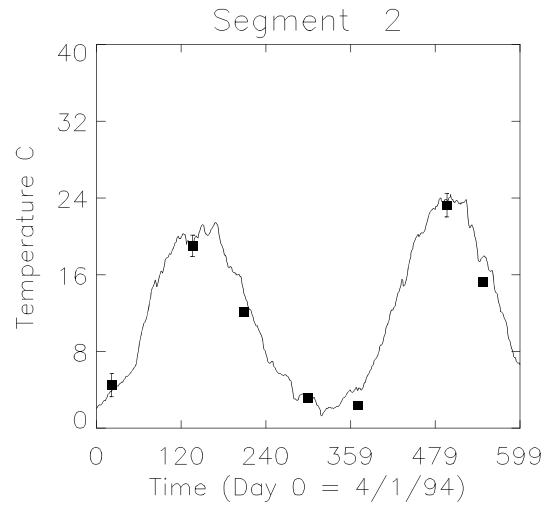
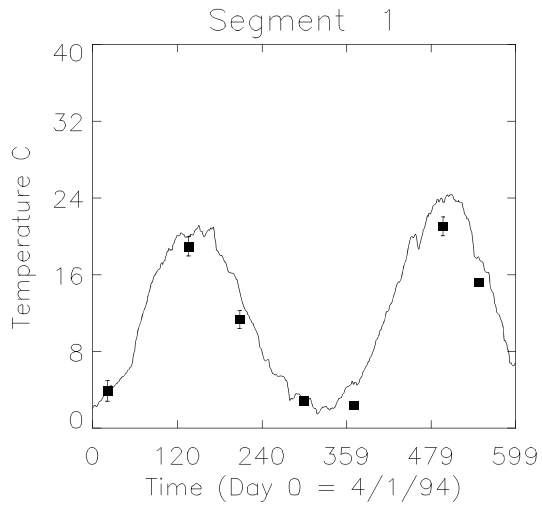

Temperature

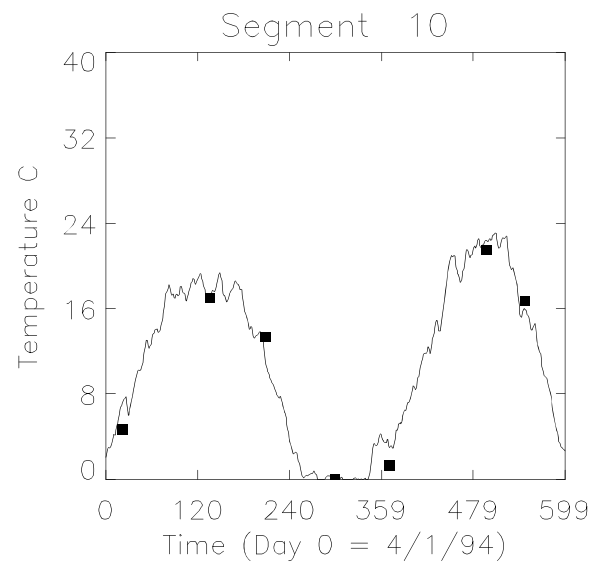
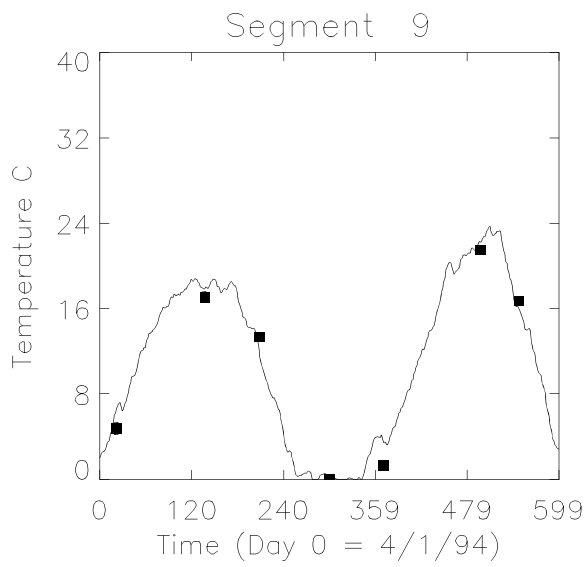
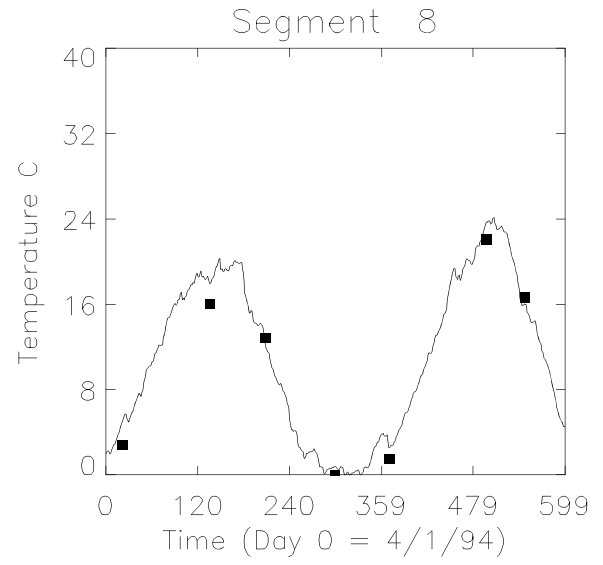
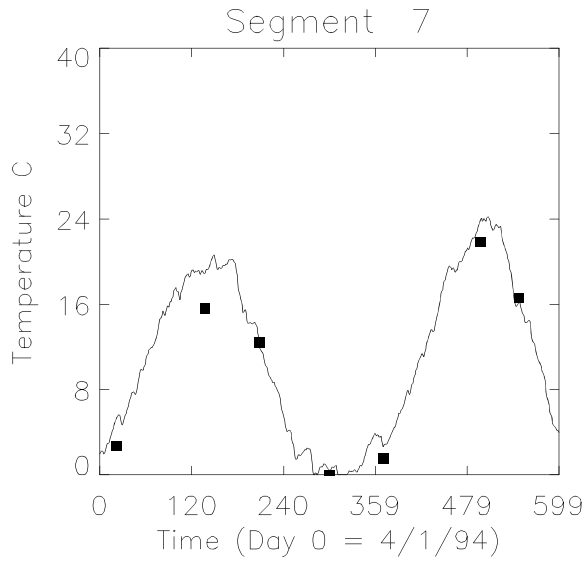

Temperature

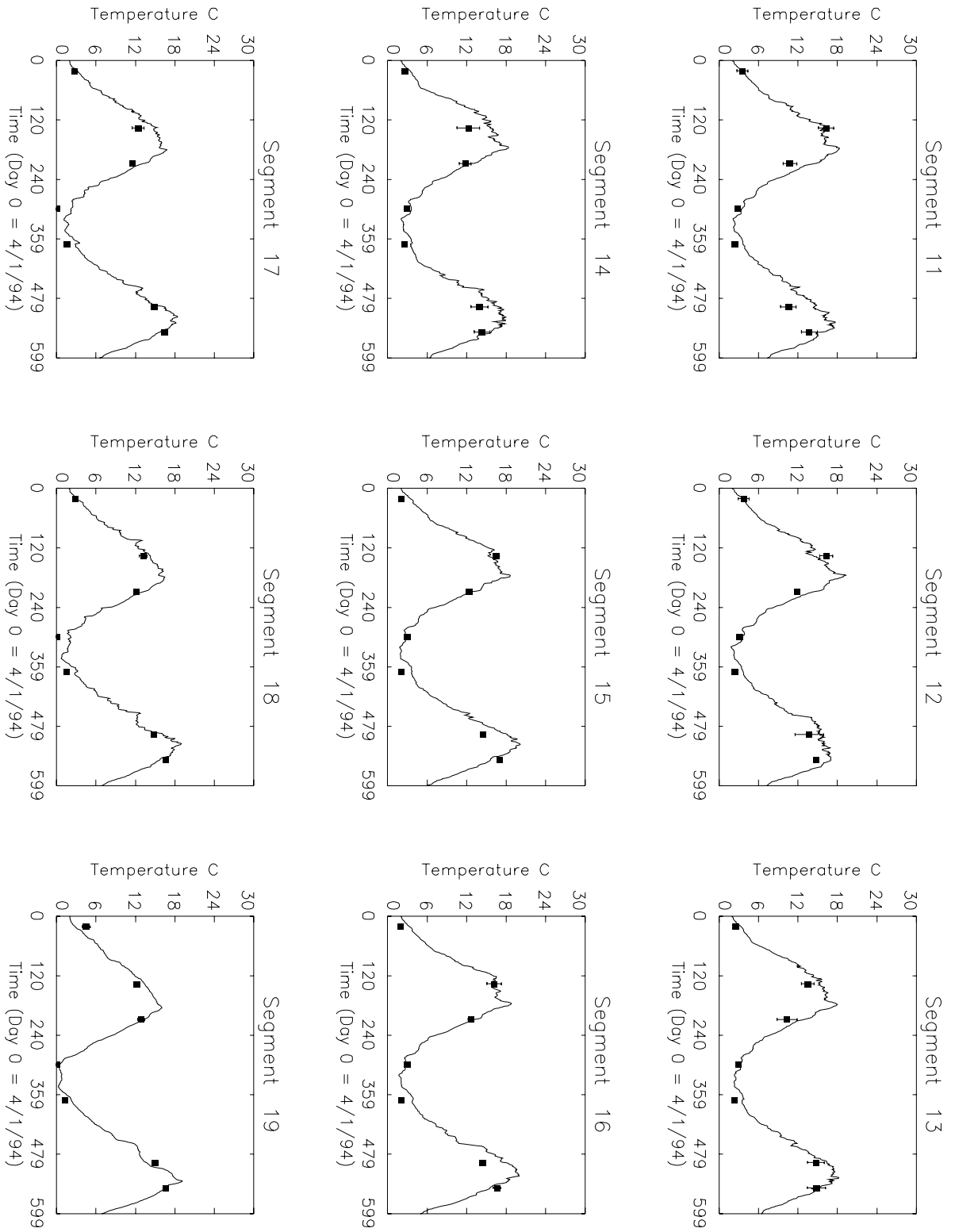

Temperature

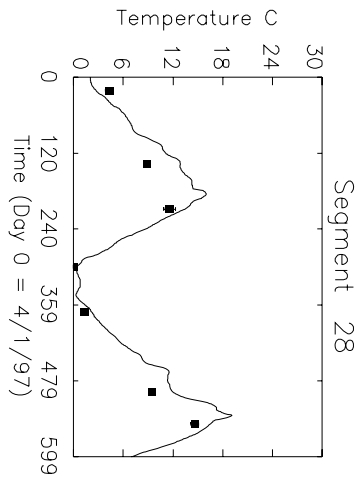
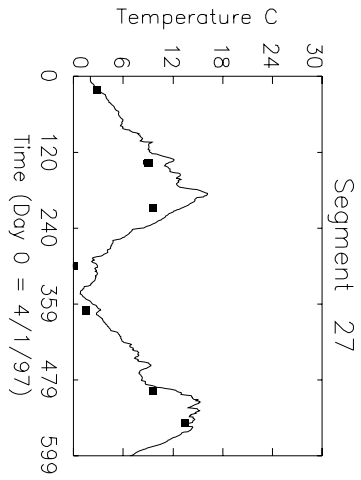
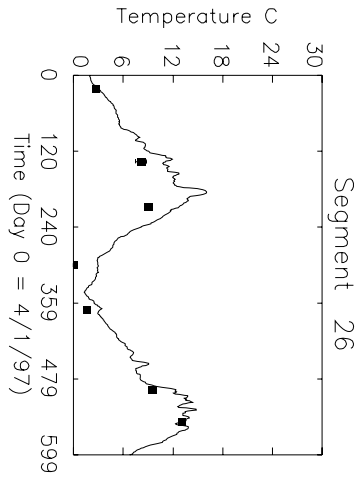
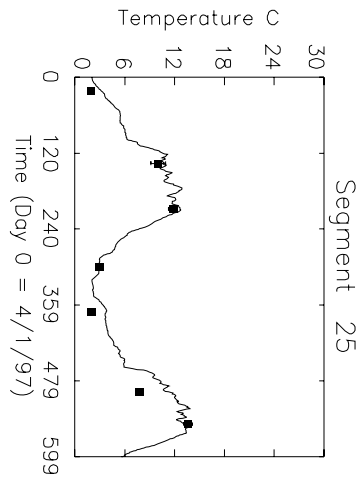
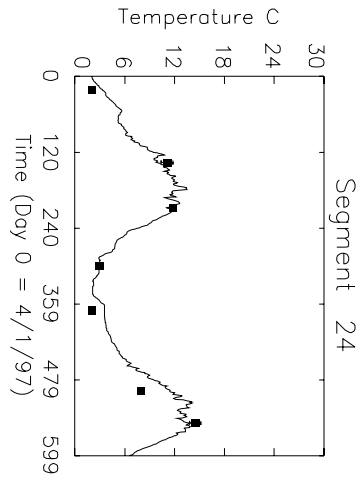
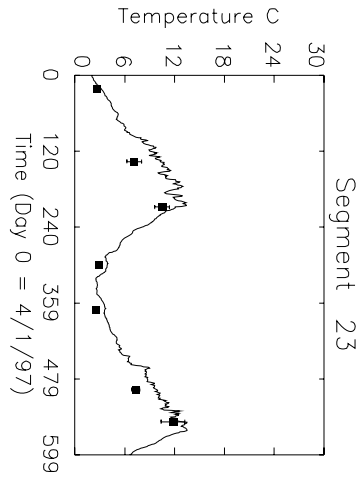
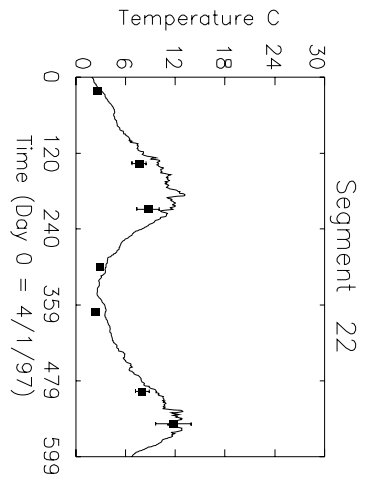
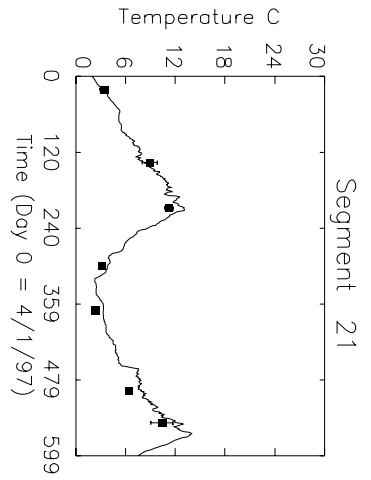
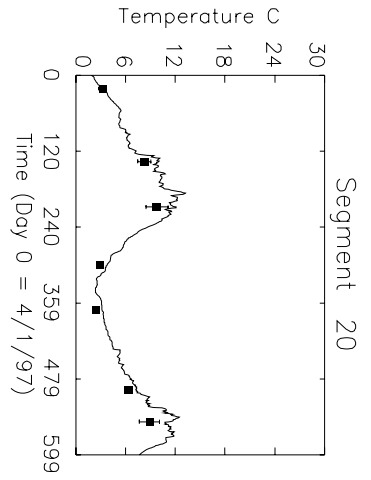

Temperature

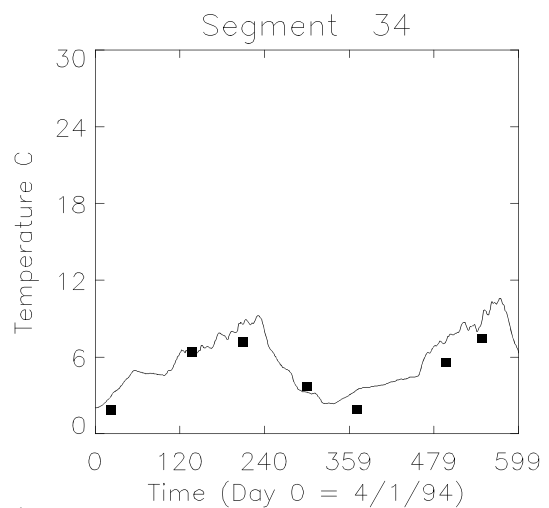
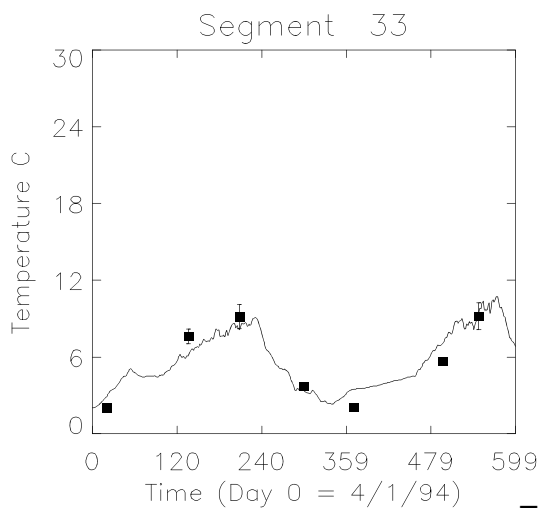
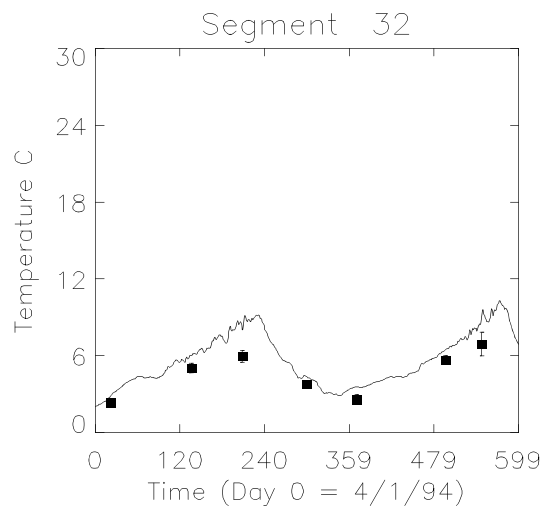
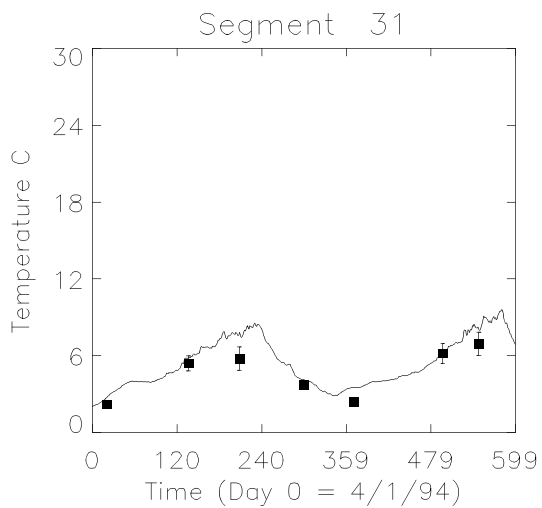
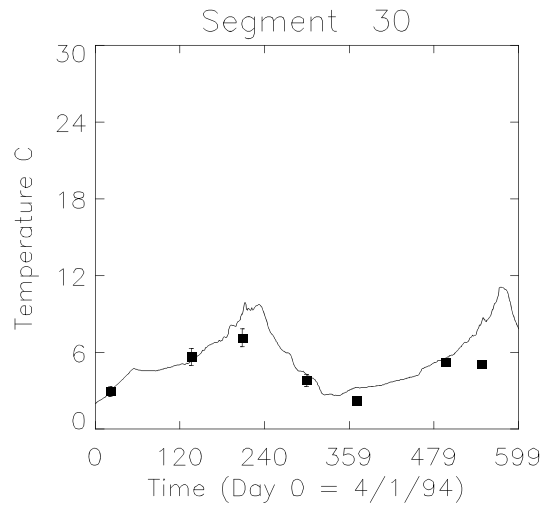
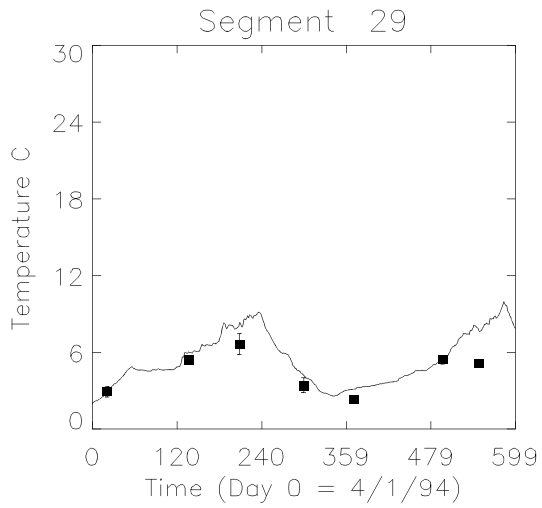

Temperature

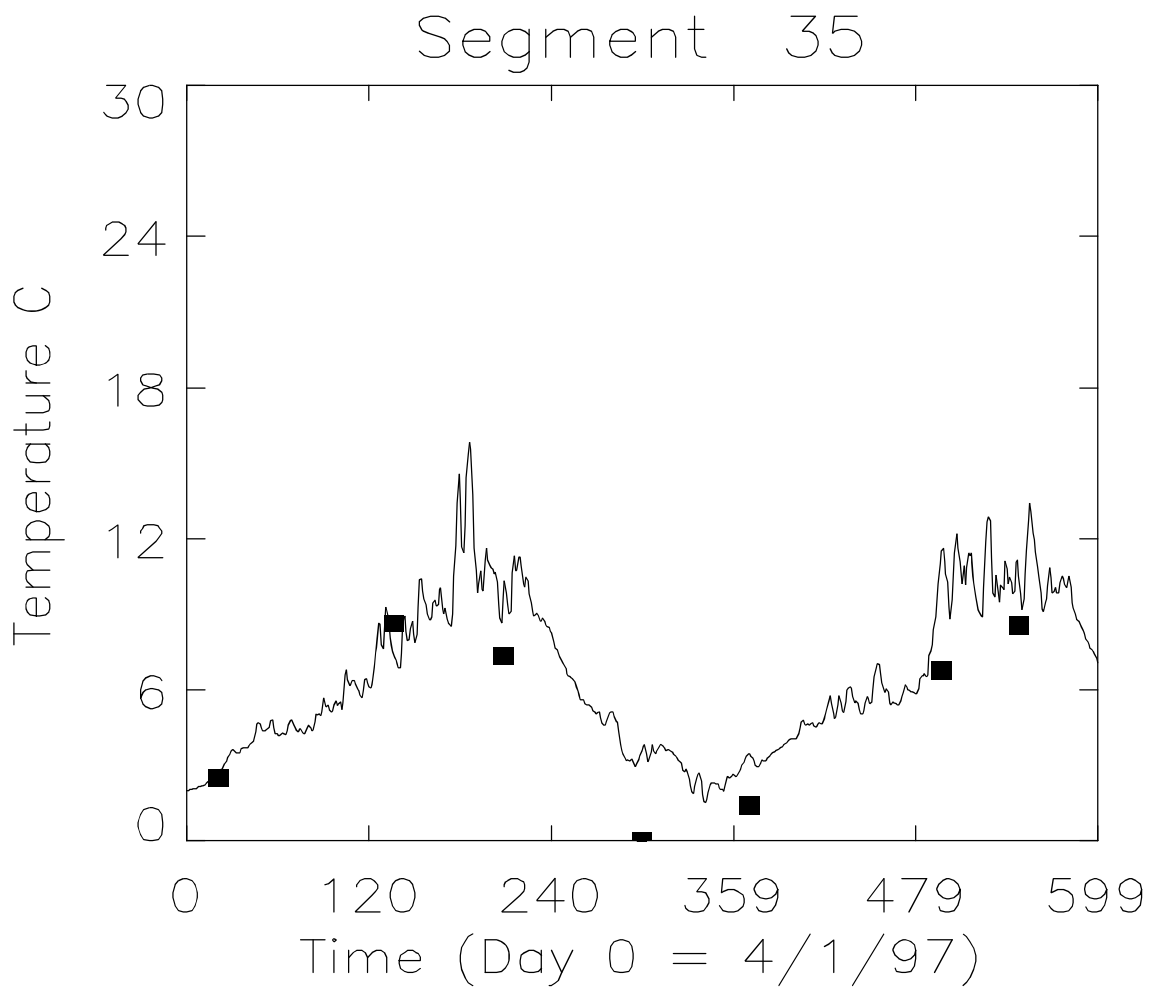

Temperature

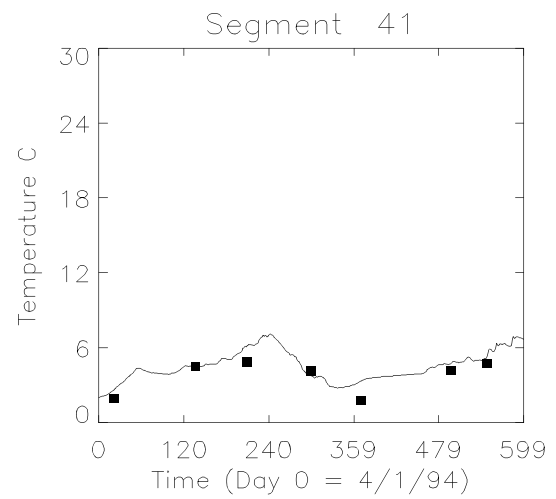
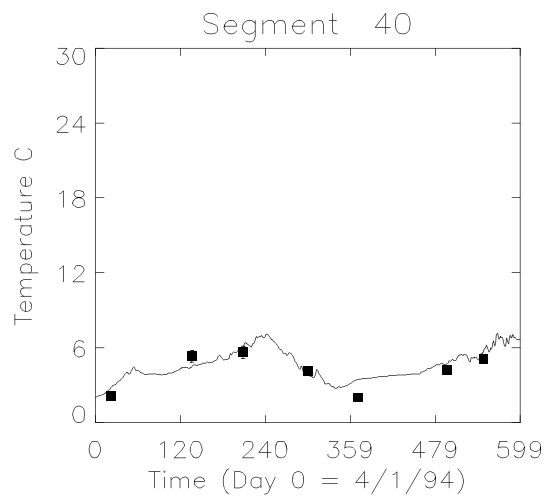
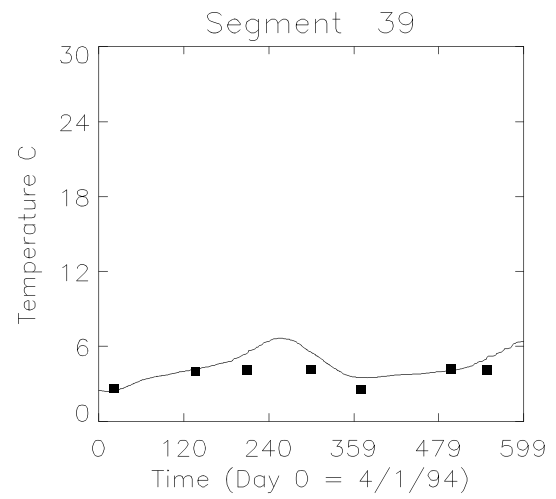
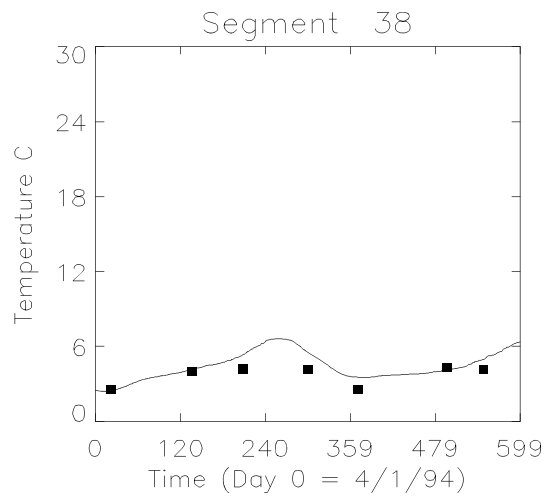
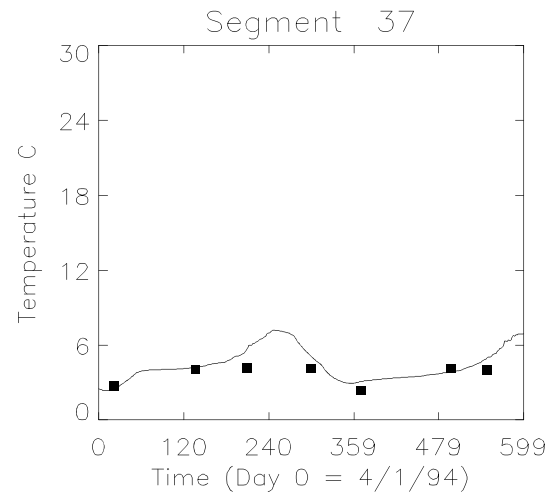
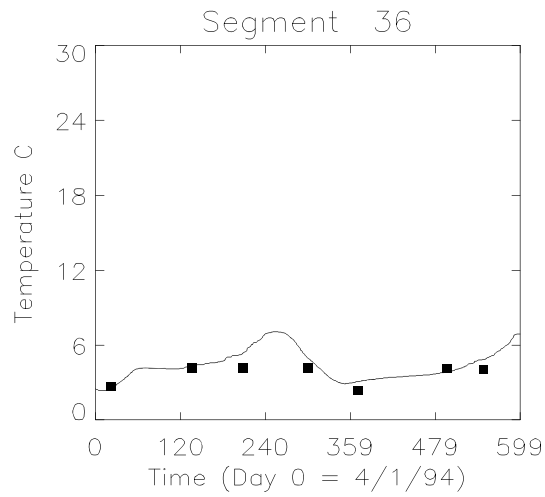

Temperature

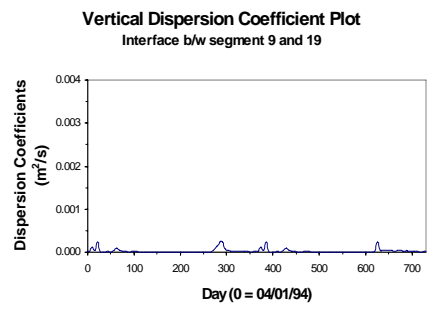
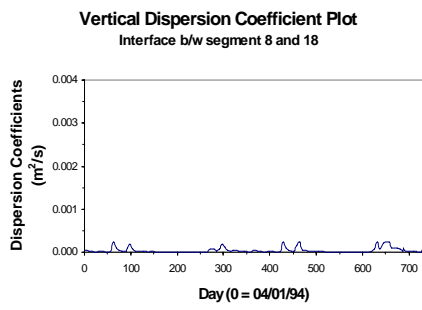
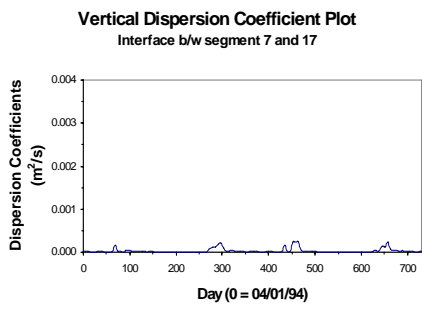
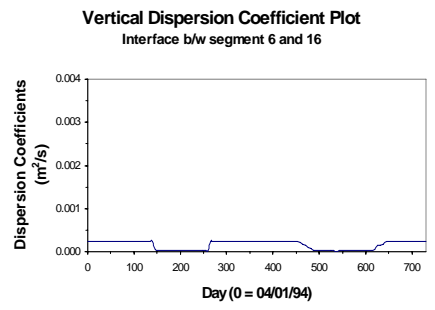
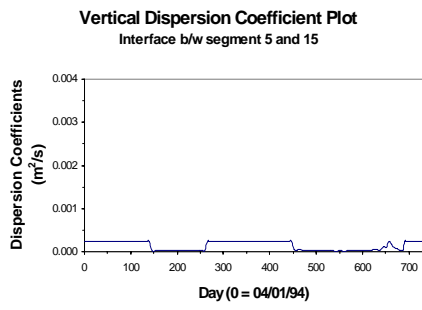
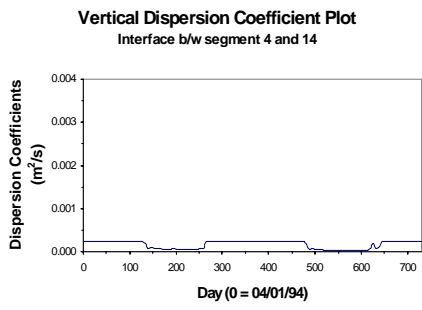
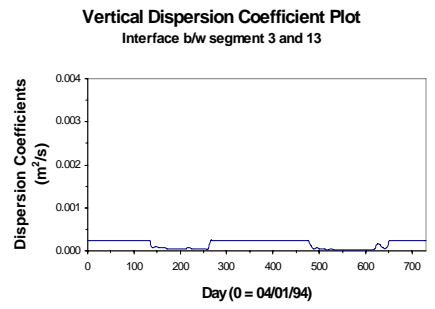
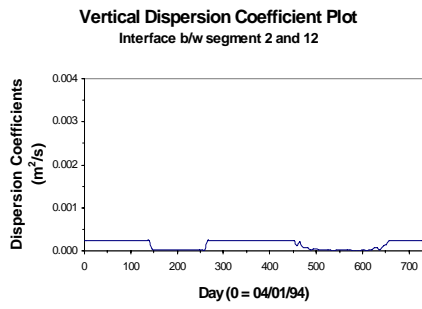
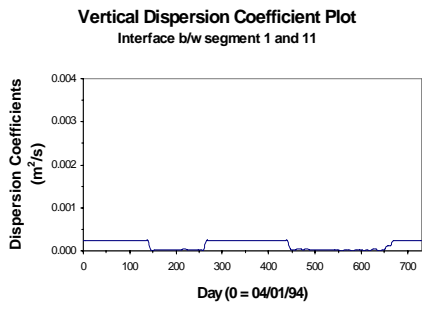

Vertical Dispersion Coefficient

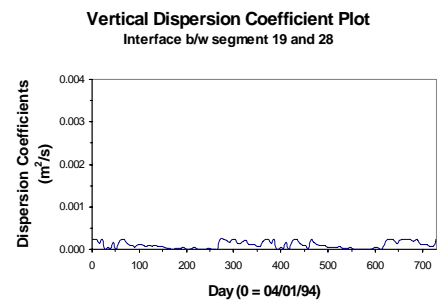
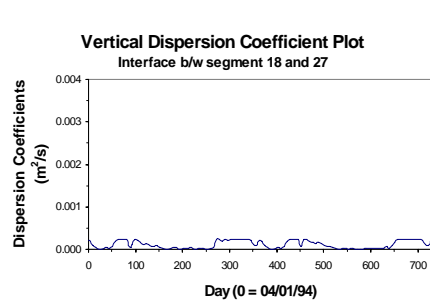
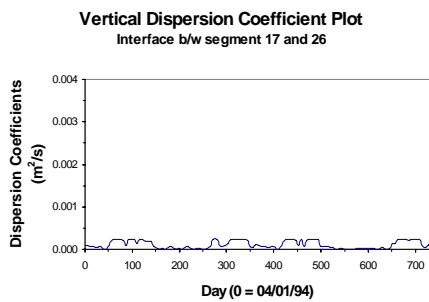
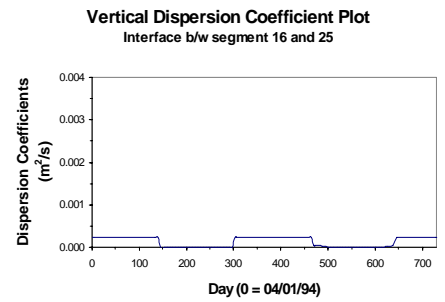
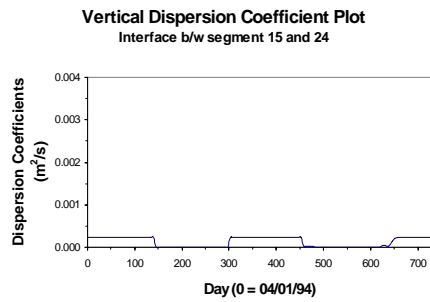
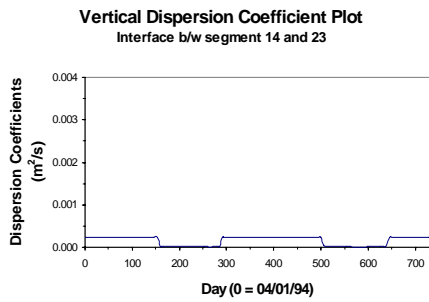
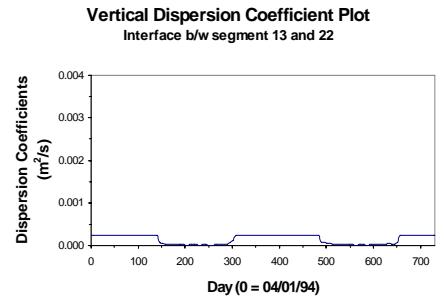
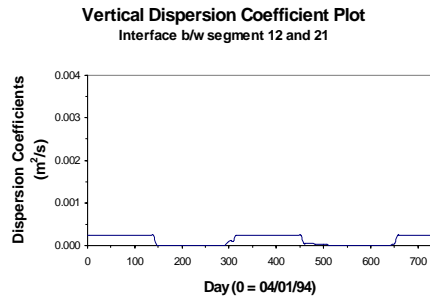
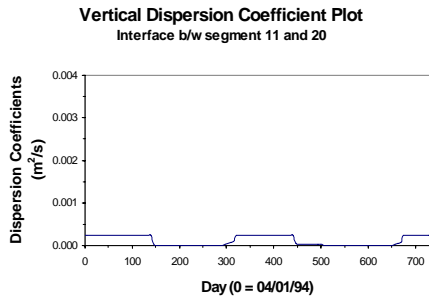

Vertical Dispersion Coefficient

Vertical Dispersion Coefficient Plot
Interface b/w segment 20 and 29

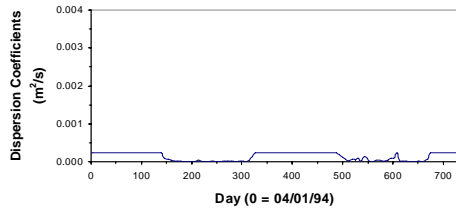

Vertical Dispersion Coefficient Plot
Interface b/w segment 21 and 30

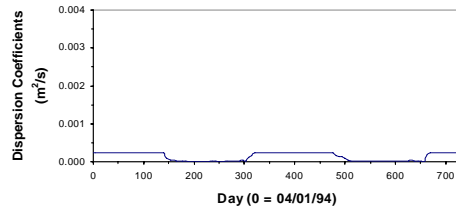

Vertical Dispersion Coefficient Plot
Interface b/w segment 22 and 31

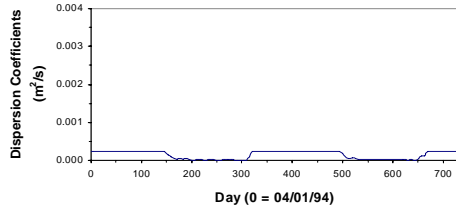

Vertical Dispersion Coefficient Plot
Interface b/w segment 23 and 32

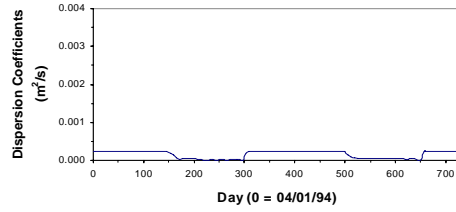

Vertical Dispersion Coefficient Plot
Interface b/w segment 24 and 33

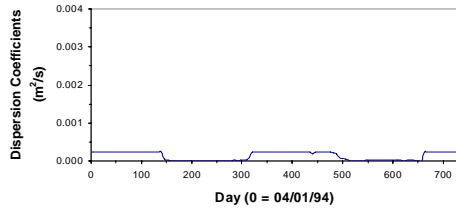

Vertical Dispersion Coefficient Plot
Interface b/w segment 25 and 34

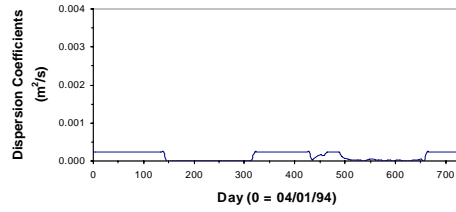

Vertical Dispersion Coefficient Plot
Interface b/w segment 26 and 35

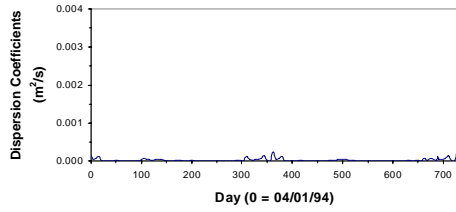

Vertical Dispersion Coefficient

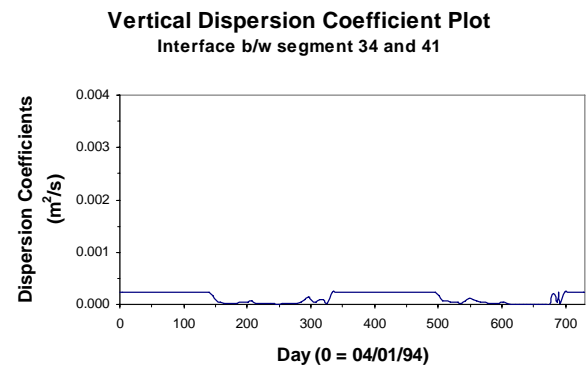
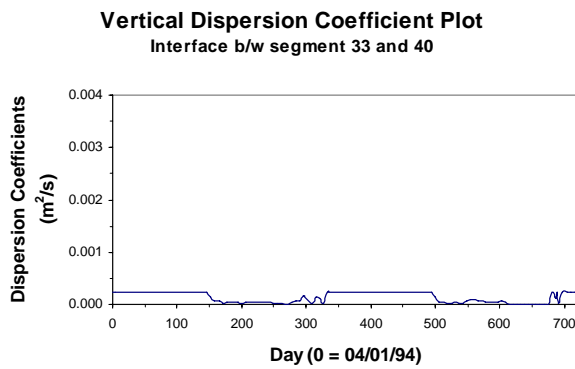
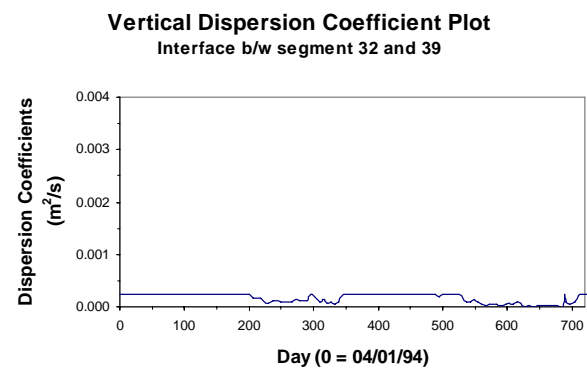
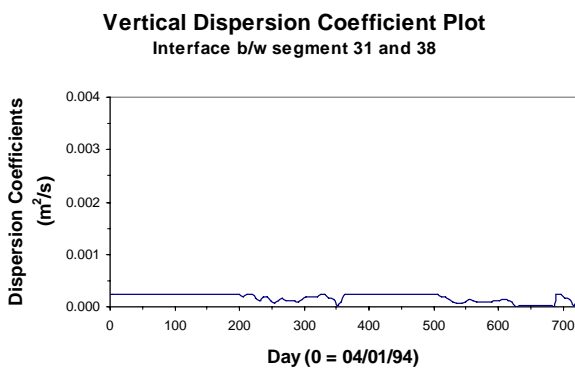
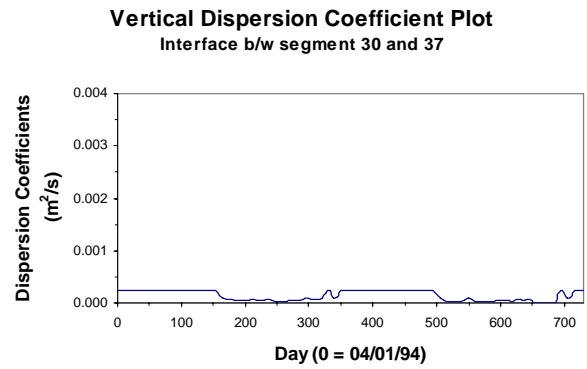
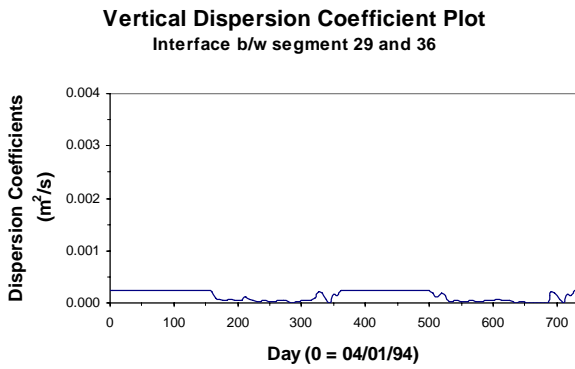

Vertical Dispersion Coefficient

Appendix 4.5.2
Calibrated Results for Organic Carbons

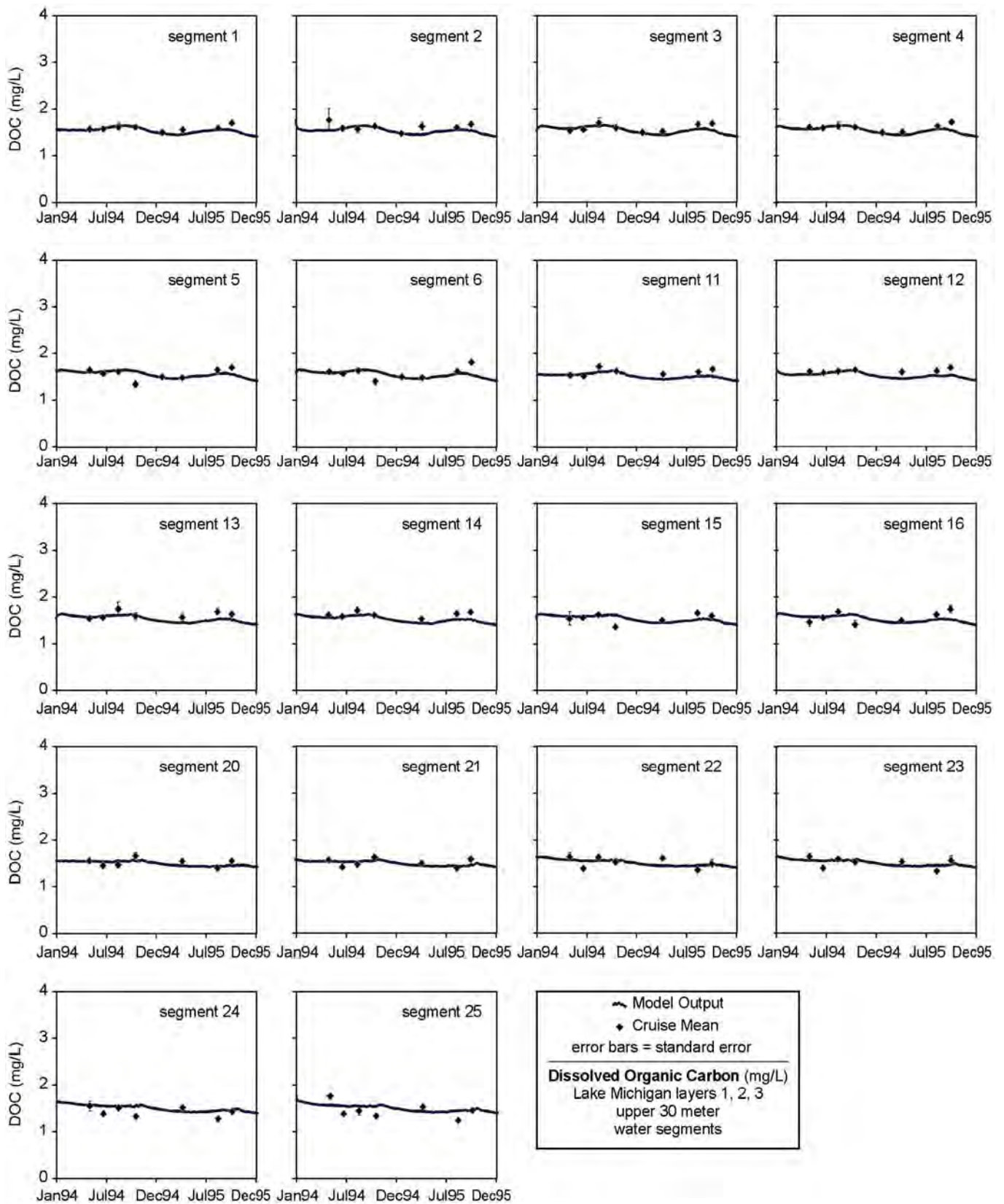

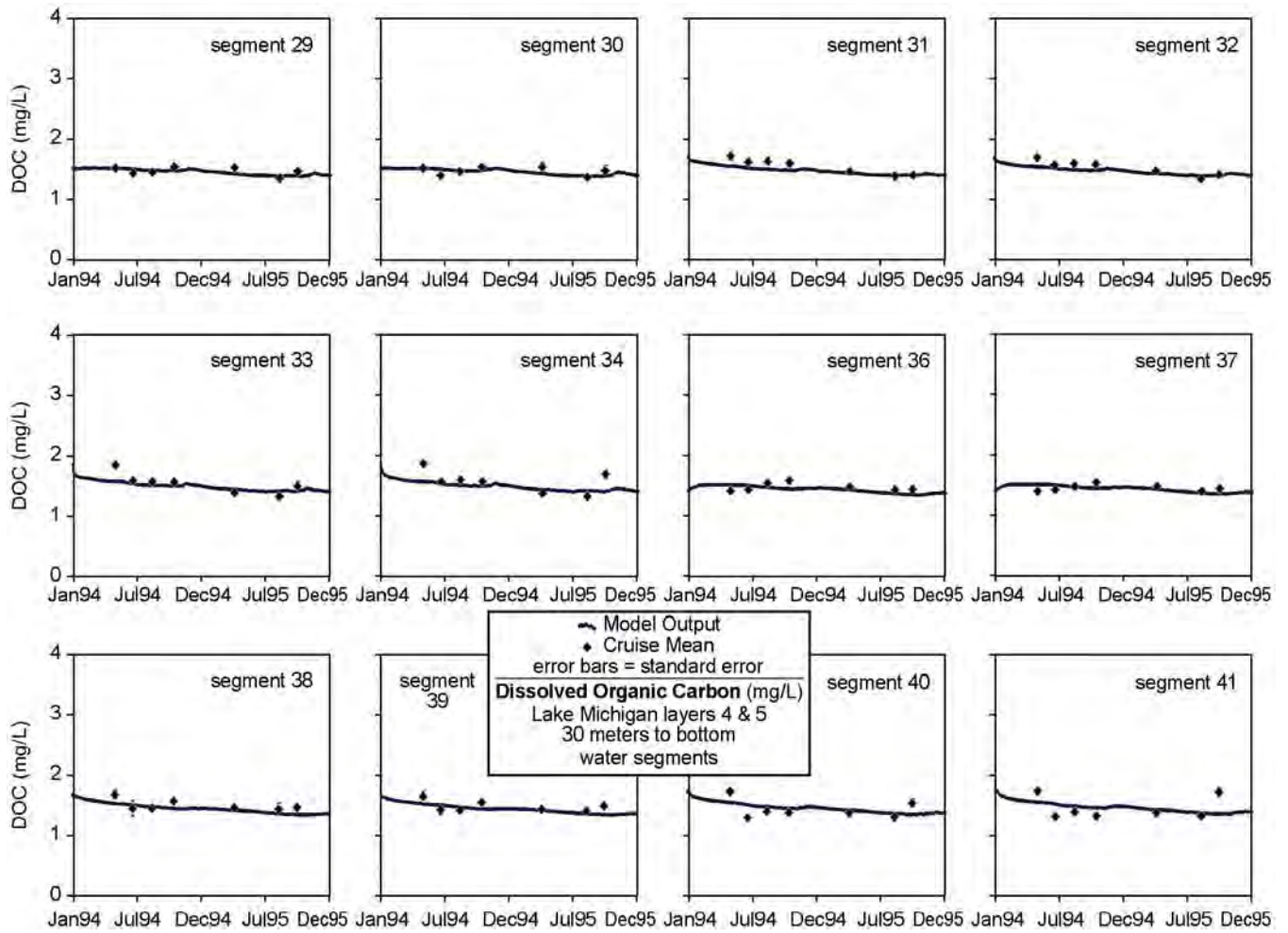

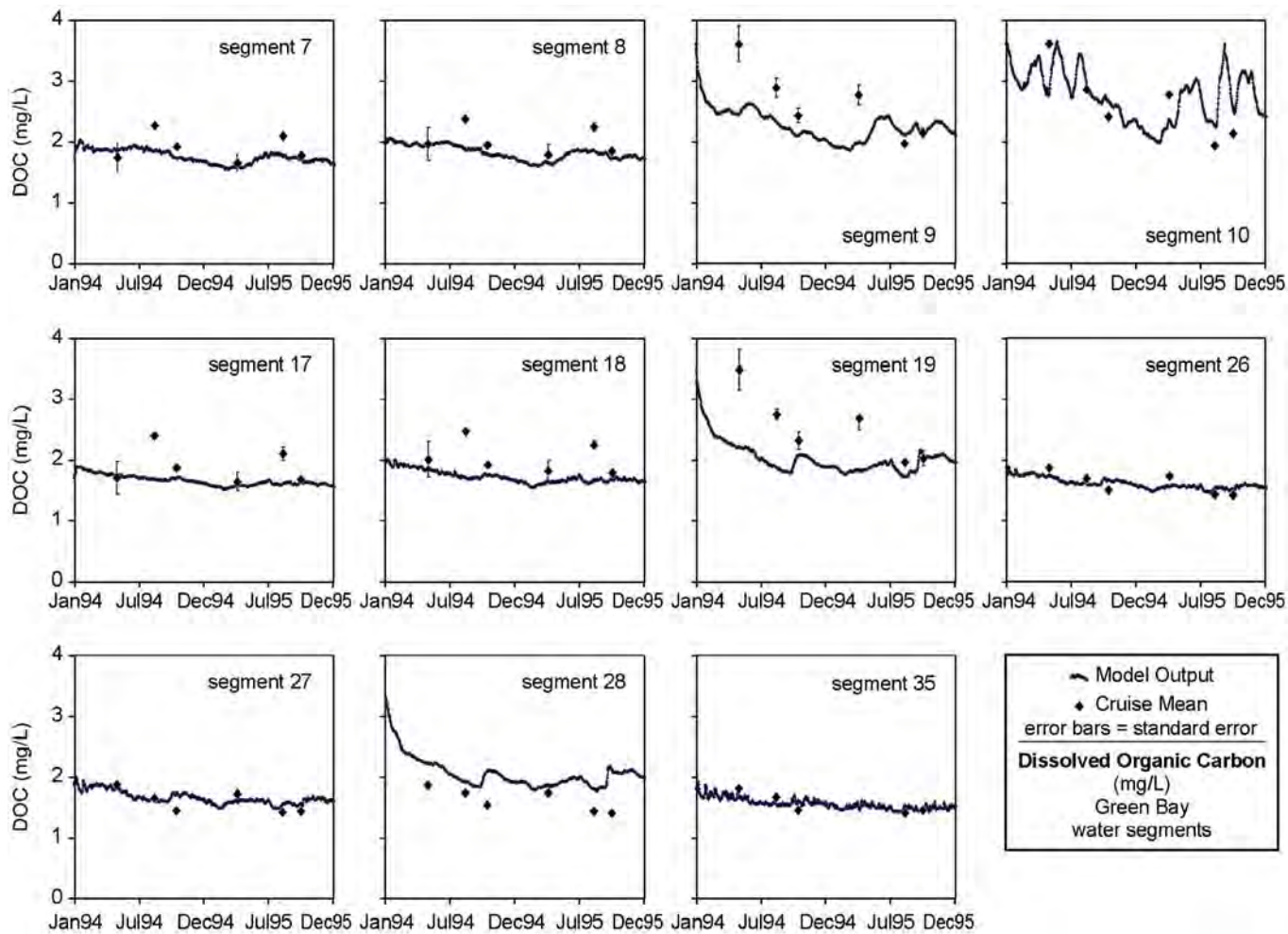

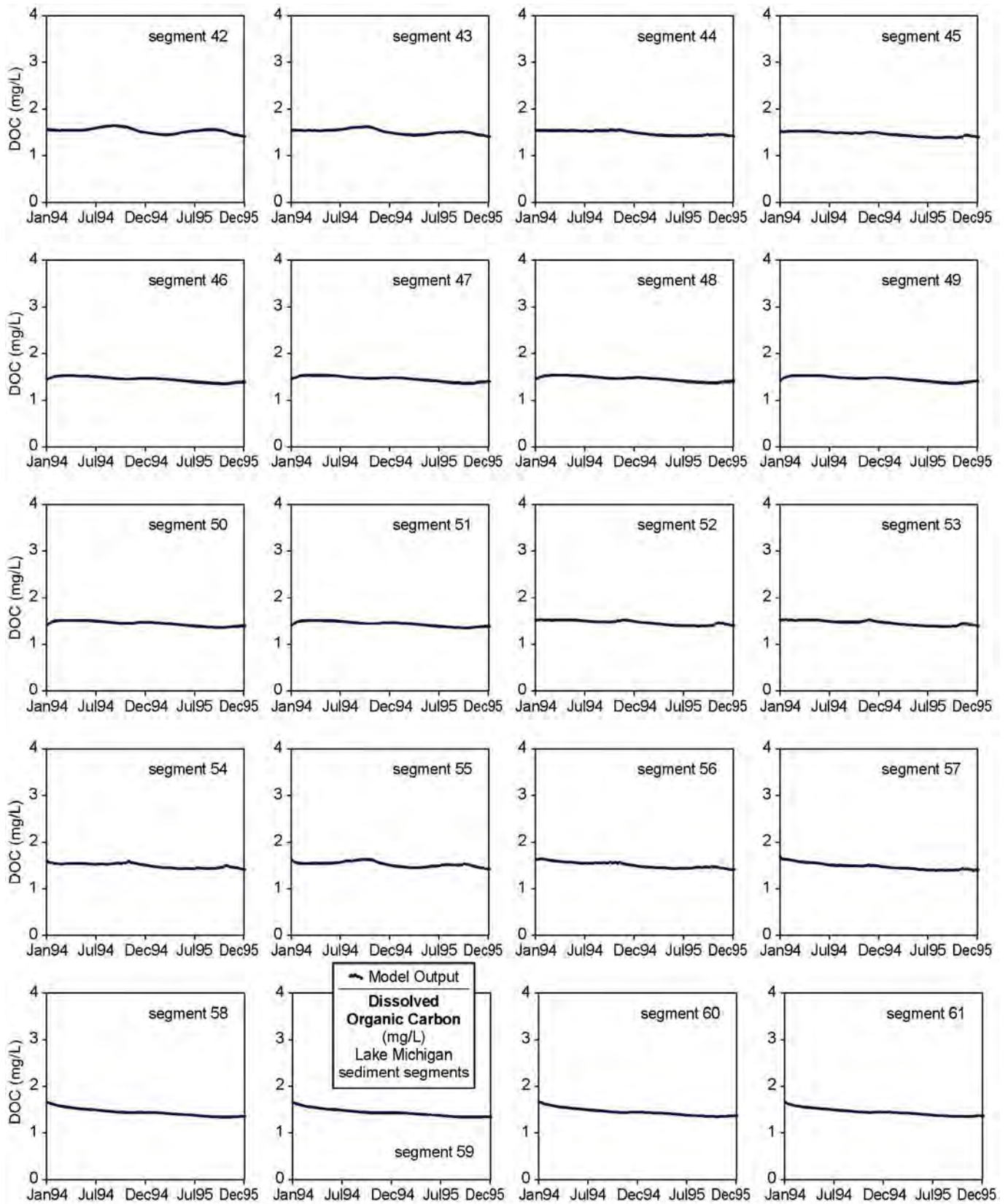

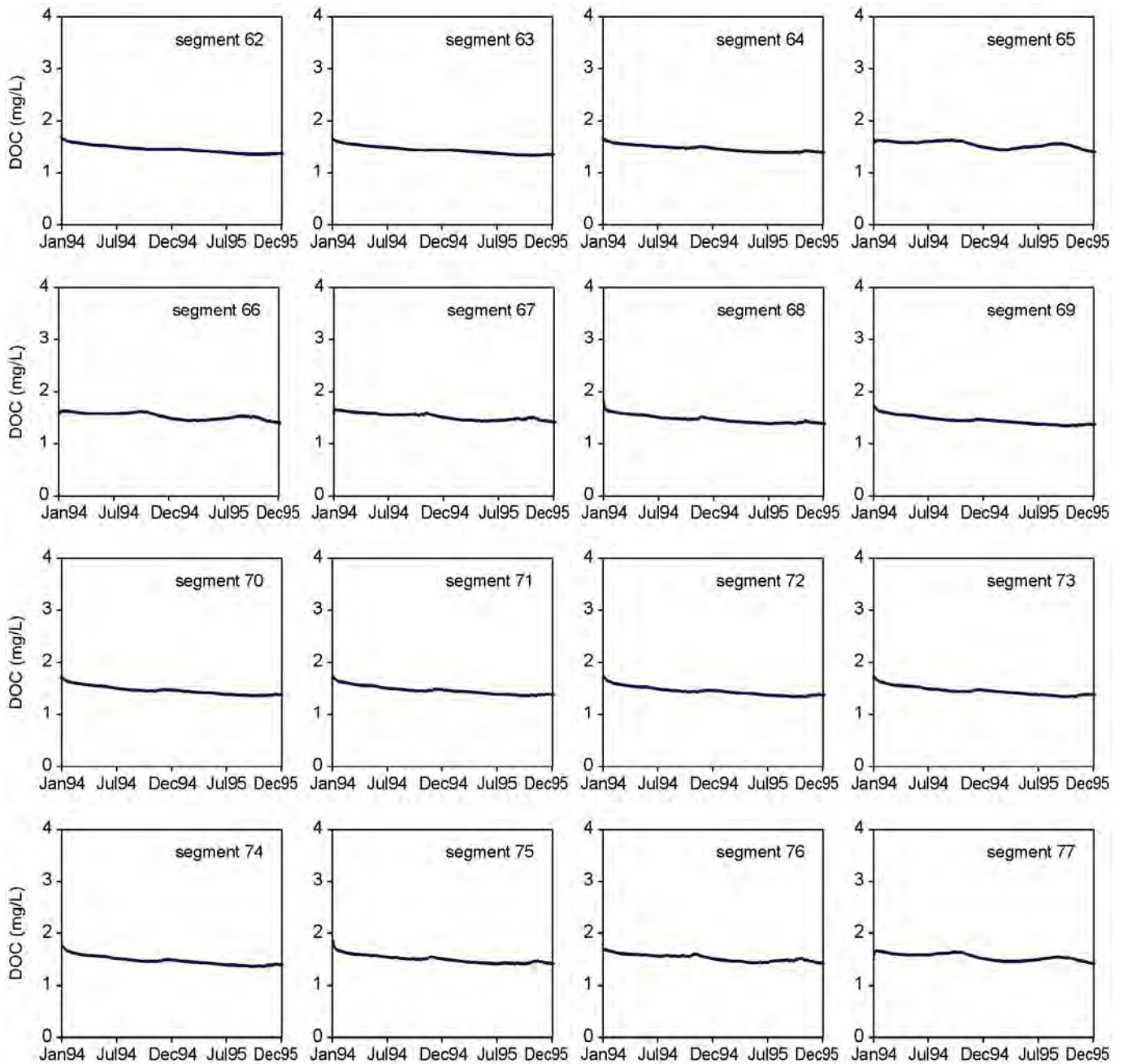

 Model Output
Dissolved Organic Carbon
 (mg/L)
 Lake Michigan
 sediment segments

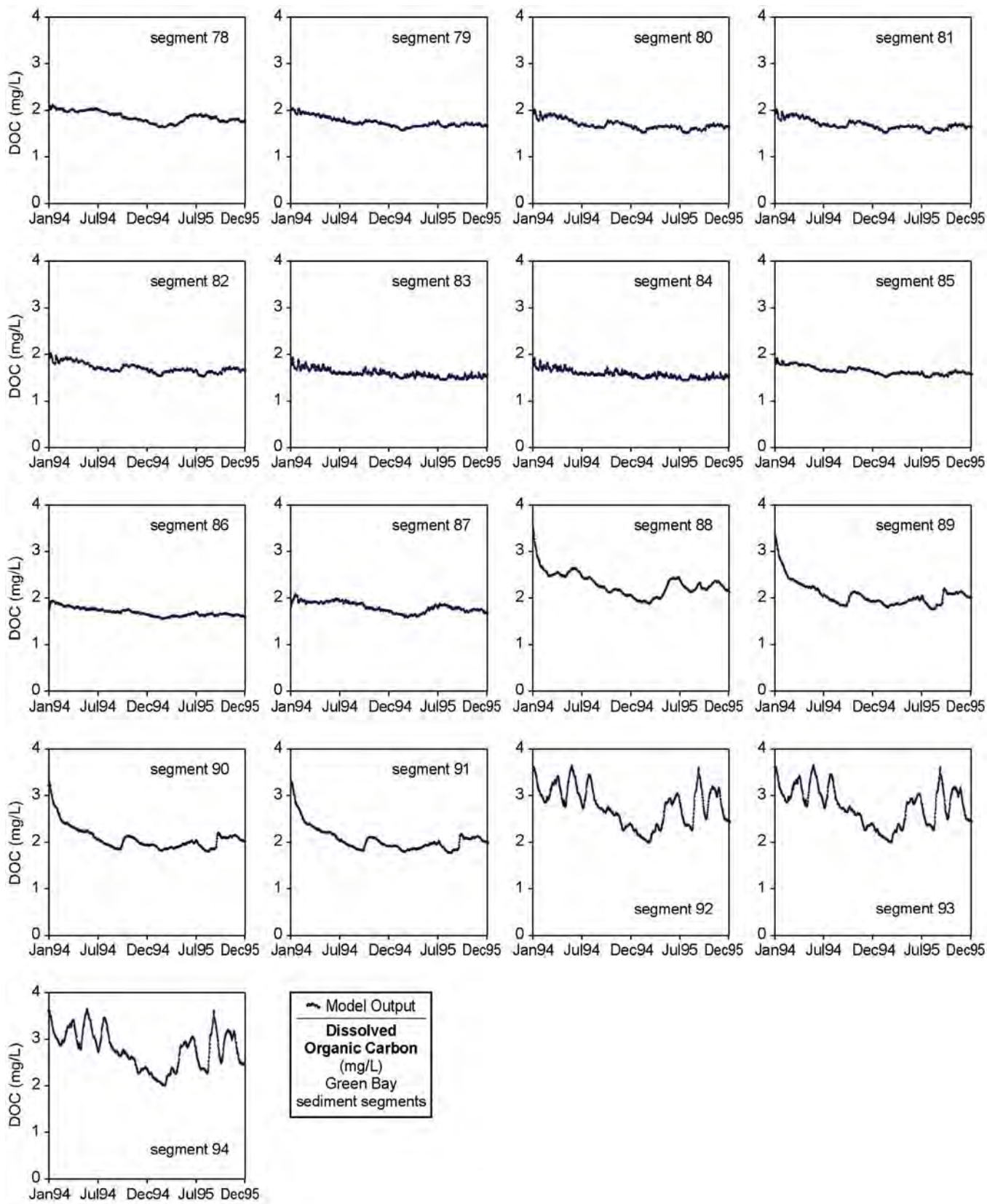

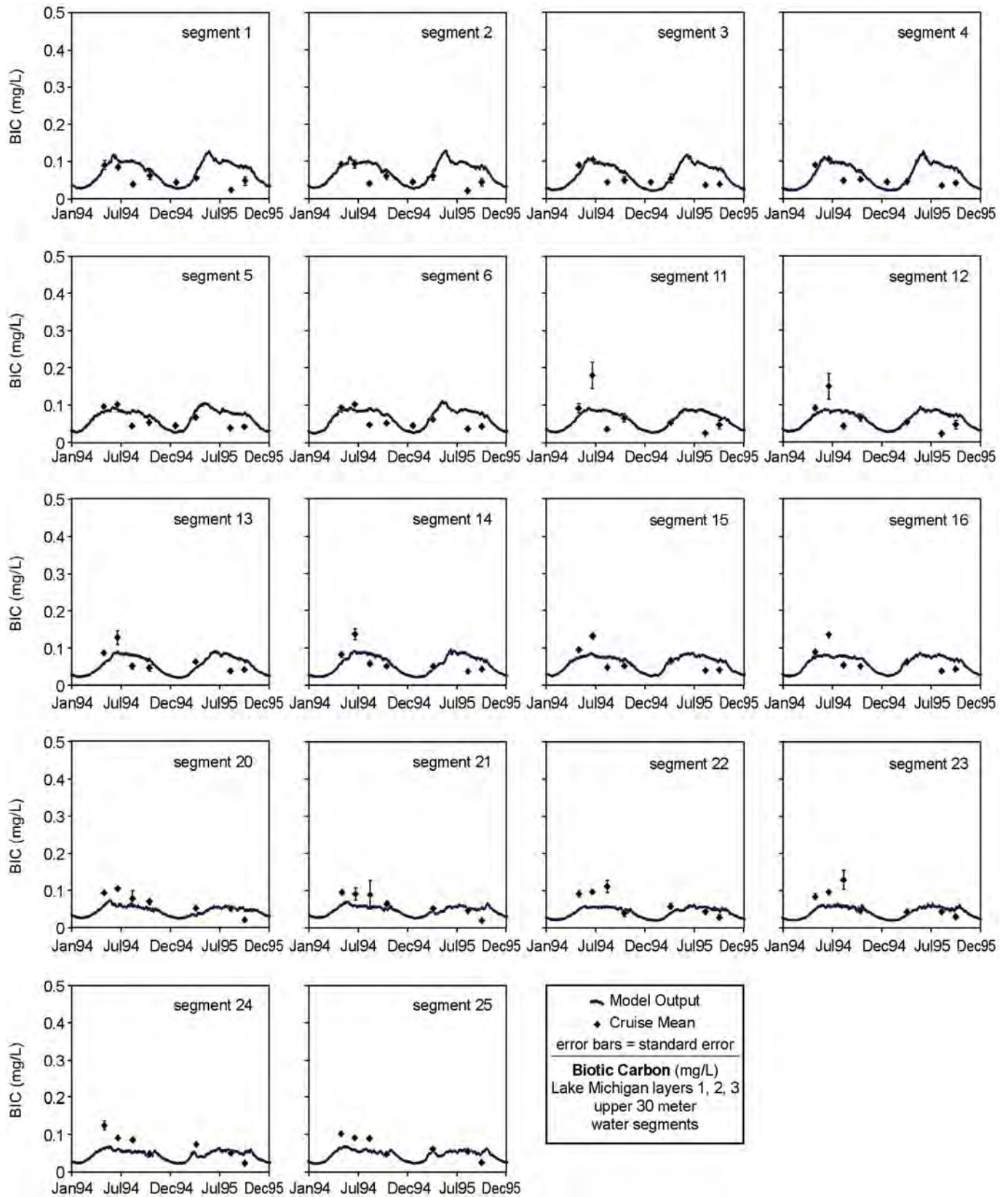

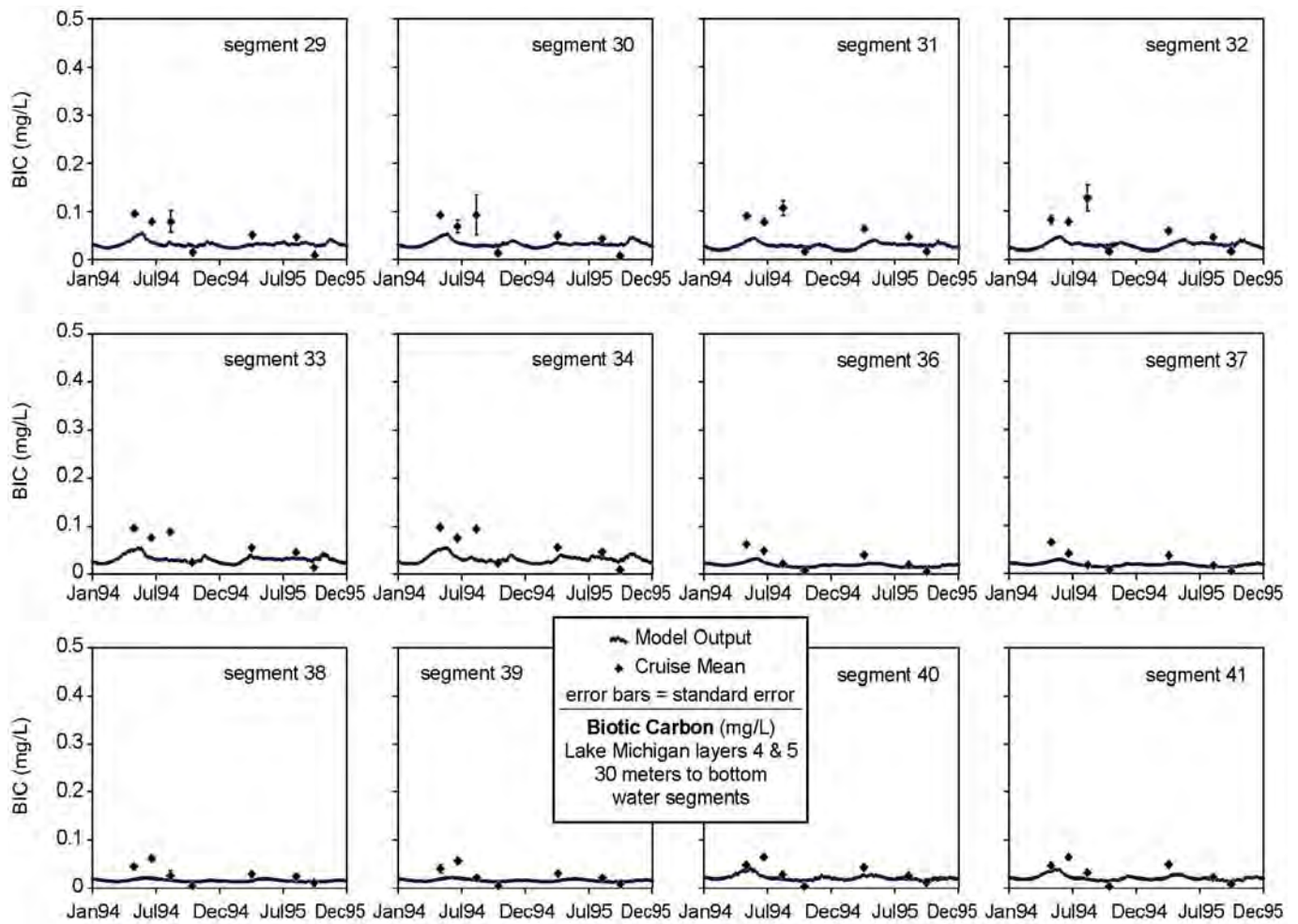

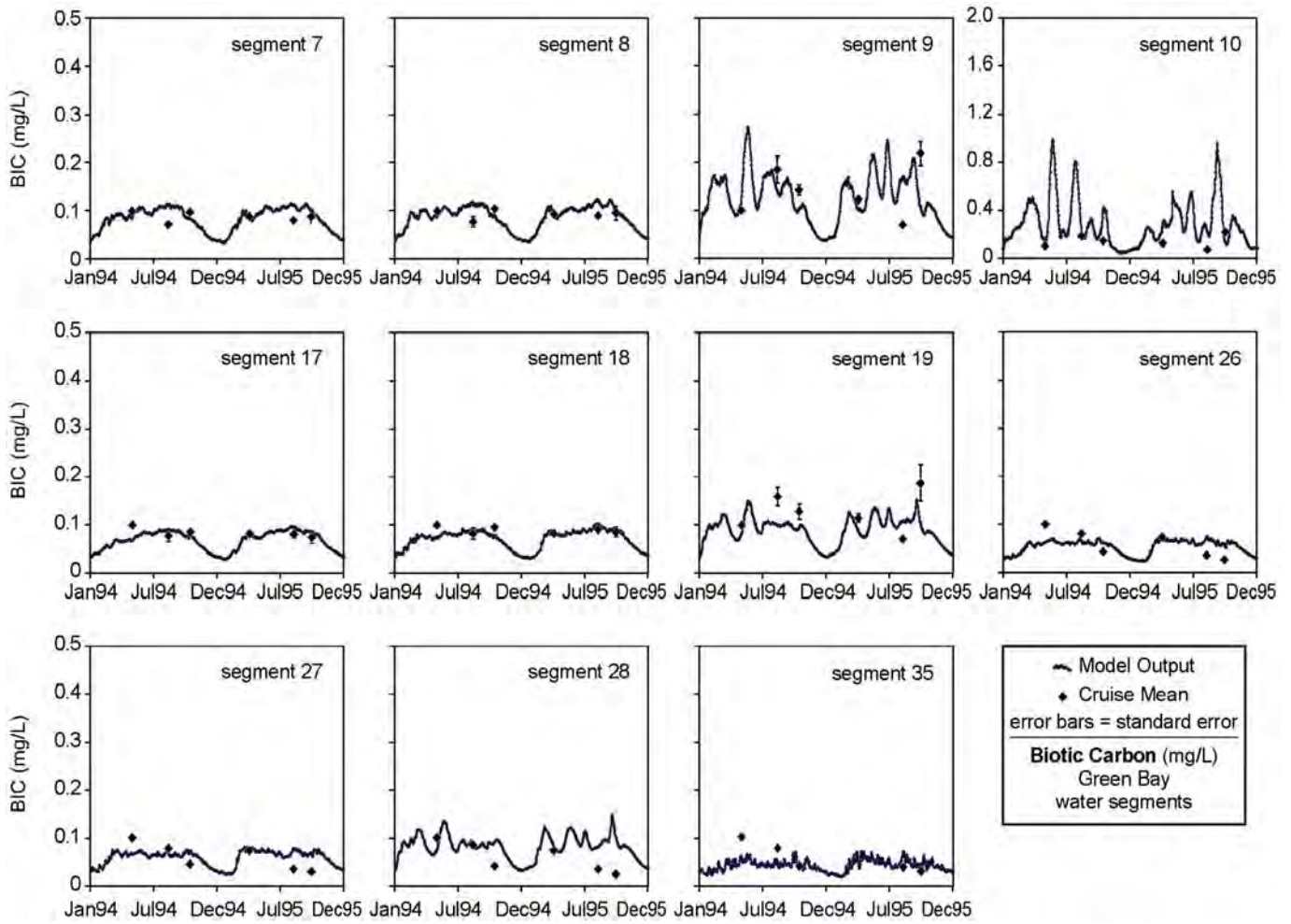

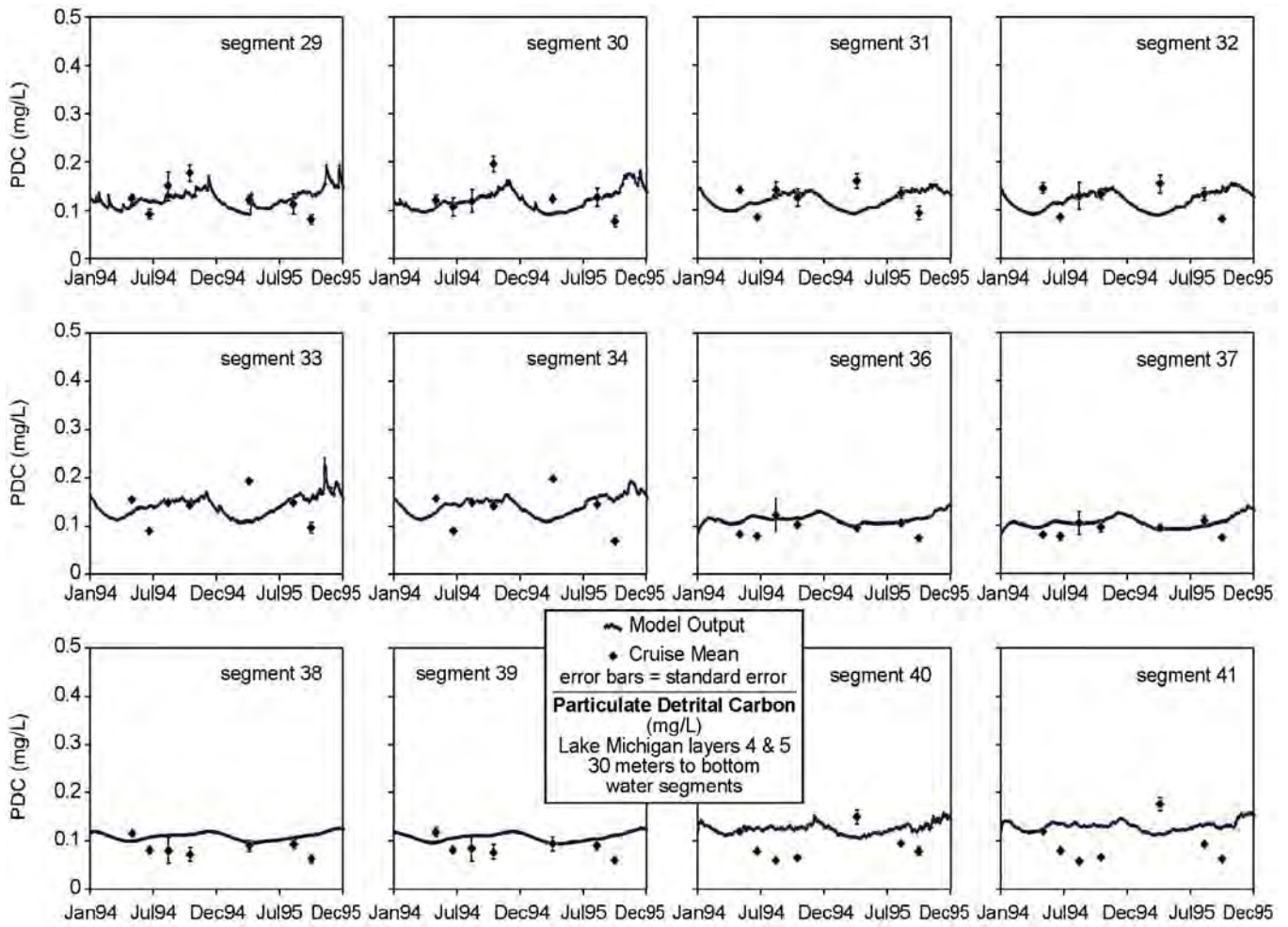

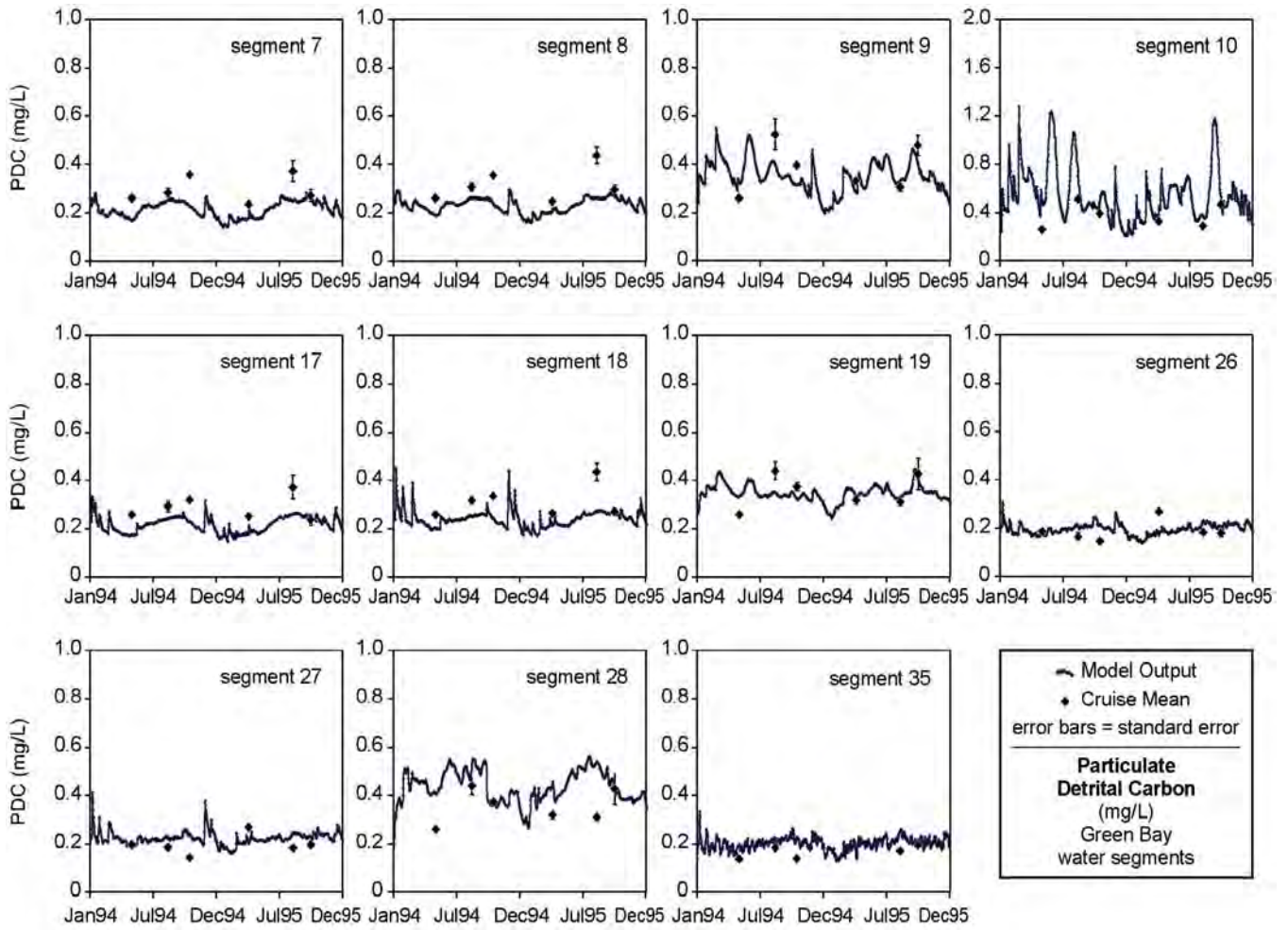

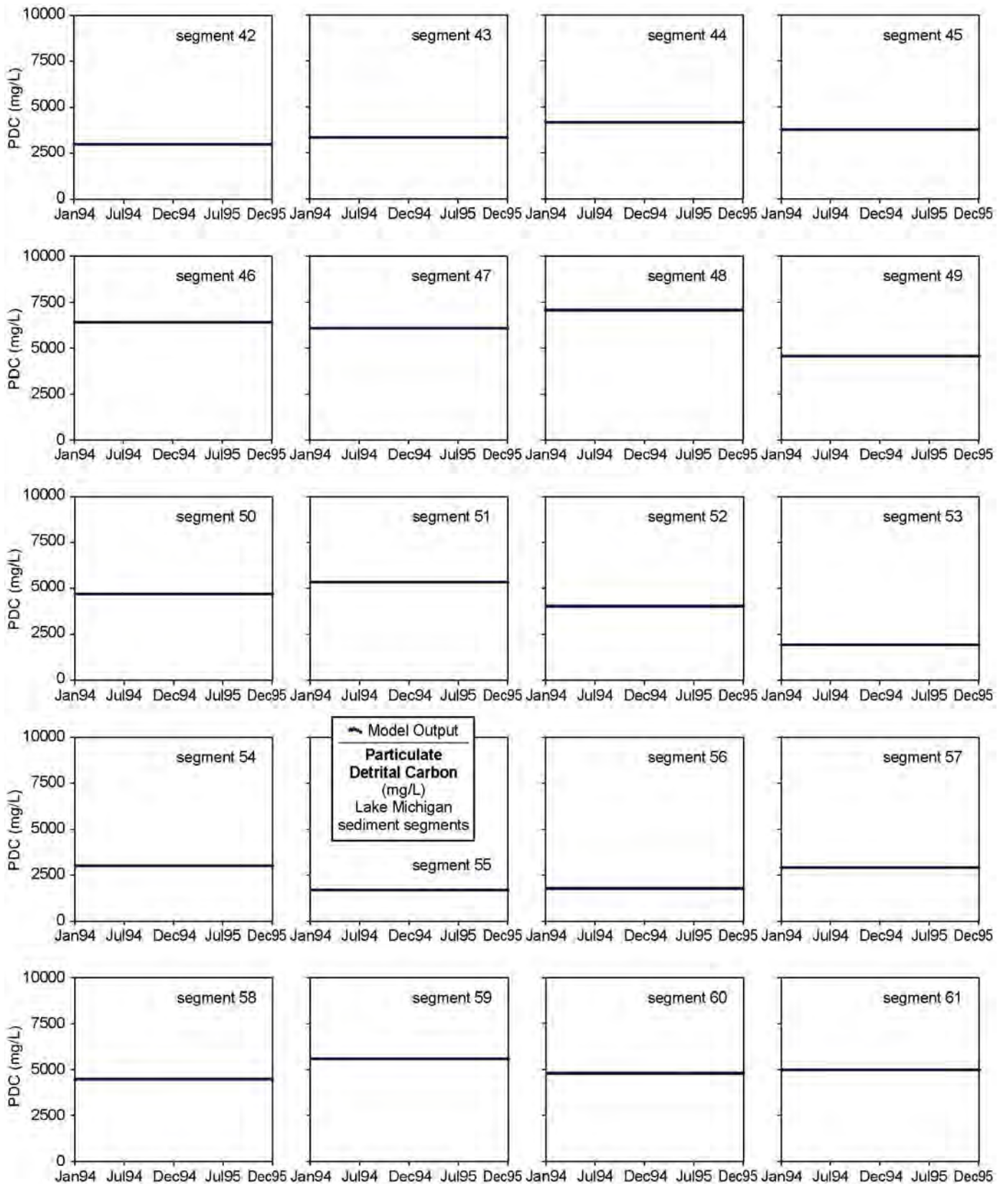

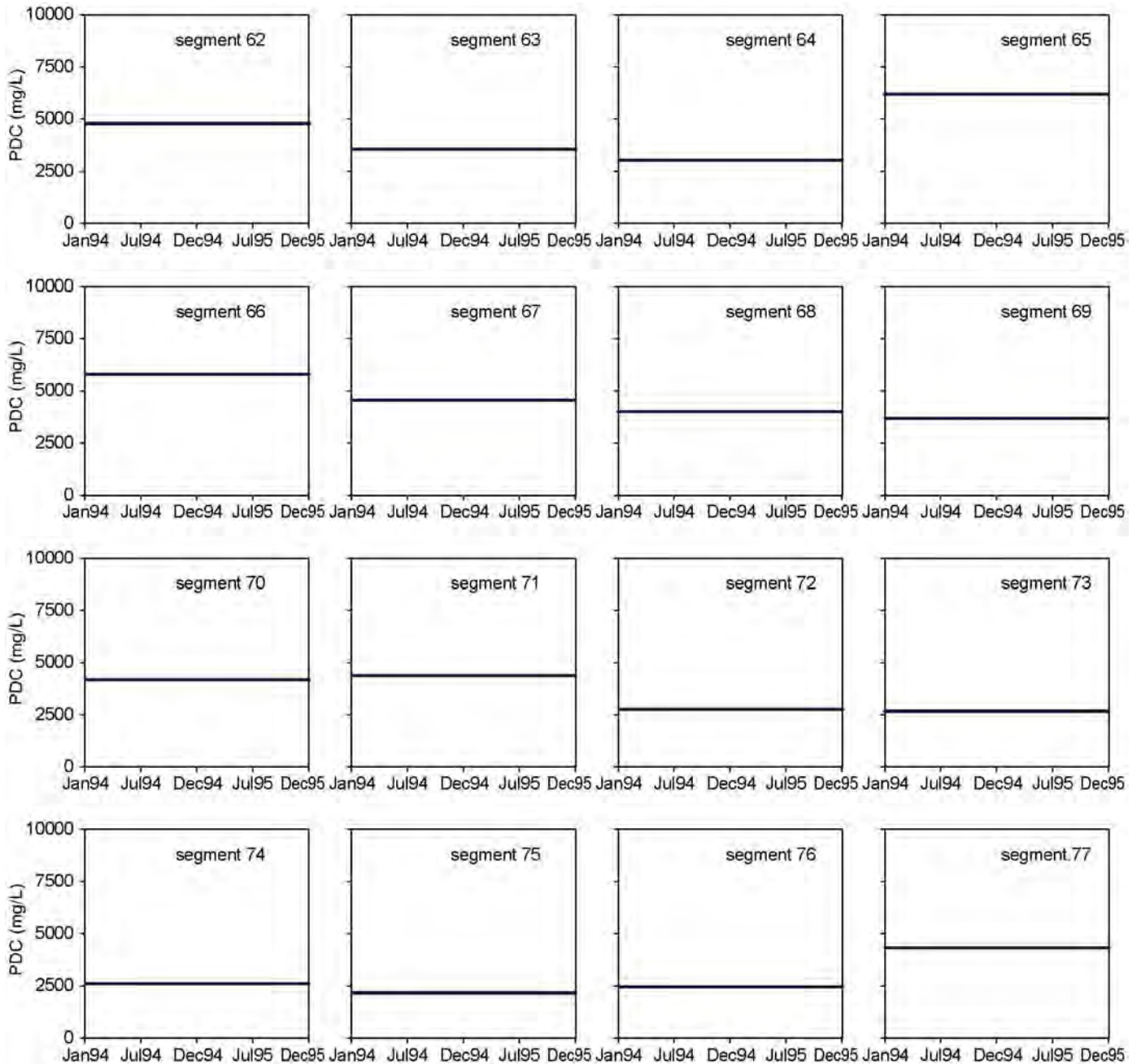



 Model Output
**Particulate
 Detrital Carbon**
 (mg/L)
 Lake Michigan
 sediment segments

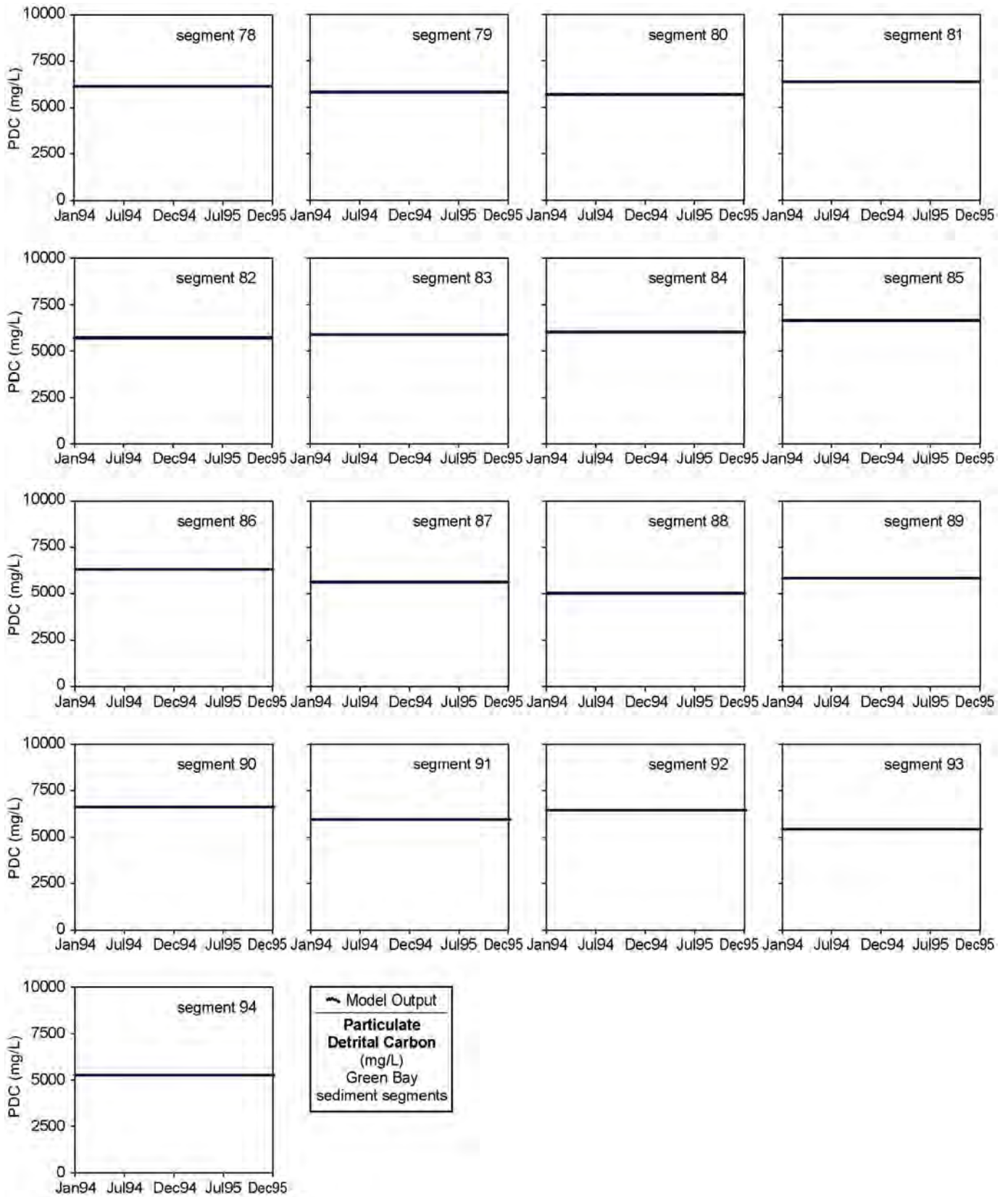

Appendix 4.5.3

Calibration Results for PCB₂₈₊₃₁ and ΣPCBs

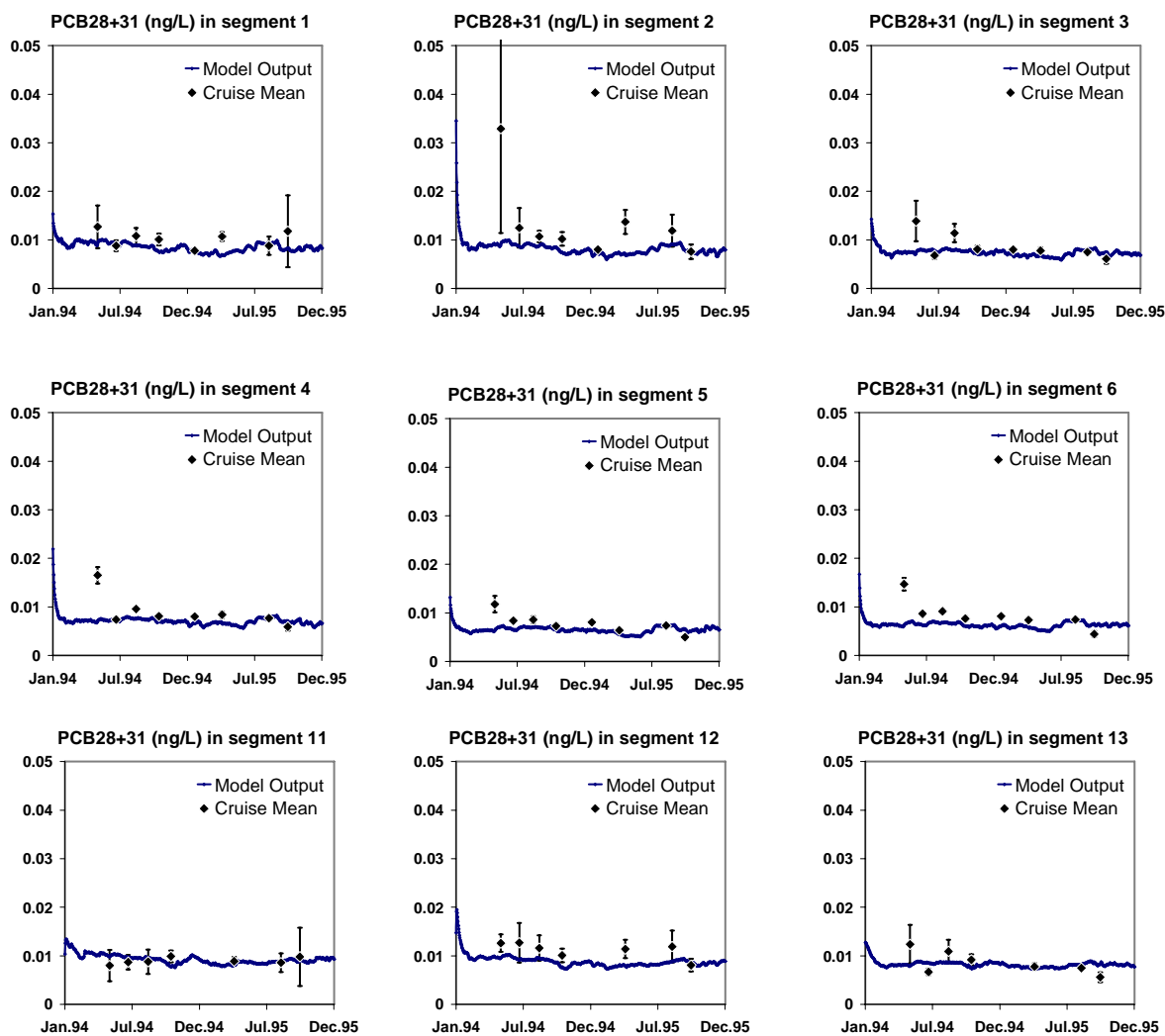

PCB_{28+31} in dissolved phase (ng/L)
 Lake Michigan layers 1, 2, and 3
 Upper 30 m water segments
 Error bars = standard error

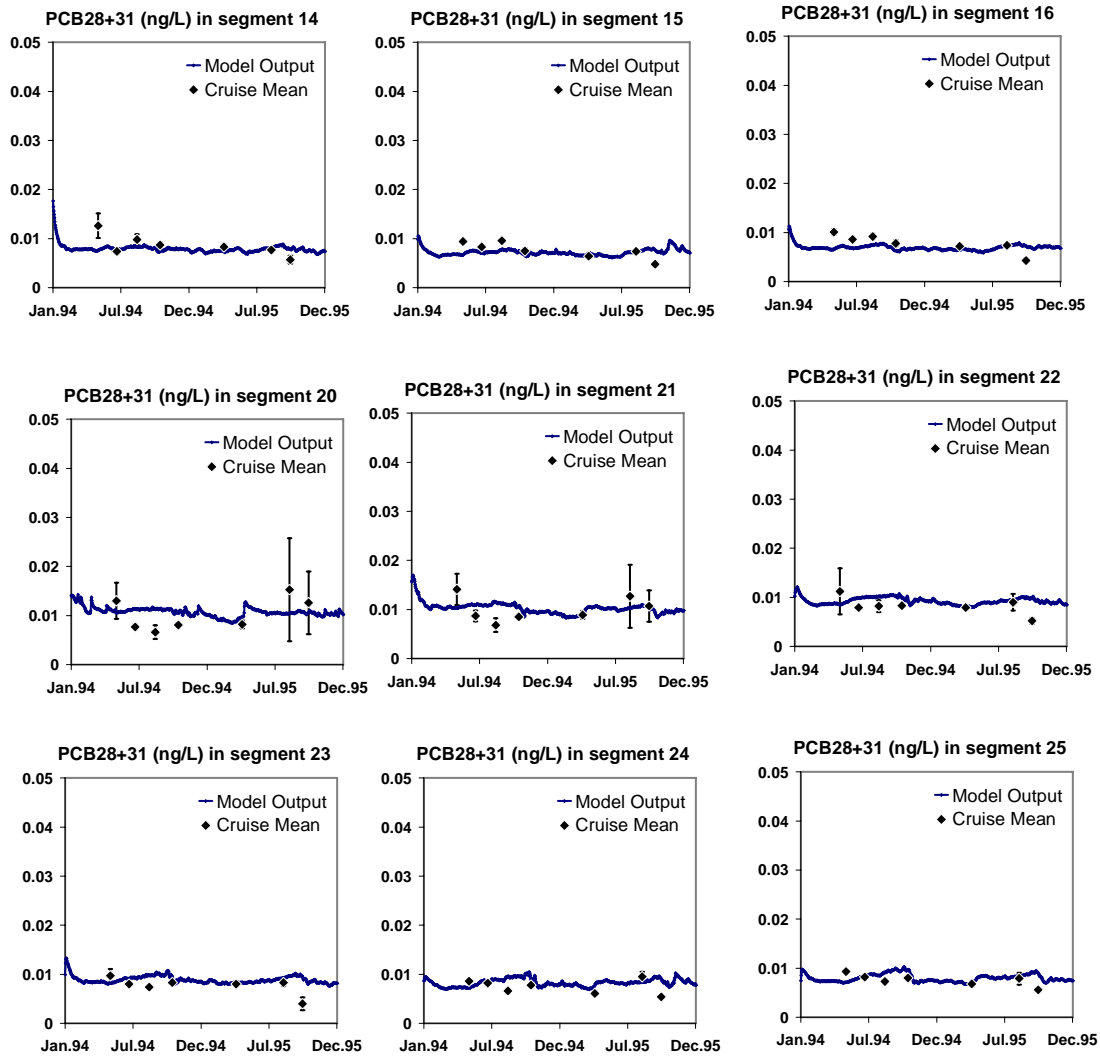

PCB₂₈₊₃₁ in dissolved phase (ng/L)
 Lake Michigan layers 1, 2, and 3
 Upper 30 m water segments
 Error bars = standard error

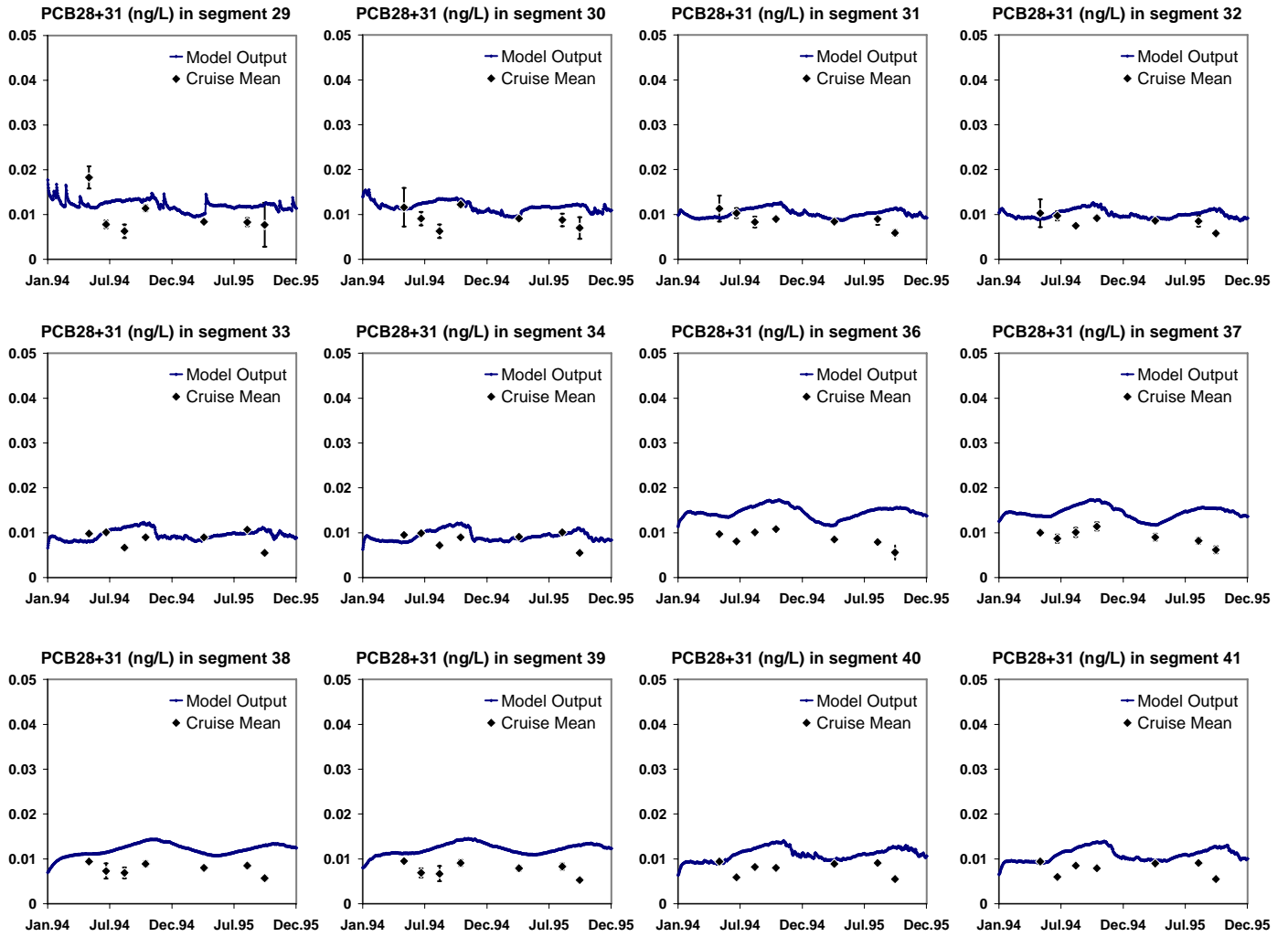

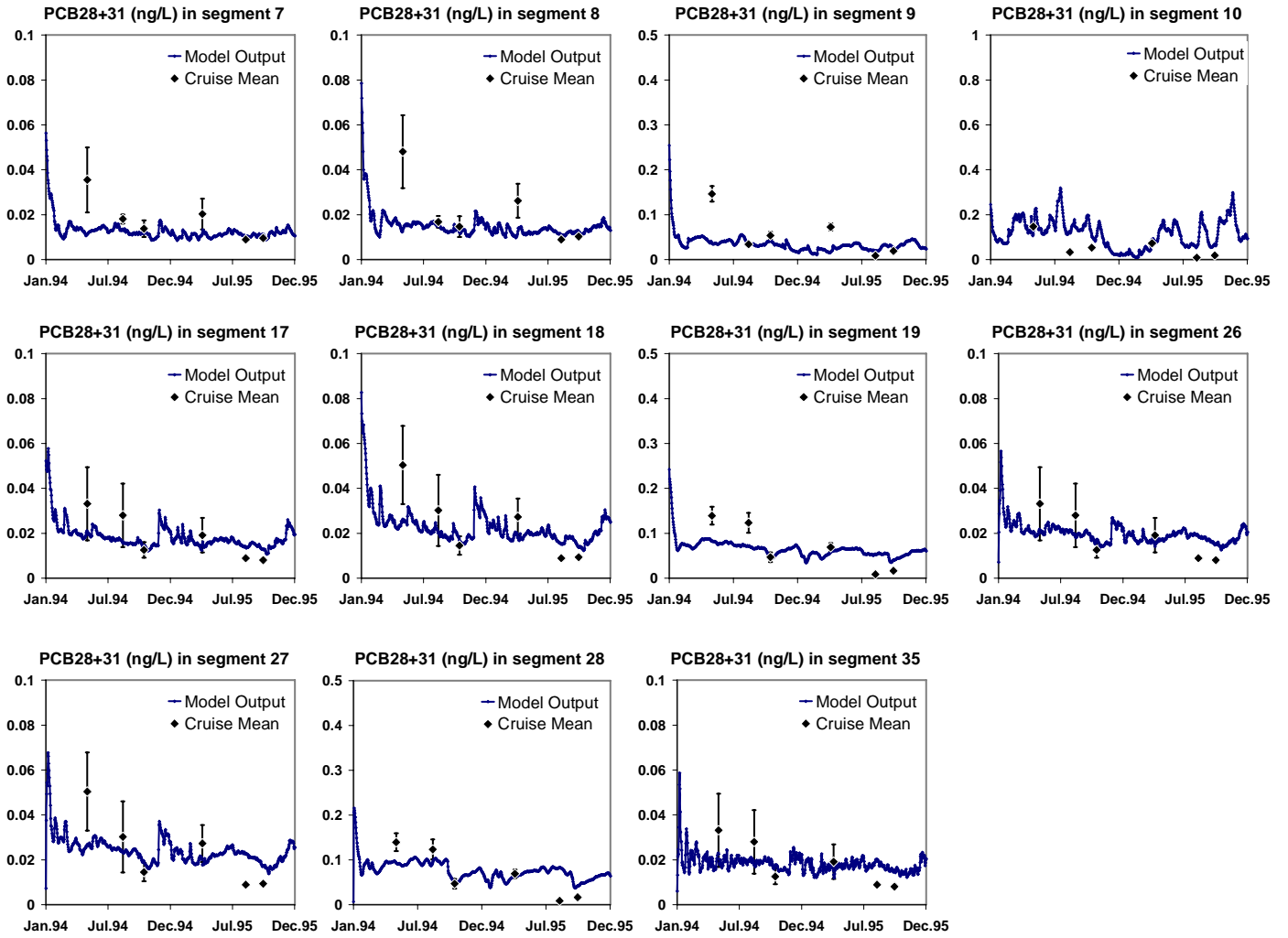

PCB_{28+31} in dissolved phase (ng/L)
 Lake Michigan layers 4 and 5
 30 m to bottom water segments
 Error bars = standard error

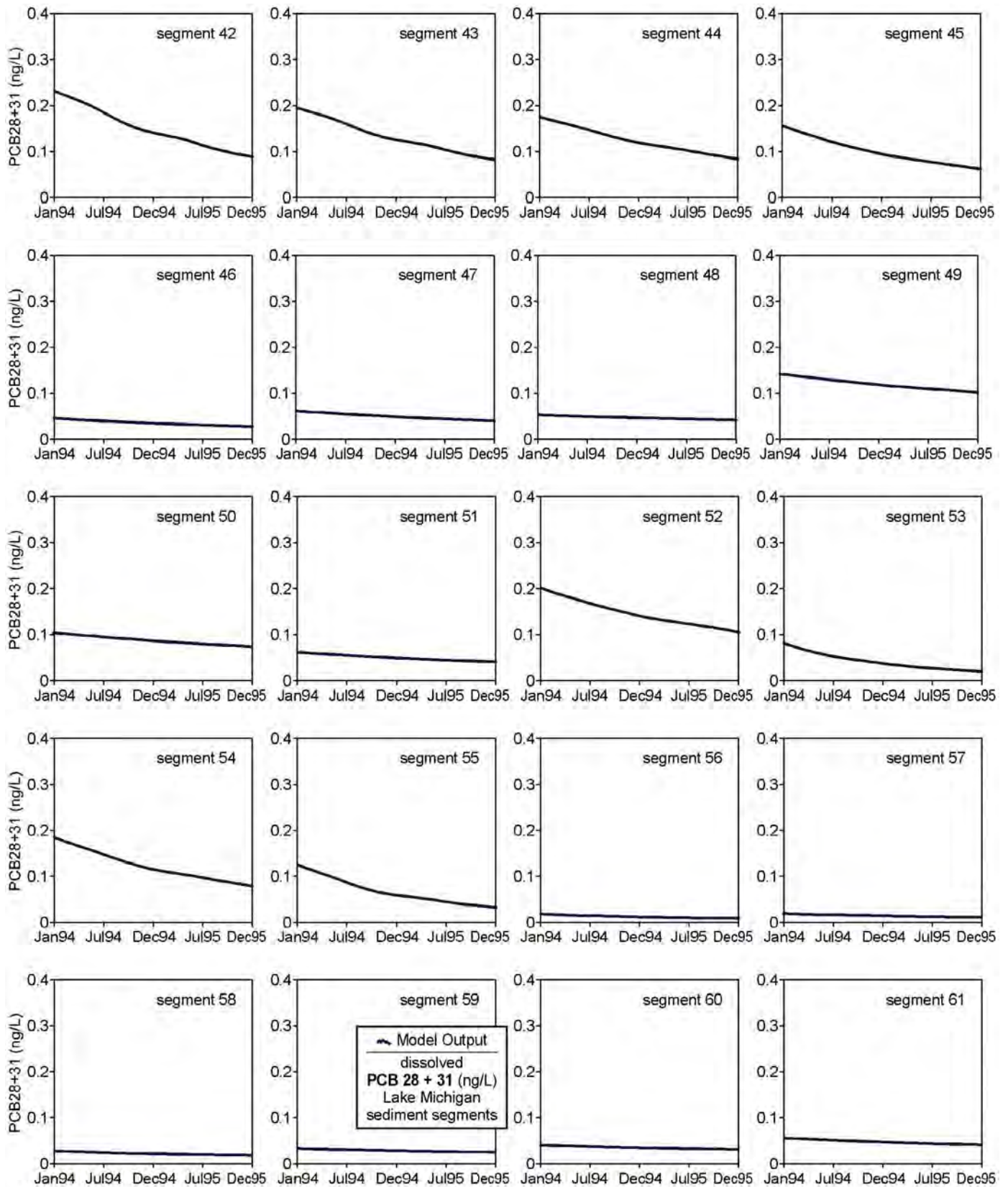

PCB₂₈₊₃₁ in dissolved phase (ng/L)
 Green Bay water segments
 Error bars = standard error

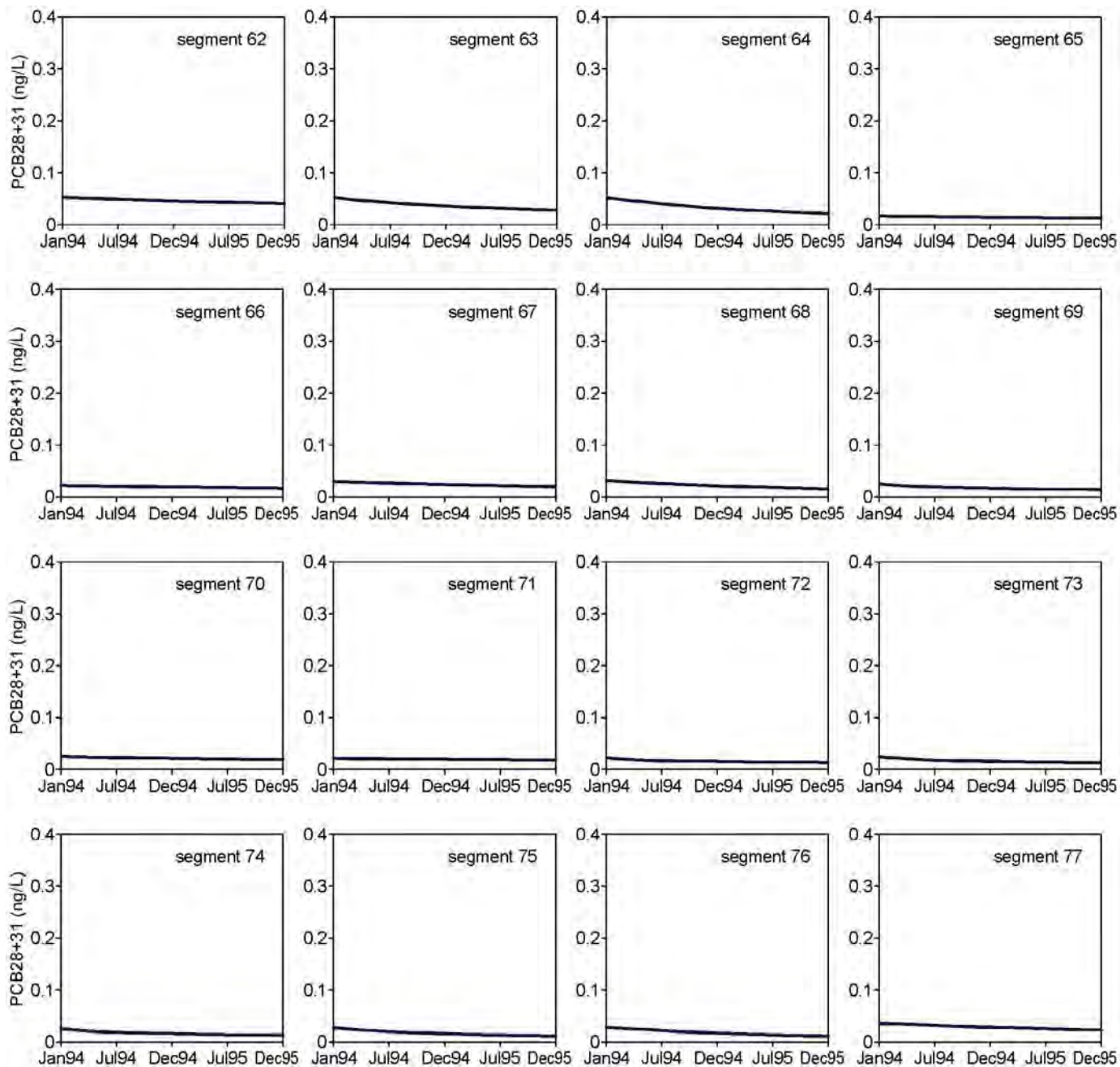



 Model Output
 dissolved
PCB 28 + 31 (ng/L)
 Lake Michigan
 sediment segments

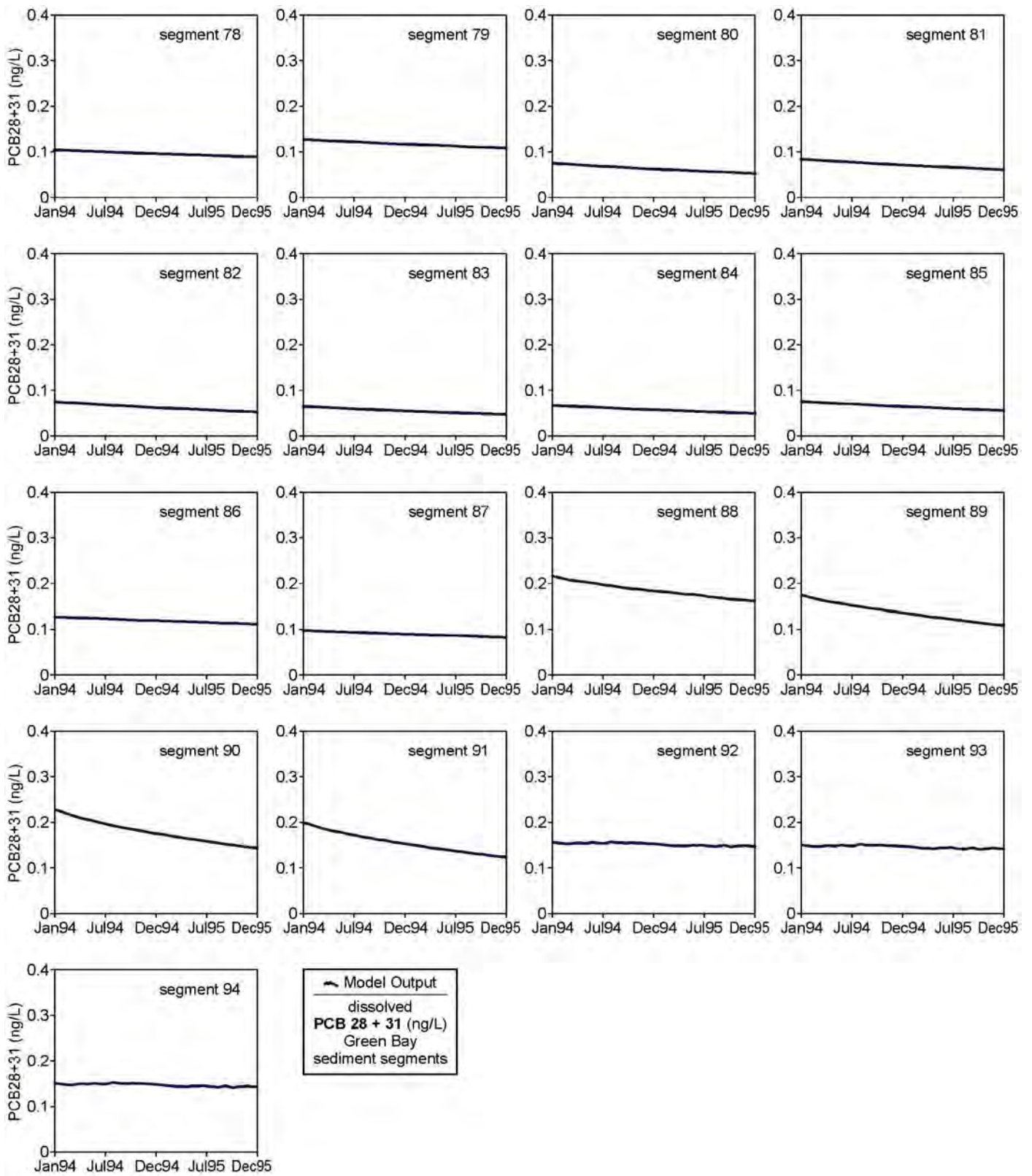

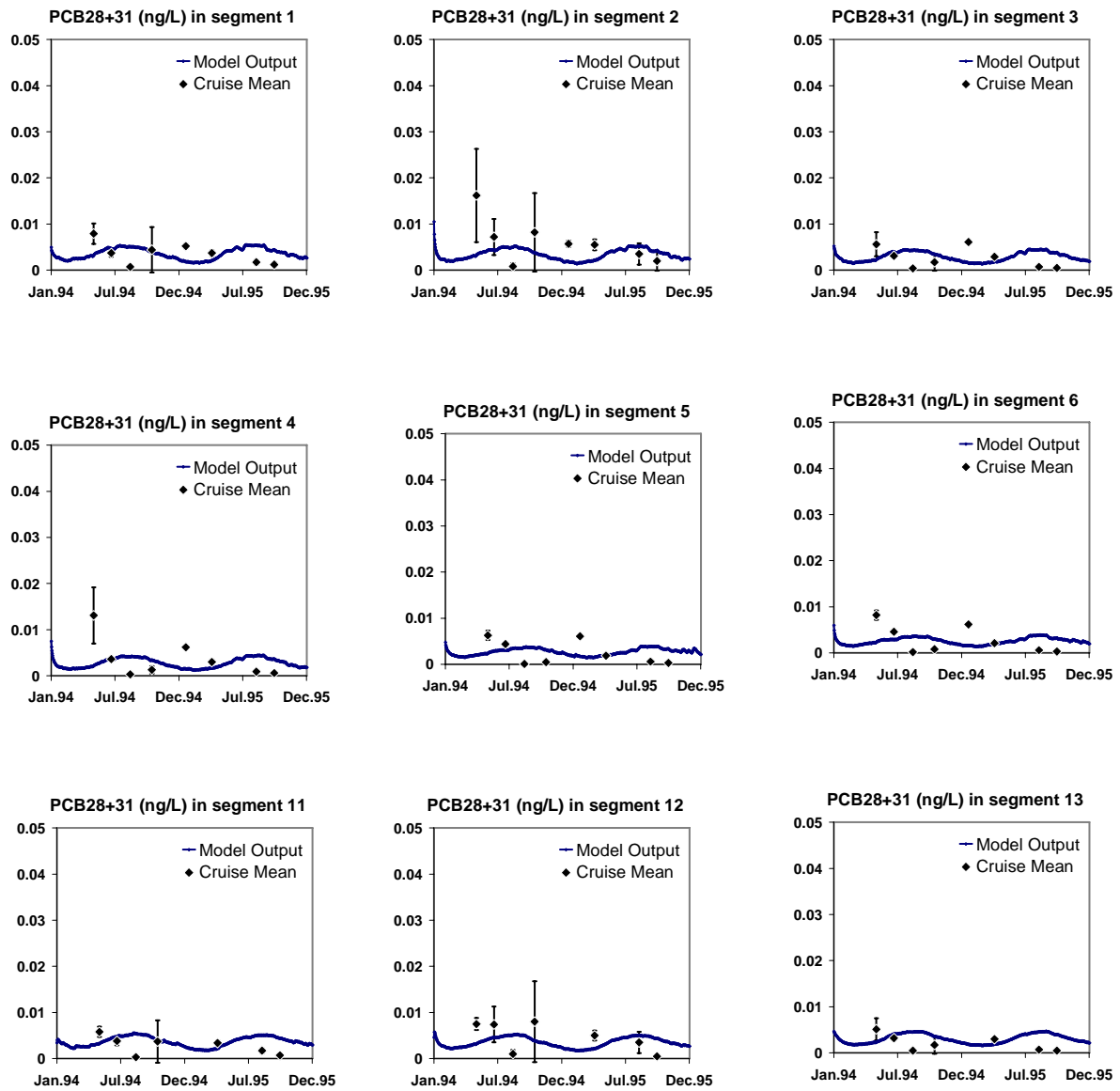

PCB₂₈₊₃₁ in particulate phase (ng/L)
 Lake Michigan layers 1, 2, and 3
 Upper 30 m water segments
 Error bars = standard error

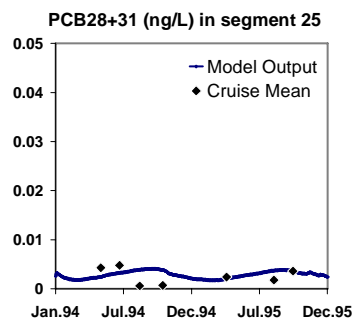
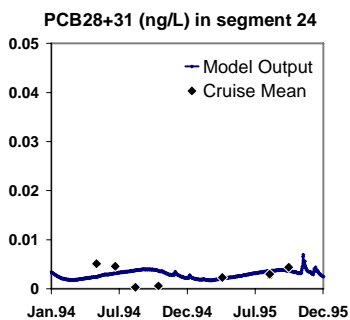
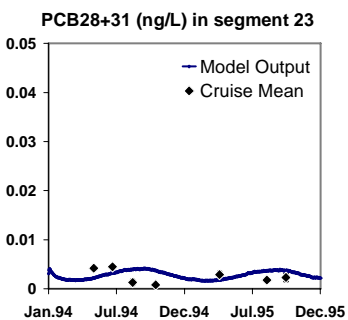
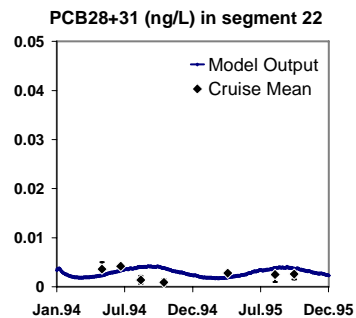
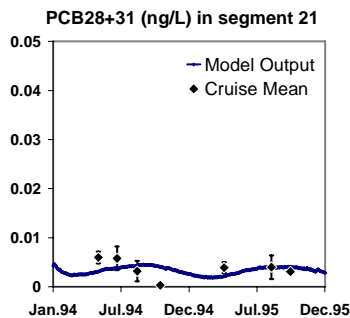
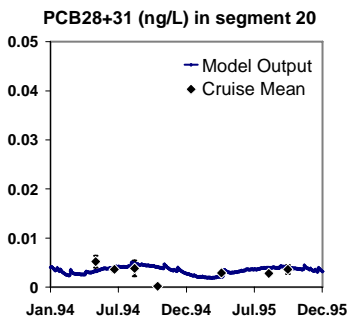
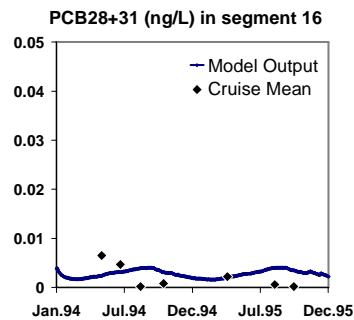
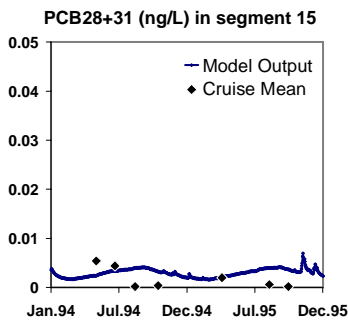
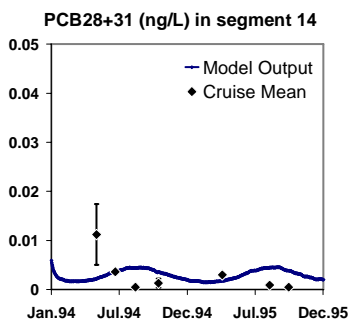

PCB_{28+31} in particulate phase (ng/L)
 Lake Michigan layers 1, 2, and 3
 Upper 30 m water segments
 Error bars = standard error

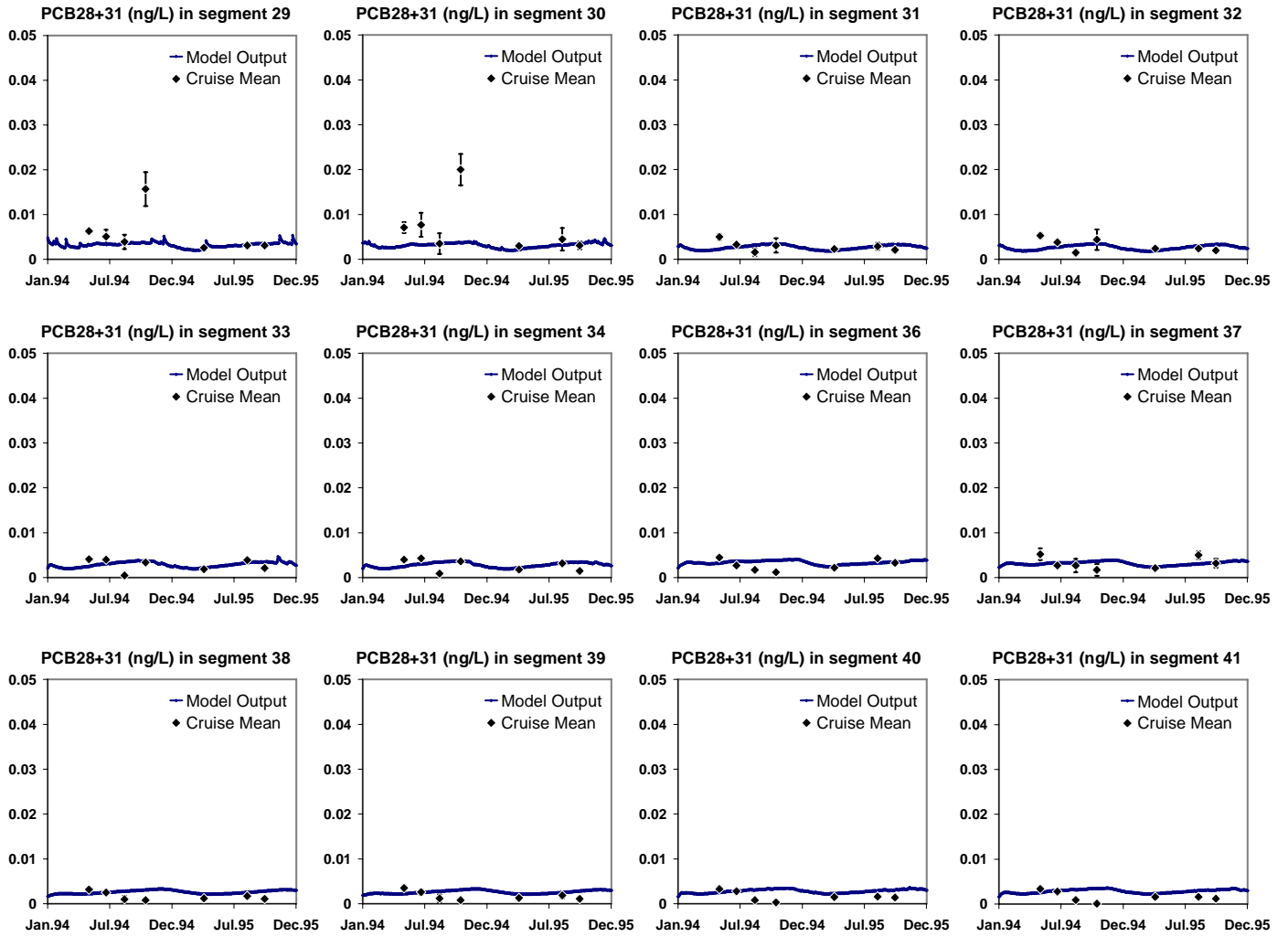

PCB₂₈₊₃₁ in particulate phase (ng/L)
 Lake Michigan layers 4 and 5
 30 m to bottom water segments
 Error bars = standard error

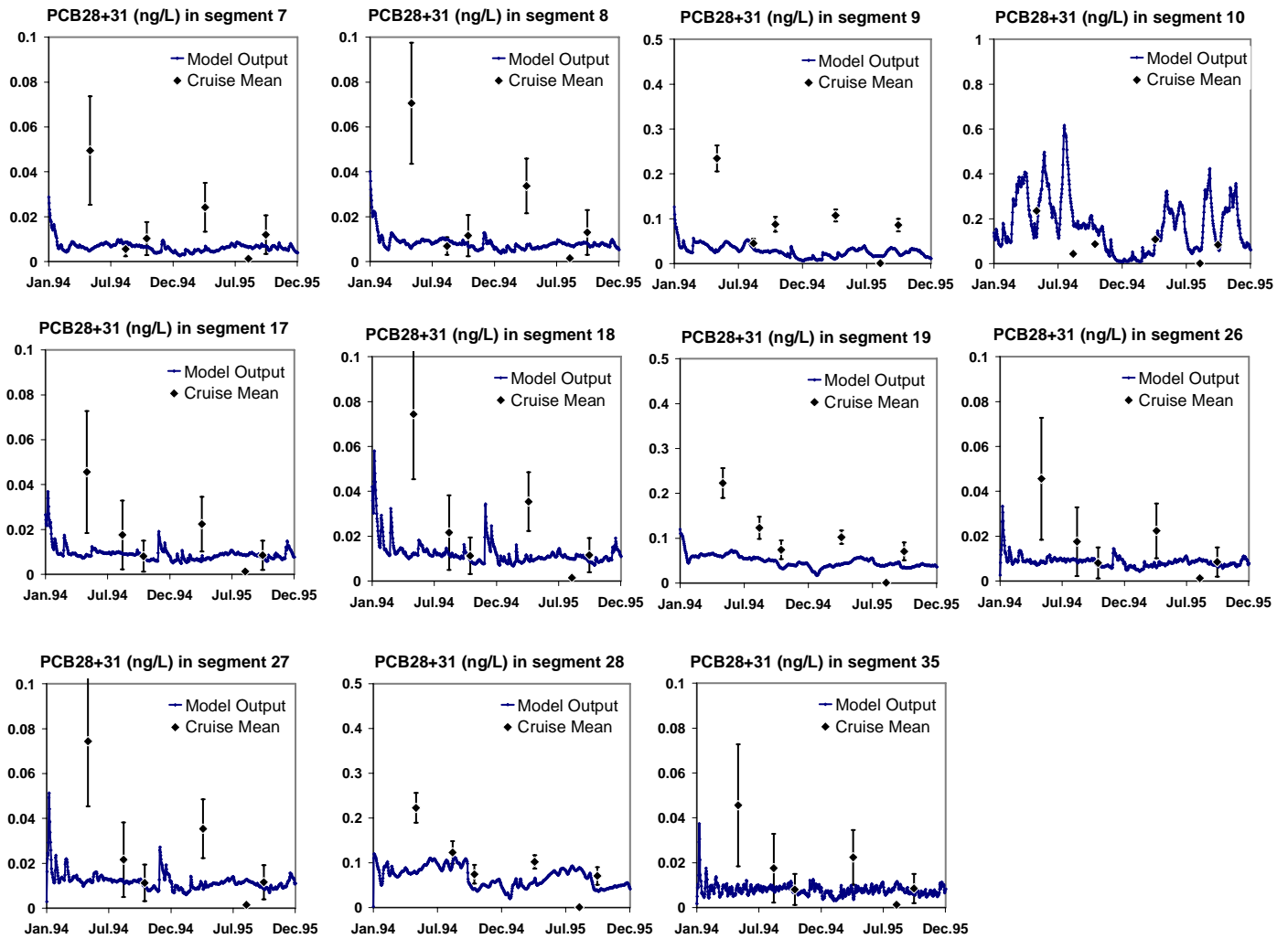

PCB₂₈₊₃₁ in particulate phase (ng/L)
 Green Bay water segments
 Error bars = standard error

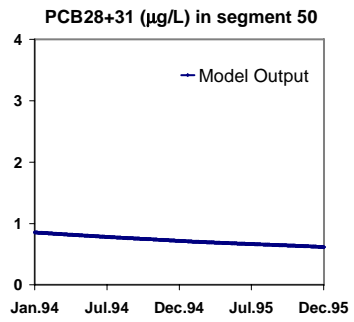
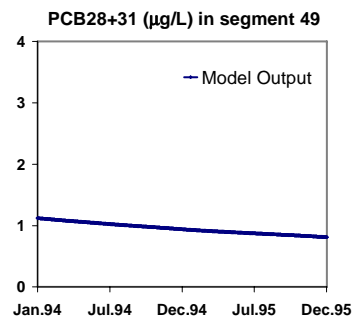
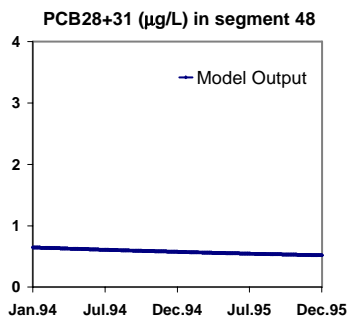
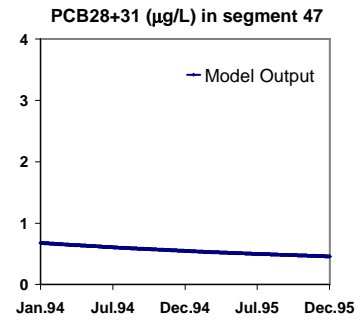
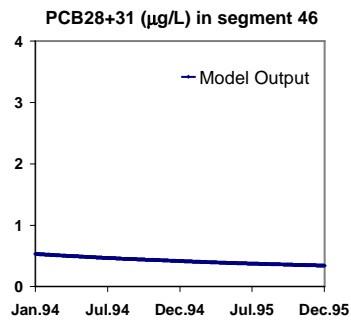
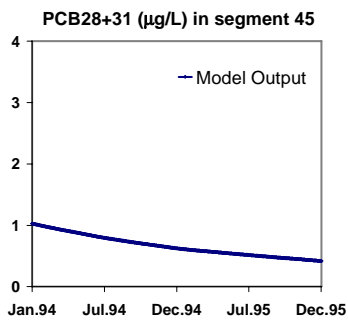
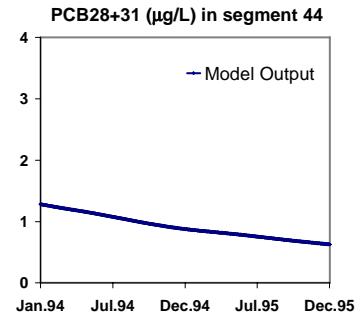
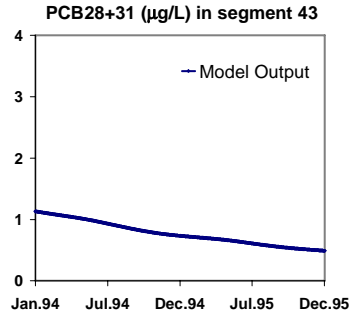
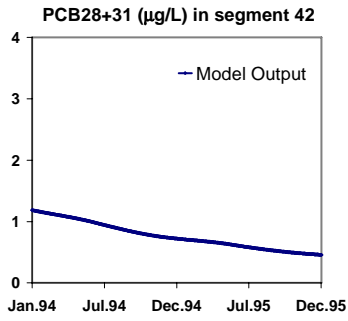

PCB₂₈₊₃₁ in particulate phase ($\mu\text{g/L}$)
 Lake Michigan sediment segments

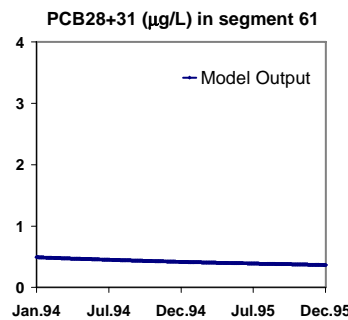
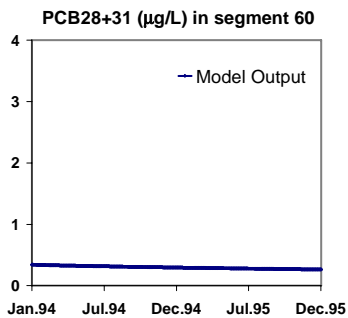
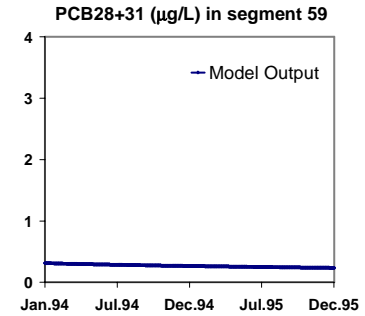
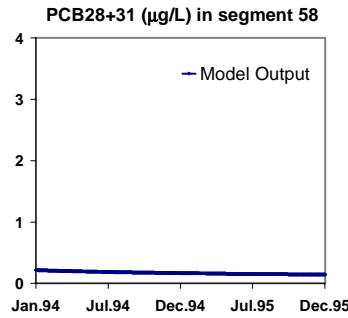
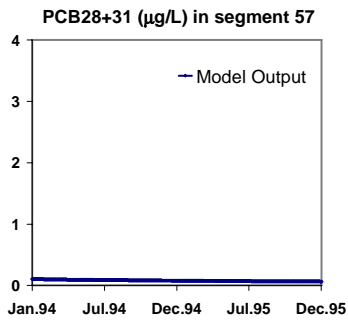
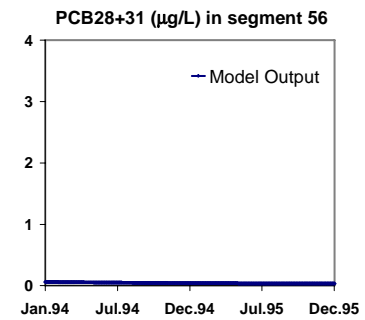
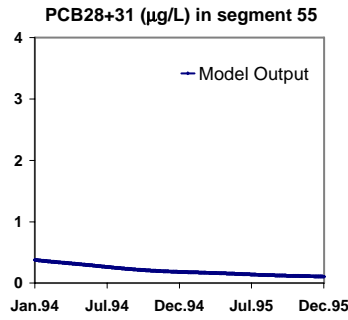
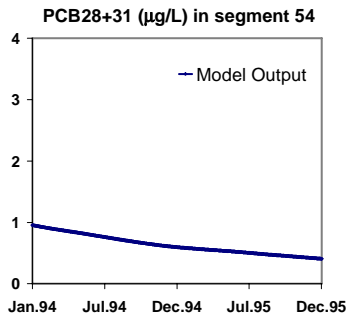
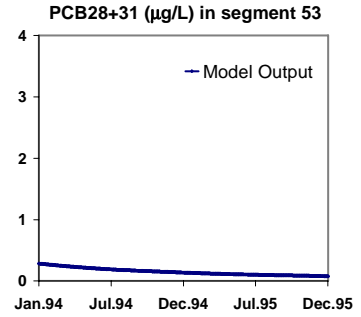
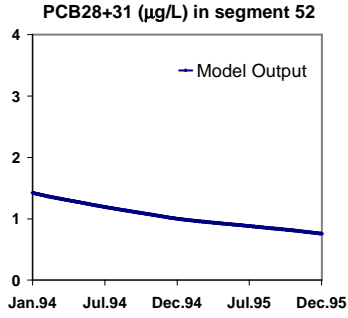
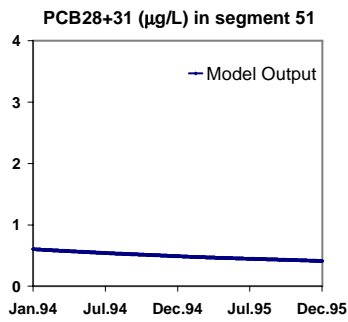

PCB₂₈₊₃₁ in particulate phase ($\mu\text{g/L}$)
Lake Michigan sediment segments

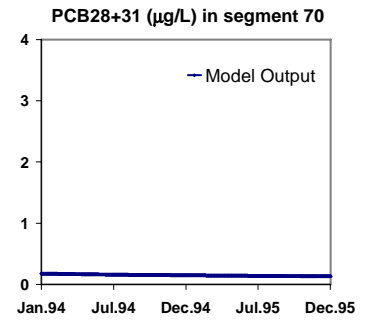
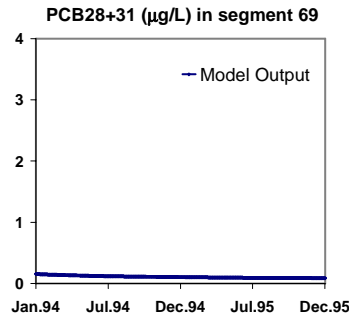
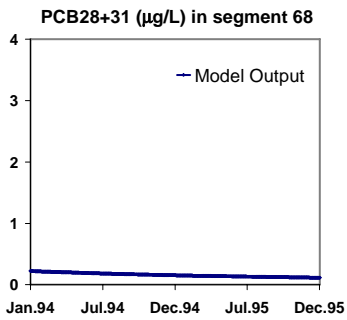
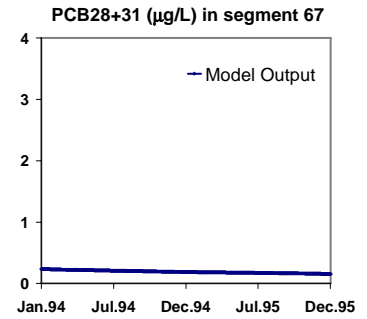
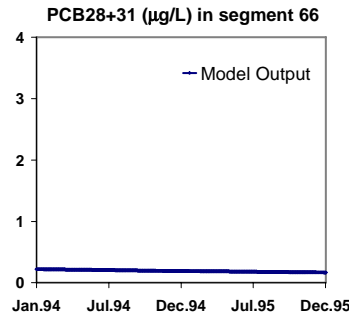
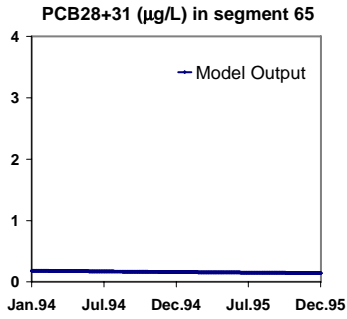
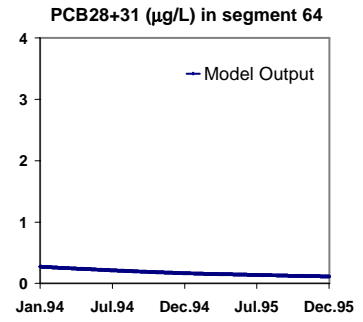
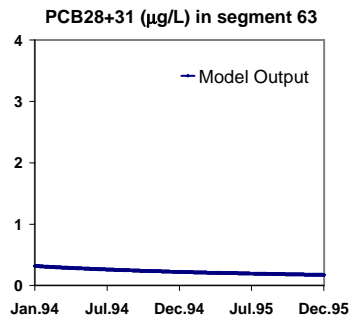
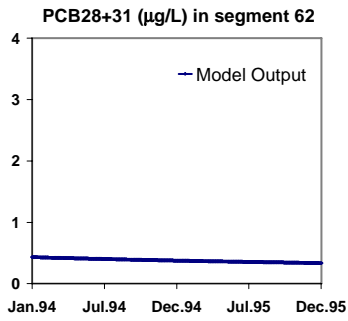

PCB₂₈₊₃₁ in particulate phase (µg/L)
Lake Michigan sediment segments

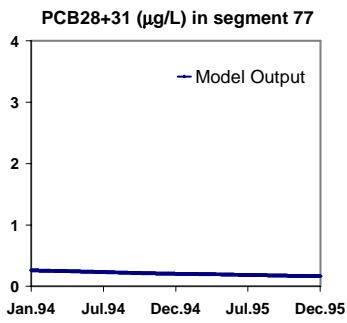
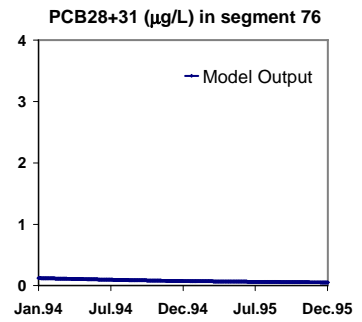
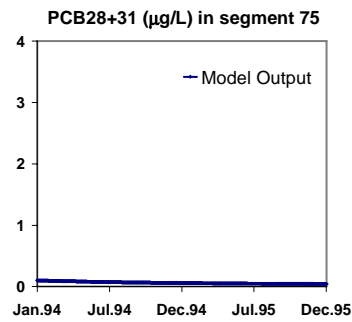
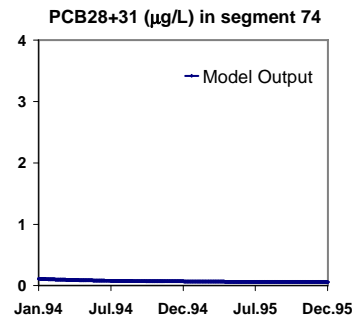
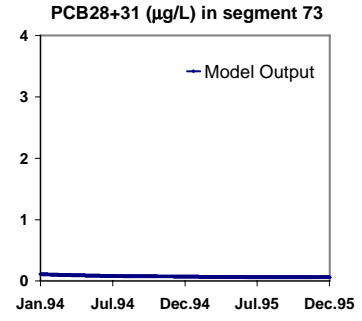
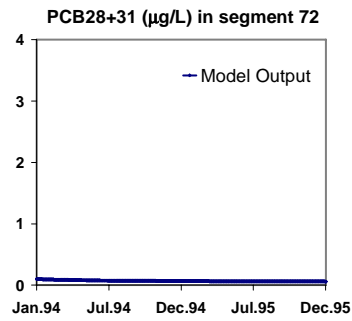
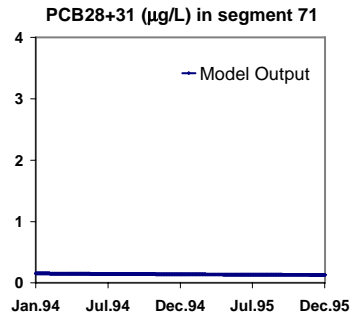

PCB₂₈₊₃₁ in particulate phase (µg/L)
Lake Michigan sediment segments

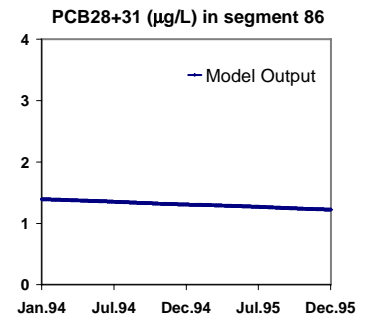
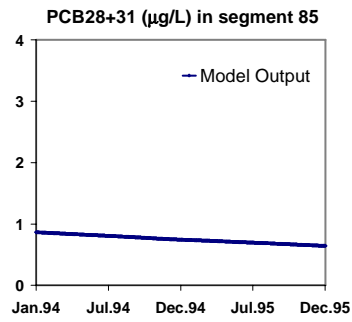
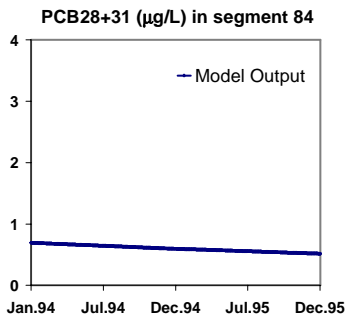
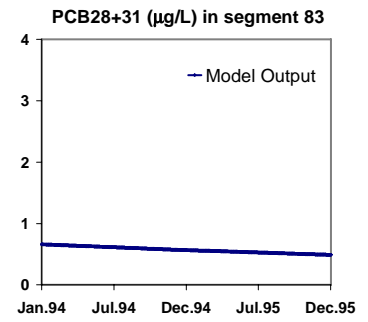
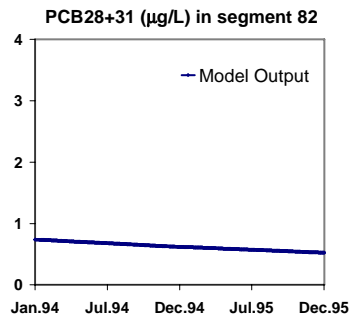
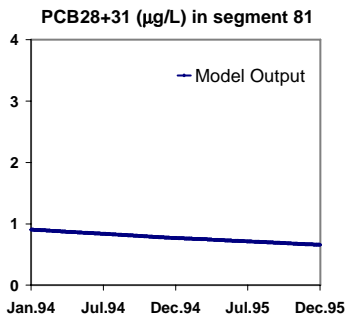
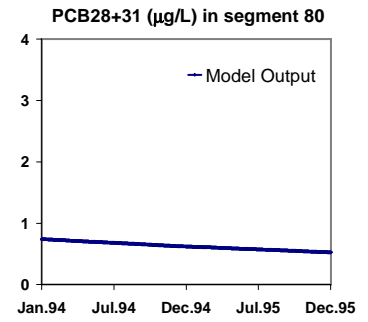
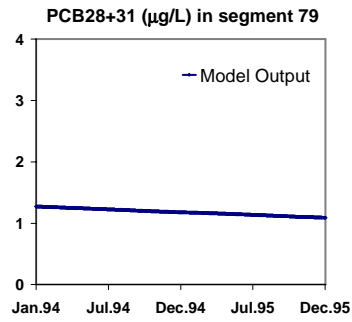
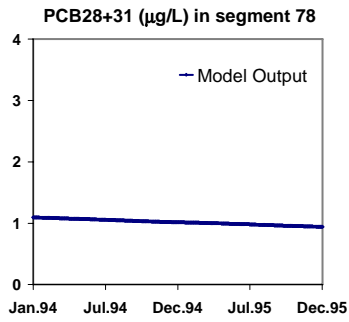

PCB₂₈₊₃₁ in particulate phase (µg/L)
Green Bay sediment segments

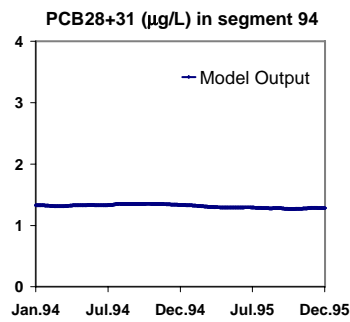
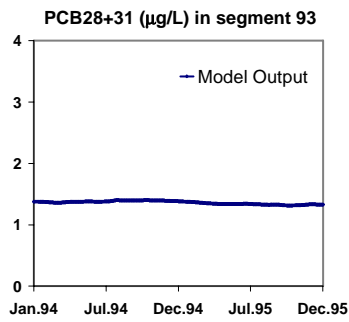
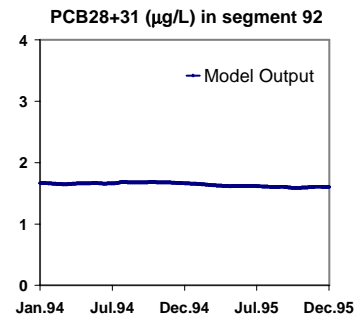
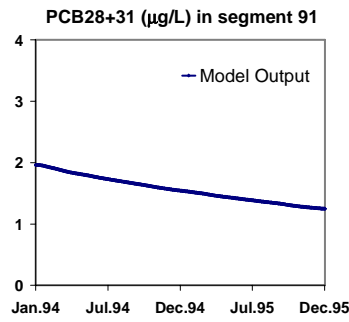
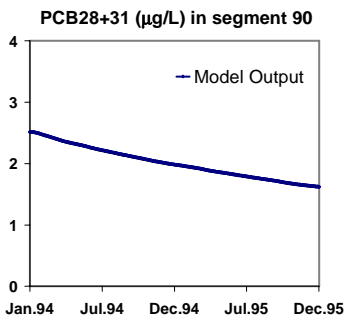
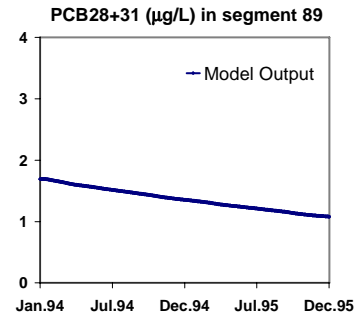
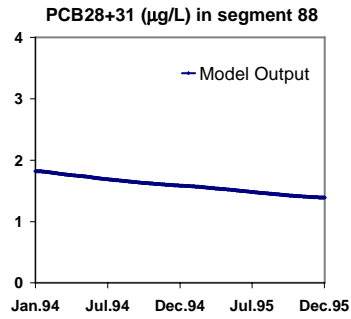
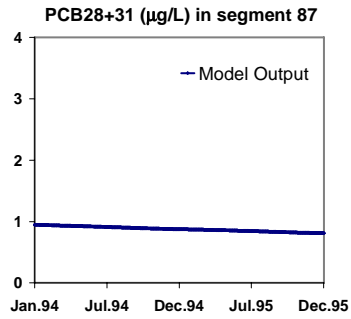

PCB₂₈₊₃₁ in particulate phase ($\mu\text{g/L}$)
Green Bay sediment segments

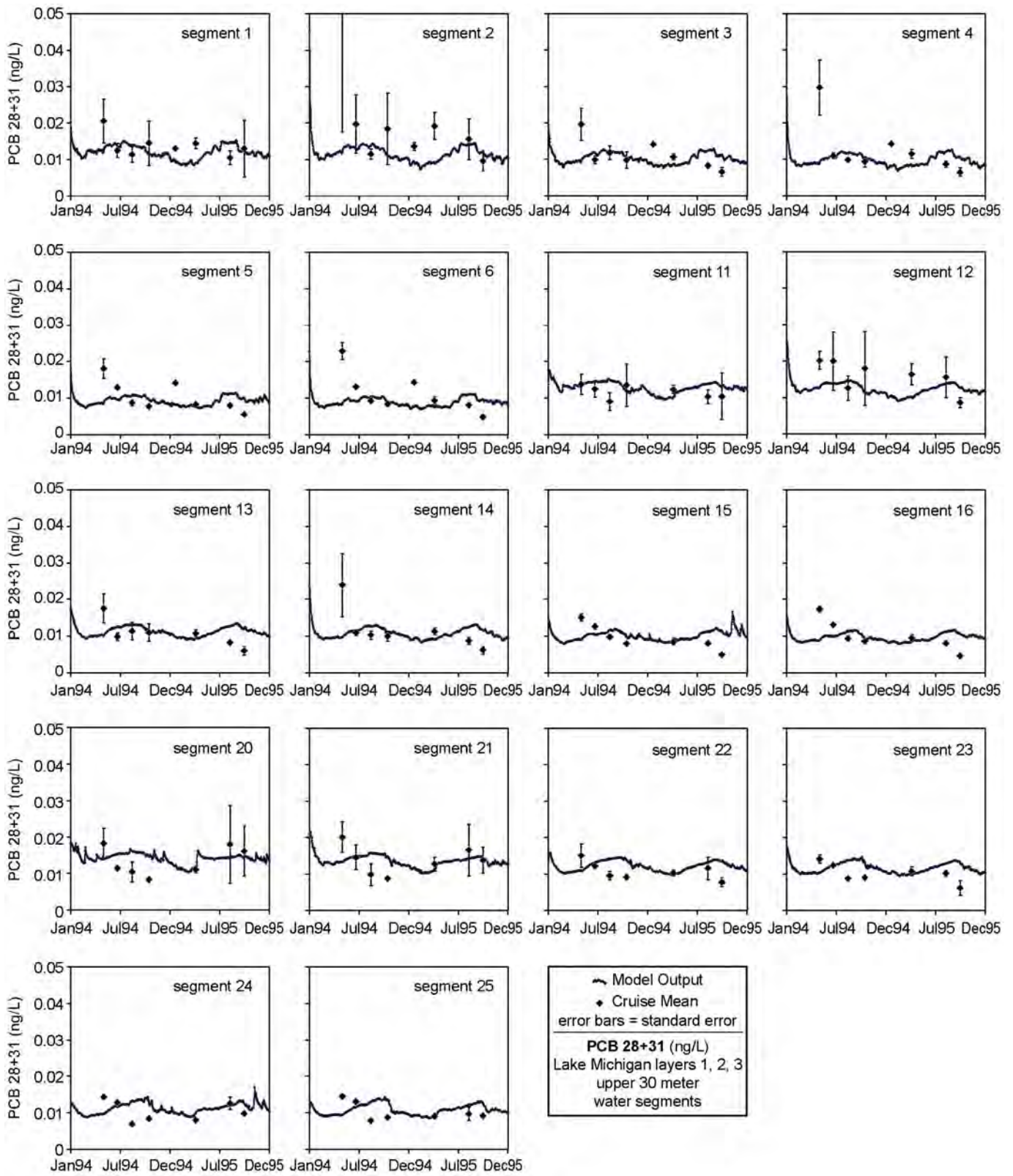

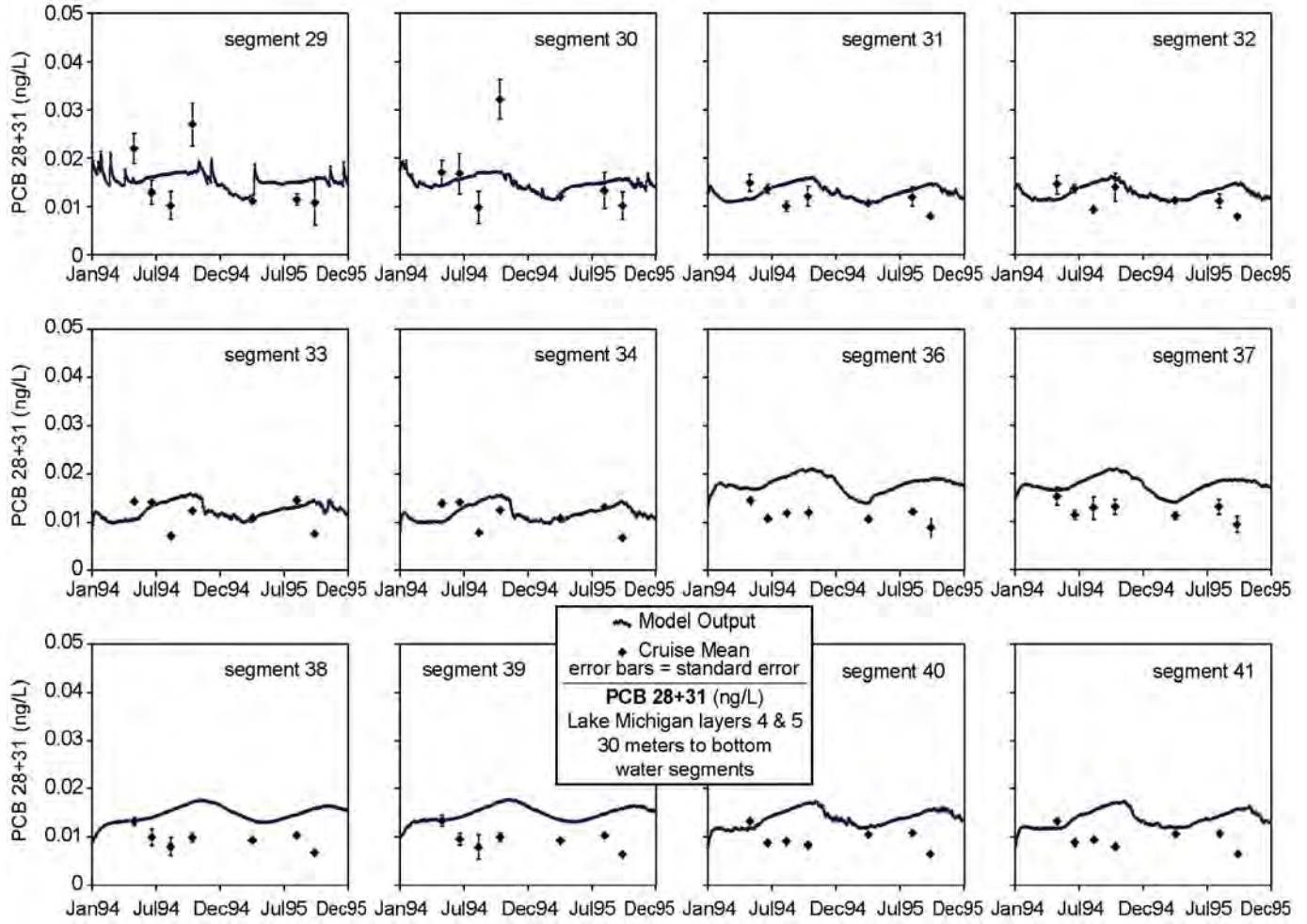

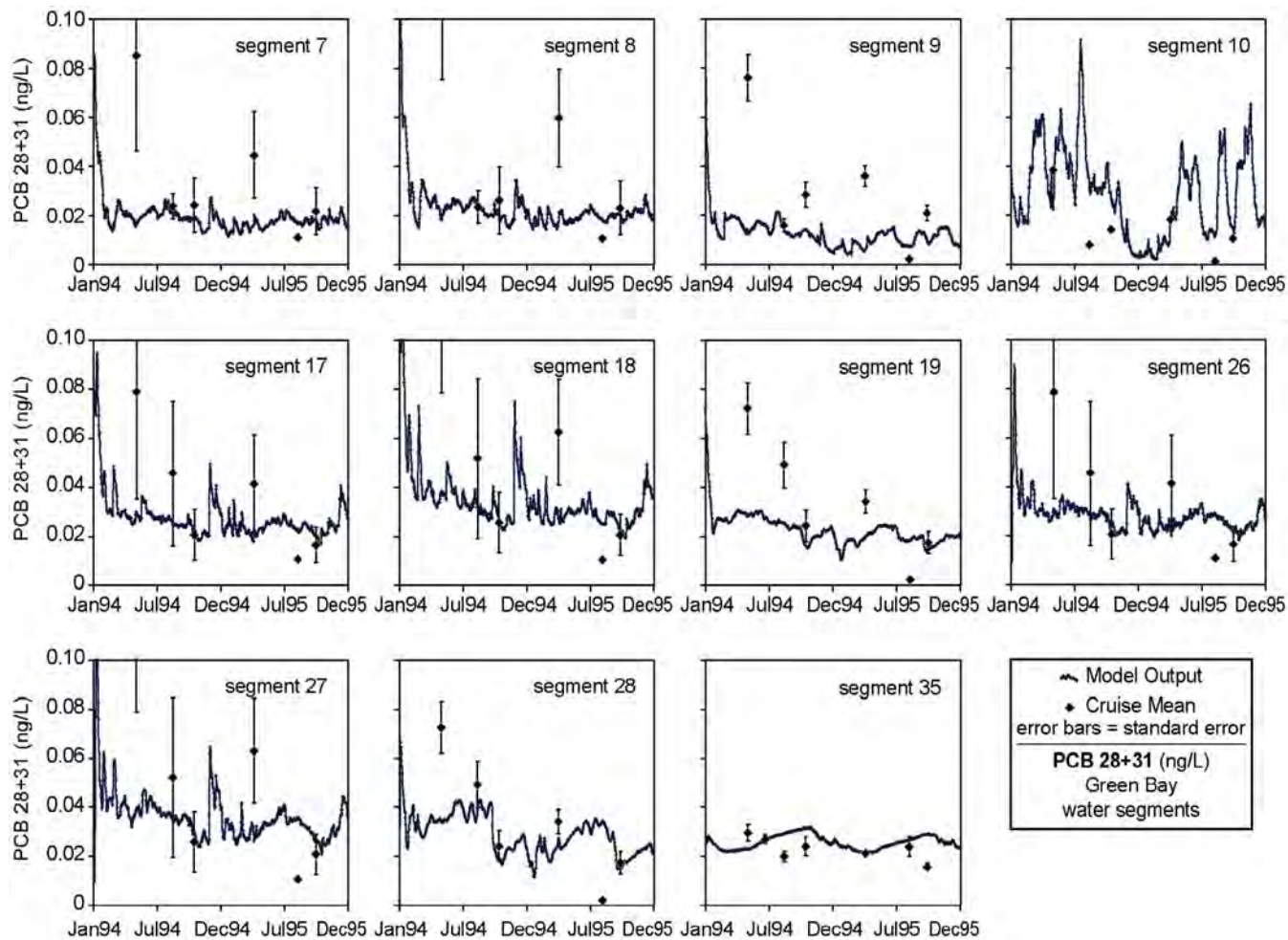

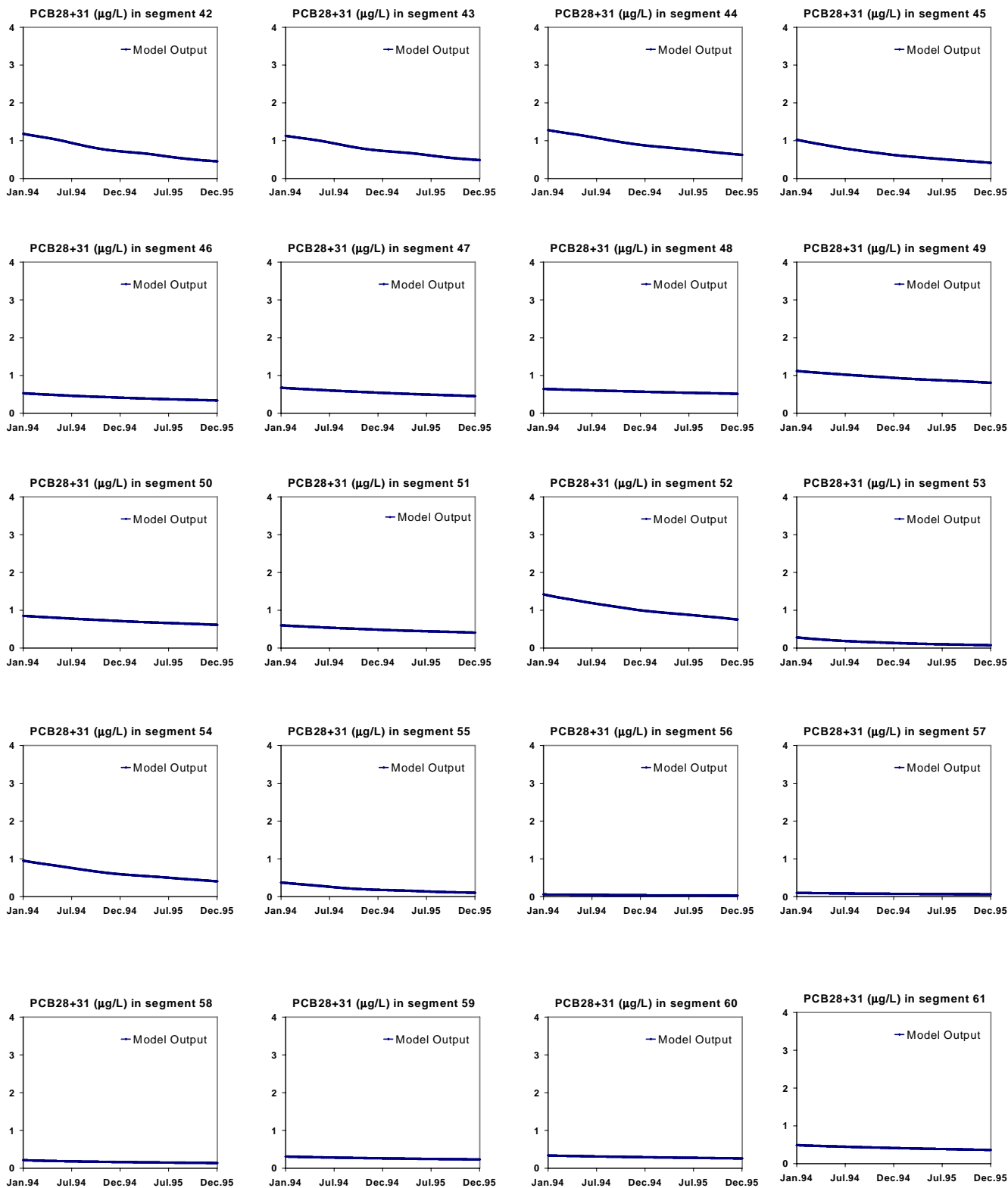

PCB₂₈₊₃₁ (dissolved + particulate) (µg/L)
 Lake Michigan sediment segments

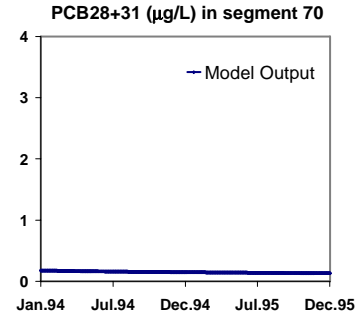
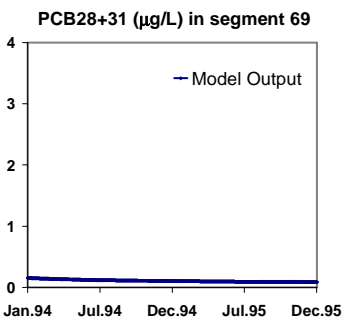
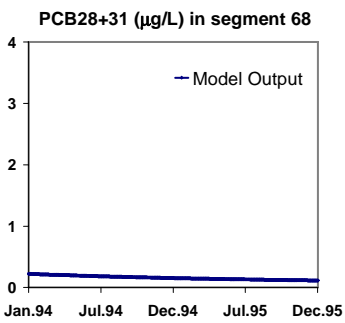
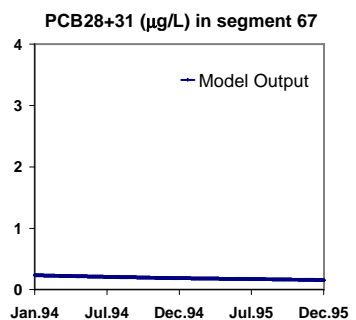
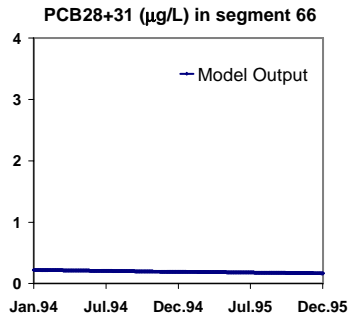
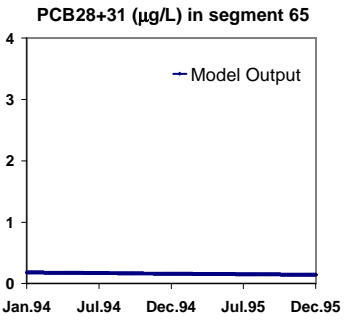
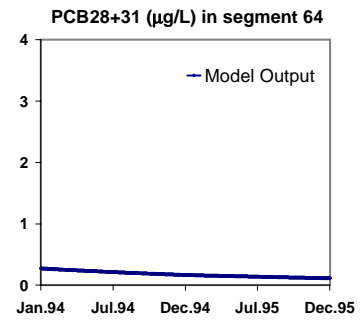
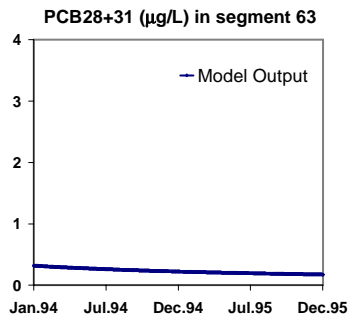
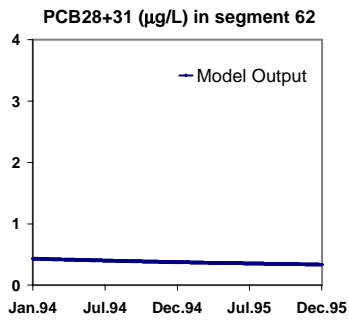

PCB₂₈₊₃₁ (dissolved + particulate) (µg/L)
 Lake Michigan sediment segments

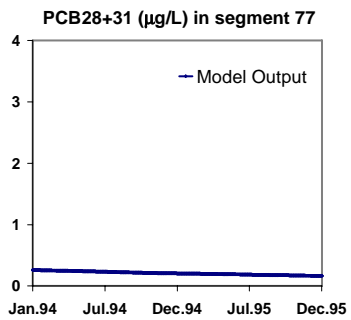
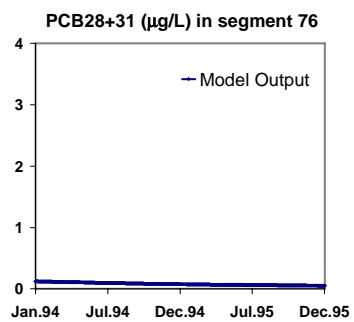
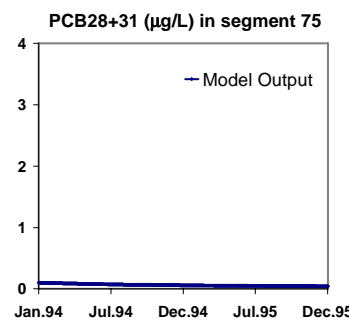
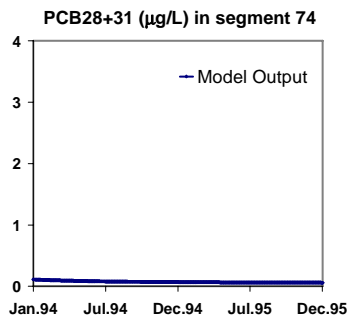
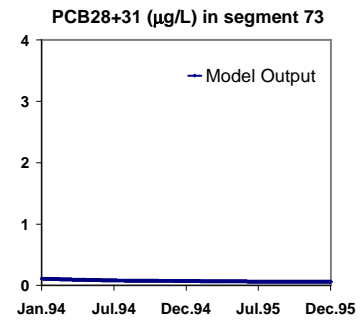
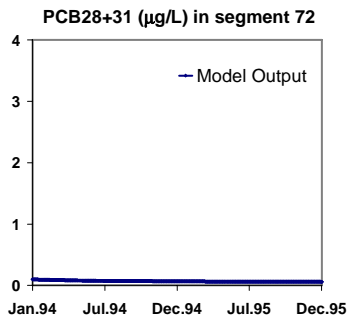
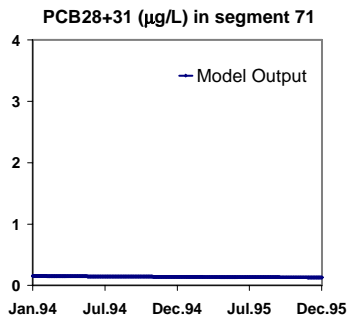

PCB₂₈₊₃₁ (dissolved + particulate) ($\mu\text{g/L}$)
 Lake Michigan sediment segments

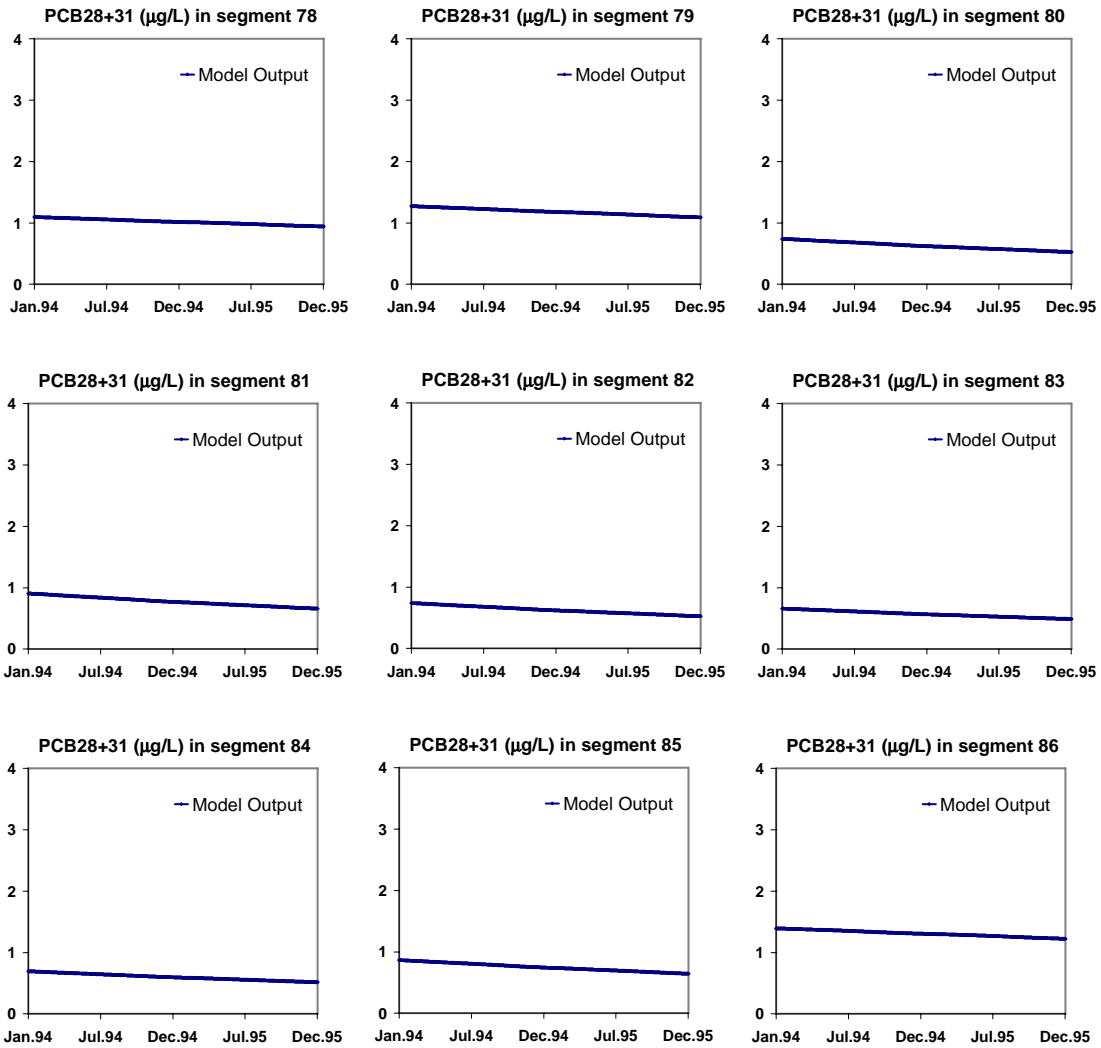

PCB₂₈₊₃₁ (dissolved + particulate) (µg/L)
Green Bay sediment segments

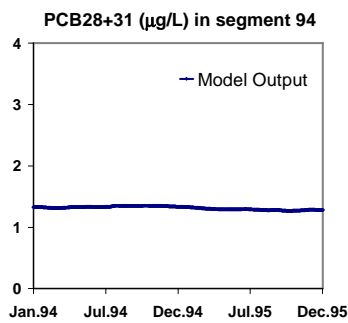
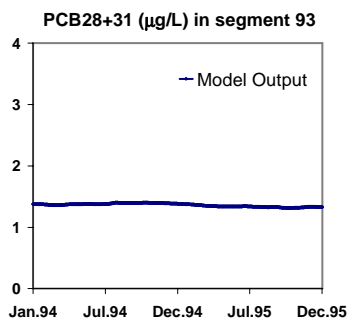
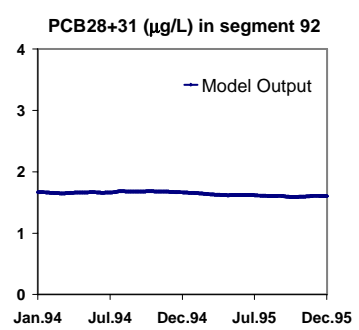
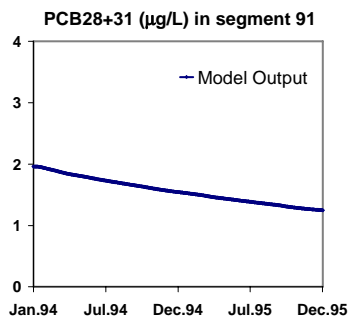
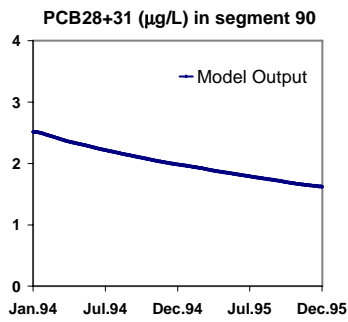
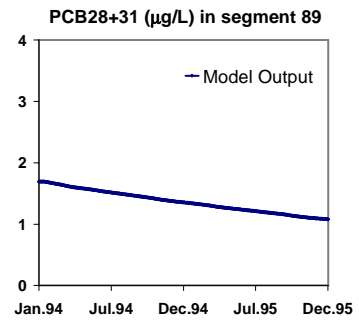
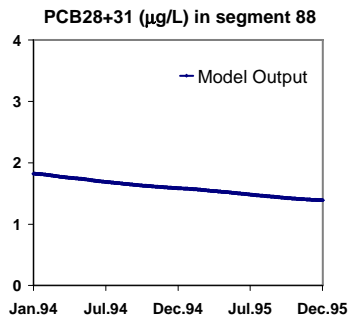
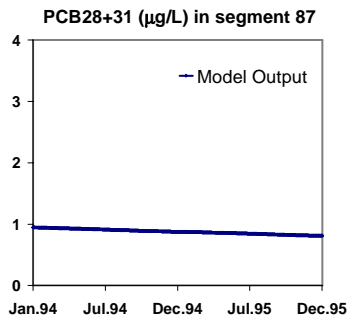

PCB₂₈₊₃₁ (dissolved + particulate) (µg/L)
Green Bay sediment segments

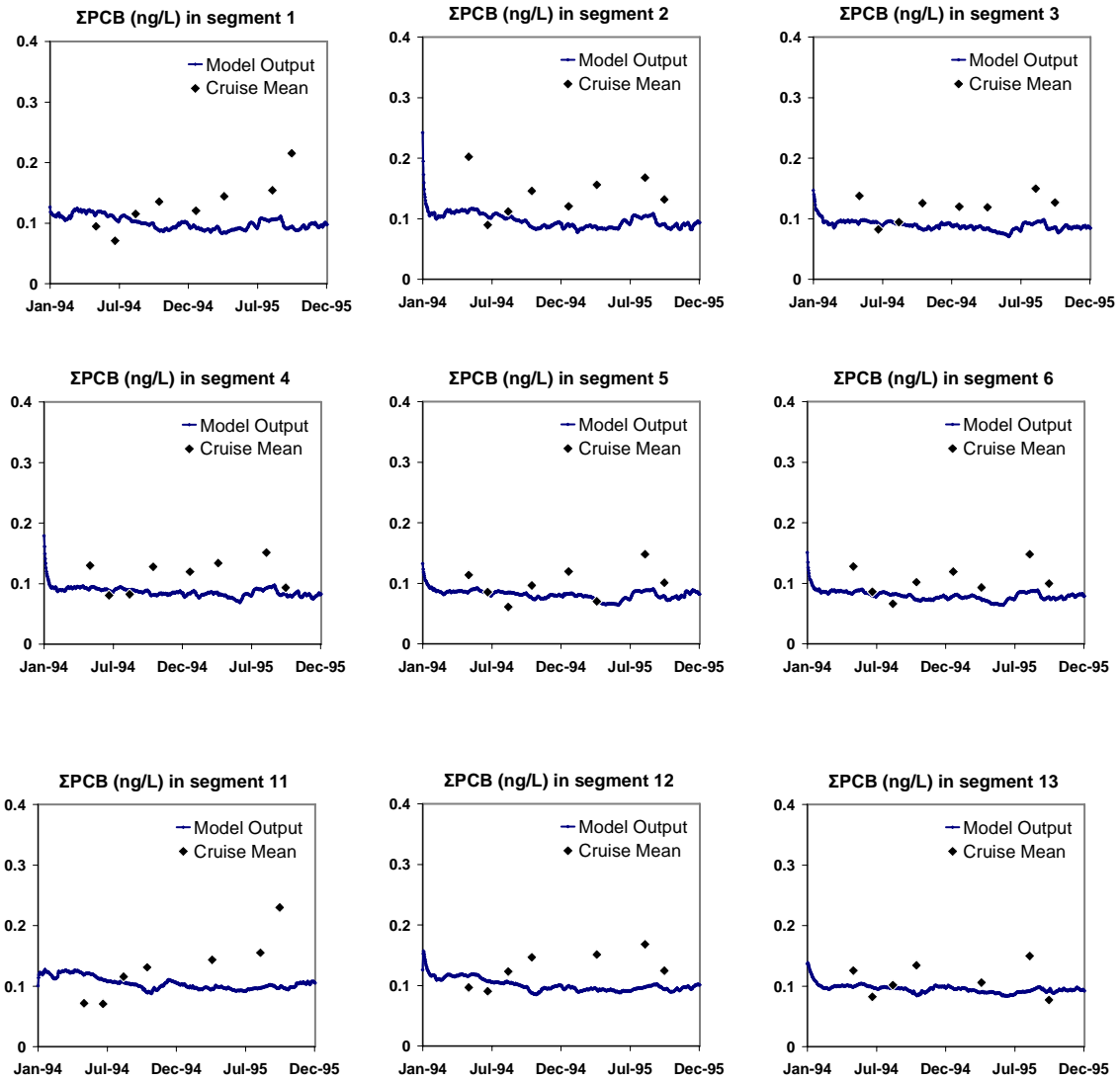

ΣPCBs in dissolved phase (ng/L)
 Lake Michigan layers 1, 2, and 3
 Upper 30 m water segments
 Error bars = standard error

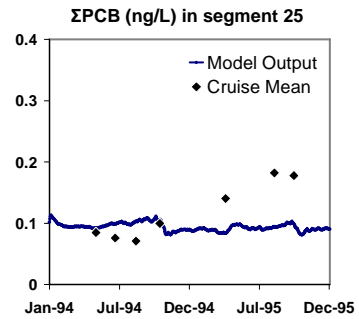
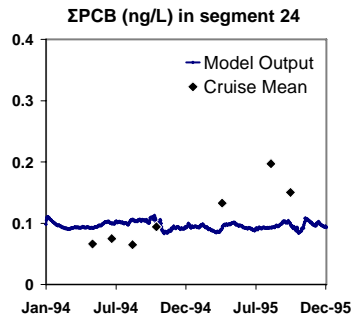
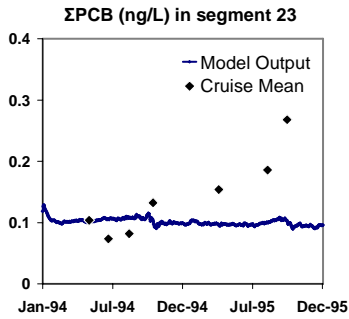
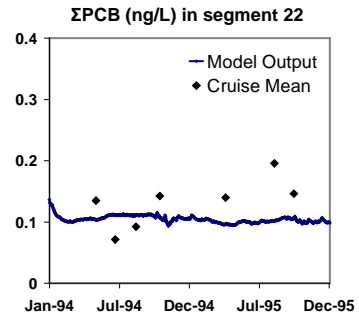
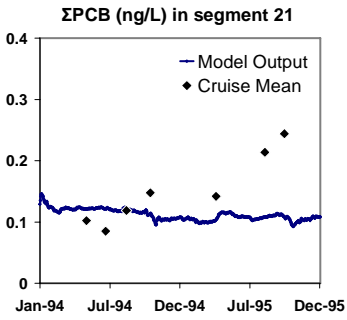
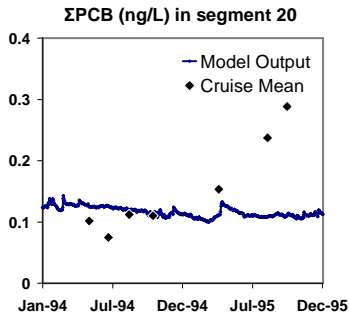
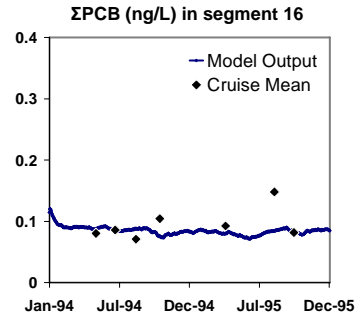
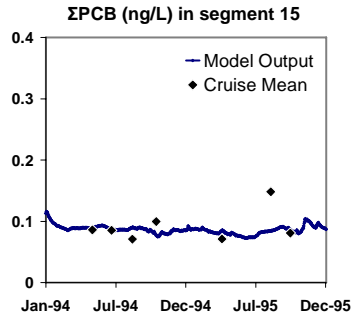
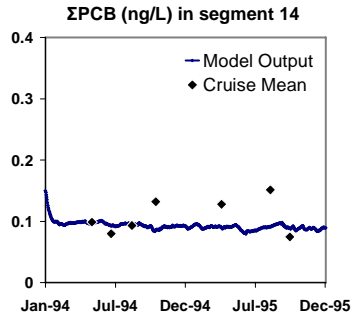

Σ PCBs in dissolved phase (ng/L)
 Lake Michigan layers 1, 2, and 3
 Upper 30 m water segments
 Error bars = standard error

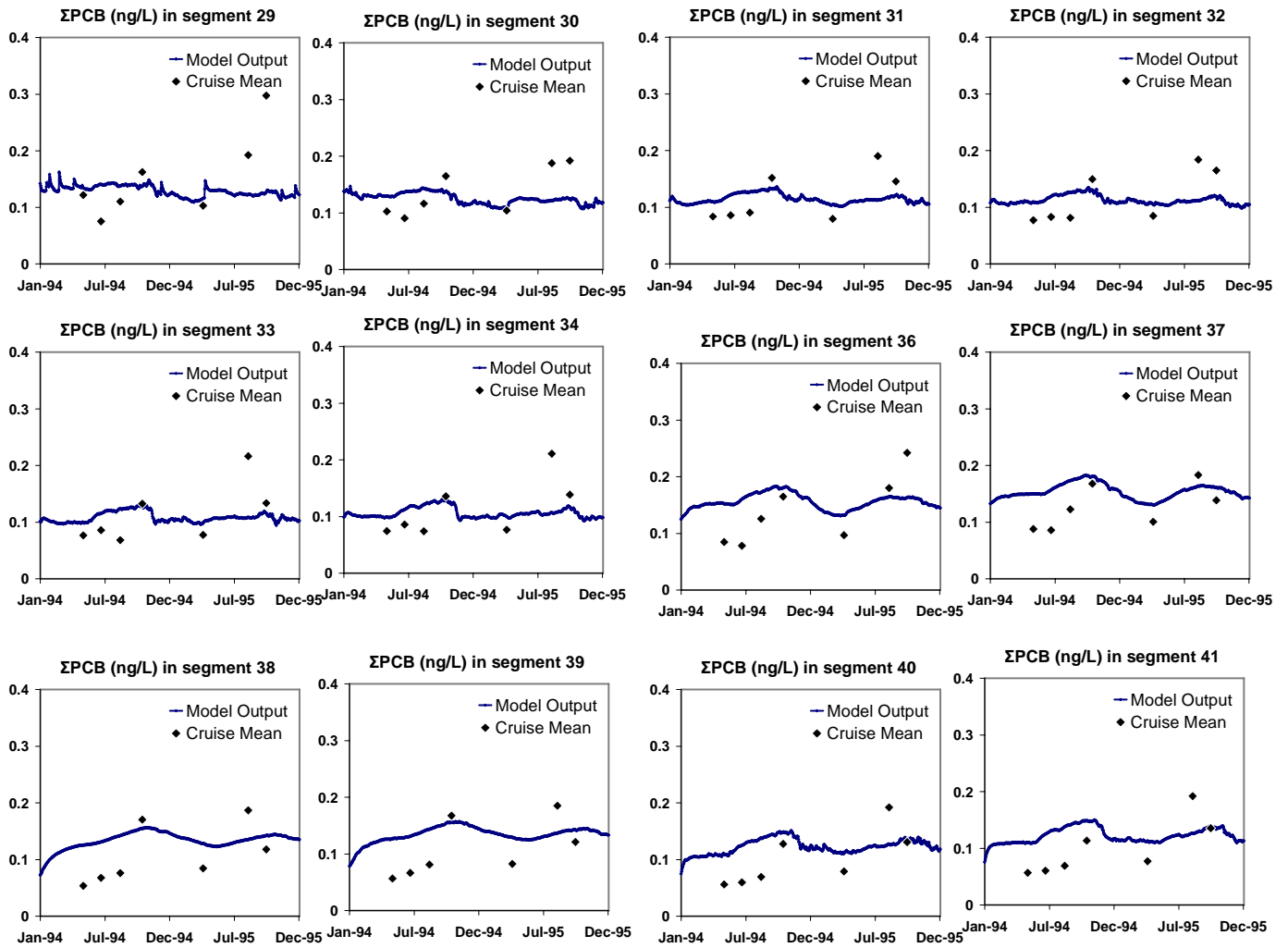

Σ PCBs in dissolved phase (ng/L)
 Lake Michigan layers 4 and 5
 30 m to bottom water segments
 Error bars = standard error

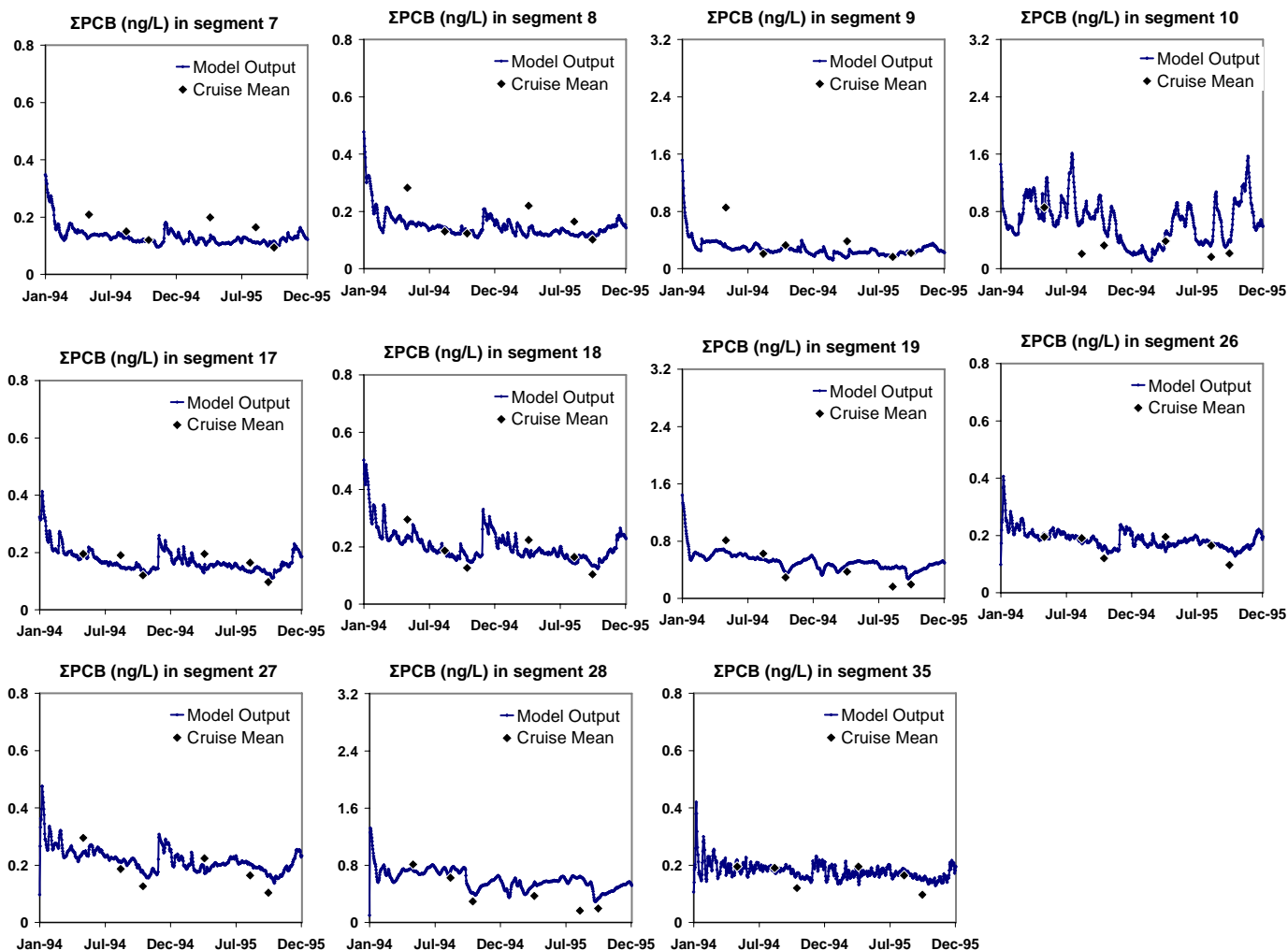

ΣPCBs in dissolved phase (ng/L)
 Green Bay water segments
 Error bars = standard error

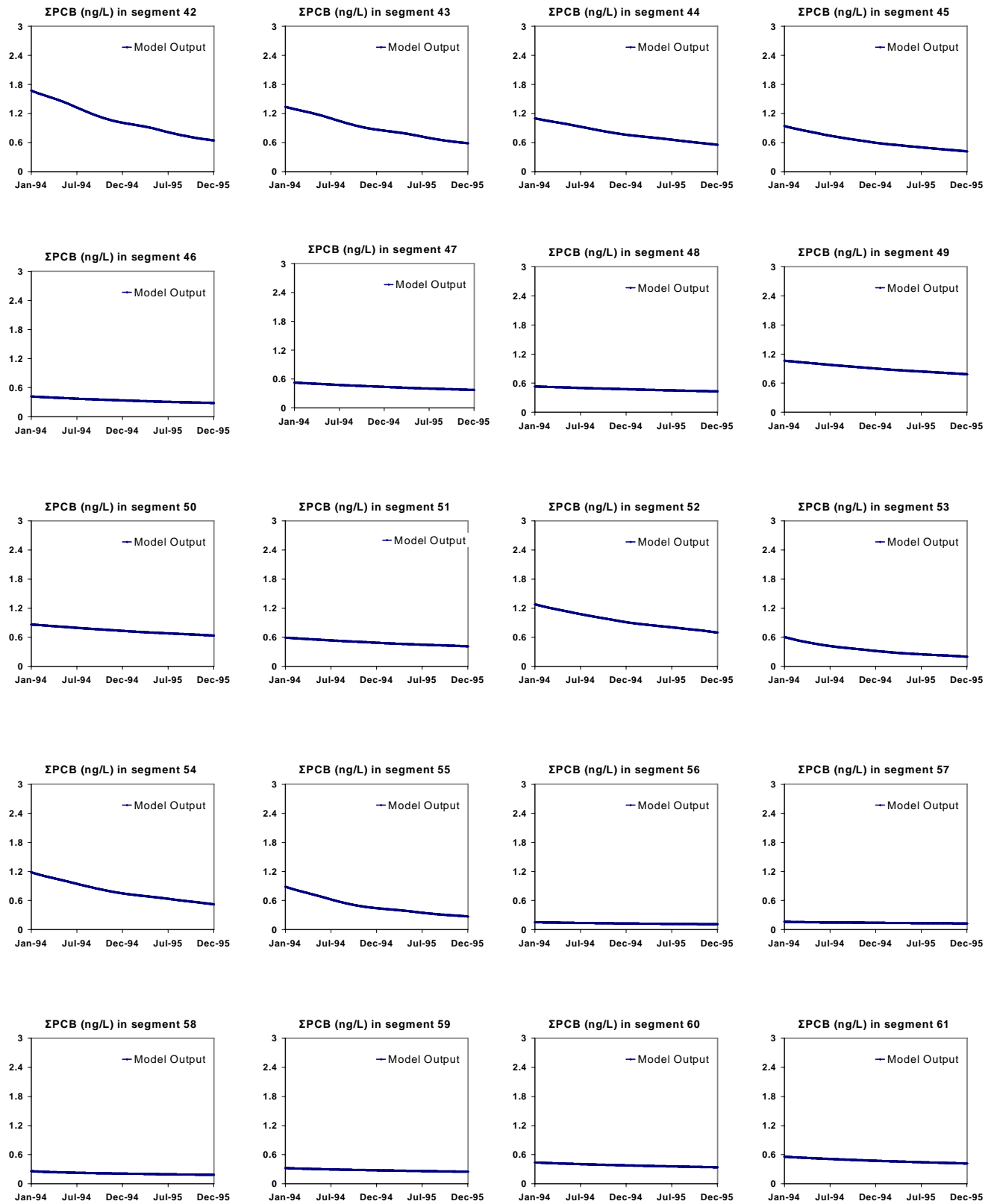

ΣPCBs in dissolved phase (ng/L)
Lake Michigan sediment segments

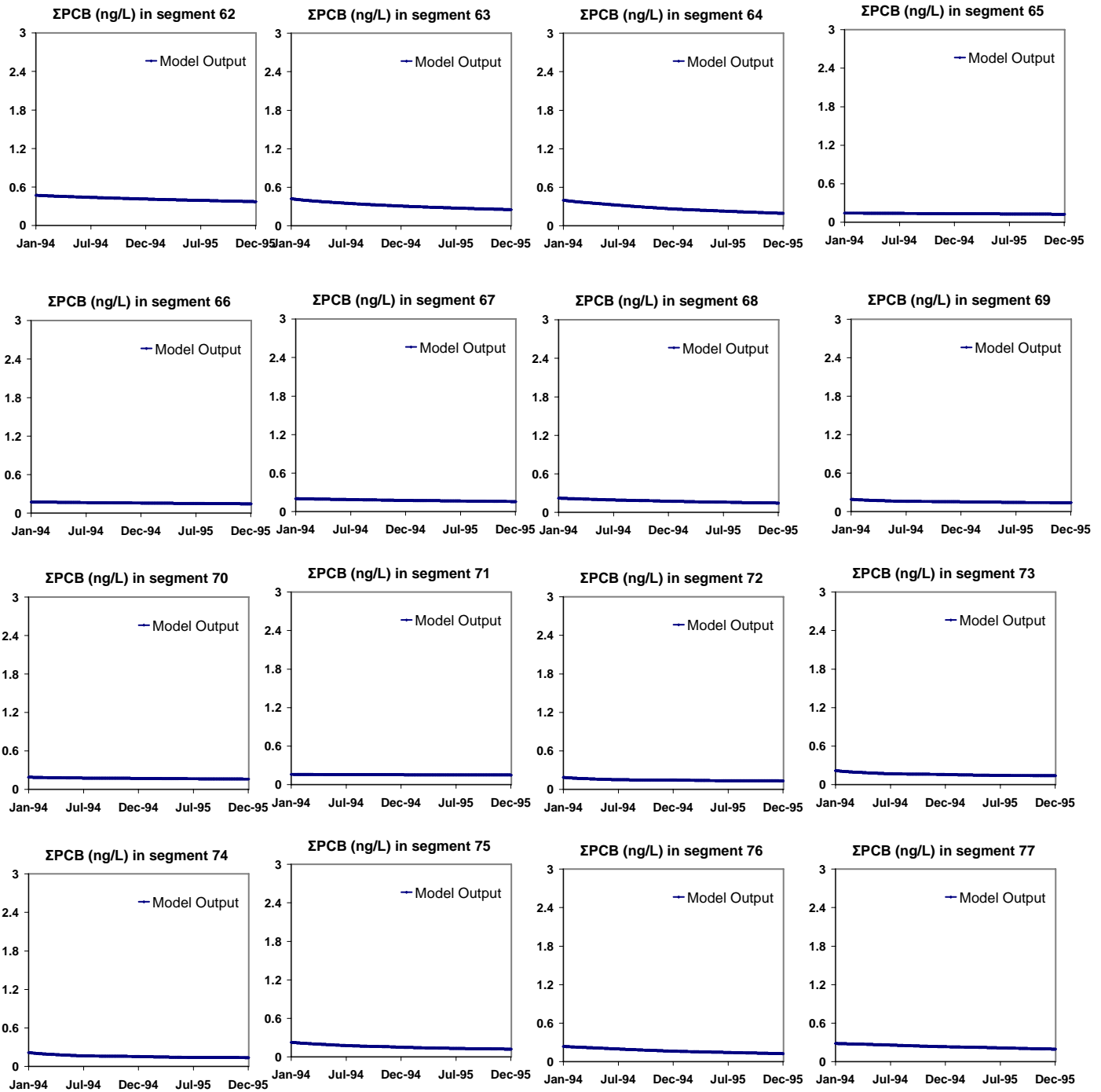

ΣPCBs in dissolved phase (ng/L)
Lake Michigan sediment segments

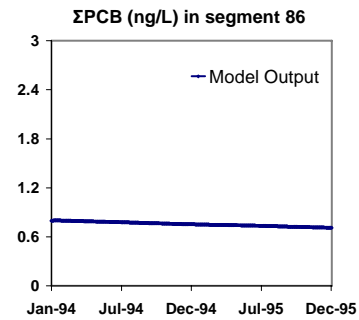
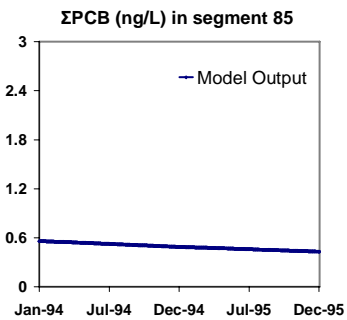
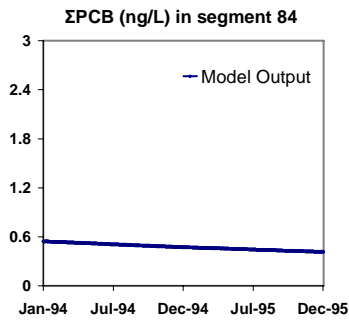
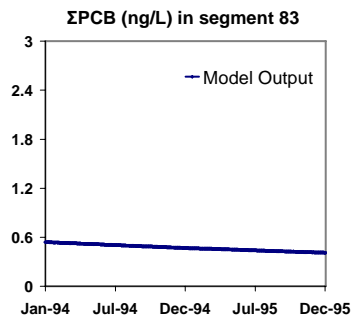
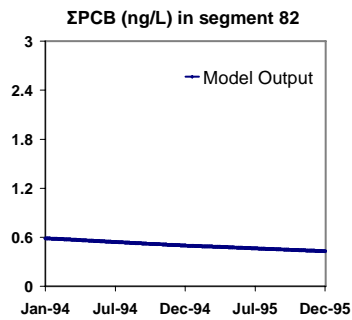
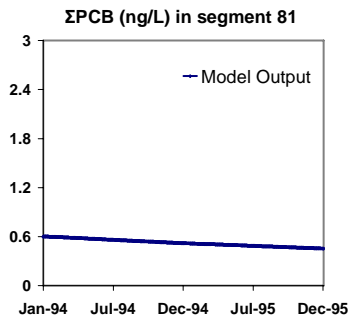
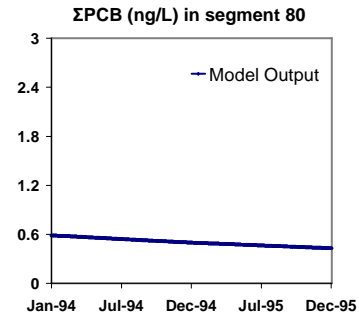
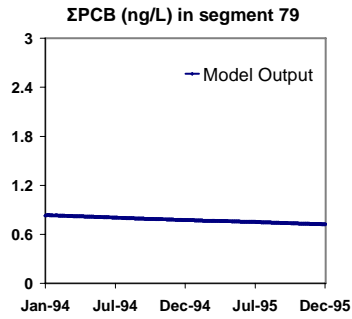
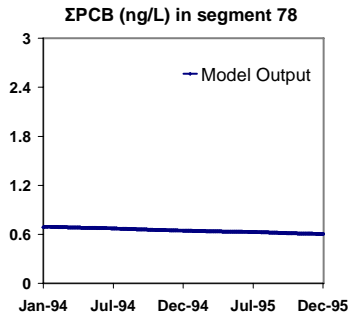

ΣPCBs in dissolved phase (ng/L)
Green Bay sediment segments

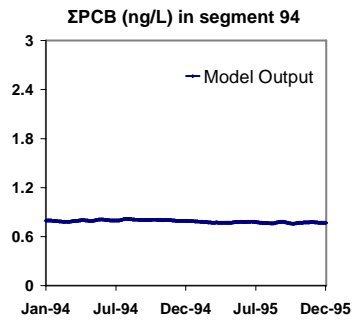
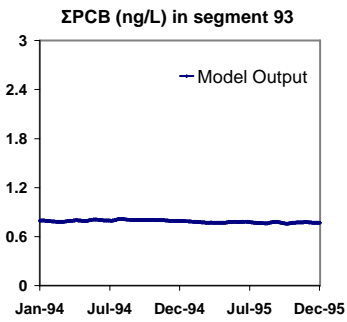
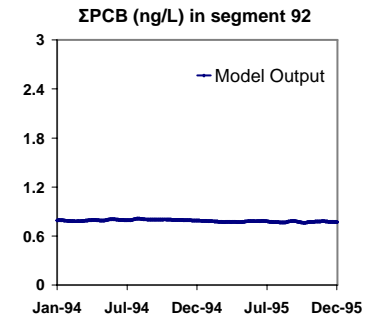
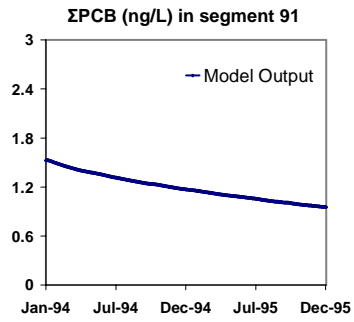
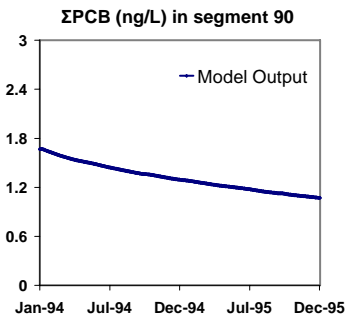
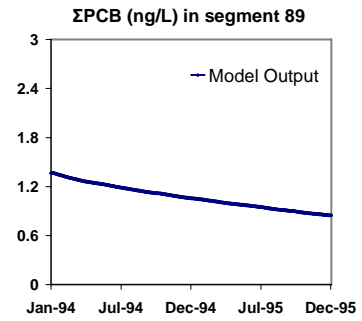
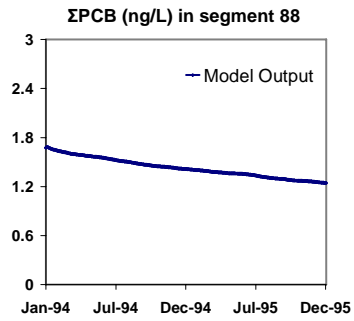
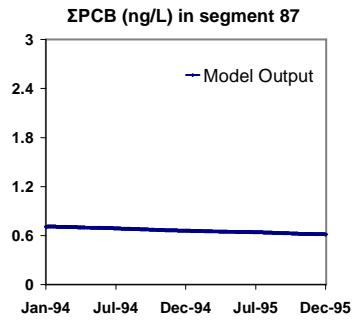

ΣPCBs in dissolved phase (ng/L)
Green Bay sediment segments

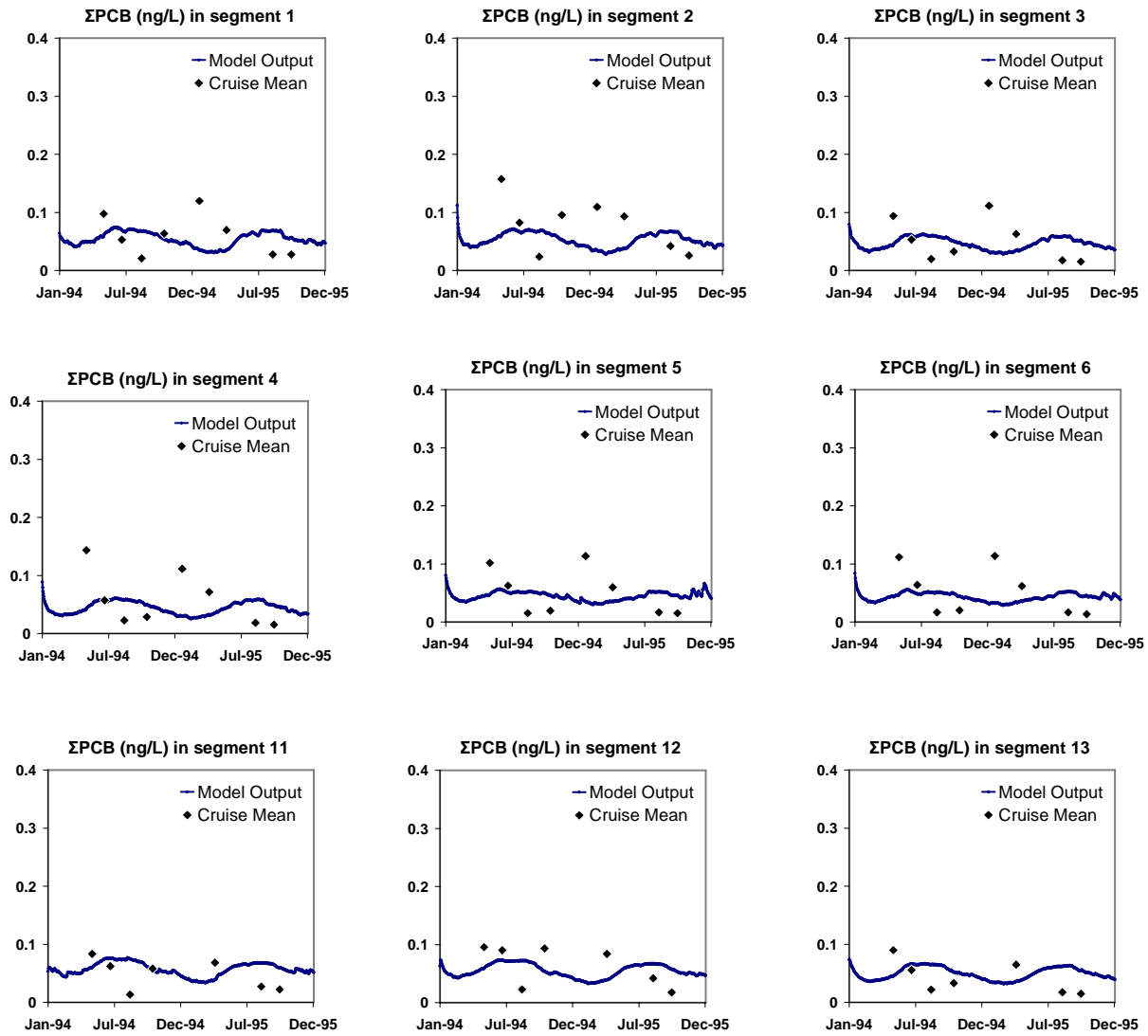

ΣPCBs in particulate phase (ng/L)
 Lake Michigan layers 1, 2, and 3
 Upper 30 m water segments
 Error bars = standard error

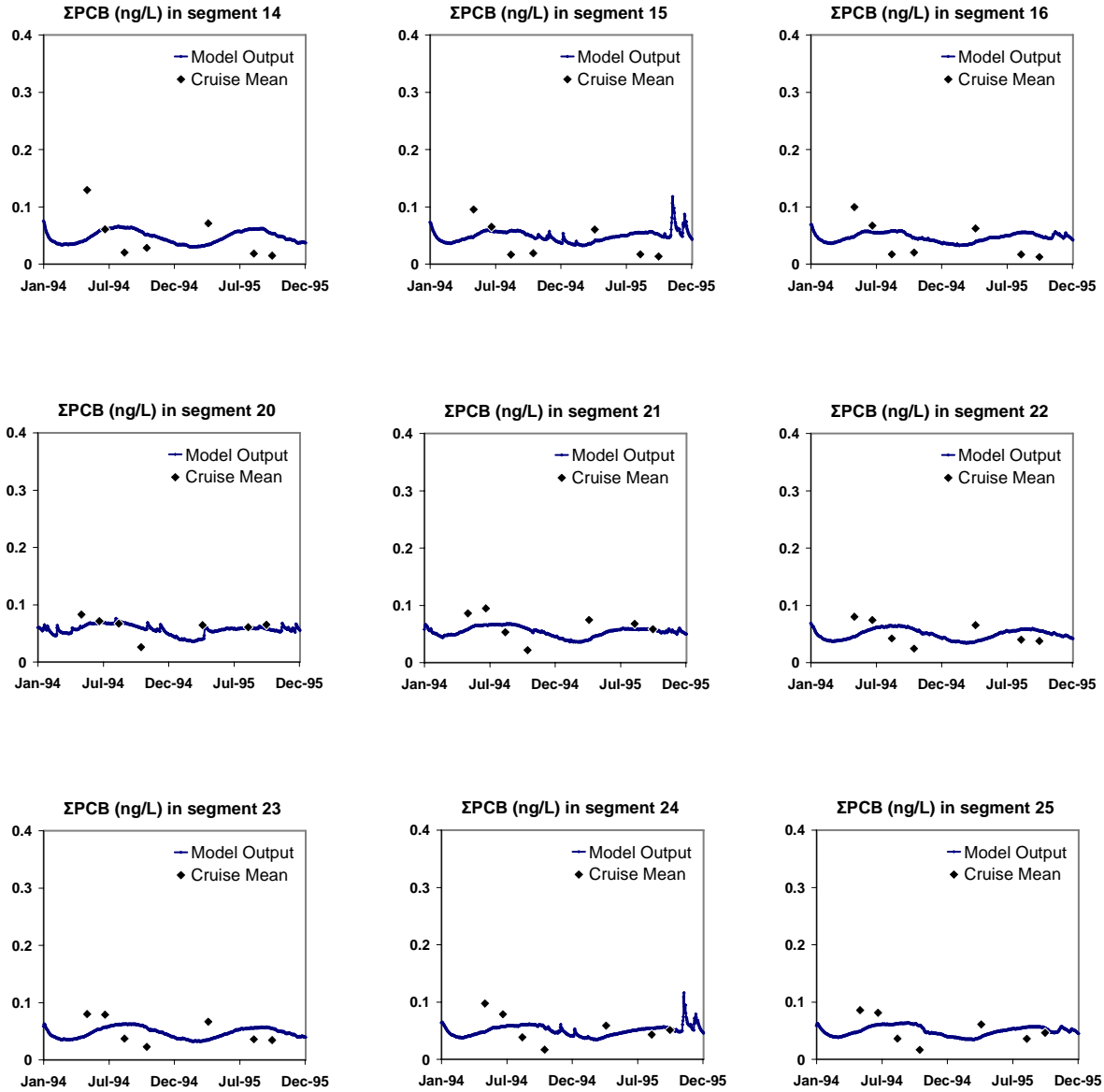

ΣPCBs in particulate phase (ng/L)
 Lake Michigan layers 1, 2, and 3
 Upper 30 m water segments
 Error bars = standard error

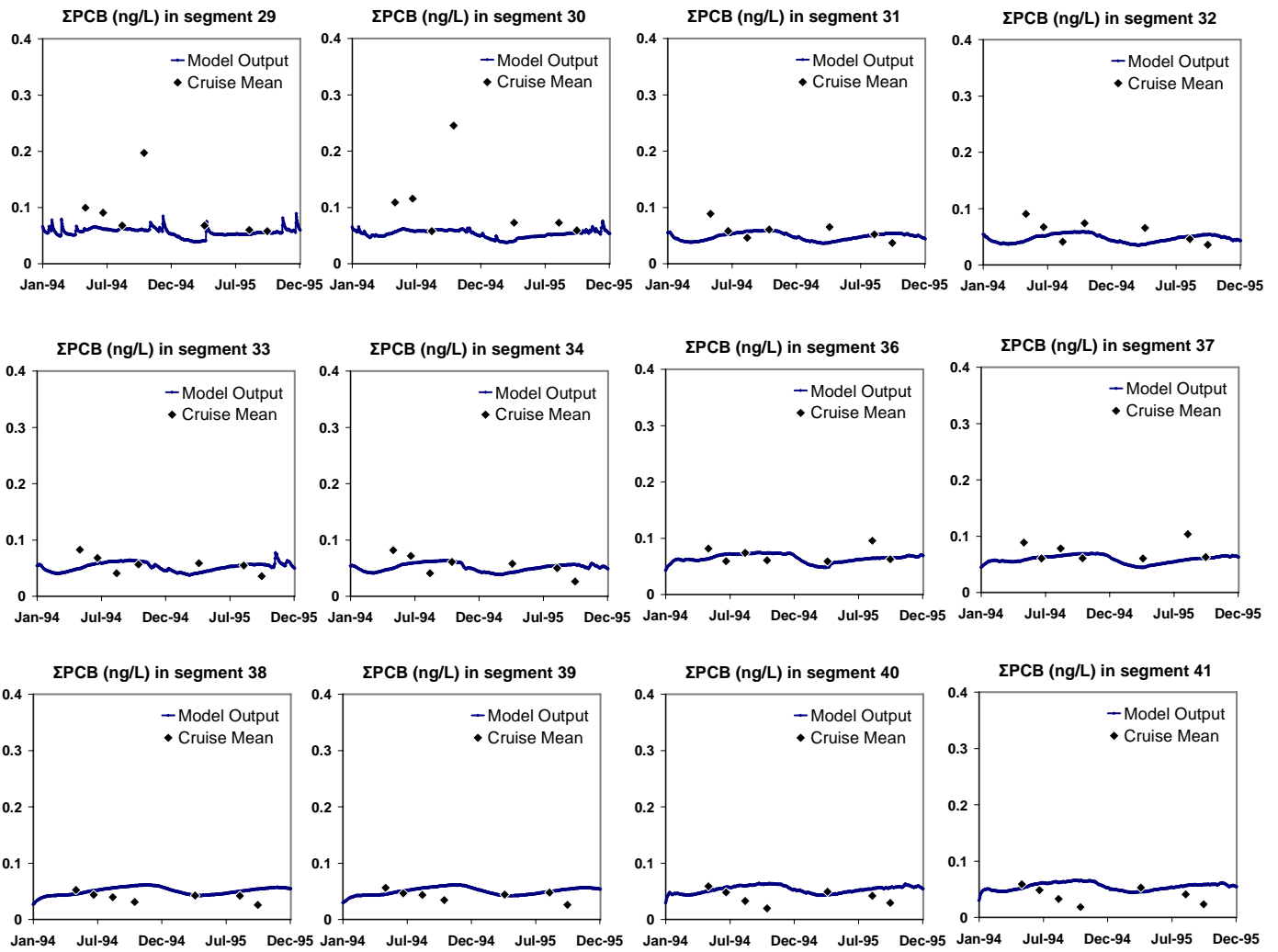

ΣPCBs in particulate phase (ng/L)
 Lake Michigan layers 4 and 5
 30 m to bottom water segments
 Error bars = standard error

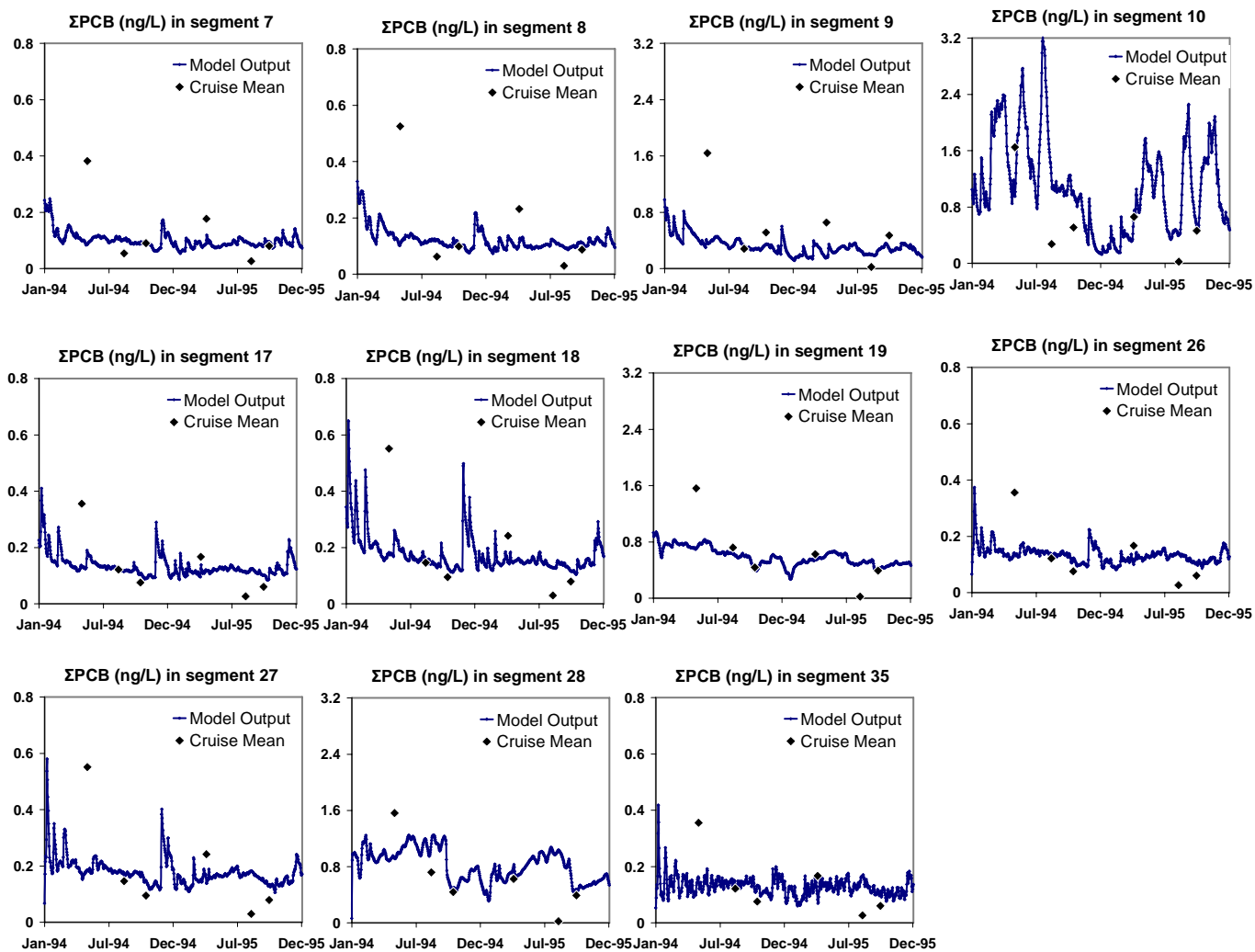

ΣPCBs in particulate phase (ng/L)
 Green Bay water segments
 Error bars = standard error

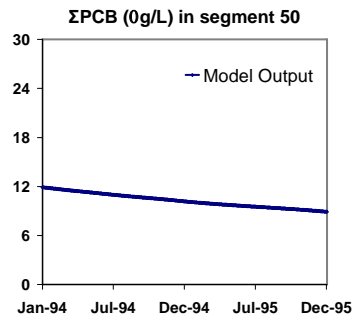
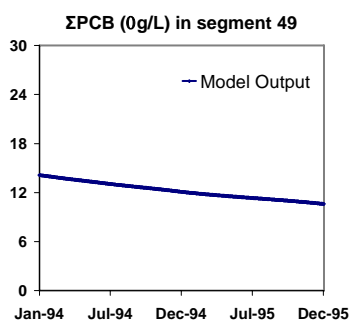
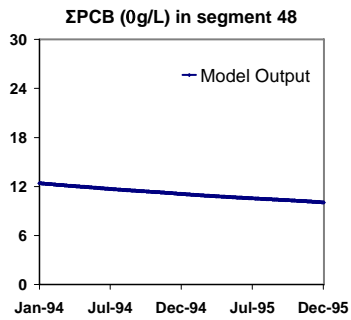
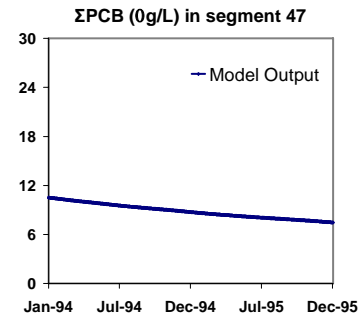
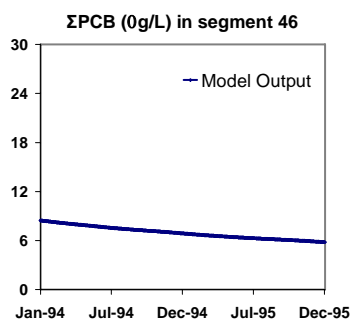
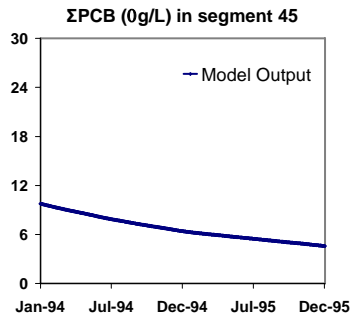
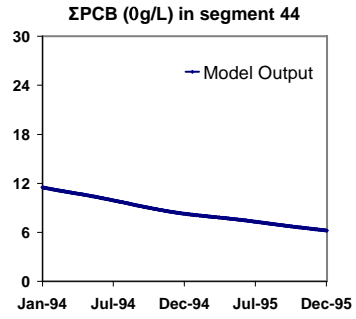
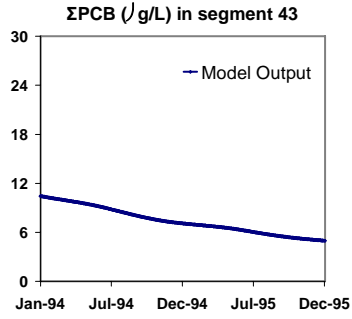
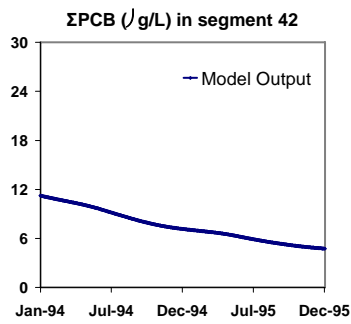

Σ PCBs in particulate phase (μ g/L)
Lake Michigan sediment segments

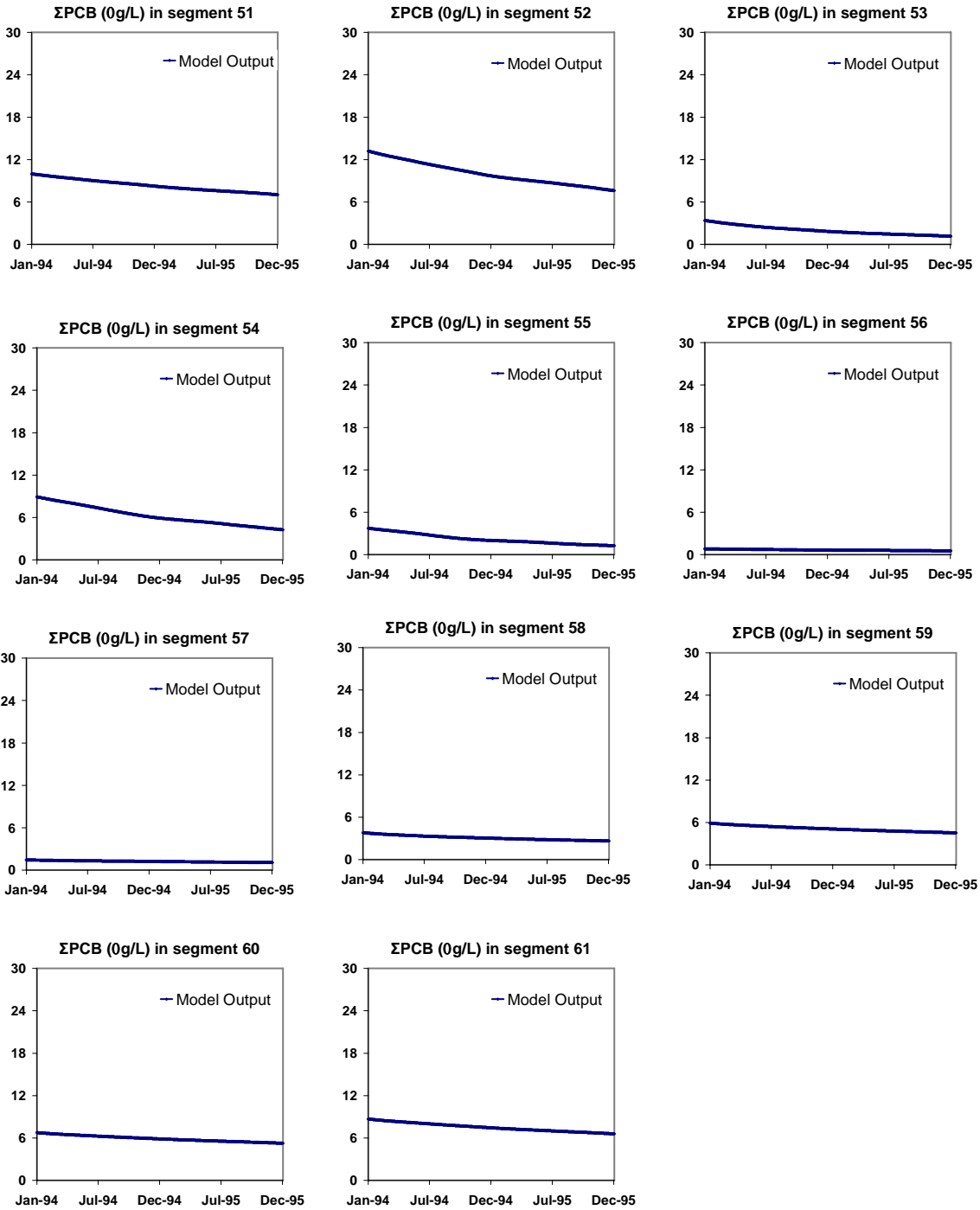

ΣPCBs in particulate phase (µg/L)
Lake Michigan sediment segments

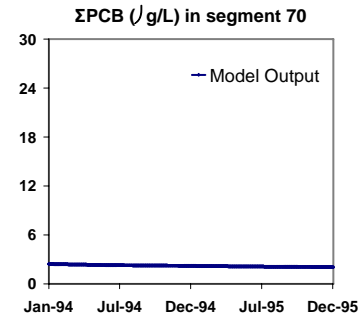
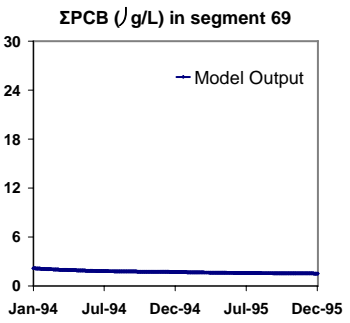
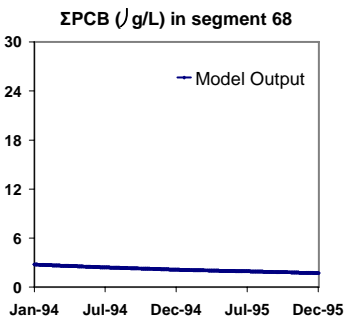
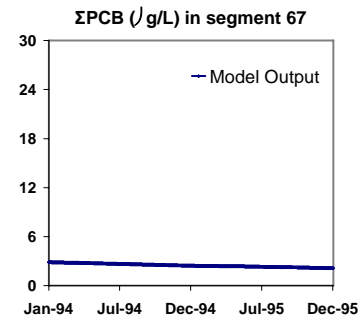
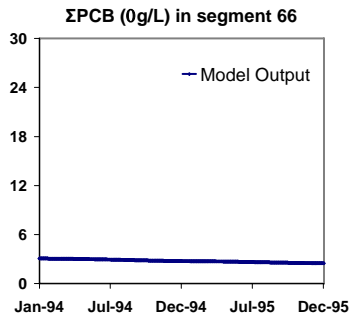
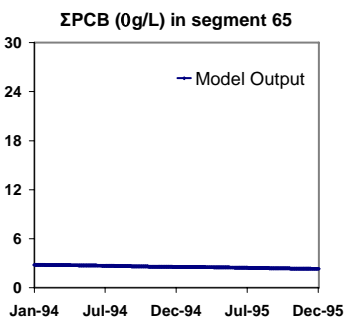
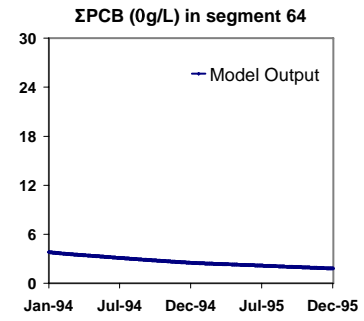
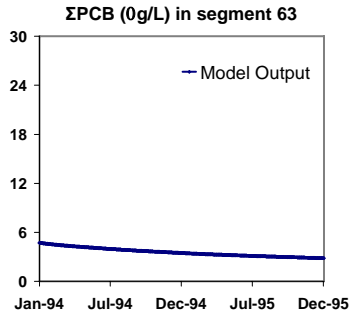
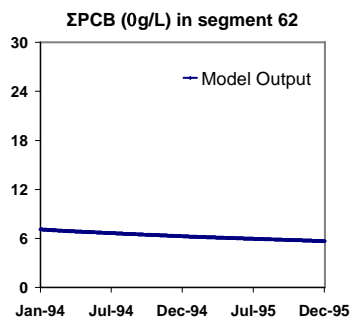

ΣPCBs in particulate phase (μg/L)
Lake Michigan sediment segments

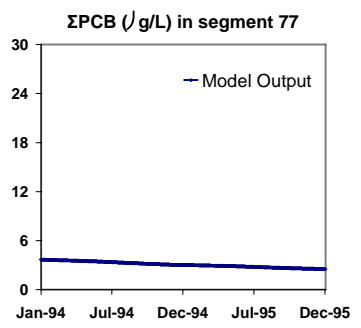
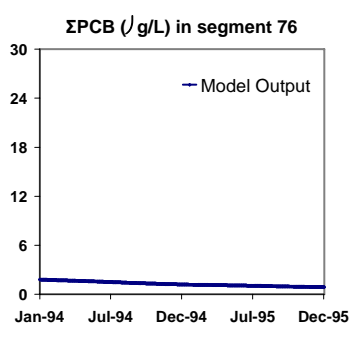
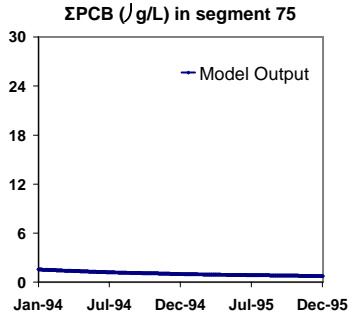
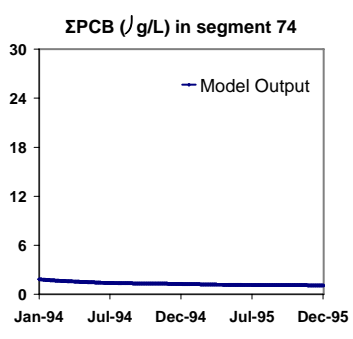
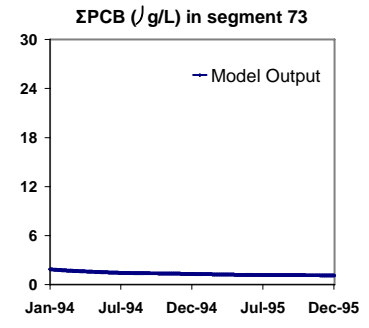
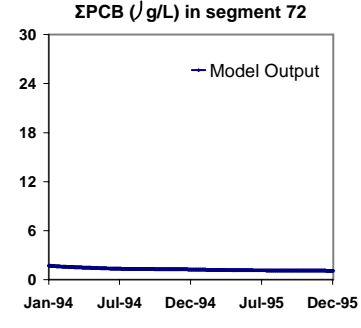
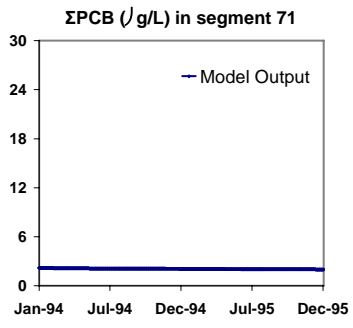

ΣPCBs in particulate phase (µg/L)
Lake Michigan sediment segments

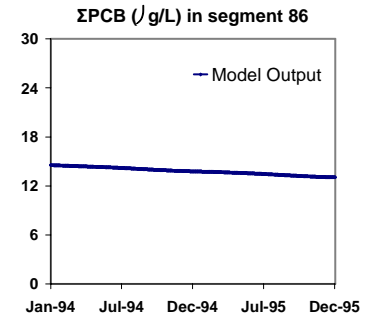
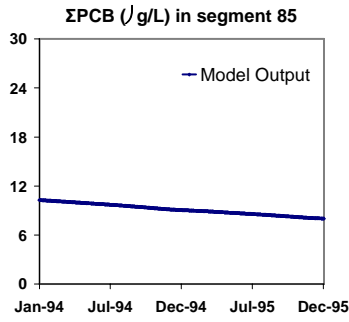
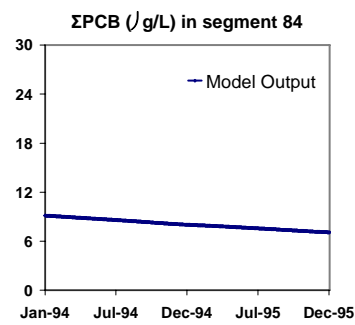
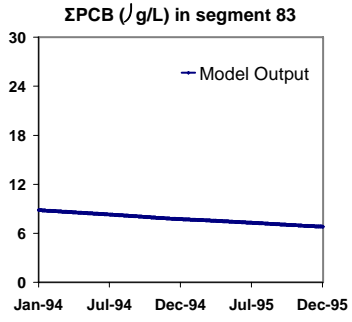
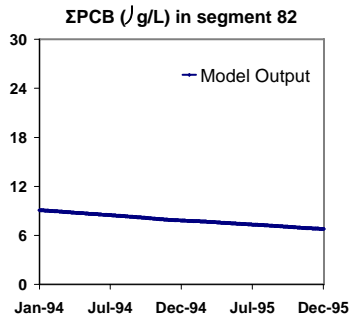
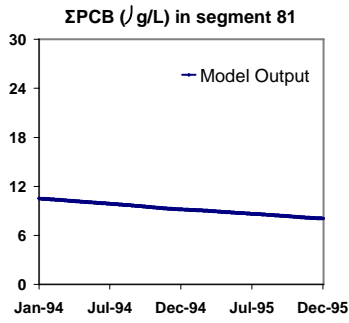
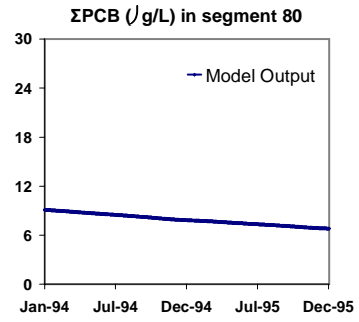
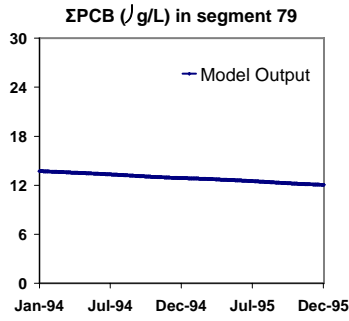
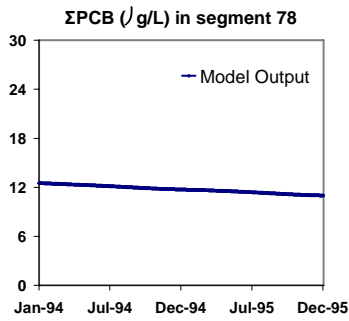

ΣPCBs in particulate phase (μg/L)
Green Bay sediment segments

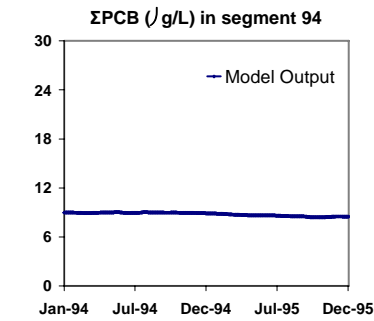
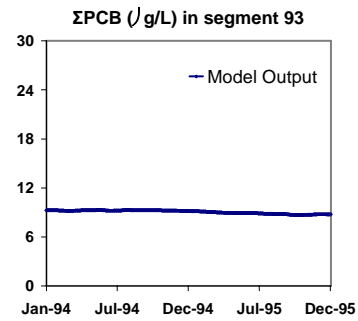
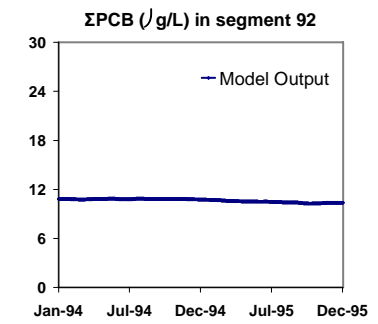
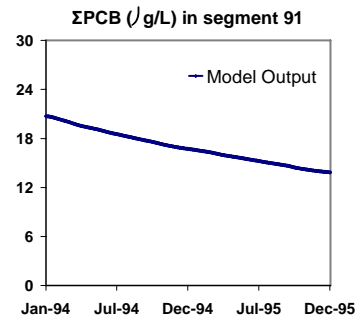
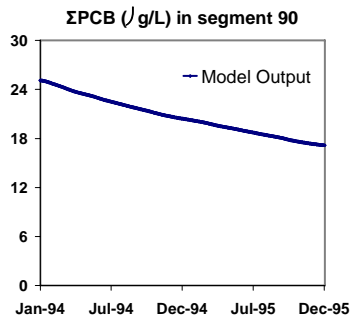
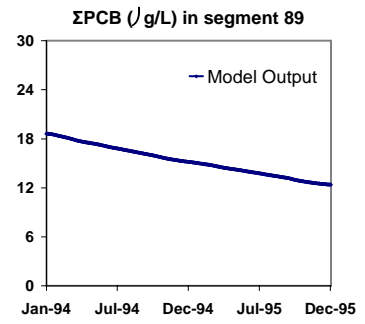
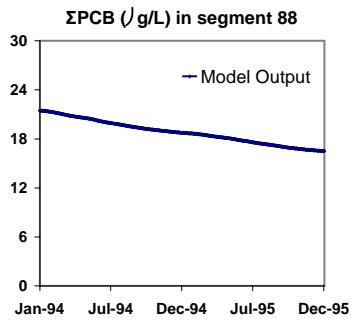
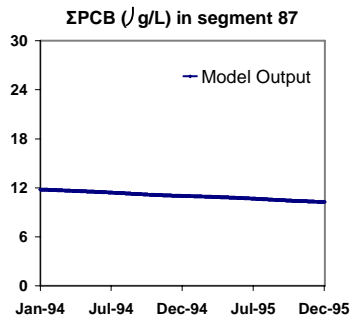

ΣPCBs in particulate phase (μg/L)
Green Bay sediment segments

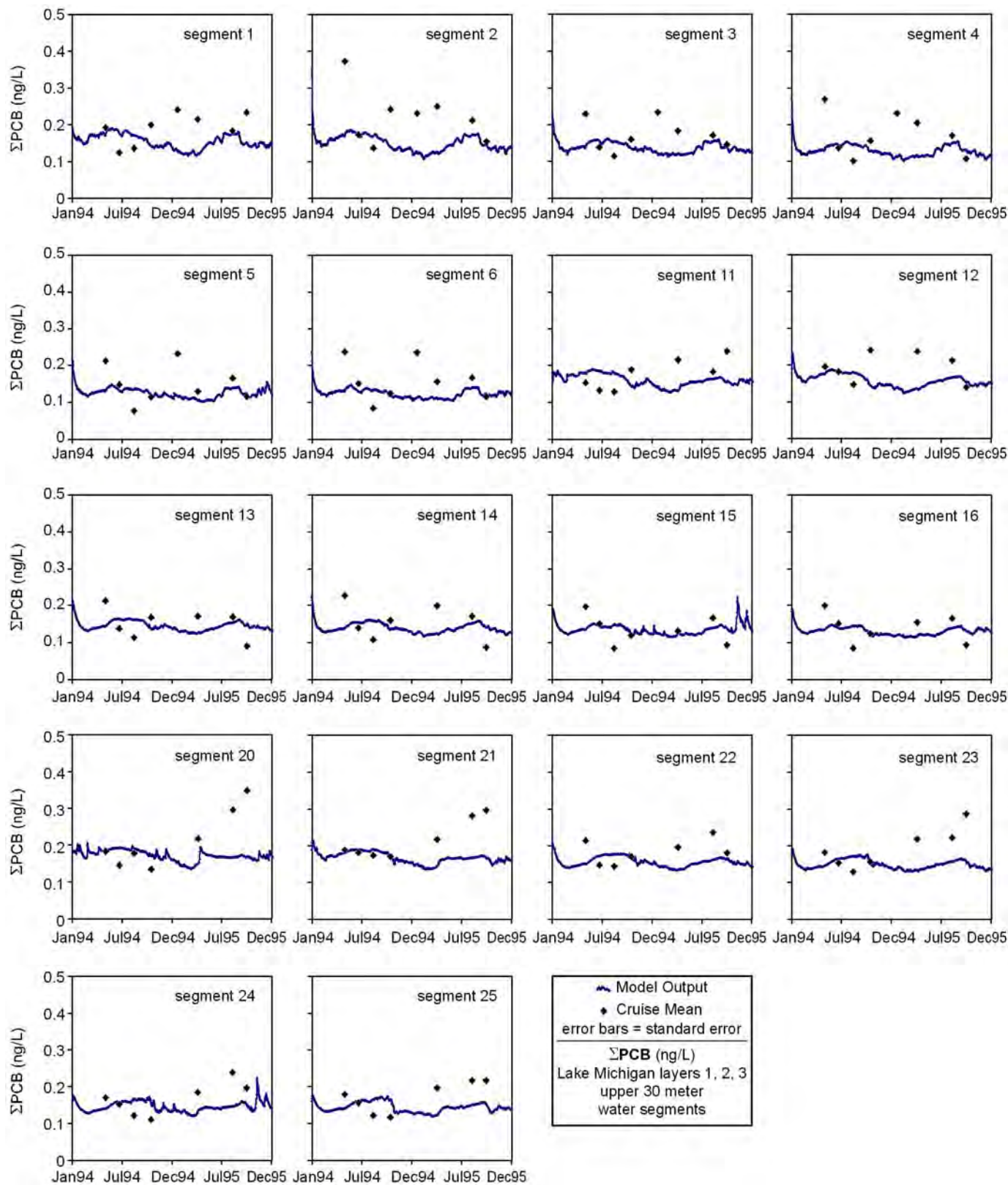

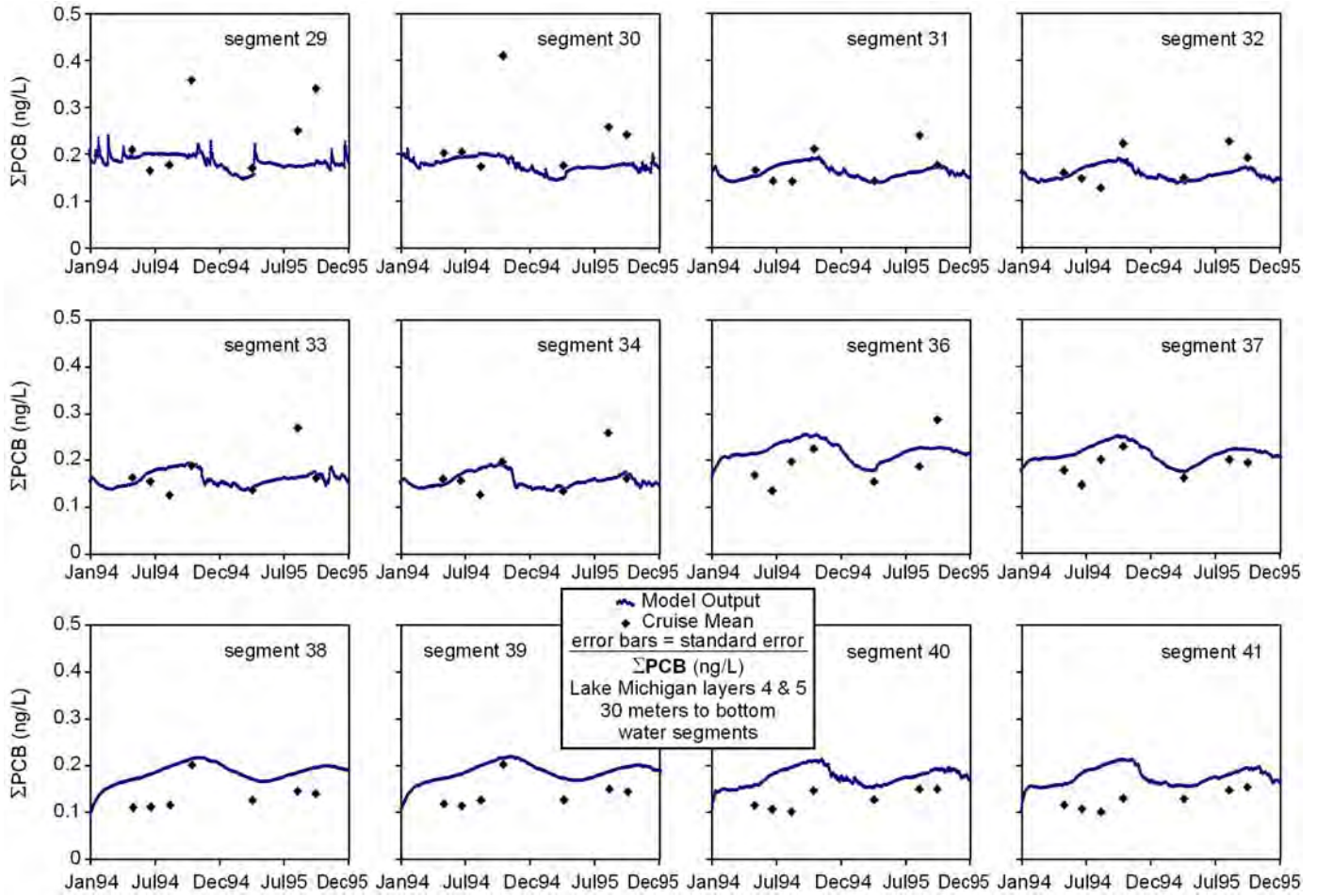

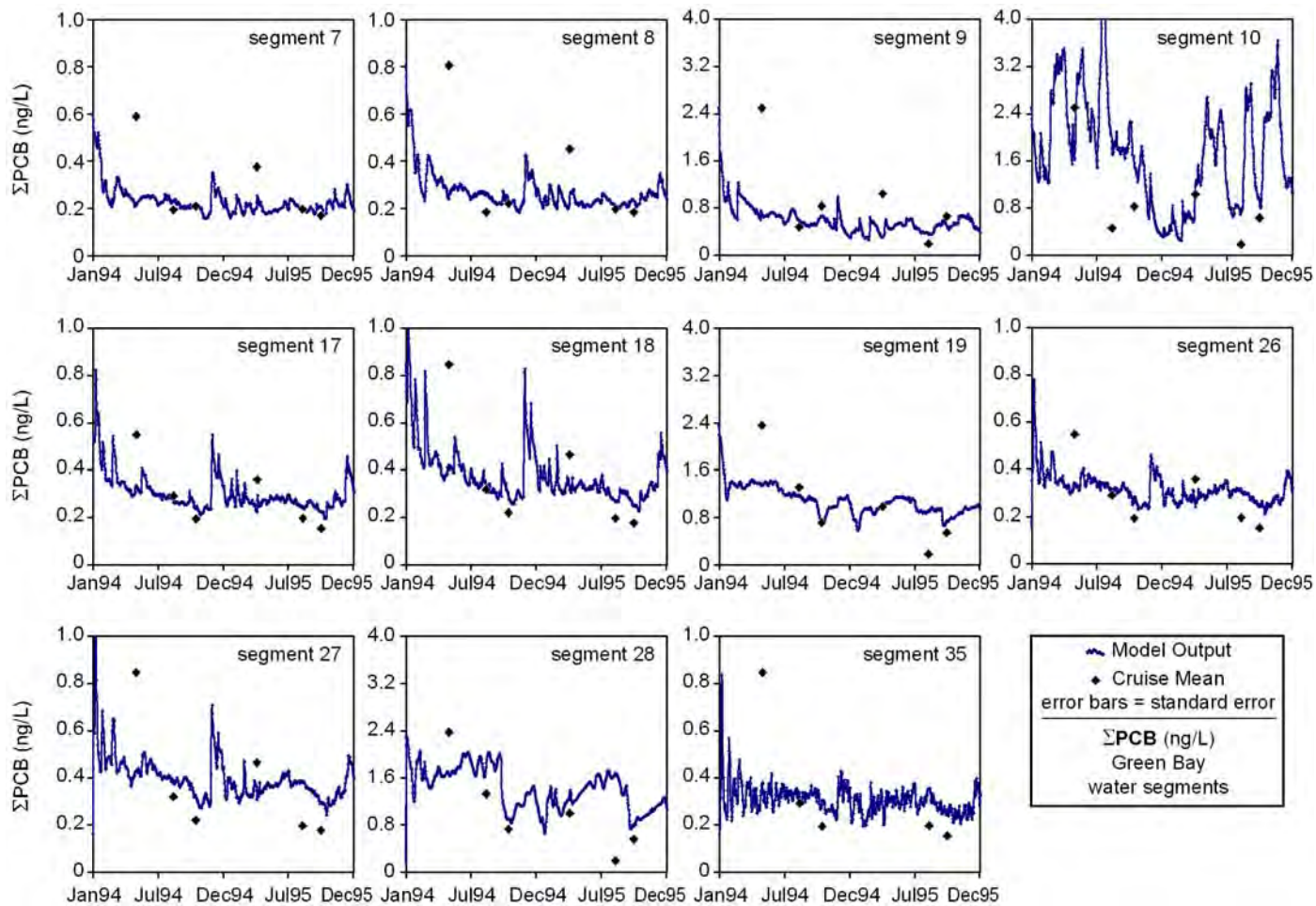

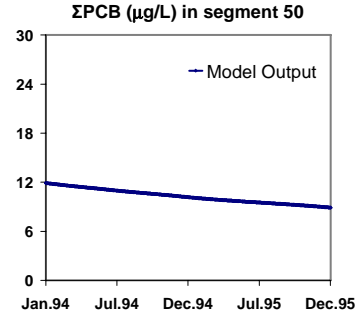
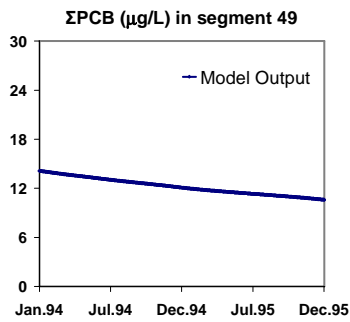
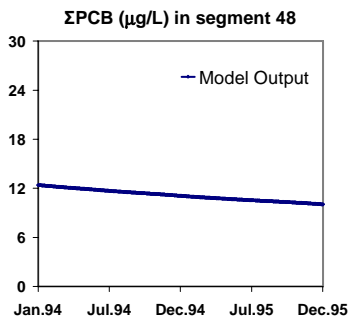
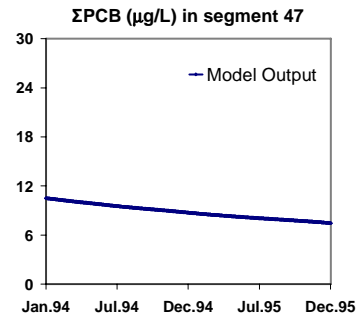
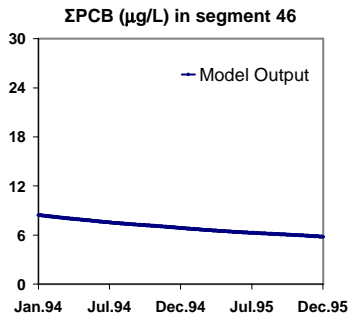
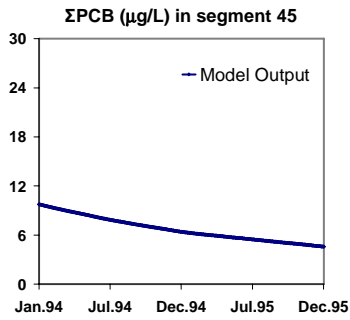
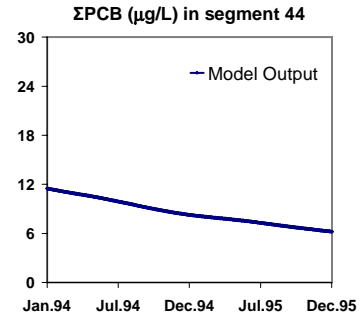
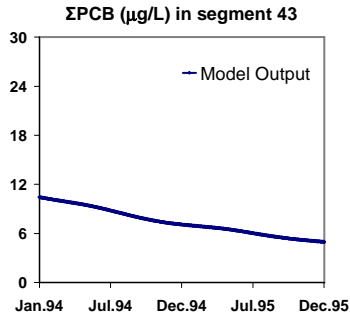
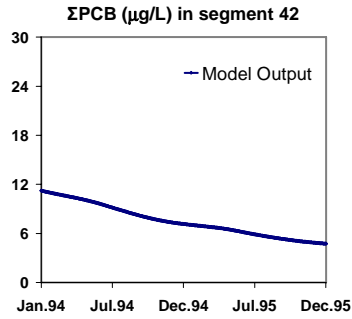

ΣPCBs (dissolved + particulate) (µg/L)
Lake Michigan sediment segments

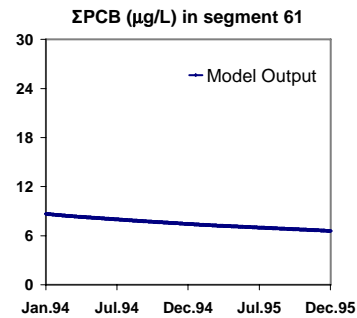
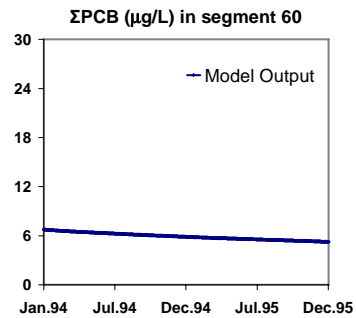
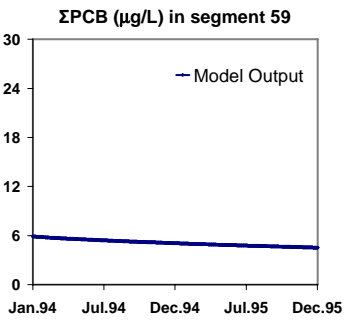
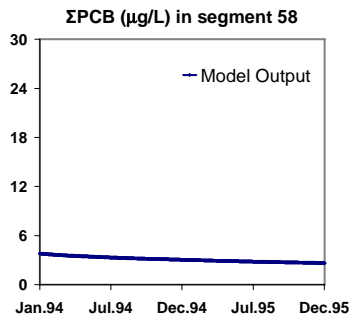
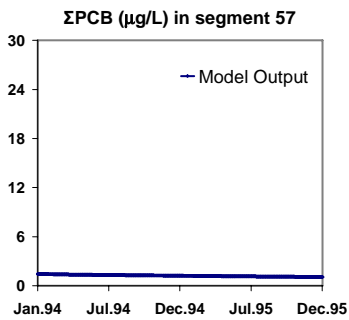
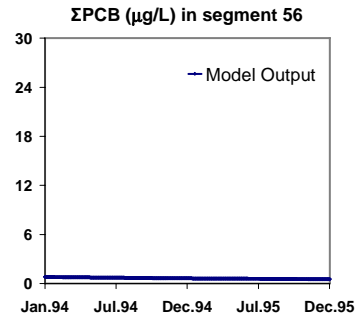
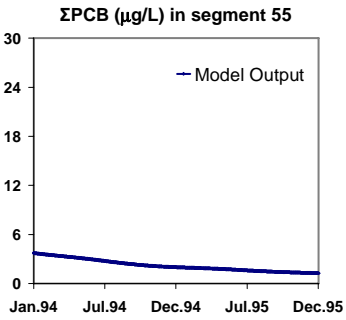
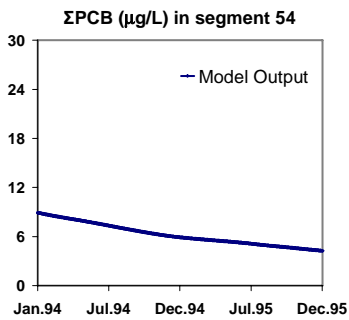
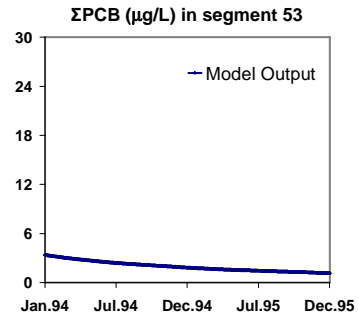
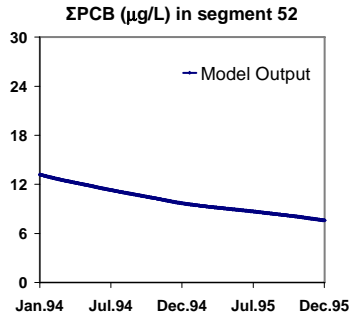
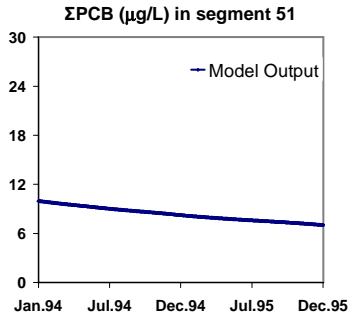

ΣPCBs (dissolved + particulate) (µg/L)
Lake Michigan sediment segments

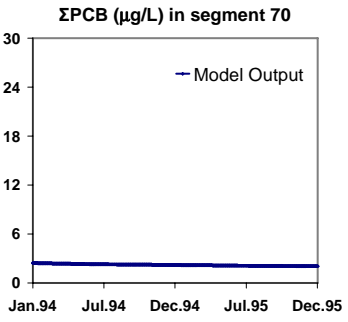
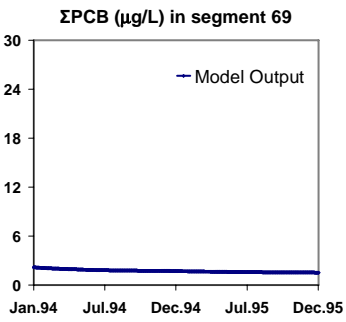
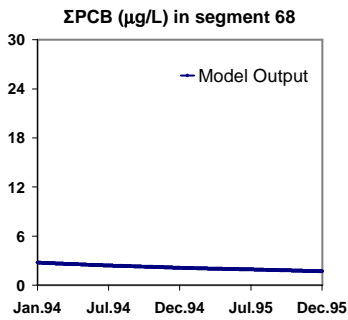
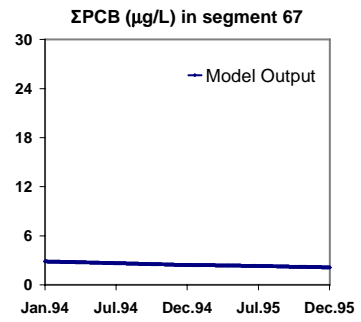
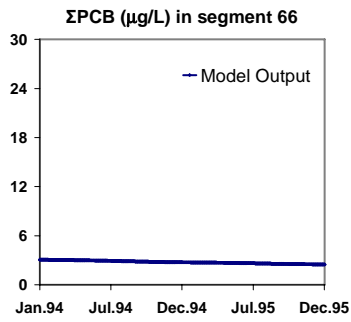
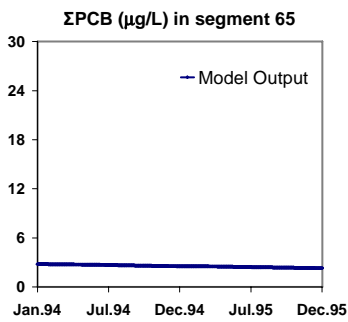
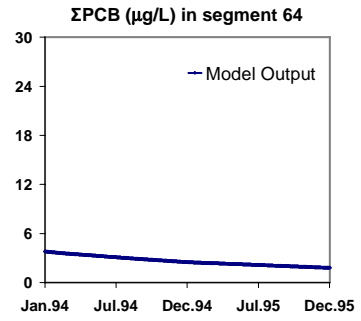
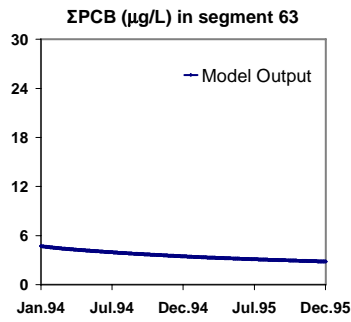
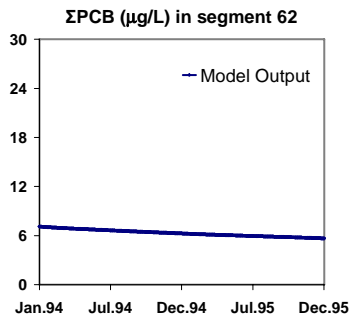

ΣPCBs (dissolved + particulate) (µg/L)
Lake Michigan sediment segments

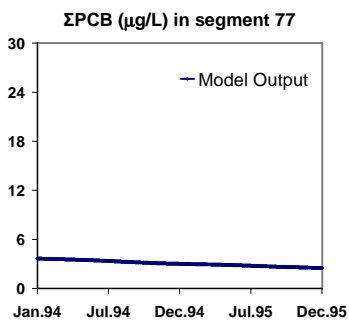
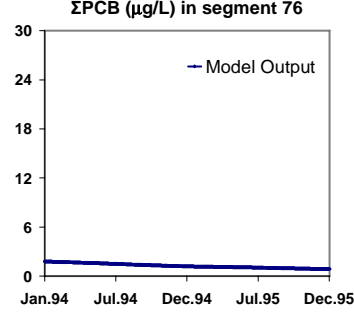
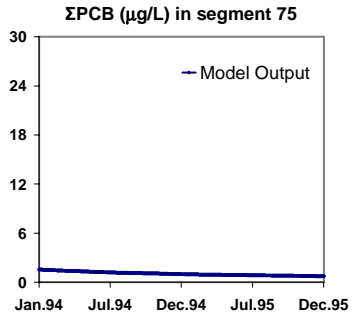
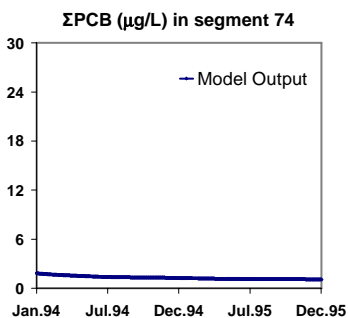
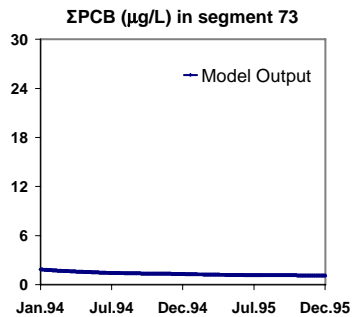
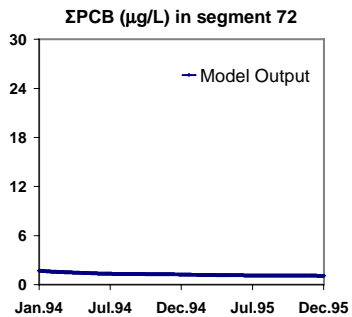
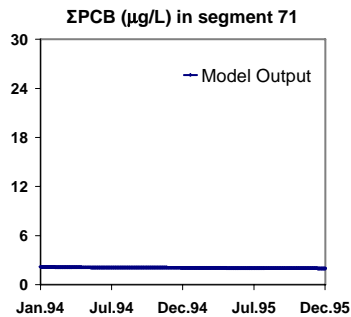

ΣPCBs (dissolved + particulate) (µg/L)
Lake Michigan sediment segments

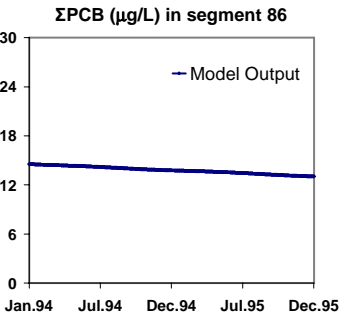
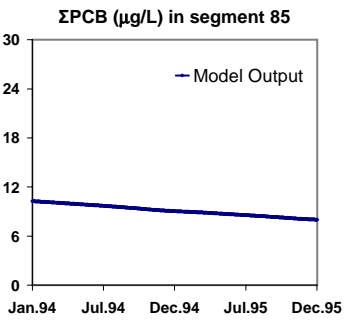
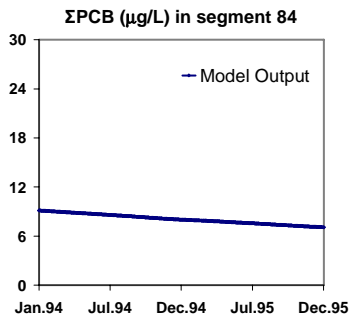
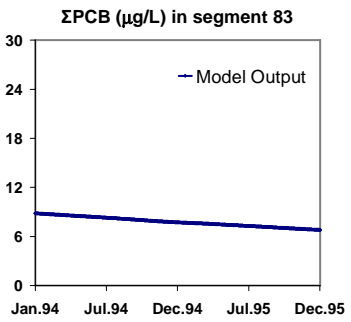
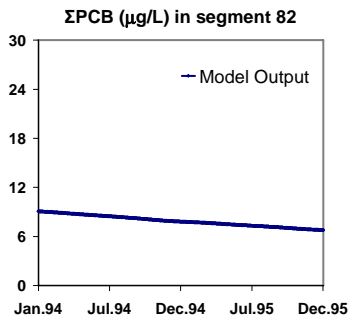
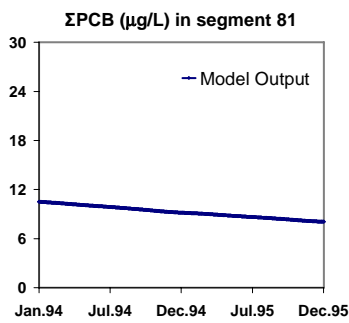
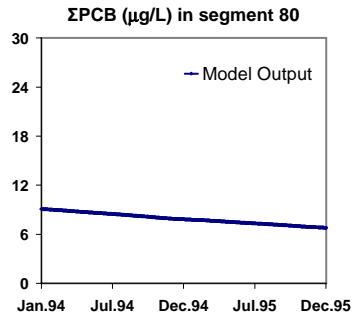
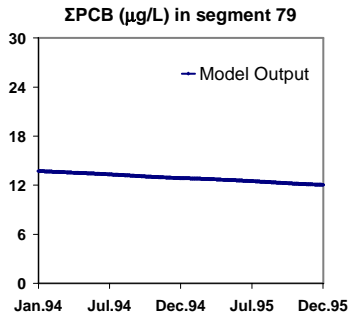
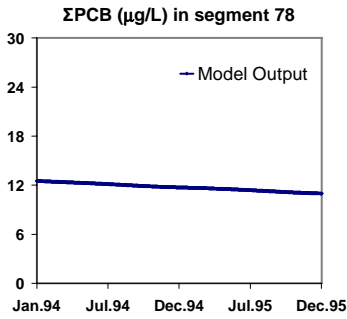

ΣPCBs (dissolved + particulate) (μg/L)
Green Bay sediment segments

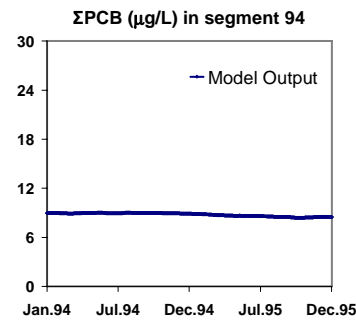
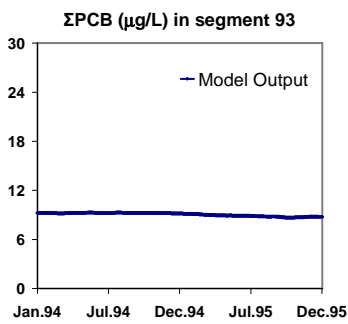
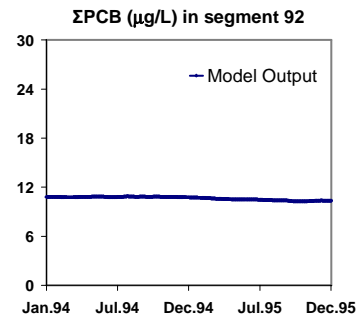
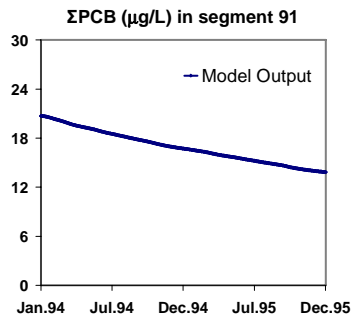
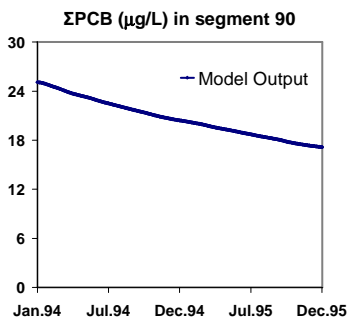
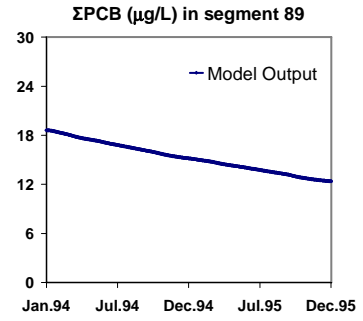
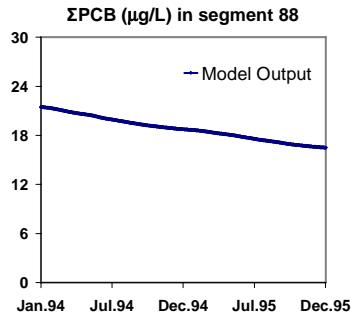
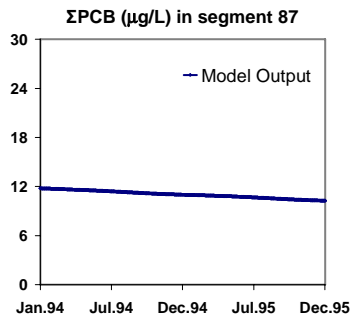

ΣPCBs (dissolved + particulate) (µg/L)
Green Bay sediment segments

Appendix 4.5.4
Simulation Results From Chloride

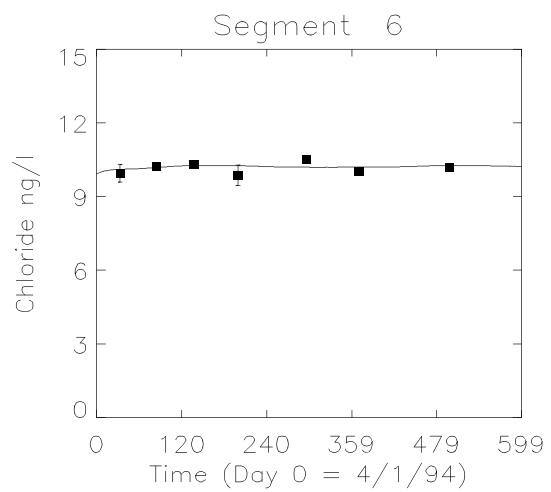
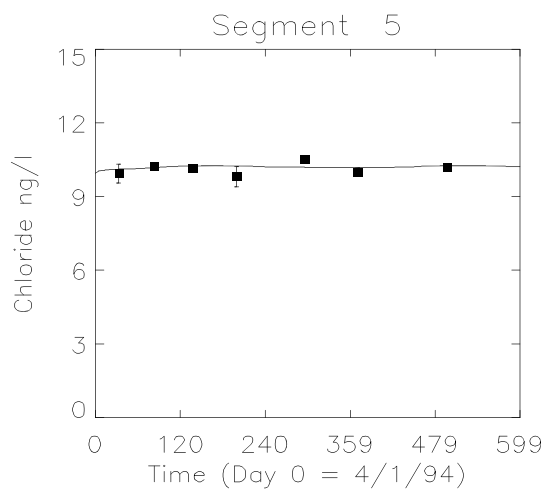
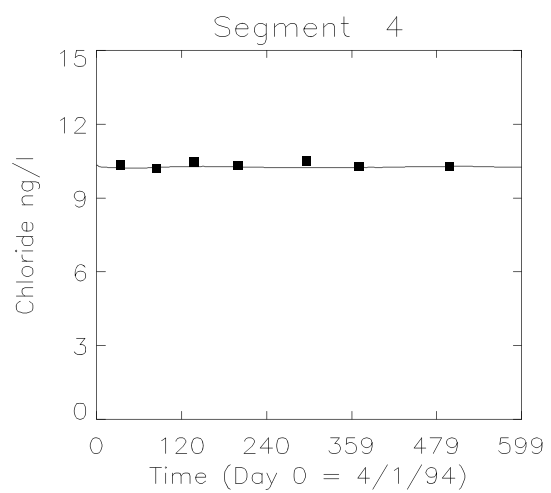
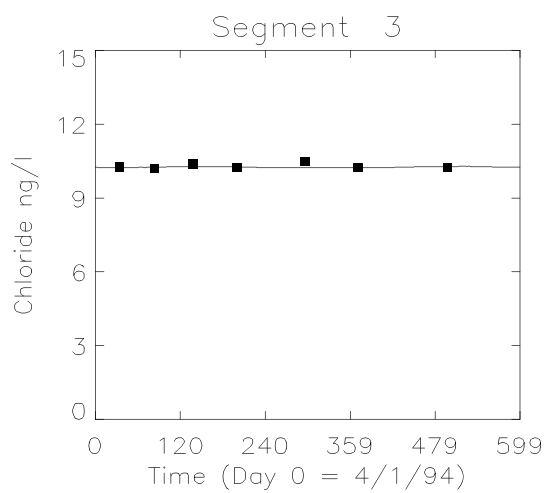
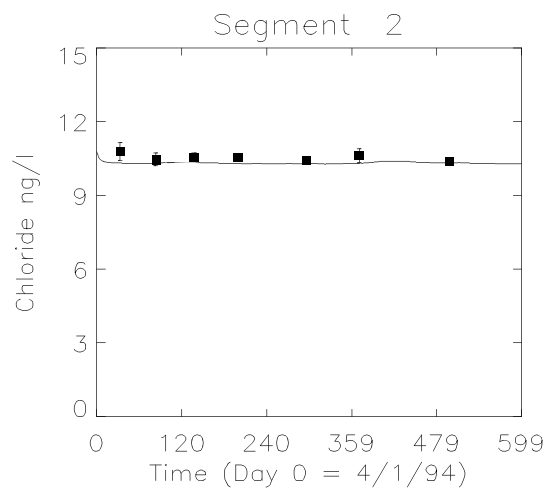
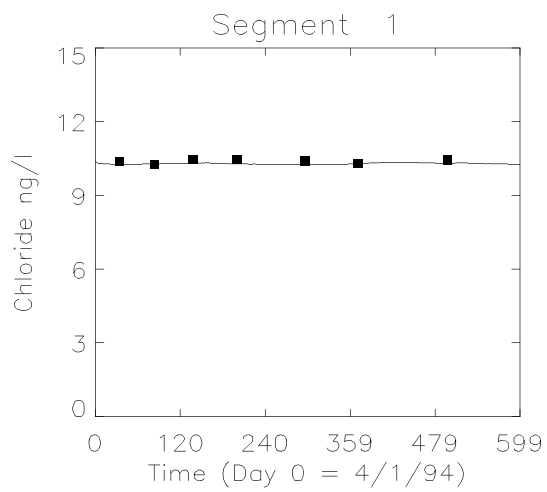

Chloride

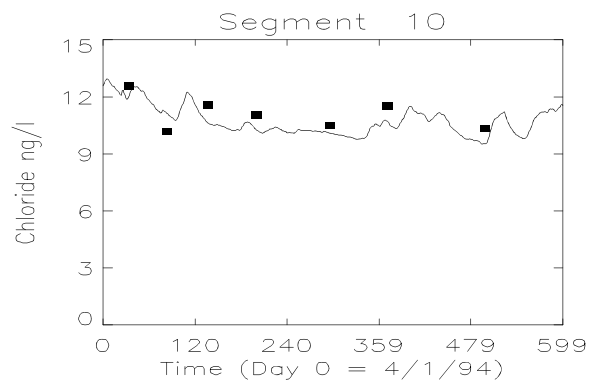
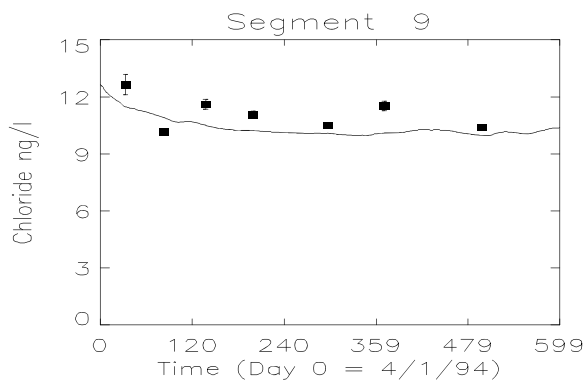
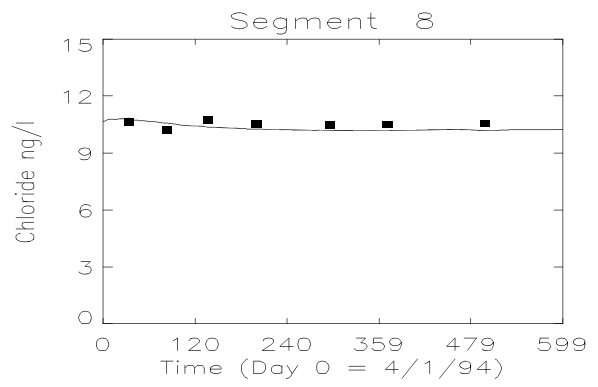
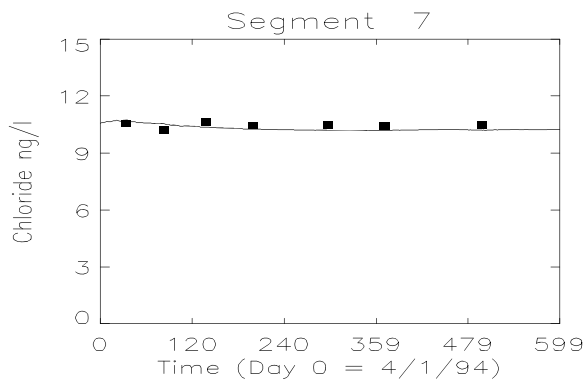

Chloride

Chloride

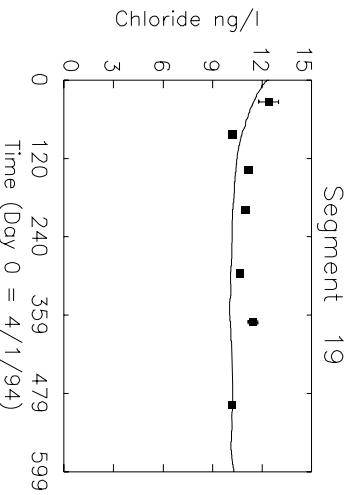
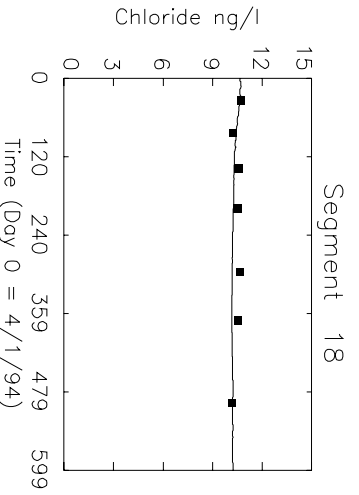
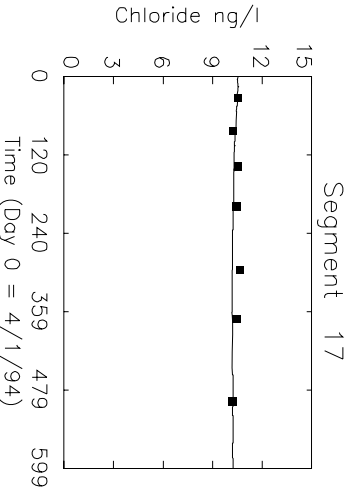
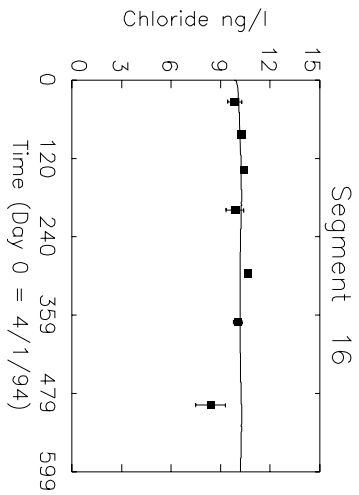
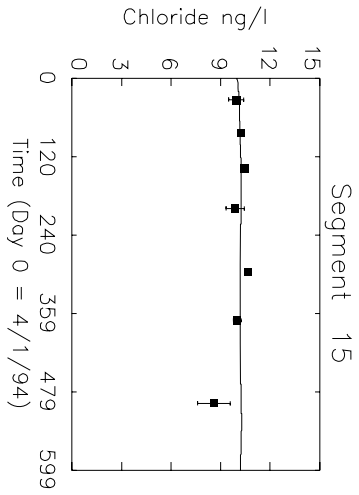
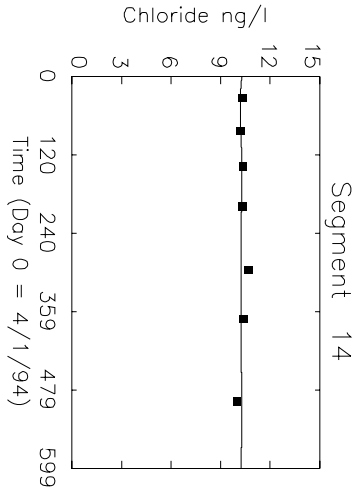
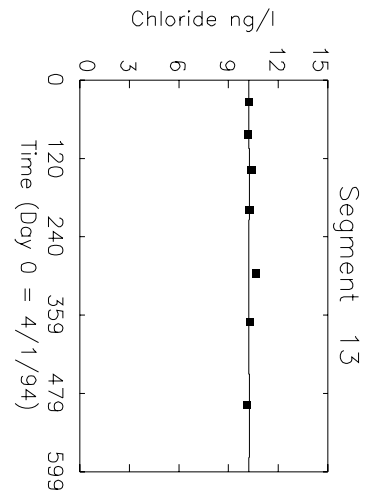
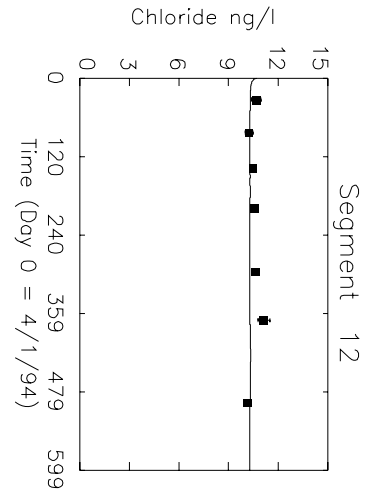
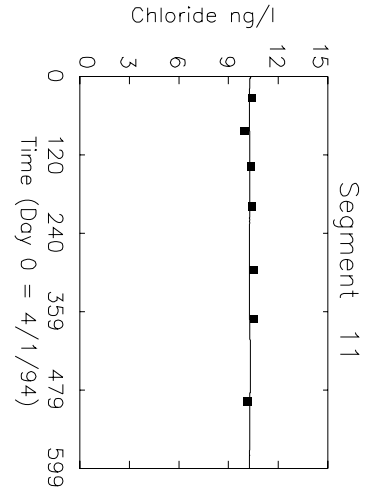

Chloride

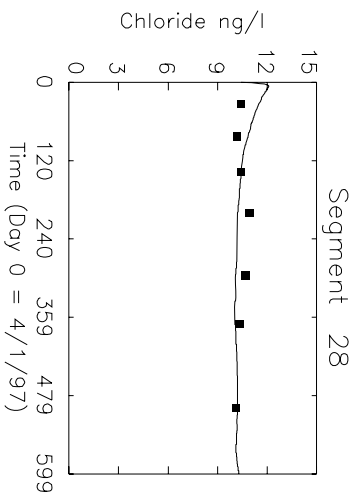
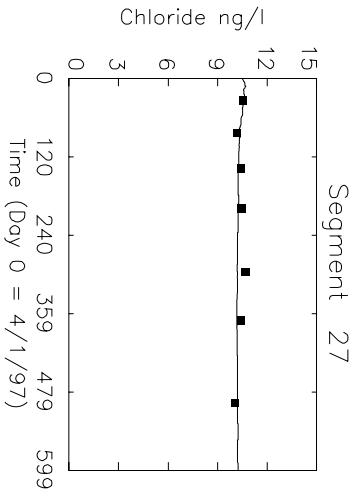
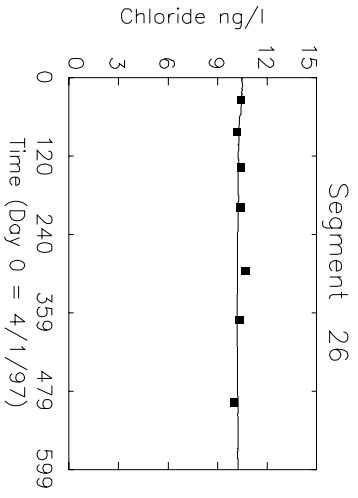
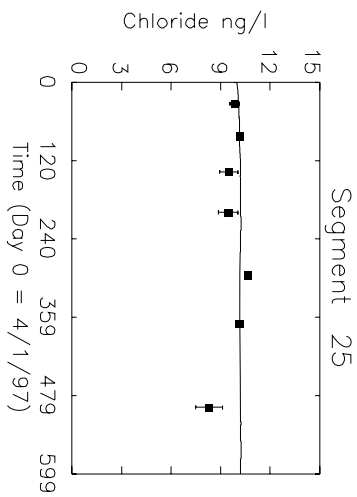
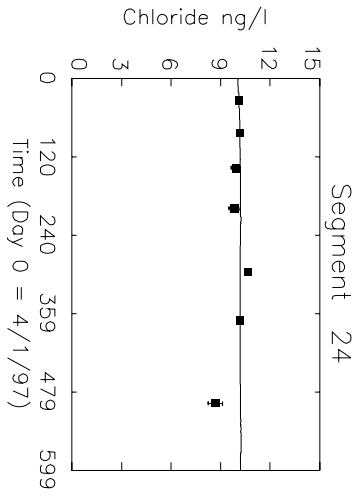
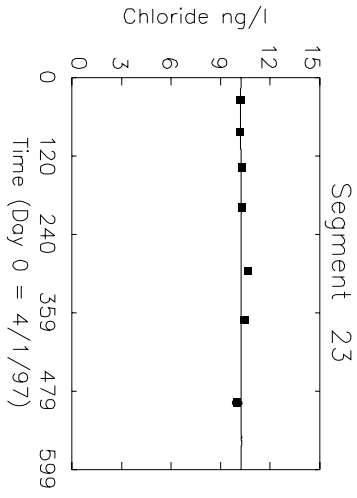
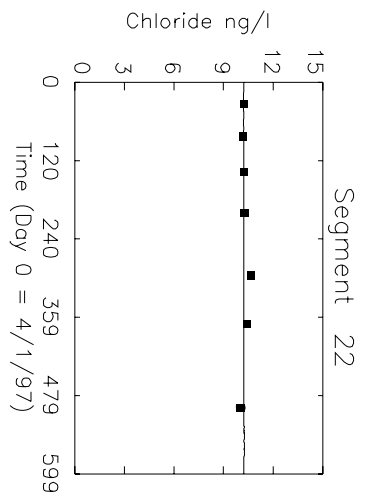
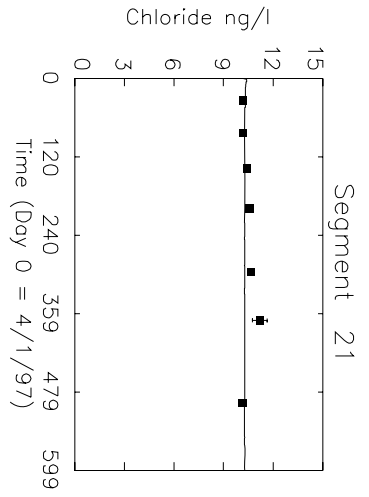
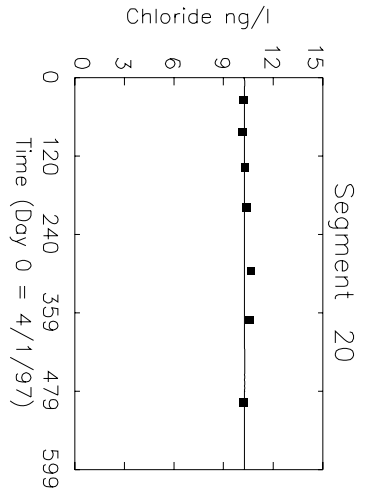

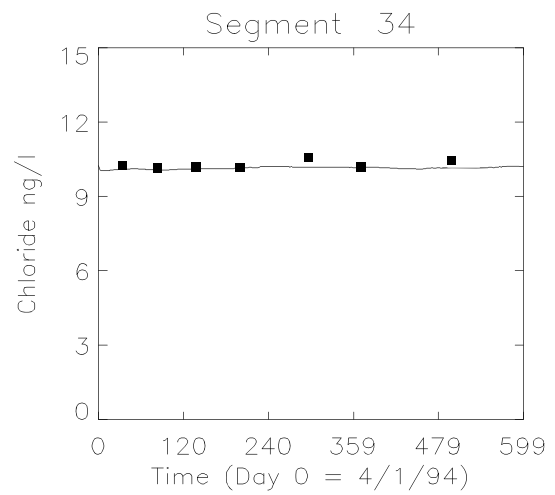
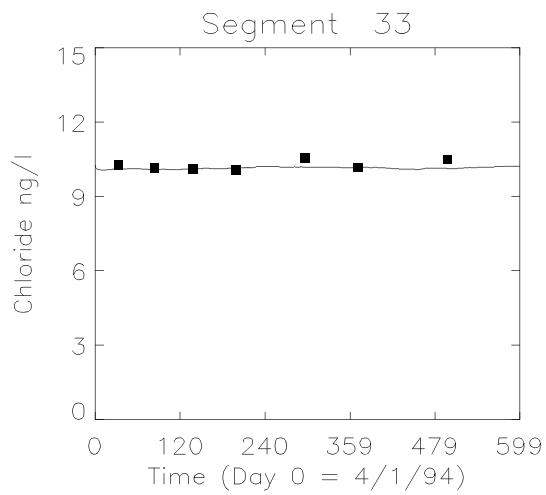
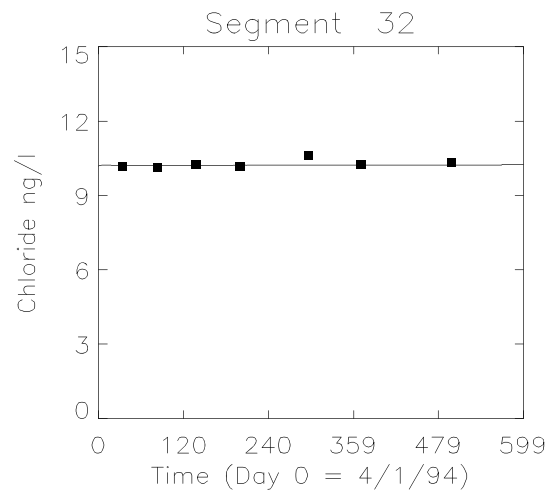
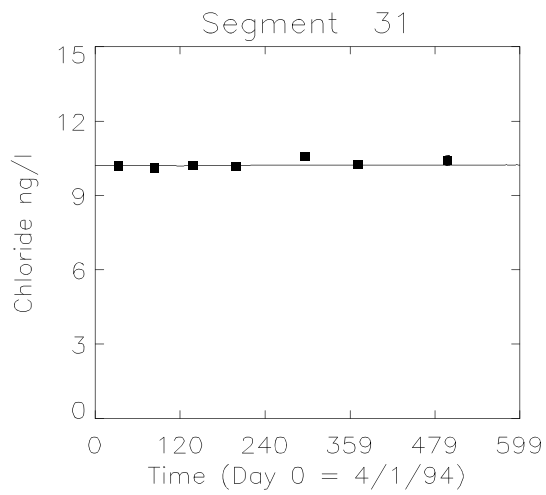
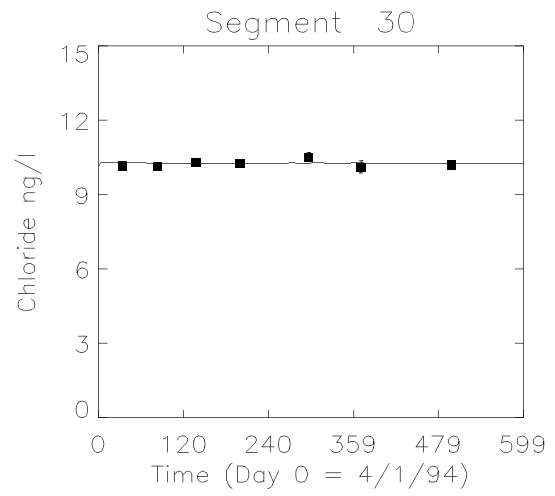
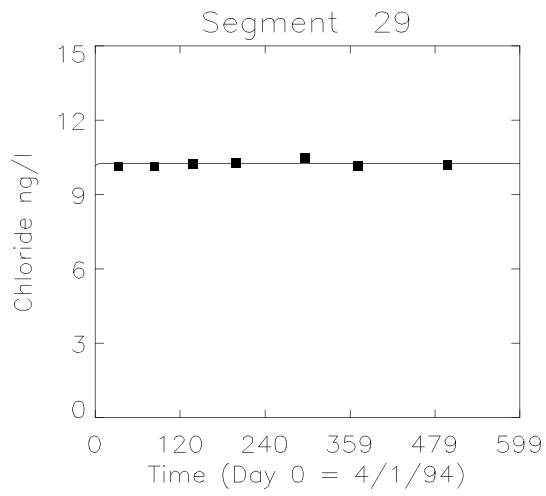

Chloride

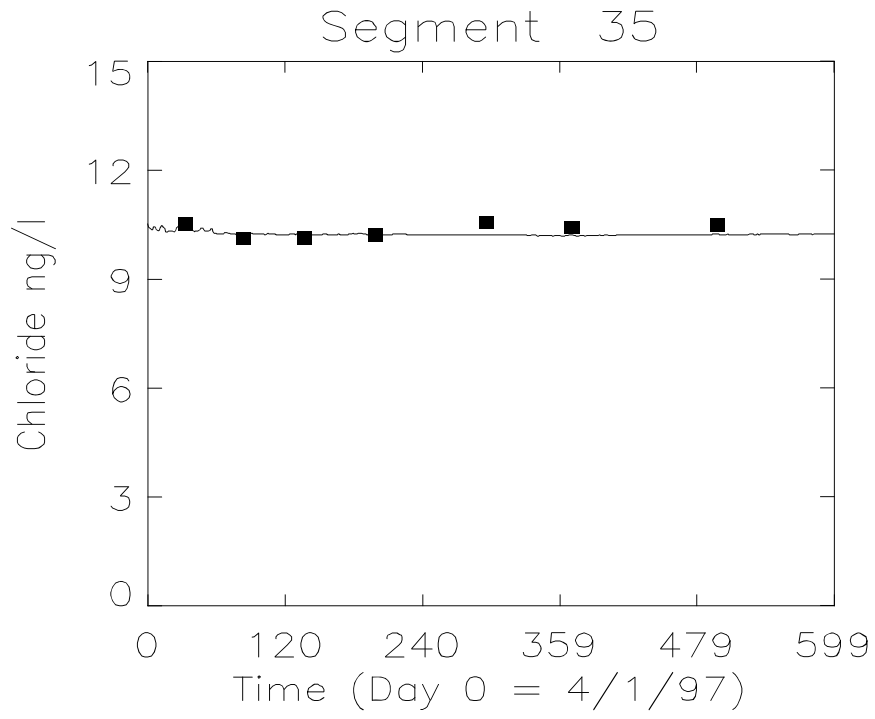

Chloride

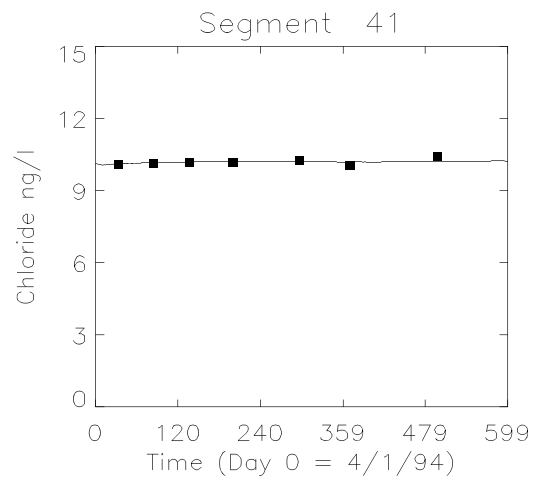
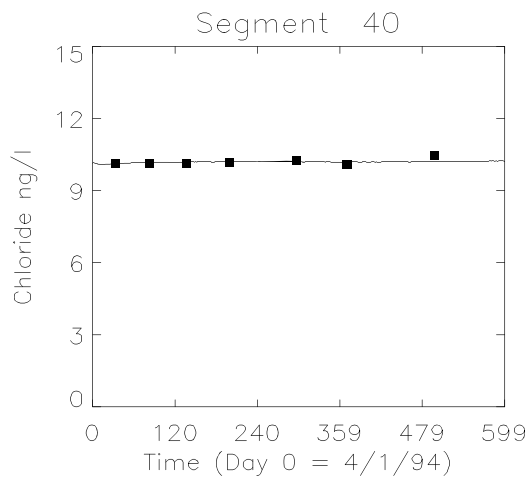
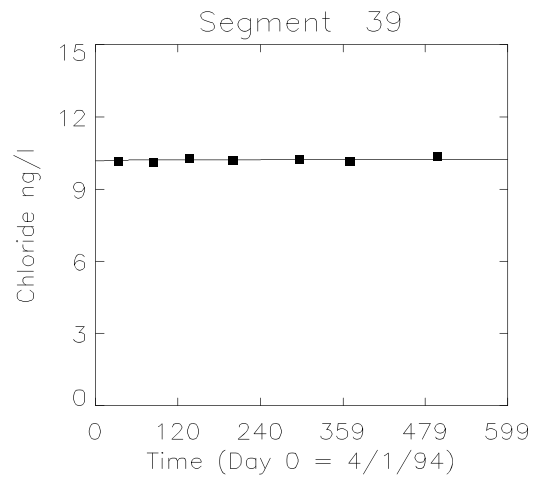
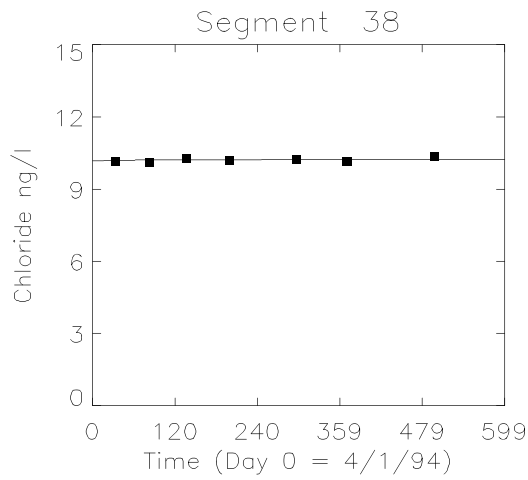
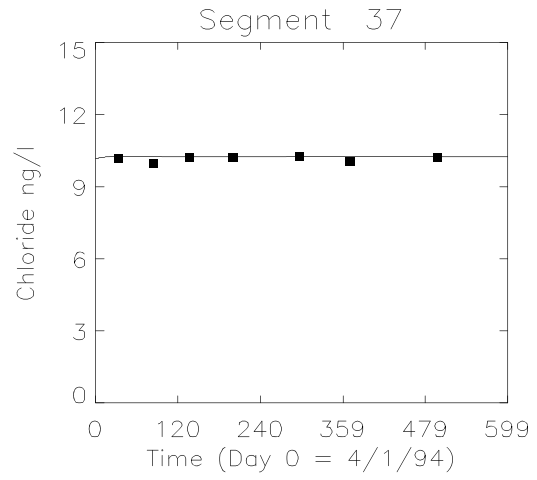
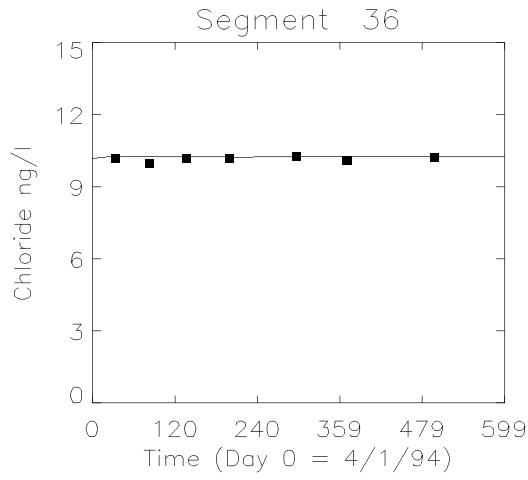

Chloride

PART 4

LM2-TOXIC

Appendix 4.5.5. Primary Production for the LM2-Toxic

Amy Anstead
Welso Federal Services, LLC
Large Lakes Research Station
9311 Groh Road
Grosse Ile, Michigan 48138

The LM2-Toxic hindcast model (1940-1995) relies on external measurements or calculations to provide the internally produced (primary production) carbon loads. There have been very few studies published that estimated lake-wide primary productivity for Lake Michigan (Fee, 1973). It is, therefore, difficult to put together a primary productivity history from 1940-1995 as required for the model hindcast. However, historical total phosphorus loads and concentration values were available, and a relationship between total phosphorus and primary productivity was used to estimate primary productivity. Lake Michigan total phosphorus loads were estimated from 1974-1991 by the International Joint Commission (IJC) (Great Lakes Water Quality Board, 1989; Pauer *et al.*, 2006), and for 1994-1995 as part of Lake Michigan Mass Balance Project (LMMBP) (described in Part 2). Prior to 1974, there were only a few reports published that documented measured total phosphorus loads (Patalas, 1972; Lee 1974). However, total phosphorus loads from 1800-1970 were estimated using a model that incorporated phosphorus sources and sinks for the Great Lakes (Chapra, 1977). There were reliable lake-wide total phosphorus concentration data from 1976 to present and measurements dating back to the 1950s (Risley and Fuller, 1965; Rockwell *et al.*,

1980). In most cases the data prior to 1976 were location specific, and it was difficult to extrapolate the results to obtain a representative lake-wide total phosphorus concentration.

Modeled loads from 1800-1850 (Chapra, 1977) were higher than measured total phosphorus loads from 1994-95 (Figure 4.5.5.1). It was curious that measured total phosphorus loads in recent times of higher anthropogenic phosphorus input (1994-1995) were lower than modeled total phosphorus loads during the pre-Western civilization period (1800-1850). There seemed to be a disconnect between the measured loads of recent times and the loads modeled for the 1800s. The model simulation was recreated and extended until 2000. As expected, the model overpredicted total phosphorus loads when compared with the measured data (Figure 4.5.5.1). Improvements were made to the model parameters which resulted in a better fit to the measured data from 1974-1995 (Figure 4.5.5.1). Modifications to the model included decreasing phosphorus export coefficients for land use, decreasing per capita detergent phosphorus export and decreasing atmospheric phosphorus loads. All modifications made fell within reported literature values for the Great Lakes system (Reckhow and Simpson, 1980; Rast and Lee, 1983; U.S. Environmental Protection Agency, 1976). The model also simulated annual average surface water total phosphorus concentration for Lake Michigan by simply dividing modeled total phosphorus load by lake volume. Modeled total phosphorus concentration compared well to measured total phosphorus concentration values for Lake Michigan (Rockwell *et al.*, 1980; Risley and Fuller, 1965; Beeton and Moffett, 1964;

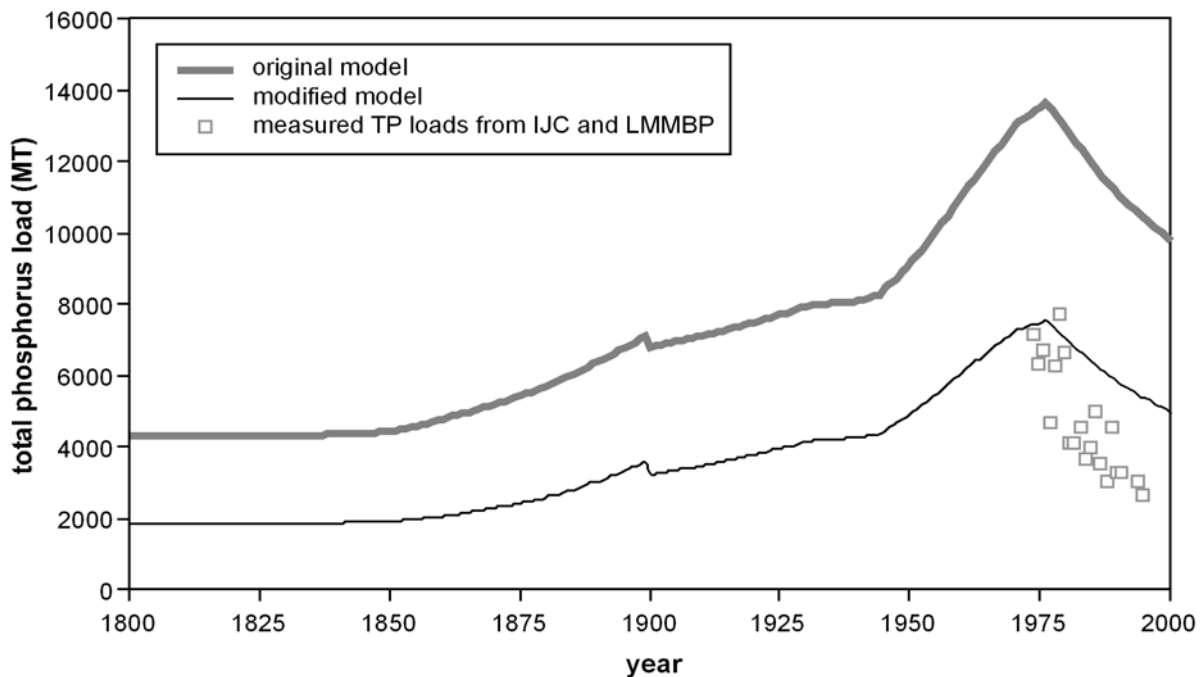

Figure 4.5.5.1. Model data versus measured total phosphorus loads.

Holland, 1969; Rousar and Beeton, 1973) (Figure 4.5.5.2). The adjusted model output provided a complete annual average total phosphorus concentration history from which primary productivity was calculated.

Vollenweider *et al.* (1974) established a relationship between total phosphorus load and primary productivity but it was limited by few values from a time when phosphorus loads and primary productivity were at their highest in Lake Michigan's history. The relationship was not as strong for years with lower total phosphorus loads. We established a total phosphorus-primary productivity relationship (Figure 4.5.5.3) from the output of a 1976-1995 hindcast of the eutrophication model, LM3-Eutro. This relationship was used to calculate lake-wide annual primary productivity from 1940-1995. Total phosphorus concentration history. Final annual primary production (as organic carbon) was provided as a spreadsheet for incorporation into LM2-Toxic.

References

- Beeton, A.M. and J.W. Moffett. 1964. Lake Michigan Chemical Data, 1954-55, 1960-61. U.S. Department of the Interior, U.S. Fish and Wildlife Service, Ann Arbor, Michigan. Data Report 6.
- Chapra, S.C. 1977. Total Phosphorus Model for the Great Lakes. *J. Environ. Engin.*, 103(EE2):147-161.
- Fee, E.J. 1973. A Numerical Model for Determining Primary Production and Its Application to Lake Michigan. *J. Fish. Res. Board Canada*, 30(10):1447-1468.
- Great Lakes Water Quality Board. 1989. 1987 Report on Great Lakes Water Quality, Appendix B: Great Lakes Surveillance, Volume I. International Joint Commission, Windsor, Ontario, Canada. 287 pp.

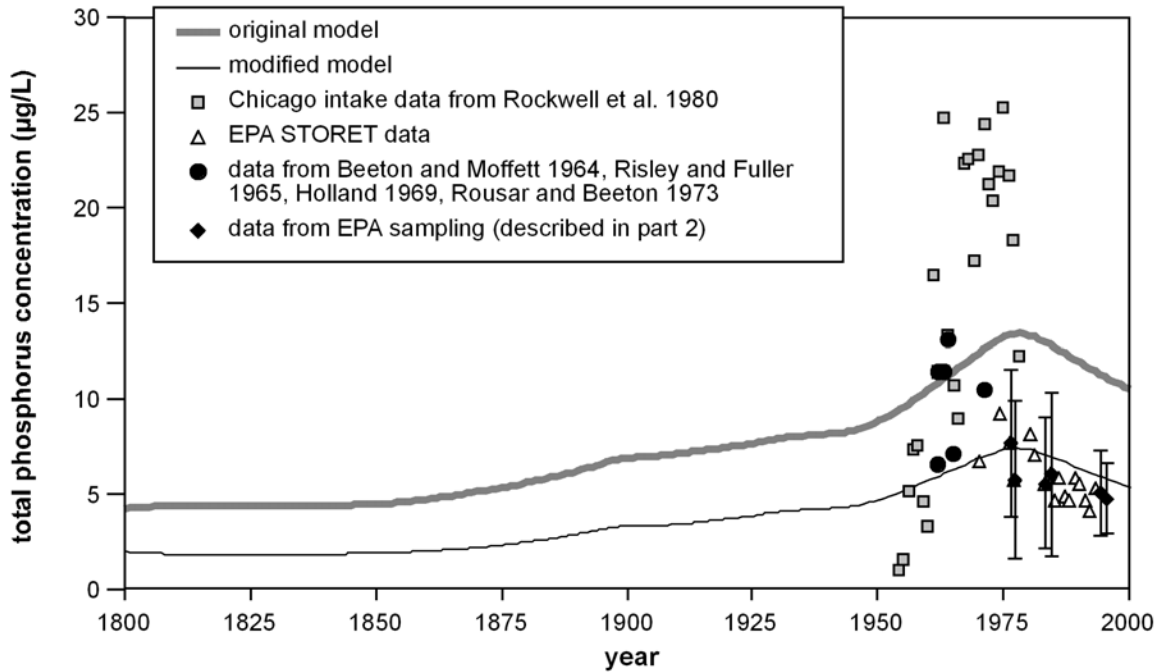

Figure 4.5.5.2. Model output versus measured total phosphorus concentration data. Error bars are ± 1 standard deviation.

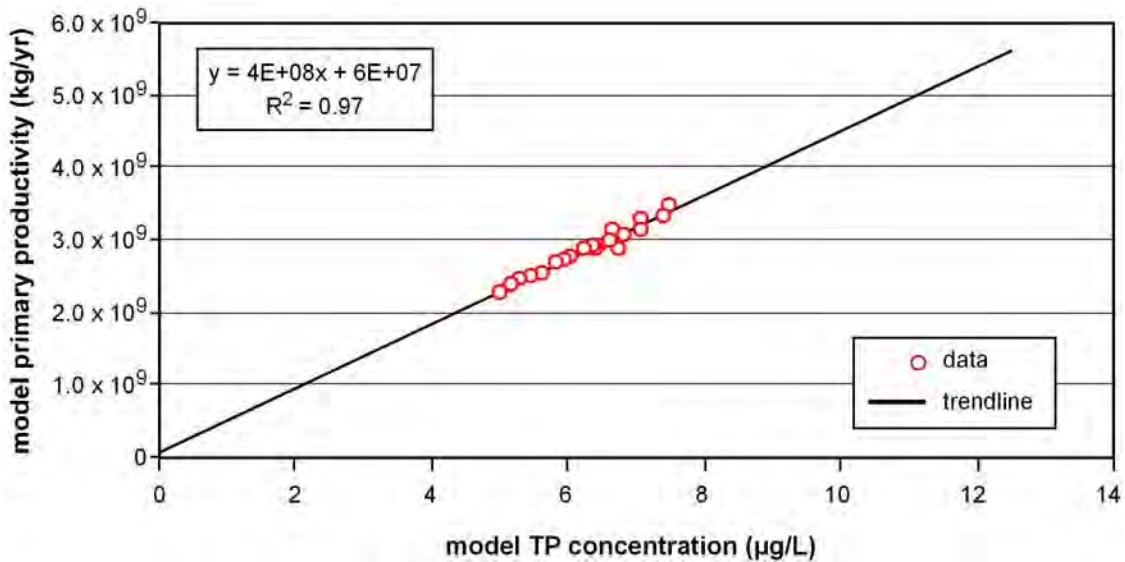

Figure 4.5.5.3. Relationship between lake-wide total phosphorus concentration and primary productivity based on model output from the LM3-Eutro model.

-
- Holland, R.E. 1969. Seasonal Fluctuations of Lake Michigan Diatoms. *Limnol. Oceanogr.*, 14(3):423-436.
- Lee, G.F. 1974. Phosphorus, Water Quality and Eutrophication of Lake Michigan. Proceedings of the Fourth Session of the 1972 Conference on Pollution of Lake Michigan and Its Tributary Basin by Illinois, Indiana, Michigan, and Wisconsin. U.S. Environmental Protection Agency, Region V, Chicago, Illinois.
- Patalas, K. 1972. Crustacean Plankton and the Eutrophication of St. Lawrence Great Lakes. *J. Fish. Res. Board Canada*, 29(11):1451-1462.
- Pauer, J.J., A.M. Anstead, K.W. Taunt, W. Melendez, and R.G. Kreis, Jr. 2006. The Lake Michigan Eutrophication Model, LM3-Eutro: Model Development and Calibration. Submitted for publication to the *Canadian J. Fish. Aquat. Sci.*
- Rast, W. and G.F. Lee. 1983. Nutrient Loading Estimates for Lakes. *J. Environ. Engin.*, 109(2):502-517.
- Reckhow, K.H. and J.T. Simpson. 1980. A Procedure Using Modeling and Error Analysis for the Prediction of Lake Phosphorus Concentration From Land Use Information. *Canadian J. Fish Aquat. Sci.*, 37(9):1439-1448.
- Risley, C. and F. Fuller. 1965. Chemical Characteristics of Lake Michigan. In: Proceedings of the Eighth Conference on Great Lakes Research, pp. 168-174. Great Lakes Research Division, The University of Michigan, Ann Arbor, Michigan.
- Rockwell, D.C., C.V. Marion, M.F. Palmer, D.S. DeVault, and R.J. Bowden. 1980. Environmental Trends in Lake Michigan. In: R.C. Loehr, C.S. Martin, and W. Rast (Eds.), *Phosphorus Management Strategies for Lakes*, Chapter 5, pp. 91-132. Ann Arbor Science Publishers, Incorporated, Ann Arbor, Michigan.
- Rousar, D.C. and A.M. Beeton. 1973. Distribution of Phosphorus, Silica, Chlorophyll *a*, and Conductivity in Lake Michigan and Green Bay. In: E. McCoy (Ed.), *Transactions of the Wisconsin Academy of Sciences, Arts, and Letters*, pp. 117-140. University of Wisconsin, Madison, Wisconsin.
- U.S. Environmental Protection Agency. 1976. *Areawide Assessment Procedures Manuals. Volume 2.* U.S. Environmental Protection Agency, Municipal Environmental Research Laboratory, Cincinnati, Ohio. EPA/600/9-76/014, 427 pp.
- Vollenweider, R.A., M. Munawar, and P. Stadelmann. 1974. A Comparative Review of Phytoplankton and Primary Production in the Laurentian Great Lakes. *J. Fish. Res. Board Canada*, 31(5):739-762.

PART 4

LM2-TOXIC

Chapter 6. The LM2-Toxic Application and Interpretation

One of the important goals during the development of the LM2-Toxic was to quantitatively understand polychlorinated biphenyl (PCB) dynamics (i.e., transport and fate of PCBs) in the Lake Michigan system and delineate the relationship between PCB external loads and its concentrations in the system. For the following discussion, Lake Michigan refers to the main part of the lake (main lake) only, excluding Green Bay. Any references to the Lake Michigan system should be considered to include both Green Bay and Lake Michigan. Lake Michigan system = Lake Michigan + Green Bay. Main lake = Lake Michigan. After calibration of organic carbon and PCB congener dynamics and model confirmation, the LM2-Toxic was used as a mass budget diagnostic tool to identify the critical contaminant sources and sinks and key environmental processes in Lake Michigan and Green Bay. The model was also applied for forecasting the long-term responses of the Lake Michigan system to a variety of forcing functions and load reduction scenarios for PCBs. The mass budget analysis and the long-term forecasts under the specified load reductions were intended to provide information useful in making management decisions for the Lake Michigan system. Long-term PCB exposure concentrations predicted from the LM2-Toxic for various forcing functions and load reduction scenarios were provided to LM Food Chain as forcing functions to compute PCB concentrations in fish tissue.

4.6.1 Conversion of PCB Congener Results to Total PCBs

LM2-Toxic is a PCB congener-based model. It was developed to compute the concentrations, total mass, and mass movement (fluxes) of 54 PCB congeners in each compartment of the Lake Michigan system. These 54 PCB congeners account for about 63% to 85% of the total PCB mass in the various media (see Table 3.1.1 for the list of ratios between total PCBs and the summed modeling congeners in all media). There were enormous amounts of information related to the model inputs and outputs from the model on a basis of each PCB congener. For the efficiency and effectiveness of presenting the input information and results from the model, and for the convenience of the reviewers and readers, all numbers in this chapter are presented as total PCBs. The model outputs for each Lake Michigan Balance Project (LMMBP) selected PCB congener were first summed as Σ PCBs, and the Σ PCBs was then converted to total PCBs using a regression between total PCBs and Σ PCBs. The regression analysis for different media was done by Computer Sciences Corporation (CSC)/Large Lakes Research Station (LLRS) personnel and is detailed in Part 1, Chapter 3 of this report. The regression equations used in this chapter for the specified media are listed in Table 4.6.1. More information on regression equations for all media can be found in Table 1.3.1.

4.6.2 Mass Budget Diagnosis of the LM2-Toxic for the LMMBP Period

A mass budget diagnostic tool was developed within the LM2-Toxic in order to quantitatively analyze the

Table 4.6.1. Regression Equations Used for Converting ΣPCBs to Total PCBs for the LM2-Toxic Results

Media	Regression Equation	R ²
Dissolved Water	$y = 1.2738x + 0.0268$	0.9413
Particulate Water	$y = 1.2251x + 0.0051$	0.9992
Dissolved + Particulate Water	$y = 1.2427x + 0.0347$	0.9829
Surficial Sediment	$y = 1.1668x + 0.6125$	0.9970

behavior of PCBs in the Lake Michigan system. This tool has the ability to estimate very detailed PCB mass fluxes in the lake, mass inventories in different compartments of the lake, phase distributions, and contaminant residence times in the system. Therefore, the results of the mass budget diagnosis were used to demonstrate the most significant PCB sources and sinks and to identify key environmental processes in the Lake Michigan system.

A mass budget diagnosis was performed for each selected PCB congener modeled in the LM2-Toxic for the two-year LMMBP period (1994-1995). The final results of the mass budget diagnosis are presented as the annual total PCBs only. Figures 4.6.1 and 4.6.2 provide a summary of the results of the total PCB mass budget diagnosis and analysis in Lake Michigan and Green Bay. Figure 4.6.1 depicts the masses transported and inventories for the entire Lake Michigan system that includes Green Bay. Figure 4.6.2 depicts the mass transported and inventories for Green Bay separately from the main lake. Table 4.6.2 lists more detailed results of the total PCB mass budget analysis, including total PCB mass distributions in different phases and residence times in the system. The diagrams and table also give an indication of the importance for each environmental process conceptualized in the Lake Michigan system. The unit of the annual average mass fluxes (average of the two-year LMMBP period – 1994-1995) in the mass budget diagrams is in kg/year. The mass inventories in the diagrams for both water column and surficial sediment (0-4 cm) are the average mass at any time over the two-year LMMBP period and in units of kg. Due to seasonal variations in the concentration of both the water column and the surficial sediments in the Lake Michigan system, the numbers for inventories can be

different on any given day in the LMMBP period. The average mass of total PCBs in the water column of the Lake Michigan system during 1994-1995 was 1,216 kg. About 30% (370 kg) of the total PCB mass in the water column was in the particulate phase (particulate detrital carbon [PDC] bounded + biotic carbon [BIC] bounded). Dissolved phase (dissolved organic carbon [DOC] bounded + unbounded) accounted for approximately 70% (846 kg) of the average mass of total PCBs in the water column. The average mass of total PCBs in the surficial sediments (0-4 cm) during the LMMBP period was 13,085 kg, and virtually all of the mass in the surficial sediment was bound to PDC. Based on the volumes of the water column ($4.8148 \times 10^{12} \text{ m}^3$) and the surficial sediment layer ($1.0871 \times 10^9 \text{ m}^3$) of the Lake Michigan system, the average concentration of total PCBs in the water column was 0.253 ng/L, and the average concentration of total PCBs in the surficial sediment layer was 12,037 ng/L. These concentrations were consistent with the average concentrations (0.259 ng/L for the water column and 650-25,000 ng/L for the surficial sediment layer) derived from the LMMBP field data.

Compared with Lake Michigan, the total PCB mass distributions in dissolved and particulate phases were quite different in the Green Bay water column. The inventories of particulate and dissolved PCBs in Green Bay were almost equal. The higher PCB mass in the particulate phase in Green Bay was due to the dominant tributary load from the Fox River. In the river, the particulate PCB concentrations were much higher than the dissolved PCB concentrations. In Lake Michigan, the particulate PCBs were less than half of the dissolved PCBs in its water column.

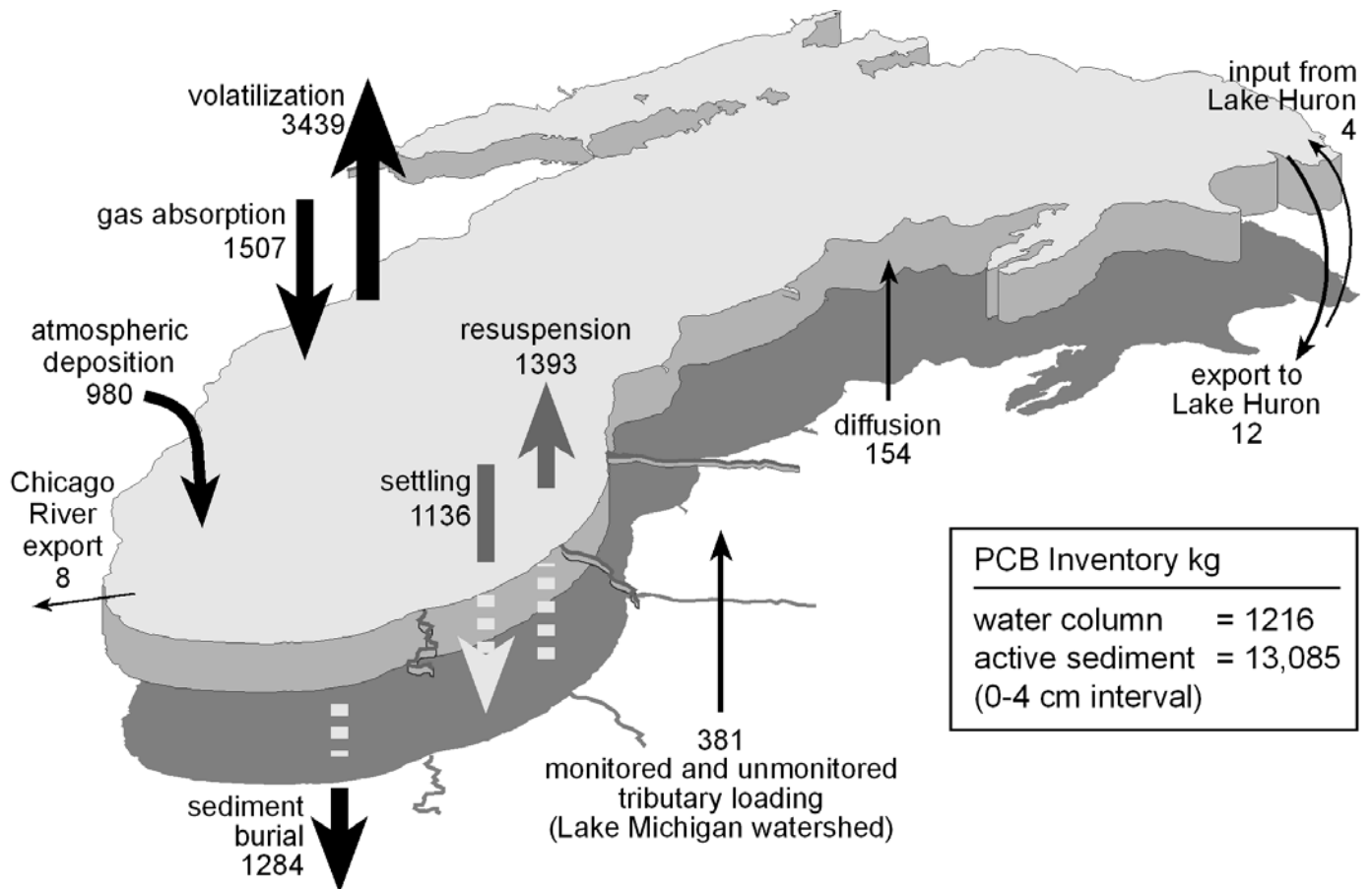

Figure 4.6.1. Mass budget average for 1994-1995 total PCBs in the Lake Michigan system (including Green Bay). Unit of the masses transported (arrows) is in kg/year.

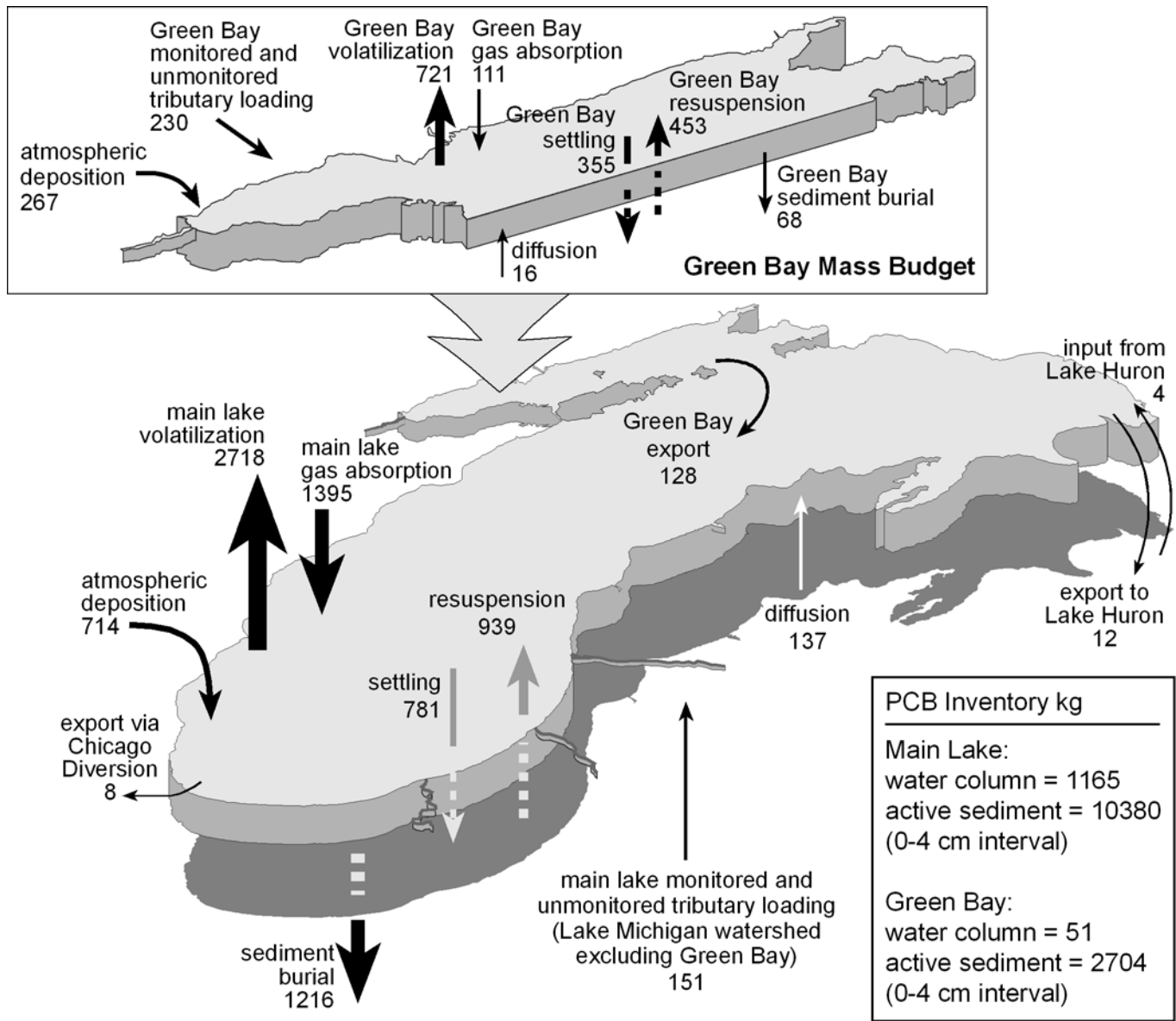

Figure 4.6.2. 1994-1995 total PCB Lake Michigan and Green Bay mass budget (averaged). Unit of the masses transported are in kg/year.

Table 4.6.2. Results of Total PCB Mass Budget Analysis for Lake Michigan and Green Bay (Fluxes are Annual Averages of the Two-Year LMMBP – 1994-1995; Inventories are the Average Inventories of the Two-Year LMMBP Period)

Mass Budget Component	Lake Michigan + Green Bay	Lake Michigan	Green Bay
Fluxes (kg/year)			
Total Loads	1362	865	496
(Monitored Tributary)	348	124	224
(Unmonitored Tributary)	33	26	7
(Atmospheric Dry)	767	514	253
(Atmospheric Wet)	214	200	13
Settling	1136	782	355
(PDC Bounded)	1076	764	311
(BIC Bounded)	61	17	44
Resuspension	1393	939	453
Burial (Sedimentation)	1284	1216	68
Diffusion	154	137	16
Absorption	1507	1395	111
Gross Volatilization	3439	2718	721
Net Volatilization	1932	1323	610
Input From Lake Huron	4	4	
Export to Lake Huron	12	12	
Net Output to Lake Huron	8	8	
Chicago Diversion	1	1	
Net Flux From Green Bay to Lake Michigan	128	128	128
Inventory (kg)			
Water Column	1216	1165	51
(PDC Bounded)	297	277	19
(BIC Bounded)	73	67	6
(DOC Bounded)	36	35	1
(Unbounded)	810	786	24
Surficial Sediment (0-4 cm)	13085	10380	2704
Residence Time in Water Column (Days)	97	121	17
Residence Time in Sediment (Days)	1688	1653	1837

Note: The fluxes represent the masses transported across the total area of an interface between adjacent compartments of the Lake Michigan system. Residence time for the water column was calculated by dividing the annual average inventory in the compartment by the annual total output (sum of gross volatilization, settling, export to Lake Huron, and Chicago diversion) from the water column. Residence time for the surficial sediment layer was derived by dividing the annual averaged sediment inventory by the sum of the losses (burial, resuspension, and diffusion).

The information on the individual fluxes of total PCBs in Figures 4.61 and 4.6.2 and Table 4.6.2 on an annual average basis for the LMMBP period provide further quantitative diagnosis on the importance of each source, sink, and the key environmental process in the Lake Michigan system. The single largest flux leaving the lake was gross volatilization (3,439 kg/year). This flux was countered by the flux from gas absorption (1,507 kg/year) as the largest source to the lake. The air-water exchange was the most important process for the Lake Michigan system. It accounted for the largest net loss (1,932 kg/year) from the Lake Michigan system of which 31.6% was from Green Bay (610 kg/year). Resuspension (1,393 kg/year) was a major flux into the water column of the Lake Michigan system. This was offset by the flux from settling (1,136 kg/year). The processes associated with the interaction between the water column and the surficial sediments (resuspension and settling) were very important processes in the Lake Michigan system. The results of these processes led to the second largest net source (257 kg/year) next to the total external load (1,362 kg/year) for the water column of the Lake Michigan system. About 40% of this net gain from the sediment-water interactions was contributed from Green Bay (98 kg/year). Green Bay received more than one-third (496 kg/year) of the total external load. The principal loss in the surficial sediment layer was burial (1,284 kg/year). The flux contributed by diffusion from the surficial sediment layer to the water column was 154 kg/year. The high value for the mass transported by the diffusion from the surficial sediment layer was not unexpected. The reason for the high value could lie in the selection of the diffusion coefficient used in the LM2-Toxic ($1.73 \times 10^{-4} \text{ m}^2/\text{day}$) (DePinto *et al.*, 1993) for sediment-water diffusion process. Compared with the coefficient used in the level 1 model ($1.8 \times 10^{-5} \text{ m}^2/\text{day}$, Table 3.3.2) and the coefficient defined under low-flow conditions for river sediment ($1.5 \times 10^{-4} \text{ m}^2/\text{day}$) (Ortiz *et al.*, 2004), the coefficient used in the LM2-Toxic was a bit higher. This could be another reason for the higher PCB concentrations for the bottom water segments output from the model during the LM2-Toxic PCB dynamics calibration (see Chapter 5 for details).

For the Lake Michigan system, the total external PCB load (monitored tributary, unmonitored tributary, atmospheric dry, and atmospheric wet loads) and

input from Lake Huron was 1366 kg/year. The total output or loss was equal to 3,229 kg/year due to net volatilization, sediment burial, export to Lake Huron, and Chicago diversion. Therefore, there was a net loss of 1,863 kg/year of total PCBs from the entire Lake Michigan system. This indicated that both the water column and the surficial sediment layer of the lake were not at steady-state during the LMMBP period. By examining the mass fluxes of total PCBs in the water column alone, the annual average total gain (1,777 kg/year) during the project period was the sum of total external load, net resuspension (resuspension flux – settling flux) from the surficial sediment layer, diffusion from the surficial sediment layer, and input from Lake Huron. The annual averaged total loss for the water column during the same period was 1,945 kg/year and was equal to the sum of net volatilization, export to Lake Huron and Chicago diversion. Thus the water column experienced a total net annual loss of 168 kg/year. The annual average net export of total PCBs from Green Bay to Lake Michigan was equal to 128 kg/year during 1994-1995. The number is very close to the value (122.3 kg/year) estimated from the 1989 Green Bay Mass Balance Project (GBMBP) (DePinto *et al.*, 1993). A net loss of 1,695 kg PCB per year from sediment was due to burial below the surficial sediment (1,284 kg/year); net resuspension to the water column (257 kg/year = resuspension flux 1,393 kg/year - settling flux 1,136 kg/year); and diffusion (154 kg/year) from the surficial sediment layer to the water column.

Residence time for the water column was calculated by dividing the annual average inventory in the compartment by the annual total output (sum of gross volatilization, settling, export to Lake Huron, and Chicago diversion) to the water column. Therefore, the water column total PCB residence times for Lake Michigan including Green Bay, Lake Michigan only, and Green Bay only were approximately 97, 121, and 17 days, respectively. Similarly, the residence time for the surficial sediment layer was derived by dividing the annual averaged sediment inventory by the sum of the losses (burial, resuspension, and diffusion). Thus the total PCB residence times in the surficial sediment layer for Lake Michigan including Green Bay, Lake Michigan only, and Green Bay only were about 1,688, 1,653, and 1,837 days, respectively. Thus, PCBs reside in

the surficial sediment layer much longer than in the water column of Lake Michigan.

4.6.3 LM2-Toxic Application for Long-Term Forecast and Sensitivity Scenarios

Predictions of long-term PCB dynamics under a variety of external forcing conditions were made using LM2-Toxic for seven PCB forecast and sensitivity scenarios. The model-predicted PCB concentrations were then used as the time-dependent exposure concentrations in the LM Food Chain to calculate PCB concentrations in lake trout. The simulation period for each scenario was 62 years, starting on January 1, 1994 and ending on December 31, 2055.

All scenarios used the same LMMBP-generated field data as input for the first two years (1994-1995) of the simulations. Then, each scenario began on January 1, 1996 and ran for a period of 60 years. The observed PCB total load for the LMMBP period (1994-1995) was adjusted upward by a factor of 1.98. The adjusted PCB load is consistent with the 1994 total load used in the PCB hindcast (see 1.7.3 of this report for details on the derivation of the PCB hindcast loading function) and is a reasonable estimate when considering the possibility of missing atmospheric loads during the LMMBP period (see 1.7.3 of this report for a detailed discussion).

The seven PCB forecast and sensitivity scenarios were:

- A) Constant Conditions – The measured PCB loads (tributary load plus atmospheric dry and wet deposition) for the LMMBP period (1994-1995), but adjusted upward by a factor of 1.98. The adjusted loads followed the same spatial distribution and monthly variation patterns established by the LMMBP measured PCB loads. The adjusted loadings, the 1994-1995 vapor-phase concentration, Lake Huron boundary conditions, and all other forcing functions as observed in 1994 and 1995 were repeated throughout the simulation period. Sediment burial was active as well as all other model processes.
- B) Continued Recovery (Fast) – This was the same as Scenario “A”, but atmospheric components (vapor phase concentration, wet and dry deposition) declined with a six-year half-life (Hillery *et al.*, 1997; Schneider *et al.*, 2001), and tributary loads declined with a 13-year half-life (Endicott, 2005; Marti and Armstrong, 1990). The boundary conditions at the Straits of Mackinac declined at a rate of 0.17/year (a four-year half-life) (Schneider *et al.*, 2001). These rates were applied starting on January 1, 1996.
- C) Continued Recovery (Slow) – This was the same as Scenario “A”, but atmospheric components (vapor phase concentration, wet and dry deposition) declined with a 20-year half-life (Buehler *et al.*, 2002) and tributary loads declined with a 13-year half-life. The boundary conditions at the Straits of Mackinac declined with a four-year half-life. These rates were applied starting on January 1, 1996.
- D) No Atmospheric Deposition – This was the same as Scenario “A”, but starting on January 1, 1996, the atmospheric loads (dry and wet deposition) were set to zero. All other forcing functions as observed in the LMMBP period were repeated throughout the simulation period.
- E) No Tributary Loadings – This was the same as Scenario “A”, but starting on January 1, 1996, all tributary loads were set to zero. All other forcing functions as observed in the LMMBP period were repeated throughout the simulation period.
- F) Lakewide Sediment Cleanup – This was the same as Scenario “A”, but starting on January 1, 1996, the lake-wide sediment PCB concentration was instantaneously set to zero. All other sediment properties remained as existed prior to sediment clean-up. All other forcing functions as observed in the LMMBP period and processes were repeated throughout the simulation period.
- G) No Atmospheric Deposition and No Tributary Loadings – The loading cuts of Scenarios “D” and “E” were combined. All other forcing functions as observed in the LMMBP period were repeated throughout the simulation period.

The results of the above seven scenarios will be presented in two separate groups. These are forecast scenarios (Scenarios A, B, and C) and sensitivity or engineering scenarios (Scenarios D, E, F, and G).

4.6.4 Results of the Forecast and Sensitivity Scenarios and Discussion

Figures 4.6.3 and 4.6.4 show the annual and monthly average long-term responses of total PCBs in the water column of the Lake Michigan system for the seven forecast and sensitivity scenarios. Compared to the annual lake-wide total PCB concentrations (Figures 4.6.3a and 4.6.3b), the monthly lake-wide total PCB concentrations show a much wider variation with high concentrations in the summer months and low concentrations in the winter months (Figures 4.6.4a and 4.6.4b).

The model results were compared to measured data and water quality criteria. The lake-wide average total PCB concentration (0.259 ± 0.172 ng/L) for the LMMBP period (1994-1995) was based on 298 field measurements from various water depths at 41 water column sampling stations. The total PCB concentration (0.165 ± 0.029 ng/L) from the Episodic Events-Great Lakes Experiment (EEGLE) project represents the average PCB concentration for southern Lake Michigan in 2000 (Miller, 2003). The focus of EEGLE was to investigate the potential impact of major sediment resuspension events on persistent organic pollutants (POPs) in southern Lake Michigan. Field sampling for EEGLE was conducted in 1998, 1999, and 2000. The average PCB concentration for 2000 from the EEGLE project was a better representation than the earlier years for the open-water concentration of PCBs in the lake and was used for post-audit comparisons to the results of the LM2-Toxic PCB long-term forecast and sensitivity scenarios. USEPA water quality criteria for the protection of wildlife is 0.12 ng/L and for human health is 0.026 ng/L; which is a human cancer value (HCV) that is still under review and development (U.S. Environmental Protection Agency, 2005; U.S. Environmental Protection Agency, 1997).

Scenario A – Constant Conditions serves as the upper bound of the range of possibilities resulting from the specified PCB forecast and sensitivity scenarios. The long-term response to the Constant

Conditions Scenario clearly demonstrated that, during the LMMBP period (1994-1995), the Lake Michigan system was not at steady-state with respect to the 1994-1995 loads, vapor phase concentrations, and the level of sediment total PCB inventory. As the mass budget analysis indicated in the previous section and in Table 4.6.2, the mass losses from net volatilization and sediment burial were the major contributors to the decline of total PCB concentrations in both the water column and the surficial sediment layer. The spatially averaged steady-state value for the water column under this scenario was about 0.145 ng/L and was reached around 2024. This value represents a 44% reduction in the annual average concentration (0.259 ng/L) in the water column for the LMMBP period. The steady-state concentration of the Constant Condition Scenario will still be approximately 20% higher than the most recent (U.S. Environmental Protection Agency, 2005) USEPA water quality criteria for the protection and wildlife and five to six times higher than the USEPA water quality criteria for the protection of human health in the Great Lakes system (U.S. Environmental Protection Agency, 1997).

Among the forecast scenarios, the outcome from Scenario A (Constant Conditions) may not be a realistic prediction of long-term PCB concentrations in the lake. Because PCB production was phased out in the 1970s, PCB inputs into the Lake Michigan system through the atmosphere (*via* dry and wet deposition, and absorption of vapor phase) and tributaries have been decreasing significantly due to regulatory policies and remediation efforts made by federal and state agencies. Therefore, it is reasonable to assume that PCB inputs into the lake should continue decreasing under current regulatory policies and clean-up efforts. The decline rates used in Scenarios B and C for PCB inputs from the atmosphere and tributaries were the result of analyzing observed data collected for the past 25 years. These rates were subject to a certain degree of uncertainty (see Section 1.7.2). The variation of the estimated decline rates for atmospheric components (dry and wet deposition and vapor phase concentration) was quite large with half-lives ranging from 6 to 20 years. It appears that the rate of decline decreased with the addition of more recent data (Hillery *et al.*, 1997; Simcik *et al.*, 1999; Schneider *et al.*, 2001; Buehler *et al.*, 2002, 2004).

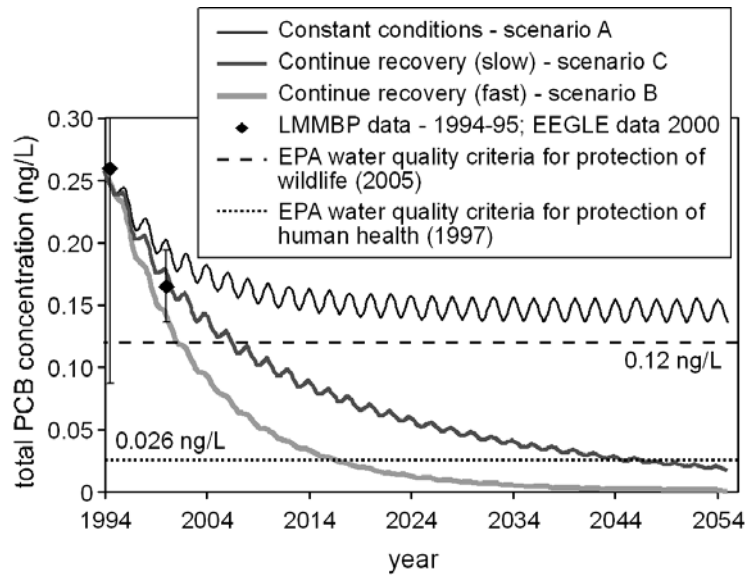

Figure 4.6.3a. Annual long-term responses to total PCB concentrations in the water column of Lake Michigan for the forecast scenarios and USEPA water quality criteria for the protection of wildlife (U.S. Environmental Protection Agency, 2005) and human health (U.S. Environmental Protection Agency, 2005) in the Great Lakes system.

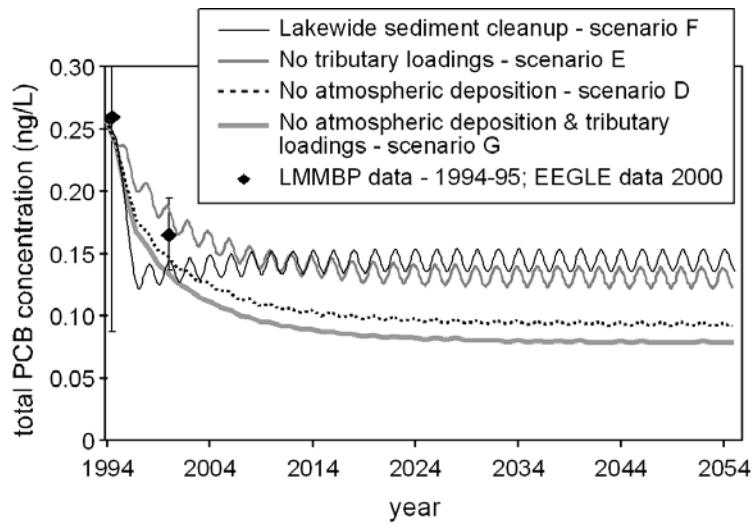

Figure 4.6.3b. Annual long-term responses to total PCB concentrations in the water column of Lake Michigan for the sensitivity scenarios.

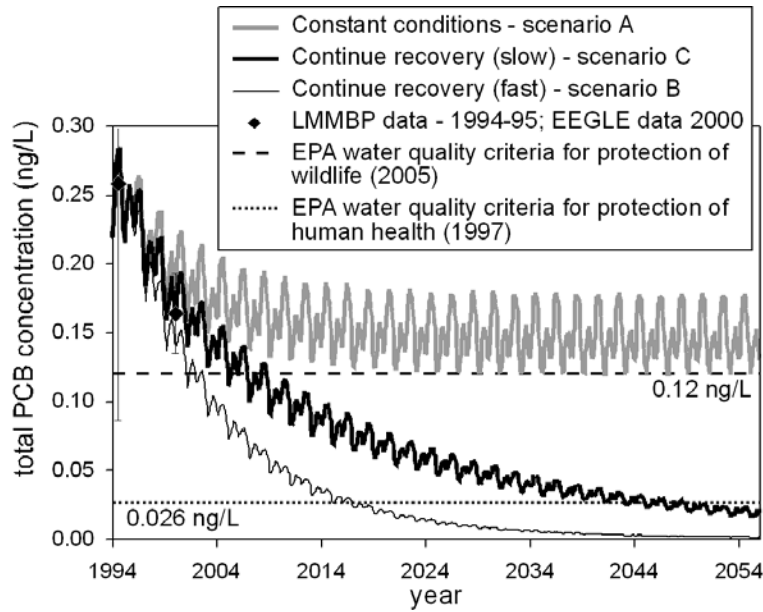

Figure 4.6.4a. Monthly long-term responses to total PCB concentrations in the water column of Lake Michigan for the forecast scenarios and USEPA water quality criteria for the protection of wildlife (U.S. Environmental Protection Agency, 2005) and human health (U.S. Environmental Protection Agency, 1997) in the Great Lakes system.

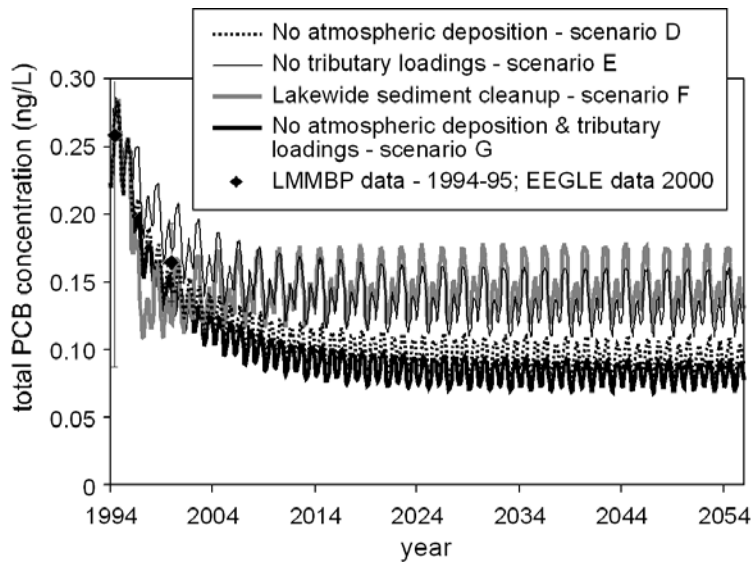

Figure 4.6.4b. Monthly long-term responses to total PCB concentrations in the water column of Lake Michigan for the sensitivity scenarios

The purpose of forecast Scenarios B and C was to provide bounds for predicted long-term PCB water column concentrations by assuming six-year half-life and 20-year half-life decline rates in PCB atmospheric components, respectively.

For Scenario B (Fast Continued Recovery Scenario), it takes about five years (starting January 1, 1996) for PCB concentrations in the water column to meet the USEPA water quality criteria for the protection of wildlife (U.S. Environmental Protection Agency, 2005) and more than two decades to reach the USEPA water quality criteria for the protection of human health (U.S. Environmental Protection Agency, 1997) in the Lake Michigan system. The water column PCB concentrations predicted in Scenario C (Slow Continued Recovery Scenario) declined at a much slower speed. The model results indicated that it would take about 12 years for the water column PCB concentrations in the lake to reach the USEPA water quality criteria for the protection of wildlife in the Great Lakes (U.S. Environmental Protection Agency, 2005). Figure 4.6.3a also shows that the PCB concentrations in the water column reached the USEPA water quality criteria for the protection of human health (U.S. Environmental Protection Agency, 1997) around 2046 (five decades after 1996). In both forecast Scenarios B and C, the PCB inventory in the surficial active sediment layer plays an important role in sustaining the water column PCB concentrations.

It is important to point out that the decline rate used in Scenarios B and C may not necessarily be realistic rates for the Great Lakes in the future. There is a chance that the actual rate could be slower, especially if there is no further regulatory and remediation actions taken to reduce the PCB sources from the atmosphere of the entire Lake Michigan watershed.

The sensitivity Scenarios D, E, F, and G were designed for the purpose of demonstrating how sensitive the long-term responses of the Lake Michigan system could be by hypothetically eliminating atmospheric deposition (dry and wet), tributary loads, total sediment inventory, and total external loads (dry and wet atmospheric deposition, and tributary loads altogether), respectively, starting on January 1, 1996. It is very important to mention that for these sensitivity scenarios, the PCB vapor

phase concentrations were kept the same as the LMMP (1994-1995) measured concentrations.

Long-term PCB concentrations in the water column were more sensitive to the atmospheric deposition (dry and wet) than the load from tributaries (Figure 4.6.3b). The steady-state concentration predicted from Scenario E (No Tributary Loadings) was 0.131 ng/L which was equivalent to less than a 10% decrease in the steady-state concentration (0.145 ng/L) from Scenario A (Constant Conditions). The steady-state concentration predicted from Scenario D (No Atmospheric Deposition) experienced a much larger drop to 0.094 ng/L, with a 35% reduction compared to the steady-state concentration of Scenario A. When eliminating both atmospheric deposition (wet and dry) and tributary load (Scenario G), the steady-state concentration decreased to 0.080 ng/L. By eliminating PCB total inventory in the lake sediments, starting on January 1, 1996, the PCB concentration in the water column experienced a steep drop initially and then gradually increased and reached a steady-state concentration of 0.145 ng/L. Notice that this value was the same as the one predicted from Scenario A (Constant Condition).

It should be emphasized that Scenarios D, E, F, and G are hypothetical and not realistic. Because LM2-Toxic was not coupled with an air quality model to dynamically compute PCB vapor phase concentration, the atmospheric concentrations in the sensitivity scenarios were kept constant as measured during the 1994-1995 LMMP period. In reality, the PCB water column concentrations should be significantly lower than the steady-state concentrations resulting from these four sensitivity scenarios. As demonstrated in Figure 4.6.1, the gross volatilization flux is the largest flux moving PCB mass out of the lake. The decrease in the water column PCB concentrations after the actions taken for these four sensitivity scenarios would reduce the gross volatilization fluxes. As a result, the PCB vapor phase concentration over the watershed should decrease accordingly. This could lead to the reduction of PCB absorption flux to the lake and further reduce the PCB water column concentrations.

Figure 4.6.5 shows the long-term responses of PCB concentrations in the lake sediments to the seven forecast and sensitivity scenarios. In general, the PCB concentrations in the sediments followed

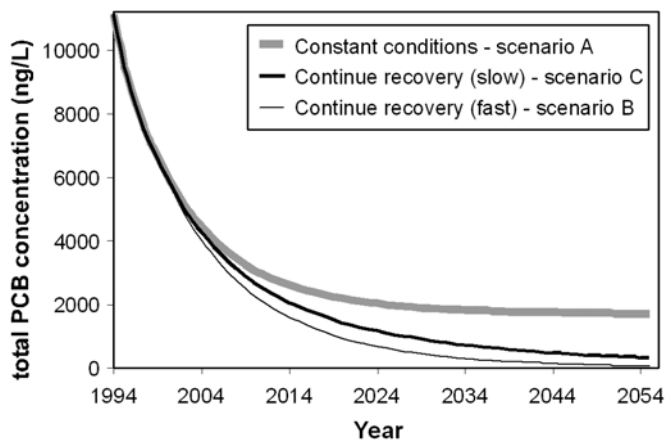

Figure 4.6.5a. Annual long-term responses to total PCB concentrations in the surficial sediment of Lake Michigan for the forecast scenarios.

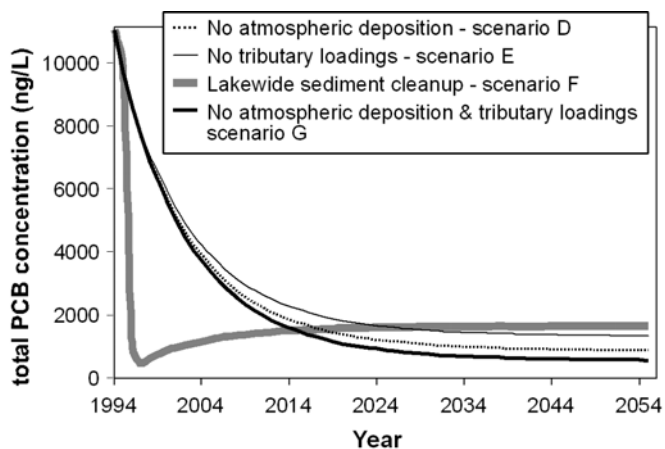

Figure 4.6.5b. Annual long-term responses to total PCB concentrations in the surficial sediment of Lake Michigan for the sensitivity scenarios.

similar long-term trends predicted for the water column. The steady-state PCB sediment concentration predicted from Scenario E (No Tributary Loads) was 1,347 ng/L which was 18% less than the steady-state PCB sediment concentration (1,665 ng/L) from Scenario A (Constant Conditions). The steady-state concentration predicted from Scenario D (No Atmospheric Deposition - Wet and Dry) was 909 ng/L which was 45% less than the concentration from Scenario A.

A few differences were noted when comparing responses of PCBs in sediment with the long-term responses of PCBs in the water column. First, there was no apparent seasonal variation in the long-term temporal profiles of the sediment PCB concentrations. The large PCB inventory and the mixing processes within the surficial sediment layer may have been factors smoothing out any seasonal variations caused by atmospheric components and tributary loads. Secondly, the long-term responses of PCB concentrations in sediment were more sensitive than those in the water column for the sensitivity Scenarios D (No Tributary Loads), E (No Atmospheric Depositions), and G (No Tributary and Atmospheric Loads). LM2-Toxic was developed for simulating 54 PCB congeners. Based on the data analysis results for PCBs in different media (see Part 1.6 for details), the heavier PCB congeners (higher molecular weight) were more abundant in tributary loads and atmospheric deposition (dry and wet) than in the vapor phase. In the water column, more than two-thirds of PCB mass was in the dissolved phase, and PCB concentrations were significantly influenced by PCB vapor phase concentration. Unlike in the water column, particulate PCBs in the lake sediments were the dominant phase, while PCBs in the dissolved phase were negligible. In addition, the heavier PCB congeners were more abundant in the sediments due to their higher partitioning coefficients. The larger percentage of heavy congeners in tributary loads and atmospheric deposition and the strong influence of vapor PCB concentrations on the water column PCB concentrations might be the factors making the PCB concentrations in sediment more sensitive to the tributary loads and atmospheric deposition than in the water column.

Reducing the PCB vapor phase concentration was critical to the level of long-term PCB concentration in the Lake Michigan system. Both Figures 4.6.3 and 4.6.5 (Scenarios B and C compared to Scenario A) demonstrate that the long-term response of PCBs in the lake system is very sensitive to PCB vapor concentrations. Figure 4.6.1 also shows that the volatilization flux and absorption flux are the number one and the number two fluxes for Lake Michigan. Again, the future declining rates for PCB atmospheric components (including vapor concentration, wet and dry deposition) may be slower than the rate used in Scenario C if there is no action taken in the future to continue reducing PCB vapor concentrations and

particulate deposition from the atmosphere of the Lake Michigan watershed.

4.6.5 Results Provided for the LM Food Chain Model

The exposure concentrations generated from LM2-Toxic for the seven scenarios were provided as forcing functions to the LM Food Chain model to predict the long-term concentration changes for PCB congeners in lake trout tissue. Sets of exposure concentrations were generated for the Saugatuck biota box, segment 2, the Sturgeon Bay biota box, and segment 3 (see Figure 5.4.1 in Part 5 LM Food Chain for the locations of the biota zones). Each data set contained water column dissolved PCB concentrations (ng/L), water column particulate PCB concentrations (ng/g organic carbon), sediment dissolved PCB concentrations (ng/L), and sediment particulate PCB concentrations (ng/g organic carbon). Because there were multiple LM2-Toxic sediment segments under each biota box and water column segment, the sediment PCB concentrations provided to the LM Food Chain were computed using area-weighted averaging based on the segment-specific concentrations generated by the LM2-Toxic.

Field data for water column hypolimnetic total particulate PCB concentrations for the Saugatuck biota box was higher than for the much larger hypolimnetic level 2 segments (Segments 21, 30, 37) within which the Saugatuck biota box resided. Therefore, a factor of 1.5 was used to scale

hypolimnetic water column total particulate PCB concentrations from the larger level 2 segments (Segments 21, 30, 37) to the hypolimnetic Saugatuck biota box. This factor was calculated based upon the LMMBP data collected from hypolimnetic sampling locations near the biota box and sampling locations within hypolimnetic segments 21, 30, and 37 as a whole (Table 4.6.3).

References

Buehler, S.S., I. Basu, and R.A. Hites. 2002. Gas-Phase Polychlorinated Biphenyl and Hexachlorocyclohexane Concentrations Near the Great Lakes: A Historical Perspective. *Environ. Sci. Technol.*, 36(23):5051-5056.

Buehler, S.S., I. Basu, and R.A. Hites. 2004. Causes of Variability in Pesticide and PCB Concentrations in Air Near the Great Lakes. *Environ. Sci. Technol.*, 38(2):414-422.

DePinto, J.V., R. Raghunathan, P. Sierzenga, X. Zhang, V.J. Bierman, Jr., P.W. Rodgers, and T.C. Young. 1993. Recalibration of GBTOX: An Integrated Exposure Model for Toxic Chemicals in Green Bay, Lake Michigan. Final Report. U.S. Environmental Protection Agency, Office of Research and Development, ERL-Duluth, Large Lakes Research Station, Grosse Ile, Michigan. 132 pp.

Table 4.6.3. Mean and Median Particulate PCBs/Organic Carbon and Field Data and Scaling Factor for Hypolimnetic Level 2, Segments 21, 30, and 37, and for Saugatuck Biota Box Hypolimnion

Field Data	Segments 20, 29, 36 (Hypolimnion)	Saugatuck Biota Box, Hypolimnion	Factor
Mean Particulate PCBs/Organic Carbon (ngPCB/mgC)	0.560	0.817	1.5
Median Particulate PCBs/Organic Carbon (ngPCB/mgC)	0.509	0.747	1.5

-
- Endicott, D.D. 2005. 2002 Lake Michigan Mass Balance Project: Modeling Total PCBs Using the MICHTOX Model. In: R. Rossmann (Ed.), MICHTOX: A Mass Balance and Bioaccumulation Model for Toxic Chemicals in Lake Michigan, Part 2. U.S. Environmental Protection Agency, Office of Research and Development, National Health and Environmental Effects Research Laboratory, MED-Duluth, Large Lakes Research Station, Grosse Ile, Michigan. EPA/600/R-05/158, 140 pp.
- Hillery, B.L., I. Basu, C.W. Sweet, and R.A. Hites. 1997. Temporal and Spatial Trends in a Long-Term Study of Gas-Phase PCB Concentrations Near the Great Lakes. *Environ. Sci. Technol.*, 31(6):1811-1816.
- Marti, E.A. and D.E. Armstrong. 1990. Polychlorinated Biphenyls in Lake Michigan Tributaries. *J. Great Lakes Res.*, 16(3):396-405.
- Miller, S.M. 2003. The Effects of Large-Scale Episodic Sediment Resuspension on Persistent Organic Pollutants in Southern Lake Michigan. Ph.D. Thesis, The University of Iowa, Iowa City, Iowa. 194 pp.
- Ortiz, E., R.G. Luthy, D.A. Dzombak, and J.R. Smith. 2004. Release of Polychlorinated Biphenyls From River Sediment to Water Under Low-Flow Conditions: Laboratory Assessment. *J. Environ. Engin.*, 130(2):126-135.
- Schneider, A.R., H.M. Stapleton, J. Cornwell, and J.E. Baker. 2001. Recent Declines in PAH, PCB, and Toxaphene Levels in the Northern Great Lakes as Determined From High Resolution Sediment Cores. *Environ. Sci. Technol.*, 35(19):3809-3815.
- Simcik, M.F., I. Basu, C.W. Sweet, and R.A. Hites. 1999. Temperature Dependence and Temporal Trends of Polychlorinated Biphenyl Congeners in the Great Lakes Atmosphere. *Environ. Sci. Technol.*, 33(12):1991-1995.
- U.S. Environmental Protection Agency. 1997. Revocation of the Polychlorinated Biphenyl Human Health Criteria in the Water Quality Guidance for the Great Lakes System. *Federal Register*, October 9, 1997, Volume 62, Number 196. [DOCID:fr09oc97-9]. From the *Federal Register Online* via GPO Access [wais.access.gpo.gov].
- U.S. Environmental Protection Agency. 2005. Water Quality Guidance for the Great Lakes System. Code of Federal Regulations, Title 40, Volume 21, Chapter 1, Part 132. [Http://www.access.gpo.gov/nara/](http://www.access.gpo.gov/nara/).

PART 4

LM2-TOXIC

Chapter 7. LM2-Toxic Sensitivity Analysis

Sensitivity analysis is a very efficient tool that can semi-quantitatively demonstrate the uncertainties in the outputs from a water quality model. These uncertainties in the model outputs could result from the uncertainties associated with the forcing time functions; the water and sediment transport; the numerical algorithms used in the model; or the parameters for the chemical and biochemical processes defined in the model. This chapter summarizes the results of a series of sensitivity analyses completed only for the forcing time functions such as primary production and polychlorinated biphenyl (PCB) loads. The PCB atmospheric components (PCB vapor concentration, dry and wet deposition) and tributary PCB load half-lives are discussed in Part 4, Chapters 3 and 6. Model sensitivity analyses were performed over both a short-term (two years, 1994-1995) and long-term (62 years - 1994 to 2055) periods.

4.7.1 Primary Production Sensitivity

Due to the affinity of PCBs for organic carbon, the internal organic carbon load (primary production) is very important in understanding the transport and fate of PCBs in the Lake Michigan system. The internal organic carbon load used in the LM2-Toxic was generated by the eutrophication model, LM3-Eutro (See Part 2 for details). Because there are uncertainties associated with the LM3-Eutro generated internal organic carbon load, the variations in the load on the LM2-Toxic PCB model output concentrations (including solids - dissolved organic carbon (DOC), biotic carbon (BIC), particulate

detrital carbon (PDC), and PCBs) were explored. The results of the sensitivity analysis for PCBs are illustrated with the PCB₂₈₊₃₁ congener pair because it is the most abundant PCB congener pair in Lake Michigan. In LM2-Toxic, this congener pair is modeled as a single state variable. The internal organic carbon load generated from the LM3-Eutro for the LMMBP period (1994-1995) was increased 50% for one analysis and decreased 50% for a second analysis. The model simulations for the analyses were conducted for both a short-term (two-year period: 1994 and 1995) period and a long-term (62-year period: 1994-2055) periods. The results from the sensitivity analysis were compared to the results from the LM2-Toxic model base runs (i.e., calibration run for the 1994-1995 period and long-term Constant Condition Scenario, see Part 4, Chapters 4 and 6 for detailed descriptions of both of these base runs).

Below is a summary of the results from the sensitivity analysis:

1. As shown in Figures 4.7.1 and 4.7.2, a 50% increase or decrease in the primary production has a noticeable effect on the solid concentrations (DOC, BIC, PDC) in the water column compared to the base run concentrations for both short-term and long-term simulations. Table 4.7.1 lists annual average concentrations for the water column carbon solids and the percentage change of the water column carbon solids concentrations due to the increase and decrease in the primary production for both short-term and long-term simulations. Primary production has significant and almost instant

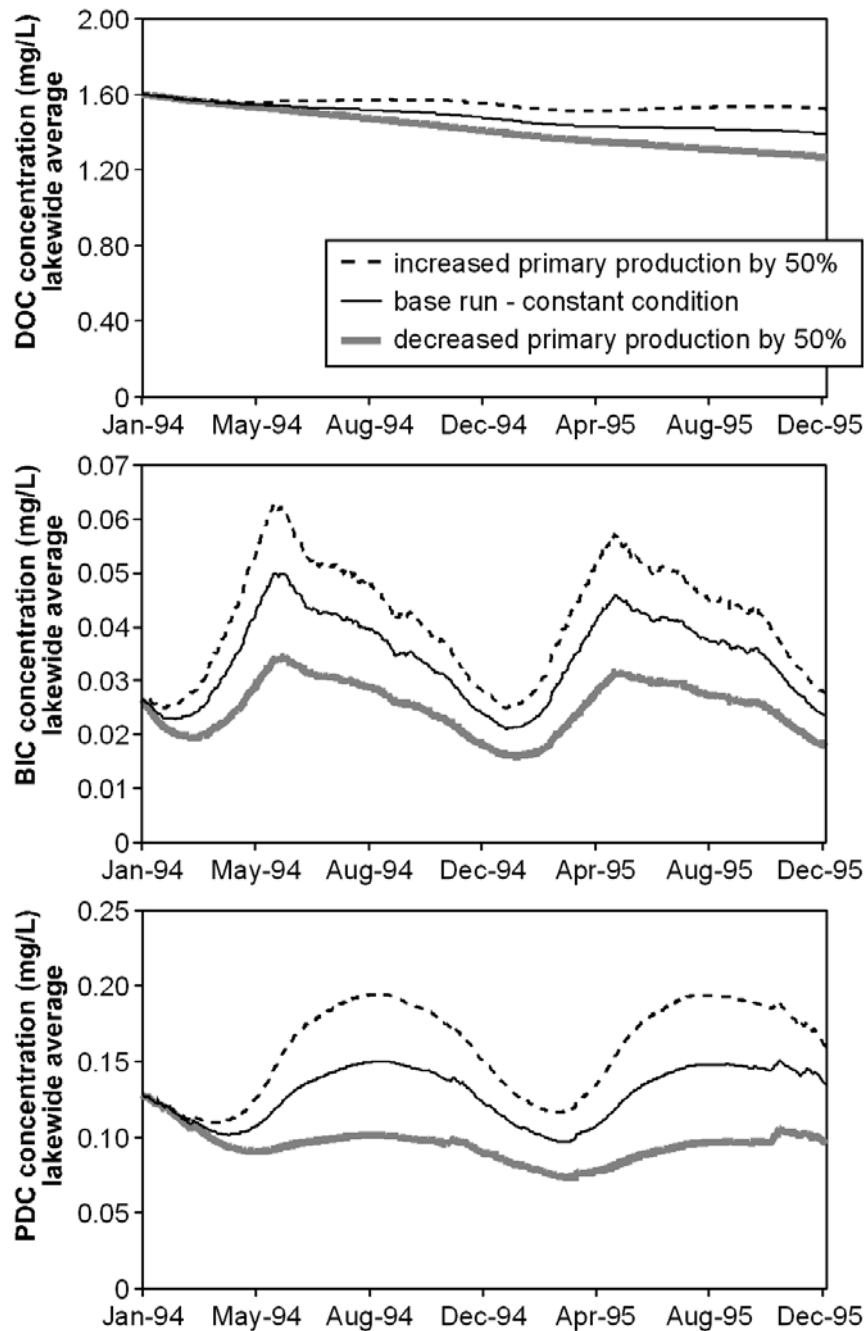

Figure 4.7.1. Short-term (1994-1995) variations of lake-wide (Green Bay included) organic carbon concentrations for \pm 50% primary production changes without adjusting settling and resuspension rates.

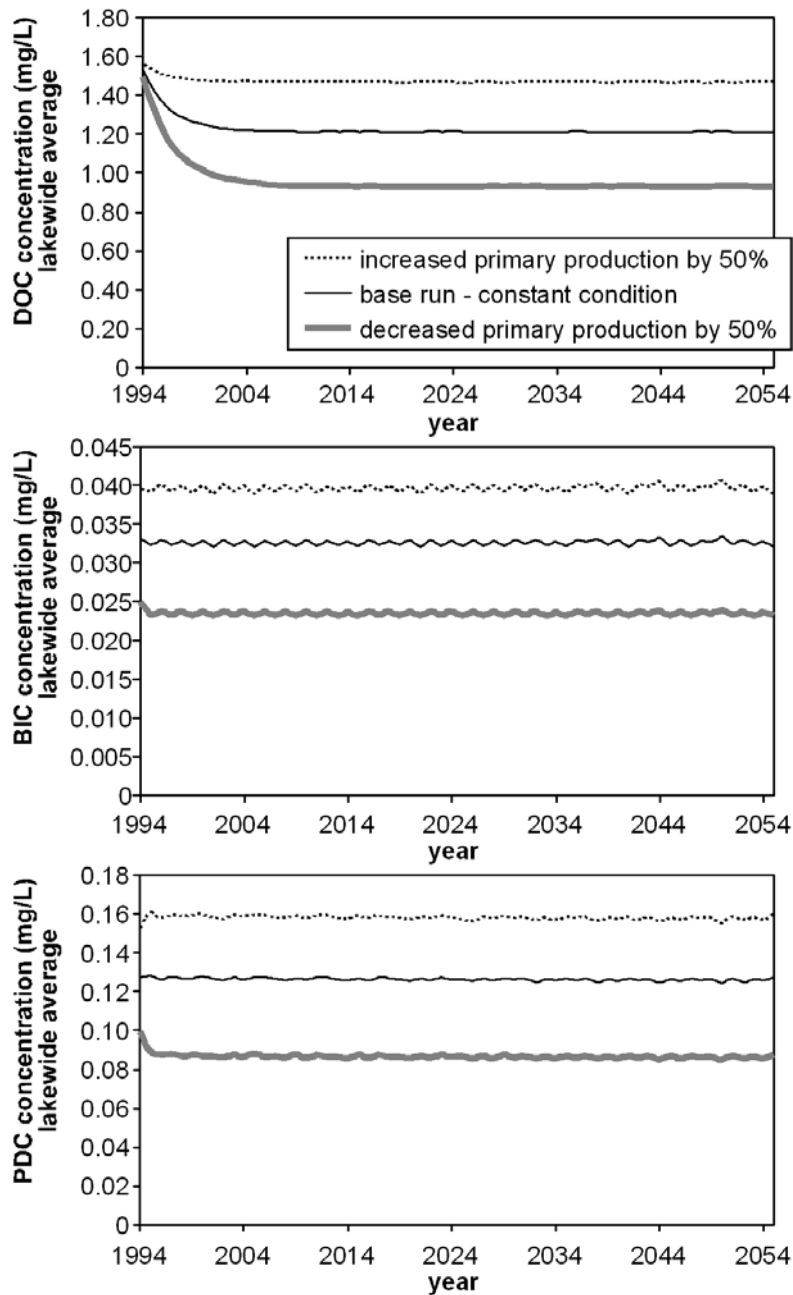

Figure 4.7.2. Long-term (1994-2055) variations of lake-wide (Green Bay included) organic carbon concentrations for \pm 50% primary production changes without adjusting settling and resuspension rates.

Table 4.7.1. Annual Average Concentrations of Water Column Carbon Solids and Annual Average Change in Percentage for Water Column Carbon Solids Concentrations Resulting From the LM2-Toxic Model Runs for Both the Short-Term (1994-1995) and the Long-Term (1994-2055) Simulations With 50% Increase and 50% Decrease of the LM3-Eutro Produced Primary Production

Carbon Solids (Short-Term Simulations)	Concentration (mg/L) From Original Base	Concentration (mg/L) From the Run With 50% Reduction	Annual Average Percentage (%) Change	Concentration (mg/L) From the Run With 50% Increase	Annual Average Percentage (%) Change
DOC	1.48	1.42	-4	1.55	5
BIC	0.034	0.025	-27	0.042	23
PDC	0.129	0.095	-26	0.159	23
Carbon Solids (Long-Term Simulations)					
DOC	1.23	0.96	-22	1.47	20
BIC	0.034	0.025	-27	0.042	23
PDC	0.129	0.088	-32	0.162	26

impact on the level of BIC and PDC concentration in the water column. Because of much larger initial DOC inventory in the lake and slower degradation process from PDC to DOC, the impact on DOC concentration in the lake due to the changes of primary production was not as evident as on BIC and PDC in the early portion of the long-term simulation period.

2. Figure 4.7.3 shows that, compared with the base run, there is very little difference in the PCB water column concentrations generated from the runs with 50% decrease and a 50% increase in primary production for the short-term simulation. Table 4.7.2 provides detailed information on individual mass fluxes in Lake Michigan and PCB inventories of both water column and surficial sediment for the two-year (1994-1995) sensitivity analyses. The decrease and increase in the settling PCB mass flux due to the 50% decrease and the 50% increase in primary production were compensated by the increase and decrease in the gross volatilization mass flux, respectively. This keeps the PCB water column inventories predicted from these two runs very close to the inventory generated from the short-term base runs.

3. The long-term, steady-state PCB concentrations in the water column was not significantly different from the base run concentrations (Figure 4.7.4). Interestingly, PCB concentrations from the long-term sensitivity runs started out almost identical and deviated with each other toward the end of the simulation. Table 4.7.3 provides detailed information on individual PCB mass fluxes in Lake Michigan and inventories of both the water column and the surficial sediment for the last two years of the long-term (62-years) model simulation. Similar to the short-term simulation, PCB settling and net volatilization fluxes were affected the most by the increase and the decrease of the primary production. The increase or decrease of the settling fluxes due to the increase or decrease in primary production was countered by the decrease or increase of the net volatilization fluxes.

In conclusion, the sensitivity analyses illustrate that, under the 1994-1995 PCB loading/boundary conditions/other forcing functions, a 50% increase or decrease in primary production generated from the LM3-Eutro does not have a significant influence on PCB concentrations in Lake Michigan for both short-

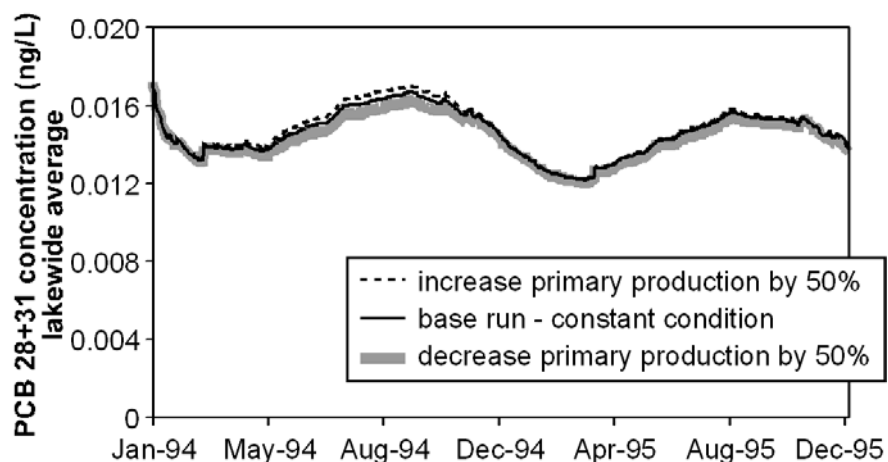

Figure 4.7.3. Short-term (1994-1995) variations of lake-wide (Green Bay included) PCB₂₈₊₃₁ (dissolved + particulate) concentrations for ± 50% primary production changes without adjusting settling and resuspension rates.

Table 4.7.2. PCB₂₈₊₃₁ Mass Fluxes and Inventories for Lake Michigan System Results From the LM2-Toxic Sensitivity Analysis on Primary Production for the Short-Term (Two-Year Period: 1994-1995) Simulations

PCB Mass Fluxes, kg/(Two Years) and Inventories, kg	Original Base Run	50% Reduction	50% Increase
Loads	113.97	113.97	113.97
Settling	104.62	89.58	116.06
Resuspension	175.59	176.77	170.48
Burial	135.99	134.12	137.80
Water Column Inventory	70.79	69.67	71.41
Sediment Inventory	808.76	797.63	819.53
Diffusion	33.37	34.20	32.73
Absorption	265.30	265.30	265.30
Gross Volatilization	558.01	577.43	540.79
Net Volatilization	292.71	312.13	275.49
Export to Lake Huron	0.88	0.78	0.97
Chicago Diversion	0.09	0.08	0.09
Mass Gain/Loss in Water Column	-75.38	-77.64	-75.43

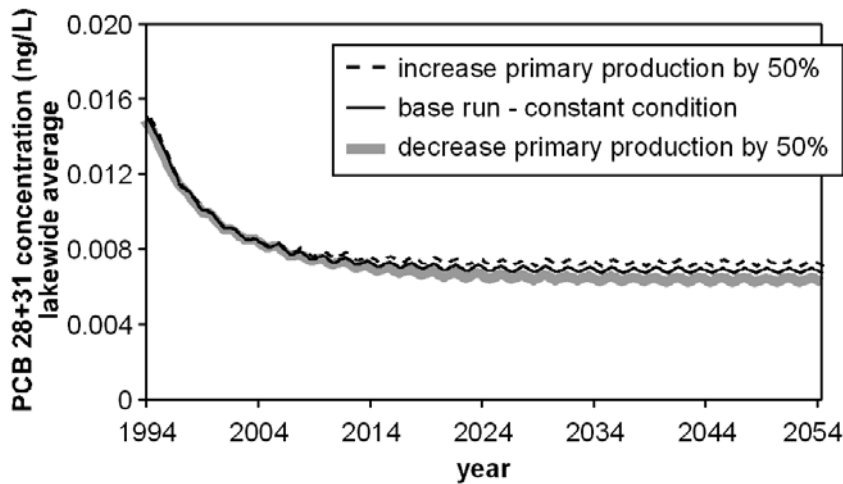

Figure 4.7.4. Long-term (1994-2055) variations of lake-wide (Green Bay included) PCB₂₈₊₃₁ (dissolved + particulate) concentrations for ± 50% primary production changes without adjusting settling and resuspension rates.

Table 4.7.3. PCB₂₈₊₃₁ Mass Fluxes and Inventories for Lake Michigan System Results From the LM2-Toxic Sensitivity Analysis on Primary Production For the Last Two Years of the Long-Term (62-Year Period: 1994-2055) Simulations

PCB Mass Fluxes, kg/(Two Years) and Inventories, kg	Original Base Run	50% Reduction	50% Increase
Loads	113.97	113.97	113.97
Settling	43.80	32.47	51.94
Resuspension	25.17	23.42	24.68
Burial	21.98	22.39	21.81
Water Column Inventory	33.78	31.21	35.71
Sediment Inventory	130.74	133.13	129.71
Diffusion	0.52	0.70	0.46
Absorption	263.07	263.07	263.07
Gross Volatilization	355.33	365.30	346.47
Net Volatilization	92.26	102.23	83.40
Export to Lake Huron	0.69	0.58	0.77
Chicago Diversion	0.07	0.06	0.07
Mass Gain/Loss in Water Column	2.84	2.73	2.93

term and long-term forecast scenarios. Table 4.7.4 lists the model-generated average PCB inventories resulting from the sensitivity runs for both the water column and the surficial sediment layer and the percentage change of the average PCB inventories in both compartments due to the increase and decrease in primary production. The inventories are the average PCB inventories for the two-year period of the short-term (1994-1995) simulation and the last two-year period of the long-term simulation. The largest percentage change of PCB inventories due to the 50% increase or decrease in primary production goes to the PCB inventory in the water column at the end of the long-term simulation period and is in the range of 5-8%. The impact on PCB inventory of the surficial sediment layer due to the changes of primary production is very small for both the short-term and the long-term periods.

4.7.2 PCB Loads Sensitivity

The variation in the outcomes of PCB concentrations in both the water column and sediment from the LM2-Toxic model can be very significant due to the uncertainty of PCB loads used as input. The uncertainty of the LMMBP-generated PCB loads could be due to sampling approach, analytical method, interpolation algorithm used for estimating the loads, and loads that were missed or not considered.

There is evidence (Wethington and Hornbuckle, 2005) that an additional input of PCBs was contributed from the local Milwaukee atmosphere through vapor-water exchange and wet and dry deposition to Lake Michigan that were not accounted for in the LM2-Toxic model. The combined additional PCB source from the Milwaukee regional atmosphere was estimated to be at least 120 kg per year (Wethington and Hornbuckle, 2005). It is possible that loads in other areas of the basin could have been missed, such as Green Bay.

Another potential unaccounted PCB source to the lake is the load associated with very large atmospheric particles. These are particles with a diameter greater than 10 μm and settling velocities greater than 7.4 cm s^{-1} . Although there is some disagreement among experts in the field regarding

the magnitude of PCB loads to the lake via the large particles, studies indicate that PCB dry deposition associated with large particles could be a significant PCB source to the lake (Miller *et al.*, 2001; Franz *et al.*, 1998; Holsen *et al.*, 1991). The annual PCB inputs from the atmosphere through the coarse particles could be in a range of 320 kg/year to 5,500 kg/year (data provided from the LMMBP atmospheric working group; Wethington and Hornbuckle, 2005; Franz *et al.*, 1998; and Holsen *et al.* 1991) during the period of 1989-1995. However, the science and technique is not well-developed enough to make reliable over-lake estimates of these fluxes. Much of the uncertainty in measuring large particle fluxes comes from the difficulty in quantifying how far these large particles travel from their source to the lake.

Model runs were designed to evaluate the impact of potential missing loads on the model outputs. A sensitivity analysis was completed for the Milwaukee load by adding 120 kg/year of PCB load into segment 1 in the LM2-Toxic model. Additional simulations were run to gain insight into how the model would respond to increasing the total PCB load (tributary load + atmospheric load) by 50% and 100%. The results from the sensitivity analysis were then compared with the LM2-Toxic model long-term (62 years) base run results (Figure 4.7.5). Compared to the steady-state concentration from the long-term base run, the simulation showed total PCBs in the water column increased less than 5% for the suggested 120 kg/year missing PCB source from the Milwaukee atmosphere. An increase of 15% and 30% was found for the simulations where the PCB load was increased by 50% and 100%, respectively. The amount of increase in total PCB concentrations was much less during the first five years of the simulation than during the steady-state period. This indicates that, under the current conditions in the Lake Michigan system, the LMMBP-generated PCB loads were not the dominant PCB flux controlling the concentration of PCBs in the lake. When the load was doubled, the PCB concentrations in the water column in the first few years only increased about 15%. Part 4, Chapter 6 provides quantitative analyses and in-depth discussions on the critical sources and sinks and important environmental processes for PCBs in Lake Michigan.

Table 4.7.4. PCB₂₈₊₃₁ Average Inventories of Water Column and Surficial Sediment Results From the LM2-Toxic Simulations for the Primary Production Sensitivity Analysis, and Changes in Percentage for These Inventories Compared to the Inventories From the Original Base Runs

PCBs (Short-Term Simulations)	Inventory (kg) From the Original Base Run	Inventory (kg) From the Run With 50% Reduction in Primary Production	Percent (%) Change	Inventory (kg) From the Run With 50% Increase in Primary Production	Percentage (%) Change
Water Column	70.79	69.67	-1.6	71.41	0.88
Surficial Sediment	808.76	797.63	-1.4	819.53	1.3
PCBs (Long-Term Simulations)					
Water Column	33.78	31.21	-7.6	35.71	5.7
Surficial Sediment	130.74	133.13	1.8	129.71	-0.79

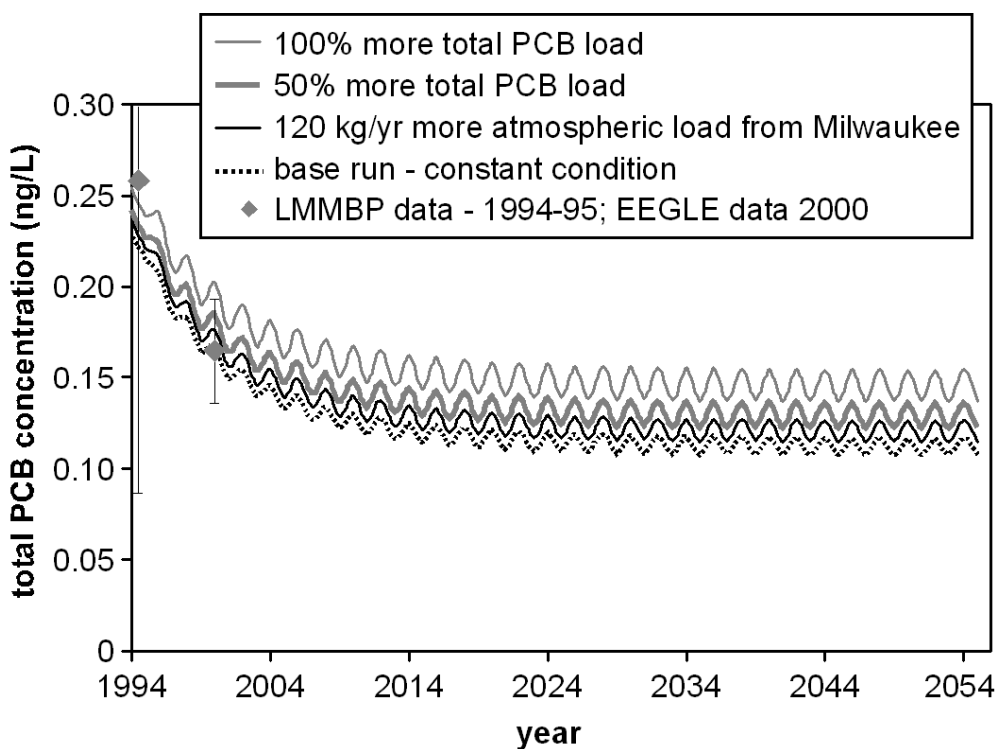

Figure 4.7.5. Sensitivity analysis of the LM2-Toxic predictions to varying PCB loads. Note: LMMBP data - 1994-1995 = 0.259 ± 0.172 ng/L; EEGLE data 2000 = 0.165 ± 0.029 ng/L. The model output concentrations and field data in this graph are lake-wide average concentrations.

References

- Franz, T.P., S.J. Eisenreich, and T.M. Holsen. 1998. Dry Deposition of Particulate Polychlorinated Biphenyls and Polycyclic Aromatic Hydrocarbons to Lake Michigan. *Environ. Sci. Technol.*, 32(23):3681-3688.
- Holsen, T.M., K.E. Noll, S. Liu, and W. Lee. 1991. Dry Deposition of Polychlorinated Biphenyls in Urban Areas. *Environ. Sci. Technol.*, 25(6):1075-1081.
- Miller, S.M., M.L. Green, J.V. DePinto, and K.C. Hornbuckle. 2001. Results From the Lake Michigan Mass Balance Study: Concentrations and Fluxes of Atmospheric Polychlorinated Biphenyls and *trans*-Nonachlor. *Environ. Sci. Technol.*, 35(2):278-285.
- Wethington, D.M. and K.C. Hornbuckle. 2005. Milwaukee, WI, as a Source of Atmospheric PCBs to Lake Michigan. *Environ. Sci. Technol.*, 39(1):57-63.

PART 5

LM FOOD CHAIN

Xin Zhang
Welso Federal Services, LLC
Large Lakes Research Station
9311 Groh Road
Grosse Ile, Michigan 48138

Chapter 1. Executive Summary

This part of the report documents the food web bioaccumulation model developed for the Lake Michigan Mass Balance Project (LMMBP). The model established dynamic relationships between polychlorinated biphenyl (PCB) concentrations in the exposure environments and result PCB levels in the fish food webs of Lake Michigan. The primary objective of this work was to provide practical modeling tools to predict toxic PCB levels in lake trout and coho salmon in response to projected water quality improvements for the lake.

The model was based upon available theory and data characterizing the bioaccumulation of toxic chemicals in fish and other aquatic organisms. A detailed description of the model development is provided in the document. Extensive collections of data on lake trout and coho salmon food webs in Lake Michigan were conducted to facilitate refinements of model parameters to site-specific conditions. Forty congeners or congener groups of PCBs were targeted for the model calibration or parameter refinements. These PCB congeners represented toxic chemicals covering a wide range of hydrophobicity.

The food web model was calibrated with PCB data collected in 1994 and 1995 for three lake trout food webs at Sturgeon Bay, Sheboygan Reef, and Saugatuck. The lake trout sub-populations in these three biota zones were believed to be appropriate representations of lake trout in Lake Michigan. Model calibration was also performed for a lake-wide coho salmon food web. During the model calibration, model parameters were refined to achieve an adequate agreement between model calculations and observed PCB data for a food web. In this study, the focus of model calibration was not limited to top predators nor to toxics with certain hydrophobicity. The model parameters were systematically optimized for all species at various trophic levels and for PCB congeners of a wide range of hydrophobicity. Extra care was taken to ensure the refined parameter values were consistent with the hydrophobicity of individual PCB congeners and with the trophic position of individual species. Satisfactory calibration results were achieved for the lake trout food webs at Sturgeon Bay and Saugatuck. Although no formal validation was possible due to additional requirements of large amount of PCB congener-specific field data, the calibrated food web models for Sturgeon Bay and Saugatuck were confirmed in some degree by the identical values of calibrated parameters between these two models.

The availability of a complete account of observed data for each food web made this model calibration probably the most thorough process among similar efforts. Although PCB concentrations in lake trout or coho salmon was the endpoint of the model computation and the focus of most model applications, we believe that the food web model with parameters “fine-tuned” for species at all trophic levels can be used to target any desirable species in the food web with a high degree of confidence. Also, the food web model was capable of assimilating toxics with various hydrophobicities. In fact, no food web model intended to simulate as many toxic chemicals with diverse hydrophobicity has been previously developed.

We believe that the food web model capable of simulating congener-based PCB dynamics in fish food webs provided a useful tool for the development of more effective load reduction plans or total maximum daily loads (TMDLs) targeted to priority PCB congeners, instead of traditional category-based load reduction plans targeted to various contaminant sources. The results of the PCB congener-based model simulations also help to better understand toxic chemical behavior in food webs.

The calibrated food web model was used to perform several model simulations for PCBs in lake trout food webs at Sturgeon Bay and Saugatuck. These model

simulations depicted dynamic responses of individual PCB congeners in the food webs to different PCB exposure input. Hypothetical long-term PCB exposure scenarios for the food webs at the Sturgeon Bay and Saugatuck biota zones were generated by the water quality model LM2-Toxic corresponding to different management choices for the reduction of PCBs into the Lake Michigan ecosystem.

For each long-term PCB exposure input, similar model responses were observed for these two biota zones. As an example, the temporal responses of individual PCB congener-based concentrations in adult lake trout at Sturgeon Bay associated with constant external PCB loadings are presented for discussion. The expected total PCB concentrations in adult lake trout at Saugatuck in response to various hypothetical PCB exposure inputs are also presented. Given the exposure PCB concentration time functions provided by the LM2-Toxic, the model simulations suggested that without further intervention, the total PCB concentrations in adult lake trout (5.5 year-old) was expected to reach the target level of 0.075 ppm in 2026 for Saugatuck biota zone and in 2032 for Sturgeon Bay biota zone.

PART 5

LM FOOD CHAIN

Chapter 2. Recommendations

Through the course of the development and calibration of the food web models, every effort was made to make full use of available information and to make necessary simplifications and assumptions to achieve a balanced progress without sacrificing the overall quality in the food web modeling. The models described in this part was believed to represent the best available knowledge for the management of congener-specific PCB contaminants in Lake Michigan food webs. However, additional works are needed to further improve the validation and to test the applicability of the models to other hydrophobic chemicals. There are also research needs that we believe are essential for the improvement of the performance of the fish models.

5.2.1 Additional Model Validations

Additional model validation should be conducted once sufficient new field data sets become available. One of the additional model validation would be to test the validity of the models for PCB concentrations in Lake Michigan food webs after 1994-1995. This exercise would include calculating PCB concentrations in fish using the new field data collections of PCB concentrations in water and sediment, comparing the model calculated data with actual measured PCB concentrations in fish, and evaluating model performance in reproducing future PCB concentrations in Lake Michigan fish.

Apparently, model validation is a continuous process. Each validation exercise only addresses model performance under a set of specific conditions or to

a type of application. For example, the aforementioned validation exercise, once achieved, indicates that the models can be used as a practical tool to make quantitative prognoses about PCB contaminants in particular Lake Michigan food webs.

In order to test models' applicability to other chemicals, model validation can also be extended to *trans*-nonachlor in Lake Michigan. There are adequate field data sets available to carry out this validation study. The values of chemical-specific model parameters for *trans*-nonachlor can be deduced from the correlations between parameter values and log K_{ow} values of the contaminants, which were established based on model calibrations for PCB congeners.

5.2.2 Model Applications

It is desirable to examine the capability of the fish models to reproduce archived fish PCB data for Lake Michigan. This can be done with the reconstruction of historical PCB concentrations in water and sediments by a fate and transport model (such as the LM2-Toxic) based on dated sediment core profiles for PCBs. Model estimates of past PCB concentrations in various fish species can then be made from the reconstructed concentrations in water and sediments. Once completed satisfactorily, the results of this model study may provide a better baseline for PCB load reduction analysis.

5.2.3 Future Improvements

The following were some of the research needs identified to be important for the improvement of the model quality.

- A. Additional studies for the refinement of bioenergetic information and growth data for species in lower trophic levels of the food webs, such as zooplankton, *Mysis*, deepwater sculpin, and slimy sculpin in Lake Michigan.
- B. Field measurement of the moisture contents of zooplankton, *Mysis*, and *Diporeia* at each biota zone in Lake Michigan. These data will help reduce model uncertainty associated with erroneous estimates of water content while converting dry weight-based data to wet weight-based.
- C. More studies on correlations between the chemical assimilation efficiency and K_{ow} values of the chemicals, and on species dependency of the chemical assimilation efficiency.
- D. Investigation of possible PCB metabolism in Lake Michigan fish, and the kinetics of the processes.
- E. More data collections for possible refinement of the model descriptions for fish dietary compositions in Lake Michigan.

PART 5

LM FOOD CHAIN

Chapter 3. Model Description

A food web bioaccumulation model usually consists of a series of submodels characterizing chemical bioaccumulation in each of the aquatic organisms in the food web. The individual submodels are linked together through feeding interactions among the organisms. The food web model (LM Food Chain) constructed for the Lake Michigan Mass Balance Project (LMMBP) is based on Version 5.2 of the computer model FDCHAIN which was originally developed by HydroQual, Inc., Mahwah, New Jersey. The original model and its early versions have been previously applied in numerous projects including the Green Bay Mass Balance Food Chain Modeling project (Connolly *et al.*, 1992). Several additions and modifications have been made to enhance the performance of the food web model. They include the introduction of a multi-compartment approach to better accommodate the spatially variable conditions in Lake Michigan, refinements of certain parameters to reflect advancements of knowledge in related disciplines, the incorporation of a new submodel for chemical bioaccumulation of benthic invertebrates, and the integration of alternative modeling equations for species-specific parameters that are not readily obtainable. The following is a detailed description of submodels used in the LM Food Chain for simulating organic chemicals in individual fish and in organisms of lower trophic levels of fish food webs.

5.3.1 Chemical Bioaccumulation in Fish

The model is a set of equations derived using the principle of mass conservation. It is generally accepted that the primary processes of chemical

exchange between a fish and its exposure environment are: 1) chemical uptake from water, 2) chemical uptake from food sources, 3) chemical elimination due to respiration and excretion, and 4) chemical concentration reduction by growth dilution (Figure 5.3.1). The submodel for chemical bioaccumulation in fish can then be derived based on a simple mass balance equation for chemicals in the fish. The general form of the mass balance equation is well-defined. The rate of change in chemical concentration in a fish (dC_F/dt) is equal to the sum of the relevant chemical fluxes into and out of the fish.

$$dC_F/dt = F_w + F_p - F_e - F_g \quad (5.3.1)$$

where

dC_F/dt = chemical increment in fish per unit time ($\mu\text{g}/\text{kg}/\text{day}$)

F_w = flux of chemical uptake from water ($\mu\text{g}/\text{kg}/\text{day}$)

F_p = flux of chemical uptake from prey items ($\mu\text{g}/\text{kg}/\text{day}$)

F_e = flux of chemical elimination *via* respiration ($\mu\text{g}/\text{kg}/\text{day}$)

F_g = flux of chemical reduction by growth dilution ($\mu\text{g}/\text{kg}/\text{day}$)

In some cases, other chemical fluxes, such as flux associated with the chemical elimination through metabolism transformation in the organism, may also need to be included in Equation 5.3.1. In this study,

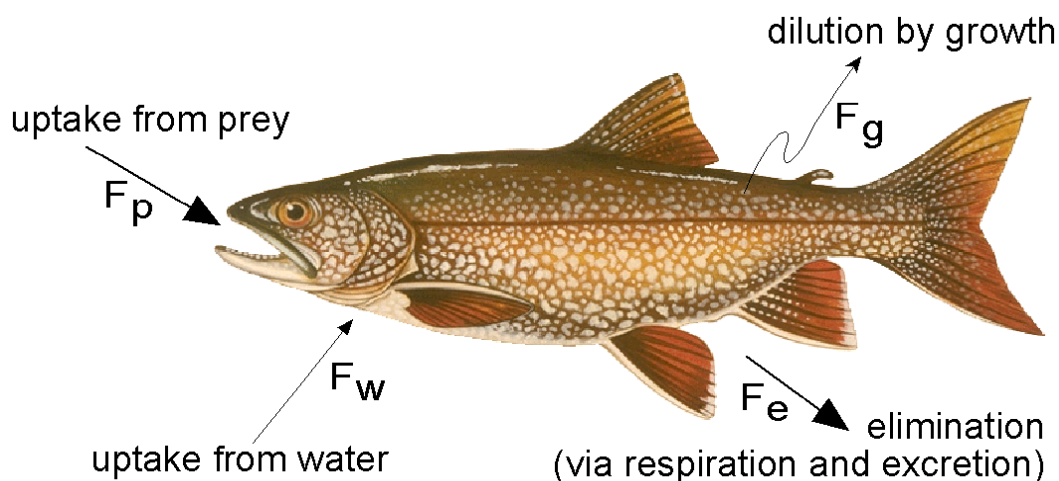

Figure 5.3.1. Primary chemical exchange processes between a fish and its environment.

we assumed that metabolism transformation of polychlorinated biphenyl (PCB) contaminants was negligible (Gobas, 1993; Stapleton *et al.*, 2001; U.S. Environmental Protection Agency, 1999).

After construction of the mathematical description for each of the chemical fluxes in the mass balance equation, the chemical concentration in the fish C_F ($\mu\text{g-chem/kg-body}$) at time $t + \Delta t$ was then calculated by numerical integration:

$$C_F(t + \Delta t) = C_F(t) + [dC_F(t)/dt] \cdot \Delta t \quad (5.3.2)$$

To predict chemical bioaccumulation for top predator fish, the mass balance equation was repeatedly applied to organisms at each trophic level to simulate chemical biomagnification from forage species to top predators.

Several methods have been developed to describe chemical dynamics in fish and to estimate related chemical fluxes in the mass balance equation. In this food web bioaccumulation model, the chemical dynamics were described based on fish bioenergetics (Lantry and Stewart, 1993; Rudstam, 1989; Rudstam *et al.*, 1994; Stewart *et al.*, 1983; Stewart and Binkowski, 1986). The mathematical equation used to estimate the chemical fluxes in the mass balance equation are described below.

5.3.1.1 Chemical Uptake From Water

The chemical flux entering an organism from water *via* gill ventilation (F_w) is expressed as a product of the fish's ventilation rate and the dissolved chemical concentration in water. The extent to which chemicals that enter the gill compartment by gill ventilation and are actually absorbed by the fish is usually expressed by the chemical gill transfer coefficient, E_c , which is included in F_w .

$$F_w = E_c \cdot K_v \cdot C_w \quad (5.3.3)$$

where

E_c = chemical gill transfer coefficient

K_v = gill ventilation rate (L-water/kg-fish/day)

C_w = dissolved chemical concentration in water ($\mu\text{g-chem/L-water}$)

The gill ventilation rate of a fish (K_v) is dependent on the amount of oxygen required by the fish to sustain its normal respiration (R_o) and the oxygen content in the water that passes through the gill membrane.

$$K_v = R_o / (E_o \cdot [O_2]) \quad (5.3.4)$$

where

R_o = rate of oxygen uptake from water, or fish respiration rate (mg-O₂/kg-fish/day)

E_o = oxygen gill transfer coefficient

$[O_2]$ = oxygen content in water (mg-O₂/L-water)

Similarly, the oxygen gill transfer coefficient, E_o , reflects the extent to which oxygen that enters the gill compartment by gill ventilation is actually absorbed by the fish. The value of R_o , which is expressed in terms of oxygen consumption, can usually be calculated using a bioenergetics model (Hewett and Johnson, 1989). Oxygen content in water $[O_2]$ was estimated as a function of water temperature based on an empirical equation for oxygen saturation in water (Greenberg *et al.*, 1992).

Substituting Equation 5.3.4 into Equation 5.3.3, the chemical flux *via* gill uptake from water (F_w) then follows as

$$F_w = (E_c/E_o) \cdot (R_o/[O_2]) \cdot C_w \quad (5.3.5)$$

5.3.1.2 Chemical Uptake From Prey

The chemical flux absorbed by fish from diet (F_p) *via* the gastrointestinal tract is expressed using the food ingestion rate of the fish (K_f) and chemical concentration in its diet (C_p). The extent to which chemicals in the diet are actually absorbed by the fish can be expressed by the chemical assimilation efficiency α , which is included in F_p .

$$F_p = \alpha \cdot K_f \cdot C_p \quad (5.3.6)$$

where

α = chemical assimilation efficiency

K_f = food ingestion rate (g-prey/g-body/day)

C_p = chemical concentration in prey (μ g-chem/g-food)

The chemical concentration in the diet (C_p) is based on diet composition and chemical content in each prey component. The food ingestion rate is determined by an energy balance. The energy intake

from food sources is equal to the energy expenditure of the fish for respiration and growth:

$$(K_f \cdot D_p) \cdot \beta = R \cdot D_F + G \cdot D_F \quad (5.3.7)$$

where

D_p = energy density of prey (kJ/kg-prey)

D_F = energy density of the fish (kJ/kg-body)

R = fish respiration rate (kg-fish/kg-body/day)

G = fish growth rate (kg-fish/kg-body/day)

β = fraction of ingested energy that is assimilated

R can usually be calculated using a fish bioenergetics model (Hewett and Johnson, 1989). G can be estimated by individual fish weight-age relationships. The energy density (D_F and D_p) can be estimated from the lipid and protein content of the fish and prey. Substituting Equation 5.3.7 into Equation 5.3.6, the flux of chemical uptake *via* food consumption, F_p , can be formulated as follows:

$$F_p = (\alpha/\beta) \cdot (D_F/D_p) \cdot (R + G) \cdot C_p \quad (5.3.8)$$

5.3.1.3 Chemical Elimination *Via* Gills

The flux of chemicals eliminated by a fish *via* the gills is expressed as a product of gill elimination rate constant, K_e , and chemical concentrations in the organism, C_F :

$$F_e = K_e \cdot C_F \quad (5.3.9)$$

where

K_e = gill elimination rate constant (1/day)

C_F = chemical concentration in organism (μ g-chem/kg-body)

Because the elimination is, in essence, the reverse process of gill uptake, the gill elimination rate constant can be related to the gill uptake rate constant. If we view the ratio of gill uptake and elimination rate constants as the chemical partition coefficient between the body tissue and aqueous

phases of the organism, the gill elimination rate constant can then be derived as

$$K_e = (E_c \cdot K_v) \cdot \rho / (f_a + f_L \cdot \pi) \quad (5.3.10)$$

where

E_c = chemical gill transfer coefficient

K_v = gill ventilation rate (L-water/kg-body/day)

ρ = aqueous phase density of the organism (kg/L)

f_a = non-lipid fraction of the fish

f_L = lipid fraction of the fish

π = chemical partition coefficient between lipid and non-lipid phases of the organism

Substitution of Equation 5.3.10 into Equation 5.3.9 yields an equation for estimating the flux of chemicals eliminated from the fish *via* gill ventilation:

$$F_e = C_F \cdot (E_c \cdot K_v) \cdot \rho / (f_a + f_L \cdot \pi) \quad (5.3.11)$$

For most organic chemicals, gill elimination is a major mechanism of chemical discharge from fish (Gobas *et al.*, 1989). Fecal elimination and excretion of chemicals are not specifically modeled in this mass balance equation. Their contribution can be viewed as having been factored into the food of chemical assimilation efficiency and gill transfer coefficient.

5.3.1.4 Chemical Dilution by Growth

Fish growth results in an increase of the fish volume and a reduction of chemical mass per fish volume. The equivalent flux of chemical loss due to fish growth (F_g) is expressed as a product of the fish growth rate (G) and chemical concentration in the fish (C_F).

$$F_g = G \cdot C_F \quad (5.3.12)$$

where

G = growth rate of organism (1/day)

C_F = chemical concentration in fish ($\mu\text{g-chem/kg-body}$)

The fish growth rate (G) was estimated based on fish weight-age relationships established for each fish species.

5.3.2 Chemical Bioaccumulation in the Base of Food Webs

The aquatic species at the base of the Lake Michigan food web are zooplankton (pelagic) and *Diporeia* (benthic). The modeled equations discussed above for individual fish can not be applied to zooplankton and *Diporeia* due to the lack of species-specific bioenergetics data. Alternative submodels are needed for chemical bioaccumulation in the base of the food webs.

5.3.2.1 Chemical Bioaccumulation in Zooplankton

Zooplankton in the Lake Michigan food webs are a mixture of a wide variety of species. The species composition of the zooplankton is not fixed. It varies with season depending on the optimal temperature for the growth of individual species. It is also dependent on prey selections of its predators in a given food web. At this stage, it is unfeasible to develop a kinetic submodel for this species group due to the lack of appropriate information.

For simplicity, a steady-state model was adapted in our food web models to calculate concentrations in Lake Michigan zooplankton. In this chemical bioaccumulation submodel, zooplankton were assumed to be a homogeneous pseudo-species. Under steady-state, the chemical mass balance Equation 5.3.1 can then be expressed as

$$F_w + F_p - F_e - F_g = 0 \quad (5.3.13)$$

The parameters in this equation have the same definition as those in the fish submodel. Substituting Equations 5.3.3, 5.3.6, 5.3.9, and 5.3.12 into Equation 5.3.13, the chemical concentration in zooplankton C_z can then be calculated by the following equation.

$$C_z = (K_c \cdot K_v \cdot C_w + \alpha \cdot K_f \cdot C_p) / (K_e + G) \quad (5.3.14)$$

5.3.2.2 Chemical Bioaccumulation in *Diporeia*

There are several experimental studies on chemical uptake from sediments by *Diporeia* (Landrum, 1989; Landrum *et al.*, 1985). Because most of the studies were conducted under controlled laboratory conditions, the kinetics of chemical exchange between *Diporeia* and its environment derived from these studies can not be readily transformed into a kinetic model applicable to a real system. The lack of information on site-specific growth data and the difficulty in characterizing the surface sediment portion that is actively selected by *Diporeia* as a food source also hindered the development of a kinetic model for chemical bioaccumulation in *Diporeia*.

The submodel for chemical bioaccumulation in *Diporeia* used in this food web model was based on a published steady-state model for benthic animals. This model, introduced by Morrison *et al.* (1996), assumes that under a steady-state condition the total chemical intake flux from water (U_w) and food (U_d) by a benthic animal equals the total chemical elimination flux from the animal *via* gill (D_w), faeces (D_f), and metabolism (D_m):

$$U_w + U_d = D_w + D_f + D_m \quad (5.3.15)$$

For detritivores, this assumption yields the equation:

$$\begin{aligned} (f_b/f_s) = & [E_w \cdot G_w \cdot (f_w/f_s) + E_d \cdot G_d \cdot (f_d/f_s) \\ & \cdot DS_d \cdot OC_d \cdot K_{oc}] / \\ & / [E_w \cdot G_w + E_d \cdot (1 - \alpha) \cdot (1 - \beta) \\ & \cdot G_d \cdot DS_d \cdot OC_d \cdot K_{oc} \\ & + V_b \cdot k_m \cdot K_{bw}] \end{aligned} \quad (5.3.16)$$

where

- f_b = chemical fugacity in benthos, Pa
- f_s = chemical fugacity in sediment, Pa
- f_d = chemical fugacity in diet (sediment or suspended particles), Pa
- E_w = chemical assimilation efficiency from water

- G_w = gill ventilation rate, L/day
- E_d = chemical assimilation efficiency from diet
- G_d = food ingestion rate, L (wet volume)/day
- DS_d = density of diet (wet), kg/L
- OC_d = organic carbon fraction of diet on wet weight base
- K_{oc} = organic carbon-water partition coefficient, L/kg
- α = organic carbon assimilation efficiency
- β = fraction of ingested diet absorbed
- V_b = volume of benthic animal, L
- k_m = chemical metabolic transformation rate in benthic animal, 1/day
- K_{bw} = benthos-water partition coefficient of chemicals, L/L

With mathematical manipulation and necessary unit conversion, the chemical fugacity terms (f_b/f_s), (f_w/f_s) and (f_d/f_s) in this model equation can be replaced by some more readily available chemical parameters. The submodel for chemical bioaccumulation in benthic animals can then be expressed as:

$$\begin{aligned} C_B = & (E_w \cdot G_w \cdot C_w + E_d \cdot G_D \cdot C_D) \cdot L_b \cdot K_{ow} / \\ & / [E_w \cdot G_w \cdot 1000 + E_d \cdot (1 - \alpha) (1 - \beta) \\ & \cdot G_d \cdot K_{oc} + W_b \cdot k_m \cdot K_{ow}] \end{aligned} \quad (5.3.17)$$

where

- C_B = chemical concentration in fresh benthic animal, $\mu\text{g/g-wet}$
- C_D = chemical concentration in diet (organic carbon normalized), $\mu\text{g/g-OC}$
- G_D = food ingestion rate, g-OC/day

W_b = body weight of fresh benthic animal, gram

L_b = lipid fraction in fresh benthic animal

5.3.3 Model Description of Exposure Environment

Calculations in the submodels discussed above require information which characterizes the environmental conditions for individual organisms, such as environmental temperature, oxygen content, and the contaminant levels in water (for pelagic species) and sediment (for benthic species). These data are essential for application of a food web bioaccumulation model.

However, among all existing aquatic food web models the environmental condition of a food web is typically defined with a single spatial compartment. This makes no distinction of preferred living condition among individual organisms and implies that all organisms in a food web live in an uniform environment. This simplified model approach is adequate for food webs in shallow and small water bodies where gradients are relatively small, and thus the exposure environments are expected to be similar among organisms in different trophic levels on a seasonal basis. However, for food webs in a large aquatic system, such as Lake Michigan, the single spatial compartment approach for defining exposure environment of a food web may not be adequate.

In Lake Michigan, the spatial variation in water temperature can be substantial, especially during summer stratification (Ayers, 1962; Brandt *et al.*, 1991; Carr, 1973; Sommers *et al.*, 1981). As a result, organisms in the lake are exposed to different temperatures depending on individual temperature preferences (Brandt *et al.*, 1980; Otto *et al.*, 1976). Species living in surface water are exposed to a temperature that varies dramatically from season to season. Species living in deep water are exposed to a relatively stable temperature. There are also species that prefer different environments at different life stages. The exposure temperatures of these species are expected to vary by age (Lantry and Stewart, 1993; Stewart and Binkowski, 1986). It is therefore, possible for a food web to consist of predators and prey that have different exposure temperatures. It appears that existing food web model frameworks are not adequately formulated to

accommodate the differential exposure temperatures among organisms in Lake Michigan food webs.

To better represent the exposure environment for each component of a food web and thus, to reduce the associated uncertainties in model estimates, a multi-compartment approach was introduced in the food web model framework. Unlike the original single compartment modeling approach which models the exposure condition as a homogeneous one for the whole food web, the multi-compartment approach allows modelers to define the exposure conditions individually for each organism with separate spatial compartments. Each compartment can be assigned organism-specific parameters which reflect the environmental condition of the preferred location of the associated organism. The temporal variation of the preferred location of the organism can be represented by the corresponding change in the parameters of the compartment over time. Figure 5.3.2 provides the conceptual diagrams for both the original single compartment approach and the new multi-compartment modeling approach. For the modified model approach, the differential exposure temperatures among the organisms in a food web can be easily described by defining each organism with an independent spatial compartment.

References

- Ayers, J.C. 1962. Great Lakes Water, Their Circulation and Physical and Chemical Characteristics. In: H.J. Pincus (Ed.), Great Lakes Basin. American Association for the Advancement of Science, Washington, D.C.
- Brafield, A.E. and M.J. Llewellyn. 1982. Animal Energetics. Blackie and Son, Ltd., Glasgow, Scotland. 168 pp.
- Brandt, S.B., J.J. Magnuson, and L.B. Crowder. 1980. Thermal Habitat Partitioning by Fishes in Lake Michigan. Canadian J. Fish. Aquat. Sci., 37(7):1557-1564.
- Brandt, S.B., D.M. Mason, E.V. Patrick, R.L. Argyle, L. Wells, P.A. Unger, and D.J. Stewart. 1991. Acoustic Measures of the Abundance and Size of Pelagic Planktivores in Lake Michigan. Canadian J. Fish. Aquat. Sci., 48(5):894-908.

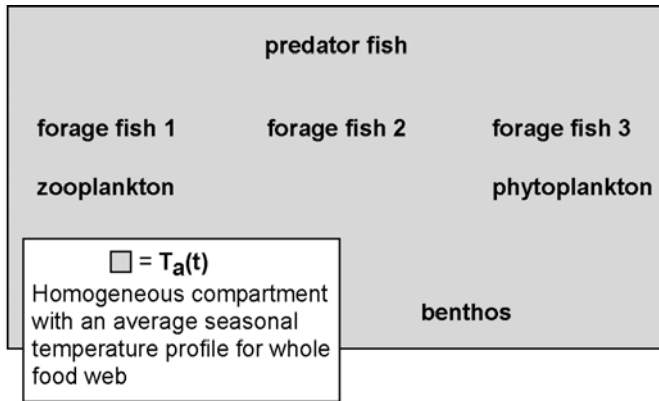

A. Single compartment approach for exposure temperature in existing food chain models.

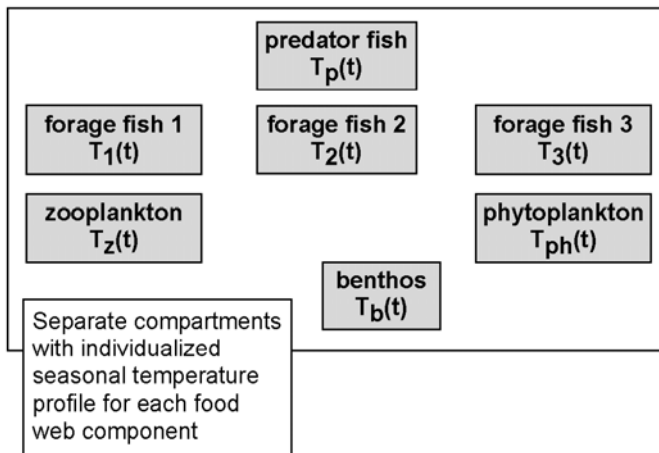

B. Multi-compartment approach for exposure temperature in food chain models.

Figure 5.3.2. Comparison of modeling approaches for exposure temperatures in food web models.

Carr, J.F., J.W. Moffett, and J.E. Gannon. 1973. Thermal Characteristics of Lake Michigan, 1954-1955. U.S. Bureau of Sport Fisheries and Wildlife, Washington, D.C. Technical Paper 69, 143 pp.

Connolly, J.P., T.F. Parkerton, J.D. Quadrini, S.T. Taylor, and A.J. Turmann. 1992. Development and Application of PCBs in the Green Bay, Lake Michigan Walleye and Brown Trout and Their Food Webs. Report to the U.S. Environmental Protection Agency, Office of Research and Development, ERL-Duluth, Large Lakes Research Station, Grosse Ile, Michigan. 300 pp.

Gobas, F.A.P.C., K.E. Clark, W.Y. Shiu, and D. Mackay. 1989. Bioaccumulation of Polybrominated Benzenes and Biphenyls and Related Superhydrophobic Chemicals in Fish: Role of Bioavailability and Fecal Elimination. *Environ. Toxicol. Chem.*, 8(3):231-247.

Gobas, F.A.P.C. 1993. A Model for Predicting the Bioaccumulation of Hydrophobic Organic Chemicals in Aquatic Food-Webs: Application to Lake Ontario. *Ecol. Model.*, 69(1/2):1-17.

Greenberg, A.E., L.S. Clesceri, and A.D. Eaton (Eds.). 1992. Standard Methods for the Examination of Water and Wastewater, 18th Edition. American Public Health Association, Washington, D.C. 982 pp.

Hewett, S.W. and B.L. Johnson. 1989. A General Bioenergetics Model for Fishes. *American Fisheries Society Symposium*, 6:206-208.

Landrum, P.F., B.E. Eadie, W.R. Faust, N.R. Morehead, and M.J. McCormick. 1985. The Role of Sediment in the Bioaccumulation of Benzo(a)pyrene by the Amphipod *Pontoporeia hoyi*. In: M. Cooke and A.J. Dennis (Eds.), *Polynuclear Aromatic Hydrocarbons: Mechanisms, Methods and Metabolism*, Eighth International Symposium, pp. 799-812. Battelle Press, Columbus, Ohio.

Landrum, P.F. 1989. Bioavailability and Toxicokinetics of Polycyclic Aromatic Hydrocarbons Sorbed to Sediments for the Amphipod, *Pontoporeia hoyi*. *Environ. Sci. Technol.*, 23(5):588-595.

Lantry, B.F. and D.J. Stewart. 1993. Ecological Energetics of Rainbow Smelt in the Laurentian Great Lakes: An Interlake Comparison. *Trans. Amer. Fish. Soc.*, 122(5):951-976.

Morrison, H.A., F.A.P.C. Gobas, R. Lazar, and G.D. Haffner. 1996. Development and Verification of a Bioaccumulation Model for Organic Contaminants in Benthic Invertebrates. *Environ. Sci. Technol.*, 30(11):3377-3384.

-
- Otto, R.G., M.A. Kitchel, and J.O. Rice. 1976. Lethal and Preferred Temperatures of the Alewife (*Alosa pseudoharengus*) in Lake Michigan. *Trans. Amer. Fish. Soc.*, 105(1):96-106.
- Rudstam, L.G. 1989. A Bioenergetic Model for *Mysis* Growth and Consumption Applied to a Baltic Population of *Mysis mixta*. *J. Plankton Res.*, 11(5):971-983.
- Rudstam, L.G., F.P. Binkowski, and M.A. Miller. 1994. A Bioenergetic Model for Analysis of Food Consumption Patterns by Bloater in Lake Michigan. *Trans. Amer. Fish. Soc.*, 123(3):344-357.
- Sommers, L.M., C. Thompson, S. Tainter, L. Lin, T.W. Colucci, and J.M. Lipsey. 1981. Fish in Lake Michigan. Michigan Sea Grant Advisory Program, Ann Arbor, Michigan. 38 pp.
- Stapleton, H.M., R.J. Letcher, and J.E. Baker. 2001. PCB Metabolism in a Freshwater Fish. *Environ. Sci. Technol.*, 35(12):4747-4752.
- Stewart, D.J., D. Weininger, D.V. Rottiers, and T.A. Edsall. 1983. An Energetics Model for Lake Trout, *Salvelinus namaycush*: Application to the Lake Michigan Population. *Canadian J. Fish. Aquat. Sci.*, 40(6):681-698.
- Stewart, D.J. and F.P. Binkowski. 1986. Dynamics of Consumption and Food Conversion by Lake Michigan Alewives: An Energetics-Modeling Synthesis. *Trans. Amer. Fish. Soc.*, 115(5):643-661.
- U.S. Environmental Protection Agency. 1999. Polychlorinated Biphenyls (PCBs) Update: Impact on Fish Advisories. U.S. Environmental Protection Agency, Office of Water, Washington, D.C. 7 pp.

PART 5

LM FOOD CHAIN

Chapter 4. Description of Data, Constants, and Other Information Necessary to Run Model

5.4.1 Chemical Properties of PCB Contaminants

Polychlorinated biphenyls (PCBs) have been recognized as significant environmental contaminants since 1966 (Mullin *et al.*, 1984). Their impact is particularly evident in the Great Lakes basin (Neidermeyer and Hickey, 1976; Hesselberg *et al.*, 1990; Oliver *et al.*, 1989; Eisenreich *et al.*, 1989). In this modeling project, 40 PCB congeners or co-eluters were targeted for simulation of their individual bioaccumulation by fish in the lake. Most of the PCB congeners were selected for their abundance and bioaccumulative tendency in the lake ecosystem. Other PCB congeners were included to make the targeted PCB group cover the full range of PCB hydrophobicity, and thus, a better representative subset of all existing 209 PCB congeners.

Hydrophobicity of a PCB congener is measured by its octanol-water partition coefficient (K_{ow}) which is the most important chemical property governing bioaccumulation of the congener in organisms. Another important chemical property involved in modeling PCB contaminants is the organic carbon partition coefficient (K_{oc}) whose value can often be correlated to that of K_{ow} . In this work, the following empirical relationship (Eadie *et al.*, 1990) was used:

$$\log K_{oc} = 1.94 + 0.72 \log K_{ow} \quad (5.4.1)$$

The targeted PCB congeners or co-eluter congeners are listed in Table 5.4.1 with their octanol-water partition coefficients K_{ow} . The values of K_{ow} are those of Hawker and Connell (1988). The molecular weight (MW) for each PCB congener is also listed for additional reference.

5.4.2 Site-Specific Data

5.4.2.1 Fish Food Web Structures

The structure of a food web shows how individual organisms in the food web are related to each other through feeding interactions. This dietary information is necessary for establishing appropriate linkages among individual submodels of a food web model and is important to the accurate simulation of chemical bioaccumulation in the food web.

The fish food webs of interest are those of two top predators in Lake Michigan, lake trout and coho salmon. These two species were selected for their important economic value. It is desirable to have a better understanding of the present and future concentrations of PCB contaminants in these two fish populations with the help of model simulations.

5.4.2.1.1 Lake Trout Food Web

It is believed that the lake trout in Lake Michigan are represented by three subpopulations at Sturgeon Bay, Sheboygan Reef, and Saugatuck (Figure 5.4.1). Movements of lake trout in Lake Michigan are believed to be considerably restricted in range (Brown *et al.*, 1981). Each of the lake trout subpopulations has a site-specific food web structure.

Table 5.4.1. Targeted PCB Congeners and Their K_{ow}

Congener	IUPAC	Homolog	Molecular Weight	log K _{ow}
	0	0	154	4.09
4	3	1	188	4.69
2,3	5	2	223	4.97
2,4'	8	2	223	5.07
3,4	12	2	223	5.22
3,4'	13	2	223	5.29
4,4'	15	2	223	5.3
2,4',4	17	3	257	5.25
2,2',3	16	3	257	5.16
2,4',6	32	3	257	5.44
2,2',5	18	3	257	5.24
2,3',5	26	3	257	5.66
2,4,4'	28	3	257	5.67
2,4',5	31	3	257	5.67
2',3,4	33	3	257	5.6
3,4,4'	37	3	257	5.83
2,2',3,4'	42	4	292	5.76
2,2',3,5'	44	4	292	5.75
2,2',4,5'	49	4	292	5.85
2,2',5,5'	52	4	292	5.84
2,3,3',4'	56	4	292	6.11
2,3,4,4'	60	4	292	6.11
2,3',4,4'	66	4	292	6.2
2,3',4',5	70	4	292	6.2
2',3,4,5	76	4	292	6.13
2,4,4',5	74	4	292	6.2
3,3',4,4'	77	4	292	6.36
2,3,3',4',6	110	5	326	6.48
3,4,4',5	81	4	292	6.36
2,2',3,4,5'	87	5	326	6.29
2,2',3,3',6	84	5	326	6.04
2,2',3,5,5'	92	5	326	6.35
2,2',3,4,6'	89	5	326	6.07
2,2',3,4,4'	85	5	326	6.3
2,2',4,4',5	99	5	326	6.39
2,2',4,5,5'	101	5	326	6.38
2,3',4,4',5	118	5	326	6.74
2',3,4,4',5	123	5	326	6.74
2,2',3,4',5',6	149	6	361	6.67
2,3,3',4,4'	105	5	326	6.65
2,2',3,3',4,6'	132	6	361	6.58
2,2',4,4',5,5'	153	6	361	6.92
2,2',3,5,5',6	151	6	361	6.64
2,2',3,4,4',5'	138	6	361	6.83
2,3,3',4',5,6	163	6	361	6.99
2,2',3,4',5,5'	146	6	361	6.89
2,2',3,3',4,4',5	170	7	395	7.27

Table 5.4.1. Targeted PCB Congeners and Their K_{ow} (Continued)

Congener	IUPAC	Homolog	Molecular Weight	$\log K_{ow}$
2,3,3',4,4',5,6'	190	7	395	7.46
2,2',3,3',4,5,5'	172	7	395	7.33
2,2',3,3',4,4',6,6'	197	8	430	7.3
2,2',3,4,4',5,5'	180	7	395	7.36
2,2',3,4,4',5,6'	182	7	395	7.2
2,2',3,4',5,5',6	187	7	395	7.17
2,2',3,3',4,4',5,6	195	8	430	7.56
2,2',3,3',4,5,5',6,6'	208	9	464	7.71
2,2',3,3',4,4',5',6	196	8	430	7.65
2,2',3,4,4',5,5',6	203	8	430	7.65
2,2',3,3',4',5,5',6	201	8	430	7.62

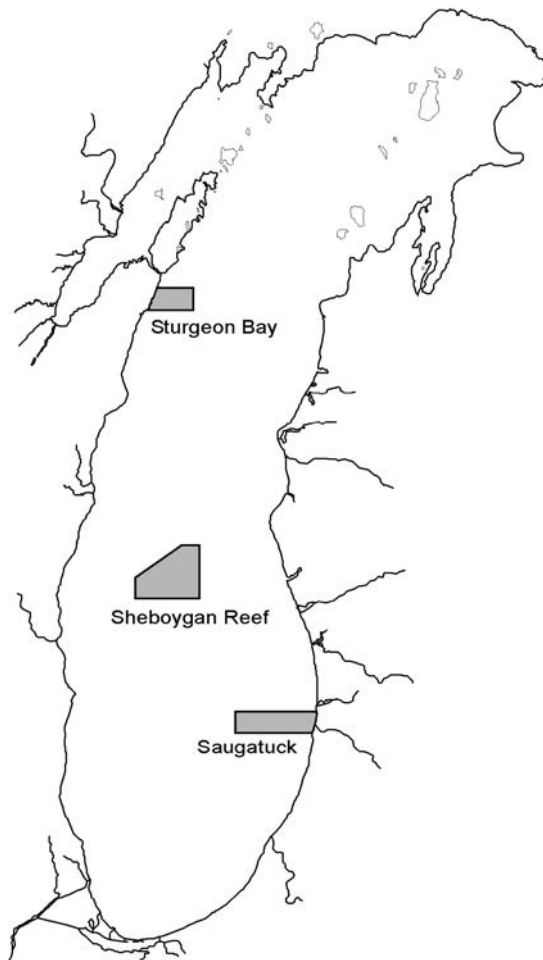

Figure 5.4.1. Biota zones in Lake Michigan.

For each lake trout subpopulation, the food web was constructed using dietary data compiled from field sampling of lake trout and associated forage fish population. Lake trout (*Salvelinus namaycush*) were caught at the three locations during the spring, summer, and fall of 1994 and 1995. They were primarily captured *via* gill netting at depths ranging from 9 to 40 m. A minor portion of trout was captured by bottom trawling. Bottom trawling was used at depths of 10 to 50 m to obtain forage fish. Prey fish included alewife (*Alosa pseudoharengus*), rainbow smelt (*Osmerus mordax*), bloater (*Coregonus hoyi*), slimy sculpin (*Cottus cognatus*), and deepwater sculpin (*Myoxocephalus thompsoni*). The diets of lake trout and forage fish were determined by stomach analysis following a standard operating procedure established for the Lake Michigan Mass Balance Project (LMMBP) (U.S. Environmental Protection Agency, 1997a). For lake trout, the diet components were further classified into age classes.

The organisms in the base of Lake Michigan fish food webs are zooplankton, *Mysis*, and *Diporeia*. Their dietary information was obtained from literature sources. *Mysis* are reported to feed on zooplankton, phytoplankton, and “fresh” detrital material at the sediment surface and suspended in the water column (Beeton and Bowers, 1982; Grossnickle, 1982). Zooplankton are believed to feed on organic-rich particles, mainly phytoplankton in the water column (Peters and Downing, 1984). *Diporeia* are reported to feed on relatively “fresh” detrital material at the sediment surface (Evans *et al.*, 1990; Gardner *et al.*, 1990; Johnson, 1987; Lydy and Landrum, 1993; Marzolf, 1965; Quigley, 1988; Quigley and Vanderploeg, 1991).

Annual average dietary data for lake trout and its forage populations in the three biota zones of the lake are summarized in Tables 5.4.2a through 5.4.7. These data were used to construct a complete food web structure for each of the three lake trout populations in Lake Michigan.

5.4.2.1.2 Coho Salmon Food Web

The coho salmon in Lake Michigan are believed to move around large portions of the lake during the fish’s lifetime (Patriarche, 1980). They were modeled as a single lake-wide population. The dietary

information of the coho salmon was compiled from field sampling. Coho salmon (*Oncorhynchus kisutch*) were sampled from angler’s catches at various locations of the lake from May to November in 1994 and April to November in 1995.

The diet of coho salmon was determined by stomach analysis following a standard operating procedure established for the LMMBP (Elliott *et al.*, 1996; Elliott and Holey, 1998; U.S. Environmental Protection Agency, 1997a). The prey species were further classified into age classes. The results are presented in Table 5.4.8.

Due to their extensive movement, coho salmon in the lake may encounter site-specific forage populations in different regions. This means that a given forage species in the coho salmon diet may belong to different subpopulations. The forage fish may have a location-dependent dietary history. Therefore, the food web structure below the top trophic level can vary with the movement of coho salmon. In order to construct an accurate food web structure for coho salmon in Lake Michigan, information on its migration pattern and food web structures of its forage populations in related locations is needed. The migration pattern of the coho salmon was established based on a general index of fish density, catch-per-unit-of-effort (CPE), in various locations on a monthly basis. In general, the fish aggregate in southern Lake Michigan during spring and travel to the southwestern region of the lake in summer. In the late summer and early autumn, most of the coho salmon are found in the northeastern region of the lake. They move back to the southeastern region during the winter. However, dietary information for forage fish in these locations were not readily available. Therefore, it was not possible to construct a comprehensive food web structure for coho salmon that reflects the seasonal or spatial variation of its forage food webs.

The most complete dietary information for forage fish was that collected from the Sturgeon Bay, Sheboygan Reef, and Saugatuck lake trout biota zones (Tables 5.4.3 through 5.4.7). In this study, these dietary data were used to construct three local food web structures for the coho salmon by linking each of them with the dietary data of the coho salmon as presented in Table 5.4.8.

Table 5.4.2a. Annual Dietary Composition of Lake Trout at Saugatuck (1994-1995)

Lake Trout Age	Forage Fish Age	Alewife	Rainbow Smelt	Bloater	Slimy Sculpin	Deepwater Sculpin	Diporeia	Mysis
Age 1	Age 1				20		20	
	Age 2				20			
	Age 3				20			
	Age 4							
	Age 5				20			
Age 2	Age 1	35						
	Age 2	5	20			40		
Age 3	Age 1	10	20		10			
	Age 2		20					
	Age 3		30					
	Age 4				10			
Age 4	Age 2	5	25	10				
	Age 3	10	25					
	Age 4			25				
Age 5	Age 2	5						
	Age 3	10	20			15		
	Age 4	10		40				
Age 6	Age 2	10	5					
	Age 3	20						
	Age 4	10	5	20				
	Age 5							
	Age 6	20		10				
Age 7	Age 3	15						
	Age 4	15		30				
	Age 5	10						
	Age 6			30				
Age 8	Age 3	10						
	Age 4	20		15				
	Age 5			20				
	Age 6	20		10				
	Age 7	5						
Age 9	Age 4	20						
	Age 5			30				
	Age 6	20		10				
	Age 7	20						
Age 10	Age 2		10					
	Age 3	10						
	Age 4	15	15	10				
	Age 5			10				
	Age 6	30						

Table 5.4.2a. Annual Dietary Composition of Lake Trout at Saugatuck (1994-1995) (Continued)

Lake Trout Age	Forage Fish Age	Alewife	Rainbow Smelt	Bloater	Slimy Sculpin	Deepwater Sculpin	<i>Diporeia</i>	<i>Mysis</i>
Age 11	Age 3	10						
	Age 4			30				
	Age 5			25				
	Age 6	10						
	Age 7			25				
Age 12	Age 1		5					
	Age 2							
	Age 3	10						
	Age 4							
	Age 5	20		15				
	Age 6		10	30				
	Age 7	10						

Table 5.4.2b. Annual Dietary Composition of Lake Trout at Sheboygan Reef (1994-1995)

Lake Trout Age	Forage Fish Age	Alewife	Rainbow Smelt	Bloater	Slimy Sculpin	Deepwater Sculpin	<i>Diporeia</i>	<i>Mysis</i>
Age 1	Age 1	85					15	
Age 2	Age 1	80				10	5	5
Age 3	Age 1	55						
	Age 2							45
Age 4	Age 1	20						
	Age 2	20				10		20
	Age 3	10						
	Age 4			10				
	Age 5				10			
Age 5	Age 1	20						
	Age 2	15						10
	Age 3	15						
	Age 4	10		20				
	Age 5				10			
	Age 6							
Age 6	Age 2	30		10				
	Age 3	20						
	Age 4	10						
	Age 5	10		20				

**Table 5.4.2b. Annual Dietary Composition of Lake Trout at Sheboygan Reef (1994-1995)
(Continued)**

Lake Trout Age	Forage Fish Age	Alewife	Rainbow Smelt	Bloater	Slimy Sculpin	Deepwater Sculpin	<i>Diporeia</i>	<i>Mysis</i>
Age 7	Age 2	35						
	Age 3	25						
	Age 4	10		15				
	Age 5	15						
Age 8	Age 2	20						
	Age 3	5						
	Age 4	20		20				
	Age 5	15		20				
Age 9	Age 2	10						
	Age 3	15						
	Age 4	30						
	Age 5	20		10				
	Age 6			15				
Age 10	Age 2	5						
	Age 3	20						
	Age 4			15				
	Age 5	40		10				
	Age 6			10				
Age 11	Age 2	5						
	Age 3							
	Age 4	20		15				
	Age 5			20				
	Age 6	20		20				
Age 12	Age 2	10						
	Age 3	10						
	Age 4	15						
	Age 5	10		20				
	Age 6	10						
	Age 7			25				

Table 5.4.2c. Annual Dietary Composition of Lake Trout at Sturgeon Bay (1994-1995)

Lake Trout Age	Forage Fish Age	Alewife	Rainbow Smelt	Bloater	Slimy Sculpin	Deepwater Sculpin	Diporeia	Mysis
Age 1	Age 1	85					15	
Age 2	Age 1	80				10	5	5
Age 3	Age 1	45	5					
	Age 2	10	5		10			
	Age 3		5		20			
Age 4	Age 1	30						
	Age 2		20					
	Age 3	10	30					
	Age 4	10						
Age 5	Age 1	30						
	Age 2		15					
	Age 3	15	15					
	Age 4	10	15					
Age 6	Age 1	10	5					
	Age 2							
	Age 3	20	10					
	Age 4							
	Age 5							
	Age 6	30		10				
	Age 7	15						
Age 7	Age 2	30	5					
	Age 3	20	5					
	Age 4	20						
	Age 5	10						
	Age 6							
	Age 7	10						
Age 8	Age 2	10	15					
	Age 3	20						
	Age 4	25						
	Age 5		5					
	Age 6	10		10				
	Age 7	5						
Age 9	Age 3	10	10					
	Age 4	30						
	Age 5		10	10				
	Age 6	20						
	Age 7	10						

Table 5.4.2c. Annual Dietary Composition of Lake Trout at Sturgeon Bay (1994-1995) (Continued)

Lake Trout Age	Forage Fish Age	Alewife	Rainbow Smelt	Bloater	Slimy Sculpin	Deepwater Sculpin	<i>Diporeia</i>	<i>Mysis</i>
Age 10	Age 2		5					
	Age 3	15	5					
	Age 4	20						
	Age 5	25	5	5				
	Age 6							
Age 11	Age 2		5					
	Age 3	15						
	Age 4	20						
	Age 5	35	5					
	Age 6							
Age 12	Age 2	15						
	Age 3	25						
	Age 4	10						
	Age 5	25		25				

Table 5.4.3. Dietary Composition of Alewife in Lake Michigan (1994-1995)

Prey		Saugatuck (0 - < 75 m)	Sturgeon Bay (0 - ~ 100 m)	Sheboygan Reef (50 - 75 m)
Small: Fish Length < 120 mm				
Age 1-2	<i>Diporeia</i>	10	45	40
	<i>Mysis</i>			
	Zooplankton	90	55	60
Large: Fish Length > 120 mm				
Age 3-7	<i>Diporeia</i>	10	75	20
	<i>Mysis</i>			50
	Zooplankton	90	25	30

Table 5.4.4. Dietary Composition of Bloater in Lake Michigan (1994-1995)

Prey		Saugatuck (0 - < 75 m)	Sturgeon Bay (0 - ~ 100 m)	Sheboygan Reef (50 - 75 m)
Small: Fish Length <= 160 mm				
Age 1-3	<i>Diporeia</i>	80	100	35
	<i>Mysis</i>	20		35
	Zooplankton			30
Large: Fish Length (g) > 160 mm				
Age 4-7	<i>Diporeia</i>	75	70	25
	<i>Mysis</i>	25	30	75
	Zooplankton			

Table 5.4.5. Dietary Composition of Rainbow Smelt in Lake Michigan (1994-1995)

Prey		Saugatuck (0 - < 75 m)	Sturgeon Bay (0 - ~ 100 m)	Sheboygan Reef (50 - 75 m)
All Ages	<i>Diporeia</i>		10	
	<i>Mysis</i>	65	90	60
	Zooplankton	35		40

Table 5.4.6. Dietary Composition of Slimy Sculpin in Lake Michigan (1994-1995)

Prey		Saugatuck (0 - < 75 m)	Sturgeon Bay (0 - ~ 100 m)	Sheboygan Reef (50 - 75 m)
All Ages	<i>Diporeia</i>	90	80	90
	<i>Mysis</i>	10	20	10

Table 5.4.7. Dietary Composition of Deepwater Sculpin in Lake Michigan (1994-1995)

	Prey	Saugatuck (0 - < 75 m)	Sturgeon Bay (0 - ~ 100 m)	Sheboygan Reef (50 - 75 m)
All Ages	<i>Diporeia</i>	70	45	80
	<i>Mysis</i>	30	55	20

Table 5.4.8. Dietary Composition of Coho Salmon in Lake Michigan (1994-1995)

Coho Salmon Age	Forage Fish Age	Alewife	Rainbow Smelt	Bloater	<i>Diporeia</i>	<i>Mysis</i>
Age 1	Age 1	40	10	10		
	Age 2	40				
Age 2	Age 1	25				
	Age 2	10				
	Age 3	20	5			
	Age 4	20				
	Age 5	10				
	Age 6					
	Age 7	10				

5.4.2.2 Fish Growth Rates

At a given body weight, W , fish growth rate, G , can be written as:

$$G = (dw/dt)/W \tag{5.4.2}$$

where

(dw/dt) = the derivative of fish weight W with respect to fish age t

With a set of weight-age data of a fish available, the average value for the fish growth rate for a given period of time can then be estimated by the following equation:

$$G = \ln(W_1 / W_0) / (t_1 - t_0) \tag{5.4.3}$$

where

W_1 = fish weight (g) at age t_1 (day)

W_0 = fish weight (g) at age t_0 (day)

G = fish average growth rate during age t_0 to t_1

The weight-age data for fish species in the food webs were obtained from field sampling conducted in 1994-1995 by the Great Lakes National Program Office (GLNPO) for the LMMBP. The methods of fish collection are described in Section 4.2.1. Each fish was weighed to the nearest gram. The lake trout and coho salmon were aged based on either decoding the information on a coded-wire tag (if found) or enumeration of annuli on scales in conjunction with use of fin clip information. More details on the fish aging procedure can be found in Lake Michigan Mass Balance Study Methods Compendium (U.S.

Environmental Protection Agency, 1997a) and Madenjian *et al.* (1998a, 1999). Forage fish were aged based on lengths and weights taken from the literature, and compared to the length and weight data collected for each of the fish species in this study.

A general relationship between age and weight for each fish was established through regression of the large amount of field data. The age-weight relationships for the lake trout in three biota zones, the migratory coho salmon, and their forage fish populations are presented in Tables 5.4.9a through 5.4.9c. Age-weight relationships for forage fish exhibit no regional variation, and a lake-wide average was obtained for each forage species. The results in Tables 5.4.9a, 5.4.9b, and 5.4.9c were used to estimate fish growth rates in the food web models.

The weight-age relationship for *Mysis* was estimated based on information from literature sources (Brafield and Llewellyn, 1962; Pothoven *et al.*, 2000). The results are presented in Table 5.4.9d.

A constant value of 0.10 (1/day) was adapted as the average growth rate for zooplankton in the lake (Connolly *et al.*, 1992).

5.4.2.3 Energy Density of Food Web Components

In a bioenergetics-based food web model, energy balance is the basis for estimating chemical fluxes between fish and its prey species. It is, therefore, important to have a good knowledge of the energy content of the fish and its prey items.

Energy densities, D , of all fish species in this study were estimated based on lipid and protein fractions in individual organisms (Lucas, 1996).

$$D = 35.5 f_L + 20.08 f_{pr} \quad (5.4.4)$$

The terms f_L and f_{pr} are lipid and protein fractions in the fish body, respectively. The energy equivalents of lipid components (kJ/g) is 35.5, and the energy equivalents of protein components (kJ/g) is 20.08. The standard value of energy equivalent for protein is 23.4 kJ/g-protein (Cho *et al.*, 1982). It was adjusted to a lower value of 20.08 kJ/g-protein because after digestion, a portion of energy in the assimilated protein is lost by nitrogenous excretion

and is not available for further respiration. Energy contributions from other body components of a fish, such as carbohydrates, are negligible (Diana, 1995).

Fish lipid content was analyzed by extracting homogenized fish composite with 100 mL of 90/10 (v:v) petroleum ether/ethyl acetate. The extract was then evaporated and the residue was weighed as extractable lipid. Detailed procedures for fish lipid separation and determination are available in the Lake Michigan Mass Balance Study Methods Compendium (U.S. Environmental Protection Agency, 1997b) and Madenjian *et al.* (2000). The values of protein fraction in the lake trout, coho salmon, and the other fish were compiled from or estimated based on various literature sources (Flath and Diana, 1985; Foltz and Norden, 1977; Gardner *et al.*, 1985; Rottiers and Tucker, 1982; Schindler *et al.*, 1971; Vijverberg and Frank, 1976). The lipid and protein fractions used for estimating energy content for all organisms in this study are compiled in Tables 5.4.10a through 5.4.10h.

5.4.2.4 Exposure Conditions

Environmental conditions to which fish are exposed play an important part in determining chemical exchange fluxes between a fish and its environment. Among the model parameters which characterize the environmental conditions for food webs, contaminant levels in water and sediment have direct influence on the contaminant level in exposed fish food webs, and temperature and oxygen content of the exposure environment regulate the chemical kinetics in fish food webs.

Due to the variation in Lake Michigan water characteristics, the exposure condition is different among fish food webs in different biota zones. To facilitate model calculations for fish food webs at Sturgeon Bay, Sheboygan Reef, and Saugatuck, exposure information for each of these three biota zones was required. Exposure data used are summarized here. All data for the LMMBP are available upon request to the GLNPO.

Table 5.4.9a. Average Weight-Age Relationships for Lake Trout in Lake Michigan (1994-1995)

Age	Sheboygan Reef Weight (g)	Saugatuck Weight (g)	Sturgeon Bay Weight (g)
1	20	90	98
2	128	180	120
3	244	550	350
4	490	1100	800
5	900	2050	1500
6	1378	2850	2700
7	1900	3400	3200
8	2600	4000	3700
9	3400	4500	4400
10	4000	5400	5000
11	4400	6500	5500
12	4700	6900	5600
13	4900	7100	5800
14	5200	7100	6000

Table 5.4.9b. Average Weight-Age Relationships for Coho Salmon in Lake Michigan (1994-1995)

Age	Day	Weight (g)
1	90	30
	122	80
	152	140
	183	220
	214	322
	244	450
	274	620
	304	878
	335	880
	366	885
2	30	890
	60	895
	90	900
	121	1400
	151	1850
	183	2190
	214	2450
	244	2670
	274	2860
	304	3050

Table 5.4.9c. Average Weight-Age Relationships of Forage Fish in Lake Michigan (1994-1995)

Age	Alewife Weight (g)	Bloater Weight (g)	Rainbow Smelt Weight (g)	Slimy Sculpin Weight (g)	Deepwater Sculpin Weight (g)
1	3	3.7	5.3	0.6	0.6
2	15	12	8	1.2	1.8
3	27	26	13	2.2	3.5
4	37	38	19	4.6	7
5	45	50	22	8.4	13
6	50	65	25	10	19
7	53	88	28	10.6	24
8	55	110	30		29
9			32		34
10			34		38
11					40

Table 5.4.9d. Estimated Weight-Age Relationships of *Mysis* in Lake Michigan

Month	Weight (g-wet) Sturgeon Bay	Weight (g-wet) Sheboygan Reef	Weight (g-wet) Saugatuck
0	0.00019	0.00001	0.00001
4	0.00194	0.00061	0.00095
8	0.00893	0.00330	0.00537
12	0.01691	0.00910	0.01706
16	0.03336	0.01860	0.04123

Table 5.4.10a. Average Lipid and Protein Fractions (%) of Lake Trout in Lake Michigan (1994-1995)

Age	Sheboygan Reef	Sturgeon Bay	Saugatuck	Protein %
1	2.3	4.8	2.3	17.37
2	3.66	4.68	3.66	
3	7.9	9.21	7.13	
4	9.36	11.81	9.52	
5	12.48	17.04	14.77	
6	15.56	18.3	18.96	
7	18.6	19.13	21.05	
8	19.36	20.52	18.56	
9	19.34	20.15	19.12	
10	19.1	22.63	20.68	
11	20.73	22.5	22	
12	22.4	20.53	23	
13	20.2	20.9	21.7	
14	20.1	21.4	19.7	
15		22.4	30.6	

Table 5.4.10b. Average Lipid and Protein Fractions (%) of Coho Salmon in Lake Michigan (1994-1995)

Age	Day	Lipid %	Protein %
1	90	5.14	20.00
	122	5.25	
	152	5.37	
	183	5.54	
	214	5.75	
	244	6.01	
	274	6.36	
	304	6.90	
	335	6.90	
	366	6.91	
2	30	6.92	
	60	6.93	
	90	6.94	
	121	7.98	
	151	8.91	
	183	9.61	
	214	10.15	
	244	10.61	
	274	11.00	
	304	11.39	

Table 5.4.10c. Average Lipid and Protein Fractions (%) of Alewife in Lake Michigan (1994-1995)

Age	Sheboygan Reef	Saugatuck	Sturgeon Bay	Protein %
1	7.2	5.5	4	16.7
2	8.5	5.5	6	
3	9	6	6	
4	10.5	7.5	6	
5	11.5	9	6	
6	12	10	6	
7	12.2	11	6	
8	12.5	12	6	

Table 5.4.10d. Average Lipid and Protein Fractions (%) of Bloater in Lake Michigan (1994-1995)

Age	Sheboygan Reef	Saugatuck	Sturgeon Bay	Protein %
1	5	4	5	16.3
2	5.5	4.5	7	
3	8	5.5	8.5	
4	11	6.5	9.5	
5	12	7.5	12.5	
6	12.5	8.5	13.5	
7	13	10.5	14.5	
8	13.5	11	15.5	

Table 5.4.10e. Average Lipid and Protein Fractions (%) of Rainbow Smelt in Lake Michigan (1994-1995)

Age	Sheboygan Reef	Saugatuck	Sturgeon Bay	Protein %
1	4.4	3.5	3	16.9
2	4.4	3.5	3	
3	4.4	3.5	3	
4	4.4	3.5	3	
5	4.4	3.5	3	
6	4.4	3.5	3	
7	4.4	3.5	3	
8	4.4	3.5	3	
9	4.4	3.5	3	
10	4.4	3.5	3	

Table 5.4.10f. Average Lipid and Protein Fractions (%) of Slimy Sculpin in Lake Michigan (1994-1995)

Age	Sheboygan Reef	Saugatuck	Sturgeon Bay	Protein %
1	6.4	3.5	8	15.9
2	6.5	4	8.1	
3	6.6	4.5	8.2	
4	6.8	5	8.3	
5	7.1	5.2	8.4	
6	7.2	5.2	8.5	
7	7.3	5.2	8.5	

Table 5.4.10g. Average Lipid and Protein Fractions (%) of Deepwater Sculpin in Lake Michigan (1994-1995)

Age	Sheboygan Reef	Saugatuck	Sturgeon Bay	Protein %
1	8.8	2	7	14.4
2	8.9	3	7.1	
3	9	4	7.2	
4	9.1	5	7.3	
5	9.4	5.5	7.5	
6	9.7	6	7.7	
7	9.9	7	7.8	
8	10.1	7.2	7.9	
9	10.3	7.2	8	
10	10.5	7.5	8.1	
11	10.6	7.5	8.2	

Table 5.4.10h. Average Lipid and Protein Fractions (%) of Zooplankton, *Mysis*, and *Diporeia* in Lake Michigan (1994-1995)

Species	Sheboygan Reef	Saugatuck	Sturgeon Bay	Protein %
Zooplankton	2.91	2.79	1.57	7.1
<i>Mysis</i>	2.31	1.61	2.9	7
<i>Diporeia</i>	3.21	1.66	4.48	10

5.4.2.4.1 PCB Concentrations in Water

Lake Michigan water and particulate samples were collected at several stations within the Sturgeon Bay, Sheboygan Reef, and Saugatuck biota zones. Information regarding the sampling stations, collection procedures, sample preparation, and methods for PCB analysis are available in detail (U.S. Environmental Protection Agency, 1997a, 1997b). The organic carbon fraction in the suspended particles was also analyzed. The analysis procedures can also be found in the above documents.

No temporal variation of PCB concentrations was found for samples collected during 1994 and 1995. PCB concentrations in suspended particles were organic carbon normalized. There was substantial variation of PCB concentrations in suspended

particles among samples collected from different water depths. No substantial vertical variation was found for PCBs in the dissolved form. PCBs in suspended particles were divided into those collected at depth < 20 m and those collected at depth > 20 m. For this study, it was assumed that the fish food webs were exposed to particulate PCB concentrations in the deeper layer. Median values for dissolved PCBs and those associated with suspended particles were used for model calibration. The PCB concentrations in the water column of the three biota zones are given in Table 5.4.11.

5.4.2.4.2 PCB Concentrations in Sediment

Sediment sampling was not specifically conducted within the three biota zones. Sediment PCB concentrations in the three biota zones were

Table 5.4.11. PCB Concentrations in Lake Michigan Water Column (1994-1995)

PCB Congeners	Sturgeon Bay		Sheboygan Reef		Saugatuck	
	Dissolved (ng/L)	Particulate (ng/g-OC)	Dissolved (ng/L)	Particulate (ng/g-OC)	Dissolved (ng/L)	Particulate (ng/g-OC)
3	0	0	0	0	0	0
8+5	0	0	0	0	0	0
12	0.002831	0	0.002265	6.94990	0.003126	0
13	0.001163	0.63374	0.00122	2.09185	0.0009	2.11576
15+17	0.003063	4.02012	0.002608	7.54759	0.004061	11.95844
16	0	1.00157	0	1.56798	0.001473	3.22824
32	0	1.37860	0	1.58024	0	4.22044
18	0.00333	3.57836	0.00377	5.47443	0.004623	10.4442
26	0.000941	0.22132	0.001258	0.37498	0.001582	2.96423
28+31	0.008012	12.42481	0.007067	17.84289	0.009846	55.58153
33	0.004408	2.28478	0.005054	3.43611	0.006045	9.97024
37+42	0.008967	14.5969	0.009517	15.35747	0.008866	16.86476
44	0.003189	5.38999	0.002878	7.30135	0.00581	20.89396
49	0.002259	3.96632	0.002054	6.86181	0.003302	14.05582
52	0.005627	9.48455	0.005518	16.12783	0.008475	35.36909
56+60	0.00134	7.20351	0.001344	13.76338	0.00198	30.47388
66	0.001664	18.39126	0.001893	29.53261	0.002783	63.51781
70+76	0.002179	7.46113	0.0021	16.42939	0.003036	33.74864
74	0.00103	4.18880	0.001039	5.84207	0.001371	14.10166
77+110	0.00291	13.79423	0.002586	28.80211	0.004342	49.83354
81	7.68E-05	1.52913	0	2.09813	0.000147	2.60703
87	0.00227	4.43503	0.002572	8.03297	0.002373	13.37302
92+84	0.005722	15.83466	0.007226	32.15896	0.01356	74.07366
89	0.00068	0.15860	0	0	0	1.59772
85	0.000507	4.76618	0.000569	8.63774	0.000681	13.30061
99	0.006156	25.2633	0.004236	36.02048	0.004228	49.72043
101	0.001328	10.76926	0.00278	17.31631	0.004522	34.31707
118	0.001236	10.49375	0.001156	19.16489	0.001713	35.9058
123+149	0.000705	6.59078	0.000862	13.43283	0.001331	21.52096
132+153+105	0.000724	18.7597	0.000958	31.21532	0.001451	58.52275
151	0	2.11833	0	3.88177	0	6.37438
163+138	0.002134	20.59195	0.002948	37.87159	0.002877	55.57444
146	0.00059	5.19236	0.000583	7.64438	0.000572	9.26933
170+190	4.74E-05	2.54427	7.36E-05	5.30883	0.000131	8.24745
172+197	0	1.03453	0	1.85133	0	2.81659
180	0	1.91204	5.13E-05	5.94020	0	18.31716
187+182	0.002588	4.91753	0.000984	7.07428	0.000683	12.63331
208+195	4.34E-05	0.88921	0	1.91721	0	2.42335
196+203	3.28E-05	1.50532	2.75E-05	3.83510	0	5.10087
201	0.000168	3.05836	7.34E-05	6.59986	0.00018	9.01875

estimated based on samples collected at several nearby stations. These stations were selected for their closeness to a specific biota zone in distance, depth, and sediment characteristics. Because organic carbon normalized sediment PCB data showed limited horizontal variation, the estimate of sediment PCB exposure by using data from nearby stations was appropriate. Information regarding the sampling stations, collection procedures, sample preparation, and methods for PCB analysis are available in detail (U.S. Environmental Protection Agency, 1997a, 1997b). Organic carbon and dry fraction of sediment samples were also analyzed. The analysis procedures can also be found in the above documents.

Sediment data analysis revealed no significant temporal variation in PCB concentrations for samples collected during 1994 and 1995. PCB concentrations in sediment were organic carbon normalized. Median values for PCBs in sediment carbon were used for model calculations. The concentrations of PCBs dissolved in sediment pore water were estimated based on measured PCB data, organic carbon content, dry fraction in the sediment samples, and organic carbon-water partition coefficients for individual PCB congeners. The results of PCB concentrations in the sediment solids and pore water for the three biota zones are given in Table 5.4.12.

5.4.2.4.3 Exposure Temperature

Lake Michigan is a vast water body with a volume of 4,920 km³. It has a surface area of 57,800 km², and its deepest point is 282 m (Coordinating Committee on Great Lakes Basic Hydraulic and Hydrologic Data, 1992). Physical characteristics of the lake vary with region and depth (Environment Canada and U.S. Environmental Protection Agency, 1997). To better reflect this reality, the model was constructed to simulate the exposure environment for each species, rather than as a whole for all species in a food web.

The prevailing annual cycles of exposure temperature for a lake-wide coho salmon population and for three lake trout and their forage populations at Sturgeon Bay, Sheboygan Reef, and Saugatuck were established and are presented in Figures 5.4.2a through 5.4.2c. The results were compiled based on site-specific information, such as annual water temperature profiles (U.S. Environmental Protection

Agency, 1995), species optimal temperature and depth at different life stages (Otto *et al.*, 1976; Peterson *et al.*, 1979; Stewart *et al.*, 1983; Wismer and Christie, 1987; Wells, 1968), prey availability (Crowder and Crawford, 1984; Eck and Wells, 1986; Janssen and Brandt, 1980), spawning season (Janssen and Brandt, 1980), and spawn site preference (Jude *et al.*, 1986; Rice, 1985). For simplicity, the exposure temperatures for different age groups in certain species were aggregated and average annual temperature cycles were determined for the species. The seasonal variation of surface water temperatures (U.S. Environmental Protection Agency, 1995) in the lake is also presented in the first panel of Figures 5.4.2a - 5.4.2b and Figure 5.4.2c for reference.

5.4.2.4.4 Oxygen Concentration in Water

The oxygen concentration in water that organisms vent through their gill membranes was determined by water temperature. In this study, the dissolved oxygen content in water [O₂] was estimated according to an empirical correlation between oxygen solubility (mg/L) and water temperature (Greenberg *et al.*, 1992).

$$\begin{aligned} \ln[O_2] = & -139.34411 + (1.575701 \times 10^5/T) \\ & - (6.642308 \times 10^7/T^2) + (1.2438 \times 10^{10}/T^3) \\ & - (8.621949 \times 10^{11}/T^4) \end{aligned} \quad (5.4.5)$$

where

$$T = \text{temperature } (^{\circ}\text{K})$$

5.4.3 Physiological Data of Fish and Other Organisms

5.4.3.1 Species-Specific Respiration Rates

In the bioenergetics-based food web model (LM Food Chain), fish respiration (or metabolism) rate is a key model parameter which determines the dynamics of chemical uptake from water and food. Fish respiration rate is dependent on fish weight, temperature, and degree of fish activity. For most of the fish species in the Lake Michigan food webs, an extensive study of respiration as a function of weight,

Table 5.4.12. PCB Concentrations in Lake Michigan Surface Sediment (1994-1995)

PCB Congeners	Sturgeon Bay		Sheboygan Reef		Saugatuck	
	Pore Water (ng/L)	Particle (ng/g-OC)	Pore Water (ng/L)	Particle (ng/g-OC)	Pore Water (ng/L)	Particle (ng/g-OC)
3	0	0	0	0	0	0
8+5	0.0279054	10.00643	0.0382893	13.72811	0.0908558	32.58473
12	0.0014341	0.71635	0	0	0	0
13	0.0013447	0.75432	0.0029074	1.63073	0.0061499	3.44944
15+17	0.0096751	5.29398	0.0252991	13.84212	0.0681406	37.28868
16	0.0038924	1.76031	0.0074487	3.36831	0.0171774	7.76701
32	0.0024807	1.41452	0.0026843	1.53063	0.0277008	15.80006
18	0.0071207	3.67665	0.018433	9.51698	0.0504009	26.02673
26	0.0026656	2.76099	0.0035926	3.72098	0.0167924	17.39422
28+31	0.049642	52.27209	0.067541	71.12439	0.2105729	221.7646
33	0.0125176	11.73799	0.0149408	14.00947	0.0549273	51.50962
37+42	0.009989	13.00778	0.019252	25.29948	0.061323	80.17273
44	0.0149115	17.92995	0.023162	27.84947	0.0644197	77.46354
49	0.0078881	11.19489	0.0098061	13,91655	0.0308258	43.75034
52	0.0174969	24.42368	0.0227162	31.70843	0.0629656	87.89781
56+60	0.0183856	40.15014	0.0281371	61.44742	0.0645118	140.8908
66	0.0446862	113.2876	0.05182	131.3768	0.1180745	299.3598
70+76	0.0180978	43.29467	0.0239207	57.22649	0.0613122	146.6866
74	0.0075816	19.2216	0.007947	20.14776	0.0219209	55.5777
77+110	0.0175742	69.76274	0.026113	102.5709	0.0514251	200.6624
81	0.0004445	1.46919	0.0006704	2.21588	0.0018093	5.98041
87	0.0049453	14.55518	0.0062292	18.33357	0.0162384	47.79412
92+84	0.0089757	22.56819	0.0178462	44.87101	0.0322442	81.07549
89	0.000158	0.3229	0.0011103	2.26910	0.0019127	3.90920
85	0.00761	22.77225	0.00995	29.77426	0.0154561	46.2521
99	0.0065556	22.77379	0.007798	27.0894	0.0150233	52.19077
101	0.0116518	39.81201	0.0138112	47.18955	0.029209	99.80335
118	0.0104703	64.97851	0.0130125	80.75468	0.0212667	131.9822
123+149	0.0034083	19.95935	0.0040488	23.71038	0.0083891	49.12844
132+153+105	0.0133833	79.90554	0.0151232	95.42261	0.0230193	145.2468
151	0.0011542	6.06862	0.0012538	6.59256	0.0026042	13.69295
163+138	0.0099996	82.25939	0.0127299	104.7201	0.0209239	172.1294
146	0.0014001	11.14243	0.0015557	12.38059	0.0028539	22.71165
170+190	0.0009791	17.12468	0.0009686	16.94218	0.0016554	28.95361
172+197	0.0002736	4.51562	0.0002758	4.53335	0.0005621	9.23983
180	0.0017814	30.90044	0.0018309	31.75848	0.0030391	52.71641
187+182	0.0010107	13.11631	0.000956	12.40633	0.0016946	21.99273
208+195	0.0001999	5.46997	0.000171	4.67938	0.0002984	8.16719
196+203	0.0006348	17.80964	0.0005772	16.19255	0.0011243	31.54036
201	0.0006772	18.07668	0.0004869	12.99829	0.0012951	34.57076

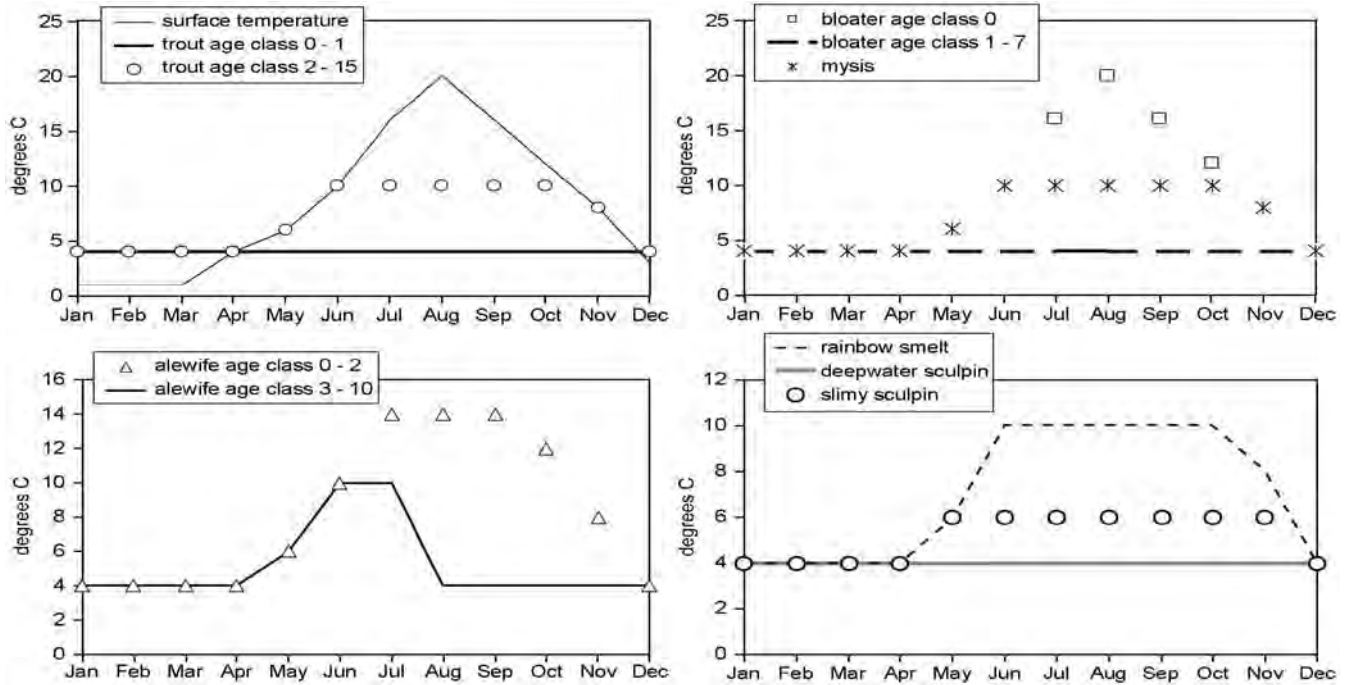

Figure 5.4.2a. Typical annual cycles of exposure temperature for Lake Michigan food webs at Saugatuck and Sturgeon Bay.

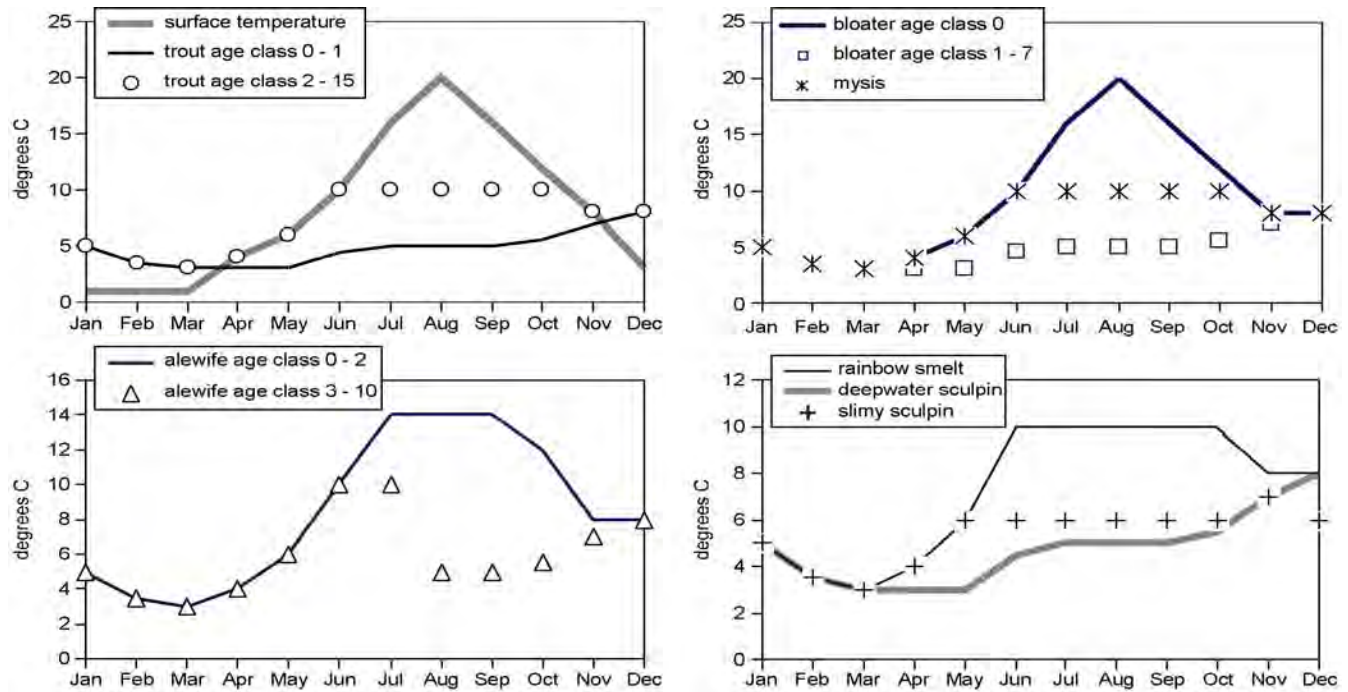

Figure 5.4.2b. Typical annual cycles of exposure temperature for Lake Michigan food web at Sheboygan Reef.

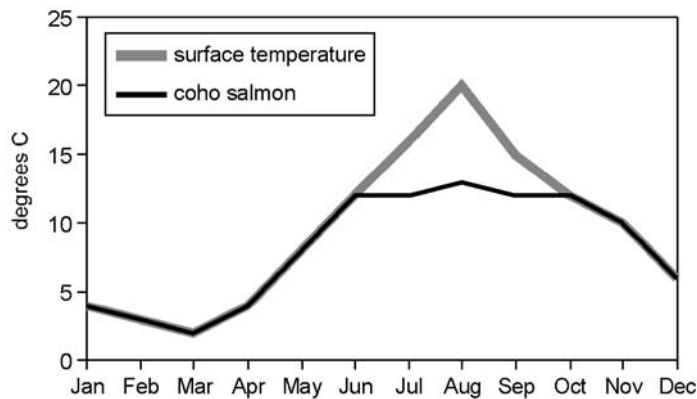

Figure 5.4.2c. Typical annual cycles of exposure temperature for coho salmon in Lake Michigan.

temperature, and swimming speed was conducted, and results were reported (Lantry and Stewart, 1993; Rudstam, 1989; Rudstam *et al.*, 1994; Stewart *et al.*, 1983; Stewart and Binkowski, 1986). In general, a fish's daily respiration rate, in g-O₂/day, can be formulated as:

$$R = \alpha W^\beta \cdot e^{\rho T} \cdot e^{\nu U} \quad (5.4.6)$$

where α , β , ρ , ν are species-specific empirical constants, W is weight, and U is the swimming speed of the fish, in cm/s.

For a given aquatic species, the swimming speed can be expressed as a function of body weight and water temperature:

$$U = \omega W^\delta e^{\phi T} \quad (5.4.7)$$

where ω , δ , ϕ are species-specific empirical constants.

The values of the species-specific empirical constants used to estimate the respiration rate were collected from literature sources (Lantry and Stewart, 1993; Rudstam, 1989; Rudstam *et al.*, 1994; Stewart *et al.*, 1983; Stewart and Binkowski, 1986) and are listed in Table 5.4.13. For slimy and deepwater sculpin, there was insufficient information available to generate species-specific respiration rates. As an alternative, their respiration rates were estimated using the generalized fish respiration equation. The constants used for the calculation of their respiration rates were also given in the table.

In this study, a value of 13.56 kJ/g-O₂ (Elliott and Davison, 1975; Brafield and Llewellyn, 1982; Crisp, 1984) was used as the respiratory energy equivalent, or oxy-calorific coefficient, for converting oxygen respiration to energy utilized by fish.

For zooplankton, a simple equation was used to estimate its respiration, in kJ/gwet/day, as a function of water temperature (Connolly *et al.*, 1992):

$$R = 0.60 e^{\rho T} \quad (5.4.8)$$

5.4.3.2 Respiration Rates Adjusted for Specific Dynamic Action (SDA)

The respiration rate estimated with Equation 5.4.6 represents the average energy requirement for the resting metabolism of a fish. It has been reported that there is an increase in respiration rate for a recently fed fish (Kayser, 1963). The additional respiration activity is often referred to as Specific Dynamic Action (SDA). The origin of the extra respiration is believed to be due to the energy necessary for the digestion of ingested foods, the absorption of nutrients, the deamination of amino acids, and the synthesis of the products of nitrogenous excretion. In homeothermic animals, it has been shown that SDA represents 30% of the caloric content of the ingested protein, 13% for a lipid, and 5% for a carbohydrate (Lucas, 1996). Due to the difficulty in experimentally discriminating SDA from additional respiration associated with excitement and activity with feeding, different SDA

Table 5.4.13. Bioenergetic Parameters of Lake Michigan Fishes

Parameter	<i>Mysis</i>	Slimy Sculpin	Deepwater Sculpin	Alewife	Rainbow Smelt	Bloater	Lake Trout	Coho Salmon
α (gO ₂ /gwet/day)	0.00182	0.043*	0.043*	0.00367	0.0027	0.0018	0.00463	0.00264
β	-0.161	-0.3	-0.3	-0.2152	-0.216	-0.12	-0.295	-0.217
ρ	0.0752	0.03	0.03	0.0548	0.036	0.047	0.059	0.06818
ω	0	1.19	1.19	5.78	0	7.23	11.7	9.7
δ	0	0.32	0.32	-0.045	0	0.25	0.05	0.13
ϕ	0	0.045	0.045	0.149	0	0	0.0405	0.0405
v	0	0.0176	0.0176	0.03	0	0.025	0.0232	0.0234

*With a unit of gwet/gwet/day.

values were cited in the literature that ranged from 9% to 20% of the energy contained in the diet (Jobling, 1981).

In this study, the SDA is modeled as a portion of a fish's dietary ingestion. The respiration rate adjusted for SDA can then be written as:

$$R_{SDA} = R \cdot Q_{ox} + SDA (R_{SDA} + G \cdot D_f) \quad (5.4.9)$$

where

R_{SDA} = SDA adjusted respiration rate, g-O₂/day

R = resting respiration rate calculated with empirical equations, g-O₂/day

Q_{ox} = respiratory energy equivalent or oxycalorific coefficient, kJ/g-O₂

SDA = fraction of assimilated energy spent on specific dynamic action

G = fish growth rate, 1/day

D_f = energy density of the fish

The final respiration rate, in kJ/day, was then estimated as:

$$R_{SDA} = (R \cdot Q_{ox} + SDA \cdot G \cdot D_f) / (1 - SDA) \quad (5.4.10)$$

5.4.4 Calibrated Model Parameters

There are several constants and variables in the model's equation whose values are either not readily available or inconclusive. Their values were determined through model calibration to site-specific conditions. The calibrated parameters include food assimilation efficiency (β) for each species or age group, the chemical assimilation efficiency (α) for each species or age group for each PCB congener, the chemical relative gill transfer coefficient (E_c/E_o) for each species (or age group) for each PCB congener, and the fraction of ingested energy for SDA for each species or age group.

An acceptable value range for each of the calibrated model parameters and its general trend for PCB congeners or species in different trophic levels was established based on information from the literature and experience gained in previous modeling work. Depending upon species and its diet, food assimilation efficiency has a value ranging from 0.05 to 0.85 (Brocksen *et al.*, 1968; Brocksen and Brugge, 1974; Elliott, 1976; Averett, 1969). The value for the

chemical assimilation efficiency can vary from 0.2 to 0.8 and is reported to be correlated with the K_{ow} value for the chemical (Gobas, 1988). The chemical relative gill transfer coefficient (E_c/E_o) ranges from 0.1 to 1.0 and is also believed to be related to K_{ow} for the chemical (McKim *et al.*, 1985). Energy fraction for SDA has a value ranging from 0.00 to 0.20. These data were used to guide our model calibrations for appropriate parameterization.

References

- Averett, R.C. 1969. Influence of Temperature on Energy and Material Utilization by Juvenile Coho Salmon. Ph.D. Thesis, Oregon State University, Corvallis, Oregon. 74 pp.
- Beeton, A.M. and J.A. Bowers. 1982. Vertical Migration of *Mysis relicta* Loven. *Hydrobiologia*, 93(1-2):53-61.
- Brafield, A.E. and M.J. Llewellyn. 1982. Animal Energetics. Blackie and Son, Ltd., Glasgow, Scotland. 168 pp.
- Brocksen, R.W., G.E. Davis, and C.E. Warren. 1968. Competition, Food Consumption, and Production of Sculpins and Trout in Laboratory Stream Communities. *J. Wildl. Mgmt.*, 32(1):51-75.
- Brocksen, R.W. and J.P. Brugge. 1974. Preliminary Investigation on the Influence of Temperature on Food Assimilation by Rainbow Trout, *Salmo gairdneri* Richardson. *J. Fish. Biol.*, 6(1):93-97.
- Brown, E.H., Jr., G.W. Eck, N.R. Foster, R.M. Horrall, C.E. Coberly. 1981. Historical Evidence for Discrete Stocks of Lake Trout (*Salvelinus namaycush*) in Lake Michigan. *Canadian J. Fish. Aquat. Sci.*, 38(12):1747-1758.
- Cho, C.Y., S.J. Slinger, and H.S. Bayley. 1982. Bioenergetics of Salmonids Fishes: Energy Intake, Expenditure and Productivity. *Comp. Biochem. Physiol.*, 73B(1):25-41.
- Coordinating Committee on Great Lakes Basin Hydraulic and Hydrologic Data. May 1992. Coordinated Great Lakes Physical Data. U.S. Army Corps of Engineers, Detroit, Michigan.
- Crisp, D.J. 1984. Energy Flow Measurements in Methods for the Study of Marine Benthos. In: N.A. Holm and A.D. McIntyre (Eds.), *Methods for the Study of Marine Benthos*, IPB Handbook 16, pp. 197-279. Blackwell Scientific Publications, Boston, Massachusetts.
- Crowder, L.B. and H.L. Crawford. 1984. Ecological Shifts in Resource Use by Bloater in Lake Michigan. *Trans. Amer. Fish Soc.*, 113(6):694-700.
- Diana, J.S. 1995. *Biology and Ecology of Fishes*. Biological Sciences Press, Carmel, Indiana. 441 pp.
- Eadie, B.J., N.R. Morehead, and P.F. Landrum. 1990. Three-Phase Partitioning of Hydrophobic Organic Compounds in Great Lakes Waters. *Chemosphere*, 20(1/2):161-178.
- Eck, G.W. and L. Wells. 1986. Depth Distribution, Diet, and Overwinter Growth of Lake Trout (*Salvelinus namaycush*) in Southeastern Lake Michigan Sampled in December 1981 and March 1982. *J. Great Lakes Res.*, 12(4):263-269.
- Eisenreich, S.J., P.D. Capel, J.A. Robbins, and R. Bourbonniere. 1989. Accumulation and Diagenesis of Chlorinated Hydrocarbons in Lacustrine Sediments. *Environ. Sci. Technol.*, 23(9):1116-1126.
- Elliott, J.M. and W. Davison. 1975. Energy Equivalents of Oxygen Consumption in Animal Energetics. *Oecologia*, 19(3):195-201.
- Elliott, J.M. 1976. The Energetics of Feeding, Metabolism and Growth of Brown Trout (*Salmo trutta* L.) in Relation to Body Weight, Water Temperature, and Ration Size. *J. Anim. Ecol.*, 45(3):923-948.
- Elliott, R.F., P.J. Peeters, M.P. Ebener, R.W. Rybicki, P.J. Schneeberger, R.J. Hess, J.T. Francis, G.W. Eck, and C.P. Madenjian. 1996. *Conducting Diet Studies of Lake Michigan Piscivores - A Protocol*. U.S. Fish and Wildlife Service, Green Bay, Wisconsin. Report Number 96-2, 38 pp.

-
- Elliott, R.F. and M.E. Holey. 1998. A Description of the Diet of Lake Michigan Coho Salmon and Collections for Contaminants Analysis as Part of the 1994-95 Lake Michigan Mass Balance Project. U.S. Fish and Wildlife Service, Green Bay, Wisconsin. Report Number 98-3.
- Environment Canada and U.S. Environmental Protection Agency. 1997. State of the Great Lakes - The Year of the Nearshore. U.S. Environmental Protection Agency, Great Lakes National Program Office, Chicago, Illinois. 76 pp.
- Evans, M.S., M.A. Quigley, and J.A. Wojcik. 1990. Comparative Ecology of *Pontoporeia hoyi* Populations in Southern Lake Michigan: The Profundal Region Versus the Slope and Shelf Regions. *J. Great Lakes Res.*, 16(1):27-40.
- Flath, L.E. and J.S. Diana. 1985. Seasonal Energy Dynamics of the Alewife in Southeastern Lake Michigan. *Trans. Amer. Fish Soc.*, 114(3):328-337.
- Foltz, J.W. and C.R. Norden. 1977. Seasonal Changes in Food Consumption and Energy Content of Smelt (*Osmerus mordax*) in Lake Michigan. *Trans. Amer. Fish Soc.*, 106(3):230-234.
- Gardner, W.S., T.F. Nalepa, W.A. Frez, E.A. Cichocki, and P.F. Landrum. 1985. Seasonal Patterns in Lipid Content of Lake Michigan Macroinvertebrates. *Canadian J. Fish. Aquat. Sci.*, 42(11):1827-1832.
- Gardner, W.S., M.A. Quigley, G.L. Fahnenstiel, D. Scavia, and W.A. Frez. 1990. *Pontoporeia hoyi* - A Direct Trophic Link Between Spring Diatoms and Fish in Lake Michigan. In: M.M. Tilzer and C. Serruya (Eds.), *Large Lakes: Ecological Structure and Function*, pp. 632-644. Springer-Verlag, New York, New York.
- Gobas, F.A.P.C., D.C.G. Muir, and D. Mackay. 1988. Dynamics of Dietary Bioaccumulation and Faecal Elimination of Hydrophobic Organic Chemicals in Fish. *Chemosphere*, 17(5):943-962.
- Greenberg, A.E., L.S. Clesceri, and A.D. Eaton (Eds.). 1992. *Standard Methods for the Examination of Water and Wastewater*, 18th Edition. American Public Health Association, Washington, D.C. 982 pp.
- Grossnickle, N.E. 1982. Feeding Habitats of *Mysis relicta* - An Overview. *Hydrobiologia*, 93(1-2):101-107.
- Hawker, D.W. and D.W. Connell. 1988. Octanol-Water Partition Coefficients of Polychlorinated Biphenyl Congeners. *Environ. Sci. Technol.*, 22(4):382-387.
- Hesselberg, R.J., J.P. Hickey, D.A. Northrup, and W.A. Willford. 1990. Contaminant Residues in the Bloater (*Coregonus hoyi*) of Lake Michigan, 1969-1986. *J. Great Lakes Res.*, 16(1):121-129.
- Janssen, J. and S.B. Brandt. 1980. Feeding Ecology and Vertical Migration of Alewives (*Alosa pseudoharengus*) in Lake Michigan. *Canadian J. Fish. Aquat. Sci.*, 37(2):177-184.
- Jobling, M. 1981. The Influence of Feeding on the Metabolic Rate of Fishes: A Short Review. *J. Fish. Biol.*, 18(4):385-400.
- Johnson, R.K. 1987. The Life History, Production and Food Habits of *Pontoporeia affinis* Lindstrom (Crustacea:Amphipoda) in Mesotrophic Lake Erken. *Hydrobiologia*, 144(3):277-283.
- Jude, D.J., D. Bimber, N. Thurber, F. Tesar, L. Noguchi, P. Mansfield, H. Tin, and P. Rago. 1986. Impact of the Donald C. Cook Nuclear Plant on Fish. In: R. Rossmann (Ed.), *Impact of the Donald C. Cook Nuclear Plant*, pp. 285-351. The University of Michigan, Ann Arbor, Michigan. Great Lakes Research Division Publication 22.
- Kayser, C. 1963. Bioenergetique. In: C. Kayser et al. (Eds.), *Physiologie*, pp. 51-121. Editions Medicales, Flammarion, Paris, France.
- Lantry B.F. and D.J. Stewart. 1993. Ecological Energetics of Rainbow Smelt in the Laurentian Great Lakes: An Interlake Comparison. *Trans. Amer. Fish. Soc.*, 122(5):951-976.

-
- Lucas, A. 1996. Bioenergetics of Aquatic Animals. Taylor and Francis Publishers, London, England. 169 pp.
- Lydy, M.J. and P.F. Landrum. 1993. Assimilation Efficiency for Sediment Sorbed Benzo(a)pyrene by *Diporeia* spp. *Aquat. Toxicol.*, 26(3-4):209-223.
- Madenjian, C.P., T.J. DeSorcie, and R.M. Stedman. 1998a. Ontogenic and Spatial Patterns in Diet and Growth of Lake Trout in Lake Michigan. *Trans. Amer. Fish. Soc.*, 127(2):236-252.
- Madenjian, C.P., R.J. Hesselberg, T.J. DeSorcie, L.J. Schmidt, R.M. Stedman, R.T. Quintal, L.J. Begnoche, and D.R. Passino-Reader. 1998b. Estimate of Net Trophic Transfer Efficiency of PCBs to Lake Michigan Lake Trout From Their Prey. *Environ. Sci. Technol.*, 32(7):886-891.
- Madenjian, C.P., T.J. DeSorcie, R.M. Stedman, E.H. Brown, Jr., G.W. Eck, L.J. Schmidt, R.J. Hesselberg, S.M. Chernyak, and D.R. Passino-Reader. 1999. Spatial Patterns in PCB Concentrations of Lake Michigan Lake Trout. *J. Great Lakes Res.*, 25(1):149-159.
- Madenjian, C.P., R.F. Elliott, T.J. DeSorcie, R.M. Stedman, D.V. O'Connor, and D.V. Rottiers. 2000. Lipid Concentrations in Lake Michigan Fishes: Seasonal, Spatial, Ontogenetic, and Long-Term Trends. *J. Great Lakes Res.*, 26(4):427-444.
- Marzolf, G.R. 1965. Substrate Relations of the Burrowing Amphipod *Pontoporeia affinis* in Lake Michigan. *Ecology*, 46(5):579-592.
- McKim, J., P. Schmeider, and G. Veith. 1985. Absorption Dynamics of Organic Chemical Transport Across Trout Gills as Related to Octanol-Water Partition Coefficient. *Toxicol. Appl. Pharmacol.*, 77(1):1-10.
- Mullin, M.D., C.M. Pochini, S. McGrindle, M. Romkes, S.H. Safe, and L.M. Safe. 1984. High-Resolution PCB Analysis Synthesis and Chromatographic Properties of All 209 PCB Congeners. *Environ. Sci. Technol.*, 18(6):468-476.
- Neidermeyer, W.J. and J.J. Hickey. 1976. Chronology of Organochlorine Compounds in Lake Michigan Fish, 1929-1966. *Pest. Monit. J.*, 10(3):92-95.
- Norstrom, R.J., A.E. McKinnon, and A.S.W. deFreitas. 1976. Bioenergetics-Based Model for Pollutant Accumulation by Fish. Simulation of PCB and Methylmercury Residue Levels in Ottawa River Yellow Perch (*Perca flavescens*). *J. Fish. Res. Board Canada*, 33(2):248-267.
- Oliver, B.G., M.N. Charlton, and R.W. Durham. 1989. Distribution, Redistribution, and Geochronology of Polychlorinated Biphenyl Congeners and Other Chlorinated Hydrocarbons in Lake Ontario Sediments. *Environ. Sci. Technol.*, 23(2):200-208.
- Patriarche, M.H. 1980. Movement and Harvest of Coho Salmon in Lake Michigan, 1978-1979. Michigan Department of Natural Resources, Lansing, Michigan. Fisheries Research Report 1889.
- Peters, R.H. and J.A. Downing. 1984. Empirical Analysis of Zooplankton Filtering and Feeding Rates. *Limnol. Oceanogr.*, 29(4):763-784.
- Peterson, R.H., A.M. Sutterlin, and J.L. Metcalfe. 1979. Temperature Preference of Several Species of *Salmo* and *Salvelinus* and Some of Their Hybrids. *J. Fish. Res. Board Canada*, 36(9):1137-1140.
- Pothoven, S.A., G.L. Fahnenstiel, H.A. Vanderploeg, and M. Luttenton. 2000. Population Dynamics of *Mysis relicta* in Southeastern Lake Michigan, 1995-1998. *J. Great Lakes Res.*, 26(4):357-365.
- Quigley, M.A. 1988. Gut Fullness of the Deposit-Feeder Amphipod, *Pontoporeia hoyi*, in Southeastern Lake Michigan. *J. Great Lakes Res.*, 14(2):178-187.
- Quigley, M.A. and H.A. Vanderploeg. 1991. Ingestion of Live Filamentous Diatoms by the Great Lakes Amphipod, *Diporeia* sp.: A Case Study of the Limited Value of Gut Contents Analysis. *Hydrobiologia*, 223(1):141-148.

-
- Rice, J.A. 1985. Mechanisms that Regulate Survival of Larval Bloater *Coregonus hoyi* in Lake Michigan. Ph.D. Dissertation, University of Wisconsin, Madison, Wisconsin.
- Rottiers, D.V. and R.M. Tucker. 1982. Proximate Composition and Caloric Content of Eight Lake Michigan Fishes. U.S. Department of the Interior, U.S. Fish and Wildlife Service, Washington, D.C. Technical Paper 108, 8 pp.
- Rudstam, L.G. 1989. A Bioenergetic Model for *Mysis* Growth and Consumption Applied to a Baltic Population of *Mysis mixta*. J. Plankton Res., 11(5):971-983.
- Rudstam, L.G., F.P. Binkowski, and M.A. Miller. 1994. A Bioenergetic Model for Analysis of Food Consumption Patterns by Bloater in Lake Michigan. Trans. Amer. Fish. Soc., 123(3):344-357.
- Schindler, D.W., A.S. Clark, and J.R. Gray. 1971. Seasonal Caloric Values of Freshwater Zooplankton, as Determined with a Philipson Bomb Calorimeter Modified for Small Samples. J. Fish. Res. Board Canada, 28(4):559-564.
- Stewart, D.J., D. Weininger, D.V. Rottiers, and T.A. Edsall. 1983. An Energetics Model for Lake Trout, *Salvelinus namaycush*: Application to the Lake Michigan Population. Canadian J. Fish. Aquat. Sci., 40(6):681-698.
- Stewart, D.J. and F.P. Binkowski. 1986. Dynamics of Consumption and Food Conversion by Lake Michigan Alewives: An Energetics-Modeling Synthesis. Trans. Amer. Fish. Soc., 115(5):643-661.
- U.S. Environmental Protection Agency. 1995. Lake Michigan Mass Balance Project Database. U.S. Environmental Protection Agency, Great Lakes National Program Office, Chicago, Illinois.
- U.S. Environmental Protection Agency. 1997a. Lake Michigan Mass Balance Study (LMMB) Methods Compendium, Volume 1: Sample Collection Techniques. U.S. Environmental Protection Agency, Great Lakes National Program Office, Chicago, Illinois. EPA/905/R-97/012a, 1,440 pp.
- U.S. Environmental Protection Agency. 1997b. Lake Michigan Mass Balance Study (LMMB) Methods Compendium, Volume 2: Organic and Mercury Sample Analysis Techniques. U.S. Environmental Protection Agency, Great Lakes National Program Office, Chicago, Illinois. EPA905/R-97012b, 532 pp.
- Vijverberg, J. and T.H. Frank. 1976. The Chemical Composition and Energy Contents of Copepods and Cladocerans in Relation to Their Size. Freshwater Biol., 6(4):333-345.
- Wells, L. 1968. Seasonal Depth Distribution of Fish in Southeastern Lake Michigan. Fish. Bull., 67(1):1-15.
- Wisner, D.A. and A.E. Christie. 1987. Temperature Relationships of Great Lakes Fishes: A Data Compilation. Great Lakes Fishery Commission, Ann Arbor, Michigan. Special Publication 87-3, 165 pp.

PART 5

LM FOOD CHAIN

Chapter 5. Calibration

5.5.1 Introduction

Calibration is a step of model development necessary for accurate parameterization and simulation. Before a food web bioaccumulation model is used to predict future contamination levels in fish or to address other related environmental issues, it needs to be calibrated to refine certain species- and chemical-specific parameters to site-specific conditions. The extensive collection in 1994 and 1995 of data on congener-specific polychlorinated biphenyl (PCB) concentrations in fish food webs and in water and sediment of Lake Michigan provided an excellent data set for model calibration.

5.5.2 Description of Process

The food web model was calibrated with site-specific conditions for lake trout in three biota zones and for a lake-wide coho salmon population. The calibrations were conducted for 40 PCB congeners or co-eluters individually. For each lake trout food web, the 1994-1995 measured data of PCBs in water and sediment, and temperature profiles in the associated biota zone, were used as model inputs. They were assumed to be representative of life-long average exposure condition. This assumption is appropriate because there are no congener-specific PCB exposure concentrations available prior to 1994, the decline in PCB concentrations in the lake has slowed down in recent years, and post-exposure input has a limited impact on the model output for a recent date. The dynamic food web model was run continuously

until a steady-state was reached for model outputs. The obtained model outputs were considered to be the model estimates of PCB concentrations in the fish food web in response to the exposure inputs. The model predicted concentrations of individual PCB congeners were then compared to the observed PCB concentrations in the biota zone for species in each trophic level of the food web. During the calibration process, selected parameters (i.e., food assimilation efficiency (β), chemical assimilation efficiency (α), chemical relative gill transfer coefficient (E_c/E_o), and specific dynamic action (SDA)) were adjusted to improve agreement between model results and measured PCB data for the food web. The adjustments of the calibrated parameters were constrained within the limits defined by the accepted range of the parameters. Starting at the bottom of the food web, parameter adjustment and refinement was conducted for each species to identify the optimal combination of the parameters which yielded the best agreement between model results and field data for all PCB congeners. This process was repeated for all trophic levels in the food web.

The resulting calibrated parameters were then examined for all species across trophic levels to ensure that the parameter values among trophic levels and among chemical hydrophobicities were internally consistent and that their trends over trophic levels and hydrophobicities were in agreement with those reported in the literature. If necessary, the calibration process was repeated by altering the optimal combination of parameters until the calibrated parameters agreed with generally accepted trends.

Similar calibrations were done for PCBs in the Lake Michigan coho salmon. Given the available information, it was not possible to construct a dynamic food web structure to reflect variable diets of the migratory coho salmon in the lake. The coho salmon model was calibrated with three fixed food web structures. They were constructed by combining an average dietary composition of coho salmon with one of the forage food web structures from the three lake trout biota zones.

The model calibration described in this chapter was based on observed PCB data at a single point in time (1994-1995). This model calibration focused on individual PCB congeners (rather than total PCBs alone) in all age classes of the top predator as well as their entire supporting forage base. The use of constant exposure history, as represented by the 1994-1995 field data for PCBs in water and sediment, in this model calibration was an appropriate approximation. Our model test indicated that, within a certain range, the variation in past exposure concentrations had only minor impacts on the model output for current contaminant levels in fish. The uncertainty in the model calibration associated with the constant exposure history was well below the uncertainty from other sources, such as variability in food web structures and PCB field data.

5.5.3 Calibration Results

The parameter values that generated the best agreement between modeled and measured PCB data were considered to be the best estimates of the calibrated parameter set for modeling PCBs in each food web. The calibrated results for the *Diporeia* submodel are listed in Table 5.5.1. Other calibrated parameter values for each lake trout food web are given in Tables 5.5.2 and 5.5.3. A range of values was given in the tables for the chemical assimilation efficiencies of fish and *Mysis*. They were treated as functions of hydrophobicity of individual PCB congeners. The correlation of the chemical assimilation efficiency α to the hydrophobicity (or K_{ow}) of a PCB congener was adopted from the work of Gobas *et al.* (1988):

$$\begin{aligned} \text{For } \log K_{ow} < 6: & \alpha = 0.5 \\ \text{For } \log K_{ow} > 6: & \frac{1}{\alpha} = 5.3 (\pm 1.5) \cdot 10^{-8} \cdot K_{ow} \\ & + 2.3 (\pm 0.3) \end{aligned} \quad (5.5.1)$$

This relationship was selected because it offered the best overall calibration results for congeners with different hydrophobicity.

There are considerable variations in the reported values of chemical assimilation efficiency at a given $\log K_{ow}$ value (Buckman *et al.*, 2004; Gobas *et al.*, 1988; Muir and Yarechewski, 1988; Niimi and Oliver, 1983; Stapleton *et al.*, 2004; Thomann *et al.*, 1992). There are also indications that chemical assimilation efficiency may be a function of species (Gobas *et al.*, 1988; Muir and Yarechewski, 1988). However, adequate information was not available to support derivation of a species-specific assimilation efficiency. For simplicity, they were assumed to be independent of the species. The chemical assimilation efficiency used in this study are at the low end of the literature reported values (Buckman *et al.*, 2004; Gobas *et al.*, 1988; Stapleton *et al.*, 2004). We believe that the lower values may better represent chemical assimilation in the real environment. This is because chemical assimilation efficiencies were mostly estimated based on laboratory studies using manufactured fish foods spiked with contaminants. The contaminants coated on the foods are likely to be more susceptible to digestion and thus more available for absorption by fish than contaminants accumulated naturally by prey species in the lake. Therefore, the actual chemical assimilation efficiencies for species in the real environment may be lower than what were reported.

Table 5.5.4 gives the calibrated parameters values for coho salmon which yielded the best overall agreement between modeled and observed data for all three supporting forage food webs.

The calibrated value for a particular model parameter is apparently related to other parameter values. For example, the estimated value of the food assimilation efficiency, β , is largely influenced by our selection of the chemical assimilation efficiency, α . If higher than those expressed by Equation 5.5.1, the calibrated values of the food assimilation efficiency listed in

Table 5.5.1. Calibrated Parameter Values for *Diporeia* Submodel

Parameter	Calibrated Value
Water ventilation rate across the respiratory surface, G_w (L/day)	6.0E-03
Food ingestion rate, G_d (g-dry/day)	1.8E-04
Fraction of food absorbed, β	5%
Organic carbon assimilation efficiency, α	46%
Chemical assimilation efficiency from diet, E_d	0.72
Chemical assimilation efficiency from water, E_w	0.60

Table 5.5.2. Calibrated Model Parameters for PCBs in the Sturgeon Bay and Saugatuck Lake Trout Food Webs

	Chemical Assimilation Efficiency (α)	Food Assimilation Efficiency (β)	Chemical Relative Gill Transfer Coefficient (E_c/E_o)	Energy Fraction for Specific Dynamic Action (SDA)
Zooplankton	0.15	0.60	0.7	
<i>Mysis</i>	0.50-0.22	0.80	1.0	0.18
Deepwater Sculpin	0.50-0.22	0.60	0.7	0.15
Slimy Sculpin	0.50-0.22	0.65	0.5	0.15
Bloater (Age 1-3)	0.50-0.22	0.25	0.4	0.18
Bloater (Age 4-7)	0.50-0.22	0.40	0.4	0.18
Alewife (Age 1-2)	0.50-0.22	0.90	0.7	0.00
Alewife (Age 3-7)	0.50-0.22	0.40	0.5	0.18
Rainbow Smelt	0.50-0.22	0.60	0.4	0.00
Lake Trout (Age 1-4)	0.50-0.22	0.40	0.6	0.15
Lake Trout (Age 5-12)	0.50-0.22	0.20	0.6	0.18

Table 5.5.3. Calibrated Model Parameters for PCBs in the Sheboygan Reef Lake Trout Food Web

	Chemical Assimilation Efficiency (α)	Food Assimilation Efficiency (β)	Chemical Relative Gill Transfer Coefficient (E_c/E_o)	Energy Fraction for Specific Dynamic Action (SDA)
Zooplankton	0.15	0.35	1.0	
<i>Mysis</i>	0.50-0.22	0.90	1.0	0.15
Deepwater Sculpin	0.50-0.22	0.45	0.8	0.18
Slimy Sculpin	0.50-0.22	0.50	0.7	0.15
Bloater (Age 1-3)	0.50-0.22	0.20	0.3	0.18
Bloater (Age 4-7)	0.50-0.22	0.35	0.4	0.18
Alewife (Age 1-2)	0.50-0.22	0.90	0.7	0.00
Alewife (Age 3-7)	0.50-0.22	0.40	0.5	0.15
Rainbow Smelt	0.50-0.22	0.55	0.3	0.00
Lake Trout (Age 1-4)	0.50-0.22	0.45	0.7	0.18
Lake Trout (Age 5-12)	0.50-0.22	0.25	0.8	0.18

Table 5.5.4. Calibrated Model Parameters for PCBs in Lake Michigan Coho Salmon

	Chemical Assimilation Efficiency (α)	Food Assimilation Efficiency (β)	Chemical Relative Gill Transfer Coefficient (E_g/E_o)	Energy Fraction for Specific Dynamic Action (SDA)
Coho Salmon (Age 1)	0.3	0.8	1	0.18
Coho Salmon (Age 2)	0.6	0.6	0.5	0.18

Tables 5.5.2 and 5.5.3 would have to be adjusted upward. Therefore, the value of a parameter in the tables can not be viewed or used independent of those of other parameters.

Model parameterization is also influenced by the quality of the available field data. For model calibrations conducted with limited field data that include only a few chemicals and an incomplete food web (species or age classes), model parameterization can be biased toward certain species or chemical properties with which it was calibrated. With the help of the extensive data collection, which covers a large number of chemicals with a wide range of hydrophobicities and a more complete account of species and age classes of a food web, the calibration results in Tables 5.5.1-5.5.4 is believed to be less biased and more applicable to a wide range of chemical contaminants and food webs in the lake.

5.5.4 Field Data for PCBs in Fish and Their Comparisons to Calibrated Model Outputs

Except coho salmon, Lake Michigan fish samples were collected in three biota zones in 1994 and 1995. Phytoplankton and zooplankton were collected for the same time periods in the biota zones. Plankton samples were collected by pumping and separating into phytoplankton and zooplankton (< 102 μm and > 102 μm , respectively). Coho salmon samples were collected from various locations in 1994 and 1995. Information regarding the sampling stations, collection procedures, sample preparation, and methods for PCB analysis are available in detail (U.S. Environmental Protection Agency, 1997a,b). For lake trout, samples were further classified into age classes. The method for age classification is

available from Lake Michigan Mass Balance Study Methods Compendium (U.S. Environmental Protection Agency, 1997a) and Madenjian *et al.* (1998a,b, 1999).

For lake trout and its forage species, PCB data exhibited no temporal variation over the two-year period of 1994-1995. Median values for congener-based PCB concentrations in each age class or size class of a species were calculated for each biota zone. For coho salmon, PCB data showed considerable temporal variation due to their rapid growth. Whole lake median values for the concentrations of individual PCB congeners in coho salmon for different seasons (size class) were estimated. The resultant values of the observed PCB concentrations in Lake Michigan fish, *Diporeia*, *Mysis*, and zooplankton in 1994-1995 are presented in Appendix 5.5.1. This comprehensive PCB data set made the Lake Michigan food web model calibration probably the most complete and systematic in terms of the completeness of the food web structure and the range of hydrophobicities of chemical contaminants, among reported model studies for chemical bioaccumulation in a food web.

The agreement between simulated model outputs and observed field data is an important measure of the quality of the simulated food web model. Appendix 5.5.2 illustrates overall comparison between calibrated model results and observed concentrations of individual PCB congeners for all species in the three lake trout food webs. To facilitate the comparison, the measured PCB data for zooplankton, *Mysis*, and *Diporeia* were converted to wet-weight basis. A dry fraction of 15% was assumed for zooplankton and *Mysis*, and 20% for *Diporeia* in the lake. Each data point in the plots denotes the model result for an individual PCB

congener and the corresponding field measurement. For forage fish and *Mysis*, observed PCB data were reported for composite samples of several age classes. The maximum and minimum age classes included in the composite samples were identified. An average value of the model results for the encompassed age classes was used to represent the model estimate for the PCB concentration in the composite sample and was compared with the observed composite data. For example, bloater (> 160 mm) at Sturgeon Bay represents a composite sample of bloater with age classes ranging from four to seven years old. Therefore, in Appendix 5.5.1, each measured PCB congener concentration for bloater (> 160 mm) was plotted against an average value of modeled concentration for age four through age seven bloaters. The solid line in each of the figures in Appendix 5.5.2 indicates the position of the “perfect match” between the model simulation and the observed data.

Among lake trout food webs in the three biota zones, calibration results for Sturgeon Bay and Saugatuck agree with the observed data reasonably well for most species from zooplankton to the top predator, as demonstrated by the strong positive correlations between modeled and measured PCB congener concentrations. The results indicate that the quality of model simulations increases with the trophic level of modeled species. This observation is consistent with the fact that the field measurements for PCBs in highly contaminated fish species are usually less variable and better defined than the field PCB data for less contaminated forage fish and invertebrates in lower trophic levels. The apparent model biases for overestimating or underestimating PCBs in zooplankton, *Mysis*, and *Diporeia* may be attributed to possible errors in the presumed values for water content in these invertebrates used for converting dry-weight based PCB data to wet-weight based values.

Overall the model yielded a satisfactory result for congener-specific PCBs in the top predator – lake trout. For forage species which is not specifically targeted in most previous model studies, the model results could be improved by adjusting the chemical assimilation efficiency individually for each species. However, we decided to limit the parameter adjustment to minimize the risk of turning the calibration into a mere curve-fitting exercise.

Considering the large variability in the measured congener-specific PCB data for water, sediment, and organisms which were used either as exposure input or for the comparison to the model output of the calibration and considering the constraints imposed on congener-specific model parameters, the agreement between the calibrated and measured congener-specific PCB data shown in Appendix 5.5.2 are remarkable.

The calibrated parameter values which result in good fits for fish PCB data at Saugatuck and Sturgeon Bay did not yield good model results for Sheboygan Reef fishes in comparison with the observed data. In order to improve the agreement between model results and the observed fish PCB data for the Sheboygan Reef biota zone, a different set of calibrated parameter values was required. The parameter values calibrated specifically for Sheboygan Reef are given in Table 5.5.3. After the additional parameter refinement, satisfactory agreement was obtained between the simulated and observed PCB concentrations for the food web at Sheboygan Reef (Appendix 5.5.2).

For the lake-wide coho salmon, there were three calibrated model results associated with different forage food web inputs. With a common set of calibrated model parameters (Table 5.5.4), each of the calibrated model results agreed reasonably with the observed data for coho salmon. As an example, calibrated results associated with the Saugatuck forage food web are compared in Figure 5.5.1 with the observed PCB data for coho salmon at different life stages. The figure shows that except for the second year coho salmon in spring (April-May), the calibrated model results agree reasonably well with the observed PCB data for coho salmon over the season. The discrepancies for the second year coho salmon in spring probably result from a mis-characterization of the coho salmon growth curve (Table 5.4.9b). Due to large variability in fish weight at a given age and a gap in weight data collection, the estimated weight-age relationship may not properly reflect the fish growth curve in the early days of two year-old fish. The resulting growth rate may be smaller than what was actually the case. A small growth rate indicates a slow dilution process for chemicals in fish, which results in a build-up of chemicals in the fish and, consequently, a model overestimate of chemicals in fish (see Figure 5.7.5).

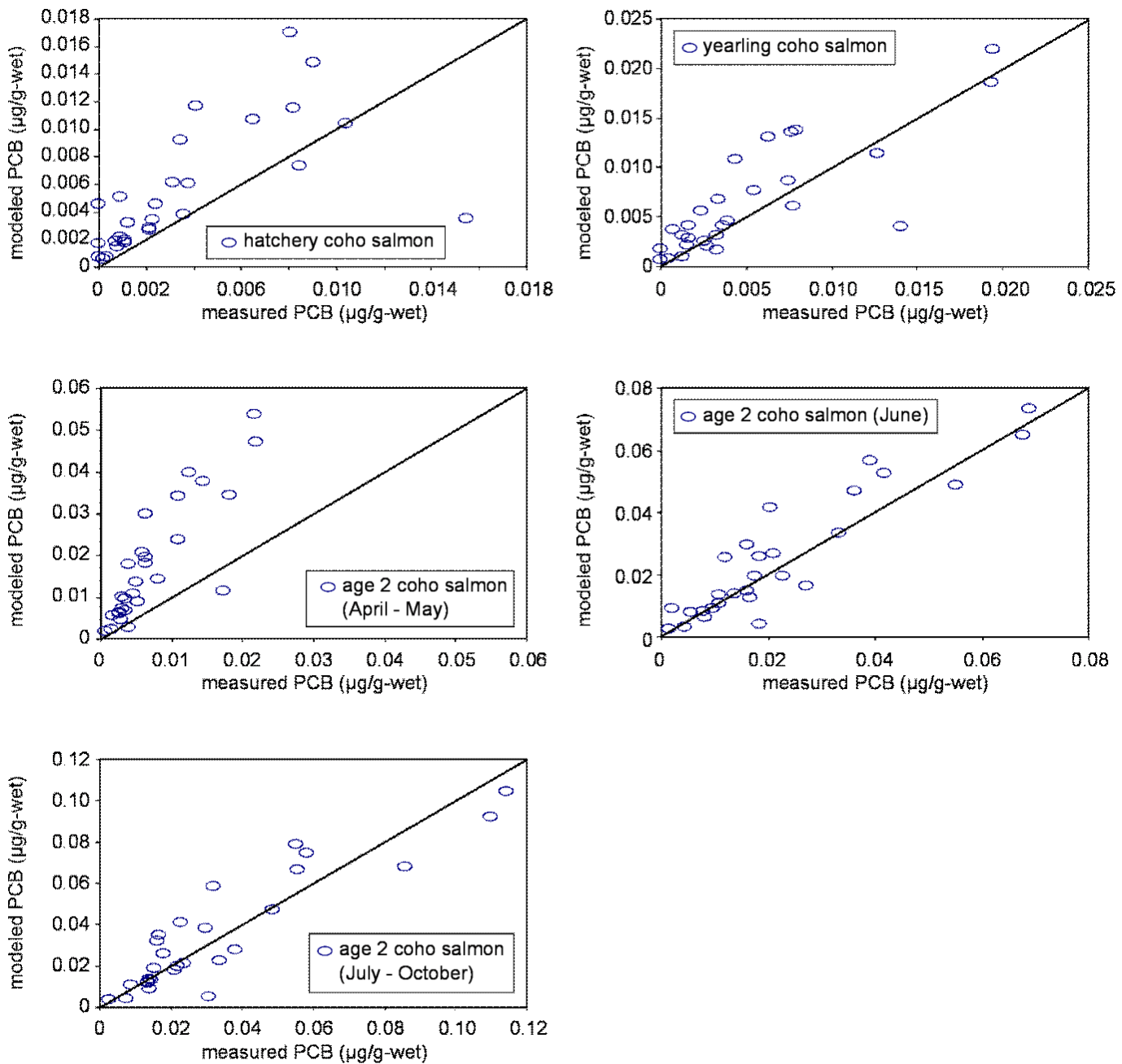

Figure 5.5.1. Agreement between modeled and observed fish PCB concentrations in coho salmon using Saugatuck food web (1994 and 1995).

Further refinement of the weight-age relationship for the fish may help reduce the discrepancies between modeled and observed spring PCB data for two year-old coho salmon.

Appendix 5.5.2 shows that the calibrated models overestimated the concentrations of most PCB congeners in young lake trout, specifically one and two year-old lake trout at Sturgeon Bay and one and three year-old lake trout at Saugatuck. It is possible to improve the agreement for these young age classes if model parameters were allowed to be adjusted independently for individual age classes. However, in this study, model parameters were defined to be species-specific or assigned to age groups (young or adult) of a species. Therefore, they were not individually refined for each age class. Rather, they were optimized systematically for all age classes or combined age classes of a species. The restriction of excessive parameter calibrations is important to reduce the risk of the calibration process being a mere curve-fitting exercise. The discrepancy between the modeled and the observed PCB data for the young lake trout does not necessarily indicate the model's limitation. In fact, this discrepancy may be attributed to the difference in the environmental condition between model simulated and the real one occupied by the young lake trout. Lake trout is a stocked species in Lake Michigan (Holey *et al.*, 1995). Before it was exposed to the lake environment and associated food webs, it was reared in hatchery facilities around the lake (Peck, 1979; Rybicki, 1990) and was exposed to a controlled environment and food. It is likely that the manufactured fish foods used in the hatchery facilities were less PCB-contaminated than the natural food items used in the food web models. Therefore, the stocked young lake trout should have lower PCB concentrations than that estimated by the food web model. An incorporation of the exposure environment in hatchery facilities into the current model framework may improve the calibrations for the young lake trout. Until then, higher predicted PCB levels in the young lake trout are expected.

A similar argument can be made for the calibration results of young coho salmon, another stocked species. Figure 5.5.1 shows that, with exception of few PCB congener data, the model results for young coho salmon were generally higher than the observed ones for most PCB congeners.

In order to evaluate the agreement between modeled and observed data in relation to the hydrophobicity of individual PCB congeners, an individual comparison was made for each PCB congener. As an example, the PCB congener data for all age classes of the lake trout at Saugatuck are illustrated in Figure 5.5.2. The results indicate that the calibrated model performed equally well for PCB congeners over a range of different hydrophobicities ($\log K_{ow}$ ranges from 5.6 to 7.71). For all PCB congeners, the modeled and observed data agreed well, taking into consideration of the uncertainty associated with the measured PCB data for individual congeners.

No comparison could be made of the current calibration to other modeling studies in terms of model performance. No similar modeling attempt has been reported to reproduce congener-specific PCB data for an entire aquatic food web. Most previous calibrations were focused on total PCBs only and were usually performed for adult predators without consideration of model results for forage species. While current calibrations yielded good agreements between the simulated and observed congener-specific PCB concentrations, it is interesting to see how well the calibrated models perform in terms of the total PCB concentrations. Modeled total PCB data in this study were estimated by summing model results for individual PCB congeners and scaling the sum based on the ratio of total PCBs to the sum of the targeted congeners from the 1994-1995 observed data. For Saugatuck lake trout, the ratio was 1.369. Figure 5.5.3 illustrates the comparison between modeled and observed total PCB data for all age classes of lake trout at Saugatuck. The result indicates that the calibrated food web model reproduces total PCB concentrations in the lake trout and its bioaccumulation trend for the age classes reasonably well.

References

- Buckman, A.H., S.B. Brown, P.F. Hoekstra, K.R. Solomon, and A.T. Fish. 2004. Toxicokinetics of Three Polychlorinated Biphenyl Technical Mixtures in Rainbow Trout (*Onchorynchus mykiss*). *Environ. Technol. Chem.*, 23(7):1725-1736.

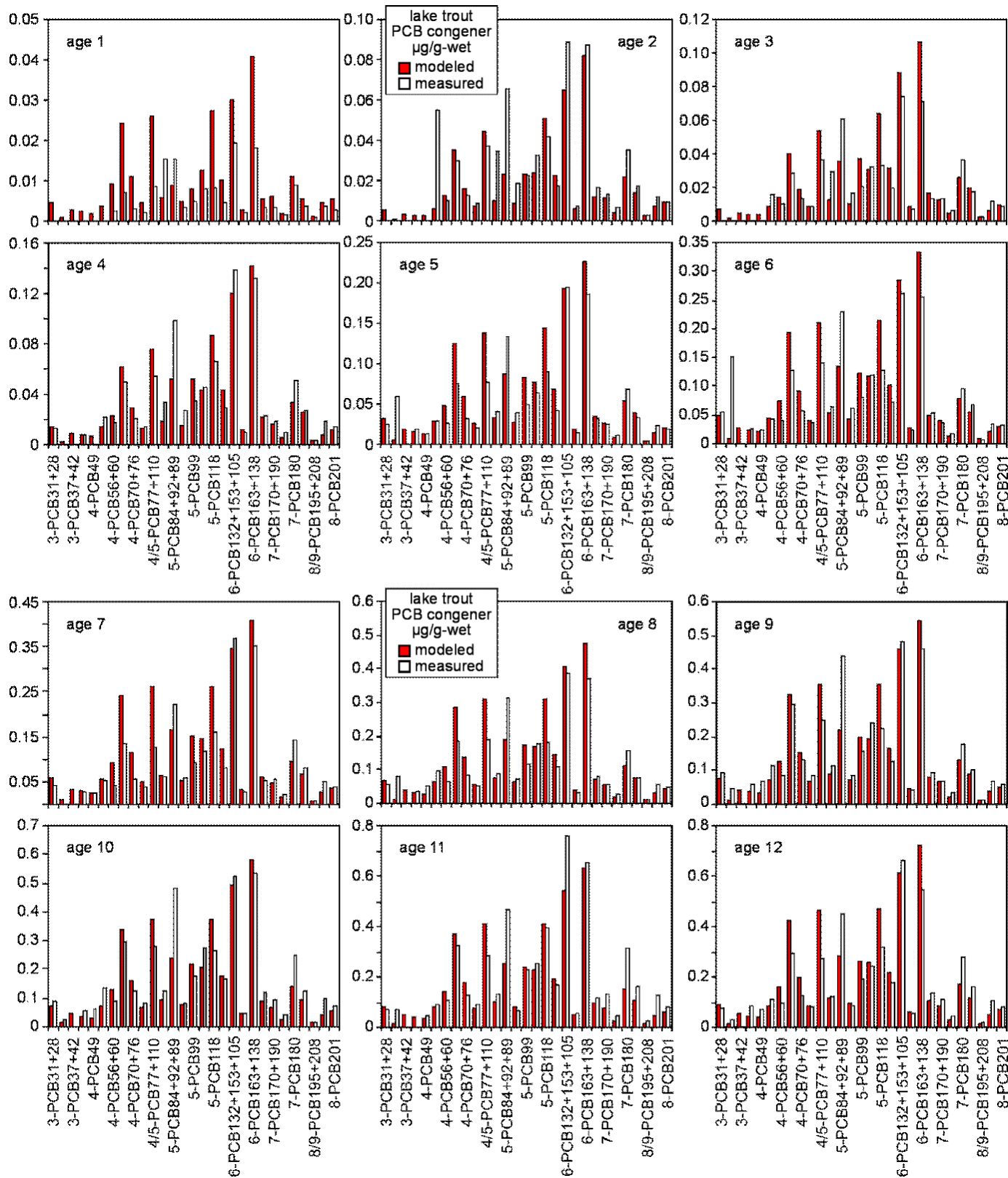

Figure 5.5.2. Individual comparison between modeled and observed data for PCB congeners in lake trout at Saugutt (1994 and 1995).

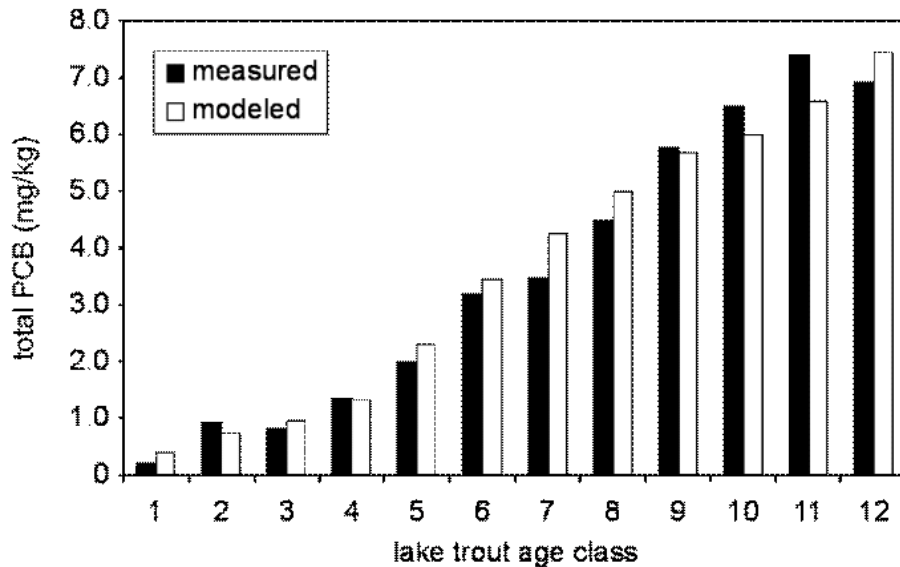

Figure 5.5.3. Comparison between modeled and observed total PCBs for lake trout at Saugatuck (1994 and 1995).

Gobas, F.A.P.C., D.C.G. Muir, and D. Mackay. 1988. Dynamics of Dietary Bioaccumulation and Faecal Elimination of Hydrophobic Organic Chemicals in Fish. *Chemosphere*, 17(5):943-962.

Holey, M.E., R.W. Rybicki, G.W. Eck, E.H. Brown, Jr., J.E. Marsden, D.S. Lavis, M.L. Toneys, T.N. Trudeau, and R.M. Horrall. 1995. Progress Toward Lake Trout Restoration in Lake Michigan. *J. Great Lakes Res.*, 21(Suppl. 1):128-151.

Madenjian, C.P., T.J. DeSorcie, and R.M. Stedman. 1998a. Ontogenic and Spatial Patterns in Diet and Growth of Lake Trout in Lake Michigan. *Trans. Amer. Fish. Soc.*, 127(2):236-252.

Madenjian, C.P., R.J. Hesselberg, T.J. DeSorcie, L.J. Schmidt, R.M. Stedman, R.T. Quintal, L.J. Begnoche, and D.R. Passino-Reader. 1998b. Estimate of Net Trophic Transfer Efficiency of PCBs to Lake Michigan Lake Trout From Their Prey. *Environ. Sci. Technol.*, 32(7):886-891.

Madenjian, C.P., T.J. DeSorcie, R.M. Stedman, E.H. Brown, Jr., G.W. Eck, L.J. Schmidt, R.J. Hesselberg, S.M. Chernyak, and D.R. Passino-Reader. 1999. Spatial Patterns in PCB Concentrations of Lake Michigan Lake Trout. *J. Great Lakes Res.*, 25(1):149-159.

Muir, D.C.G. and A.L. Yarechewski. 1988. Dietary Accumulation of Four Chlorinated Dioxin Congeners by Rainbow Trout and Fathead Minnows. *Environ. Toxicol. Chem.*, 7(3):227-236.

Niimi, A.J. and B.G. Oliver. 1983. Biological Half-Lives of Polychlorinated Biphenyl (PCB) Congeners in Whole fish and Muscle of Rainbow Trout (*Salmo gairdneri*). *Canadian J. Fish. Aquat. Sci.*, 40(9):1388-1394.

Peck, J.W. 1979. Utilization of Traditional Spawning Reefs by Hatchery Lake Trout in the Upper Great Lakes. Michigan Department of Natural Resources, Lansing, Michigan. Fisheries Research Report Number 1871, 33 pp.

-
- Rybicki, R.W. 1990. Growth, Survival, and Straying of Three Lake Trout Strains Stocked in the Refuge of Northern Lake Michigan. Michigan Department of Natural Resources, Charlevoix, Michigan. Fisheries Research Report Number 1977.
- Stapleton, H.M., R.J. Letcher, J. Li, and J.E. Baker. 2004. Dietary Accumulation and Metabolism of Polybrominated Diphenyl Ethers by Juvenile Carp (*Cyprinus carpio*). Environ. Toxicol. Chem., 23(8):1929-1946.
- Thomann, R.V., J.P. Connolly, and T. Parkerton. 1992. An Equilibrium Model of Organic Chemical Accumulation in Aquatic Food Webs With Sediment Interaction. Environ. Toxicol. Chem., 11(5):615-629.
- U.S. Environmental Protection Agency. 1997a. Lake Michigan Mass Balance Study (LMMB) Methods Compendium, Volume 1: Sample Collection Techniques. U.S. Environmental Protection Agency, Great Lakes National Program Office, Chicago, Illinois. EPA/905/R-97/012a, 1,440 pp.
- U.S. Environmental Protection Agency. 1997b. Lake Michigan Mass Balance Study (LMMB) Methods Compendium, Volume 2: Organic and Mercury Sample Analysis Techniques. U.S. Environmental Protection Agency, Great Lakes National Program Office, Chicago, Illinois. EPA/905/R-97/012b, 532 pp.

PART 5
LM FOOD CHAIN

Appendix 5.5.1. PCB Concentrations

PCB Concentrations (pg/gdry) in Lake Michigan Zooplankton (1994 and 1995)

Congener	Sturgeon Bay	Sheboygan Reef	Saugatuck
003	942.42	4596.10	2524.99
8+5	0.00	0.00	0.00
012	0.00	0.00	20.63
013	0.00	36.50	37.72
15+17	346.18	505.07	1701.43
16+32	611.41	14.10	533.16
018	428.48	879.95	1532.19
026	1162.99	3091.17	3287.49
018	0.00	202.80	275.03
031	780.54	1008.82	2932.27
033	155.28	144.44	557.12
037	627.83	1055.40	729.66
042	177.23	196.84	344.48
044	1551.78	2167.43	3387.58
049	1361.32	1865.86	3048.96
052	3184.89	6015.69	9735.53
56+60	140.42	393.11	430.87
066	2494.88	4837.90	5282.59
70+76	1819.84	2449.22	4070.87
074	485.56	891.89	2982.48
77+110	4734.04	7091.83	8637.94
081	526.94	640.49	929.34
084	138.86	209.04	569.02
085	1196.67	1693.86	1576.04
087	1172.30	1530.19	2107.52
089	0.00	114.54	1.98
092	1717.47	4379.51	4713.77
099	2236.80	4110.96	5052.15
101	3555.53	7212.97	9913.42
105+132	945.97	575.56	1200.71
118	1848.85	4981.37	5604.17
123+149	2055.80	4760.39	6475.89
163+138	5421.44	10186.65	13291.16
146	604.57	2325.00	1961.19
151	705.24	1630.44	2229.45
153	4141.67	10988.05	9058.01
170+190	1370.12	2069.29	2704.17
172	0.00	89.13	0.00
180	2233.74	7918.56	6411.65
187+182	1355.95	3872.70	3372.63
208+195	271.63	768.08	476.79
196	561.42	1627.29	1231.23
197	0.00	0.00	6.23
201	859.29	2013.64	2227.83
203	755.51	2126.44	1421.58
Total PCBs (ng/gdry)	79.76	164.96	186.57

PCB Concentrations (pg/gdry) in Lake Michigan *Mysis* (1994 and 1995)

Congener	Sturgeon Bay	Sheboygan Reef	Saugatuck
003	295.99	1442.10	2776.39
8+5	0.00	0.00	0.00
012	0.00	0.00	0.00
013	0.00	0.00	7.83
15+17	864.95	764.41	727.53
16+32	247.21	365.10	676.49
018	317.42	335.53	387.07
026	2999.53	2396.32	3763.90
018	2556.78	1844.79	3874.53
031	2962.47	2460.94	3804.77
033	572.50	437.38	768.72
037	642.45	390.94	538.32
042	900.57	498.41	1219.20
044	2114.48	1423.97	2141.67
049	1396.40	1001.56	1385.91
052	2338.15	1432.18	2443.17
56+60	3878.33	3459.49	5055.25
066	17962.44	12566.99	15158.91
70+76	7397.18	5921.41	8394.57
074	5483.80	3204.08	4788.27
77+110	16483.66	15121.06	18968.39
081	1978.49	1797.28	1554.18
084	431.90	462.87	568.36
085	5453.35	4998.50	6336.71
087	2871.70	2445.71	3263.37
089	690.72	1253.79	1422.84
092	5534.60	4544.90	6474.88
099	8409.94	7174.27	9223.89
101	10566.23	8639.79	10362.89
105+132	3981.38	3512.08	5012.26
118	12965.63	12239.49	13760.94
123+149	6600.91	5732.46	7126.46
163+138	23085.36	19870.08	25270.07
146	6185.89	4776.05	6196.97
151	1450.94	1198.93	1543.19
153	18171.41	15615.26	18526.82
170+190	3114.04	2729.24	4091.89
172	1653.80	961.35	1845.96
180	9439.54	7593.51	10890.27
187+182	6134.45	5843.48	7583.53
208+195	598.11	577.48	950.25
196	1273.98	1164.65	2111.79
197	143.04	104.25	168.82
201	2629.61	2469.69	3660.18
203	1686.18	153	2578.83
Total PCBs (ng/gdry)	268.55	231.50	304.20

PCB Concentrations (pg/gdry) in Lake Michigan *Diporeia* (1994 and 1995)

Congener	Sturgeon Bay	Sheboygan Reef	Saugatuck
003	3906.66	5658.22	3962.63
8+5	0.00	0.00	0.00
012	189.56	0.00	62.00
013	43.98	22.03	0.00
15+17	1770.95	2020.00	1768.21
16+32	1307.43	1339.92	718.87
018	1409.46	1624.00	1782.47
026	7416.87	10941.37	10387.19
018	3395.46	3496.20	1071.94
031	4529.39	4809.64	4855.98
033	375.32	1191.56	1175.22
037	1809.82	1732.81	2324.90
042	1294.33	1711.93	1912.89
044	4256.19	4520.00	5510.35
049	3808.59	4495.64	5355.30
052	10389.60	12587.27	14273.38
56+60	5368.74	4930.76	1209.98
066	16343.52	18348.06	16440.11
70+76	7109.30	7900.30	9109.38
074	5273.06	4219.65	4824.45
77+110	22583.42	27073.80	23745.34
081	2503.48	2486.35	2144.60
084	3197.15	3343.36	3077.91
085	6488.84	7345.93	5647.89
087	4386.27	4808.38	4888.14
089	1377.35	2314.04	884.02
092	7507.20	7997.86	8354.76
099	9411.39	11629.65	10301.72
101	16886.93	20088.19	19176.48
105+132	5656.26	8086.64	2835.04
118	15147.07	15025.20	13256.51
123+149	8145.97	10093.62	11363.05
163+138	23232.90	31096.81	29498.80
146	5766.45	7260.52	6785.31
151	3775.24	4523.58	4541.13
153	18210.67	23022.24	20568.66
170+190	4153.52	7085.55	7736.04
172	2213.68	3342.80	3414.31
180	12962.69	16248.07	18870.57
187+182	6036.73	8097.15	8591.93
208+195	1713.80	2549.43	2502.72
196	2536.71	3680.19	4064.65
197	261.67	363.58	305.39
201	5337.86	7118.87	7602.03
203	3508.22	4486.55	5058.51
Total PCBs (ng/gdry)	334.12	438.93	458.97

PCB Concentrations (pg/gwet) in Sturgeon Bay Forage Fish (1994 and 1995)

Congener	Alewife (< 120 mm)	Alewife (> 120 mm)	Bloater (< 160 mm)	Bloater (> 160 mm)	Deepwater Sculpin	Slimy Sculpin	Rainbow Smelt
28+31	0.000	11.309	4.610	11.290	3.865	3.750	3.897
33	10.430	19.914	0.000	0.000	0.000	0.000	0.000
44	0.000	4.674	6.327	5.516	0.000	0.000	0.000
49	0.000	5.844	0.000	0.000	0.000	0.000	0.000
52	0.000	10.254	6.392	7.248	3.587	1.504	1.681
56+60	2.030	11.293	9.505	12.013	5.964	6.902	5.929
66	5.229	29.891	26.145	31.444	17.164	20.223	14.597
70+76	2.540	12.458	11.314	14.319	2.057	4.867	6.381
74	1.466	8.869	6.745	8.675	4.268	5.411	3.869
77	0.371	1.595	1.283	1.772	0.273	0.589	0.561
81+87	14.853	22.095	18.612	20.619	12.972	21.998	20.743
89+84+92	10.112	37.137	44.757	54.165	10.183	30.950	23.046
85	2.747	10.889	10.867	14.158	10.934	11.030	7.338
99	3.210	14.144	15.814	20.217	12.301	13.387	8.558
101	6.199	20.015	22.667	26.797	1.791	13.398	9.145
105	3.156	14.297	14.575	18.511	14.156	12.552	9.082
110	7.973	26.990	28.566	38.224	1.879	14.950	13.985
118	5.786	25.380	25.432	33.211	25.661	22.083	15.399
123	0.056	0.176	0.198	0.308	0.164	0.109	0.117
132+153	8.933	29.602	37.441	46.953	44.284	35.290	25.625
163+138	8.511	38.504	47.722	52.778	39.733	38.979	32.502
146	2.377	7.384	9.073	10.518	0.965	6.368	6.106
149	4.952	13.634	11.978	15.353	1.088	3.506	7.258
151	1.313	3.212	3.860	4.453	0.870	2.932	1.490
170+190	2.491	5.596	7.643	8.045	7.527	6.423	2.648
172	0.809	2.401	3.447	3.597	0.702	2.710	1.392
180	4.646	13.806	19.987	21.033	20.044	13.790	8.513
187+182	2.716	8.151	11.201	11.706	0.696	5.999	6.541
195	0.240	0.666	1.021	1.221	1.075	0.988	0.374
203+196	1.752	4.951	7.438	7.788	6.710	5.650	2.532
197	0.084	0.223	0.319	0.327	0.341	0.260	0.159
201	1.959	5.169	6.677	6.638	1.674	4.050	2.389
208	0.142	0.296	0.531	0.545	0.417	0.406	0.181
Total PCBs	172.116	560.804	575.407	733.247	314.139	417.064	315.647

PCB Concentrations (ng/gwet) in Sheboygan Reef Forage Fish (1994 and 1995)

Congener	Alewife (< 120 mm)	Alewife (> 120 mm)	Bloater (< 160 mm)	Bloater (> 160 mm)	Deepwater Sculpin	Slimy Sculpin	Rainbow Smelt
28+31	3.256	5.826	5.176	9.765	0.000	0.000	0.000
33	0.000	17.442	0.000	0.000	0.000	0.000	0.000
44	0.000	4.725	0.000	0.000	0.000	0.000	0.000
49	3.794	0.000	0.000	0.000	0.000	0.000	0.000
52	7.518	7.477	5.680	4.368	0.000	1.013	0.000
56+60	4.101	10.283	8.582	13.409	9.164	5.943	5.223
66	11.592	30.267	22.764	35.035	25.382	17.985	13.927
70+76	5.386	12.757	11.334	17.053	2.514	4.395	5.845
74	2.222	8.767	5.688	8.894	5.477	3.853	3.333
77	0.258	1.014	1.369	1.980	0.309	0.448	0.543
81+87	22.356	25.641	32.846	31.378	22.663	26.423	22.723
89+84+92	18.842	39.098	54.979	62.057	15.595	32.187	24.521
85	3.998	10.782	14.992	19.016	14.039	10.972	6.759
99	5.708	14.739	19.385	26.322	18.989	16.932	9.077
101	10.598	22.411	29.371	24.681	2.941	14.064	9.083
105	6.140	14.964	19.847	26.596	25.039	15.741	9.552
110	13.830	28.398	35.807	42.061	2.737	13.300	15.578
118	8.954	23.092	35.099	45.496	44.167	28.068	16.827
123	0.114	0.251	0.308	0.284	0.460	0.187	0.224
132+153	12.590	30.020	53.335	62.731	65.938	39.911	22.113
163+138	18.392	40.612	73.856	84.649	68.900	52.639	30.566
146	3.655	8.056	15.614	17.237	0.805	8.398	6.086
149	6.245	13.816	16.067	17.228	1.661	3.357	7.115
151	1.525	3.123	5.699	4.268	1.223	2.748	1.337
170+190	3.283	6.858	13.007	10.441	14.640	9.105	3.100
172	1.074	2.643	5.204	4.516	0.836	3.151	1.438
180	5.879	14.764	29.506	27.837	32.047	19.841	8.622
187+182	3.330	8.193	14.603	18.631	0.630	6.081	6.368
195	0.310	0.756	1.623	1.249	1.909	1.225	0.346
203+196	2.326	5.615	11.622	9.774	11.016	7.622	2.720
197	0.089	0.226	0.462	0.508	0.490	0.285	0.137
201	2.373	5.539	10.145	8.146	2.093	4.599	2.521
208	0.131	0.317	0.708	0.602	0.661	0.501	0.163
Total PCBs	220.814	546.978	748.376	831.049	501.386	419.502	300.601

PCB Concentrations (ng/gwet) in Saugatuck Forage Fish (1994 and 1995)

Congener	Alewife (< 120 mm)	Alewife (> 120 mm)	Bloater (< 160 mm)	Bloater (> 160 mm)	Deepwater Sculpin	Slimy Sculpin	Rainbow Smelt
28+31	8.369	9.774	3.847	8.098	0.000	0.000	4.240
33	12.556	23.427	0.000	0.000	0.000	0.000	0.000
44	0.000	0.000	0.000	0.000	0.000	0.000	0.000
49	0.000	12.753	0.000	0.000	0.000	0.000	0.000
52	5.064	10.687	16.495	11.790	0.000	8.412	1.777
56+60	4.031	9.631	6.094	11.164	4.857	3.654	4.761
66	11.127	25.752	16.980	30.477	13.539	10.335	11.979
70+76	5.283	11.572	9.069	18.093	1.205	3.387	5.760
74	2.762	7.322	4.327	9.070	3.879	2.999	3.151
77	0.843	1.493	1.033	1.633	0.198	0.343	0.593
81+87	21.428	24.871	22.140	28.286	17.683	21.236	18.614
89+84+92	19.299	35.866	43.896	63.825	5.713	24.274	19.974
85	4.345	9.506	9.436	12.142	8.920	5.737	5.141
99	6.106	13.533	14.445	23.084	12.242	8.725	7.006
101	11.825	21.757	23.211	28.569	1.106	9.976	7.163
105	4.641	13.427	13.123	18.116	14.779	8.350	7.826
110	13.259	26.335	24.681	36.576	1.076	8.987	11.775
118	9.053	23.145	24.234	31.442	26.089	13.556	14.153
123	0.060	0.169	0.201	0.255	0.132	0.110	0.084
132+153	12.061	30.510	37.195	51.392	42.229	24.553	18.611
163+138	16.115	40.579	49.265	67.268	40.831	30.389	24.013
146	3.638	7.868	10.892	13.072	0.321	5.365	4.155
149	7.161	15.348	13.537	18.804	1.044	2.983	6.525
151	1.928	3.534	4.619	5.717	0.593	2.913	1.213
170+190	2.478	5.940	9.344	11.285	13.140	6.654	2.594
172	1.005	2.545	3.632	4.637	0.365	2.518	1.072
180	5.795	16.046	22.774	31.759	33.473	17.227	9.206
187+182	3.209	10.416	12.581	16.100	0.293	4.641	5.999
195	0.269	0.713	1.255	1.514	2.331	1.102	0.307
203+196	2.153	5.531	9.494	10.981	12.955	6.902	2.541
197	0.098	0.229	0.387	0.507	0.482	0.229	0.122
201	2.328	5.925	8.416	9.230	1.224	4.152	2.252
208	0.130	0.279	0.635	0.612	0.498	0.400	0.141
Total PCBs	287.310	573.372	615.045	873.001	365.842	376.329	291.917

PCB Concentrations (ng/gwet) in Sturgeon Bay Lake Trout (1994 and 1995)

Congener	Age 1	Age 2	Age 3	Age 4	Age 5	Age 6	Age 7
28+31	0.000	0.000	10.680	17.650	22.534	41.786	46.792
33	0.000	0.000	0.000	0.000	0.000	32.120	42.462
44	18.226	0.000	0.000	2.880	5.227	18.855	24.149
49	13.725	0.000	5.046	14.347	13.267	20.095	39.700
52	2.865	0.000	13.777	22.469	0.000	27.100	42.695
56+60	4.367	5.724	13.488	17.320	25.674	40.163	39.780
66	14.793	17.145	41.804	50.468	72.777	110.836	118.203
70+76	4.675	5.936	13.636	22.306	29.391	45.679	47.853
74	4.097	4.797	10.716	17.430	20.678	30.696	34.171
77	0.266	0.000	1.371	2.445	2.605	5.245	4.702
81+87	29.668	31.048	24.925	36.077	54.880	49.721	70.747
89+84+92	18.243	27.508	60.967	82.217	126.234	160.033	168.053
85	7.875	8.563	19.108	24.593	34.299	50.831	51.816
99	10.914	11.486	25.777	30.332	49.448	66.624	74.340
101	8.835	13.159	30.762	36.979	55.655	77.678	79.291
105	9.559	8.991	24.529	30.827	48.503	59.322	66.525
110	12.077	14.841	35.922	45.971	70.921	106.324	109.363
118	17.712	16.302	38.407	53.027	87.062	103.727	123.433
123	0.094	0.208	0.300	0.584	0.722	1.064	1.306
132+153	24.818	22.648	68.139	82.362	119.892	165.469	181.435
163+138	30.316	29.042	99.208	94.453	168.222	214.542	220.792
146	5.660	5.411	17.116	20.982	30.064	43.110	47.982
149	5.013	5.752	20.771	26.291	37.733	54.963	57.888
151	1.784	1.680	6.443	8.044	10.979	15.430	16.537
170+190	5.711	4.696	12.011	14.740	23.259	29.841	35.128
172	2.126	2.475	5.097	6.625	8.950	12.034	12.254
180	12.361	13.768	28.648	38.273	55.861	75.209	80.560
187+182	4.102	4.351	17.432	19.547	32.642	42.033	43.520
195	0.686	0.625	1.579	1.989	2.608	3.594	3.884
203+196	4.655	4.004	10.452	13.647	19.335	26.749	29.878
197	0.150	0.069	0.501	0.793	0.984	1.234	1.252
201	3.556	3.189	10.328	12.528	17.812	24.681	24.434
208	0.278	0.243	0.564	0.771	1.101	1.423	1.363
Total PCBs	349.583	364.790	884.714	1287.150	1742.295	2248.412	2478.275

**PCB Concentrations (ng/gwet) in Sturgeon Bay Lake Trout (1994 and 1995)
(Continued)**

Congener	Age 8	Age 9	Age 10	Age 11	Age 12
28+31	66.954	77.598	111.520	99.443	107.946
33	63.982	34.107	36.697	75.689	53.131
44	33.195	49.237	50.701	32.234	28.188
49	37.845	41.842	40.070	51.421	62.538
52	64.537	58.491	92.921	82.763	87.828
56+60	55.385	82.393	99.851	137.322	73.866
66	186.923	255.298	264.540	386.921	234.730
70+76	76.679	105.075	110.659	152.905	95.558
74	50.498	70.697	78.345	107.210	66.468
77	6.685	6.907	12.407	13.600	10.319
81+87	75.729	78.939	100.210	140.067	96.935
89+84+92	245.107	277.331	390.988	416.209	284.160
85	57.672	109.100	102.649	141.713	89.222
99	94.898	125.154	156.480	209.150	151.254
101	113.195	151.327	193.178	267.999	160.833
105	79.250	99.385	140.080	165.916	133.617
110	144.145	176.551	227.895	309.951	232.517
118	142.990	168.539	240.937	276.779	226.950
123	1.401	1.715	1.792	2.359	1.702
132+153	206.942	247.985	320.117	320.940	304.475
163+138	260.991	281.228	407.877	398.335	304.516
146	56.778	69.026	84.552	80.844	90.964
149	74.369	81.397	117.008	127.702	113.001
151	21.626	21.294	30.955	34.259	32.845
170+190	39.045	38.363	64.018	70.959	55.435
172	16.711	20.770	28.197	33.870	26.544
180	102.704	115.630	149.134	186.764	156.371
187+182	62.193	68.694	91.501	95.639	71.585
195	4.410	4.982	8.105	7.937	7.043
203+196	35.589	34.609	56.418	62.819	51.484
197	1.692	1.708	2.338	2.813	2.245
201	33.695	32.718	51.387	58.205	48.042
208	1.824	1.815	2.758	2.785	2.443
Total PCBs	3395.8	4267.0	5190.4	6416.8	5024.9

PCB Concentrations (ng/gwet) in Sheboygan Reef Lake Trout (1994 and 1995)

Congener	Age 3	Age 4	Age 5	Age 6	Age 7	Age 8
28+31	2.349	6.491	8.572	13.126	21.200	23.931
33	0.000	0.000	0.000	0.000	17.724	13.163
44	3.051	0.000	0.000	0.000	0.000	23.109
49	0.000	0.000	0.000	14.172	6.689	9.919
52	0.000	4.723	10.966	12.785	22.029	23.444
56+60	7.959	11.579	20.051	20.911	27.984	32.555
66	22.084	29.180	52.964	57.596	82.542	90.674
70+76	8.479	11.284	18.908	26.067	33.795	37.338
74	5.341	7.176	13.591	15.090	21.299	22.533
77	0.727	0.869	1.706	2.401	3.278	3.318
81+87	29.304	33.709	42.660	49.367	57.814	70.299
89+84+92	37.496	49.209	85.739	104.224	133.213	165.941
85	12.537	19.777	28.877	30.582	37.123	42.600
99	14.628	25.622	40.493	40.355	50.249	71.108
101	16.199	20.698	41.807	51.197	61.600	77.654
105	15.756	22.053	35.820	34.615	57.052	75.080
110	20.635	25.731	46.707	64.792	82.438	109.961
118	28.838	42.093	61.520	60.930	100.543	140.992
123	0.206	0.270	0.550	0.655	1.069	1.471
132+153	45.226	60.176	97.252	87.272	143.787	190.680
163+138	59.090	75.884	128.908	116.502	180.747	237.563
146	6.424	11.309	20.558	25.583	37.545	49.172
149	8.984	10.106	21.734	27.628	42.637	62.837
151	2.774	3.524	6.856	7.979	13.019	17.667
170+190	8.053	15.352	21.165	18.992	28.705	37.889
172	3.109	5.254	7.616	7.988	11.342	14.512
180	19.163	36.244	49.873	48.246	74.927	86.163
187+182	7.342	9.645	20.146	23.297	33.271	45.150
195	1.205	1.721	2.812	2.438	3.542	4.914
203+196	7.677	12.473	19.801	17.086	26.200	34.354
197	0.375	0.540	0.782	0.780	1.251	1.505
201	4.954	7.097	12.938	14.318	21.804	30.457
208	0.453	0.552	1.019	0.924	1.378	1.856
Total PCBs	544.1	749.0	1300.1	1329.4	2011.4	2662.7

**PCB Concentrations (ng/gwet) in Sheboygan Reef Lake Trout (1994 and 1995)
(Continued)**

Congener	Age 9	Age 10	Age 11	Age 12
28+31	27.117	38.287	59.381	50.904
33	14.768	11.304	23.388	7.998
44	17.491	33.339	42.762	31.584
49	14.438	23.805	31.731	28.917
52	34.453	49.661	62.762	51.654
56+60	39.777	56.678	73.976	65.390
66	118.889	164.240	222.135	186.011
70+76	49.819	70.778	86.727	71.353
74	30.417	44.126	57.365	50.362
77	4.220	7.203	8.449	7.179
81+87	70.967	87.231	109.337	97.456
89+84+92	196.518	258.625	314.461	266.142
85	38.322	44.303	67.224	47.548
99	83.588	109.036	144.470	123.786
101	102.514	144.378	168.091	138.410
105	85.615	111.966	170.353	145.071
110	123.866	204.392	217.835	177.645
118	145.182	182.151	303.263	236.468
123	1.521	1.666	2.902	2.261
132+153	215.050	233.549	385.133	333.006
163+138	261.633	334.204	478.044	414.488
146	59.306	74.663	109.645	82.588
149	76.345	108.299	131.518	109.975
151	20.782	28.133	36.344	32.945
170+190	39.775	53.027	82.994	83.730
172	16.805	23.309	29.654	22.048
180	100.669	128.123	207.344	173.536
187+182	56.780	75.421	85.610	74.777
195	5.210	7.259	10.952	11.943
203+196	36.921	49.995	77.609	74.577
197	1.643	1.948	3.471	2.697
201	33.076	46.398	64.124	45.504
208	2.148	2.865	3.829	3.766
Total PCBs	2885.367	3847.910	5291.523	4320.339

PCB Concentrations (ng/gwet) in Saugatuck Lake Trout (1994 and 1995)

Congener	Age 1	Age 2	Age 3	Age 4	Age 5	Age 6
28+31	0.000	0.000	0.000	12.689	25.357	54.836
33	0.000	0.000	0.000	0.000	60.046	149.814
44	0.000	0.000	0.000	7.271	18.186	26.458
49	0.000	0.000	0.000	0.000	12.937	23.683
52	0.000	54.702	15.423	21.443	28.489	42.646
56+60	2.407	10.121	10.335	16.764	25.861	41.315
66	6.976	30.022	28.322	50.218	75.783	128.176
70+76	2.972	12.541	13.400	20.900	32.136	57.787
74	2.101	8.940	8.828	14.090	20.651	35.901
77	0.420	1.597	1.209	1.798	3.538	5.481
81+87	15.370	34.205	28.866	33.756	40.463	63.679
89+84+92	15.212	65.689	60.687	98.227	133.026	228.572
85	3.366	18.363	16.325	27.565	39.935	62.355
99	4.767	22.423	20.386	34.339	49.952	79.670
101	7.864	32.706	32.377	45.768	64.437	117.938
105	4.060	21.851	17.916	34.405	48.238	68.026
110	8.261	35.693	35.403	52.105	74.116	134.279
118	8.237	41.458	33.447	65.537	89.691	127.994
123	0.038	0.192	0.195	0.348	0.448	0.733
132+153	15.417	66.905	56.234	104.088	146.448	192.622
163+138	18.143	87.664	71.280	131.670	186.316	255.139
146	3.369	16.388	13.260	22.683	32.292	52.359
149	4.445	17.108	19.775	29.044	41.290	71.993
151	2.005	7.014	6.813	10.232	14.458	22.469
170+190	3.444	13.279	13.325	18.845	24.501	36.805
172	1.455	5.627	5.426	8.320	10.427	15.972
180	8.902	35.430	35.959	51.095	68.493	95.069
187+182	3.628	16.926	17.716	27.286	32.853	67.401
195	0.518	1.730	1.735	2.472	3.321	4.614
203+196	3.647	11.663	12.134	17.917	23.482	34.081
197	0.000	0.727	0.632	0.945	1.156	1.664
201	2.746	9.588	8.852	14.221	18.886	31.062
208	0.282	0.600	0.573	0.873	1.162	1.718
Total PCBs	175.474	1006.024	854.026	1325.389	2048.679	3169.660

**PCB Concentrations (ng/gwet) in Saugatuck Lake Trout (1994 and 1995)
(Continued)**

Congener	Age 7	Age 8	Age 9	Age 10	Age 11	Age 12
28+31	41.441	58.278	94.278	89.884	71.240	74.058
33	0.000	79.286	45.341	24.287	68.407	32.485
44	27.384	38.107	60.763	57.841	0.000	85.738
49	24.918	54.032	66.320	63.576	46.492	68.946
52	53.326	97.743	113.608	133.449	89.570	110.241
56+60	41.852	65.226	86.046	86.744	106.207	97.381
66	134.351	186.428	296.478	293.366	326.176	291.395
70+76	55.184	85.751	132.429	124.580	126.473	127.506
74	40.012	50.604	85.699	84.646	91.269	83.357
77	5.054	6.480	9.185	9.300	9.469	11.042
81+87	62.337	89.576	115.261	124.845	132.524	119.929
89+84+92	223.314	315.128	440.209	483.935	467.124	450.639
85	59.930	72.836	84.631	85.427	67.642	87.862
99	92.361	117.029	158.320	177.869	226.828	191.150
101	117.717	175.219	241.748	275.204	251.779	245.095
105	90.825	108.533	129.450	144.524	273.178	225.447
110	121.589	181.002	238.491	271.898	273.766	261.772
118	159.552	182.133	222.638	263.991	396.848	318.105
123	0.959	1.659	1.817	2.146	1.067	2.647
132+153	277.072	276.537	351.994	380.232	487.895	438.150
163+138	350.735	371.566	461.226	532.781	651.971	547.906
146	52.772	82.009	93.598	119.568	116.769	136.812
149	80.649	107.123	125.935	163.525	168.020	176.019
151	27.012	33.280	43.959	48.187	53.570	55.721
170+190	55.392	55.922	68.048	95.684	133.525	113.024
172	19.716	25.493	30.099	38.397	39.965	39.942
180	142.617	156.647	179.478	249.146	315.883	276.035
187+182	81.900	76.951	102.800	124.901	162.844	164.270
195	7.168	7.541	9.519	13.455	18.328	15.683
203+196	51.628	55.952	66.377	99.183	124.932	108.448
197	2.424	2.386	2.816	3.763	5.345	4.608
201	39.138	49.023	57.490	73.102	81.521	80.992
208	2.316	2.662	3.202	4.315	5.277	4.428
Total PCBs	3530.741	4430.807	5958.251	6542.673	7476.621	6541.367

PCB Concentrations (ng/gwet) in Lake Michigan Coho Salmon (1994 and 1995)

Congener	Hatchery	Yearling	Age 2 (April-May)	Age 2 (June)	Age 2 (July-Oct.)	Age 2 (November)
28+31	0.000	0.000	7.456	17.375	17.334	18.672
33	0.000	0.000	0.000	15.158	35.219	15.184
44	0.000	0.000	0.000	10.925	11.268	9.721
49	0.000	0.000	0.000	2.036	13.136	8.569
52	0.000	0.000	5.398	17.627	18.419	15.121
56+60	0.831	1.955	3.726	9.774	17.444	13.042
66	4.261	5.117	11.520	32.110	57.477	42.305
70+76	3.380	2.828	5.557	13.159	24.125	18.233
074	2.179	1.311	3.305	9.079	16.652	11.621
77	0.000	0.264	0.632	1.436	2.594	2.370
81+87	15.588	13.926	16.780	24.814	34.594	28.300
89+84+92	9.848	10.935	18.090	50.450	95.721	64.203
85	1.986	2.855	4.998	14.463	21.408	18.322
99	3.236	3.688	6.318	18.208	34.905	24.366
101	7.712	6.708	10.768	28.445	52.062	35.947
105	2.426	3.166	5.716	16.229	30.831	21.356
110	7.763	6.956	13.981	34.774	59.180	41.925
118	6.489	5.805	10.452	32.501	60.284	40.341
123	0.000	0.034	0.105	0.331	0.427	0.246
132+153	5.912	11.521	14.538	45.758	86.036	60.727
163+138	7.482	15.237	20.484	66.101	122.707	87.200
146	1.148	2.778	2.877	14.276	23.141	13.169
149	2.887	4.611	6.049	18.890	33.776	21.454
151	1.015	1.305	1.589	5.109	9.346	5.672
170+190	0.831	2.131	3.522	9.169	16.075	10.634
172	0.278	1.013	1.250	3.738	7.271	4.724
180	2.231	6.447	7.808	21.549	41.654	25.801
187+182	2.239	3.229	4.324	12.225	24.890	17.066
195	0.098	0.328	0.417	1.043	2.038	1.144
203+196	0.717	2.383	2.920	8.102	15.307	8.816
197	0.013	0.115	0.123	0.330	0.614	0.366
201	0.670	2.358	2.724	7.455	15.002	8.712
208	0.060	0.133	0.168	0.431	0.667	0.403
Total PCBs	112.920	170.560	279.089	690.301	1379.036	926.867

PART 5

LM FOOD CHAIN

**Appendix 5.5.2. Agreement Between Modeled and Observed
PCB Concentrations**

Agreement Between Modeled and Observed PCB Concentrations in Zooplankton, *Mysis*, and *Diporeia* at Sturgeon Bay (1994 and 1995).

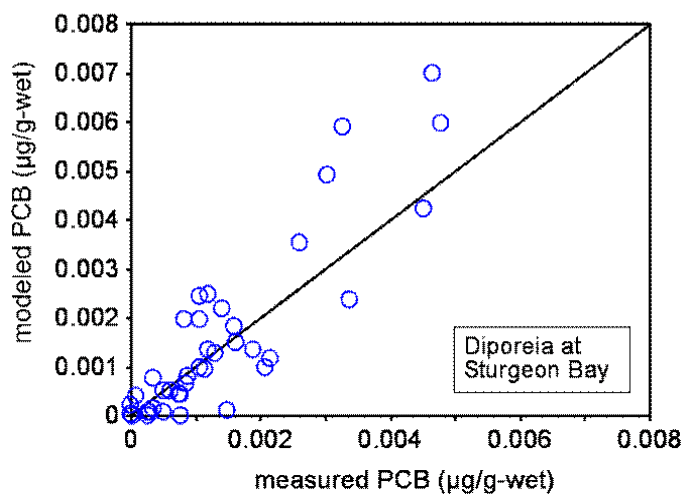
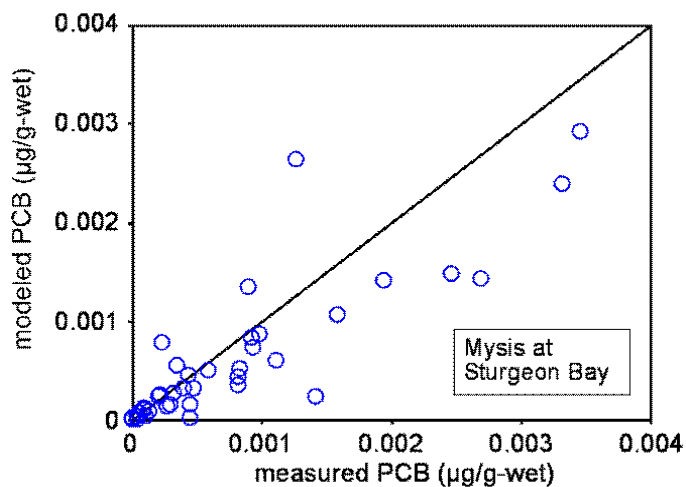
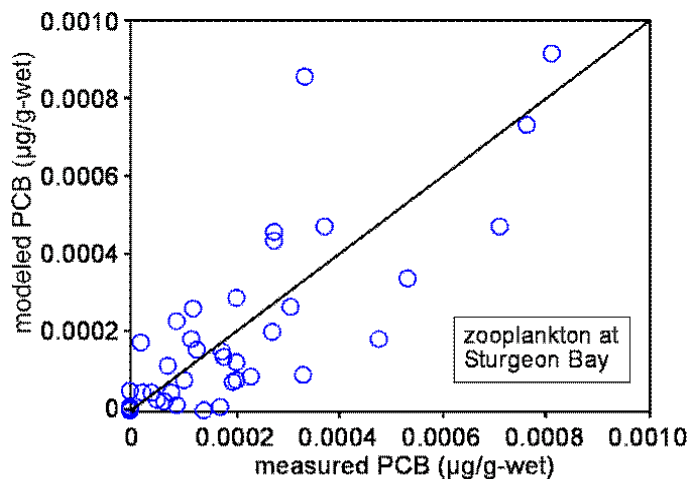

Agreement Between Modeled and Observed Fish PCB Concentrations in Forage Fish at Sturgeon Bay (1994 and 1995)

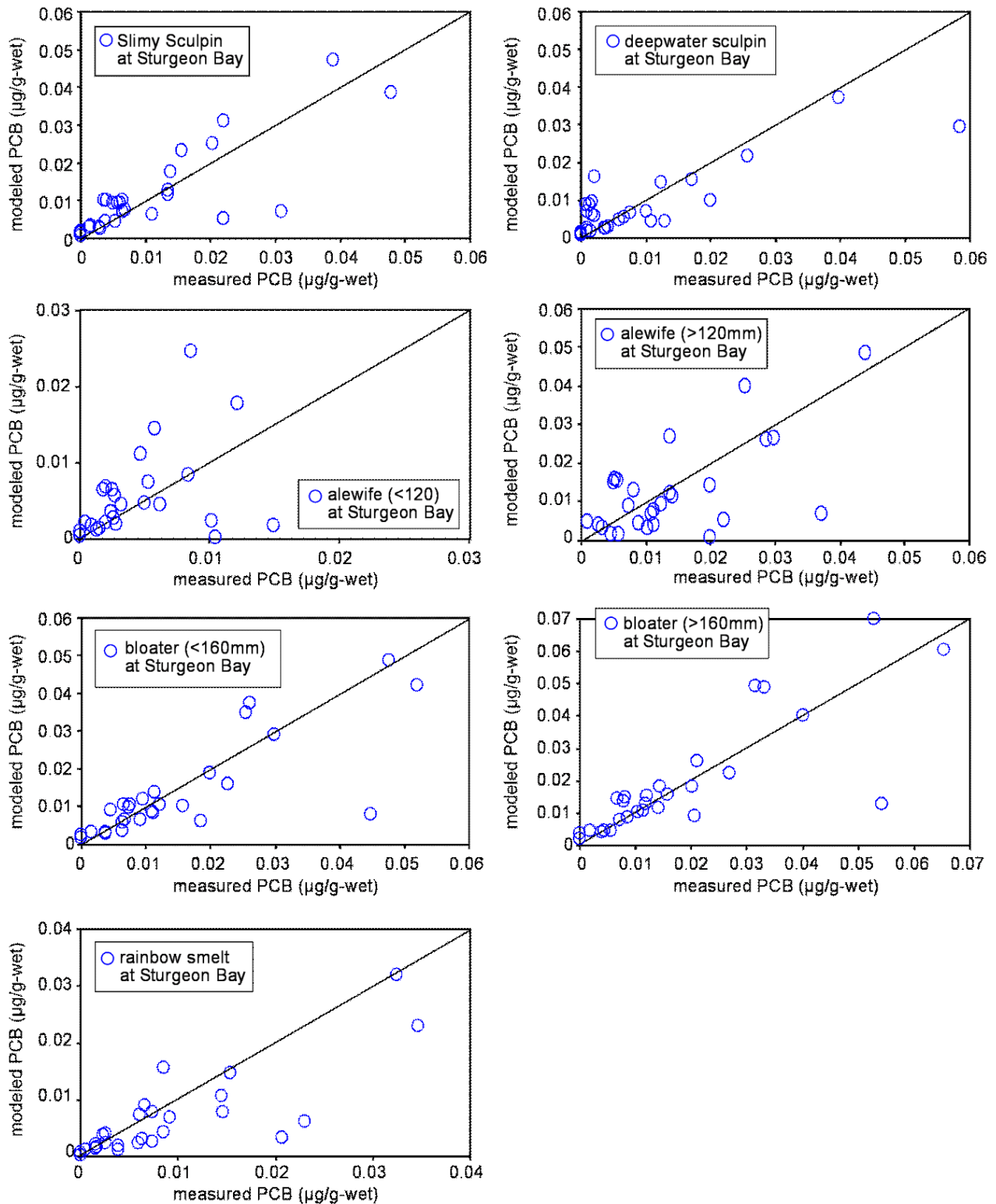

Agreement Between Modeled and Observed Fish PCB Concentrations in Lake Trout at Sturgeon Bay (1994 and 1995).

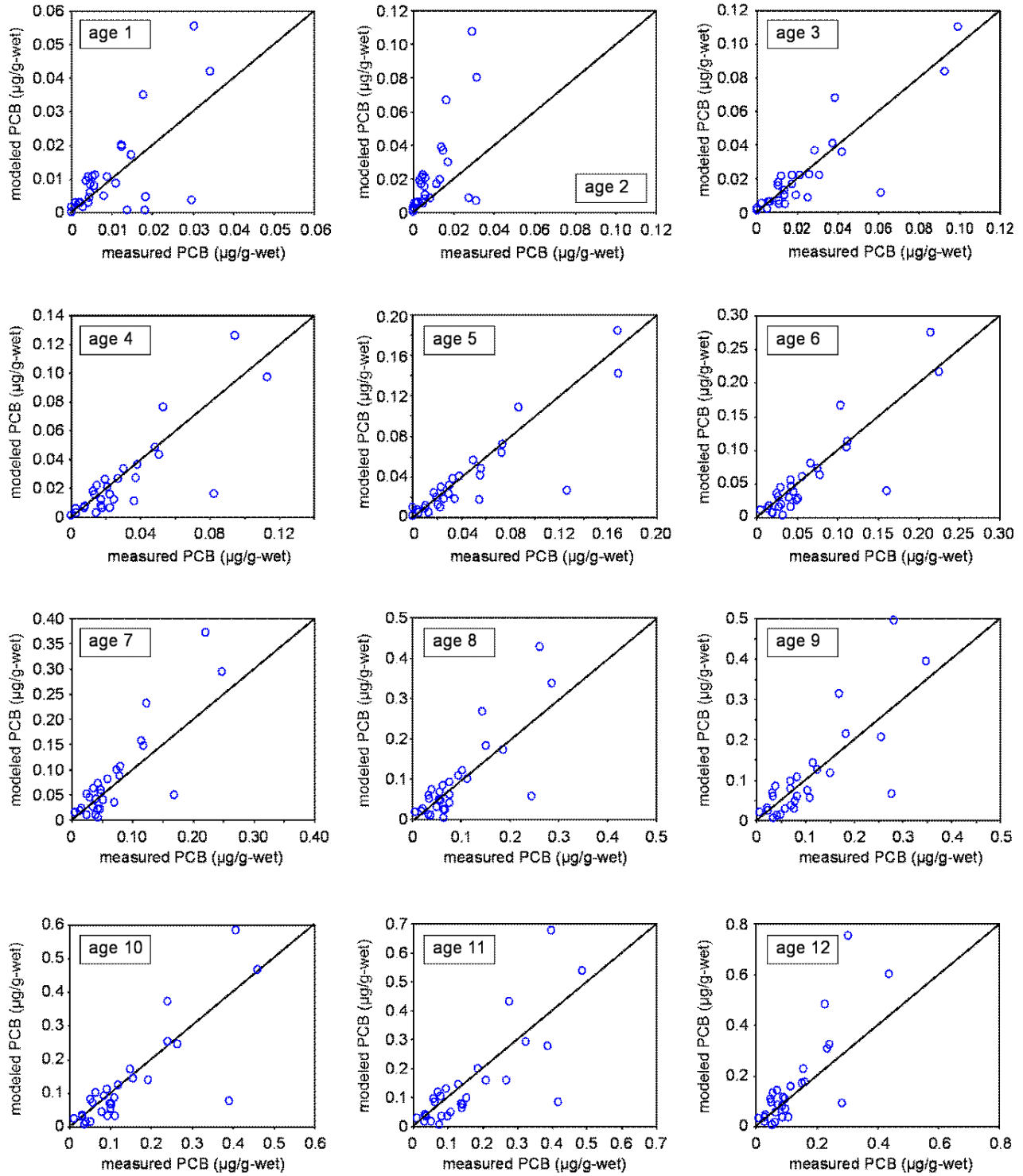

Agreement Between Modeled and Observed PCB Concentrations in Zooplankton, *Mysis*, and *Diporeia* at Sheboygan Reef (1994 and 1995)

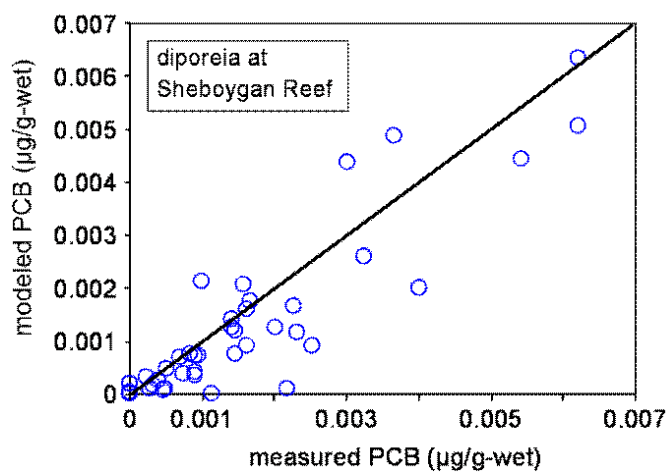
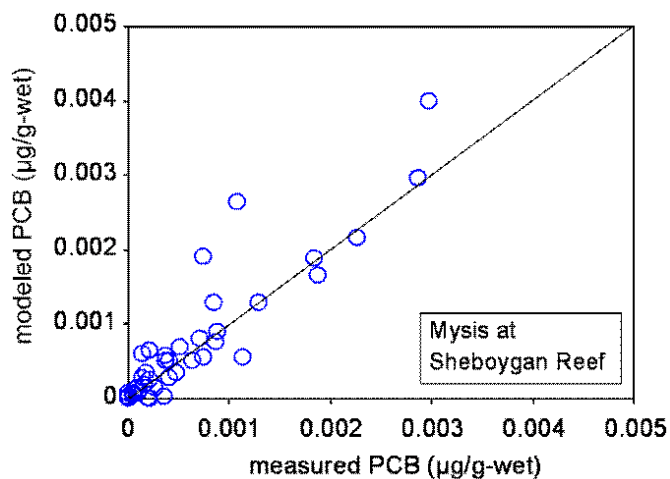
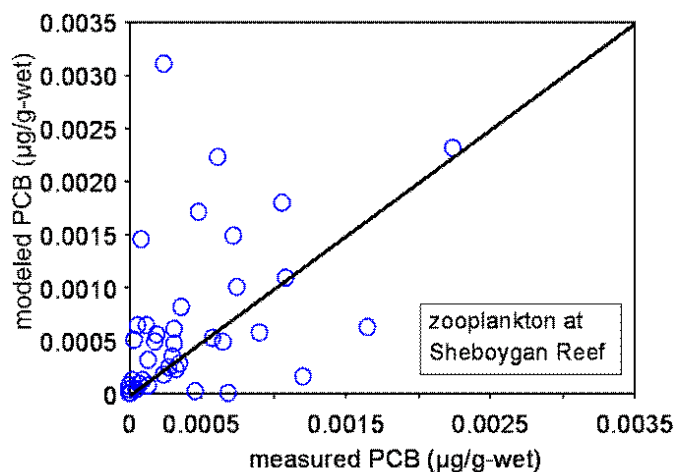

Agreement Between Modeled and Observed Fish PCB Concentrations in Forage Fish at Sheboygan Reef (1994 and 1995)

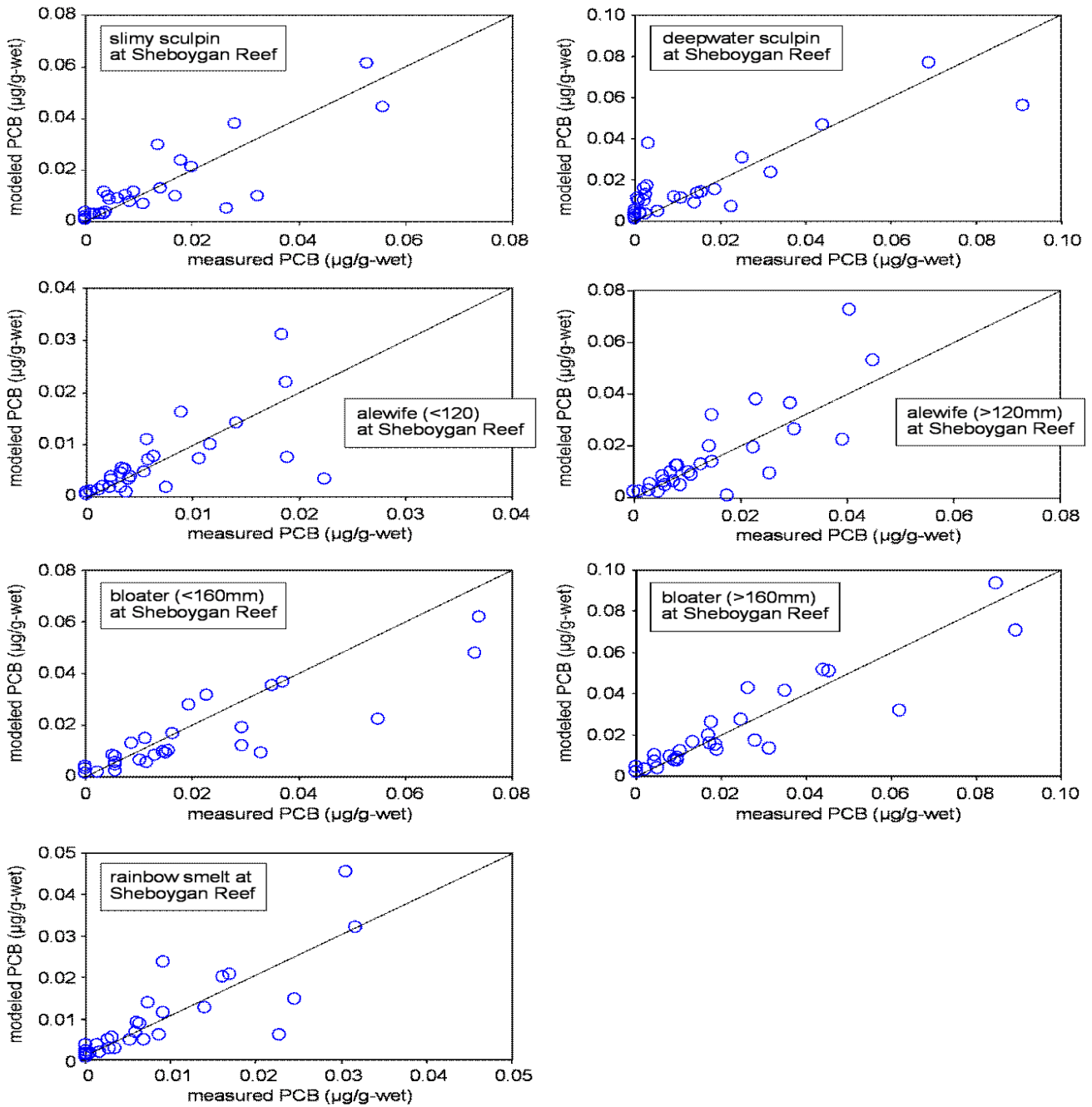

Agreement Between Modeled and Observed Fish PCB Concentrations in Lake Trout at Sheboygan Reef (1994 and 1995)

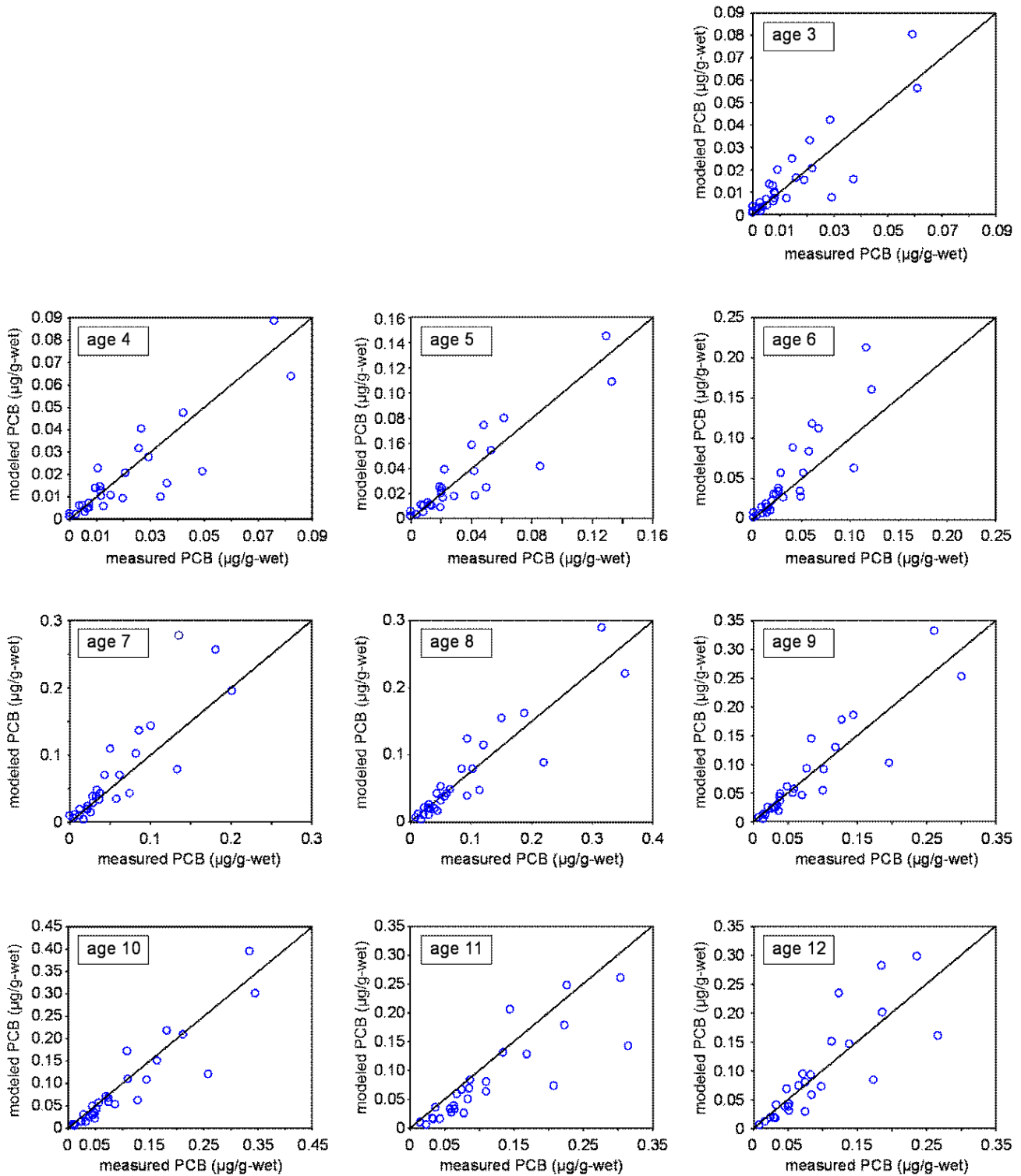

Agreement Between Modeled and Observed PCB Concentrations in Zooplankton, *Mysis*, and *Diporeia* at Saugatuck (1994 and 1995)

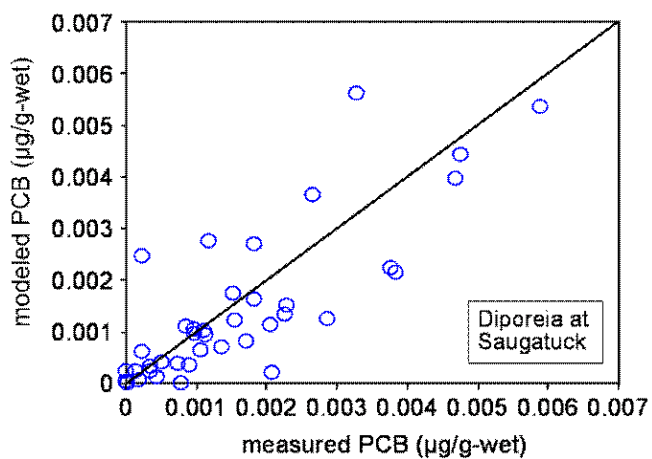
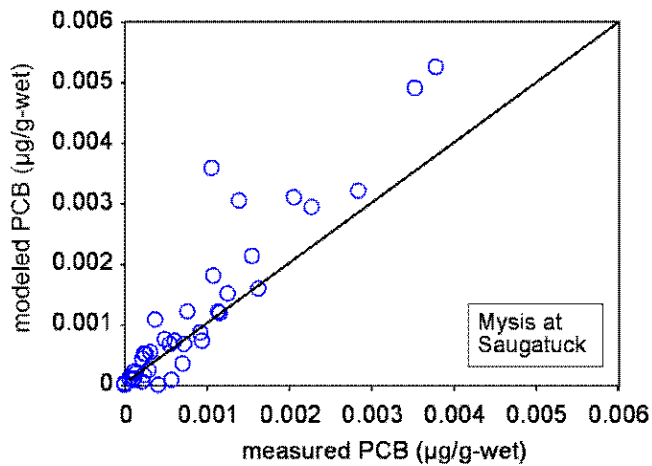
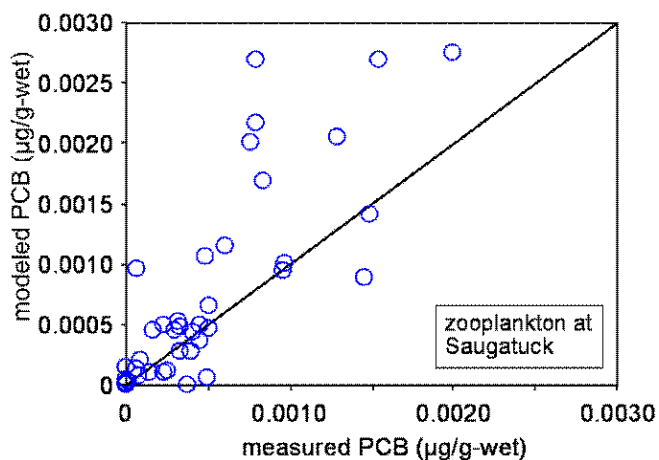

Agreement Between Modeled and Observed PCB Concentrations in Forage Fish at Saugatuck (1994 and 1995)

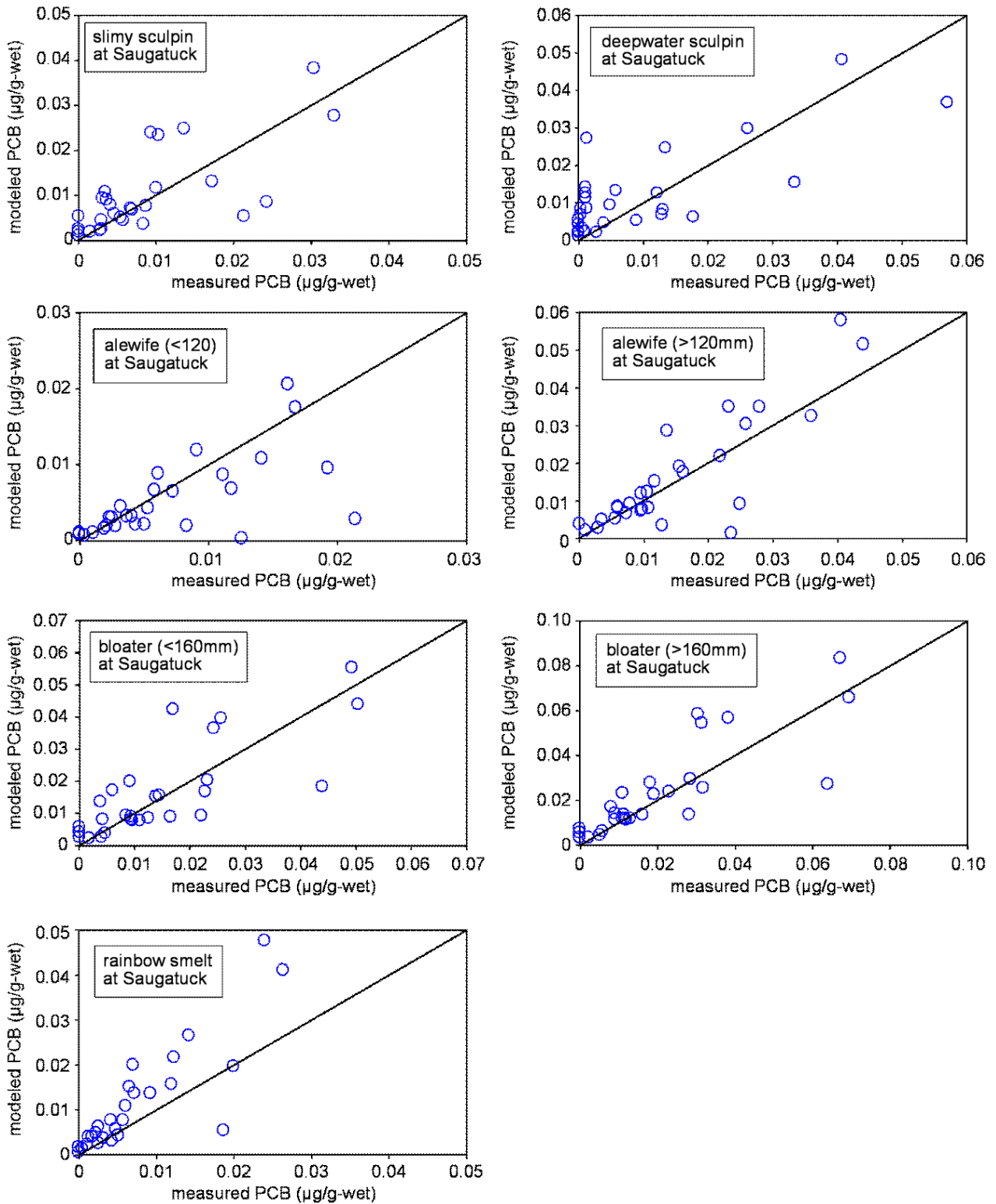

Agreement Between Modeled and Observed PCB Concentrations in Lake Trout at Saugatuck (1994 and 1995)

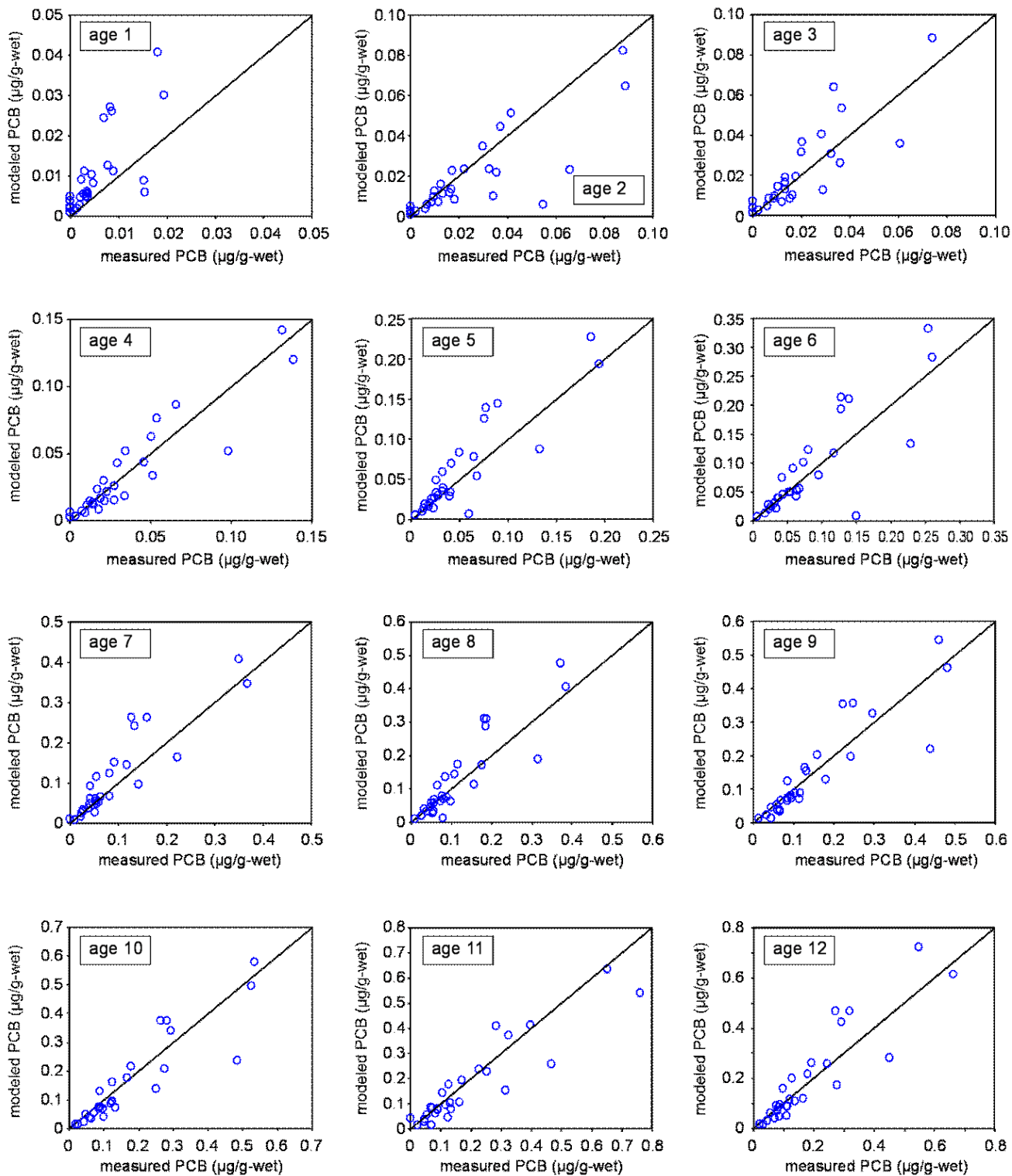

PART 5

LM FOOD CHAIN

Chapter 6. Model Verification

5.6.1 Introduction

Model validation represents an independent test of a model's ability to reproduce measured PCB concentrations in Lake Michigan fish. Ideally, a calibrated model should be subsequently validated with another set of observed data that are independent of those used in the model calibration process. Additional sample collection and analysis for PCB concentrations in the Lake Michigan system is currently underway. Once completed, this work will provide a new PCB data set necessary for the validation of the food web models.

In this study, no particular procedures were performed to validate the calibrated food web models due to the limited data currently available. In fact, subsequent validation of a calibrated bioaccumulation model is rare because the necessary field data are not readily available.

5.6.2 Model Applicability to Other Sites

An alternative of model evaluation is to test the applicability of the calibrated models to other sites. For the lake trout food web models, this test was possible thanks to the extensive collection of PCB data at the three biota zones for this project. Because the lake trout food webs consist of the same predator and prey species among the three biota zones, the model parameters required for simulating bioaccumulation in the food webs should be identical at these three biota zones. Therefore, model parameters calibrated for one biota zone could be

applied to model food web bioaccumulation at another biota zone. The agreement between the model results and the observed PCB data for the second biota zone could then be evaluated for the verification of the calibrated model parameters. Apparently, a properly calibrated model parameter set should be able to generate good fits for both biota zones. This exercise could serve as an independent test of how well the calibrated model represents fish bioaccumulation under different environmental characteristics and food web structures.

The calibration results presented in Chapter 5 show that the lake trout food webs at Sturgeon Bay and Saugatuck share a common set of parameter values (Table 5.5.2). The identical parameter values for Sturgeon Bay and Saugatuck suggested that the model parameters calibrated for Sturgeon Bay could be satisfactorily applied to model the Saugatuck food web, and *vice-versa*. In other words, the model parameters (Table 5.5.2) calibrated with observed data for Sturgeon Bay have been in effect verified with the observed data for the Saugatuck biota zone. Or conversely, the model parameters can be viewed as having been calibrated with the Saugatuck data and verified by the observed data for the Sturgeon Bay.

It should be pointed out that the identical calibrated parameter values obtained for the Sturgeon Bay and Saugatuck food webs were not achieved under a "blind test". In this sense, the applicability to both Sturgeon Bay and Saugatuck food webs did not necessarily constitute a strict validation of the calibrated models. This applicability, however, did provide us with a certain confidence about the model's performance at these two biota zones for its

intended purpose, which was to establish quantitative linkage between PCB levels in fish and exposure.

The food web model calibrated for Sheboygan Reef had a unique set of parameter values (see Table 5.5.3). This indicated that the calibrated model for this biota zone could not be validated with the observed data from Sturgeon Bay or Saugatuck. The reasons for this discrepancy were unclear. The mismatch in sampling locations for the observed PCB data for forage species and other food web

components may be one explanation. Due to difficulty in collecting fish samples at Sheboygan Reef, the forage fish samples were collected near Port Washington instead of from the biota zone. It is possible that the observed PCB data for the forage fish species did not represent the actual contamination levels at Sheboygan Reef. Therefore, the food web model calibrated with the data may not be optimized properly.

PART 5

LM FOOD CHAIN

Chapter 7. Model Sensitivity and Uncertainty

Sensitivity analysis was conducted to study how variations in different model parameters affect the model estimates for polychlorinated biphenyls (PCBs) in a fish food web. The purpose of this analysis was to determine which model parameters had the greatest influence on model simulations for PCB bioaccumulation in the food web. The results were very useful for guiding the calibration of the models. In fact, sensitivity analysis was performed repeatedly during the model calibration through the trophic levels and for each of the calibrated parameters in order to properly direct the calibration effort.

No model uncertainty analysis has been performed to estimate the uncertainty in the model output due to the variability in model parameters and other input variables. There are many uncertain aspects in a model that affect the model output. For a well-calibrated model, uncertainties in calibrated model parameters have a very limited effect on the overall model uncertainty. This is because the influences of uncertainty in individual model parameters has been cancelled out by the model calibration process. The effect of a change in one parameter can be balanced by appropriate adjustment to the other (i.e., compensating effects). Therefore, for a calibrated model, the major sources of model uncertainty are likely from other aspects, such as the quality of the field data used to guide the model calibration, the simplified model representations of fish behavior, food web structure and environmental conditions, and approximations made during model construction. It is difficult to adequately quantify these sources of

uncertainty. In addition, the reliability of model results for chemical bioaccumulation is associated with individual model applications and, to a large extent, is predominated by the uncertainty in the input of exposure chemical concentrations whose reliability is often not adequately defined. Any applications of a model beyond the domain for which the model is calibrated will also likely increase the uncertainty associated with the model results. It is, therefore, not an easy task to perform an uncertainty analysis to define the expected distribution of model outputs for the fish models.

In this study, model sensitivity to selected parameters and input variables were quantitatively assessed in terms of their relative impacts on the output of the model. The results are presented in this chapter to illustrate the potential range of uncertainty of the model in association with different model parameters and input variables. In addition, by identifying the most sensitive input variables, the results can also be useful to guide the effort for effective reduction of model uncertainty.

5.7.1 Sensitivity Analysis

Model outputs for PCB bioaccumulation in the lake trout food web at Saugatuck, Lake Michigan, were used as an example for the model sensitivity analysis. A total of seven input parameters were assessed for their influence on model outputs for PCBs in the top predators of the food web. These included four calibrated model parameters:

- Chemical assimilation efficiency (α);
- Food assimilation efficiency (β);
- Chemical relative gill transfer coefficient (E_c/E_o);
- The fraction of ingested energy for specific dynamic action (SDA);

and three other input variables:

- Fish growth rate;
- Octanol-water partition coefficient K_{ow} ;
- Fish diet.

Most of these parameter inputs are species-specific. For simplicity, sensitivity simulations were performed for input parameters associated with the top predator (lake trout) only. This is because the involvement of input parameters for species in lower trophic levels complicates the sensitivity analysis. Due to feeding interactions, an input parameter for a species in lower trophic levels will impact not only the model outputs for that particular species but also the model outputs for species in upper trophic levels. The quantification of this type of across trophic levels propagation and aggregation of the impact of a parameter is strongly dependent on the feeding relationships between the species and its predators. In order to properly isolate the impacts of individual parameters on model output, all parameters in lower trophic levels were fixed at their nominal values and the parameters associated with lake trout only were adjusted for the sensitivity simulations.

The calibrated food web model for lake trout at Saugatuck was used to conduct model sensitivity analysis. The analysis was performed by running the model with the modified values of a tested input parameter to calculate the steady-state PCB concentrations in the fish, while the other parameters were fixed at their calibrated values. PCB concentration changes in the lake trout (age four) relative to the calibrated model results are used to illustrate the sensitivity of modeled PCB data to the change of a particular input parameter.

5.7.1.1 Chemical Assimilation Efficiency (α)

The chemical assimilation efficiency for fish is believed to be correlated to the octanol-water partition coefficient (K_{ow}) of a chemical. In this study, the correlation between chemical assimilation efficiency and the K_{ow} value reported by Gobas *et al.* (1988) was used in the calibrated model. The values estimated by this correlation are generally at the lower end of the reported chemical assimilation data. For sensitivity analysis, the chemical assimilation efficiency of the lake trout for all PCB congeners was increased by 20%. This adjustment of parameter input essentially increases the chemical intake of a fish by 20%. The result of a sensitivity simulation indicates that, except for a few low K_{ow} congeners, PCBs in lake trout increase by 20% as a result of a similar increase in chemical assimilation efficiency. Figure 5.7.1 reflects the proportional increase in computed PCBs in lake trout responding to a 20% increase in the values of chemical assimilation efficiency.

5.7.1.2 Food Assimilation Efficiency (β)

The calibrated values of food assimilation efficiency for lake trout are related to selection of the values of chemical assimilation efficiency (α). For sensitivity simulations, the value of the food assimilation efficiency for young lake trout (ages 1-4) was adjusted upward from 0.40 to 0.50. The value of food assimilation efficiency has a direct impact on the amount of food or chemical intake by a fish. The increase in the food assimilation efficiency from 0.40 to 0.50 will result in a proportional reduction in the amount of food intake necessary to meet the fish's energy demand. A reduced food intake, 80% of the original ($0.40/0.50 = 0.80$), translates into a correspondingly lower dietary chemical intake by the fish. The sensitivity simulation indicates that for high K_{ow} PCB congeners, their concentrations in the lake trout reduced by 20% as suggested by the expected reduction in chemical uptake by dietary route. The concentration reduction for low K_{ow} PCB congeners in lake trout were not as pronounced as for high K_{ow} PCB congeners (Figure 5.7.2). For low K_{ow} PCBs, the dietary route of PCB intake by a fish is not as dominant as for high K_{ow} PCBs.

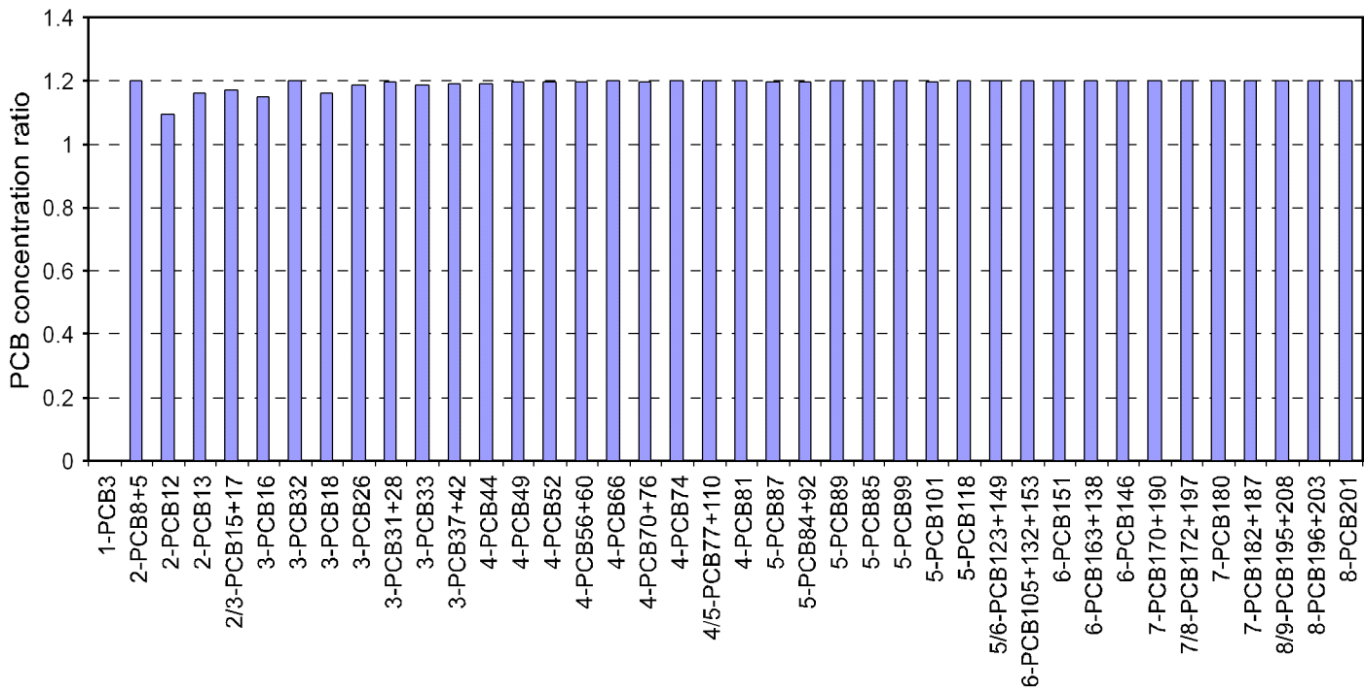

Figure 5.7.1. Sensitivity of PCBs in lake trout (age four) to chemical assimilation efficiency presented as ratios of model outputs with modified chemical assimilation efficiency to model outputs with the calibrated chemical assimilation efficiency.

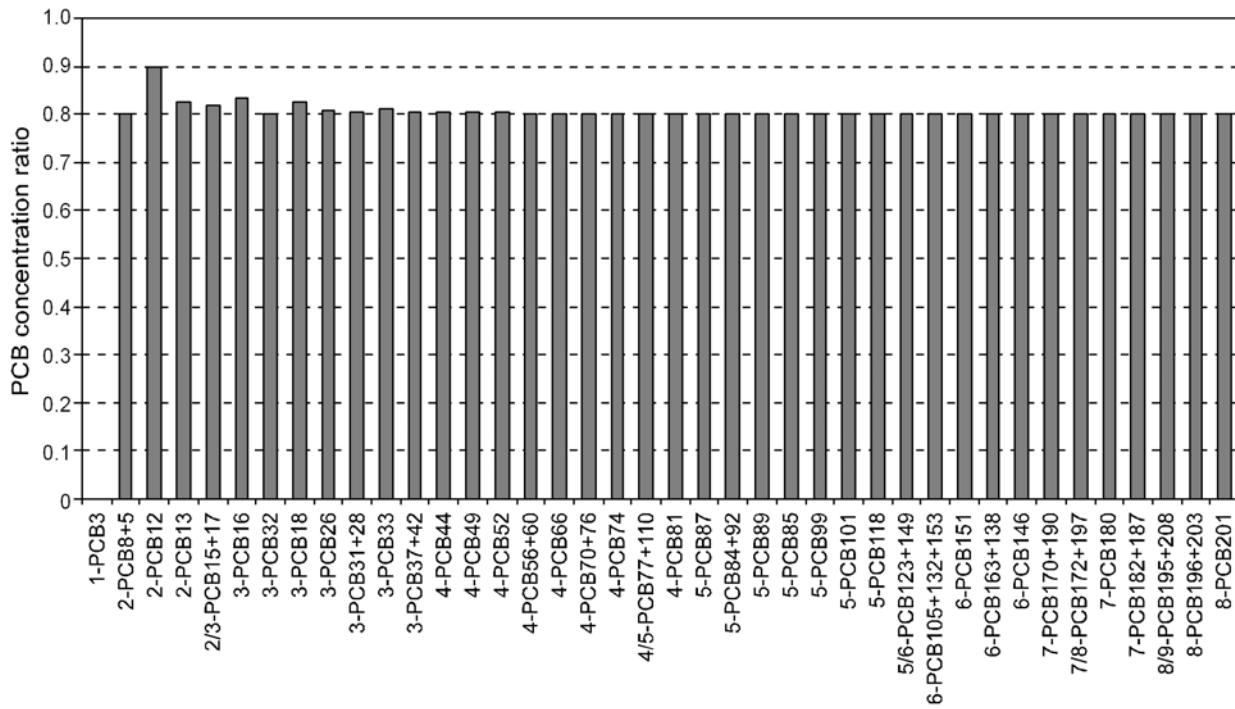

Figure 5.7.2. Effect of changes in food assimilation efficiency on the computed PCB data for lake trout in Lake Michigan presented as ratios of model outputs with modified food assimilation efficiency to model outputs with the calibrated food assimilation efficiency.

5.7.1.3 Chemical Relative Gill Transfer Coefficient (E_g/E_o)

The value of the chemical relative (to oxygen) gill transfer coefficient (E_g/E_o) used in the model for young lake trout (ages 1-4) is 0.60. For the sensitivity analysis, this value was increased to 0.80. The corresponding changes in model results were greatest (up to 16% decrease) for PCB congeners with lower K_{ow} values. The model results for highly chlorinated PCB congeners were less sensitive to the variation in the chemical relative gill transfer coefficient (E_g/E_o). For PCB congeners with chlorine numbers greater than seven, essentially no changes were observed in response to the increase in this parameter (see Figure 5.7.3). The increase in this parameter raises the elimination rate of PCBs through gill ventilation. The results of this sensitivity analysis suggests that the chemical elimination *via* gill ventilation is an insignificant loss mechanism relative to growth dilution for highly chlorinated PCB congeners.

5.7.1.4 The Fraction of Ingested Energy for Specific Dynamic Action (SDA)

The calibrated value of the SDA for young lake trout (ages 1-4) is 0.15. For the sensitivity analysis, this value was reduced to 0.10. The downward adjustment of this parameter corresponded to roughly a 5% reduction in chemical dietary uptake rate based on Equation 5.7.1 (see Part 5, Chapter 4, Section 5.4.3.2). The results of the sensitivity simulation show that lower chlorinated PCB congeners are not sensitive to changes in SDA. For highly chlorinated PCB congeners, a reduction in SDA from 0.15 to 0.10 produces about a 5% reduction in modeled PCB concentration in the fish (see Figure 5.7.4). This result suggests that for these highly chlorinated congeners, the dietary uptake may be the dominant route for chemical accumulation in fish.

$$R_{SDA} = (R \cdot Q_{ox} + SDA \cdot G \cdot D_f) / (1 - SDA) \quad (5.7.1)$$

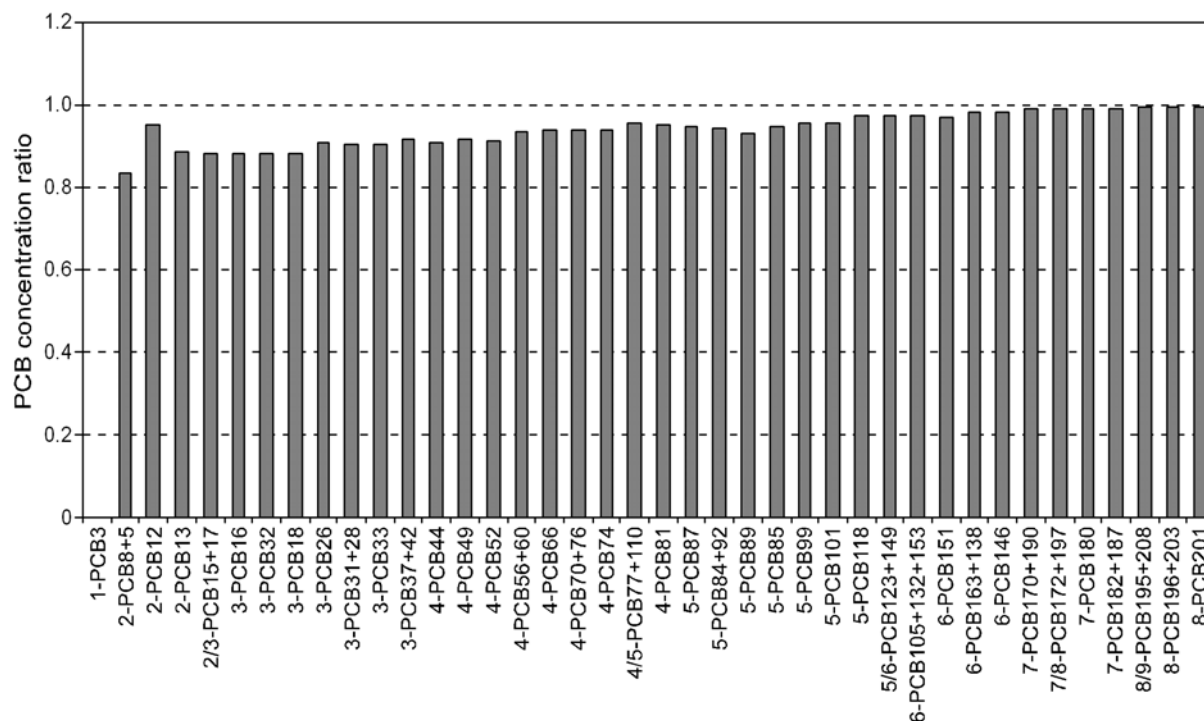

Figure 5.7.3. Effect of changes in chemical relative gill transfer coefficient (E_g/E_o) on the computed PCB data for lake trout in Lake Michigan presented as ratios of model outputs with modified chemical relative gill transfer coefficient to model outputs with the calibrated chemical relative gill transfer coefficient.

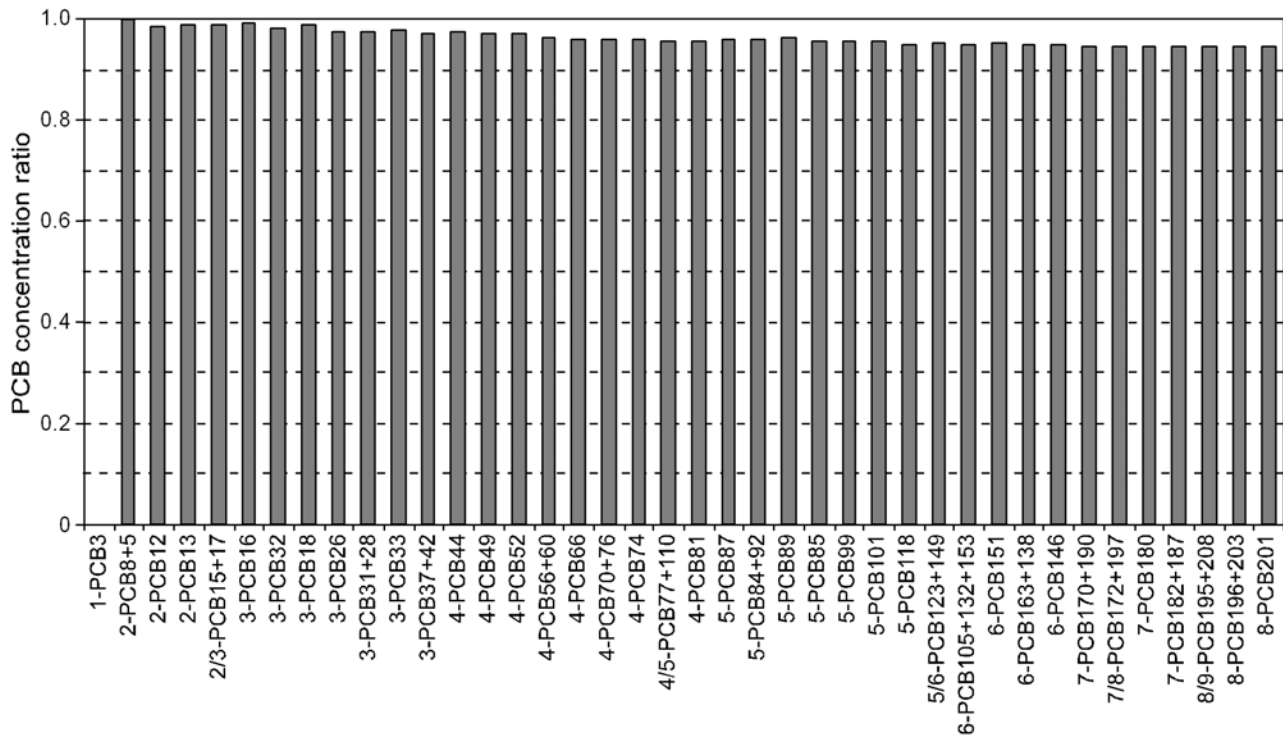

Figure 5.7.4. Effect of changes in SDA on the computed PCB data for lake trout in Lake Michigan presented as ratios of model outputs with modified SDA parameter to model outputs with the calibrated SDA value.

5.7.1.5 Fish Growth Rate

Fish growth rates in this model were calculated based on the age-weight relationships presented in Tables 5.4.9a-d (Part 5, Chapter 4). For young lake trout at Saugatuck, the average growth rate was estimated to be about 0.0018 day⁻¹ based on Equation 5.7.2 (see Part 5, Chapter 4, Section 5.4.2.2). A sensitivity simulation was performed for this parameter by adjusting the lake trout growth rate for all age classes from the current growth rate to zero. Figure 5.7.5 shows that the modeled PCB concentrations for lake trout (age 4) were sensitive to the changes in this parameter. A reduction to zero in the fish growth rate resulted in significant increases in modeled PCB concentrations for higher chlorinated PCB congeners and moderate decreases for lower chlorinated PCB congeners.

$$G = \ln(W_1 / W_0) / (t_1 - t_0) \quad (5.7.2)$$

The reduction in fish growth has two opposite effects on the modeling of chemical bioaccumulation in fish. It lowers the estimate for chemical clearance (*via* growth dilution) from the fish, which would result in a higher model estimate for chemical bioaccumulation. On the other hand, the reduction in fish growth also cuts back the fish's energy demand in response to a slow growth, which would result in a lower model estimate for fish's food intake and associated chemical uptake. The net effect of a zero fish growth rate on the overall model output for PCB bioaccumulation will depend on the individual PCB congeners.

The elevated PCB levels in the zero-growth fish suggested that fish growth is an important route of elimination (*via* dilution) for highly chlorinated PCB congeners. For lower chlorinated PCB congeners, fish growth plays a minor role in the overall clearance of PCBs from the fish in comparison with other elimination processes. The net effect of a zero fish growth is thus dominated by the reduction in energy demand and consequently the lower chemical

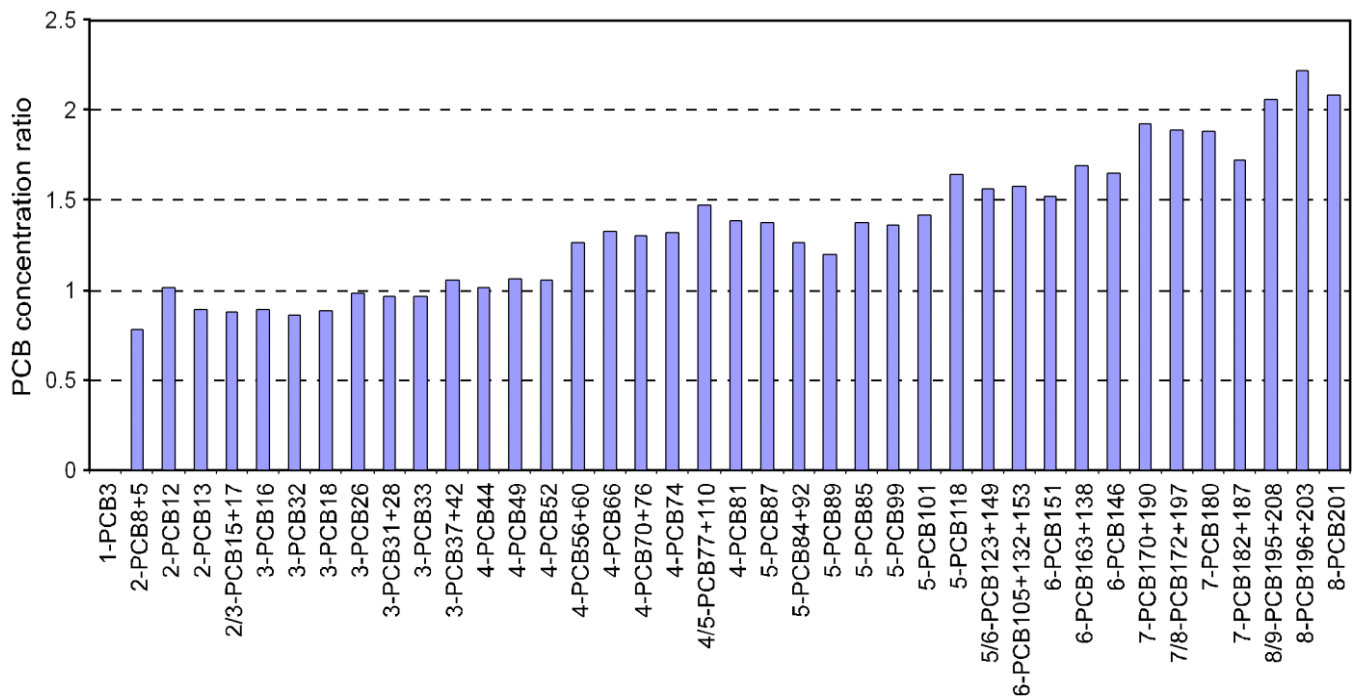

Figure 5.7.5. Sensitivity of PCBs in lake trout (age four) to fish growth rate presented as the ratios of model outputs with zero lake trout growth rate to model outputs with field estimated growth rate.

uptake. As a result, the model generates lower estimates for PCB concentrations in the zero growth fish.

5.7.1.6 Octanol-Water Partition Coefficient K_{ow}

Reported K_{ow} values for PCB congeners vary in the literature (Hawker and Connell, 1988; Li *et al.*, 2003; Schenker *et al.*, 2005; Miller *et al.*, 1984; Woodburn *et al.*, 1984). For a given PCB congener, a variation of up to 0.5 logarithm unit is not uncommon among reported data of the K_{ow} . K_{ow} values used in the calibrations of the food web model are those published by Hawker and Connell (1988). Eight PCB congeners with different hydrophobicity were selected for sensitivity analysis. Model sensitivity simulations were conducted by reducing the log K_{ow} value for each PCB congener by 5%. Figure 5.7.6 indicates that PCB estimates for lake trout (age four) are very sensitive to log K_{ow} values. For lower chlorinated congeners, model estimated PCB concentrations decrease to about one-third in response to a 5% reduction in log K_{ow} values. The reduction in model predictions is a result of an increased gill elimination rate caused by the reduced log K_{ow} values. The model sensitivity becomes

smaller with higher chlorinated PCB congeners. This is consistent with the fact that gill elimination is a less important route for higher chlorinated congeners than lower chlorinated congeners.

5.7.1.7 Fish Diet

There are considerable variations in dietary data for fish in Lake Michigan. The dietary compositions used in the calibrated food web models were the average values over a sampling time period of two years (1994 and 1995). For lake trout at Saugatuck, the main dietary components are alewife, rainbow smelt, and bloater (Table 5.4.2a). Sensitivity simulations were run by changing the dietary composition from their original diet to 50% rainbow smelt and 50% alewife for all age classes of lake trout. The results of the sensitivity analyses for four year-old lake trout are presented as an example in Figure 5.5.7. Except for a few lower chlorinated PCB congeners, a 10% to 20% drop in modeled PCB concentrations occurred in response to the dietary change.

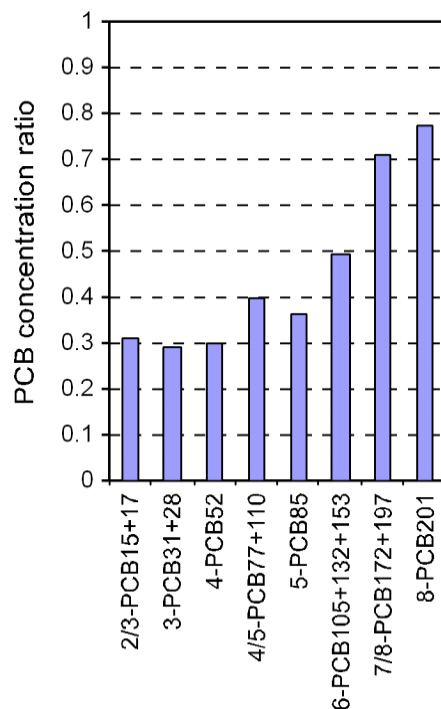

Figure 5.7.6. Sensitivity of PCBs in lake trout (age four) to octanol-water partition coefficient ($\log K_{ow}$) presented as ratios of model outputs with $\log K_{ow}$ input reduced by 5% to model outputs with original $\log K_{ow}$ values.

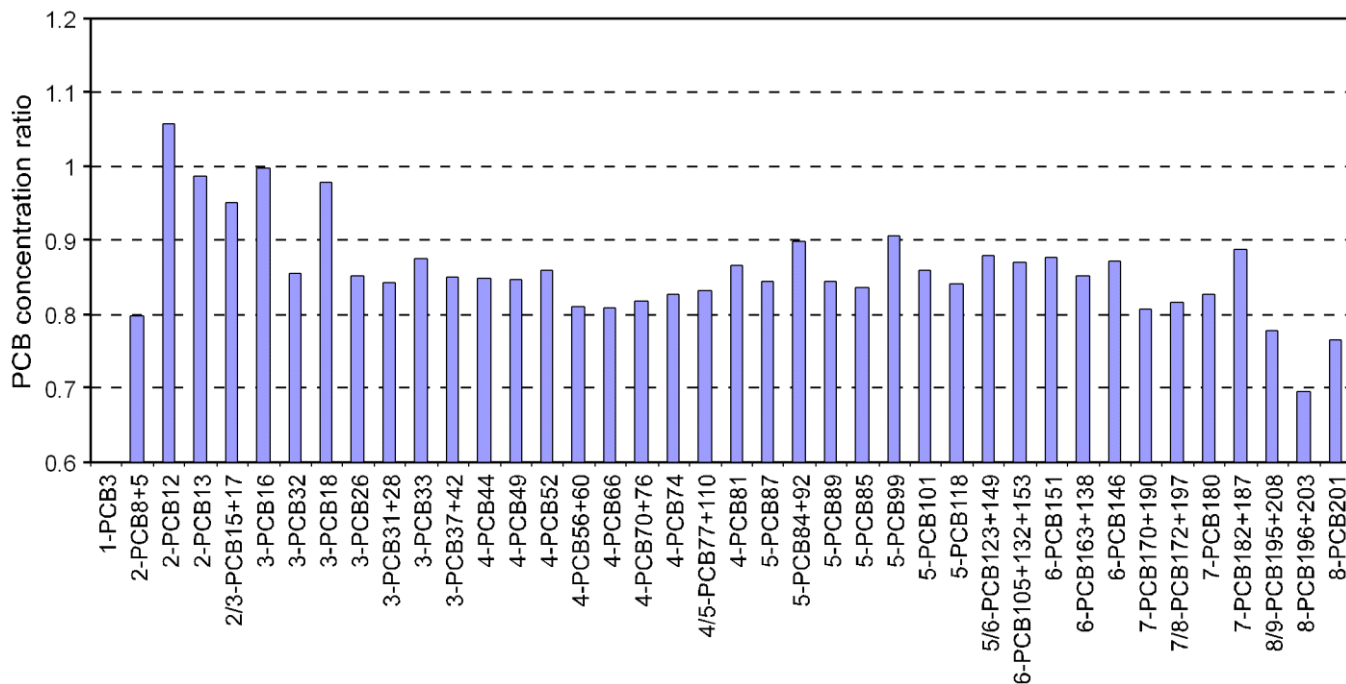

Figure 5.7.7. Sensitivity of PCBs in lake trout (age four) to fish diet presented as ratios of model outputs with modified fish diet to model outputs with field estimated fish diet.

Alteration of fish diet had a direct impact on model estimates for dietary PCB flux into the fish. A shift to a less contaminated diet will result in a lower PCB uptake by the fish. Because the diet of lake trout varies with age classes, a dietary shift to rainbow smelt and alewife exclusively will likely have different results for different age classes of the lake trout in terms of modeled PCB concentrations. For lake trout at a age class whose original prey is less contaminated than rainbow smelt or alewife, the above dietary shift will result in a higher model estimate of PCBs in the fish. It should be noted that for the four-year-old lake trout, model results are not only influenced by its own dietary change but also by the dietary changes in younger age classes because the initial PCB level in an older fish is determined by the PCB levels in the fish while in previous age classes.

The hypothetical dietary composition for sensitivity analysis was chosen based on the observation that *Diporeia* is disappearing in Lake Michigan (Landrum *et al.*, 2000; Nalepa *et al.*, 1998). This event will inevitably affect the population and availability of deepwater sculpin, slimy sculpin, and bloater that prey on *Diporeia* as a primary food source. However, this sensitivity simulation is by no means a prediction as to what will happen to the lake trout PCBs in association with the disappearance of *Diporeia* in Lake Michigan because it is not possible to predict the alternative diet of a fish in response to changes in prey community composition. We may be able to estimate the relative abundances of potential alternative food items with the depletion of a preferred food source. However, food selectivity of a fish is not only a function of prey populations but also determined by other factors, such as food preference and the ability to actively select a favorable food.

References

Gobas, F.A.P.C., D.C.G. Muir, and D. Mackay. 1988. Dynamics of Dietary Bioaccumulation and Faecal Elimination of Hydrophobic Organic Chemicals in Fish. *Chemosphere*, 17(5):943-962.

Hawker, D.W. and D.W. Connell. 1988. Octanol-Water Partition Coefficients of Polychlorinated Biphenyl Congeners. *Environ. Sci. Technol.*, 22(4):382-387.

Landrum, P.F., D.C. Gossiaux, T.F. Nalepa, and D.L. Fanslow. 2000. Evaluation of Lake Michigan Sediment for Causes of the Disappearance of *Diporeia* spp. in Southern Lake Michigan. *J. Great Lakes Res.*, 26(4):402-407.

Li, N.Q., F. Wania, Y.D. Lei, and G.L. Daly. 2003. A Comprehensive and Critical Compilation, Evaluation, and Selection of Physical-Chemical Property Data for Selected Polychlorinated Biphenyls. *J. Phys. Chem. Ref Data*, 32(4):1545-1590.

Miller, M.M., S. Ghodbane, S.P. Wasik, Y.B. Tewari, and D.E. Martire. 1984. Aqueous Solubilities, Octanol/Water Partition Coefficients, and Entropies of Melting of Chlorinated Benzenes and Biphenyls. *J. Chem. Engin. Data*, 29(2):184-190.

Nalepa, T.F., D.J. Hartson, D.L. Fanslow, G.A. Lang, and S.J. Lozano. 1998. Declines in Benthic Macroinvertebrate Populations in Southern Lake Michigan, 1980-1993. *Canadian J. Fish. Aquat. Sci.*, 55(11):2402-2413.

Schenker, U., M. MacLeod, M. Scheringer, and K. Hungerbuhler. 2005. Improving Data Quality for Environmental Fate Models: A Least-Squares Adjustment Procedure for Harmonizing Physicochemical Properties for Organic Compounds. *Environ. Sci. Technol.*, 39(21):8434-8441.

Woodburn, K.B., W.J. Doucette, and A.W. Andren. 1984. Generator Column Determination of Octanol/Water Partition Coefficients for Selected Polychlorinated Biphenyl Congeners. *Environ. Sci. Technol.*, 18(6):457-459.

PART 5

LM FOOD CHAIN

Chapter 8. Model Application

The fish bioaccumulation models provide a dynamic linkage between polychlorinated biphenyl (PCB) levels in fish tissue and PCB concentrations in their exposure environment. They are valuable tools for helping us to obtain a quantitative understanding of the bioaccumulation and trophic transfer of PCBs in the lake. The bioaccumulation models can be applied to estimate PCB levels in the fish given the input of exposure concentrations in the water and surface sediment. Besides this common application, the models can also be used to derive estimates of PCB concentrations in the exposure environment based on observed fish PCB data. For example, fish bioaccumulation models have been applied, in conjunction with fate and transport models, to reconstruct the time history of contaminant concentrations in the environment (Gobas *et al.*, 1995; DePinto *et al.*, 2003).

In this chapter, the focus of model application is primarily on simulating future PCB levels in lake trout on the basis of projected exposure concentrations in sediment and overlying water that were provided by the LM2-Toxic model (see Part 4).

5.8.1 Simulation of Fish PCB Levels Based on Hypothetical Exposure Inputs

The food chain bioaccumulation model was developed as a component of an integrated series of the Lake Michigan Mass Balance models. One of the main objectives of the models was to evaluate the impact of PCB load reduction strategies on PCB concentrations in the Lake Michigan ecosystem.

Several PCB load reduction scenarios were selected for model analyses. The PCB concentrations in water and sediment associated with each of the load reduction scenarios were estimated by the LM2-Toxic model (Part 4, Chapter 6). These predicted future environmental concentrations provided a basis for estimating corresponding fish PCB levels using the fish bioaccumulation models.

5.8.1.1 Exposure Concentration Inputs Used for Model Simulations

Environmental concentrations are the most critical input when models are applied to deduce the resulting PCB levels in fish. It cannot be over-emphasized that it is exposure input data which “drive” the models because, to a first approximation, fish PCB levels are proportional to the concentrations in its exposure environment.

Site-specific PCB concentrations in water and sediment were provided by the LM2-Toxic model for the Saugatuck and Sturgeon Bay biota zones. Regional average PCB environmental concentrations were also provided for two large areas denoted as segment 2 and segment 3 in the LM2-Toxic model, respectively. Segment 2 is the southeastern part of Lake Michigan surrounding the Saugatuck biota zone, and segment 3 is the northwestern part of the lake surrounding the Sturgeon Bay biota zone (see Figure 4.3.1).

For each site, a total of seven hypothetical scenarios of long-term (1994-2055) PCB environmental concentrations were provided as exposure input to the food chain models. These were generated by the LM2-Toxic model as a quantitative prediction of

environmental concentrations under various PCB load reduction scenarios for the Lake Michigan ecosystem. As described in Part 4 (Chapter 6) of this document, the seven PCB load reduction scenarios were:

- A) Constant Conditions – The measured PCB loads (tributary load plus atmospheric dry and wet deposition) for the LMMBP period (1994-1995), but adjusted upward by a factor of 1.98. The adjusted loads followed the same spatial distribution and monthly variation patterns established by the LMMBP measured PCB loads. The adjusted loadings, the 1994-1995 vapor-phase concentration, Lake Huron boundary conditions, and all other forcing functions as observed in 1994 and 1995 were repeated throughout the simulation period. Sediment burial was active as well as all other model processes.
- B) Continued Recovery (Fast) – This was the same as Scenario “A”, but atmospheric components (vapor phase concentration, wet and dry deposition) declined with a six-year half-life (Hillery *et al.*, 1997; Schneider *et al.*, 2001), and tributary loads declined with a 13-year half-life (Endicott, 2005; Marti and Armstrong, 1990). The boundary conditions at the Straits of Mackinac declined at a rate of 0.17/year (a four-year half-life) (Schneider *et al.*, 2001). These rates were applied starting on January 1, 1996.
- C) Continued Recovery (Slow) – This was the same as Scenario “A”, but atmospheric components (vapor phase concentration, wet and dry deposition) declined with a 20-year half-life (Buehler *et al.*, 2002) and tributary loads declined with a 13-year half-life. The boundary conditions at the Straits of Mackinac declined with a four-year half-life. These rates applied starting on January 1, 1996.
- D) No Atmospheric Deposition – This was the same as Scenario “A”, but starting on January 1, 1996, the atmospheric loads (dry and wet deposition) were set to zero. All other forcing functions as observed in the LMMBP period were repeated throughout the simulation period.
- E) No Tributary Loadings – This was the same as Scenario “A”, but starting on January 1, 1996, all tributary loads were set to zero. All other forcing functions as observed in the LMMBP period were repeated throughout the simulation period.
- F) Lakewide Sediment Cleanup – This was the same as Scenario “A”, but starting on January 1, 1996, the lake-wide sediment PCB concentration was instantaneously set to zero. All other sediment properties remained as existed prior to sediment clean-up. All other forcing functions as observed in the LMMBP period and processes were repeated throughout the simulation period.
- G) No Atmospheric Deposition and No Tributary Loadings – The loading cuts of Scenarios “D” and “E” were combined. All other forcing functions as observed in the LMMBP period were repeated throughout the simulation period.

Each of the seven long-term PCB concentration scenarios consisted of a set of congener-specific PCB concentrations in the water column and surface sediment as functions of time. As an example, some congener-specific PCB exposure concentration data for Sturgeon Bay corresponding to Scenario A (continuation of current PCB loading) are presented in Figures 5.8.1a and 5.8.1b) as provided by the water quality model (LM2-Toxic).

5.8.1.2 Responses of Fish Models to Different Exposure Inputs

The food web models calibrated for Saugatuck and Sturgeon Bay lake trout food webs were used for the modeling exercise in this chapter. The Saugatuck model was applied to simulate fish bioaccumulation in response to exposure concentrations for Saugatuck and segment 2. The Sturgeon Bay model was applied to simulate fish bioaccumulations in response to exposure concentrations for Sturgeon Bay and segment 3. We believe that these bioaccumulation models can reasonably represent PCB concentrations in fish as a function of exposure concentrations in water and sediment for the calibrated biota zones. For the large segments (two and three) beyond the sites for which the models were calibrated, the reliability of the models becomes uncertain.

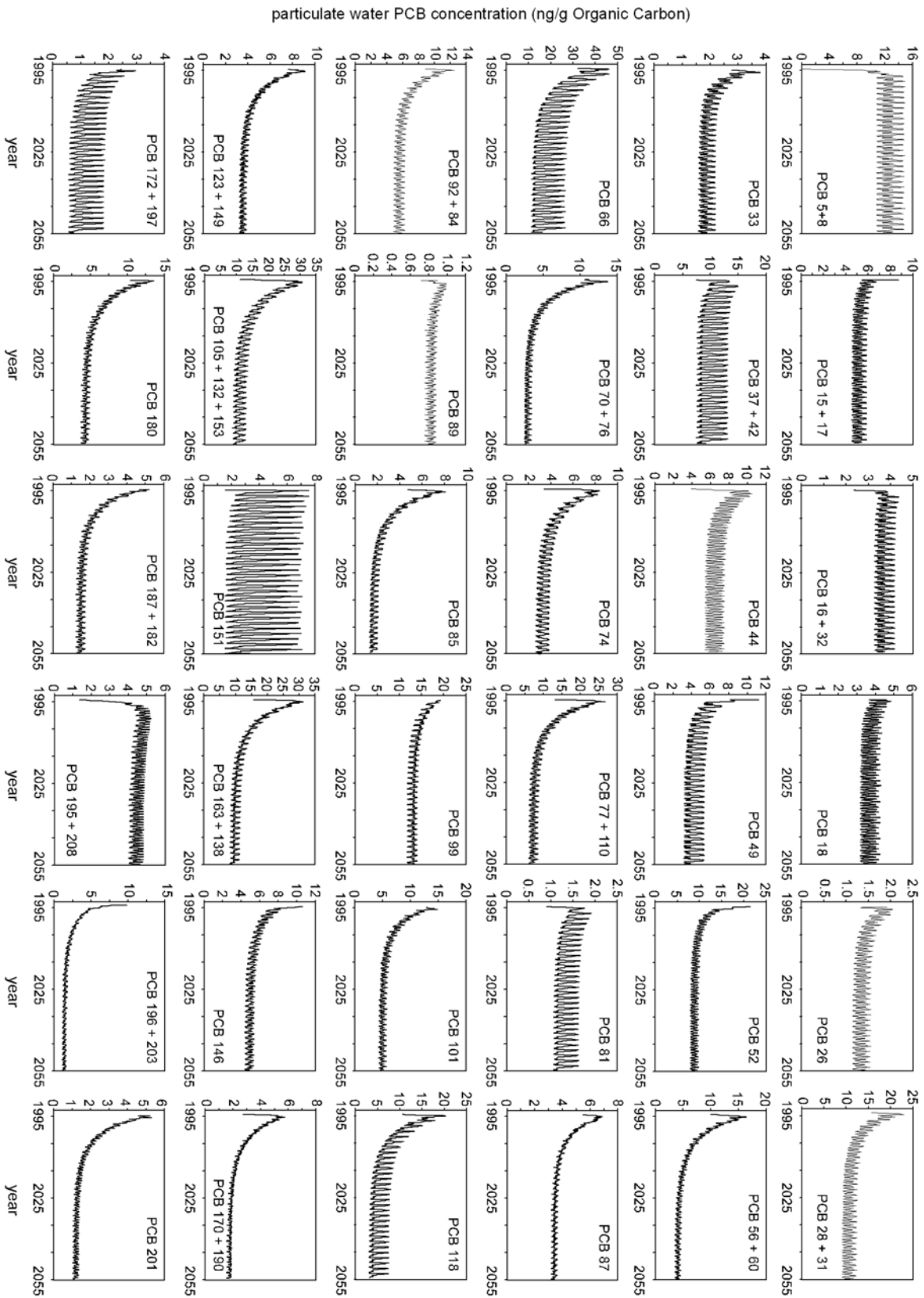

Figure 5.8.1a. PCB congener-specific exposure concentrations at Sturgeon Bay predicted by LM2-Toxic for Scenario A – PCBs in suspended particles of the water column.

sediment PCB concentration (ng/g Organic Carbon)

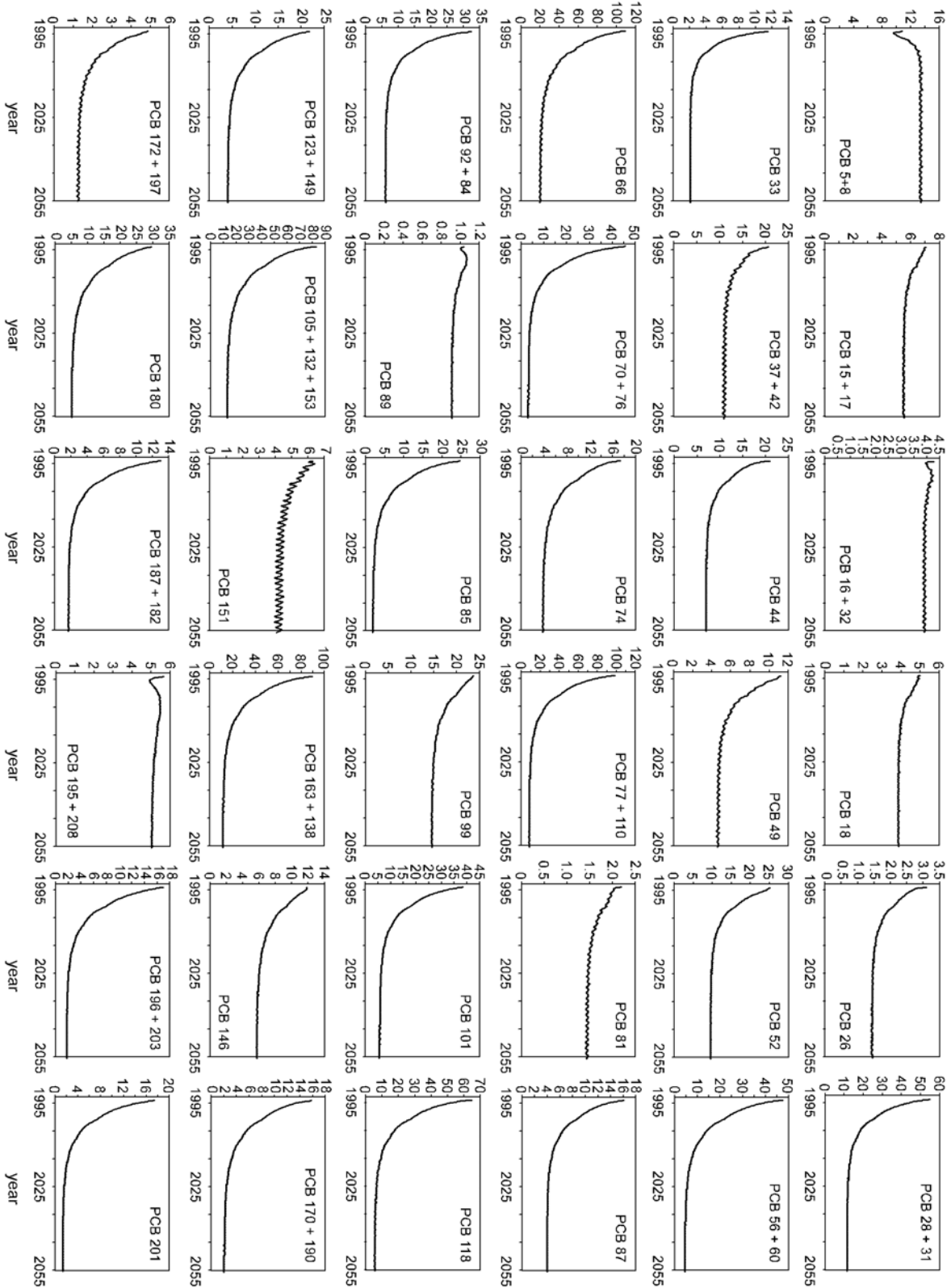

Figure 5.8.1b. PCB congener-specific exposure concentrations at Sturgeon Bay predicted by LM2-Toxic for Scenario A – PCBs in the surface sediment.

The extrapolative applications of the calibrated models to segments 2 and 3 were carried out on assumptions that the average environmental concentrations in large segments were good representations of the exposure conditions for fish in the segments, and that the food web structures used in the models were still representative beyond the specific biota zones.

However, caution should be taken while interpreting these model outputs because assumptions may or may not be valid. For example, there is evidence that lake trout are usually congregated in nearshore areas (Rybacki and Keller, 1978; Schmalz *et al.*, 2002). This implies that lake trout caught in any area of Lake Michigan may have actually spent a large portion of their living history in nearshore areas and were exposed to PCB concentrations found there. Therefore, interpretation of the segment-specific fish model results need to take the actual home range of fish into consideration.

A fundamental assumption of the fish model application is that the food web structure, related biological parameters (such as growth and consumption rates for each species) and environmental elements (such as annual temperature) will remain the same over the entire time period of the model simulations. Aside from this assumption, the reliability of the fish model estimates is primarily dependent on the quality of model inputs for PCB concentrations in water and sediment (see Part 4, Chapter 6).

Fish model simulations were initiated with the assumption that PCBs in fish at day zero of the model simulations (January 1, 1994) were at steady-state with the exposure concentration. The temporal trend of PCB concentrations in lake trout food web species were estimated in response to different hypothetical long-term exposure concentrations at Saugatuck and Sturgeon Bay, segment 2 and segment 3. The simulation results in terms of total PCBs in an adult lake trout (age 5.5) are presented in Figures 5.8.2 and 5.8.3.

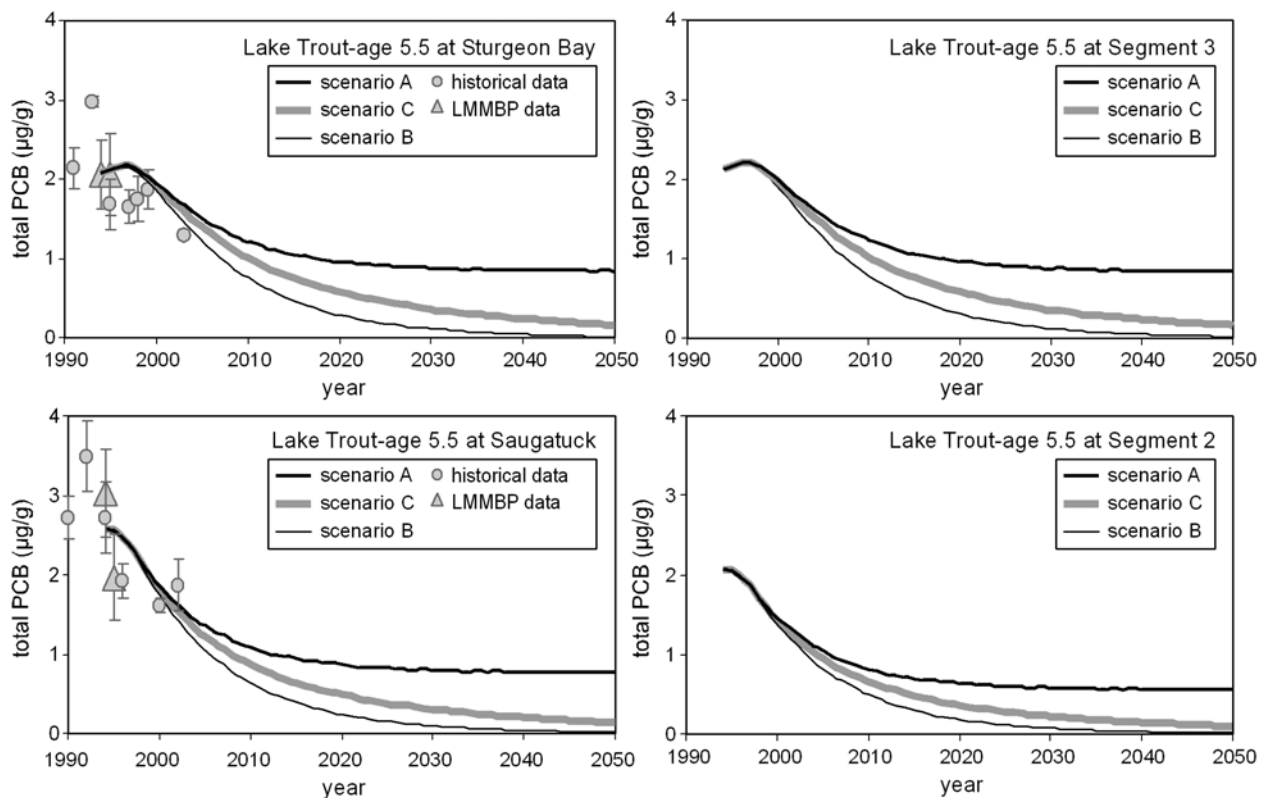

Figure 5.8.2. Total PCB concentrations of the lake trout in response to the exposure concentration inputs associated with various loading scenarios.

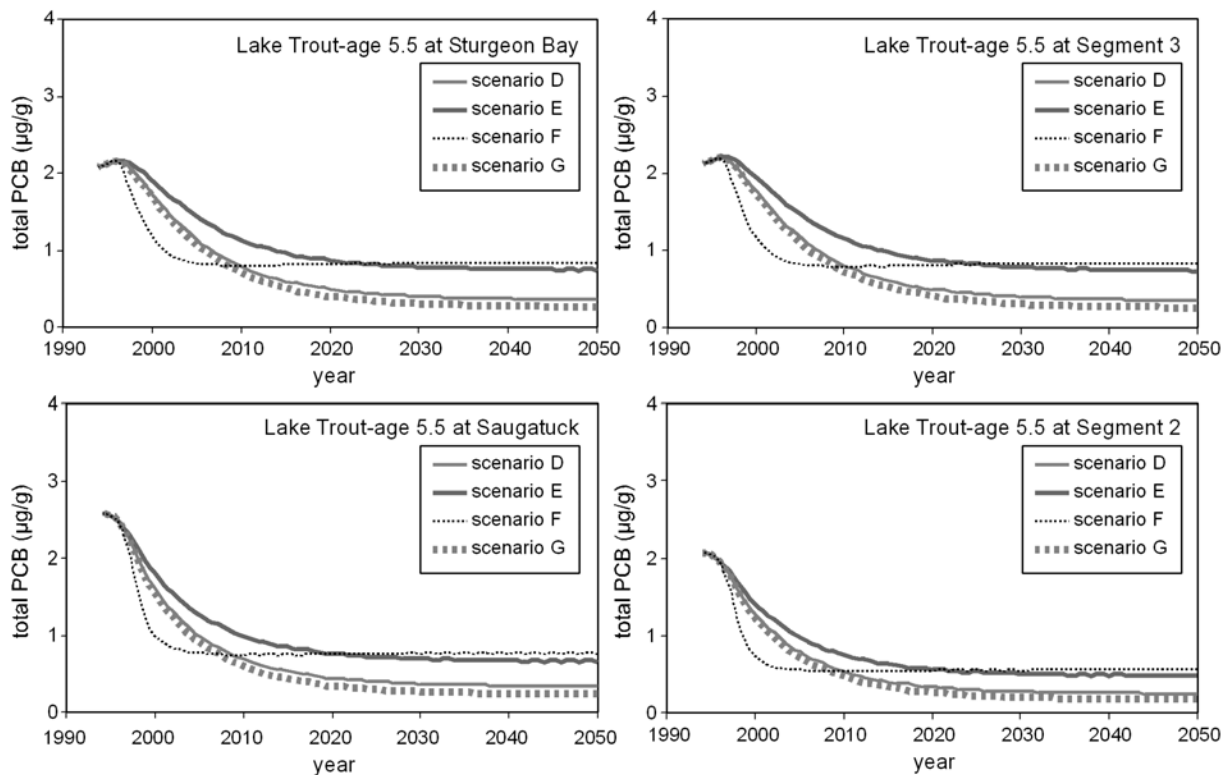

Figure 5.8.3. Total PCB concentrations of the lake trout in response to the exposure concentration inputs associated with various loading scenarios.

The model estimates of total PCB values were calculated based on the sum of fish model results for individual PCB congeners. The age 5.5 lake trout represents the average of five and six year-old lake trout and was selected for illustration because of the availability of long-term observed PCB data for the lake trout at similar ages. The observed total PCB data were also included in the figures for the Saugatuck and Sturgeon Bay biota zones.

The results show that the fish model simulations made for Sturgeon Bay and segment 3 have very similar outputs. This is because environmental exposure concentrations for these two sites were almost identical, and the model for these two sites used the same food web.

The results also show that the fish model outputs for Saugatuck and segment 2 were different. Because the model simulations for these two sites used the same food web structure, the difference can be

attributed to the different exposure concentrations used for their simulations.

The results further indicate that, under the same loading scenario, projected PCB levels in lake trout declined at a much faster rate at Saugatuck and segment 2 than at Sturgeon Bay and segment 3. The difference in rates of decline in fish PCB concentration was a result of similar declining trends in the PCB exposure concentrations used as input for fish model simulations.

Assuming exposure inputs from the LM2-Toxic model are reasonable depictions of future environmental PCB concentrations in Lake Michigan under different PCB load reduction scenarios, the fish models predicted that total PCB concentrations in age 5.5 lake trout will level off in response to constant external loading in 2040 (Scenario A) at all four sites. The estimated steady-state values of total PCB concentrations in lake trout are expected to be 0.84 µg/g-wet for Sturgeon Bay and segment 3, and 0.77

µg/g-wet and 0.56 µg/g-wet for Saugatuck and segment 2, respectively. The higher final value estimated for segment 3 (0.84 µg/g-wet) in comparison to segment 2 (0.56 µg/g-wet) is consistent with observations (LMMBP data) that the lake trout food web at Sturgeon Bay has a substantially higher bioaccumulation capacity than the one at Saugatuck.

Based on the exposure input data provided by the LM2-Toxic model, the fish models further suggested that for the fast recovery scenario (Scenario B), the targeted total PCB concentration for fish (0.075 ppm, see Appendix 3.4.1) would be achieved in about 2036 at Sturgeon Bay and segment 3, and 2033 and 2030 at Saugatuck and segment 2, respectively. All other PCB reduction scenarios do not achieve the targeted PCB levels in the lake trout within the time period of the model simulations (2055).

5.8.1.3 Discussion

It should be noted that the temporal trend of total PCBs in lake trout for each load scenario (Figures 5.8.2 and 5.8.3) was the result of combined contributions from the fish model results for individual PCB congeners. For each of the PCB congeners, the concentration temporal trend in the fish was largely a reflection of the time functions of the exposure concentrations for water and sediment, as shown in Figures 5.8.1a and 5.8.1b.

The temporal trends of total PCB concentrations in water and sediment for various PCB load scenarios were illustrated in Part 4 of this report (Figures 4.6.3 and 4.6.5). These lake-wide average data are a good representation of the site-specific environmental total PCB concentrations used for the food web bioaccumulation model simulations.

As expected, the model results illustrate that future PCB levels in fish are closely related to the projected environmental concentrations. For example, the total PCB concentrations in age 5.5 lake trout associated with the Scenario B (Fast Continued Recovery) are the lowest of all scenarios at the end of the model simulation (Figure 5.8.2). This result is similar to that for the modeled total PCB concentrations in water and sediment (Figures 4.6.3 and 4.6.5).

Similarly, the dramatic decline at the early stage of the model simulation in fish PCB levels associated with the Scenario F (Sediment Cleanup) (Figure 5.8.3) is the result of the parallel trends in the total PCB concentrations for water and sediment (Figures 4.6.3 and 4.6.5). Among the PCB load reduction scenarios, the sediment cleanup scenario appears to have the most immediate impact on PCB concentrations in water and sediment and consequently on PCB levels in the fish.

For the total PCB concentrations in the fish at the Sturgeon Bay and Saugatuck biota zones, the model generated temporal trends for all scenarios appears to be in line with the expected trend inferred from the field data. Comparing Scenarios B and C, the Continued Recovery (Fast) (Scenario B) appears to fit the field data better at both locations. Additional field data are needed to confirm this observation.

It should be emphasized that the model results are the product of the model, its structure, and the assumptions made. Because the results of fish bioaccumulation models are highly dependent on exposure concentrations, the model results should be interpreted in light of uncertainty in the exposure predictions (Part 4, Chapter 6).

References

- DePinto, J.V., W.M. Larson, J. Kaur, and J. Atkinson. 2003. LOTOX2 Model Documentation - In Support of Development of Load Reduction Strategies and a TMDL for PCBs in Lake Ontario. Submitted to New England Interstate Water Pollution Control Commission, Boott Mills South, Lowell, Massachusetts. 122 pp.
- DeVault, D.S., W.A. Willford, R.J. Hesselberg, D.A. Nortrupt, E.G.S. Roundberg, A.K. Alwan, and C. Bautista. 1986. Contaminant Trends in Lake Trout (*Salvelinus namaycush*) From the Upper Great Lakes. Arch. Environ. Contam. Toxicol., 15(4):349-356.
- Gobas, F.A.P.C., M.N. Z'Graggen, and X. Zhang. 1995. Time Response of the Lake Ontario Ecosystem to Virtual Elimination of PCBs. Environ. Sci. Technol., 29(8):2038-2046.

-
- Golden, K.A., C.S. Wong, J.D. Jeremiason, S.J. Eisenreich, G. Sanders, J. Hallgren, D.L. Swackhamer, D.R. Engstrom, and D.T. Long. 1993. Accumulation and Preliminary Inventory of Organochlorines in Great Lakes Sediments. *Water Sci. Technol.*, 29(8-9):19-31.
- Rybicki, R.W. and M. Keller. 1978. The Lake Trout Resource in Michigan Waters of Lake Michigan, 1970-1976. Michigan Department of Natural Resources, Lansing, Michigan. Fisheries Research Report Number 1863.
- Schmalz, P.J., M.J. Hansen, M.E. Holey, P.C. McKee, and M.L. Toney. 2002. Lake Trout Movements in Northwestern Lake Michigan. *North Amer. J. Fish. Mgt.*, 22(3):737-749.
- Schneider, A.R., H.M. Stapleton, J. Cornwell, and J.E. Baker. 2001. Recent Declines in PAH, PCB, and Toxaphene Levels in the Northern Great Lakes as Determined from High Resolution Sediment Cores. *Environ. Sci. Technol.*, 35(19):3809-3815.

PART 6

COMPARISON OF MODEL RESULTS

Timothy J. Feist
Welso Federal Services, LLC
and
Kenneth R. Rygwelski
U.S. Environmental Protection Agency
Office of Research and Development
National Health and Environmental Effects Research Laboratory
Mid-Continent Ecology Division
Large Lakes and Rivers Forecasting Research Branch
Large Lakes Research Station
9311 Groh Road
Grosse Ile, Michigan 48138

6.1. Summary

Three levels of models were used or developed during the Lake Michigan Mass Balance Project (LMMBP). The toxic fate and transport/bioaccumulation portion of the project included a previously-developed model (MICHTOX) for the coarse scale Level 1 and newly-developed models (LM2-Toxic and LM Food Chain) for the middle resolution Level 2. MICHTOX was used to assist in the development of the sampling program and to provide a screening-level assessment of the polychlorinated biphenyl (PCB) data. The LM2-Toxic and LM Food Chain models (LM models) were developed during the LMMBP as part of a suite of integrated mass balance models. While similar in function, the Level 1 and Level 2 models had different development histories and capabilities, and a comparison of model results was useful to evaluate suitability for potential future uses. This chapter provides an examination of the similarities and differences between the models and compares the

results of scenario predictions from both sets of models.

The LM models provided a higher resolution evaluation of PCB dynamics on a spatial, chemical, and biological scale than MICHTOX. The higher resolution of the LM models included hydrodynamically modeled water transport, smaller water quality segments, congener versus homolog-level modeling, and a more detailed, data-based food web structure. While both sets of models used similar kinetics and forcing functions, the LM models were more fully calibrated to process data that were not available during the earlier development of the MICHTOX model. The higher resolution and more thorough calibration should allow the LM models to provide better representation of system processes and better predictions of the effects of future loading changes. These features of the LM models should also allow them to be used with minimal re-calibration for modeling localized areas of the lake that may have different congener composition, carbon production, or lake trout diets.

The comparison of model results demonstrated that, while differences in model parameterization resulted in different flux rates for important processes in PCB cycling in Lake Michigan, the annual net changes in water column concentrations were similar. The different flux rates resulted in different steady-state concentration predictions under a hypothetical constant loading condition scenario. However, under a scenario with declining loading trends based on scientific literature, predicted concentrations in water and fish from both sets of models converged and the rate of decline was more important to the model results than differences in model parameterization.

6.2 Comparison of Models

The LMMBP included three levels of models (Figure 6.1). For the PCB contaminant evaluation, MICHTOX represented the simpler, coarse resolution models. MICHTOX is comprised of two submodels: a toxics fate and transport submodel, and a food chain bioaccumulation submodel. LM2-Toxic and LM Food Chain (LM models) represented the higher resolution Level 2 models. This section discusses the similarities and differences in the models.

6.2.1 Model Similarities

The toxics models were similar in a number of ways. The MICHTOX fate and transport submodel and the LM2-Toxic model were both based upon the United States Environmental Protection Agency (USEPA) WASP4 toxics model (Ambrose *et al.*, 1988) and used similar approaches for modeling toxic fate and transport. While MICHTOX still possessed the general structure of WASP4, the LM2-Toxic computer code was completely new. MICHTOX and LM2-Toxic contained similar kinetics and mass transport functions. Both models included advection, dispersion, diffusion, settling and resuspension of toxics bound to particles, and deep sediment burial. The air/water exchange functions were also similar in the models. Both models used the 1994-1995 LMMBP data to develop forcing functions for tributary loads, atmospheric deposition, and atmospheric vapor concentrations, although LM2-Toxic simulated individual PCB congeners while MICHTOX simulated total PCBs divided into two homologs.

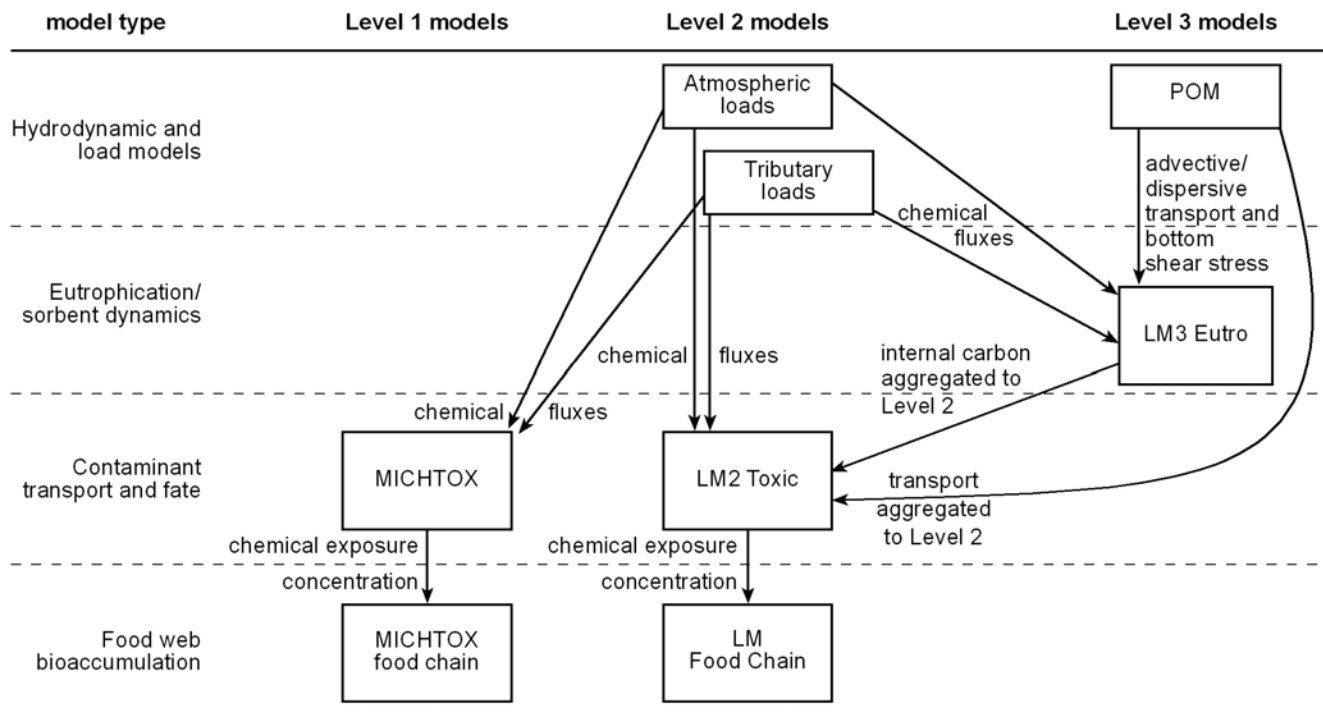

Figure 6.1. Supporting models and links for MICHTOX and the LM models.

The food chain bioaccumulation models were also conceptually similar. The MICHTOX food chain submodel and the LM Food Chain model were both based upon the concept of mass conservation and used similar kinetic processes, including uptake, elimination, and concentration reduction through growth. Both models used the LMMBP data set for estimates of fish and invertebrate weight, growth, and initial concentrations.

6.2.2 Model Differences

The primary differences in the models involved the level of resolution and the degree of calibration. The LM models provided a higher resolution evaluation of PCB dynamics with regard to spatial scales, hydrodynamic scales, kinetic processes, PCB forms, and biological components. The LM models were also rigorously calibrated using extensive field and process data, while MICHTOX was developed at a time when few PCB data were available.

LM2-Toxic was developed using a higher resolution spatial grid than MICHTOX; this provided a more accurate representation of spatially-dependent processes and of the effects of spatial variability in loads and concentrations. The LM2-Toxic water quality grid was composed of five vertical segments and 41 total water segments (Figure 4.3.1), while the MICHTOX grid used two vertical segments and nine total water segments (Figure 3.3.2). LM2-Toxic was also much more highly resolved in sediment segments having 53 sediment segments divided into non-depositional, transitional, and depositional zones (Figure 4.3.2). MICHTOX used six sediment segments (Figure 3.3.2), with the area of the segments adjusted to represent sediment focusing of contaminants.

The hydrodynamic processes in the models also used different resolutions. LM2-Toxic used hydrodynamic predictions from the fine-scaled (44,042 cell) Great Lakes version of the Princeton Ocean Model (GL-POM) aggregated to the 41-segment LM2-Toxic grid. Horizontal and vertical flows were obtained from the GL-POM hydrodynamic model and dispersion coefficients from the temperature model (see Section 4.5.1 in Part 4, Chapter 5 for details). MICHTOX used externally-specified estimates of advective and dispersive exchanges between its nine segments.

The LM models also contained higher resolution water quality kinetics and PCB forms. They simulated over 30 state variables (34 in LM2-Toxic, 40 in LM-Food Chain) representing PCB congeners or co-eluting congeners. MICHTOX modeled total PCBs in water, sediment, and the food web as two homologs. LM2-Toxic contained three carbon classes for partitioning of toxics: biotic carbon (BIC), particulate detrital carbon (PDC), and dissolved organic carbon (DOC). MICHTOX used a single solids class with a seasonally-specified fraction of organic carbon along with DOC. LM2-Toxic used dynamic phytoplankton carbon production loads estimated using the LM3-Eutro model, while MICHTOX carbon loads were based upon a steady-state solids balance and seasonal organic carbon fraction calculated from historical data.

In addition to containing more detail in PCB state variables, LM Food Chain was more detailed in its representation of the food chain than the MICHTOX food chain submodel. The LM Food Chain model was based on the LMMBP data and included phytoplankton, three invertebrates, and six fish species. The MICHTOX food chain submodel used an idealized food chain that included phytoplankton, two invertebrates, and two fish species.

The models also differ in the degree of calibration applied to them. LM2-Toxic and LM Food Chain were thoroughly calibrated to the LMMBP data set, and the LM2-Toxic was confirmed against a sediment core derived PCB hindcast loading estimate. In addition, the LM models had process data available to reduce degrees of freedom during calibration, such as particulate settling velocities, sediment mixing zone thicknesses, and complete fish diet data. MICHTOX was never fully calibrated against a PCB data set. It was calibrated to solids transport and plutonium data, validated to the small amount of PCB data available when the model was originally developed, and later compared to three hypothetical hindcast loading scenarios and the LMMBP data set (Endicott *et al.*, 2005; Endicott, 2005). At the time of development of MICHTOX, there were little process data available against which to constrain the model parameterization.

6.3 Comparison of Model Results

6.3.1 Comparison of Mass Budget Analyses

Mass budget analyses were conducted for PCB simulation results for the 1994-1995 LMMBP sampling period from both the MICHTOX fate and transport submodel and LM2-Toxic (Part 3, Chapter 3, Section 3.3.3.3 and Part 4, Chapter 6, Section 4.6.2). For this and the following comparisons, results from the LM models for individual congeners were summed and then converted to total PCB concentrations (Part 4, Chapter 6, Section 4.6.1) for comparison with results from the MICHTOX model.

There were a number of similarities in the results from both models. They both demonstrated a net loss of PCBs from the system. The net loss was calculated as the sum of fluxes out of the system minus the sum of fluxes into the system, or (sediment burial + gross volatilization + export to Lake Huron + Chicago diversion) - (tributary loads + atmospheric deposition + gas absorption + input from Lake Huron). Predicted net losses from the system were 2,673 kg/year for MICHTOX and 1,863 kg/year for the LM2-Toxic. The net loss from the system means that, under measured 1994-1995 loads, the system was not at steady-state and observed concentrations would decline. For the water column only, predicted net losses of total PCBs were similar for both models: 182 kg/year for MICHTOX and 159 kg/year for LM2-Toxic.

Both models show that gross volatilization, gas absorption, resuspension, and settling are significant mass transfer rate processes in the Lake Michigan system (Figure 6.2). Net volatilization of PCBs was the largest flux process. Resuspension of PCBs was greater than settling for both models, which means there was a net movement of PCBs from the sediment to the water column. Export of PCBs to Lake Huron or through the Chicago diversion was negligible, and was not shown on Figure 6.2.

The results in Figure 6.2 highlight the differences in parameterization of the models. PCB resuspension and settling fluxes were much greater for MICHTOX than for LM2-Toxic. Volatilization and gas absorption fluxes were also higher in MICHTOX. MICHTOX was

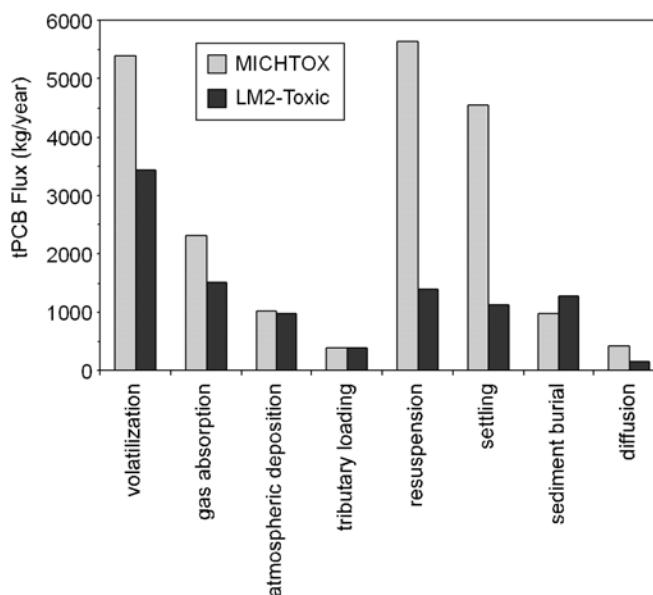

Figure 6.2. Comparison of the Lake Michigan total PCB mass balance analyses results, 1994-1995.

predicting more PCBs moving from the sediment to the water column than LM2-Toxic through net resuspension and diffusion, but was also removing more PCBs from the water column through net volatilization. This resulted in the net change in PCB mass in the water column being similar between the models. Net resuspension fluxes and diffusion in MICHTOX were as large of a PCB source to the water column as the external loads. They were less than a third of the external loads for the LM2-Toxic. LM2-Toxic has a greater sediment burial loss from the system, but the magnitude is small compared to net volatilization losses.

6.3.2 Comparison of Model Forecast Scenarios

Results for the model forecast scenarios were compared from both the fate and transport models and the food chain/bioaccumulation models. For comparison purposes, the LM2-Toxic segment results were volume-weighted and averaged to match the MICHTOX segmentation. The bioaccumulation model results provided only an approximate comparison between models because the MICHTOX food chain submodel lake trout concentrations were modeled on a segment-wide

basis and the LM Food Chain results were for the biota boxes used for model calibration.

A comparison of the Constant Conditions Scenario results showed that MICHTOX predicted lower concentrations in the epilimnion than LM2-Toxic (Figure 6.3). This agreed with the model comparison to 1994-1995 data in which MICHTOX underpredicted epilimnion concentrations (Part 4, Chapter 3). The models contained the same general processes and used the same forcing functions, therefore, differences in predicted concentrations were primarily due to model parameterization and resolution differences. For the southern Lake Michigan model segments, hypolimnetic concentrations reached comparable concentrations at steady-state even though MICHTOX had higher annual average concentrations initially. While both models used the same initial conditions, MICHTOX had higher sediment PCB resuspension rates which resulted in the higher initial annual average

hypolimnetic water column concentrations shown on the plot. For the central Lake Michigan hypolimnetic segments, MICHTOX predicted lower concentrations than LM2-Toxic.

Sediment concentration predictions were slightly higher for MICHTOX than for the LM2-Toxic model (Figure 6.4). The initial sediment concentrations on a ng/L basis were significantly different between the models. While both models used initial conditions based upon measured 1994-1995 PCB concentrations (ng PCB/g sediment), LM2-Toxic also used measured porosity from the 1994-1995 data while MICHTOX used the same porosity and sediment density used during the initial model development.

The water concentration results from the Continued Recovery – Fast Scenario were also compared (Figure 6.5). For both sections of Lake Michigan,

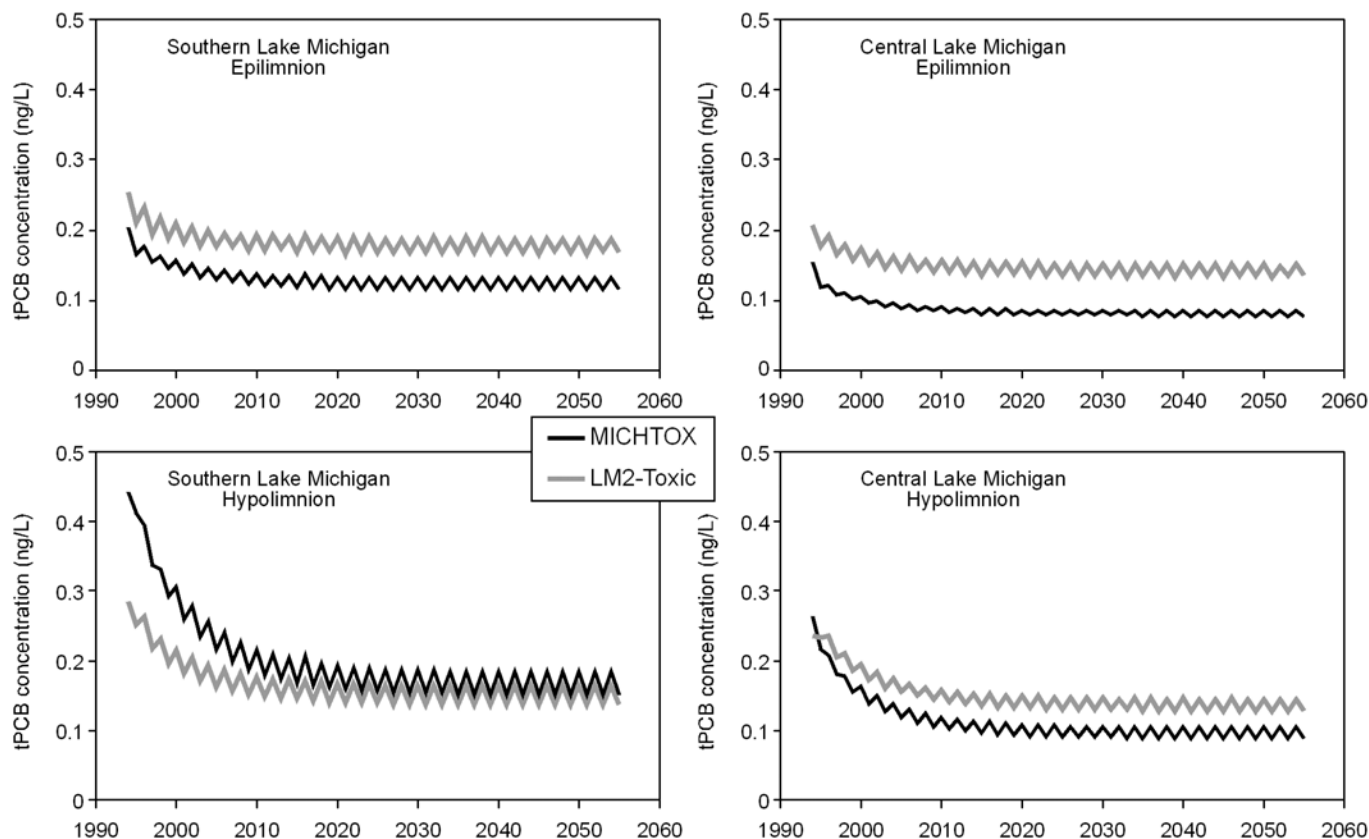

Figure 6.3. Comparison of model output annual average total PCB water concentrations for the Constant Conditions Scenario.

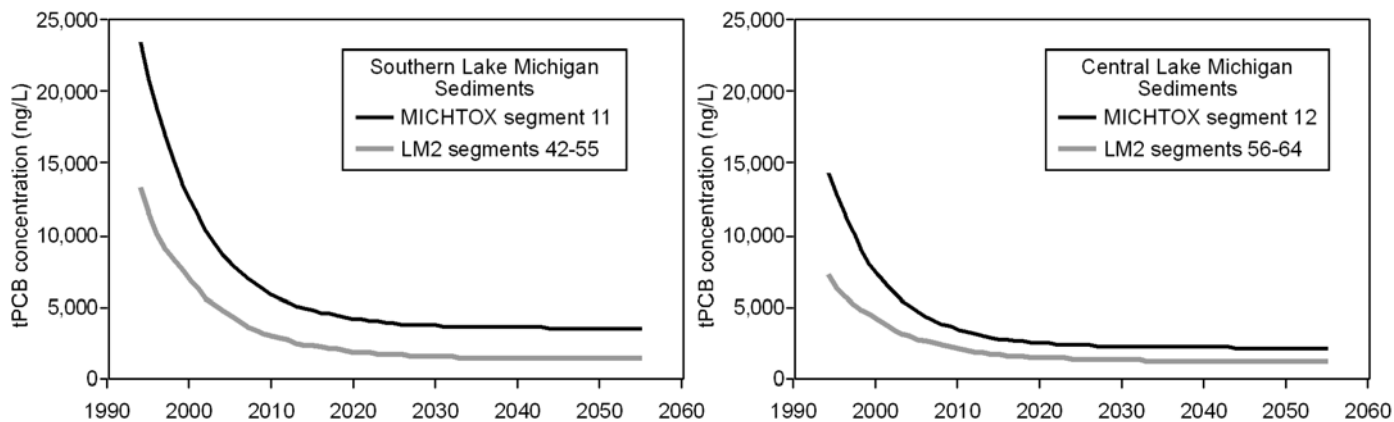

Figure 6.4. Comparison of model output annual average total PCB sediment concentrations for the Constant Conditions Scenario.

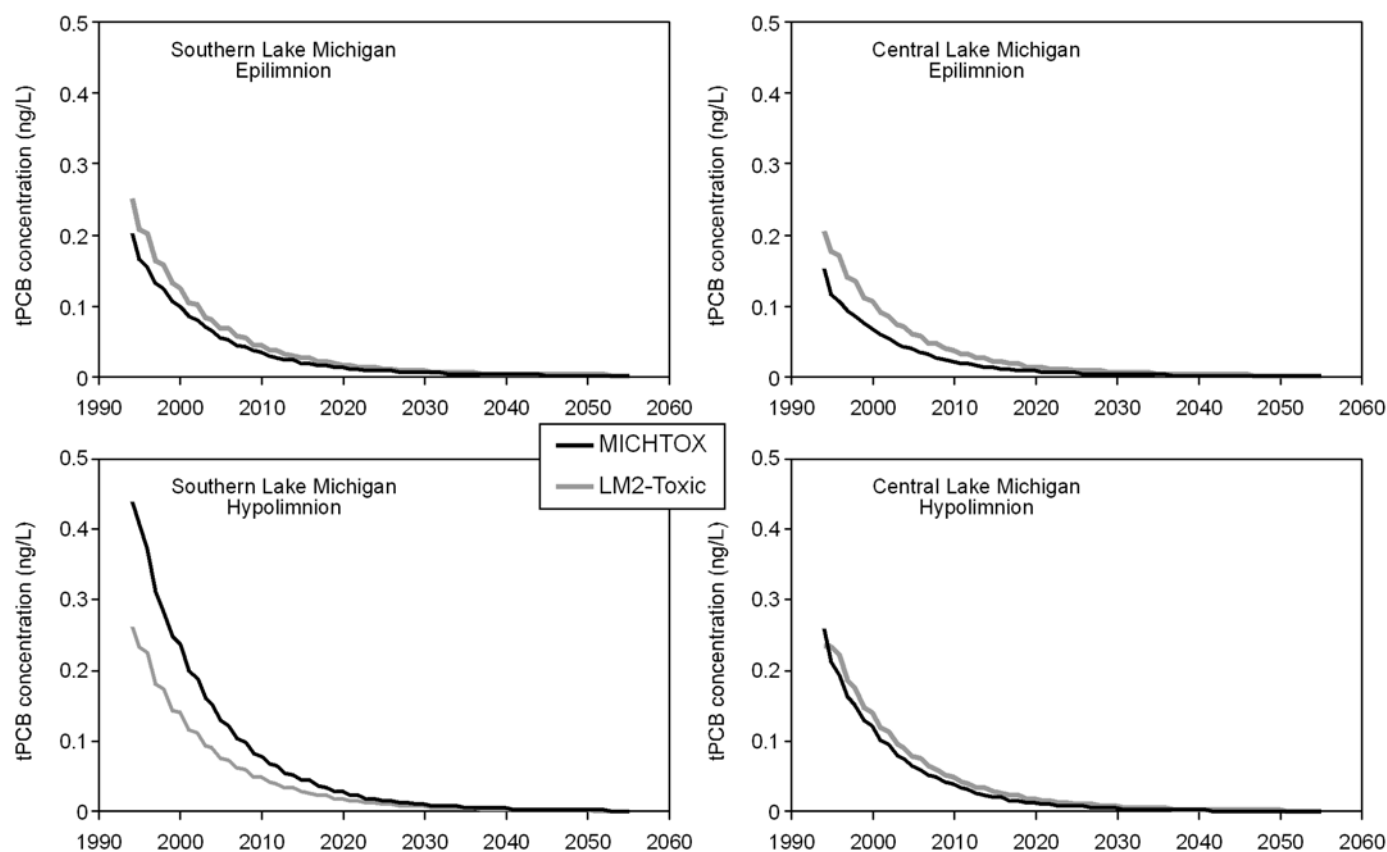

Figure 6.5. Comparison of model output annual average total PCB water concentrations for the Continued Recovery – Fast Scenario.

the model predictions converged over time to low concentrations. In the Constant Conditions Scenario results, differences in model parameterization resulted in differences in long-term predicted concentrations. For scenarios in which the external forcing functions declined over time, the differences in predicted concentrations were still present, but the magnitude of the difference was small compared to the overall decline in concentrations. Thus for long-term predictions, the rate of decline was more influential than differences between the model parameters.

The bioaccumulation models were also compared for the Constant Conditions Scenario and the Continued Recovery – Fast Scenario. For the Constant Conditions Scenario, MICHTOX predicted lower total PCB concentrations than LM Food Chain in the 5-6 year-old lake trout at both locations (Figure 6.6). The predicted concentration differences were larger for the central Lake Michigan/Sturgeon Bay results than the southern Lake Michigan/Saugatuck results. Differences in lake trout concentrations predicted by the models were a function of both the exposure concentrations predicted by the water quality models and factors affecting bioaccumulation in the food chain models.

The results from the bioaccumulation models for the Continued Recovery – Fast Scenario (Figure 6.7)

were similar to the results from the fate and transport models. PCB concentrations declined over time to low concentrations, with the difference in predicted concentrations between the models becoming smaller over time. For Saugatuck, the LM Food Chain model predicted that the 0.075 µg/g lake trout PCB concentration target would be achieved in 2033, and the MICHTOX food chain submodel predicted it would be achieved in 2025. For Sturgeon Bay, the LM Food Chain predicted a much slower decline than the MICHTOX food chain submodel, with the target being reached in 2036 and 2018, respectively. The difference in time required to achieve the target concentration was primarily due to the delay in the start of the concentration decline in the LM Food Chain predictions.

References

Ambrose, R.B., T.A. Wool, J.P. Connolly, and R.W. Schanz. 1988. WASP4, a Hydrodynamic and Water Quality Model - Model Theory, User's Manual and Programmer's Guide. U.S. Environmental Protection Agency, Office of Research and Development, Environmental Research Laboratory, Athens, Georgia. EPA/600/3-87/039, 297 pp.

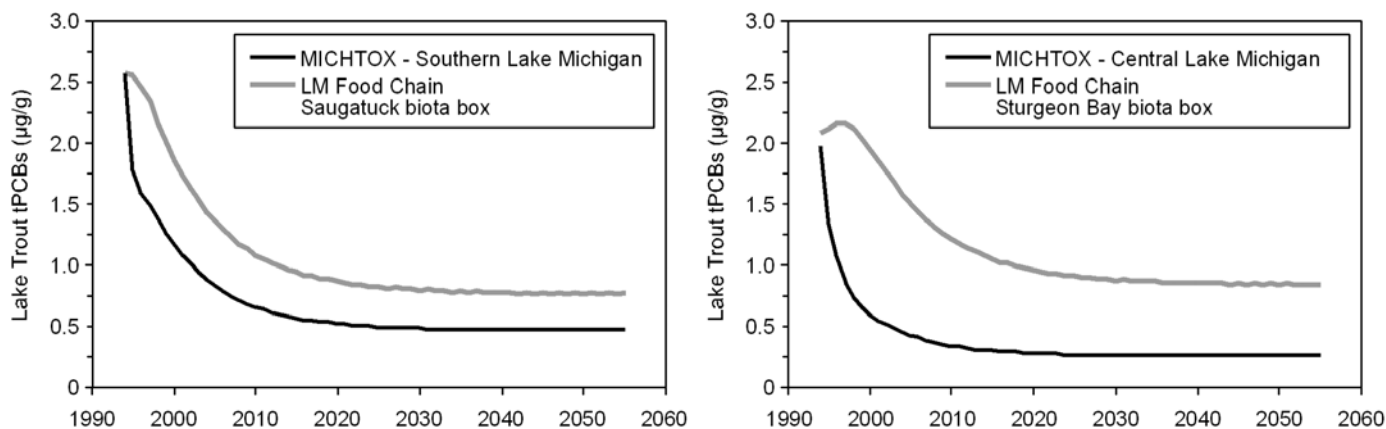

Figure 6.6. Comparison of the bioaccumulation model annual average total PCB concentration results for the Constant Conditions Scenario.

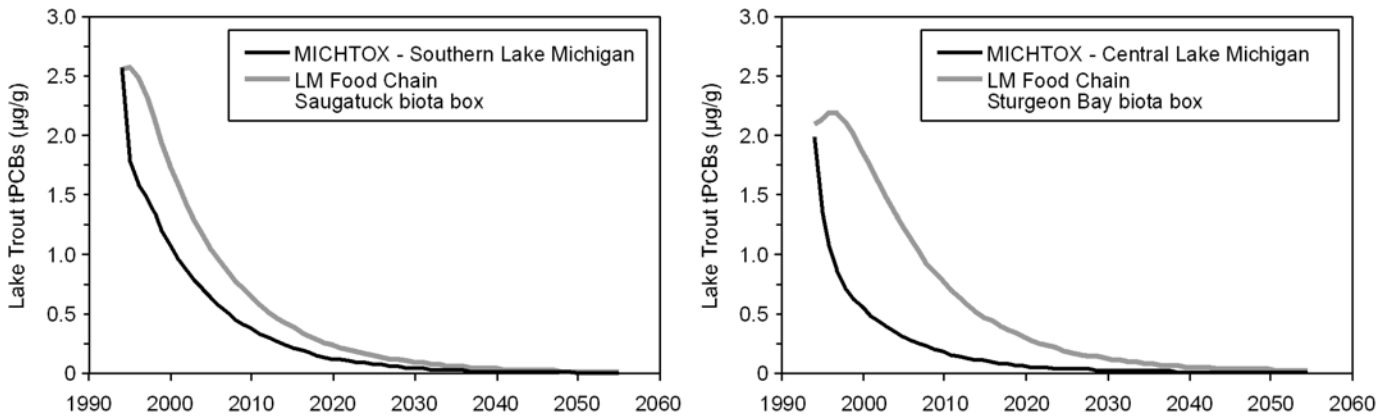

Figure 6.7. Comparison of the bioaccumulation model annual average total PCB concentration results for the Continued Recovery – Fast Scenario.

Endicott, D.D. 2005. 2002 Lake Michigan Mass Balance Project: Modeling Total PCBs Using the MICHTOX Model. In: R. Rossmann (Ed.), MICHTOX: A Mass Balance and Bioaccumulation Model for Toxic Chemicals in Lake Michigan, Part 2. U.S. Environmental Protection Agency, Office of Research and Development, National Health and Environmental Effects Research Laboratory, MED-Duluth, Large Lakes Research Station, Grosse Ile, Michigan. EPA/600/R-05/158, 140 pp.

Endicott, D.D., W.L. Richardson, and D.J. Kandt. 2005. 1992 MICHTOX: A Mass Balance and Bioaccumulation Model for Toxic Chemicals in Lake Michigan. In: R. Rossmann (Ed.), MICHTOX: A Mass Balance and Bioaccumulation Model for Toxic Chemicals in Lake Michigan, Part 1. U.S. Environmental Protection Agency, Office of Research and Development, National Health and Environmental Effects Research Laboratory, MED-Duluth, Large Lakes Research Station, Grosse Ile, Michigan. EPA/600/R-05/158, 140 pp.

PART 7

APPENDICES

Appendix 7.1 Lake Michigan Mass Balance Project (LMMBP) PCB Peer Review Report

Kenneth R. Rygwelski
U.S. Environmental Protection Agency
Office of Research and Development
National Health and Environmental Effects
Research Laboratory
Mid-Continent Ecology Division
Large Lakes and Rivers Forecasting Research
Branch
Large Lakes Research Station
9311 Groh Road
Grosse Ile, Michigan 48138

7.1.1 Executive Summary

The United States Environmental Protection Agency (USEPA), National Health and Environmental Effects Laboratory (NHEERL), Mid-Continent Ecology Division at Grosse Ile, Michigan in cooperation with the USEPA Great Lakes National Program Office (GLNPO), conducted a polychlorinated biphenyl (PCB) transport and fate mass balance modeling study of PCBs in Lake Michigan to determine strategies for managing and remediating this toxic chemical in the lake basin. Some specific programs that this effort support include the Lake Michigan Lake-wide Management Plan (LaMP) and the Great Lakes Water Quality Agreement (GLWQA). Within the ecosystem approach, the Lake Michigan Mass Balance Project (LMMBP) models account for the sources, sinks, transport, fate, and food chain bioaccumulation of PCBs. The calibrated models offer an opportunity for running various PCB load

reduction scenarios to get an insight on the effects to the lake ecosystem. Model forecasting of PCB concentrations in lake trout is one of the primary endpoints of the investigation as it relates to both ecosystem and human health. In addition, demonstration of a whole lake Total Maximum Daily Load (TMDL) process to yield a desired target PCB concentrations in lake trout has been achieved. A significant factor that differentiates this study from other PCB transport and fate modeling projects is that PCBs were modeled as single PCB congeners to predict total PCBs. Also, a high-resolution hydrodynamic model was applied and a eutrophication model was used to generate the primary productivity solids in this system where autochthonous solids production is significant and plays an important role in describing PCB transport. Mass balance estimates indicate that the lake system is losing approximately 2,000 kg/year of PCBs. Also, the bioaccumulation model predicts that the target level for unrestricted consumption in lake trout (0.075 ppm for whole fish) was forecasted to be achieved for five to six year-old lake trout between the years 2025 and 2035.

The main sampling activity for the project was conducted in 1994 through 1995; however, a PCB screening-level model called MICHTOX was developed and running PCB simulations before the LMMBP began. This model was developed to gain an initial insight into the PCB transport and fate in Lake Michigan including its biota. Later on, the MICHTOX model was run again using the newer data collected from the LMMBP. The more advanced PCB and support models included a hydrodynamic model called Princeton Ocean Model (POM), a eutrophication model called LM3-Eutro, and a 41

segment PCB model called LM2-Toxic. The output from the LM2-Toxic was used to define the exposure concentration for the bioaccumulation model called LM-Food Chain. Development of a high resolution PCB model (LM3-Toxic) is proceeding, and is discussed in the Modelers' Comments section.

On July 27 - 28, 2004, peer reviewers representing modelers in academia, research, and the USEPA, convened at the Crowne Plaza Hotel in Romulus, Michigan to review the LMMBP PCB models (Figure 1). Prior to this review, a June 2004 draft copy of "Results of the Lake Michigan Mass Balance Project: PCBs Modeling Report" prepared by the Large Lakes and Rivers Forecasting Research Branch, Mid-Continent Ecology Division, NHEERL, Office of Research and Development (ORD), USEPA at Grosse Ile, Michigan was provided to each of the peer reviewers. In general, the review panel agrees that the model construct (spatial, temporal, process resolution) and application is consistent with the problem definition for which the model was developed and for the available resources. In addition to providing a comprehensive review of the model, the panel also provided detailed suggestions for future model improvements. Most of the panel's comments were captured at the meeting and are identified as "consensus" comments. James Martin provided additional post-meeting comments (see Section 7.1.5), and the modelers' responses to his questions follow the responses to the consensus comment section. In addressing the review comments, we had to carefully consider where to apply available resources and prioritize actions that help to ensure model integrity. Hopefully our responses reflect this balance. Responses identify actions that have been taken, are on-going, or will be conducted in the future. The USEPA wishes to thank the panel for their willingness to participate in this review and for their constructive comments.

7.1.2 LMMBP Peer Review Panel

Robert B. Ambrose, Jr., P.E.
Environmental Engineer
Ecosystems Research Division
National Exposure Research Laboratory
U.S. Environmental Protection Agency
Office of Research and Development
960 College Station Rd.
Athens, Georgia 30605

Voice: 706-355-8229; Fax: 706-355-8104
ambrose.robert@epa.gov

Joel E. Baker, Ph.D.
Professor
Chesapeake Biological Laboratory
P.O. Box 38
2108 Fowler Laboratory
University of Maryland
1 Williams Street
Solomons, Maryland 20688-0038
Voice: 410-326-7205
baker@cbl.umces.edu

Ken Drouillard, Ph.D.
Assistant Professor
Great Lakes Institute for Environmental Research
Biological Sciences Department
401 Sunset Avenue
Windsor, Ontario Canada N9B 3P4
Voice: 519-253-3000 Ext. 4744
kgd@uwindsor.ca

Barry Lesht, Ph.D.
Department of Energy, Acting Director of
Environmental Research Division
Argonne National Laboratory
9700 S. Cass Avenue
Argonne Illinois 60439
Voice: 630-252-4208 Fax: 630-252-2959
bmlesht@anl.gov

James L. Martin, Ph.D., P.E.
Professor and Kelly Gene Cook, Sr. Chair in Civil
Engineering
Department of Civil Engineering
Mississippi State University
P.O. Box 9546
222 Walker Engineering Building
Mississippi State, Mississippi 39762-9546
Voice: (662) 325-7194; Fax: (662) 325-7189
jmartin@enr.msstate.edu

7.1.3 LMMBP PCB Charge to Peer Reviewers

The members of the Peer Review Panel have been assembled by the USEPA GLNPO because they are experts in multimedia mass balance modeling and have expertise in one or more of the multimedia

Table 7.1.1. Agenda – Lake Michigan Mass Balance PCB Modeling Peer Review, Crowne Plaza Hotel, 8000 Merriman Road, Romulus, Michigan 48174 at Detroit Metropolitan Airport, Romulus, Michigan, July 27 and 28, 2004

Time	Tuesday's Agenda	Speaker
8:20 am	Welcome/Introductions and Project Goals/Objectives/Uses	P. Horvatin
8:40 am	Agenda Overviews/Previous Reviews	J. Keough
8:50 am	Charge to Peer Review Panel	G. Warren
9:00 am	PCB Background and History	R. Kreis
9:15 am	PCB QA Report	L. Blume
9:30 am	PCB Data Summary/Representativeness	R. Rossmann
9:45 am	Questions and Discussion	
10:00 am	Break	
10:15 am	Modeling Introduction/Overview	R.. Kreis
10:40 am	Atmospheric Load Modeling	D. Hornbuckle/J. DePinto
11:10 am	Questions and Discussions	
11:20 am	Tributary Load Modeling	D. Hall
11:50 am	Questions and Discussion	
12:00 pm	Lunch	
1:00 pm	MICHTOX Level 1 Modeling	D. Endicott
1:45 pm	Questions and Discussion	
2:00 pm	Hydrodynamic Modeling and POM to WASP Linkage	D. Beletsky
2:30 pm	Questions and Discussion	
2:45 pm	Break	
3:00 pm	Eutrophication Modeling - Autochthonous Carbon Production	J. Pauer
3:30 pm	Questions and Discussion	
3:40 pm	PCB Fate and Transport Modeling	Xiaomi Zhang
4:10 pm	Questions and Discussion	
4:20 pm	Food Chain Bioaccumulation Modeling	Xin Zhang
4:50 pm	Questions and Discussion	
5:00 pm	Remaining Issues/Wednesday's Agenda	R. Kreis
5:30 pm	Adjourn for the Day	

Time	Wednesday's Agenda	Speaker
8:00 am	Comparisons of Models	K. Rygwelski
8:30 am	Questions and Discussion	
8:40 am	Future Plans and Applications	R. Kreis
9:10 am	Questions and Discussion	
9:20 am	Summary of Peer Review Panel Recommendations	R. Kreis
10:00 am	Break	
10:15 am	Wrap-Up Session - Final Discussion and Debriefing by Reviewers	
12:00 pm	Adjourn	

aspects of this modeling approach. Panel Reviewers are expected to provide an objective, unbiased review of the Lake Michigan Mass Balance PCB Modeling: science, best modeling practices, conduct, and supporting components. Panel Review comments should be verbally summarized at the end of the review and then provided in written form, cognizant of constraints in data availability, staff, and financial resources associated with the project. Written comments on the format and content of the project documentation can be provided, if appropriate.

7.1.3.1 Overall Multimedia Ecosystem Modeling Approach

Does the suite of models applied, including atmospheric and tributary load calculation models/methodologies, hydrodynamics model, autochthonous solids (eutrophication) model, water column and sediment transport and fate models, and food chain bioaccumulation model, represent an integrated approach to ecosystem modeling? Are these models, in combination, state-of-the-art? What are the strengths and weaknesses of the overall approach?

7.1.3.2 Overall Model Performance

Overall, how well does the model suite represent physical, chemical and biological processes? How consistent are the modeling concepts and assumptions with current scientific knowledge? Are the processes being depicted at the spatial and temporal scales appropriate/adequate for the issues being addressed and data availability? Overall, how well are transport, exchange, and partitioning processes for PCBs accounted for? Are the food web, trophic structure, and processes which affect bioaccumulation represented accurately? Overall, how well is food chain bioaccumulation of PCBs in Lake Michigan represented? Are model algorithms used to describe processes appropriate (complexity versus simplification)? Have the data been adequately and fully utilized in the modeling? What are the strengths, weaknesses, and uncertainties of the overall modeling performance?

7.1.3.3 Suitability for Management

In terms of their predictive capability related to transport, fate, and bioaccumulation of PCBs in lake trout, is the suite of models and application sufficient to evaluate and guide potential PCB load reduction strategies for Lake Michigan? What are anticipated modeling strengths and weaknesses for management uses?

7.1.4 Modelers' Responses to Peer Review Comments

1. How do you reconcile the difference in peak PCB production versus peak loads for the hindcast run?

Modelers' Response – The explanation for this difference is not readily apparent. A similar difference has been noted for Lake Ontario (Gobas *et al.*, 1995). Peak production occurred in 1970. Gobas *et al.* (1995) found the best overall agreement between observed and predicted total PCB concentrations in water, sediment, and biota occurred when peak loading was assumed to occur in 1961. One would not expect peak loading to necessarily occur in the same year as peak production. Much of the PCBs produced were used in transformers and other sealed sources which would not have an impact on the environment until product failure occurred. It is believed that most of the significant loading of PCBs to Lake Michigan came from PCBs that were used for other purposes. The use of these PCBs in the basin does not appear to coincide with production. Within the basin, the first noted use of PCBs was at Waukegan, Illinois in 1948 when Outboard Marine Corporation purchased hydraulic fluid with PCBs. From the mid-1950s to mid-1960s, PCBs from deinking were loaded to the Kalamazoo River. In the 1950s, PCBs were used in the Green Bay area for production of PCB-coated carbonless copy papers. These discharges to the Fox River peaked in 1969-1970. The use of PCBs for these papers was phased-out in 1971-1972. In the 1960s, industrial PCBs were loaded to Sheboygan Harbor. Thus it appears that PCB use in the basin began in 1948 and ended in 1972. The loadings over time from these uses of PCBs is not currently documented; however, it appears that PCB loadings to the Lake Michigan basin do not coincide

with production or sales figures. This discussion will be included in Part 1, Chapter 7 of the report.

2. POM: Extend the hydrodynamic record from two years to ten years.

Modelers' Response – Currently, funding is not available to extend the POM modeling from two years to ten years. When preparing to conduct forecasts, we were concerned about how representative POM (1994 and 1995) results would be when repeated along with water temperature, velocities, and dispersion coefficients for LM2-Toxic (PCB) and LM3-Eutro (nutrients and carbon) model runs extending beyond the two-year LMMBP period. The POM model used lake conditions and forcing functions present March 31, 1982 through November 20, 1983 for calibration purposes. Comparing lake and atmospheric conditions such as wave height, air temperature, lake levels, tributary flows, and precipitation for the 1982-1983 and the LMMBP period 1994-1995 with the historical record, we found that neither of the two-year periods were at any extreme from means. Based on this review, we believe that the two years of hydrodynamic modeling fairly represent average lake conditions. More discussion on the representativeness of the 1994-1995 period can be found in Part 1-Introduction and Chapter 4 of the report.

3. LM3-Eutro: Why does the model not predict dissolved silicon beyond 0.7? Was the code checked for possible errors? Identify Green Bay stations on the model versus observed plots.

Modelers' Response – This question is related to Figure 2.5.3 in the June 2004 draft copy of "Results of the Lake Michigan Mass Balance Project: PCBs Modeling Report." Please note that the axes in this figure were incorrectly labeled. The abscissa axis should be labeled "model results", and the ordinate axis should be labeled "field data." The dissolved silica output from the model was examined carefully. Although it appears that the model does not predict values higher than 0.7 mg/L (Figure 2.5.3), closer inspection of the model output reveals that the majority of the predicted values are relatively evenly distributed between 0.4 and 0.76 mg/L, with a few values as high as 0.78 mg/L. A limitation of the LM3-Eutro model was the absence of a fully-developed sediment submodel that reflected seasonal

variations. User-defined soluble reactive phosphorus, ammonia, dissolved silica, and dissolved organic carbon sediment fluxes were used to provide an estimate of the sediment feedback. However, these fluxes were constant values in space and time and were selected to provide a reasonable estimate of annual averages. Due to this limitation, the model underestimated the silica build-up at the bottom of the lake during the late summer months caused by the slow decay of the biogenic silica, which settled to the bottom during the spring and early summer diatom blooms, and its potential resuspension. It is believed that this is the major reason why model output values are less than 0.8 mg/L whereas several field values are well above 1 mg/L. There is little difference between observed silica concentrations in Green Bay and the open lake with large seasonal variations at both locations. In Lake Michigan, the observed silica range is between 2.1 and 0.04 mg/L, while in Green Bay it ranges between 1.58 and 0.13 mg/L.

4. LM2-Toxic: Run the model with a conservative tracer and check that mass balances (set initial conditions and boundary concentration = 1).

Modelers' Response – This test was completed very successfully. By setting initial and boundary concentrations of an assumed conservative tracer equal to 1 mg/L in both the water column and sediment segments with no external load, no gas exchange, and no partitioning process, the model was run for a short-term simulation (two years) and a long-term simulation (60 years). The results from the model runs show no change for the two-year model run in all media. For the long-term run, an extremely small change (0.001%) was found in water column segments with roughly a 0.5% change in sediment segments.

5. LM2-Toxic: Consider adding subsurface benthic layers below the surficial layer. It is likely that higher PCB concentrations reside in the deeper layers. Look at historical data.

Modelers' Response – There are subsurface sediment layers (called ghost layers) defined in the current LM2-Toxic segmentation. A quasi-Lagrangian framework is used to allow a moving sediment-water interface. There is no mass exchange between the mixed surficial sediment layer

and subsurface sediment layer, and between two adjacent subsurface layers through mixing or diffusion processes. The cores that demonstrate the high PCB concentrations in deeper layers are found in the depositional zones where the potential for resuspension is minimal. Furthermore, mass transfer *via* diffusion between deeper layers is likely to be minimal for hydrophobic PCBs (see response to comment 14). A detailed description of the semi-Lagrangian sediment bed option is detailed in Part 4, Chapter 3, Section 4.3.4.2.3 of the report and IPX 2.74 documentation (Velleux *et al.*, 2000).

6. LM2-Toxic: Recheck assumptions on scenarios with attenuation rates for tributary loads and wet/dry atmospheric deposition. Check Hites' data against assumed decline in vapor concentration.

Modelers' Response – The half-life of the PCB decline in tributary and vapor phase loadings were assumed to be 12.5 years and six years, respectively, in our model runs for "natural attenuation." These rates are consistent with the PCB tributary and atmospheric loading rates of decline calculated and used by other researchers (Velleux and Endicott, 1994; Endicott, 2002; Marti and Armstrong, 1990; Hillery *et al.*, 1997; Schneider *et al.*, 2001). Further examination of additional data has not revealed any change to these assumptions. See Part 3, Chapter 3 of the report and Endicott (2005) for documentation of materials used for hindcasts and forecasts for MICHTOX and LM2-Toxic. Eventually, Attachment 4 will become a stand-alone ORD publication. See Part 4, Chapter 6, Paragraph 4.6.3 for documentation of sources of information used for forecasts for the LM2-Toxic. A detailed description of the uncertainties that would have an impact on hindcast and forecast choices will be detailed in a revision of the report in Part 1, Chapter 7.

7. LM2-Toxic: Compare model projections to water data post-1998 (southern Lake Michigan).

Modelers' Response – Post-1998 data for southern Lake Michigan have been located. These data will be compared with the model's long-term projections as part of the model verification. The results of the comparison will be detailed in a revised edition of the

report. Additional verification of the model will occur after data collected in 2005 are available.

8. LM2-Toxic: The Panel recommended that a Monte Carlo uncertainty analysis be performed using a steady-state version of the model.

Modelers' Response – This is certainly a valid suggestion. However, given the complexity of the model and the number of solids (three solids) and PCB congeners (54 congeners) simulated in the model, it could be very costly and time-consuming to do the recommended Monte Carlo uncertainty analysis on even a few selected critical parameters used in a steady-state version of the model. In addition to the uncertainties associated with the parameters defined by chemical and biochemical processes conceptualized in the model, water transport, solid cycling rates, numerical algorithms used in the model, and data input into the model are all subject to a certain error, and this error propagates in the model results. The uncertainties associated with these errors could be much greater than the ones only related to the chemical-specific parameters. See Part 4, Chapter 5, Section 4.5.4 for details on the tasks conducted to reduce the uncertainties caused by water transport and solid cycling rates. If computing resources and manpower become available, this issue will be addressed in the future.

9. LM2-Toxic: In regards to solids dynamics (radioisotope calibration), the Panel requested that the Modelers' examine the decline rate and add more recent data.

Modelers' Response – We will examine the decline rate and add more recent data in the future as available.

10. Peer Review Panel: LM2-Toxic/Eutro: How sensitive is the PCB model to primary productivity changes versus sediment net resuspension changes?

Modelers' Response – The suggested sensitivity analysis has been thoroughly investigated. For a 50% increase or decrease in primary production corresponding to the primary production generated from LM3-Eutro for the 1994-1995 period, the LM2-Toxic model was tested for both a short-term (the

two-year calibration) period and a long-term (62-year) period. The results from the sensitivity analyses were compared to the results from the LM2-Toxic model base runs (i.e. 1994-1995 calibration run and long-term Constant Condition Scenario). See Part 4, Chapters 5 and 6 for detailed descriptions of both of these base runs. The general results from the tests are: 1) The solids concentrations (DOC – Dissolved Organic Carbon, BIC – Biotic Carbon, and PDC – Particulate Detrital Carbon) in the water column have a substantial deviation from the base run concentrations for both the short-term calibration and the long-term scenario simulations; and 2) the total (particulate plus dissolved) PCB concentrations in the water column has a noticeable difference from the base run concentrations for the short-term calibration simulation, but it has very little difference for the base run concentrations for the long-term simulation. The results from the sensitivity analyses suggest that, under the 1994-1995 PCB loading/boundary conditions/other forcing functions, the influence of primary production on the PCB concentrations in the water column is very small, especially for long-term forecast scenarios. The details on the procedures used to conduct the test and the associated results will be presented in the revised edition of the report.

11. LM2-Toxic/POM: The model did not consider ice cover in various processes (volatilization, resuspension, etc). Perhaps test the affect with a sensitivity analysis.

Modelers' Response – The POM model was applied to Lake Michigan by the National Oceanic and Atmospheric Administration (NOAA)-Great Lakes Environmental Research Laboratory (GLERL). The current version does not include ice cover algorithms. However, in the absence of an ice model, both POM and LM2 were run with the water temperature steady at 2°C from the period January 1, 1994 through March 31, 1994. Lake Michigan ice cover for 1982 and 1994 were greater than the mean and median whereas 1983 and 1995 were less than the mean and median. None of the four years (1982-1983 hydrodynamic model calibration years and 1994-1995 LMMBP years) represented an extreme of mean daily ice cover. There is an in-depth discussion on historical ice cover data for Lake Michigan in Part 1, Chapter 4 of the report.

Both NOAA and Large Lakes Research Station (LLRS) staff agree that ice cover algorithms in POM would be worthwhile additions to the model. During most winters, Lake Michigan ice cover occurs most often in the nearshore areas only. LM2-Toxic could utilize ice cover predictions from POM by indicating the fraction of the surface segment area that is covered during certain times. However, the coarse grid structure of LM2-Toxic could not be used to predict the impact of ice cover in specific small regions of the lake, such as nearshore zones. At this time, we do not have the in-house expertise to develop a revised POM that addresses ice cover; however, when a revised POM is made available from GLERL that incorporates these algorithms, we could incorporate this version into our Level 3 models where segmentation resolution is fine enough to better deal with year-to-year and within-year ice cover variations. GLERL is planning to incorporate ice cover algorithms in POM for application to Lake Erie.

The effect of ice cover on PCB mass fluxes across the air-water interface through gas absorption and gross volatilization is likely to be small because our calculations predict that these PCB mass fluxes decrease substantially with a decrease in temperature. However, it is recognized that ice cover could affect both particulate settling rates and sediment resuspension fluxes of PCBs in certain time periods in a year in the nearshore regions. It is our opinion that ice cover most likely will not have a substantial impact on the long-term results from the LM2-Toxic model, because ice cover does not affect the total inventory of PCBs in the lake system. However, for short-term predictions, ice cover would be expected to impact the model predictions.

12. LM2-Toxic/Food Chain: Investigate congener patterns in air, water, fish, and sediment. How do these compare?

Modelers' Response – The PCB patterns of multiple media will be compared to determine similarities and differences within and among media. This technique is commonly referred to as PCB fingerprinting or PCB signature recognition and has had mixed success in the past. This recommendation has minor implications to the modeling; however, it is a data analysis tool and has merit for data presentation and interpretation purposes. The relative percent of total

PCBs represented by each congener will be computed and then expressed as a cumulative frequency plot for comparative purposes. These will represent data for an entire study period, will be tested with both mean and median values, and will be a composite expression of seasonal and spatial data. In addition, selected evaluation of pattern recognition using the LMMBP data set can be found in Kuehl (2002) and McCarty *et al.* (2004).

Fingerprints will be calculated for sediment, water column (dissolved and particulate), vapor phase, wet and dry atmospheric deposition, and age 5-6 year-old lake trout signatures from the Saugatuck biota site. Atmospheric signatures will be based on a subset of all congeners because vapor phase data were computed by Keri Hornbuckle for the study, and over-lake concentrations were only calculated for the congeners that are being modeled at Grosse Ile. In addition, PCB patterns associated with water discharging from the Kalamazoo River near the Saugatuck biota site and other selected tributaries will be compared/contrasted to the lake water. These results will be presented in Part 1, Chapter 6 of the report.

13. LM2-Toxic: Consider the missing 120 kg/year total PCB contribution from Milwaukee (sum vapor/wet/dry); how sensitive is the PCB model to atmospheric and tributary loads?

Modelers' Response – The issue, documented in Wethington and Hornbuckle, 2005, of an additional PCB load from the Milwaukee area through vapor exchange, wet deposition, and dry deposition to Lake Michigan was not included in our model. The additional PCB load from the atmosphere was estimated to be at least 120 kg per year. The sensitivity analysis for the Milwaukee load was performed by adding a 120 kg/year PCB load into segment 1 in our model. The results from the sensitivity analysis were then compared to results from the LM2-Toxic model long-term (62 years) base run (Constant Conditions Scenario). The steady-state concentrations from this simulation show an increase of less than 5% in the steady-state concentration compared to the original long-term base run. The details on the Milwaukee loading sensitivity analysis and the impact of the external PCB load changes and vapor phase concentrations to the projected level of PCB concentrations in Lake

Michigan will be discussed in the revised report. It should be noted that additional data will always continue to become available, and this is such a case.

Another potential missing load to the lake is that load associated with very large particles greater than 10 µm. Although experts disagree on the magnitude of the PCB load to the lake *via* large particles, various scientists indicate that PCB dry deposition associated with large particles could be a significant PCB source to the lake (Miller *et al.*, 2001; Franz *et al.*, 1998; Holsen, 1991). Currently, it is not possible to make reliable estimates of these fluxes to the lake. The uncertainty in these flux estimates is associated with the uncertainty of how far these large particles travel from their sources.

Simulations were run to gain insight into how the model would respond to increasing the total PCB load (load from all tributaries + atmospheric load to the entire lake) by 50% and 100%. The results from these sensitivity analyses were then compared with those from the LM2-Toxic model long-term (62 years) base run (Constant Conditions Scenario). The steady-state concentrations from this simulation show an increase of less than 10% and 25%, respectively, to the steady-state concentration from the long-term base run.

14. LM2-Toxic: Investigate PCB diffusion from deeper sediment layers, relative to sediment resuspension.

Modelers' Response – Because of very large PCB partition coefficients, most of the PCB mass in the sediment is associated with the particulate phase. Therefore, relative to sediment resuspension, the PCB mass moved by PCB diffusion between deeper sediment layers through pore water is trivial. Adding this process into the current semi-Lagrangian scheme for sediment transport in the LM2-Toxic model would require considerable effort and time to modify the code, calibrate the model, and analyze the output.

15. LM2-Toxic/LM Food Chain: Conduct a hindcast for PCBs which will be further used in the LM2 Food Chain hindcast; possibly select five congeners.

Modelers' Response – We agree with the review panel on the importance of this task. Although it requires significant resources, time and effort, this is an effort that is certainly worth doing. This task is currently underway and all of the selected PCB congeners (54) will be simulated in the model hindcast. The LM Food Chain model will be run using the output of the LM2-Toxic hindcast that was run to describe the exposure history. The approach, inputs, model outputs, and interpretation of the results will be presented in the revised report.

16. LM2-Toxic/POM: Examine the effects of changing the horizontal grid structure to evaluate translating POM output to the LM2 grid.

Modelers' Response – This is a valuable and interesting suggestion. However, it would require considerable effort and expertise to accomplish the task. It would require extramural personnel such as David Schwab of NOAA-GLERL to adapt POM output to the new grid structure. Considering the resources and time that would be involved in this task, it cannot be done in the foreseeable future.

17. LM-Food Chain: Calibrate over declining exposure concentrations rather than constant exposure history. To facilitate this effort, consider hindcasting five PCB congeners.

Modelers' Response – Due to the lack of credible PCB congener-specific exposure history data, the measured data for PCBs in water and sediment (1994-1995) was assumed to be representative of life-long average exposure concentrations for the food web and was, therefore, used in model calibration simulations. Model calibration over declining exposure concentrations will be attempted once the temporal profiles of congener-based PCB concentrations in water and sediment become available from the LM2-Toxic hindcast.

Theoretically, calibrations over declining exposure concentrations should yield better results than that conducted over a constant exposure history because PCB loads to the Great Lakes have been and will likely continue to decline toward a steady-state. However, it is difficult to accurately determine the rates of decline for exposure concentrations in the various media. The lake trout, as well as coho

salmon food webs in Lake Michigan, are exposed to PCBs associated with both the water and sediment. Therefore, model calibrations for their food webs require information on temporal variations of PCB concentrations in both the water and sediment over the exposure history. However, the temporal trends of PCB concentrations decline are usually reported for total PCBs only. Congener-specific PCB data are rarely available. For total PCBs, the quality of the estimated exposure decline rates is usually questionable due to the often considerable variability and uncertainty of the measured total PCB data in the water and sediment. Therefore, with limited data availability and poor data quality, a reconstructed declining exposure history is not necessarily a better representation of the actual exposure condition than the constant exposure assumption. If one can assume that the PCB concentrations in Lake Michigan system is currently declining at a very small rate, then model calibrations using current congener-specific PCB data as average life-long exposure may be a more desirable alternative than model calibrations over declining exposure concentrations for total PCBs or a limited number of congeners.

18. LM Food Chain: Concern on using specific dynamic action (SDA) versus activity cost (respiration). Recommend using activity cost for calibration. This question will be reformulated in the written review.

Modelers' Response – In the LM Food Chain model, activity cost for each species is estimated as a function of temperature based on bioenergetic equations and is not "refined" during calibrations. We chose to adjust only SDA with the hope to minimize the risk of turning calibration into a curve-fitting exercise.

19. LM Food Chain: Explain why 5.5 year-old trout data are so variable at Saugatuck.

Modelers' Response – It is not uncommon for fish to have variable PCB levels among individuals of the same age class and among age classes. The variability of PCB levels among individual fish can have a direct impact on the uncertainty interval associated with the measured PCB data in composites. The variability of an individual fish's PCB concentrations may be attributed to, among other things, the differences in body size, health

condition, feeding skill, dietary preference among individual fish, exposure variances due to their spatial feeding range, and analytical chemistry variability. These individual differences are likely to have direct impact on the growth rate and the amount of dietary PCB intake of individual fish and subsequently on fish's PCB bioaccumulation.

The trend for the USEPA historical Saugatuck lake trout PCB concentration data is clearly downward. Similarly, the within-year variability represented by 95% confidence intervals for these observations also demonstrates a decreasing trend in time. Data prior to 1981 clearly have much more within-year uncertainty than data collected after that date, and the concentration means for these earlier data show greater year-to-year differences than do later composites. A cursory examination of the historical PCB lake trout composite concentration data compared against available mean fish length, fish weight, % lipids, and % males in the composites revealed no distinct relationships for the years examined.

Although a cursory examination of the historical PCB lake trout composite concentration data collected at Saugatuck compared against mean fish weight and length showed no distinct relationship, some of the within-year variability of composites could be further attributed to the fact that the monitoring samples were not collected for a particular age class. Rather, the lake trout samples were collected and classified as 600-700 mm size class. For many of the historical 600-700 mm lake trout samples, their age classes are uncertain. Based on accurate age classification for the 1994-1995 lake trout samples, the 600-700 mm size class can be roughly associated with 5 and 6 year age classes. However, this size-age correlation may not necessarily be applicable for lake trout samples collected in other years. In other words, the monitoring data for adult lake trout at Saugatuck over the years represent PCB levels in a range of age classes of lake trout. In our report, these monitoring data were labeled and plotted as PCBs in 5.5 year-old lake trout merely for convenience in comparing with age-specific modeled PCB data for lake trout. To demonstrate the range of PCB-predicted concentrations in lake trout, model output for the 4, 5, 6, and 7 year-old lake trout will be plotted with the Saugatuck historical lake trout data.

This graphic will appear in the revised draft of the report.

Dietary preference is likely a very important aspect in evaluating long-term trend data. Food web changes have and are occurring in Lake Michigan based upon past and present disparate reports on the topic. However, the 1994-1995 diet study results suggest a general consistency with known lake trout diet preferences in the past. Although these are typically dominated by alewife, bloater, sculpin, and smelt, there may be a greater trend toward bottom-dwelling bloater and sculpin than during the general evidence in the past two decades.

The year-to-year differences in mean concentrations and the within-year variability observed in lake trout could also possibly be related to variable exposure resulting from meteorological and physical factors. These factors have the potential to have direct and indirect impacts on the food web and exposure gradients within the feeding range of Saugatuck lake trout. A primary factor is PCB loading events associated with high flow from the Kalamazoo River that discharges at Saugatuck. The Kalamazoo River has a history of PCB contamination (see table that follows in response to 1.20). Also, periodic low lake level events have the potential to reduce PCB exposure to the lake trout food chain in certain zones which could be reflected in periodic low-level PCB body burden results. In a period from the mid-1960s to the late-1980s, the lake levels were at near record lows and near record highs, respectively.

Much of the analytical chemistry data on fish prior to 1983 was performed using packed column gas chromatography (GC). Dichlorodiphenyl-dichloroethylene (DDE) often co-extracted with the PCBs and was very difficult to analytically separate from PCBs on the packed-column GC (Michael Mullin, personal communication). If the concentration of DDE was significant, and separation was not complete, then a positive PCB bias results in the measurement. Some measurements were performed where sample extracts were analyzed using joint GC and mass spectrophotometry. This combined analytical system improved the ability to separate the DDE from the PCBs. Most of the analytical work performed post-1983 was done using capillary GC which significantly improved separation of DDE from PCBs.

20. LM-Food Chain: Develop a time line/chronology of regulatory and remedial actions, relative to the fish monitoring record/trend at Saugatuck.

Modelers' Response – This has been done and will be found in the revised edition of the report in Part 1, Chapter 5. Where appropriate, dates have been added to figures in that chapter. The table used to summarize the time-line is shown in Table 7.1.2.

21. LM-Food Chain: Provide an estimate of model error on the fish long-term monitoring trend.

Modelers' Response — There are many sources that contribute to model errors. They include conceptual errors and/or omissions, errors in parameterization, uncharacterized system variability, and errors in data used for calibrations. In addition, the quality of model prediction of the long-term fish monitoring trend

Table 7.1.2. Significant Dates in the History of PCBs in the Lake Michigan Basin

Date	Event
1865	First PCB-like chemical discovered
1881	First PCBs synthesized
1914	Measurable amounts of PCBs found in bird feathers
1927	PCBs first manufactured at Anniston, Alabama
1935	PCBs manufactured at Anniston, Alabama and Sauget, Illinois
1948-1971	Outboard Marine Corporation at Waukegan, Illinois purchase eight million gallons of hydraulic fluid with PCBs
1954	Appleton Paper Company began using PCBs as PCB-coated carbonless copy paper with discharges to the Fox River
Mid-1950s to Mid-1960s	PCBs loaded to Kalamazoo River from deinking
1959-1972	Outboard Marine Corporation at Waukegan, Illinois used hydraulic fluid with PCBs for die-casting
1960s	PCBs used by Tecumseh Products Company loaded Sheboygan River
1969-1970	Paper company discharges of PCBs to Fox River peaked
1970	PCB production peaked at 85 million pounds and huge contamination noted at Sauget, Illinois plant
1971-1972	Appleton Paper Company and NCR Corporation phased-out PCB use. Recycling of carbonless paper had occurred for several decades
1973	U.S. Food and Drug Administration (USFDA) establish 5 ppm PCB tolerance level in fish
1975	124,000 cans of salmon from Lake Michigan seized because of PCBs
1977	PCB production ends
1984	USFDA lowered PCB tolerance level in fish to 2 ppm
1985	Commercial fishing for carp and other valuable species outlawed on Green Bay
1989-1990	Sheboygan Harbor PCB Remediation
1991	U.S. Department of Health and Human Services label PCBs as possible carcinogen
1991-1992	Waukegan Harbor PCB remediation (1 million pounds PCBs) completed for this action in 1992. Additional work is planned.
1998	The eight Great Lakes States agreed on a "Great Lakes Protocol for Fish Consumption Advisories" that lowered the regional standard from the USFDA commercial standard of 2 ppm down to 0.05 ppm
1997-1999	Kalamazoo River sediment PCB remediation on Bryant Mill Pond (20,000 pounds of PCBs). Additional work is planned
1997-1998	Milwaukee River PCB remediation
1998-1999	Upper Fox River deposit N (17,000 cubic yards) and sediment management units 56 and 57 dredging partially completed. Additional work is planned on the Fox River system
1994-2000	Manistique Harbor PCB remediation (141,000 cubic yards)
20002	Possibly begin Grand Calumet River PCB remediation

depends on the availability of a realistic projection of future exposure concentrations in water and sediment for the food web. Not all errors from these sources can be quantified. In the final report, we will provide an estimate of model error associated with model parameterization and calibration with an emphasis on error associated with a potential shift in food web structures.

22. LM Food Chain: Conduct a prey sensitivity analysis for lake trout.

Modelers' Response – We will be testing the sensitivity of the model to changes in the food web structure. In addition to a prey sensitivity analysis for lake trout at Saugatuck, model sensitivity to fish growth rate, lipid content, and temperature (among others) will also be provided in the revised edition of the report.

23. Enhance data presentations of the project data to provide regional and open lake/nearshore differences and gradients for multiple media.

Modelers' Response – We agree that data presentation is an important aspect of this project to aid in the understanding of modeling results. PCB data used for the modeling will appear in the revised edition of the report in Part 1, Chapter 5, "PCBs in the Lake Michigan Ecosystem."

24. Provide CDs of presentations to the Peer Review Panel.

Modelers' Response – All presentations given at the peer review were provided to the panel members in electronic form after the review.

25. Provide CD copies of draft modeling report, appendices, and attachments (those available electronically) to the Peer Review Panel.

Modelers' Response — The Draft Modeling Report, Appendices, and Attachments were provided to the panel in bound hard-copy in late June 2004 for review purposes. CD/electronic copies of the report and associated materials were provided to the peer review panel after the review.

7.1.5 Modelers' Responses to Specific Comments Made by Peer Review Panel Member – James Martin

Note: Some of Dr. Martin's comments were identical to those listed in the consensus comments above and were, therefore, not repeated in this section.

1. MICHTOX: Continue to maintain the Level 1 model, particularly for comparison with Level 2 predictions.

Modelers' Response – While we appreciate the reviewer's interest, it would be difficult to continue to maintain the MICHTOX PCB model for purposes of comparing future Level 2 predictions because of current resource limitations. Furthermore, it is rather difficult to make a direct comparison of MICHTOX to Level 2 because the construct of the two models is so different. We plan, however, to continue with the development of a Level 3 PCB transport/fate/bioaccumulation model which would offer much more spatial resolution and would incorporate SEDZL sediment resuspension velocities along with the QUICKEST-ULTIMATE sediment algorithms into the framework. The Level 3 model should; therefore, be very useful for comparison to the Level 2 model predictions.

2. MICHTOX, LM2, and LM3: Explore incorporating specific algorithms, such as the steady-state algorithm (as exists in MICHTOX), with the Level 2 and potentially Level 3 models.

Modelers' Responses – A steady-state version would be helpful if Monte Carlo type simulations were performed to help understand model uncertainty. For the LM2 and LM3 PCB congener-level models, a Monte Carlo type uncertainty analysis presents many challenges as described in our response to comment 8 above. However, for our other two LMMBP toxic chemicals of interest (mercury and *trans*-nonachlor), a Monte Carlo type simulation would be more feasible due to the fewer number of state variables.

3. MICHTOX/LM2: Both models predicted remarkably similar changes in total PCB concentrations over time in the long-term projections. However, there were differences between the two models such as in the rates of settling/resuspension used and in the characterization of the sediment bed. As a result, the two models predicted similar results for somewhat dissimilar reasons. It would be of interest to further investigate factors leading to the similarity in predictions, which may provide some additional insights as to the factors controlling PCBs in Lake Michigan.

Modelers' Responses – In Ken Rygwelski's PowerPoint presentation at the peer review titled, A Comparison of Lake Michigan Mass Balance Project (LMMBP) Polychlorinated Biphenyl Models: MICHTOX versus LM2-Toxic and LM Food Chain, a graphic was presented that displayed the whole lake total PCB concentration projections for the two models. It is noteworthy that at the beginning of the runs depicted, January 1, 1994, MICHTOX starts out higher than LM2-Toxic. The reason is that MICHTOX concentrations at that time represent the concentrations predicted from the MICHTOX hindcast whereas the concentrations from LM2 represent observed lake concentrations at that time. Also, note that in the same presentation MICHTOX was losing approximately 2,958 kg/year and LM2-Toxic was losing 2,043 kg/year. Although MICHTOX was losing more PCBs per year than LM2-Toxic, it started out with a higher lake inventory of PCBs in the water, which can explain, in part, why the two models predict similar concentrations. The construct of these two models is rather different in a number of ways, and this makes comparisons difficult. Some of these differences, however, were most likely overcome through the calibration process of the two models. A discussion on this topic of model comparability between MICHTOX and LM2-Toxic will appear in the revised report.

The two food chain models were also very close to predicting when the 5.5 year-old lake trout at the Saugatuck biota zone would reach the target consumption criteria of 0.075 ppm PCBs in whole fish. MICHTOX predicted year 2025 and LM Food Chain predicted the year 2026. A major difference between these two model constructs is that MICHTOX is composed of four members in the food

web whereas LM Food Chain has 10 members. Also, MICHTOX is based on two PCB homologs and LM Food Chain is PCB congener-based. It is likely that much of the similarities in the predictions of these two models is due to calibration and the use of the same rate of decline for PCB loads for natural attenuation.

4. POM/LM2/LM3: Continue development of the linked POM and Levels 2/3 models.

Modelers' Response – Currently, neither in-house expertise nor funding exists to further the development of POM for Lake Michigan. We do recognize; however, that simulating ice cover and incorporating finer spatial resolution for some nearshore "hot spot" areas could be described better with a POM upgrade.

In terms of upgrading Level 3 models, we are currently working on upgrading the coupled LM3-Eutro and LM3-Toxic (PCB) model. This near-term goal includes resuspension velocities from SEDZL into the coupled model. The QUICKEST-ULTIMATE algorithm will be implemented in the 10 sediment layers. The model has two particle classes: fine-grained inorganic fraction and fine-grained organic fraction. Refractory organic carbon, total phosphorus, total nitrogen, and total silica will be associated with the particulate resuspension flux as well as the PCB modeled congeners. With this new construct, a LM3 hindcast from 1960 to 1995 will be run for both the Eutro and Toxic components of the coupled model. A long-term goal includes adding sediment diagenesis and dissolved oxygen algorithms to LM3 Eutro.

LM3-Eco is an enhanced version of LM3-Eutro and will eventually include *Bythotrephes*, *Mysis*, carnivorous zooplankton, herbivorous zooplankton, diatoms, and green algae (Phase 1), and additional state variables including *Dreissena*, *Diporeia*, nitrogen-fixing blue-green algae, and non-nitrogen-fixing blue-green algae (Phase 2). At this time, Phase 1 of LM3-Eco is in the model calibration stage.

-
5. Provide documentation of the POM application and testing, particularly with regard to an assessment of the applicability of the model to the transport of PCBs and other water quality constituents. Perhaps include it as an appendix to the modeling report.

Modelers' Response – See Schwab and Beletsky (1998) and Beletsky and Schwab (2001). These documents are available at <http://www.glerl.noaa.gov/pubs/techrept.html> and <http://www.glerl.noaa.gov/pubs/fulltext/2001/20010008.pdf>, respectively. LLRS has electronic and hardcopy forms of these documents in our library.

6. Investigate potential linkages issues between POM and with SEDZL.

Modelers' Response – SEDZL has its own hydrodynamic model and is not at all connected with POM; therefore, all of the hydrodynamic forcing functions are input into the SEDZL model. The Donelan parametric wind wave model applied to Lake Michigan by David Schwab of NOAA-GLERL is a stand-alone model which is run before SEDZL is run, and the output of the wave model becomes input for the SEDZL model.

7. Investigate assumptions/limitations of using a sigma grid, particularly in resolving both nearshore and open lake issues. One potential limitation to the POM model construct (relative to this application) is related to the coordinate system used in the vertical dimension (a sigma grid). A sigma grid requires a constant number of vertical layers throughout the model domain (beneath each of the 5 km horizontal grid cells (the number of vertical layers was variously cited as from 15 to 20 in the modeling report, which should be corrected). This use of the sigma grid may impact the ability of the model to resolve vertical gradients, particularly in deeper sections of the lake while still sufficiently capturing nearshore circulation patterns. In addition, sigma grids may produce artificial horizontal transport patterns. While there are numerical schemes for compensating for this, I am not aware that they have been implemented in POM or that any sigma transport tests have been conducted for an application such as Lake Michigan.

Modelers' Response – The actual number of sigma layers throughout the POM construct is 19 water layers. The citations mentioning 15 or 20 layers will be corrected in the revised edition of the report.

The potential problem of using the sigma grid structure for POM is that an extra term is introduced in the horizontal gradient terms that can lead to artificial vertical diffusion of heat and momentum, particularly in areas of large topographic gradients as was described in Schwab and Beletsky (1998). To help minimize this affect, the 5 km gridded depths were slightly smoothed by adjusting the depths to ensure that the relative depth change between adjacent grid squares was less than 0.5 while still preserving the volume of the original grid.

The model did not perform as well in the thermocline area as it performed near the surface. The simulated thermocline was too diffuse. To study the effect of vertical resolution on the vertical temperature gradients, a model run with 39 sigma levels was conducted. NOAA also ran the model with zero horizontal diffusion to test for artificial diffusion along sigma surfaces. In both cases, very little improvement was noticed in model results. On the other hand, experiments with an one-dimensional version of the model showed that the Mellor-Yamada scheme can provide a sharp thermocline that is sensitive to the choice of extinction coefficient which poses significant spatial and temporal variability in large lakes but was kept constant in the calculations because at the time of generating the model runs, temporal data on the extinction coefficients were not available. In Schwab and Beletsky, 1998, NOAA mentions that a 2 km grid structure or higher resolution would likely improve the results, but would likely push computer resources beyond current limits for the hydrodynamic model and associated LM3 water quality models.

8. In addition to spatial averaging, there was apparently time-averaging of hydrodynamic predictions as well, allowing a daily time-scale for the LM2-Toxic model. The procedures used to average the hydrodynamic predictions, and tests conducted to determine the impact of that averaging, should be documented.

Modelers' Response – Schwab and Beletsky (1998) indicate that aggregated average surface heat flux

(on an hourly time scale) and average vertical temperature profiles (on a six hour time scale) were computed for each of the 10 LM2 surface segments and the 41 segments, respectively, for both the 1982-1983 and 1994-1995 periods. In addition, horizontal and vertical inter-segment transports averaged over one-day and six-day intervals were computed for the 10 column LM2 grid with five vertical layers: layer one, 0-10 m; layer two, 10-20 m; layer three, 20-30 m; layer four, 30-50 m; and layer five, 50 m-bottom. They do not discuss any tests run to determine the impact of averaging. A discussion on how these data were used in LM2 can be found in the report in Part 4, Chapter 4, Sections 4.4.1.2 and 4.4.1.3. All programs and data sets associated with the LM2 aggregation are on the Final Report CD received from NOAA-GLERL.

9. LM3-Eutro: Table 2.4.6 lists the two “types” of data but does not describe how the transformations were made.

Modelers’ Response – The relationship between the variables measured in the field and state variables used in the model can be found in Appendix 2.4.1 of the report.

10. LM3-Eutro: Table 1.1.2 does not indicate that zooplankton were a measured parameter, although it is a model state variable and the text indicate that zooplankton data were collected (Part 2, Chapter 4, Section 2.4.2.2.4).

Modelers’ Response – As part of the introductory material, Table 1.1.2 was only intended to offer a general overview of the major types of data collected. For example, some sub-parameters of PCBs such as a listing of all of the congeners measured, or the fact that dissolved and particulate were measured are missing from the table. However, zooplankton is a major biological and will be included in the table. A comment will be added where Table 1.1.2 is referenced in the text explaining that for a complete listing of parameters measured, the reader should see Part 1, Chapter 3 of the report. For modeled parameters, the reader should see individual chapters on MICHTOX, MICHTOX Food Chain, LM2-Toxic, LM Food Chain, or LM3-Eutro modeling in the report.

11. LM3-Eutro: While I agree that the expansion of variables to include dissolved organic and labile and refractory particulate organic forms allows for more realistic description (which is an increasingly common practice) there are no established protocols for measuring these forms. Therefore, it must have been necessary to make assumptions regarding, for example, the partitioning of particulates among labile and refractory forms. Those assumptions should be described in the report, and perhaps some sensitivity analyses performed as to the impact of differing assumptions on model predictions. The assumptions regarding the split were indicated (Part 2, Chapter 4, Section 2.4.1.1) for atmospheric loads, but not for other loading sources that this reviewer could find.

Modelers’ Response – The LM3-Eutro model has labile and refractory state variables for particulate nitrogen and phosphorus whereas particulate silica is in the refractory form only. Since nitrogen was not a limited nutrient in the model, the evaluation of the two particulate nutrient forms focuses on phosphorus only.

Total phosphorus, dissolved phosphorus, and soluble reactive phosphorus (SRP) were measured in the water column of Lake Michigan. The labile and refractory forms of particulate phosphorus can be calculated based on equations described in Appendix 2.4.1. For initial lake conditions, particulate phosphorus was evenly split between the labile and refractory forms. Somewhat different fractions of particulate phosphorus were used for the labile and refractory forms in tributary and atmospheric loads (e.g. the tributary particulate was 0.55 labile and 0.45 refractory – see Part 2, Chapter 4).

The mineralization rates for the two particulate phosphorus forms used in the model were very similar; therefore, no significant differences would be expected when different fractions of these forms are used in the model. This was confirmed when several model sensitivity simulations were performed by varying the initial lake condition and loading percentages between 25% and 75% for the two particulate state variables, and in all cases the results were virtually the same.

-
12. LM3-Eutro: In Part 2, Chapter 4, Section 2.4.4.2, it is stated that laboratory primary production rates were used to verify the overall production rates in the model. These comparisons should be included in the modeling report.

Modelers' Response – A comparison of the model-predicted versus laboratory-measured primary production rates can be found in Figure 2.5.2. However, there was no reference to this figure in Part 2, Chapter 4, Section 2.4.4.2. (there was a reference to the graph in Part 2, Chapter 5, Section 2.5.2). The text will be updated to include a reference to the figure in Part 2, Chapter 4, Section 2.4.4.2, and the figure will be moved.

13. LM3-Eutro: The characterization of non-diatoms versus diatoms is a useful breakdown. Since blue-greens were the dominant algae (see page 99), some additional explanation would be worthwhile as to how nitrogen limitation was computed for these algae.

Modelers' Response – Blue-green algae was present in Lake Michigan in large numbers. However, because of their very small size, they made up less than 6% of the total phytoplankton carbon mass. For this reason, we lumped this group in the model as part of the "non-diatom" algae group and we assumed that phosphorus, rather than nitrogen, was the limiting nutrient. The corresponding section in the revised edition of the report will be updated to provide a better and more detailed explanation.

14. LM3-Eutro/LM3-Toxic: Continue to develop the Eutro Model, for both linkages to the Toxic Model as well as for use related to addressing conventional pollution in Lake Michigan and its tributaries/embayments.

Modelers' Response — We do plan to continue to develop the coupled LM3-Eutro and LM3-Toxic (PCB) model. SEDZL provides us with a time-variable resuspension velocity which we will use in LM3-Toxic (PCB). Current plans include the addition of particulate resuspension processes to LM3-Eutro including particulate forms of nutrients and refractory organic carbon. Eventually, we will add diagenesis to the sediment compartment and algorithms to

compute dissolved oxygen. See our response to Number 4 above for additional details.

15. LM3-Eutro: Explore and document methods to relate measurable field data to model input values (e.g., refractory particulate organic matter).

Modelers' Response – This question has been answered in Number 11 above.

16. Conduct additional calibration (e.g., to nitrogen series) as an additional test of the model's performance and if the model may be used to address questions in the future with regard to conventional pollution.

Modelers' Response – Because nitrogen does not drive this model, relatively little time and effort was spent on the calibration of the different nitrogen species and was, therefore, not included in the June 2004 draft copy of the report. However, nitrogen will be fully calibrated in future modeling efforts especially when addressing lake nutrient and phytoplankton (chlorophyll-*a*) issues.

17. LM3-Eutro: The comparisons of model predictions and field data were somewhat limited in Part 2, Chapter 5. Additional comparisons should be provided, both graphical and statistical, between model predictions and observed data. Comparisons should be provided if possible for all state variables. For example, no comparisons are presently provided for nitrogen species.

Modelers' Response – In the revised edition of the report, Part 2, Chapter 5 (Calibration) was expanded and updated to include additional graphical and statistical results of the calibration process.

18. LM3-Eutro/LM3 – Toxic: Presently, the LM2- and LM3-Eutro codes specify sediment fluxes as zero order rates, which is a common practice. However, there are models of sediment diagenesis that allow prediction, rather than description, of those rates. While probably not critical in the context of using the Eutro predictions for input to the toxic model, incorporation of a sediment diagenesis model may be worthwhile should the LM3-Eutro model

be used in the future to assess eutrophication related management questions.

Modelers' Response – Sediment diagenesis will be added to LM3-Eutro. See "Modelers Response" to Number 4 above for additional planned enhancements of LM3-Eutro.

19. LM3-Eutro/POM: The linkage of the POM model with the LM3-Eutro grid was only briefly discussed. The incorporation of the QUICKEST-ULTIMATE routines from the U.S. Army Corps of Engineers CE-QUAL-ICM model should provide a suitable numerical framework for that linkage. However, the linkage of hydrodynamic and water quality models, even using a one-to-one spatial grid, is not a trivial task. For example, because of differing solution schemes, mass imbalances can occur which, if not properly treated, can accumulate and impact long-term model predictions. As such testing is required to ensure that water and constituent mass are conserved globally and locally in the linked water quality model. This testing needs to be documented and should be included in the modeling report, perhaps as an appendix.

Modelers' Response – All of these topics and issues were covered in four reports written by Ray Chapman associated with the U.S. Army Corps Of Engineers, Waterways Experiment Station which will be included in an updated version of the LM3 User Guide (Settles et al. 2002). This updated LM3 User Guide will be included as a new appendix in the revised report.

20. LM3-Eutro: The section of the report (Chapter 1) dealing with the calibration of the LM2-Eutro and LM3-Eutro was somewhat confusing, with regard to which model was calibrated against existing data.

Modelers' Response – The LM3-Eutro model is a Level 3 model with 44,042 (5 x 5 km²) segments – there is no LM2-Eutro model. However, as part of the post-processing, the model was collapsed to a Level 2 grid, similar to the LM2-Toxic framework. This enabled a comparison of field data with model output on the Level 3 grid and on the Level 2 grid. Part 2, Chapter 5 of the report (Calibration) was

updated to better explain the calibration of LM3-Eutro on the Level 2 and Level 3 segmentation schemes.

21. LM2/POM: An overlay grid, such as between the POM model and LM2-Eutro and LM2-Toxic is often more problematic than using a one-to-one spatial grid (between a hydrodynamic and a water quality model). In this application, it was suggested that linkage problems did occur, resulting in the necessity of adding "water balancing flows" (Part 4, Chapter 3, Section 4.3.3). Adding water-balancing flows is not an uncommon practice in linking three-dimensional hydrodynamic and water quality models. Typically those flows are small but without them water volume imbalances accumulate over time. However, it was indicated during presentations that in this study not including the "balancing" flows resulted in water volumes going to zero in some water quality segments (in Green Bay). This is indicative of a linkage problem that should be further investigated. In addition, the approach used to compute vertical exchanges (Equation 4.4.1) should not have been applicable if vertical flows (gross not net) were included with the hydrodynamic linkage. It is suggested that additional testing of the linkage be conducted and documented within the modeling report, perhaps as an appendix.

Modelers' Response – LM2-Eutro, referred to in sentence one, does not exist. Primary productivity is estimated by LM3-Eutro in space and time, and this information is exported to LM2-Toxic (PCB). The overlay between LM3-Eutro and POM is a one-to-one spatial grid.

We agree with Dr. Martin's comments and suggestion on the linkage between POM and LM2. The linkage problem (mass of water is not balanced in individual segment basis in LM2-Toxic model) was identified during the period of testing the linkage, and the water balancing flow was introduced to correct the imbalance. This problem was noted in a very small segment volume in Green Bay and after a run time of 70 years. See Part 4, Chapter 3, Section 4.3.3 of the report for additional discussion on this issue. The results of the test will be included as an appendix in the revised report. NOAA-GLERL performed the linkage calculations between POM

and LM2, so any further investigation would need to be referred to them.

Dr. Martin is also correct on the applicability of vertical exchanges. The vertical flows provided by NOAA based on POM outputs are the net vertical flows; therefore, the vertical exchange process must be added in the overall water transport field used in LM2-Toxic model. Additional discussion and description of the method of calculating vertical exchange coefficients and calibration are documented in Part 4, Chapter 3, Section 4.3.3 and Part 4, Chapter 4, Section 4.4.1 in the report.

22. LM2-Toxic: As indicated in Part 2, Chapter 6, Section 4.6.2, the flux contributed by the diffusive term from the sediment bed was unexpectedly large relative to the resuspension flux. This may have been due to the relatively large specified diffusion coefficient used relative to the Level 1 model. In addition, it was indicated in Part 4, Chapter 6, Section 4.6.2 that the total PCB residence time for Lake Michigan were on the order of 100 days. This estimate seems low to this reviewer. It would be interesting to see how this compares to predictions from a Level 3 model which may more realistically estimate vertical exchanges in layers isolated from the water surface. The Level 3 model could be used to determine if the rapid removal may be in part an artifact of the modeling approach used in the Level 2 studies. As an example, given the rates of settling used, surface particles would require approximately one year to reach the bottom, while with a single vertical-box model it would be assumed that vertical transport is on average instantaneous.

Modelers' Response – We agree with Dr. Martin regarding the high flux contributed by diffusion between the water column and surficial sediment layer. We plan to investigate model responses in both the water column and sediment to various mass fluxes across the sediment-water interface by changing the diffusion coefficient and/or mixing length between the water column and surficial sediment as identified in Part 4, Chapter 2 of the report. There is further discussion on the diffusion coefficient used in LM2-Toxic model in Part 4, Chapter 6, Section 4.6.2 of the report. This also is

one of the recommendations in Chapter 2 of Part 4. Like Dr. Martin, we also noticed that the total PCB residence time for Lake Michigan is relatively low and will do the comparison with the LM3 model when these results become available.

23. LM2-Toxic: Apply the model to refine whole-lake estimates of PCB concentrations.

Modelers' Response – Whole lake, volume-weighted average concentrations of total PCBs in the lake can be found in Part 4, Chapter 6, Section 4.6.4 of the report for various load reduction scenarios, including the "No-Effects Action."

24. LM2-Toxic: Extend the modeling framework to include other contaminants of concern (e.g., mercury).

Modelers' Response – We will extend the modeling framework to include other contaminants such as mercury and *trans*-nonachlor and believe the LM2-Toxic model would make an excellent and easy-to-use screening and diagnostic tool for helping management personnel and policy makers to understand the key processes controlling the level of the contaminant of interest in the water system.

25. LM2-Toxic: The comparisons of measured and simulated concentrations seem reasonable. However, since differences occur between factors controlling PCBs in Lake Michigan and Green Bay, the results for these two systems should be reported separately.

Modelers' Response – For LM2-Toxic, most field measured data were interpolated separately for the two systems. We also reported the two systems together and separately for model calibration results and mass budget diagnosis. See Part 4, Chapters 5 and 6 of the report for details.

26. LM2-Toxic/LM3-Toxic: The sediment bed model seems reasonable. However, some additional clarification of the semi-lagrangian method for simulating the sediment bed (Part 4, Chapter 3, Section 4.3.4.2.3) would be useful. In addition, the present construct does not allow for the tracking of materials buried out of the layer, or perhaps entrained into the layer from deeper contaminated sediments. Some

additional development of the sediment algorithms would be useful for the Level 2 model and for incorporation into the Level 3 framework where it may be more important with regard to near-shore issues).

Modelers' Response – There is a detailed description on the semi-Lagrangian method for simulating sediment bed in the IPX model user manual (Velleux *et al.*, 2000). An algorithm for tracking masses and fluxes of both solids and PCBs in the sediment bed, including deeper sediments, has already been implemented in the LM2-Toxic model codes. We will consider additional development of LM2 sediment algorithms for incorporation into LM3 as another option. Also, see "Modelers Response" to Number 4 above for additional enhancements planned for the sediment bed model.

27. LM Food Chain: Continue to develop and refine the food chain model.

Modelers' Response – Additional calibration simulations will be run with reconstructed historical exposure PCB concentrations in water and sediment as inputs. The new calibration results will be compared with those from the constant exposure assumption. The results will be provided and discussed in the report. Further development and refinement of the model will be carried out when additional data for the lake trout food web at Sheboygan and for the coho salmon population become available.

28. LM Food Chain: Extend the calibration period to an evaluation of historical loadings and/or a period encompassing all available data (not just the 1994-1995 data set).

Modelers' Response – A new set of calibration procedures will be performed using estimated temporal profiles of historical PCB exposure concentrations in water and sediment as model inputs. All currently available field PCB monitoring data for fish in Lake Michigan will be compiled and used in the calibration. The results will be provided in the final report. However, the credibility of the calibration results will be impaired by the lack of historical information regarding food web structures and dietary shift, age-specific PCB data for lake trout,

PCB data for forage fish, PCB compositional change, and congener-specific PCB values.

29. LM Food Chain: Use the model along with any revisions made to the LM2-Toxic to refine estimates of future trends in fish PCB concentrations.

Modelers' Response – As revised PCB exposure scenarios in the water and sediment provided by LM2-Toxic becomes available, new model projections of future trends in lake trout PCB concentrations will be made and reported in the final report.

30. LM Food Chain: Initiate extending the model (and data analysis) to other pollutants of concern (e.g., mercury).

Modelers' Response – It has been our intention to expand the model to other pollutants of concern, including application to other organic chemicals such as *trans*-nonachlor and mercury.

31. LM Food Chain/LM3-Eutro: Perhaps some more direct coupling of the eutrophication and food chain model could be considered in future applications to aid in addressing questions regarding impacts of changes in food chain structure on uptake of PCBs and other toxicants.

Modelers' Response – This recommendation was not addressed in the report. The possibility of direct coupling of the eutrophication and food chain models could be explored in future applications. However, the current state of understanding regarding the mechanism of fish dietary selection/adaptation does not permit prediction of changes in food chain structures with eutrophication data. Further investigation is required on this topic before attempts are made to couple the food web model with the eutrophication model to address PCB uptake issues.

32. LM3-Toxic/LM2-Toxic: Continue to develop the LM-3 model in order to test against the LM2-Toxic predictions to estimate the potential impact of a more physically realistic model on lake-wide PCB impacts.

Modelers' Response – We do plan to further develop the LM3 models to compare to LM2-Toxic. See

“Modelers’ Response” to comments in Number 4 above. Comparison of the models on a lake-wide basis, such as volume-weighted averages, will be performed.

33. LM3-Toxic: Continue to develop the LM3 Model in order to aid in addressing nearshore impacts which can not be addressed using the LM2 structure.

Modelers’ Response – We will continue to develop LM3-Toxic and LM3-Eutro/Eco to address nearshore impacts as best as can be accomplished within the limitations of the 5 km grid structure. Much finer space scales would need to be implemented in a model, however, in order to model specific harbors associated with an Area of Concern or tributary mouths. In those cases, a finer scaled model would need to be constructed, and LM3 could be used to provide the boundary condition for this finer-scaled model construct.

34. LM3-Toxic: Continue to develop and test the linkage between the POM and LM3 models (both Eutro and Toxic), such as testing to ensure that mass conservation is maintained.

Modelers’ Response – A mass conservation test was performed several years ago on LM3-Toxic using a conservative tracer. During the test, all loadings were shut off. All lake cell concentrations were equal. The model was run for two years, and no noticeable change was detected in the concentrations.

35. LM3-Toxic/SEDZL: Continue to explore linkages or incorporation of SEDZL routines in the Level 3 models. This linkage may be of particular importance in evaluating nearshore trends and issues.

Modelers’ Response – We will continue to pursue linking SEDZL output to Level 3 models as described in the “Modelers’ Response” to Number 4 above.

If we decide to further develop the linkage beyond the current construct, we would likely choose SEDZL-J as it is now being promoted by the experts as the better model to use versus SEDZL. SEDZL-J utilizes SED-Flume data and also allows for non-constant vertical sediment profile data. SED-Flume measures

the total erosion rate on actual sediment cores and includes both the rate at which sediments are transferred to the water column (resuspension), but also the bed-load rate. SEDZL-J includes bed load and bed armoring whereas SEDZL does not. SED-Flume data as well as bulk density profiles have been collected on Lake Michigan cores by the University of California at Santa Barbara. A project to apply SEDZL-J was proposed, but funding was not available. Of course, if bedload, armoring, and non-constant vertical sediment profile data are not issues, then there does not seem to be a great advantage of SEDZL-J over SEDZL. A potential limitation of applying either SEDZL or SEDZL-J's, two-dimensional models to deeper portions of Lake Michigan during stratification exists. At this time, a three-dimensional, SEDZL-J, is not available.

The extent of this impact on our resuspension rate estimates is not known.

References

- Beletsky, D. and D. J. Schwab. 2001. Modeling Circulation and Thermal Structure in Lake Michigan: Annual Cycle and Interannual Variability. *J. Geophys. Res.*, 106(C9):19745-19771.
- Endicott, D.D. 2005. 2002 Lake Michigan Mass Balance Project: Modeling Total PCBs Using the MICHTOX Model. In: R. Rossmann (Ed.), *MICHTOX: A Mass Balance and Bioaccumulation Model for Toxic Chemicals in Lake Michigan, Part 2*. U.S. Environmental Protection Agency, Office of Research and Development, National Health and Environmental Effects Research Laboratory, MED-Duluth, Large Lakes Research Station, Grosse Ile, Michigan. EPA/600/R-05/158, 140 pp.
- Franz, T.P., S.J. Eisenreich, and T.M. Holson. 1998. Dry Deposition of Particulate Polychlorinated Biphenyls and Polycyclic Aromatic Hydrocarbons to Lake Michigan. *Environ. Sci. Technol.*, 32(23):3681-3688.
- Gobas, F.A.P.C., M.N. Z'Graggen, and X. Zhang. 1995. Time Response of the Lake Ontario Ecosystem to Virtual Elimination of PCBs. *Environ. Sci. Technol.*, 29(8):2038-2046.

-
- Hillery, B.R., I. Basu, C.W. Sweet, and R.A. Hites. 1997. Temporal and Spatial Trends in Long-Term Study of Gas-Phase PCB Concentrations near the Great Lakes. *Environ. Sci. Technol.*, 31(6):1811-1816.
- Holsen, T.M., K.E. Noll, S. Liu, and W. Lee. 1991. Dry Deposition of Polychlorinated Biphenyls in Urban Areas. *Environ. Sci. Technol.* 25(6):1075-1081.
- Kuehl, M. 2002. Polychlorinated Biphenyl (PCB) Congener Patterns in Lake Michigan Mass Balance Study Biota. Master's Thesis, University of Wisconsin, Green Bay, Wisconsin. 120 pp.
- Marti, E.A. and D.E. Armstrong. 1990. Polychlorinated Biphenyls in Lake Michigan Tributaries. *J. Great Lakes Res.*, 16(3):396-405.
- McCarty, H.B., J. Schofield, K. Miller, R.N. Brent, P. Van Hoof, and B. Eadie. 2004. Results of the Lake Michigan Mass Balance Study: Polychlorinated Biphenyls and *trans*-Nonachlor Data Report. U.S. Environmental Protection Agency, Great Lakes Program Office, Chicago, Illinois. EPA-905/R-01/011, 289 pp.
- Miller, S.M., M.L. Green, J.V. DePinto, and K.C. Hornbuckle. 2001. Results From the Lake Michigan Mass Balance Study: Concentration and Fluxes of Atmospheric Polychlorinated Biphenyls and *trans*-Nonachlor. *Environ. Sci. Technol.*, 35(2):278-285.
- Schneider, A.R., H.M. Stapleton, J. Cornwell, and J.E. Baker. 2001. Recent Declines in PAH, PCB, and Toxaphene Levels in the Northern Great Lakes as Determined From High Resolution Sediment Cores. *Environ. Sci. Technol.*, 35(19):3809-3815.
- Schwab, D. and D. Beletsky. 1998. Lake Michigan Mass Balance Study: Hydrodynamic Modeling Project. National Oceanic and Atmospheric Administration, Great Lakes Environmental Research Laboratory, Ann Arbor, Michigan. Technical Memorandum ERL GLERL-108, 53 pp.
- Settles, M., W. Melendez, and J. Pauer. 2002. LM3: The Lake Michigan Mass Balance Model. Internal Report. U.S. Environmental Protection Agency, Office of Research and Development, National Health and Environmental Effects Research Laboratory, MED-Duluth, Large Lakes Research Station, Grosse Ile, Michigan. 203 pp.
- Velleux, M. and D.D. Endicott. 1994. Development of a Mass Balance Model for Estimating PCB Export from the Lower Fox River to Green Bay. *J. Great Lakes Res.*, 20(2):416-434.
- Velleux, M., S. Westenbroek, J. Ruppel, M. Settles, and D.D. Endicott. 2000. A User's Guide to IPX, the In-Place Pollutant Export Water Quality Modeling Framework, Version 2.7.4. U.S. Environmental Protection Agency, Office of Research and Development, National Health and Environmental Effects Research Laboratory, MED-Duluth, Large Lakes Research Station, Grosse Ile, Michigan. 179 pp.
- Wethington, D.M. and K.C. Hornbuckle. 2005. Milwaukee, WI, as a Source of Atmospheric PCBs to Lake Michigan. *Environ. Sci. Technol.*, 39(1):57-63.

PART 7

APPENDICES

Appendix 7.2 Comments as Received From Dr. James Martin Peer Review Summary: Lake Michigan Mass Balance Project

James L. Martin
Department of Civil Engineering
Mississippi State University
Mississippi State, Mississippi 39762

7.2.1 General Comments

These comments are based upon a review of the draft (June 24, 2004) documentation "Results of the Lake Michigan Mass Balance Project: PCBs Modeling Report" as well as materials presented and discussed at the July 27-28, 2004 Peer Review Workshop held in Romulus, Michigan. The charge of the peer review was to focus on and address three major categories each with subcomponents, considering strengths and weaknesses:

1. Overall Multimedia Ecosystem Modeling Approach
2. Overall Model Performance
3. Suitability for Management

Each of these topics are discussed below followed by a summary of recommendations for continued and future development.

7.2.1.1 Overall Multi-Media Ecosystem Modeling Approach

The overall multi-media and mass balance approach is a necessity to a system like Lake Michigan where both the biota concentrations are an end-point for management decisions and biota impact the PCB cycling (since such a large component of the organic solids are of biotic origin). It is also necessary to include the hydrodynamics of Lake Michigan, since hydrodynamics impacts contaminant transport. For the analysis of loadings, consideration of loadings from all media (tributaries, the atmosphere, etc.) is also essential. The overall multi-media approach as implemented in the Lake Michigan Mass Balance Project included all of these components. The specific components and their relative importance will shift as issues progress from whole-lake to nearshore areas and from PCBs to other contaminants such as mercury. However, the framework developed for the Lake Michigan mass balance studies will provide a suitable base for the extension of the overall approach into other areas and to other chemicals of concern.

7.2.1.2 Overall Model Performance

The model(s) is (are) considered by this reviewer to adequately represent the physical/biological/chemical processes impacting PCB concentrations in the water, sediment, and biota of Lake Michigan. The present construct is considered limited in its applicability to whole lake issues. However, the extension of the framework to the LM3 level should allow for the modeling system to be used to address nearshore issues as well. The modeling framework

is also suitable as a basis for the development of models of other chemicals of concern, such as mercury.

7.2.1.3 Suitability for Management

An assessment of the suitability of the modeling framework for management requires first delineating the specific management questions that framework will be asked to address. The strength of the studies completed to date is that they provide a framework that can be used in the contributing toward the "weight-of-evidence" with regard to the relative importance of loading sources on the average concentrations of PCBs in the lake as well as in estimating the time required for natural recovery in the water column and biota. To the extent that this weight-of-evidence relates to the management goals for the Lake, the modeling framework is suitable. It integrates the present understanding of factors impacting PCBs in Lake Michigan. While the spatial segmentation of the LM2-Toxic model is more detailed than that of the Level 1 models, the structure is perhaps best suitable for refining whole Lake estimates of PCB concentrations rather than predicting local variations.

However, there are a number of issues, such as nearshore and tributary issues, that the present model Level 2 models cannot address. For example, the LM2-Toxic model cannot be used to address issues related to specific Areas of Concern, other than as a lake-wide average. It is expected that the LM3-Toxic model, when completed, would be more suitable for addressing local variations in PCB concentrations and exposure.

An additional major strength of the study is serving as a framework for the evaluation of available data and in the planning of future data (and modeling) efforts. For example, analyses designed to determine model uncertainty provide not only information concerning predictive uncertainty but can guide monitoring efforts to reduce that uncertainty. An iterative program of model development and data collection may provide for the most efficient use of limited resources, particularly given the reasonably long time frame before some of the issues (such as the Total Maximum Daily Load (TMDL) for Lake Ontario) need to be addressed. This iterative

approach to the collection and analysis of data, exemplified by the Levels 1 and 2 studies and leading to Level 3 is clearly an effective means of organizing all of the myriad efforts and parties involved in the collection and analysis of data. The participants are to be commended on the demonstrated efficacy of the use of the mass balance approach in the design of the PCB study.

7.2.2 Specific Recommendations

7.2.2.1 POM and Linkages

1. Continue development of the linked POM and Level 2 and Level 3 models.
2. Provide documentation of the POM application, perhaps as an appendix to the modeling report.
3. Assist in developing ice cover algorithms and linkages with water quality model.
4. Investigate potential linkages issues between POM and with SEDZL.
5. Investigate assumptions/limitations of using a sigma grid, particularly in resolving both nearshore and open-lake issues.

7.2.2.2 LM2-Eutro and LM3-Eutro

1. Continue to develop the Eutro model, for both linkages to the Toxic model as well as for use related to addressing conventional pollution in Lake Michigan and its tributaries/embayments.
2. Explore and document methods to relate measurable field data to model input values (e.g., refractory particulate organic matter).
3. Conduct additional calibration (e.g., to nitrogen series) as an additional test of the model's performance and if the model may be used to address questions in the future with regard to conventional pollution.
4. Consider including a sediment diagenesis model if Eutro will be used in the future to address management questions related to conventional pollution.

-
5. Consider exploring a more direct linkage with the food chain model, to address potential changes in the food chain structure.

7.2.2.3 Level 1 Model

1. Continue to maintain the Level 1 model, particularly for comparison with Level 2 predictions.
2. Explore incorporating specific algorithms, such as the steady-state algorithm, with the Level 2 and potentially Level 3 models.

7.2.2.4 LM2-Toxic

1. Test the linkage with the POM model by running conservative tracer test to insure that a mass balance is maintained.
2. Revisit and refine sediment component of the model (e.g., number of layers).
3. Extend the calibration period to an evaluation of historical loadings and/or a period encompassing all available data (not just the 1994-1995 data set).
4. Investigate why similar predictions were obtained to those from the Level 1 for what appears to be dissimilar reasons (differences in settling velocities, diffusion rates, bed thickness, etc.).
5. Apply the model to refine whole-lake estimates of PCB concentrations.
6. Extend the modeling framework to include other contaminants of concern (e.g., mercury).

7.2.2.5 LM Food Chain

1. Continue to develop and refine the food chain model.
2. Extend the calibration period to an evaluation of historical loadings and/or a period encompassing all available data (not just the 1994-1995 data set).
3. Consider investigating a more direct linkage with biotic models (such as LM3-Eutro).

4. Use the model along with any revisions made to LM2-Toxic to refine estimates of future trends in fish PCB concentrations.

5. Initiate extending the model (and data analysis) to other pollutants of concern (e.g., mercury).

7.2.2.6 LM3-Toxic

1. Continue to develop the LM3 model in order to test against the LM2-Toxic predictions to estimate the potential impact of a more physically realistic model on lake-wide PCB impacts.
2. Continue to develop the LM3 model in order to aid in addressing nearshore impacts which can not be addressed using the LM2 structure.
3. Continue to develop and test the linkage between the POM and LM3 models (both Eutro and Toxic), such as testing to ensure that mass conservation is maintained.
4. Continue to explore linkages or incorporation of SEDZL routines in the Level 3 models. This linkage may be of particular importance in evaluating nearshore trends and issues.

7.2.3 Specific Comments

What follows are some specific comments and observations regarding each of the modeling components. Some of these comments request clarification of specific assumptions and methods used in the development of the models. While the documentation provided was extensive, there were specific areas identified where additional information and/or clarification would be helpful.

7.2.3.1 Hydrodynamics and POM Linkage

The hydrodynamic model used in this application for LM3-Eutro, and planned for LM3-Toxic, is the Princeton Ocean Model (POM). POM is widely used and accepted and is similar in construct to several other hydrodynamic models in common usage (e.g., the ECOM model, which was based largely on POM, and EFDC). However, there was no information provided in the subject modeling report as to the model application and testing of the model, particularly with regard to an assessment of the

applicability of the model to the transport of PCBs and other water quality constituents. The information provided was limited to a brief presentation by D'mitry Beletsky and David Schwab. As such, there was not sufficient information presented to assess the application or performance of the hydrodynamic model. Since the hydrodynamic model is a critical component of the Levels 2 and 3 studies, it is suggested that documentation of the model application be provided in the PCB modeling report, perhaps as an appendix.

One potential limitation to the POM model construct (relative to this application) is related to the coordinate system used in the vertical dimension (a sigma grid). A sigma grid requires a constant number of vertical layers throughout the model domain (beneath each of the 5 km horizontal grid cells (the number of vertical layers was variously cited as from 15 to 20 in the modeling report, which should be corrected). This use of the sigma grid may impact the ability of the model to resolve vertical gradients, particularly in deeper sections of the lake while still sufficiently capturing nearshore circulation patterns. In addition, sigma grids may produce artificial horizontal transport patterns. While there are numerical schemes for compensating for this, I am not aware that they have been implemented in POM or that any sigma transport tests have been conducted for an application such as Lake Michigan.

A second potential limitation of the POM model is its present inability to predict ice cover. From the presentations, it was suggested that ice algorithms will be added to the model and it is recommended that the incorporation of ice algorithms be pursued.

The linkage of the POM model with the LM3-Eutro grid was only briefly discussed. The incorporation of the QUICKEST-ULTIMATE routines from the U.S. Army Corps of Engineers CE-QUAL-ICM model should provide a suitable numerical framework for that linkage. However, the linkage of hydrodynamic and water quality models, even using a one-to-one spatial grid, is not a trivial task. For example, because of differing solution schemes, mass imbalances can occur which, if not properly treated, can accumulate and impact long-term model predictions. As such, testing is required to ensure that water and constituent mass are conserved globally and locally in the linked water quality model.

This testing needs to be documented and should be included in the modeling report, perhaps as an appendix.

An overlay grid, such as between the POM model and LM2-Eutro and LM2-Toxic is often more problematic than using a one-to-one spatial grid (between a hydrodynamic and water quality model). In this application, it was suggested that linkage problems did occur resulting in the necessity of adding "water balancing flows" (Part 4, Chapter 3, Section 4.3.3). Adding water-balancing flows is not an uncommon practice in linking three-dimensional hydrodynamic and water quality models. Typically those flows are small but without them water volume imbalances accumulate over time. However, it was indicated during presentations that in this study, not including the "balancing" flows resulted in water volumes going to zero in some water quality segments (in Green Bay). This is indicative of a linkage problem that should be further investigated. In addition, the approach used to compute vertical exchanges (Equation 4.1.1) should not have been applicable if vertical flows (gross not net) were included with the hydrodynamic linkage. It is suggested that additional testing of the linkage be conducted and documented within the modeling report, perhaps as an appendix.

In addition to spatial averaging, there was apparently time-averaging of hydrodynamic predictions as well, allowing a daily time-scale for the LM2-Toxic model. The procedures used to average the hydrodynamic predictions, and tests conducted to determine the impact of that averaging, should be documented.

In general, the linkage of POM with the LM models represents an advancement and provides additional capabilities that should be continued to be developed. For example, the coupled model should more accurately predict the transport patterns in the lake, which are always of questionable accuracy when based on purely descriptive techniques. In addition, the coupled model may be more readily applied to predict conditions in more localized areas, such as nearshore, and to predict conditions (such as extreme events) that cannot be adequately characterized using a descriptive approach.

7.2.3.2 LM2-Eutro and LM3-Eutro

The eutrophication model is an important component of the overall multi-media modeling approach. The addition of an eutrophication model is of particular importance for Lake Michigan due to the reported large fraction of total sorbents that are of biotic origin (reported to be 90 percent of the total organic carbon load to the lake, Part 4, Chapter 3, Section 4.3.4). The overall structure of the eutrophication model seems reasonable, and seems comparable to other eutrophication models. The majority of the comments provided below are related to clarifications that would be helpful in the modeling report.

Some additional description is needed as to how the field data (as listed in Table 1.1.2) were converted to model input or used for model comparisons. Table 2.4.6 lists the two "types" of data but does not describe how the transformations were made. Table 1.1.2 does not indicate that zooplankton were a measured parameter, although it is a model state variable and the text indicate that zooplankton data were collected (Part 2, Chapter 4, Section 2.4.2.2.4). Also, while I agree that the expansion of variables to include dissolved organic and labile and refractory particulate organic forms allows for more realistic description (which is an increasingly common practice) there are no established protocols for measuring these forms. Therefore, it must have been necessary to make assumptions regarding, for example, the partitioning of particulates among labile and refractory forms. Those assumptions should be described in the report, and perhaps some sensitivity analyses performed as to the impact of differing assumptions on model predictions. The assumptions regarding the split were indicated (Part 2, Chapter 4, Section 2.4.1.1) for atmospheric loads, but not for other loading sources that this reviewer could find.

In Part 2, Chapter 4, Section 2.4.4.2, it is stated that laboratory primary production rates were used to verify the overall production rates in the model. These comparisons should be included in the modeling report.

The characterization of non-diatoms versus diatoms is a useful breakdown. Since blue-greens were the dominant algae, some additional explanation would be worthwhile as to how nitrogen limitation was computed for these algae.

The section of the report (Chapter 1) dealing with the calibration of the LM2-Eutro and LM3-Eutro was somewhat confusing, with regard to which model was calibrated against existing data.

The comparisons of model predictions and field data were somewhat limited in Chapter 5. Additional comparisons should be provided, both graphical and statistical, between model predictions and observed data. Comparisons should be provided if possible for all state variables. For example, no comparisons are presently provided for nitrogen species.

Presently, the LM2-Eutro and the LM3-Eutro codes specify sediment fluxes as zero order rates, which is a common practice. However, there are models of sediment diagenesis that allow prediction, rather than description, of those rates. While probably not critical in the context of using the Eutro predictions for input to the Toxic model, incorporation of a sediment diagenesis model may be worthwhile should the LM3-Eutro model be used in the future to assess eutrophication-related management questions.

In general, the linkage of the Lake Michigan eutrophication and toxicant models represents an advancement and provides additional capabilities that should be continued to be developed. This reviewer considers the existing eutrophication model construct sufficient for its intended use, to provide biotic solids for the toxicant model. However, the eutrophication model is also considered important in its own right, and should have applicability in addressing questions regarding conventional pollutants in Lake Michigan. In addition, perhaps some more direct coupling of the eutrophication and food chain model could be considered in future applications, to aid in addressing questions regarding impacts of changes in food chain structure on uptake of PCBs and other toxicants.

7.2.3.3 Level 1 Models

The inclusion of the Level 1 model in the modeling report and presentations, and the contrasting of model construct and predictions with the Level 2 model, was considered by this reviewer to be very useful. First, the Level 1 model and its predictions were useful in providing insights into factors impacting PCBs in Lake Michigan and addressing interim management questions. In addition, the Level 1 modeling studies illustrated what this

reviewer considers to be one of the best uses of models and modeling studies: to first aid in mining and interpreting available data, to then identify deficiencies in available data and modeling approaches, and finally to aid in planning additional studies and model refinements.

One area that perhaps deserves further investigation is the similarity in predictions of the Level 1 and Level 2 models. Both models predicted remarkably similar changes in total PCB concentrations over time in the long-term projections. However, there were differences between the two models such as in the rates of settling/resuspension used and in the characterization of the sediment bed. As a result, the two models predicted similar results for somewhat dissimilar reasons. It would be of interest to further investigate factors leading to the similarity in predictions, which may provide some additional insights as to factors controlling PCBs in Lake Michigan.

There were some capabilities of the Level 1 model which should be considered for incorporation into the Level 2 model. One such capability is the steady-state solution. A goal in future studies, as expressed during the presentations, was to assess uncertainty in the Level 2 model. Uncertainty is most commonly assessed using steady-state rather than dynamic predictions. The long simulation time required to achieve steady-state predictions in the dynamic Level 2 model may preclude conducting uncertainty analyses. Incorporating steady-state solution techniques in the Level 2 (and ultimately the Level 3 model) would facilitate the analysis.

7.2.3.4 LM2-Toxic

The Level 2-Toxic model represents an advancement over its predecessor, the Level 1 model. These advancements not only include simulation of PCB congeners, but improvements in transformation kinetics, such as volatilization. A number of these improvements resulted from Level 2 investigations, and the study serves as a very good example of the benefits achieved through the iterative development and refinements of models

The coupling of the POM predictions to the Level 2 model seems a reasonable approach. However, using a 1-1 grid rather than a course-grid overlaying

a fine-grid hydrodynamic model is a preferable approach, which is the approach planned for the Level 3 model. Several recommendations regarding testing of the linkage between the POM hydrodynamic model and both the LM2-Toxic and LM3-Toxic model were discussed in a previous section.

With regards to solids transport, the approach used for computing sediment resuspension seems reasonable. However, it is hoped that a more detailed sediment model (SEDZL, which was part of the original plan) can be incorporated into the Level 3 framework. The settling velocities used also seem reasonable but are lower than those used in the Level 1 study. Since the estimated resuspension velocities will vary with the settling velocities, the rates used are also presumably lower than those used in the Level 1 studies. Since the projections of the two models were remarkably similar, some additional investigation as to why similar predictions were obtained using dissimilar rates would be worthwhile.

The sediment bed model seems reasonable. However, some additional clarification of the semi-Lagrangian method for simulating the sediment bed (Part 4, Chapter 3, Section 4.3.4.2.3) would be useful. In addition, the present construct does not allow for the tracking of materials buried out of the layer, or perhaps entrained into the layer from deeper contaminated sediments. Some additional development of the sediment algorithms would be useful for the Level 2 model and for incorporation into the Level 3 framework (where it may be more important with regard to nearshore issues).

As indicated in Part 4, Chapter 6, Section 4.6.2, the flux contributed by the diffusive term from the sediment bed was unexpectedly large relative to the resuspension flux. This may have been due to the relatively large specified diffusion coefficient used relative to the Level 1 model. As suggested above, some additional testing is recommended to compute and compare factors causing predicted variations between the Level 1 and Level 2 studies, and the diffusive fluxes should be considered in that testing. In addition, it was indicated in Part 4, Chapter 6, Section 4.6.2 that the total PCB residence time for Lake Michigan were on the order of 100 days. This estimate seems low to this reviewer. It would be

interesting to see how this compares to predictions from a Level 3 model which may more realistically estimate vertical exchanges in layers isolated from the water surface. The Level 3 model could be used to determine if the rapid removal may be in part an artifact of the modeling approach used in the Level 2 studies. As an example, given the rates of settling used, surface particles would require approximately one year to reach the bottom, while with a single vertical-box model it would be assumed that vertical transport is on-average instantaneous.

The comparisons of measured and simulated concentrations seem reasonable. However, since differences occur between factors controlling PCBs in Lake Michigan and Green Bay, the results for these two systems should be reported separately.

One limitation to the Level 2 application, and to many similar studies, was the limited time-scale to which the model was applied. The model was applied and calibrated using data from the 1994 and 1995 field studies. Given the time scale of changes in Lake Michigan PCB concentrations, this period is not sufficient to test the model against long-term trends

in the PCB concentrations for Lake Michigan. Similarly to the Level 1 studies, it would be worthwhile as an additional test to run the model with estimated historical loadings and for comparison to all existing data, including data from this sampling period. Such an application would provide additional testing of the robustness of the model, particularly since the models intended use is in the projection of long-term trends in PCB concentrations for Lake Michigan.

7.2.3.5 LM Food Chain

The food chain model used in this study was based upon what I consider to be a widely accepted approach and which I consider adequate for the purposes of this study. However, my experience in food chain modeling is limited and dated so I would defer to others with more recent experience to evaluate this component of the model. As with the LM2-Toxic model, the application of the model to a longer period of record is recommended as an additional test of the model.