



Guidance for Developing Quality Systems for Environmental Programs

EPA QA/G-1

Quality

FOREWORD

The U.S. Environmental Protection Agency (EPA) has developed an Agency-wide program of quality systems for environmental data. EPA's Quality System requires documentation of both management and technical activities. This document, *Guidance for Developing EPA Quality Systems for Environmental Programs*, provides methods and tools for developing and documenting the elements of a functional quality system. It is pertinent to organizations that carry out environmental data operations within or for EPA.

This document helps organizations design a structured management system for ensuring quality in its work processes, products, and services. The EPA's Quality System has been built to ensure that environmental programs are supported by the type and quality of data needed for their appropriate use. As required by the *EPA Quality Manual for Environmental Programs*, Order 5360 A1 (EPA, 2000a), this document is valid for up to five years from the official date of publication. After five years, this document will be reissued without change, revised, or withdrawn from the *U.S. Environmental Protection Agency Quality System Series* documents.

This document provides guidance to EPA employees and other organizations involved in quality system development. It does not impose legally binding requirements on EPA or the public and may not apply to a particular situation based on the circumstances. EPA retains the discretion to adopt approaches on a case-by-case basis that differ from this guidance where appropriate. Interested parties are free to raise questions about the recommendations in this document and the appropriateness of using them in a particular situation, and EPA and other parties should consider whether the recommendations in the document are appropriate for the particular situation. EPA may periodically revise this guidance without public notice.

This document is one of the *EPA Quality System Series* documents, which describe policies and procedures for planning, implementing, and assessing the effectiveness of a quality system. Questions regarding this document or other *EPA Quality System Series* documents can be directed to:

U.S. EPA
Quality Staff (2811R)
1200 Pennsylvania Ave., N.W.
Washington, D.C. 20460
Phone: (202) 564-6830
Fax: (202) 565-2441
e-mail: quality@epa.gov

Copies of *EPA Quality System Series* documents may be obtained from the Quality Staff directly or by downloading them from its Home Page, www.epa.gov/quality.

TABLE OF CONTENTS

	<u>Page</u>
1.0 INTRODUCTION	1
1.1 PURPOSE AND SCOPE	1
1.2 SUPERSESSION	3
1.3 PERIOD OF APPLICABILITY	4
1.4 HOW TO USE THIS GUIDANCE DOCUMENT	4
2.0 ELEMENTS OF A QUALITY SYSTEM	5
2.1 THE EPA QUALITY SYSTEM MODEL	5
2.1.1 Specifications for EPA Organizations	7
2.1.2 Specifications for Non-EPA Organizations	8
2.2 QUALITY SYSTEM STANDARDS AND MODELS	10
2.2.1 Elements of the ANSI/ASQC E4-1994 Quality System Standard	10
2.2.2 Other Quality System Standards and Models	10
3.0 HOW TO DEVELOP A QUALITY SYSTEM	13
3.1 OVERVIEW OF THE QUALITY SYSTEM DEVELOPMENT PROCESS	13
3.1.1 Quality Systems for Small Organizations	14
3.2 INITIATION ACTIVITIES	16
3.2.1 Senior Management Commitment	16
3.2.2 Quality System Development Team	17
3.2.3 Establish Quality Policy	20
3.2.4 Analyze Requirements	21
3.2.5 Inventory Existing Quality Procedures and Practices	22
3.2.6 Obtain Management Approvals, Resources for Development	23
3.3 DEVELOPMENT ACTIVITIES	25
3.3.1 Assign Tasks and Develop Detailed Schedule	26
3.3.2 Analyze Work Processes Using a Quality System Model	27
3.3.3 Write Standard Operating Procedures	29
3.3.4 Write a Quality Management Plan	31
3.3.5 Develop Supporting Systems and Tools	33
3.3.6 Conduct Detailed Compliance Audit	33
3.3.7 Obtain Management Approvals and Resources for Implementation	34
3.4 IMPLEMENTATION AND START-UP ACTIVITIES	35
3.4.1 Determine the Implementation Strategy and Schedule	36
3.4.2 Publish and Distribute Quality Management Plan and Quality Procedures	38
3.4.3 Training	38

	<u>Page</u>
3.4.4	Communications 40
3.4.5	Establish a Program for Recognizing Quality Performance 41
3.4.6	Initiate Quality Procedures and Maintain Records 41
3.4.7	Conduct Periodic Internal Quality System Audits 42
3.4.8	Corrective Actions 43
3.4.9	Identify Improvements 44
3.5	ONGOING MAINTENANCE AND IMPROVEMENT 45
3.5.1	Allocate Resources per the Budget Cycle 45
3.5.2	Conduct Routine Quality Assurance 46
3.5.3	Implement Improvements 46
3.5.4	Conduct Periodic Self-Assessment of this Quality System 47
3.5.5	Maintain Quality Training, Communications, and Recognition and Rewards Programs 47
4.0	CASE STUDIES 51
4.1	QUALITY SYSTEM DEVELOPMENT IN AN ENVIRONMENTAL CONSULTING FIRM 51
4.1.1	Background 51
4.1.2	Initiation 52
4.1.3	Development 56
4.1.4	Implementation 59
4.1.5	On-going Maintenance and Improvement 60
4.2	QUALITY SYSTEM DEVELOPMENT IN AN EPA REGULATORY PROGRAM: SIX-YEAR REVIEW OF NATIONAL PRIMARY DRINKING WATER STANDARDS 61
4.2.1	Background 61
4.2.2	Initiation 62
4.2.3	Development 62
4.2.4	Implementation 63
4.2.5	On-going Maintenance and Improvement 64
5.0	TOOLS AND METHODS USED IN DEVELOPING QUALITY SYSTEMS 67
5.1	INTRODUCTION 67
5.2	STANDARD OPERATING PROCEDURES TEMPLATES 67
5.3	QUALITY MANAGEMENT PLANS 68
5.4	QUALITY MANUALS 69
5.5	DOCUMENT CONTROL AND RECORDS MANAGEMENT SYSTEMS 71
5.6	QUALITY SYSTEM COMPLIANCE CHECKLISTS 72
5.7	PROCESS ANALYSIS AND IMPROVEMENT TOOLS 72

	<u>Page</u>
5.7.1 Process Flow Charts	72
5.7.2 Control Charts	73
5.7.3 Cause-and-Effect (Fishbone) Diagrams	74
5.7.4 Pareto Charts	74
5.7.5 Benchmarking	76
5.7.6 Scheduling Tools	79

APPENDIX A: QUALITY SYSTEM CHECKLIST	A-1
APPENDIX B: REFERENCES	B-1
APPENDIX C: QUALITY ASSURANCE CONCEPTS	C-1
APPENDIX D: GLOSSARY OF TERMS	D-1

LIST OF FIGURES

	<u>Page</u>
Figure 1.	The EPA Quality System 6
Figure 2.	A Four-Phase Process for Developing a Quality System 13
Figure 3.	Initiating the Quality System (Phase 1) 16
Figure 4.	Developing the Quality System (Phase 2) 26
Figure 5.	Standard Diagram of a Work Process 28
Figure 6.	Implementing the Quality System (Phase 3) 36
Figure 7.	Ongoing Maintenance and Improvement (Phase 4) 46
Figure 8.	Quality System for the Six-Year Review 63
Figure 9.	Data Sources for Occurrence and Exposure Assessments 66
Figure 10.	Example of a Process Flow Chart 73
Figure 11.	Control Chart Showing a Process Under Statistical Control 74
Figure 12.	Example of a Cause-and-Effect (Fishbone) Diagram 75
Figure 13.	Example of a Pareto Chart 75
Figure 14.	Project Gantt Chart 80
Figure 15.	PERT Chart 80

LIST OF TABLES

	<u>Page</u>
Table 1.	Quality-Related Regulations and Agreements by Organization 8
Table 2.	Agency-wide Internal and External Quality Policies 9
Table 3.	Elements of the ANSI/ASQC E4-1994 Quality System Standard 11
Table 4.	Standards Relating to Quality Systems 11
Table 5.	Example General Schedule for Development of a Quality System 19
Table 6.	Example Detailed Schedule for Development of a Quality Management Plan 26
Table 7.	Quality System Elements Required for the MRI Environmental Monitoring Group . . 53
Table 8.	Assessment of Department Practices 57
Table 9.	Sample Quality System Development Activities for the 2000 Six-Year Review 65
Table 10.	Reasons for Benchmarking 79

LIST OF ABBREVIATIONS

ANSI/ASQ	American National Standards Institute/American Society for Quality
ASTM	American Society for Testing and Materials
CFR	Code of Federal Regulations
EPA	Environmental Protection Agency
GPO	Government Printing Office
ISO	International Organization for Standardization
MRI	Marine Research Institute
MTE	Measurement and Testing Equipment
NPDWRs	National Primary Drinking Water Regulations
OAQPS	Office of Air Quality Planning and Standards
OCW	Office of Clean Water
PERT	Program Evaluation and Review Technique
QA	Quality Assurance
QC	Quality Control
QSDT	Quality System Development Team
SDEP	State Department of Environmental Programs
SOP	Standard Operating Procedures

CHAPTER 1

INTRODUCTION

1.1 PURPOSE AND SCOPE

What does this guidance cover?

This guidance document provides methods and tools to help organizations develop a quality system that meets its internal organizational needs and complies with U.S. Environmental Protection Agency (EPA) requirements for quality systems. EPA's policies for quality systems are outlined in EPA's *Policy and Program Requirements for the Mandatory Agency-wide Quality System*, Order 5360.1 A2 (EPA, 2000a); *EPA Quality Manual for Environmental Programs*, Manual 5360 A1 (EPA, 2000b); and the Federal Regulations (48 CFR 46; 40 CFR 30, 31, and 35).

Other general environmental quality system specifications applicable to EPA's programs are described in the American National Standards Institute/American Society for Quality (ANSI/ASQ) E4-1994, *Specifications and Guidelines for Quality Systems for Environmental Data Collection and Environmental Technology Programs* (ANSI/ASQ, 1995). This document outlines the basic guidelines for planning, implementing, and assessing a quality system for environmental data collection and environmental technology. ANSI/ASQ's standards apply to quality systems for air and water quality monitoring, pollution control technology development, sampling and analysis for environmental impact studies, hazardous waste investigations, and a variety of other activities.

What is a quality system?

A quality system is the means by which an organization manages its quality aspects in a systematic, organized manner. It provides a framework for planning, implementing, and assessing work performed by an organization and for carrying out required quality assurance (QA) and quality control (QC) activities. It encompasses a variety of technical and administrative elements, including:

- C policies and objectives,
- C organizational authority,
- C responsibilities,
- C accountability, and
- C procedures and practices.

What are the purpose and scope of the EPA Quality System?

The EPA Quality System is a management system that provides the necessary elements to plan, implement, document, and assess the effectiveness of QA and QC activities applied to environmental programs conducted by or for EPA. The EPA Quality System encompasses the collection, evaluation, and use of environmental data by or for EPA, and the design, construction, and operation of environmental technology by or for EPA. This includes environmental programs such as the demonstration of environmental technology; investigation of chemical, biological, physical, or radioactive constituents; development, evaluation, and use of computer or mathematical models; use of data collected for other purposes or from other sources (also called secondary data); and the collection and use of data pertaining to the occupational health and safety of personnel in EPA facilities. Example programs are listed in Section 1.3 of the EPA Manual 5360 A1 (EPA, 2001b).

What are the benefits of EPA's quality system?

Successful implementation of the EPA Quality System leads to the benefits outlined below.

- C Scientific Data Integrity—EPA will be better able to produce data of known and documented quality based on sound scientific principles.
- C Reduced or Justifiable Resource Expenditures—Resource expenditures can be reduced if EPA's information needs are more closely matched to the information collection. Through proper planning, only the correct type, amount, and quality of data will be collected for EPA use.
- C Proper Evaluation of Internal and External Activities—The EPA Quality System provides documentation of activities and improved oversight for evaluation purposes. This reduces the potential for waste and abuse.
- C Reliable and Defensible Decisions—When the quality of data are better known, determining whether the data can be used for a specific decision is facilitated. This reduces embarrassing surprises and challenges to regulations, permit appeals, etc.
- C Burden Reduction—As EPA better defines the data needed for a specific application, the burden on other organizations who are required to collect and/or report data to EPA may be reduced.

Overall, implementation of the EPA Quality System will reduce the Agency's vulnerabilities and increase EPA's ability to make reliable, cost-effective, and defensible decisions.

Who should read this guidance?

This document is intended for managers and quality professionals within EPA organizations (program offices, laboratories, and regional offices); states, tribal governments, recipients of external assistance agreements; and EPA contractors.

Is my organization required to follow this guidance?

No. This is non-mandatory guidance intended to help organizations apply EPA policies and apply quality management concepts and best practices to their own circumstances. The process described in this guidance for developing a quality system is only one of many possible approaches for developing a quality system. While the general process described here should work for most organizations, the specific details will need to be tailored to each organization.

How does this guidance document relate to other the EPA Quality System documents?

This guidance describes a process for developing a quality system that follows EPA Quality System policies set forth in EPA Order 5360.1 A2 while also meeting the internal needs of an organization. Consequently, this guidance addresses the organizational development processes and related tools that can be employed to establish a working quality system. Most of the other *EPA Quality System Series* documents focus on a specific managerial or technical element of the EPA Quality System, at either the organizational or project level. This guidance describes how an organization assembles these elements into a coherent quality system. EPA QA/R-2 provides the specifications for documenting the quality system.

Where can I find more information?

Additional documents, tools, training, and technical assistance are available through the EPA Quality Staff (see the Foreword for contact information). Many additional resources are available for downloading at the Quality Staff website: www.epa.gov/quality.

1.2 SUPERSESSION

No previous guidance on developing quality systems has been issued by the EPA Quality System staff. Therefore, this document does not supersede any other documents.

1.3 PERIOD OF APPLICABILITY

As described in the EPA Quality Manual (5360 A1), this document will be valid for 5 years from the official date of publication. After 5 years, this document will either be reissued without change, revised, or withdrawn from the EPA Quality System.

1.4 HOW TO USE THIS GUIDANCE DOCUMENT

If you are interested in learning about...	then read
Principles underlying quality management and the core elements of a quality system	Chapter 2
Activities necessary to develop a quality system that meets your organization's needs	Chapter 3
An example of quality system development in a narrative case study format	Chapter 4
Tools and methodologies that may help in the development of your quality system	Chapter 5
References and supplemental reading	References
Definitions of important quality management terms	Glossary

CHAPTER 2

ELEMENTS OF A QUALITY SYSTEM

This chapter will answer the following questions:

- C What are the components of the EPA Quality System?
- C What are the requirements of the Quality System for EPA organizations?
- C What are other Quality System standards that government agencies and private organizations need to consider?

2.1 THE EPA QUALITY SYSTEM MODEL

The EPA Quality System integrates management and technical activities for the planning, implementation, and assessment of environmental programs within the Agency's mission and scope. The EPA's Quality System has been designed to ensure that environmental programs are supported by the type, quality, and quantity of data needed for their intended use. The EPA Quality System integrates policy and procedures, organizational responsibilities, and individual accountability.

The ANSI/ASQ E4-1994, *Specifications and Guidelines for Quality Systems for Environmental Data Collection and Environmental Technology Programs* (ANSI/ASQ, 1995) specifically defines a quality system as:

...a structured and documented system describing the policies, objectives, principles, organizational authority, responsibilities, accountability, and implementation plan of an organization for ensuring the quality in its work processes, products, items, and services. The quality system provides the framework for planning, implementing, and assessing work performed by the organization and for carrying out required QA and QC.

The EPA Quality System is depicted graphically in Figure 1. At the policy level, EPA's primary internal policy directives are *EPA Policy and Program Requirements for the Mandatory Agency-wide Quality System*, Order 5360.1 A2 (EPA, 2000b) and *EPA Quality Manual for Environmental Programs*, Manual 5360 A1 (EPA, 2000a), which are derived in part from national and international consensus standards on quality systems, as further explained below. EPA requirements affecting external organizations are reflected in regulations addressing contracts and assistance agreements. EPA program and regional offices establish policies that are consistent with Agency-wide policies. At the organizational level, the quality system features documentation [written in a Quality Management Plan (QMP)], systems assessments (such as Management Systems

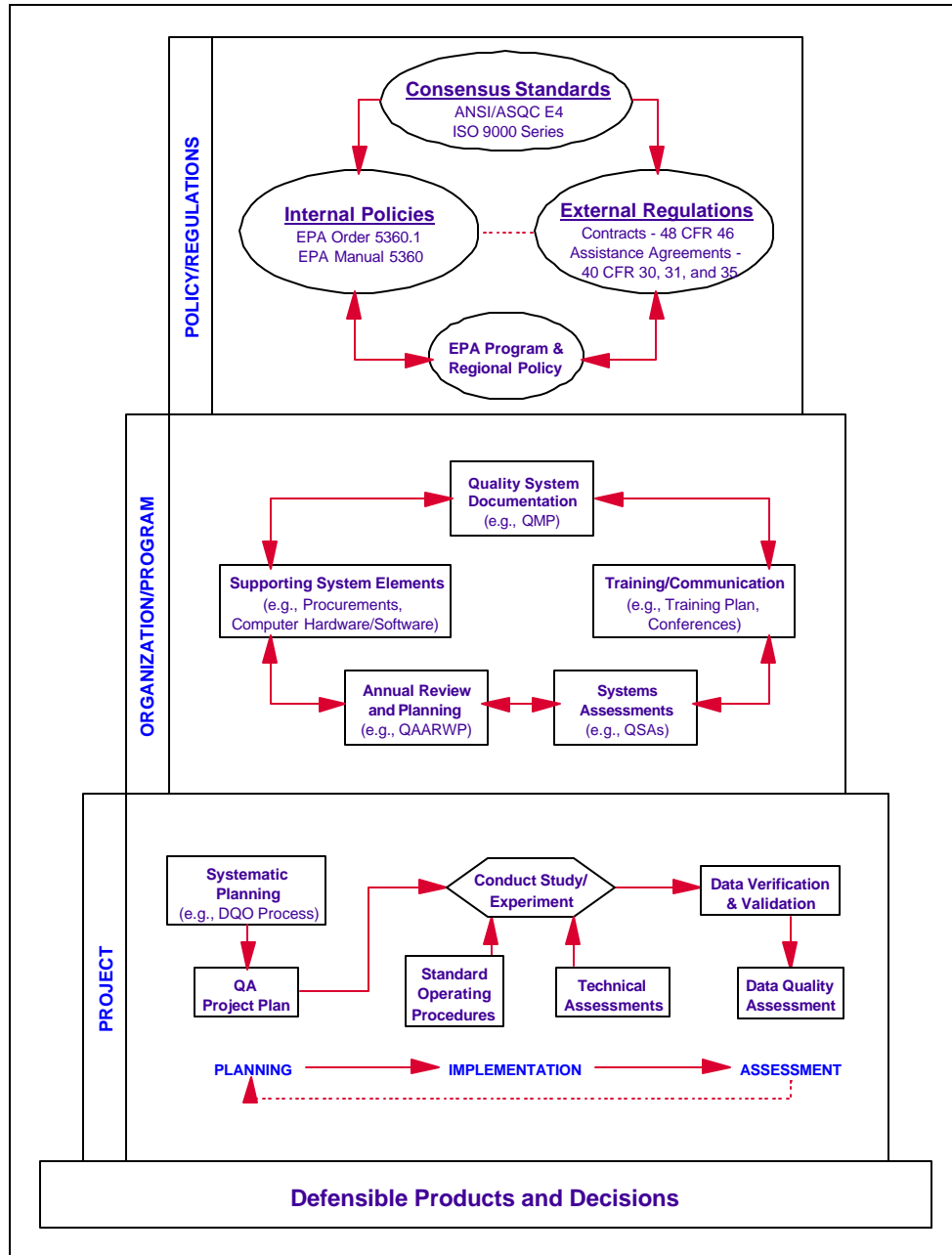

Figure 1. The EPA Quality System

Reviews or Quality System Audits), annual reviews and planning documents (written in the QA Annual Report and Work Plan), training and communications, and supporting system elements (such as purchasing systems, information management systems, etc.). Implementation of each component or tool reflects EPA's needs with respect to its environmental data operations and Agency policies. At the project level, planning, implementation, and assessment activities are applied to EPA's data generation, acquisition, and use. In the planning phases of project management, EPA data users apply a systematic

planning process (such as the data quality objectives process) to specify performance criteria for data operations, which are documented in a QA Project Plan. In the implementation phase, technical audits and assessments are used to ensure that data are being acquired as stated in the EPA QA Project Plan. In the assessment phase, data are formally verified and validated to ensure that they are free of major errors and are then analyzed to determine if performance criteria have been met.

2.1.1 Specifications for EPA Organizations

EPA Order 5360.1 A2 (EPA, 2000b) defines basic quality management specifications for all EPA organizations covered by the EPA Quality System. These specifications are summarized below.

1. Conform to the minimum specifications of ANSI/ASQ E4-1994.
2. Identify a QA Manager who reports on quality issues to senior executive leadership and ensure that this QA Manager functions independently of direct environmental data generation, model development, or technology development responsibility.
3. Develop a Quality Management Plan and implement this plan following Agency approval.
4. Provide sufficient resources to implement the quality system.
5. Perform assessments of the effectiveness of the quality system at least annually and implement corrective actions based on assessment results in a timely manner.
6. Submit a QA Annual Report and Work Plan for the organization that summarizes the previous year's activities and outlines the work proposed for the current year.
7. Use a systematic planning approach to develop acceptance or performance criteria for all work covered by the EPA Quality System.
8. Have approved QA Project Plans, or equivalent documents, for all applicable EPA projects and tasks involving environmental data.
9. Assess existing data when used to support Agency decisions or other secondary purposes to verify that they are of sufficient quantity and adequate quality for their intended use.
10. Implement Agency-wide Quality System requirements in all applicable EPA-funded extramural agreements.

11. Implement corrective actions based on assessment results.
12. Provide appropriate training for all management and staff to assure that QA and QC responsibilities and requirements are understood at every stage of implementation.

2.1.2 Specifications for Non-EPA Organizations

Agency-wide Quality System specifications may also apply to non-EPA organizations that collect or analyze data for or in association with EPA. These specifications are defined in the applicable regulations governing extramural agreements, as shown in Tables 1 and 2. Agency-wide Quality System specifications may also be invoked as part of negotiated agreements, such as a memorandum of understanding. Non-EPA organizations that may be subject to quality system specifications include:

- any organization or individual under a direct contract to EPA to furnish services or items or perform work (i.e., a contractor) under the authority of 48 CFR 46, (including applicable work assignments, delivery orders, and task orders);

Table 1. Quality-Related Regulations and Agreements by Organization

	Contract	Cooperative Agreement	Grant	Inter-Agency Agreement	Other Specifications
EPA	N/A	N/A	N/A	N/A	EPA Order 5360.1 A2, ANSI/ASQ E4-1994
Contractor	48 CFR 46	N/A	N/A	N/A	N/A
Federal Agency	N/A	N/A	N/A	Negotiated into each agreement	Contained in specific Federal Regulation that requires data
Hospital	48 CFR 46	40 CFR 30	40 CFR 30	N/A	Contained in specific Federal Regulation that requires data
University	48 CFR 46	40 CFR 30	40 CFR 30	N/A	Contained in specific Federal Regulation that requires data
Local Government	48 CFR 46	40 CFR 31, 40 CFR 35	40 CFR 31, 40 CFR 35	N/A	Contained in specific Federal Regulation that requires data
Non-profit Organization	48 CFR 46	40 CFR 30	40 CFR 30	N/A	Contained in specific Federal Regulation that requires data
Regulated Entity	N/A	N/A	N/A	N/A	Contained in specific Federal Regulation that requires data
State Government	48 CFR 46	40 CFR 31, 40 CFR 35	40 CFR 31, 40 CFR 35	N/A	Contained in specific Federal Regulation that requires data
Tribal Government	48 CFR 46	40 CFR 31, 40 CFR 35	40 CFR 31, 40 CFR 35	N/A	Contained in specific Federal Regulation that requires data

* Grants include Performance Partnerships Grants and Performance Agreements.

- institutions of higher education, hospitals, and other nonprofit recipients of financial assistance (e.g., grants and cooperative agreements) under the authority of 40 CFR 30;
- commercial business enterprises;
- state, local, and tribal governments receiving financial assistance under the authority of 40 CFR 31 and 35; and
- other government agencies receiving assistance from EPA through extramural agreements.

Table 2. Agency-wide Internal and External Quality Policies

Agency-wide Policy	Requirements
EPA Order 5360.1 A2	<i>Policy and Program Requirements for the Mandatory Agency-wide Quality System</i> establishes minimum requirements for EPA organizations, policy for developing QMPs, responsibilities for EPA management, staff, and Quality personnel.
EPA Manual 5360 A1	<i>EPA Quality Manual for Environmental Programs</i> addresses ways to implement quality management activities, reporting requirements for environmental programs, Quality Staff guidance documents, user-friendly QA and QC guidance, etc.
48 CFR 46	<i>Quality Assurance in the Federal Acquisition Requirements</i> contains requirements for contracts, work assignments, and task orders. EPA and its contractors use ANSI/ASQ E4 as the standard for quality requirements and are required to submit a QMP or QA Project Plan.*
40 CFR 30	<i>Grants and Agreements with Institutions of Higher Education, Hospitals and Other Non-Profit Organizations</i> contains requirements for referenced organizations and requires grantees to comply with ANSI/ASQ E4. Grantees must submit a QMP or QA Project Plan.*
40 CFR 31	<i>Uniform Administrative Requirements for Grants and Cooperative Agreement to State and Local Governments</i> contains requirements for grants and cooperative agreements to State, local, and Tribal governments, requires grantees to develop QA practices to produce data of adequate quality for project objectives.*
40 CFR 35	State and Local Assistance contains requirements for any financial assistance to State and local governments.*

*Requirements are involved when work is within the scope of the regulations and the program.

In general, EPA requires compliance with the ANSI/ASQ E4-1994 standard for all recipients of funds for projects involving environmental data collection. Required documentation can include:

- Documentation of the organization's quality system (usually provided in a QMP).

- Documentation of the application of QA and QC activities to an activity-specific effort (usually provided in a QA Project Plan).

Use of existing quality system documentation, such as ISO 9001 registration, may serve as an acceptable alternative.

2.2 QUALITY SYSTEM STANDARDS AND MODELS

The EPA Quality System is based on the national consensus standard ANSI/ASQ E4-1994 and is consistent with other consensus management system standards. This section briefly reviews this and other relevant quality system standards and models.

2.2.1 Elements of the ANSI/ASQ E4-1994 Quality System Standard

The American National Standard, *Specifications and Guidelines for Quality Systems for Environmental Data Collection and Environmental Technology Programs* (ANSI/ASQ E4-1994) (ANSI/ASQ, 1995), was developed to promote consistency among the many quality systems requirements for environmental programs throughout the Federal government and the environmental industry. The standard describes the elements that, at minimum, should be in place to ensure that a functional quality system exists for organizations that perform environmental data operations or design or operate environmental control technology. The ANSI/ASQ E4 standard is designed to provide the basis for an auditable agreement between two parties. For example, the government may invoke the standard in a procurement, such that the successful bidder is required to comply with the ANSI/ASQ E4 standard and submit to an audit by the government to assess compliance. The standard is organized according to general elements covering organization-wide quality management (Part A), project-oriented elements covering environmental data operations (Part B), and project-oriented design, construction, and operations of environmental technology (Part C). Table 3 lists the specific elements within each category. Refer to the standard for more information.

2.2.2 Other Quality System Standards and Models

There are several other quality system standards and models that government agencies and commercial organizations may consider, depending on the nature of their work. Considerable commonality exists among various quality standards and models, regardless of application or industry. One such standard is *ISO 9001:2000, Quality Management Systems – Requirements* (ISO, 2000), an international consensus standard that defines general requirements for quality management systems for any organization that delivers products or services. Table 4 identifies some major quality system standards, their methods of administration, and examples of situations in which they may apply. In some cases, there may be a two-party agreement like that discussed above for ANSI/ASQ E4-1994.

Table 3. Elements of the ANSI/ASQ E4-1994 Quality System Standard

Part A. Management Systems	Part B. Environmental Data	Part C. Design, Construction, and Operation of Environmental Technology
1. Management and Organization 2. Quality System and Description 3. Personnel Qualifications and Training 4. Procurement 5. Documents and Records 6. Computer Hardware and Software 7. Planning 8. Implement Work Processes 9. Assessment and Response 10. Quality Improvements	11. Planning and Scoping 12. Design of Data Collection 13. Implementation 14. Assessment and Response Activities 15. Assessment and Data Usability	16. Planning 17. Design of Systems 18. Construction/Fabrication 19. Operations 20. Assessment and Response 21. Verification and Acceptance

In other cases, third-party registrations or certification processes establish the compliance status of an organization, such as in the case of the *ISO 9001:2000*. An increasing number of federal and commercial organizations are requiring contractors and suppliers to become registered with *ISO 9001:2000*, and countries in the European Union and Asia have embraced the standard in many areas of commerce. Government regulations and guidelines, such as *Good Laboratory Practices* (40 CFR 160 and 792), *Good Clinical Practices* (21 CFR 50, 56, 312), and *Good Manufacturing Practices* (21 CFR 210, 211, 290), include many quality management requirements that apply to health and pharmaceutical research and medical device manufacturing—activities in which failures could place humans at risk. *ISO 17025* (ISO, 1999) addresses competency requirements for testing and calibration laboratories and also includes quality system requirements. The National Environmental Laboratory Accreditation Program is an approach designed to promote coordination and efficiency in auditing for compliance with various laboratory QA requirements across states and programs.

Table 4. Standards Relating to Quality Systems

Standard Name	Method of Administration	Examples of Application
<i>ANSI/ASQ E4, Specifications and Guidelines for Quality Systems for Environmental Data Collection and Environmental Technology Programs</i>	2-party agreement	State conducting EPA-funded studies; contractor whose primary clients are within EPA
<i>ISO 9001:2000, Quality Management Systems – Requirements</i>	3 rd -party registration	EPA contractor who also provides services to ISO 9001-registered firms

Table 4. Standards Relating to Quality Systems

Standard Name	Method of Administration	Examples of Application
<i>Good Laboratory Practices, Good Automated Laboratory Practices, Good Clinical Practices, Good Management Practices</i>	FDA and EPA regulations and guidelines	Research organization conducting toxicology testing for new drug or chemical
<i>ISO 17025, General Requirements for the Competence of Calibration and Testing Laboratories</i>	Accreditation/ registration	Commercial metrology lab that serves EPA contractors as well as ISO 9001-registered commercial clients
<i>National Environmental Laboratory Accreditation Program</i>	Accreditation by approved authority (3 rd party)	An environmental services laboratory based in New York, with operations also in Florida, whose primary accreditation in New York is recognized by Florida

Summary

- The EPA Quality System integrates both management and technical activities for the planning and assessment of Agency environmental programs.
- The authority and requirements related to EPA’s quality system are described in several federal regulations and EPA policy orders.
- EPA quality systems should conform to the requirements of ANSI/ ASQ E4, which outlines elements for management systems, environmental data collection, and the design and operation of environmental technologies.
- There are a number of other quality system standards and models that government agencies and commercial organizations should consider depending on the nature of their work, including the *ISO 9001:2000* international consensus standard, the *Good Practices* regulations and guidelines, National Environmental Laboratory Accreditation Program, etc.

CHAPTER 3

HOW TO DEVELOP A QUALITY SYSTEM

This chapter will address the following questions:

- What are the four main phases of the quality system development process?
- What is management's role in the development of a quality system?
- How can organization-appropriate quality procedures be developed?
- How are staff encouraged to implement a quality system?
- What do quality system experts say about developing a quality system?

3.1 OVERVIEW OF THE QUALITY SYSTEM DEVELOPMENT PROCESS

A quality system can be seen as developing in four phases (Figure 2). In the initiation phase, the strategic direction is set and organizational resources are assigned to begin the process. In the development phase, the procedures, documents, and tools that form the quality system are brought together. In the implementation phase, the system is made operational through training and execution of the quality system procedures throughout the organization. In the ongoing maintenance and improvement phase, the system is monitored and evaluated to ensure that it continues to satisfy the organization's needs and to identify and implement opportunities for improvement.

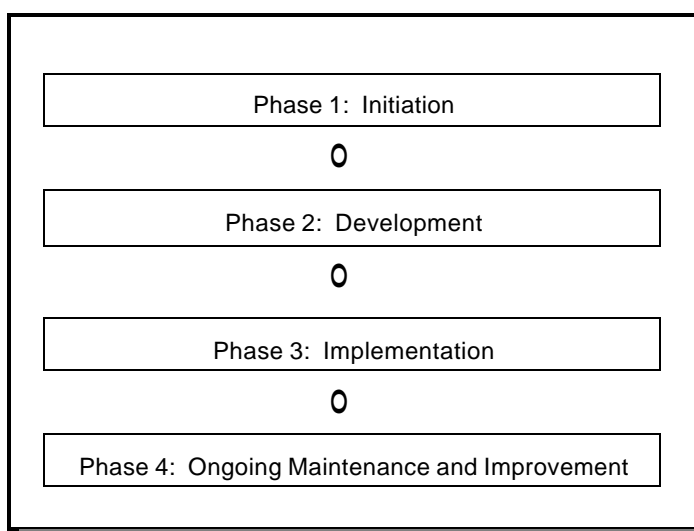

Figure 2. A Four-Phase Process for Developing a Quality System

Embedded in each phase are activities that follow the Shewhart cycle (Deming, 2000):

- C Plan—Analyze the situation, develop solutions;
- C Do—Implement the planned solutions;
- C Check—Assess the results of the implementation; and
- C Act—Take corrective action after assessment.

This cycle is based on the assumption that a quality system is not something that is performed once and for all. Rather, a quality system evolves in four-cyclical steps, as an organization's management plans and implements activities, evaluates the effectiveness of these activities, and then selects revised goals to guide the next phase of the cycle. The concept of continual improvement is an implicit assumption of the cycle.

It is EPA policy (EPA, 2000b) that environmental data operations be planned using a systematic planning process based on the scientific method. The Shewhart cycle incorporates both a systematic planning process in its iterative approach and the scientific method in its checking of the results of the planned solution.

The development process involves preparing documents that describe the planned quality system and then implementing these plans. Quality systems that operate under EPA Order 5360.1 A2 are self-certifying. No external registration body exists for these quality systems, as exists for quality systems that comply with ISO 9001. However, assessments of a quality system (EPA, 2001c) that comply with the Order determine if it is implemented and operating in the manner prescribed by its approved QMP, and if it is consistent with current EPA policies.

3.1.1 Quality Systems for Small Organizations

The EPA quality system is characterized by the principle of the graded approach, under which organizations base the level of QA and QC applied to an organizational area or project on the intended use of the work product and on the confidence needed and expected in the quality of the work product. The graded approach is also used in developing a quality system that is appropriate for the mission, objectives, and resources of the organization that is developing the quality system. This approach starts with the initiation phase and continues through the remaining phases of the quality system development process. *Overview of the EPA Quality System* (EPA, 2002) states:

The development and implementation of a quality system should be based on a "graded approach." This means that the components and tools of a quality system (Figure 2) are applied according to the scope and nature of an organization, program, or project and the intended use of its products or services. This approach recognizes that a "one size fits all" approach to quality management is not appropriate and that the quality system of different organizations and program should (and will) vary according to the specific needs of the organization. For example, the quality expectations of a fundamental research program are different from that of a regulatory compliance program because the intended use of the products differs.

Oakland (1993) notes that requirements for fully developed quality systems are likely to affect those organizations employing less than 100 people. Small organizations may be unaware of how to meet the requirements and the repercussions of establishing the quality system on its current work processes. A small organization may perceive the cost of establishing the quality system as disproportionate to the value of work that results from the quality system.

One solution to help a small organization develop and implement a quality system under these conditions is to seek outside help from a professional consultant or from the governmental entity that has oversight responsibility for the organization's quality system. During the development phase, this help can take the form of technical assistance in preparing a QMP and standard operating procedures (SOPs) that are appropriate for the organization. During the implementation phase, an external assessment of the developing quality system can provide objective feedback about quality activities that remain to be implemented. The assessors can provide technical assistance to promote the implementation of the quality system.

The schedule for developing and implementing the organization's quality system should be appropriate for the resources allocated and the availability of personnel to do the work. Resource and personnel limitations do not eliminate the obligation to comply with external quality requirements, but they may be factors in determining the rate that the quality system is developed and implemented. The organization's senior management should consult with the government entity with oversight responsibility about any limitations that may exist.

An organization may not have enough personnel to assign someone to implement the quality system and conduct routine QA activities on a full-time basis. Someone from the staff may need to function as the organization's quality manager on a part-time basis while performing other duties. A part-time quality manager should be careful to remain objective regarding the quality system, particularly during internal assessments of the quality system.

An example demonstrating the development of a quality system is provided in the remainder of this chapter. The example describes a hypothetical quality system for a state environmental monitoring program. It will be used to illustrate some of the concepts discussed in this chapter.

Quality System Development Example

***Background:** Quality is monitored by the State Office of Quality, but quality systems are decentralized in individual State agencies. Each agency's quality system is designed to be appropriate to its objectives and organizational structure.*

With the promulgation of new federal environmental monitoring standards, the State Department of Environmental Programs (SDEP) was required to establish a new monitoring

program with a self-contained quality system that complies with ANSI/ASQ E4-1994. The program would involve the gradual deployment of a large number of newly purchased environmental sampling equipment by SDEP district offices and development of complex analytical and data management systems in the central laboratory. Full deployment of the monitoring network would occur over one year. The slowly increasing volume of samples coming from the district offices to the central laboratory would allow the staff to run shakedown tests of their systems and to uncover problems. This shakedown period also would allow the equipment manufacturer and EPA to modify the sampling equipment and the analytical procedures to correct these problems.

3.2 INITIATION ACTIVITIES

The initiation phase of quality system development is critical. Choices made early usually set the tone for what follows. The organization's senior management should have a clear idea of its purpose and goals in developing the quality system. Development of a quality system inevitably involves some changes in the way an organization does its work, and change can be challenging. Identifying a set of successful strategies that will achieve the organization's goals is important. Figure 3 shows the initiation phase activities. These activities are discussed further in the sections below.

3.2.1 Senior Management Commitment

One of the basic assumptions about a quality system is that it is primarily a management function and secondarily a technical function. It would then follow that the senior management of an organization should play a leading role in the development of a quality system. If senior management recognizes that the quality system will provide real benefit to the organization and to management itself, and communicates this message to the staff, there is a greater likelihood that the quality system will be successful.

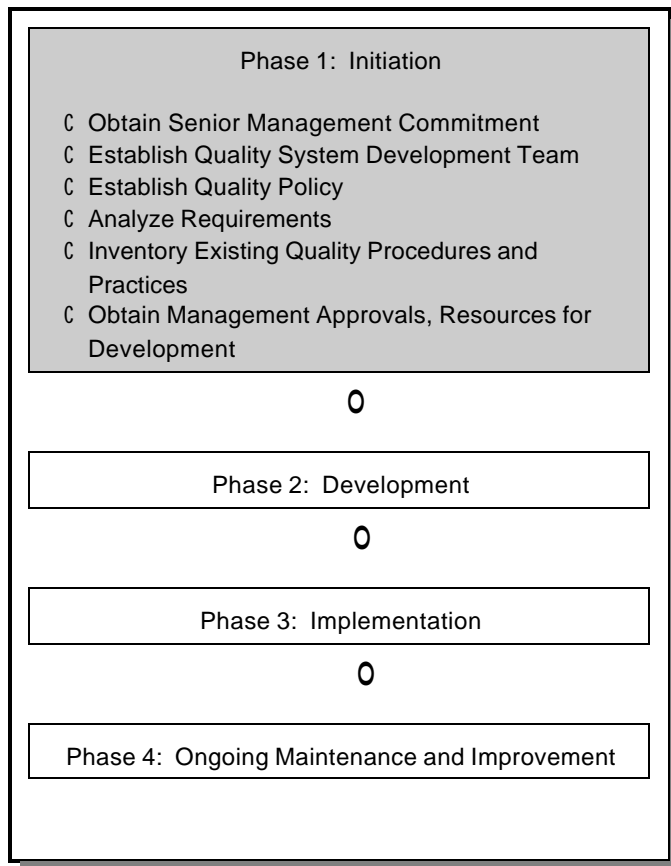

Figure 3. Initiating the Quality System (Phase 1)

Note that in this discussion the term “senior management” refers to the highest level of management in the organization that is developing the quality system. If this organization is a part of a larger organization, higher levels of management may exist.

If the quality system is to be useful to senior management, it should be understood by management and address those issues that are important to management. The quality system should be explained to management in terms of the organization’s mission and goals, rather than only in terms of external quality requirements. The anticipated benefits of achieving organizational goals and improving the organization’s performance is more significant than the existence of the quality system.

Although the impetus to develop a quality system may originate from outside the organization, management should see the quality system as a necessary component of its overall approach to running the organization. Consequently, one of the first milestones in developing a quality system is to obtain senior management’s commitment to develop and implement the quality system. This commitment should involve changes in the basic policies of the organization and allocation of the resources, in both funds and staff time, to develop and implement the quality system.

“Improvement of quality and productivity, to be successful in any company, must be a learning process, year by year, senior management leading the whole company....Support of senior management is not sufficient. It is not enough that senior management commit themselves for life to quality and productivity. They must know what it is they are committed to—that is, what they must do. These obligations can not be delegated. Support is not enough: action is required.”

– Deming, 2000

Senior management will need reasonable estimates of the resources and the time needed to develop and implement the quality system. These estimates should factor in the extent to which existing activities will be disrupted and existing procedures will be changed. The preparation of these estimates should precede management’s formal commitment to develop and implement the quality system.

3.2.2 Quality System Development Team

Developing a quality system cannot be viewed as an isolated process. The quality system affects functions and practices throughout the organization. Thus, it is important that the quality system reflects the needs and actual practices of the organization. In some cases, the task of developing a quality system may be delegated to one person. This is not ideal since it is not likely that a single individual would understand all of the work processes at each level of the organization. The role of developing a quality system is more readily filled by a quality system development team.

A quality system development team is a temporary group that would exist only during the development and implementation phases. The team should include individuals with expertise in quality systems and individuals with expertise in the core functions of the organization. Because the entire organization will be involved in the implementation of the quality system, key individuals in the organization should be involved in its development. These individuals can help ensure that the structure and components of the quality system are appropriate for the organization. They can be champions for the system during implementation.

Careful thought should be given to the structure and composition of the team before it is assembled. Several different and equally valid models for team structure exist and should be considered (Brown et al., 1994; Oakland, 1993). Successful teams are composed of individuals fulfilling different roles and having different personality types. The team may be assembled with all or some of the following considerations:

- members are appointed by and supported by senior management;
- time spent by members in team activities is approved and encouraged by management;
- membership is considered a high-priority assignment by members and management;
- the team operates under a specific charge to develop the quality system;
- the team is led by one individual, who is supported by the rest of the team;
- the number of members is small enough to allow effective action;
- the team includes middle managers, operational supervisors, trainers, and technical, administrative, and quality staff from diverse core functions of the organization to provide a thorough understanding of how work is done in all parts of the organization and to act as quality system champions during the implementation phase;
- the members are familiar with the mission, structure, and needs of the organization and its components;
- the members are familiar, collectively, with all managerial, administrative, and technical procedures of the organization and with basic quality concepts;
- the members have good oral and written communications skills; and
- the members are even-tempered and can work with tact and reason in potentially difficult situations.

One of the first goals for the team is to develop a general schedule for the development and implementation of the quality system. The schedule should address all specified components of the quality system and the organizational modifications needed to accommodate the quality system. It should allocate time for preparation of quality documents, for internal and external assessment, and for staff training. Deadlines for intermediate tasks in the development effort should reflect a logical sequence of events. Table 5 shows an example of a general schedule for developing a quality system.

The quality development team should assign responsibility for specific tasks to designated team members. It also should have procedures to track development progress. Project management tools

Table 5. Example of a General Schedule for the Development of a Quality System

Major Task Name	Start Date	Stop Date
Conduct initial assessment of existing quality procedures	10/07/02	11/04/02
Develop new quality procedures	11/04/02	01/13/03
Develop QMP	11/04/02	04/21/03
Conduct detailed compliance audit	04/21/03	05/19/03
Obtain management approval for implementation	04/21/03	05/05/03
Distribute plan to entire organization and post quality system documents on intranet site	05/05/03	05/19/03
Conduct quality system training for staff	06/02/03	09/29/03
Implement quality system	06/02/03	09/29/03
Conduct internal assessment of quality system	10/06/03	11/03/03
External assessment of quality system	05/03/04	06/07/04

(for example the Gantt charts described in Chapter 5), provide a way for the team to monitor how well specific tasks are moving toward completion.

The team should maintain communications among its members. Because the team is drawn from different subunits of the organization, individual members may not be in contact with each other day-to-day. Some formal team communications arrangements should be developed. Periodic face-to-face meetings or conference calls are useful for group discussions regarding development issues. An e-mail list server can help ensure that all members are kept informed about the status of the quality system development.

The team should also report to senior and middle management regarding the status of the development on a regular basis. Because the quality system should be integrated into the management system, and because development of the quality system is likely to produce changes in the organization's policies and procedures, management will need to be kept informed about proposed development steps and should authorize these changes. Otherwise, the team's progress could outpace the organization's process to change procedures.

Management's participation in the development will encourage their ownership of quality, which is important for the successful implementation of the quality system. Maintaining management's commitment to the development process by keeping them informed is important.

3.2.3 Establish Quality Policy

A tangible accomplishment of the team would be a documented statement of mission, objectives, and quality policy. Many organizations will have a written mission statement, and others will have written objectives that cover some relevant time horizon. However, many organizations do not have a written quality policy, and the team may need to focus in that area.

Documentation of an organization's quality policy is important because the process of developing such a statement may reveal those areas the organization feels are important, and will help the team focus the quality system on those areas.

A mission statement is a short and clear expression of an organization's core principles. It should address three key questions:

1. What does this organization exist to do? (purpose statement);
2. What activities does the organization perform to accomplish this purpose? (business statement); and
3. What are the basic principles or beliefs that the organization shares and that guide our activities? (values statement).

A quality policy is a written expression of senior management's overall intentions and direction for an organization regarding quality, including objectives for quality and commitment to quality. It should become part of the organization's formal policies and should be communicated to all members of the organization. A quality policy informs the organization of senior management's plans to:

- establish a quality system;
- identify the customer's needs and perception of needs;
- assess the ability of the organization to meet those needs economically;
- ensure that procured materials and services reliably meet the required standards of performance and efficiency;
- concentrate on a philosophy of prevention, rather than detection, of problems;
- educate and train for quality improvement; and
- review the quality system to maintain progress (Oakland, 1993).

The difference between the mission and quality policy statements is in their orientation. The mission statement addresses goals for the entire organization; the quality policy addresses senior management's

1917 Huntington Monument at Newport News Shipyard:

*"We shall build good ships here—
at a profit— if we can—
at a loss— if we must—
but always good ships"*

– Dobyms and Crawford-Mason (1991)

specific commitments toward the quality of the organization's activities. Quality policies are implemented by the organization's quality procedures documented in its QMP. The effort required to develop a meaningful quality policy aligned with the organization's mission statement should help the team understand this distinction.

The quality system development team should work closely with senior management and middle management because management should perceive the quality policy statement as an expression of its own goals, objectives, and procedures. This process should help the organization recognize that quality is a core value and that it is important to management. Several revisions may be needed to produce a statement that is based on sound quality principles and expressed in management's terms.

"What is the quality policy? It is the state of mind held by the company personnel concerning how well they must do their jobs. It is this policy, whether it has been stated or not, that determines in advance how successfully the next job will be done."
– Crosby, 1979

The team also should develop objectives for the quality system development process. The objectives will vary with the organization and the status of its existing quality procedures. The following are examples of tasks that help in the development of the quality system objectives:

- review quality system concepts and develop an organization-specific strategy for developing the quality system;
- identify the organization's customers (internal or external) and their quality requirements and expectations;
- conduct customer surveys to determine the degree that the organization's current work conforms to these requirements;
- define benchmarks (i.e., a standard of excellence or achievement against which other similar objectives should be measured or judged);
- create teams to address specific operating problems;
- define a unique quality system problem-solving process; and
- create a quality system improvement plan (Hunt, 1993).

3.2.4 Analyze Requirements

The quality system development team should analyze and interpret the applicable requirements in the quality system. The team should be familiar with the elements of a quality system defined by EPA Order 5360.1 A2 and ANSI/ASQ E4-1994. Team members should determine which elements are applicable to the organization. For example, the elements associated with the design, construction, and operation of environmental technologies may not be applicable to an organization developing and using

computer software. The elements that go into a specific quality system should be designed to match the specific organization; there are no generic QMPs that are applicable to all organizations. The QMP should reflect the mission and objectives of the organization and the existing policies and procedures for attaining these objectives. In addition to the EPA requirements, non-EPA organizations should also determine whether their quality system should comply with other quality standards, such as ISO 9001.

3.2.5 Inventory Existing Quality Procedures and Practices

Existing quality procedures and practices can be inventoried by conducting a self evaluation of the organization's existing quality practices. This includes identifying existing written procedures that address quality system objectives, identifying current undocumented quality procedures that address these objectives, and identifying gaps where applicable objectives are not being addressed. Using existing procedures as much as possible will help ensure that the quality system will be well integrated into routine operations.

The purpose of this self evaluation is to obtain general knowledge of the organization's current quality practices; a more detailed compliance audit will be conducted during the development phase. The team needs to know if the organization already has a functioning quality system and to what extent the quality system is documented. At this point, the team does not need to know the extent to which procedures are actually being followed.

There are four aspects of the organization that should be investigated in the self-evaluation (Hunt, 1993):

- *Climate*—people's perceptions of their organization;
- *Processes*—the organization's policies and procedures;
- *Management tools*—the specific techniques used to promote quality management improvements throughout the organization; and
- *Outcomes*—mission accomplishment.

The steps outlined below can be taken to identify existing quality procedures during the self-evaluation (Oakland, 1993).

- Gather existing information: locate relevant information sources from verbal inputs, existing files, control charts, quality records, etc.; collect this information, speak to the staff, and investigate additional sources.
- Organize the collected information, which may not be in the appropriate format.

- Define the gaps in the collected information by asking the following questions: Is enough information available? What further information is needed? What work processes are undocumented? What parts of the organization are involved in these work processes? Do any problems exist with these work processes?
- Plan further information collection by: creating a list of additional information that needs to be developed; identifying any team members who can develop this additional information; consulting with others in the organization who are knowledgeable of the work processes and could develop this information; and developing relationships with other staff in the organization who can help in implementing the quality system.

The results of this self-evaluation and inventory of existing procedures and practices will provide a basis for developing a plan for further quality system development. Details about the technical approach, schedule, and budget should be included in the plan, as described in the next section.

3.2.6 Obtain Management Approvals, Resources for Development

The initiation phase will be completed when senior management authorizes development of the quality system. The quality system development team should be prepared to make a formal oral or written presentation to management. This presentation should include:

- the specifications for the quality system;
- the results of the initial evaluation of the current status of the quality system;
- a plan for the development of the quality system;
- those aspects of the organization's procedures that need to be modified to conform to EPA quality system specifications;
- documentation and procedures that need to be developed;
- an estimated general schedule for the development and implementation of the quality system; and
- an estimate of the approximate cost associated with this effort.

The quality development team should take positive steps to help senior management understand the merits of the quality system, the need for management participation, and the precise nature of the needed participation. Management is more likely to commit resources to the development process if they foresee tangible benefits for the organization arising from the quality system than if they foresee only conformance with external quality requirements. If possible, the team's presentation should estimate the current cost of poor quality, the estimated cost reduction if the quality system is successful, and the cost of implementing the quality system.

Arriving at a rigorous estimate of the cost of poor quality for the entire organization may be difficult. Estimates of the cost associated with specific projects may provide anecdotal evidence for the presentation. If the team can present case histories of projects where the absence of quality planning resulted in errors and additional costs, the benefits of the quality system may be more meaningful to management.

An example outline for a presentation to senior management is given below.

- Background
 - What is being proposed?
 - What is a quality system?
 - Why is this important now?
 - What are the external quality requirements?
 - Why invest resources? (e.g., cost of poor quality vs. cost of quality system)
- Strategic objectives
- Benefits to the organization
- Technical approach
 - Implementation strategy;
 - Task overview and responsibilities of key personnel;
 - Quality system deliverables (e.g., the QMP);
 - Task breakdown;
 - Planned schedule of tasks, deliverables, and meetings;
 - Staff commitment to team activities;
 - Labor commitments breakdown by task; and
 - Budget requirements.

Quality System Development Example

Phase I: Initiation

As part of developing its monitoring program, the department assembled a team that was charged with developing and implementing a comprehensive, yet realistic quality system that would fit into the larger departmental quality system. The team included:

- *the head of the monitoring division;*
- *a State Purchasing Department buyer who handles equipment purchases for SDEP;*
- *a senior sampling technician from the field section in a district office;*
- *a chemist from the analytical services section in the central laboratory;*
- *a database manager from the information technology section;*
- *a quality assurance specialist from the quality section; and*

- a training specialist from the director's staff.

Once established, the team reviewed the requirements for the quality system using EPA's Requirements for QMP (QA/R-2) (EPA, 2001a) and ANSI/ASQ E4-1994. They summarized the requirements regarding resource allocations for the program, training, assessments, reports to management, and other topics. The team also reviewed the method description in the Code of Federal Regulations and in supporting technical documents. They summarized the quality requirements for procurement of acceptable sampling devices and analytical instrumentation; for collection and transport of environmental samples; for handling, analysis, and storage of the samples; for data management; and for assessments. Subsequently, the team met with EPA Regional Office monitoring and quality representatives to learn how the program's quality system would be integrated into the EPA Quality System.

The analytical chemist on the team reviewed the Analytical Services Section's written SOPs and investigated the section's unwritten practices in light of the method's quality requirements. This gap analysis revealed that sample handling procedures needed to be standardized and documented. It also revealed that QC procedures needed to be improved for some analytical techniques and that periodic performance evaluations were needed. Some SOPs had not been updated recently and they referred to analytical instrumentation that was no longer used in the central laboratory. After learning of the problems, the head of the analytical services section directed the analytical chemist to update all SOPs older than 3 years. The team met to discuss the outcome of the initiation phase activities. They prepared a brief written report to senior management in the department regarding the quality requirements for the new monitoring program.

3.3 DEVELOPMENT ACTIVITIES

After management has committed the organization to establishing a quality system, the development phase can begin. This phase involves assembling and development of the various elements of the quality system and the documentation that describes the quality system. Figure 4 shows the activities involved in the development phase. Each activity is described in more detail below.

It is as important to maintain regular communications with senior and middle management during the development phase as during the initiation phase. The presence of management representatives on the team is not sufficient to ensure that all management remains informed about the development process and that senior management remains committed to the process. The process of implementing

the quality system will take time and the changes may cause some disruption in the organization's work processes. Management should be given enough time to prepare for these changes.

3.3.1 Assign Tasks and Develop a Detailed Schedule

The major tasks in the development schedule should be divided into a set of detailed assignments. Typically, the team leader is responsible for coordinating the team's efforts and for meeting the deadlines of major tasks in the development effort. Individual team members should be given responsibility for handling specific assignments. A detailed schedule should be developed that shows the general schedule was approved by senior management (see Table 6 for an example of a detailed schedule for one component of the quality system).

The development schedule should be flexible enough to accommodate delays. It may be wise to design the schedule so that individual components of the quality system can be developed independently and then harmonized at a later date. Delays may occur because processes are more complex than anticipated. It is usually more important for the team to focus on developing a quality system that functions well, rather than on meeting an arbitrary deadline.

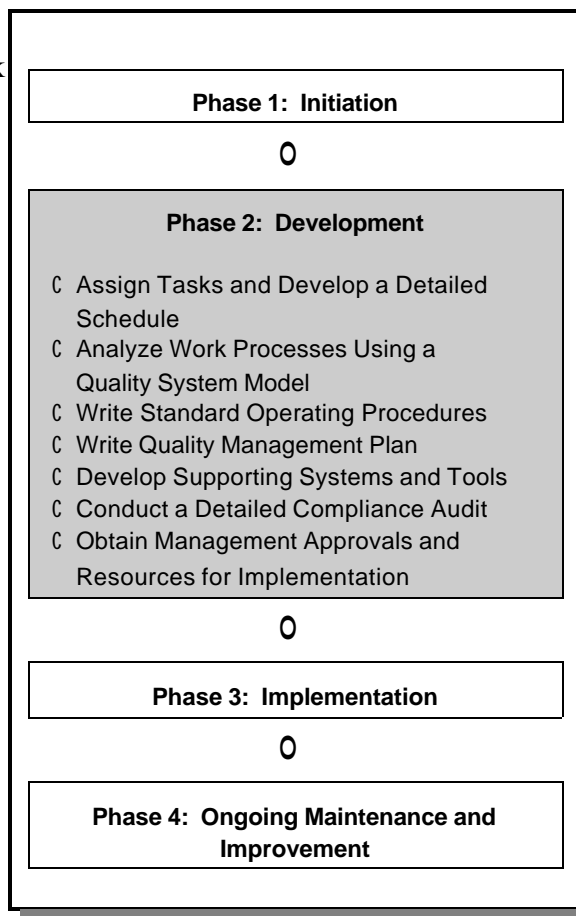

Figure 4. Developing the Quality System (Phase 2)

Table 6. Example Detailed Schedule for Development of a Quality Management Plan

	Detailed Assignment	Responsibility	Start Date	Stop Date
3.	Develop QMP	Andrews	11/04/02	04/21/03
3.1	Draft mission statement and quality policy	Andrews	11/04/02	12/02/02
3.2	Develop outline for plan	Bernholt	11/04/02	12/02/02
3.3	Develop work process diagrams	Carson	11/04/02	01/13/03
3.4	Identify linkages to existing policies	Dayton	11/04/02	12/02/02

Table 6. Example Detailed Schedule for Development of a Quality Management Plan

Detailed Assignment		Responsibility	Start Date	Stop Date
3.5	Distribute QMP outline for review	Andrews	12/02/02	12/16/02
3.6	Review and revise QMP outline	Bernholt	12/16/02	01/13/03
3.7	Draft detailed QMP sections	Entire team	01/13/03	02/10/03
3.8	First draft QMP submitted for review	Andrews	02/10/03	02/24/03
3.9	Review of QMP by senior management	Management	02/24/03	03/24/03
3.10	Review and revise QMP	Entire team	03/24/03	04/21/03

Quality systems can be developed and implemented in a standard approach or a fast-track approach (Brown et al., 1994). In the standard approach, each phase of the quality system development process is done in sequence. By some estimates, the standard approach takes one year for each layer of management in large organizations. Smaller organizations have fewer layers and the quality system can be developed and implemented more quickly.

In the fast-track approach, there is considerable overlap in the phases. This approach is more risky than the standard approach, requires a greater allocation of resources and more intensive coordination efforts. More stress is associated with this approach because it does not allow staff to adjust to the quality system on a gradual basis.

3.3.2 Analyze Work Processes Using a Quality System Model

One goal of a successful quality system is to improve the organization's work quality and reduce the effort needed to do this work. If this goal is to be attained, the quality system development team should understand how work is accomplished in the organization. Because an organization is complex, the work should be understood as individual processes that are linked into a chain of relationships.

For example, a chain of processes might be those involved in the review and approval of an environmental permit. The initial process in the chain could be the handling of a permit application and supplemental data to assemble a complete permit review package. The second process could be the engineering review of the package to determine if the industrial facility conforms to regulatory requirements. The third process could be the entry of data into the organization's database concerning the approved permit. The final process in the chain could be using the information in the database to generate a notification letter to the applicant. In each process, an input is transformed into an output and value was added.

Controls and resources also have an impact on work processes. Controls are policies and other external requirements that specify the conditions required for the process to generate the correct output. Resources are the people performing the transformation and the equipment they use.

Each process is represented by a single box with surrounding arrows representing inputs, controls, outputs, and resources (see Figure 5). The arrows denote data or objects related to the process. Individual processes can be linked together to form process flow diagrams (as discussed in Chapter 5). These diagrams are used to represent the entire system and the interrelationships among its processes to improve understanding of the system. Feedback loops can exist so that the output of a downstream process is an input to an upstream process. Using such diagrams, a complex system can be broken down into a set of interrelated processes.

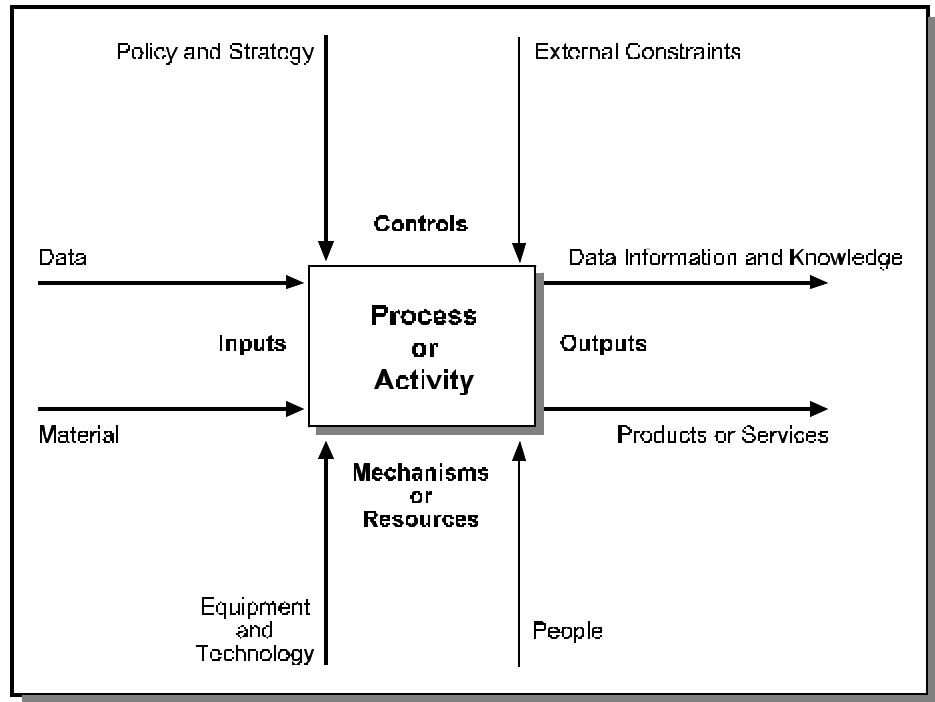

Figure 5. Standard Diagram of a Work Process (National Institutes of Standards and Technology 1993)

The system becomes more complicated when different individuals within the organization handle the different processes. In a system that involves multiple individuals, a single individual may not understand the entire system and how the different processes interrelate. An individual who understands only a single process may subtract value from the product because the overall objective of the system is not understood.

After the system has been described in a process flow diagram, the quality system development team can critically analyze the system to identify the specific areas where errors and poor quality may occur. This can also determine specific points where quantitative parameters may be measured and tracked using statistical control techniques. The team can then focus its quality improvement and measurement efforts on the identified areas. The analysis should follow the work as it flows through the

system because errors that occur in the early stages of the system may not be manifested until much later. The analysis can save resources by minimizing development efforts in those areas of the system that are already performing well.

As the system is being analyzed, attention should be paid to the following points:

- processes should be described as objectively as possible;
- preconceived ideas about the processes should be questioned or suspended until the analysis is complete—hasty judgements should be avoided;
- all components of the system should be tested and verified;
- small details should be recorded at the appropriate level of analysis because they may be more important to understanding the system than are the major items; and
- new processes should not be considered until the undesirable or problem-causing attributes of the existing process have been exposed.

The analysis of an organization in terms of its work processes should produce the following results (ISO, 2000a):

- definition of the organization's activities in a manner that identifies the organization's work products and their required quality;
- identification of management and staff who are responsible for specific work processes;
- identification of the carrying capacity of work processes;
- identification of critical linkages and bottlenecks between work processes;
- identification of the resources needed for the work processes; and
- identification of individuals and organizations who affect and who are affected by the work processes.

3.3.3 Write Standard Operating Procedures

During the initiation phase, the team will have identified applicable specifications of the EPA quality system and the existing quality procedures of the organization. Team members should then compare the procedures with the EPA specifications to determine which procedures may be used without modification and which ones need to be revised. The modifications may be as simple as reformatting the documents to a consistent style. However, they may be complex enough to require changes in how work is performed in the organization. Team members should work with managers in making the more complex revisions so that the revised documents reflect quality principles and the existing management procedures of the organization.

Write Procedures for Undocumented Work Processes

A functioning organization is likely to have developed procedures for accomplishing most of the activities that it performs. These procedures may be informal and undocumented. In developing the quality system, the team should document any existing informal procedures that meet the organization's quality requirements. Team members should interview the organization's management and staff to investigate what procedures are being followed. These interviews will also help the team understand how the organization operates and may identify members of the management and the staff who can assist in the implementation of the quality system.

“Standard operating procedures are certainly central to organizational functioning, but staff should be encouraged to think about them critically. If you educate your staff so that they are encouraged to think about the work processes they are performing, instead of blindly following SOPs, you may unleash all sorts of creative energy.”

– Cohen and Brand, 1993

Informal procedures may not be uniform across the organization. One goal of the development effort is to harmonize the procedures to the greatest extent possible across the organization. The team needs to be sensitive to valid reasons for procedures being different in different components of the organization and to incorporate the valid differences in the documentation.

Guidance for Preparing Standard Operating Procedures (SOPs) (QA/G-6) (EPA, 2001b) provides detailed information on the preparation and use of SOPs within a quality system. This document describes SOPs for technical and administrative operational elements of an organization that would be operating under a QMP and/or a QA Project Plan. Technical SOPs may document an organization's technical activities, such as field sampling, laboratory analysis, data processing and evaluation, modeling, risk assessment, and auditing of technical systems. Administrative SOPs may document its administrative activities, such as contract management, document review, inspection, training, record maintenance, data validation, and official correspondence.

Wieringa et al. (1998) provides detailed information about the principles and practice of procedure writing. This process consists of the following seven steps:

1. Plan—What are they writing? Why are they writing it? What resources will they need?
2. Investigate—The writers do preliminary research to collect information and develop ideas about what they will be writing.
3. Organize thoughts—Outlining is a useful organizational tool; a flow chart can help the writer analyze the process in a systematic fashion.
4. Draft—Write a draft of the SOP.

5. Review—The draft SOP should be reviewed by the writers, technical experts, users, and management and revised to improve accuracy and readability.
6. Test—The SOP should be tested by a typical user who will perform the process as specified in the SOP while the writer observes which SOP sections causes problems.
7. Maintenance—After the SOP has been successfully implemented, it should be revised to incorporate any changes that have been made in the process.

The overall process should also include routine periodic review of SOPs to ensure that revisions are incorporated in a timely manner.

Design and Document New Procedures that Fill in Current Gaps

The most difficult procedures to develop are those that do not exist in the organization in any form. Management and staff of an organization may not perceive the need for procedures that address previously undocumented and unregulated aspects of their work processes. They may not see the benefits to be obtained from the new procedures. At a more fundamental level, they may not have critically analyzed the work processes from a Quality Systems needs perspective and may not be able to articulate any recommendations for the new procedures. The team members may wish to develop several alternative procedures for their consideration. The team should consider how to apply the graded approach to the new procedures that are being developed.

“One of the best-documented quality systems the author has ever seen was a small hand-tool company. It possessed an excellent quality manual, beautifully laid out in sections covering each paragraph heading of ISO 9002. Each procedure described exactly how compliance with the standard was achieved, and identified the responsibilities and authorities of the individuals concerned—but it was a work of fiction! It did not bear any relation to what actually happened.”
– Oakland, 1993

3.3.4 Write Quality Management Plan

After an organization’s mission, quality policy, and quality procedures have been developed by the team, they should be documented in a QMP for the organization. The elements of a QMP are specified in *EPA Requirements for Quality Management Plans (QA/R-2)* (EPA, 2001a). See Section 5.3 for more information about the elements of a QMP. Organizations external to EPA may refer to this document as a “quality manual” or a “quality plan.”

The value of preparing a QMP is not only in the document prepared, but also in the systematic planning that should be involved in preparing the document. The formal process of developing the

mission statement and quality policy, and of preparing SOPs and the QMP, requires that management and the team perform a critical assessment of the organization's goals and the methods used to attain those goals. The fact that this process occurs will help ensure the successful implementation of the quality system. The plan can be viewed as the organization's documentation that systematic planning has occurred. Conversely, a plan developed without systematic planning and consultation may be difficult to implement.

As the plan is being prepared, the team should continue to work closely with middle and senior management to ensure that the quality procedures accurately represent work processes in the organization and that the work processes meet the quality requirements. Any team-initiated modifications of work processes should be approved by management before they are documented in the plan. The plan should describe either the quality procedures as they currently exist in the organization or the quality procedures that senior management has committed to have implemented in the organization.

Although there is no required format for the plan, a plan organized to follow the structure of the *EPA Requirements for QMP (R-2)* (EPA, 2001a) is recommended. The plan is more likely to address all the necessary quality system elements, and reviewing it will be easier for external readers if the elements of a QMP are presented in a standardized format.

Deciding how much detail is needed in a QMP will depend on the level of detail in the administrative and technical SOPs. If the SOPs document the organization's work processes in a comprehensive fashion, the plan can be a relatively brief document (e.g., 25 to 30 pages). Together, the plan and the SOPs should provide the management and staff with a complete set of instructions to implement the organization's quality policy.

The plan and the SOPs should also provide enough information about an organization's quality procedures to serve as the written criteria for an external assessment of the organization's quality system. *Guidance on Assessing Quality Systems (QA/G-3)* (EPA, 2001c) provides information about the criteria for assessments of quality systems.

Oakland (1993) describes questions to ask about each element of the plan:

*“What specific activity should be done to meet the requirement?
Why does it have to be done? (or why is it done that specific way?)
Where is the requirement met?
When is the requirement met?
Who is responsible for doing it?
How is it done? (or “What SOPs are used?” or “Can it be done in another way?)”*

EPA's Quality Staff developed a checklist for reviewing QMPs (see www.epa.gov/quality/qs-docs/qmp-checklist.pdf). This checklist can be used by the team to help ensure that the plan contains all the necessary elements.

3.3.5 Develop Supporting Systems and Tools

The team will need to develop or acquire any new tools or systems needed to support implementation of the quality system (e.g., document control and a records management information system). Chapter 5 describes some tools and methods that can be useful when developing quality systems.

The EPA Quality Manual (EPA, 2000) defines policies for quality-related documents and records. The team should establish procedures for control and management of these documents and records as it develops the quality system. It should also investigate the document and records management system that is appropriate for the quality system and the organizational structure. The team will have to address issues such as the following:

- c the extent that the document and records management system will be centralized and standardized;
- c whether the system will operate in paper or electronic format or some combination;
- c software that needs to be obtained to support the system;
- c provisions to give management and staff access to quality documents and records;
- c provision for long-term storage of quality documents and records;
- c the scheme for organizing quality documents and records in the system; and
- c resources and responsibilities for operating the system.

3.3.6 Conduct a Detailed Compliance Audit

After the QMP has been completed, it should be checked against what is actually being performed in the organization. This assessment should be more detailed than the evaluation conducted during the initiation phase. Although the team prepared the QMP, it should be objective when it assesses how well the organization conforms to the plan and to the requirements that underlie the plan. The team should determine if the organization follows the existing procedures. Techniques used in assessments of a quality system (EPA, 2001c) should be used for this internal assessment.

A detailed self-assessment checklist should be developed, based on the QMP. A checklist allows the team to compare current procedures with the organization's requirements in a systematic manner. It will also help the team identify existing documents that address specific requirements of the organization.

The assessment should be more than just a review of documents relating to quality procedures in the organization because the documents may not represent how procedures are actually performed in the organization. The team should speak with management and staff to determine if the existing procedures are actually followed in routine activities. The team should interview multiple individuals having diverse job functions in different parts of the organization.

3.3.7 Obtain Management Approvals and Resources for Implementation

The plan should be presented to senior management for approval and subsequent distribution as the formal policy of the organization. The team should demonstrate to senior management that the plan is reasonable, that it will be accepted by the middle management and staff, and that it will produce benefits. If the plan passes these hurdles, senior management should review and approve it after any necessary modifications have been made. Management should make it clear to the organization that the plan is to be implemented and should manage the organization in accordance with the plan.

“A typical example was that of a quality manager who proposed to introduce a comprehensive formalized quality control program into the company... He had gotten a weak reception from the line manager but was thoroughly sold on his own proposals. His senior managers had then told him, in effect, to secure the support of the line managers first. Again I played the role of critic, and asked him to explain to me just what would be the tangible effects of his proposals... He was unable to be specific enough to convince me that the present system (or lack of system) had enough deficiencies to warrant taking a major step into the unknown. I later confirmed that his senior managers had much the same judgment.”

– Juran, 1999

Quality System Development Example Phase 2: Development

The quality system development team reviewed its progress and developed a detailed schedule for the remaining tasks. Each team member agreed to review their assigned work processes and develop written procedures, if necessary.

The database manager reviewed the data management process, from sample media preparation to the reporting of final analytical results. Commercial software was used to generate process flow charts showing the flow of data through the system and the time requirements associated with each data-handling component of the system. This analysis identified three areas where bottlenecks or errors were most likely to occur in the data management system:

- C the requirement for “just-in-time” shipment and tracking of limited shelf-life sampling media;*
- C the integration of sample data, field data, and analytical data which were in different formats; and*
- C documentation of laboratory holding times between the receipt and the analysis of limited shelf-life samples.*

The database manager also determined which data quality problems from the field and laboratory components of the method needed to be linked with the final analytical results for specific samples. A database structure that included these indicators was developed.

After all team members had developed written quality procedures for their work processes, the QA specialist began work on assembling the QMP based on these procedures. The group’s analysis of all the work processes had revealed that the manual entry of data on hard-copy forms was a significant bottleneck in the timely handling and analysis of the limited shelf-life samples in all components of the program. The head of the monitoring division decided to purchase computers and bar-code scanners to track the samples from the preparation of the sample media through to the entry of the final analytical results in the database. The automated sample tracking system was addressed in the QMP’s elements associated with management and organization, computer hardware and software, planning, and assessment and response.

The SDEP QA specialist conducted a compliance audit of the district offices to compare their actual quality procedures against those listed in the draft quality manual. One district office had not yet prepared its chain-of-custody procedures for samples and had not yet identified staff members who would be operating the sampling sites in the district. It appeared that this district office was understaffed and was having difficulties accomplishing its existing duties. Upon receiving the report of the compliance audit, the head of this district office reassigned staff responsibilities to allow time for a senior technician to develop the district-level quality procedures for the new monitoring program and to operate the sampling sites.

The team held an interim progress meeting and prepared a brief report for management on the details of the development phase activities as well as the remaining tasks.

3.4 IMPLEMENTATION AND START-UP ACTIVITIES

After developing the elements of the quality system, the system is put into practice during the implementation phase. The method of implementation can have a major influence on its success. Figure 6 shows the main activities involved in implementing a quality system. The following sections describe these activities in more detail.

During the implementation phase, management and staff should develop a clear understanding of the quality system procedures and policies of the organization. They should understand EPA’s quality requirements in general terms and the specific quality procedures for their own work processes. An understanding of when, and under what circumstances, specific quality documents are to be prepared and to whom these documents should be sent for review and approval is also needed. Management should also have an understanding of how to implement and document the quality procedures and how to report the results of these procedures. They should be aware of the need to look for ways to improve the quality of the work processes. Finally, they should be prepared for internal and external assessments of the work processes and for corrective actions arising from the assessments.

Middle managers may face unique problems during implementation. Even with support and guidance from senior management, work processes under their supervision will be changed in the midst of maintaining normal work flow. These managers should receive the active support of the team to implement the quality system for their processes successfully.

3.4.1 Determine the Implementation Strategy and Schedule

The team should prepare a detailed schedule for the implementation of the quality system based on a coherent strategy. This strategy should take into account the circumstances and unique characteristics of the organization and should be consistent with the overall quality system development effort.

The third step in the Shewhart cycle, “Check,” involves evaluating the validity and worth of proposed solutions. The implementation should be designed to provide opportunities for early feedback and corrective action loops so that newly developed quality procedures can be checked for

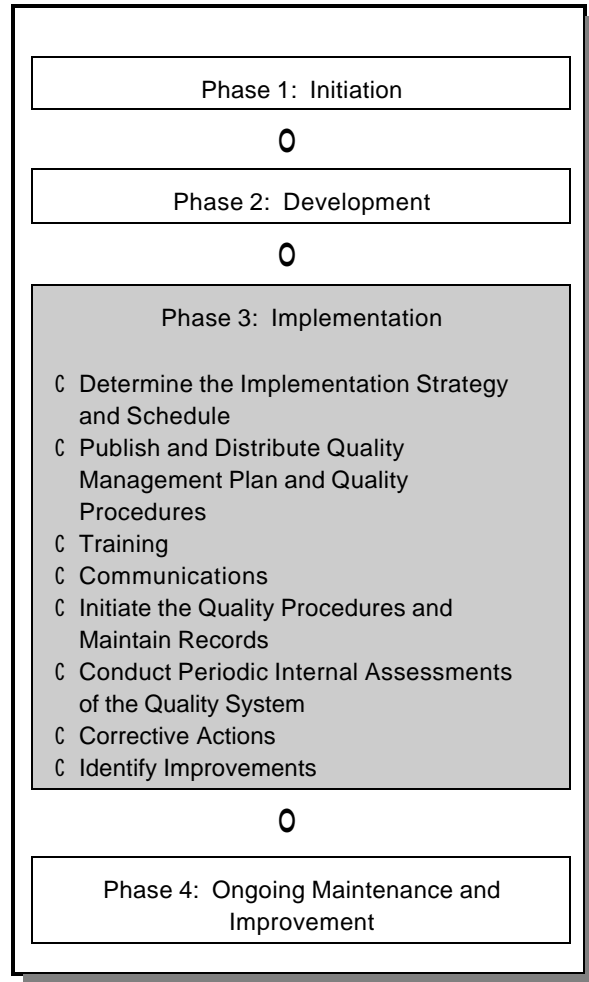

Figure 6. Implementing the Quality System (Phase 3)

improved performance results. If appropriate and feasible, the team may want to consider conducting a pilot study in a target program or division. Complications or oversights may be identified and corrected before investing in the full implementation of the quality system by testing some of the implementation activities, such as training and quality procedures. This approach gives senior management a way to assess the validity of the procedures before they are implemented throughout the organization and can also provide some initial estimates of the costs and benefits of the procedures. Whether or not a pilot study approach is taken, the strategy should have the potential for significant improvements over a short period or have a large positive impact across the entire organization.

Although it is quite possible that the actual implementation process will deviate from the original schedule, developing the schedule is still important. The schedule is a tool for the team to track the process and determine if unforeseen problems are occurring. Management will need tangible milestones to justify the expenditure of resources needed to implement the quality system and to monitor the team's progress.

“While you are attempting to get your staff to adopt this new way of working, your organization will still need to complete its assigned tasks. Expect a long transition period, lasting several years, where you gradually replace one way of working with another.”
– Hunt, 1993

The process of developing a detailed schedule encourages the team to address the implementation process in a rigorous fashion. The steps in this schedule should involve tangible measurable activities that can be verified by an external observer. The implementation process should be broken down into steps that are small enough to allow reasonable tracking of the process. Separate schedules can be used for different subgroups in the organization.

The implementation schedule should be realistic. Full implementation may require several years. It is important that the team not expect the process to occur swiftly and that they do not become disillusioned because of unrealistic expectations. They should be prepared and be committed to all efforts needed to achieve implementation. Management should be aware of the schedule and willing to support the team during the entire implementation process.

During the initiation phase, the team may have identified individuals who are potential champions of the quality system because of their attitudes or the strategic positions that they occupy. A champion has the following characteristics:

- C power, influence, and resources to get things rolling and maintain momentum;
- C respect of the management and staff; and
- C interpersonal skills needed to persuade people to take action (Carr and Littman, 1990).

These individuals are logical choices to check the quality procedures during the early phases of implementation or during a pilot study. They are likely to be objective about the procedures, and their assessment of the validity of the procedures likely will be credible to the rest of the organization.

The team should be careful to involve the managers of the champion in the process (Carr and Littman, 1990). These individuals are possibly being asked to participate in the quality system before they fully understand it. The team should inform them about the quality system and involve them in the early assessment. Information gained from the early assessment or pilot study will allow the team to modify the procedures during the later stages of quality system implementation.

3.4.2 Publish and Distribute Quality Management Plan and Quality Procedures

The QMP and the quality procedures should be known and accessible to all staff if the quality system is to be successfully implemented. The initial publishing and distribution of the QMP and quality procedures should be coordinated with the initial training and communications from management.

A document control system should ensure that the staff has the most current versions of the QMP and quality procedures. However, the document control system should not become a paper bureaucracy that expends excessive effort on managing the quality system documents. The documents should be readily accessible to staff in a format useful to them.

If the organization has an internal website, the team should consider posting and maintaining quality system documents online. This approach to document distribution allows these documents to be accessible to everyone in the organization. The documents can be updated without the need to distribute paper copies throughout the organization.

3.4.3 Training

The introduction of the quality system may require staff to change the work processes that are familiar to them. They may be asked to do new things using new techniques and new terminology. Training will help staff obtain the conceptual tools needed to implement the quality system.

Training should be a normal work process in an organization and should be integrated into other work processes as part of the overall effort to develop, implement,

“It is the author’s belief that training is the single most important factor in actually improving quality, once there has been commitment to do so. For training to be effective, however, it must be planned in a systematic and objective in manner. Quality training must be continuous to meet not only changes in technology but also changes in the environment in which an organization operates, its structure, and perhaps most important of all, the people who work there.”
– Oakland, 1993

and continuously improve the quality system. Staff and management need to see the quality system as an integral part of the organization and as something that has an impact on their day-to-day activities. If staff's only interaction with the quality system is an annual visit from an assessor, they are likely to regard the quality system as an unnecessary diversion from their work.

Everyone in the organization should receive training on the quality system. It is unlikely that generic quality system training courses can address the specific needs of each organization. Similarly, it is unlikely that a single training course customized for an organization can address the specific needs of every individual in the organization. The amount of training and the topics to be included in the training should depend on each individual's role in the organization and on their specific training needs. Everyone should also know the basics of the quality system as well as the underlying reasons for implementing the quality system. Everyone should also know the quality procedures needed for their specific jobs. More specialized quality training, such as document control procedures or statistical techniques, should be taught to those individuals who can apply these procedures in their jobs. Information about developing and implementing a quality training program is available in *Guidance for Developing a Training Program for Quality Systems (QA/G-10)* (EPA, 2000c).

Quality training should have short-term objectives (e.g., what and how) and long-term objectives (e.g., why). Short-term training should focus on an overview of the quality system and the specific quality procedures that individuals need to know immediately to do their work under the quality system. Staff will be able to apply this practical knowledge immediately and better retain the knowledge that they apply. Long-term training should focus on the overall quality system and the quality principles that underlie it. The staff is likely to appreciate and retain this theoretical knowledge after they have mastered the practical aspects of the quality system. Both types of training are necessary; long-term training should not be deferred indefinitely.

Training should be provided at all levels of the organization. Neglect of training at any level can delay, and perhaps prevent, implementation of the quality system. Senior Management should be shown how to define the quality policy and objectives, how to establish the organizational structures needed to implement the quality system, how to clarify the authority of the quality system, and generally how to create the atmosphere in which the quality system will thrive. Quality Assurance Staff should know how to assist management and staff in implementing the specific quality procedures that each individual needs to know and how to promote the ownership of the quality system by the management and staff. Middle management should know the technical skills needed to plan, implement, and assess changes in work processes under their control to implement the quality system. Supervisors should know general quality principles, the reasons for the quality system, and their role in the quality system. At the end of their training, supervisors should be convinced of their own senior management's commitment to the quality system. All other staff should know the basics of the quality system and the specific quality procedures needed to perform their duties.

Common approaches to training include using designated in-house trainers, cascaded training, and training by outside consultants (Goetsch and Davis, 1995). The most common approach is to train designated trainers in quality principles and procedures and then have them train the rest of the organization. This approach has the advantage of consistency of instruction and can be continued indefinitely as on-the-job training. Cascaded training involves passing the training down from senior management to middle management and from middle management to the rest of the organization. This approach has several advantages:

- c individuals are likely to work harder at learning if they expect to teach the subject matter to others;
- c preparations for teaching and the actual teaching itself reinforce the teacher's knowledge of the subject; and
- c when managers teach, it shows that they are serious about the subject matter.

One disadvantage of cascaded training is that individuals differ in their abilities to be effective teachers. The third approach is to use an outside consultant to do the training. This approach may be most useful early in the implementation process until an in-house capability can be developed. The disadvantage of this approach is that the outside consultant may not be familiar enough with the organization to tailor the training for the specific structure, procedures, and culture that exists in the organization.

Mentoring is also an effective training approach to supplement formal training. Members of the development team and other champions of quality identified by the team can train others in quality principles and procedures as part of their everyday activities. Mentors can transfer specific information about quality principles and procedures needed to accomplish the task at hand. The training will be fresh when it is applied in a real setting. This approach can reduce training costs associated with presenting information on quality principles and procedures that have no applications for specific individuals.

3.4.4 Communications

Communications are another way to demonstrate senior management's commitment to quality. The staff should hear a clear and direct message about the importance of the quality system, management's support of its development, and the staff's role in its development and implementation. Initially, management could prepare and disseminate the mission

“Honest, open communication is probably the single most important factor in successfully creating a quality management environment. It will take time, but it can lead to trust and mutual respect, and it can sometimes be the only thing that keeps the effort alive. If people keep talking to one another, they can work through problems, overcome barriers, and find encouragement and support from others involved in quality management efforts.”
—Hunt, 1993

statement and perhaps describe the QMP. The infrastructure for developing and implementing the quality system could be described, and subsequent messages would describe the quality system in greater detail, the implementation schedule, and resources that are available to the staff regarding the quality system.

Communications and training should address both the technical and human sides of the quality system. The staff's first question concerning the quality system is more likely to be "How will the quality system affect me?" rather than "How will the quality system change the work process?"

It is likely that the staff has heard about the quality system before it was formally announced, and they may have misconceptions and fears about it and its impact on their jobs. They may believe that the quality system is being introduced because someone has decided that their performance is deficient. Unless training and communications correct this misconception, staff may resist implementation of the quality system. Staff should be reassured that the overall organization, rather than individuals, is the focus of the quality system.

3.4.5 Establish a Program for Recognizing Quality Performance

Recognition by management of an employee's good work can take oral or written form. It provides motivation and support for the employee, encourages others to do likewise, and improves productivity. Effective recognition has the following characteristics:

- C it is specific so that the employee knows the actions that are recognized;
- C it is directed at the right person;
- C it is genuine;
- C it is given closely following the recognized activity; and
- C it focuses on the quality procedures that are being encouraged, rather than on the specific results of following those procedures.

"The success of quality management is determined, in large part, by the degree of importance the organization places on it. Recognition is one of the most important ways to reinforce a proactive, positive change in behavior as it relates to quality improvement. Recognition is given for the successful application of the quality management principles and practices."

– Hunt, 1993

3.4.6 Initiate the Quality Procedures and Maintain Records

After the quality plans and procedures have been distributed and staff has been trained, the actual use of those procedures should be initiated, and quality records maintained as objective evidence that the quality system is functioning properly. As with any other major change, the quality system will

not be implemented without problems. Management should plan to prevent the foreseeable problems and quickly address the unforeseen problems that inevitably arise. Management and staff should be ready to implement the quality procedures that have been distributed. They should be aware of the results of any pilot studies that were conducted.

Administrative and logistical support for the quality system needs to be in place to handle the flow of paperwork that will be generated by the quality system. For example, the authors of QA Project Plans need to know who to send the plans to for review and approval.

The quality system policies should define what quality-related records need to be maintained. Quality records provide objective evidence that work processes conform to the quality procedures (i.e., what has been done). These records are different from quality procedures, which specify what should be done. Written procedures should specify how quality records are to be prepared, reviewed, stored, and disposed. The retention time for quality records should be specified. Examples of quality records may include inspection reports; calibration test results; corrective action forms; review and sign-off sheets for reports, plans, and procedures.

3.4.7 Conduct Periodic Internal Assessments of the Quality System

A periodic internal assessment is a process for assessing an organization's practices as they relate to its quality system. The focus of the assessment is on the quality system. It does not judge the quality of data and information to support an individual decision nor does it judge performance or competency of personnel. These assessments are designed to assess the organization's quality system and provide an unbiased and objective source of feedback about the quality system. The assessment seeks to determine if a quality system is implemented and is operating within an organization in the manner prescribed by the approved QMP and consistent with current EPA policies (EPA, 2001c).

The assessment includes quality system document review, file examination and review, and interviews of managers and staff responsible for environmental data operations. The assessment focuses not only on recognizing the effectiveness of a quality system and noteworthy accomplishments, but also on the identification of nonconformances and needed improvements.

“Self-assessment allows an organization clearly to discern its strengths and areas for improvement by focusing on the relationship between the people, processes, and results. Within any quality-conscious organization it should be a regular activity.”
– Oakland, 1993

The purpose of periodic assessments is to determine the adequacy and effectiveness of the quality system being applied to environmental data operations conducted by or for EPA. Because the

Agency's decisions rely on the quality of environmental data, it is imperative that the effectiveness of QA implementation is assessed periodically. Assessments are tools for determining the adequacy and effectiveness of the quality system applied to environmental data operations.

An assessment can answer the following questions:

- c Does the organization understand what it has to do to meet requirements, particularly those given in the Order and related federal regulations?
- c Does the organization do what it says in its documents, particularly in its QMP?
- c Does the quality system work as designed to support environmental decision making with environmental data that are sufficient in quantity and quality appropriate for their intended purpose?

3.4.8 Corrective Actions

Some of the findings from the internal assessments will indicate work processes in which quality practices can be improved. The assessors may have found that the quality procedures are not being followed. Their analysis of the situation should have addressed both the work processes and the quality procedures. In some cases, the staff may have encountered an impractical quality procedure that looked reasonable during planning, but an alternative procedure that works or works better. It is also possible that the quality system development team may have had an incorrect understanding of a work process while the quality procedure was being developed. There may be external determinants that prevent the application of the quality procedures. In the absence of extenuating circumstances, the staff may be unwilling or unable to implement the quality procedure. Appropriate steps need to be taken to ensure that reasonable quality procedures are used in the quality system, that the staff can adopt the quality practice, and that the work processes have outputs that conform to EPA policies and adequately support environmental decisions.

Deming (2000) was careful to distinguish between variability of a process that arises from common causes inherent within the process and variability that arises from special causes from outside the process. The former is a normal characteristic of the process and does not require corrective action. The latter represents an out-of-control situation that requires corrective action. This distinction is the basis of statistical process control. Deming notes that trying to correct a work process experiencing normal variability—called “tampering”—is counterproductive and may lead to greater variability. Deming’s distinction is as valid for processes that are not easily quantified as it is for industrial processes for which many copies of the same item are produced. Distinguishing the two types of variability is harder. Corrective action should not be taken unless it is necessary.

The development and implementation of corrective actions are the responsibility of the management and staff who are involved in the work process. The quality system development team or

the auditors can provide recommendations and technical assistance in developing appropriate corrective actions, but the work process does not belong to them. Any corrective action imposed from the outside is likely to be resisted. The implementation of the corrective action should be documented and maintained with other quality records.

3.4.9 Identify Improvements

The fourth step in the Shewart Cycle involves adjusting the quality system based on information obtained during the assessments. As the quality system is being implemented, the team will interact with management and staff and will obtain some feedback about the effectiveness of the various components of the quality system. This information should be used to revise the QMP and the quality procedures as necessary to improve the overall process.

It is likely that the quality system as implemented will differ in some respects from the quality system originally planned and documented. These differences are not necessarily deficiencies because the team may not have perfect knowledge of the organization's work processes. The quality system documentation should be modified to describe the quality procedures that work for the organization.

Below are four strategies that can be followed to improve the quality system:

1. Collect meaningful data about the work process that are free from errors of measurement or procedure and that have a direct application to the work process.
2. Identify root causes of problems, rather than the symptoms.
3. Develop appropriate solutions based on meaningful data and applied to the root causes.
4. Make thoughtful changes after careful and deliberate planning and foresight and with adequate resources, rather than reacting too quickly (Goetsch and Davis, 1997).

By modifying the quality system based on feedback from management and staff, the team will help ensure that the organization will see that it has ownership of the quality system.

Quality System Development Example

Phase 3: Implementation

The Quality System development team identified several possible strategies that could be followed to implement the quality system. The "blitz" approach would involve adoption of the quality system across the entire division at one time.

A gradual approach would involve the adoption of the quality system by different sections. Because federal oversight was focused on individual monitoring programs, and because quality systems in the State were decentralized, the monitoring division head decided to

implement a quality system that would involve only those individuals participating in the new program. The sampling, analytical, and data management components of the program would all implement the quality system at the same time.

The division's QA specialist conducted periodic internal assessments of the monitoring program's quality and technical systems. These assessments were conducted in the central laboratory and the district offices. Performance evaluations were conducted in the central laboratory and at individual monitoring sites. The quality representative from the EPA regional office conducted external assessments of the program's quality and technical systems after the first year of operations and at biannual intervals afterwards. Performance evaluation samples were sent to SDEP from the EPA National Monitoring Laboratory on a quarterly basis.

During the performance evaluations at individual monitoring sites, the division's QA specialist found that the sampling apparatus' calibration drifted outside of control limits for a significant number of the network's sites on multiple occasions. This calibration drift caused many measurements to be invalidated. Further investigations at the central laboratory revealed a design flaw in the sampler. The samplers' manufacturer was contacted about the problem, and a modified part was designed that brought the calibration drift back into control.

3.5 ONGOING MAINTENANCE AND IMPROVEMENT

At this stage, the quality system development team generally transfers responsibilities to a more permanent group within the organization. The organization should develop the infrastructure to maintain and improve the quality system as appropriate for the organization. It could involve a centralized quality group or a decentralized group of individuals who are responsible for quality for specific work processes.

Phase four of the quality system development process fundamentally involves activities to establish the Shewhart cycle for continuous improvement. Figure 7 shows the activities in Phase 4, and are explained in more detail below.

3.5.1 Allocate Resources per the Budget Cycle

After the initial implementation of the quality system, additional resources should be allocated for its maintenance and improvement. Resources should be allocated for nonroutine activities, such as new programs in the organization that should be integrated into the quality system. Resources should also be allocated for ongoing quality systems training for management and staff.

3.5.2 Conduct Routine Quality Assurance

Ongoing maintenance activities can involve a number of quality assurance activities. These may include reviews of quality documents, such as the organization's QMP and the QA Project Plans for environmental data collection activities. Activities may also involve quality system audits and technical systems audits and preparation of QA Annual Report and Work Plans.

3.5.3 Implement Improvements

The Shewart cycle is based on the concept of continual improvement; work processes are refined to reduce errors and variation in the quality of the product or service. Deming (2000) expressed this concept as: "Improve constantly and forever the system of production and service, to improve quality and productivity, and thus constantly decrease costs."

Continual improvement is focused more on improving the process, rather than on improving the output from the process. Japanese quality experts, such as Kaoru Ishikawa, see a quality system more as an ongoing process that results in improving quality without a specific endpoint (Beckford, 1998). Under Ishikawa's model for quality, continual improvement consists of slow, incremental improvements in quality. All involved with operating a process are encouraged to find ways to improve the process and are given the tools and management support to develop and implement the improvements. Product and service quality will improve as a consequence of these improvements.

This concept is based on the assumption that many small changes to an existing process can produce larger cumulative quality improvements than can a few radical changes. This assumption may not be valid if the process cannot be further improved or if innovative techniques would require a complete redesign of the process.

If continual improvement is to become an effective technique, there must be some way to monitor the output of the process and to detect small changes in the quality of the product or service.

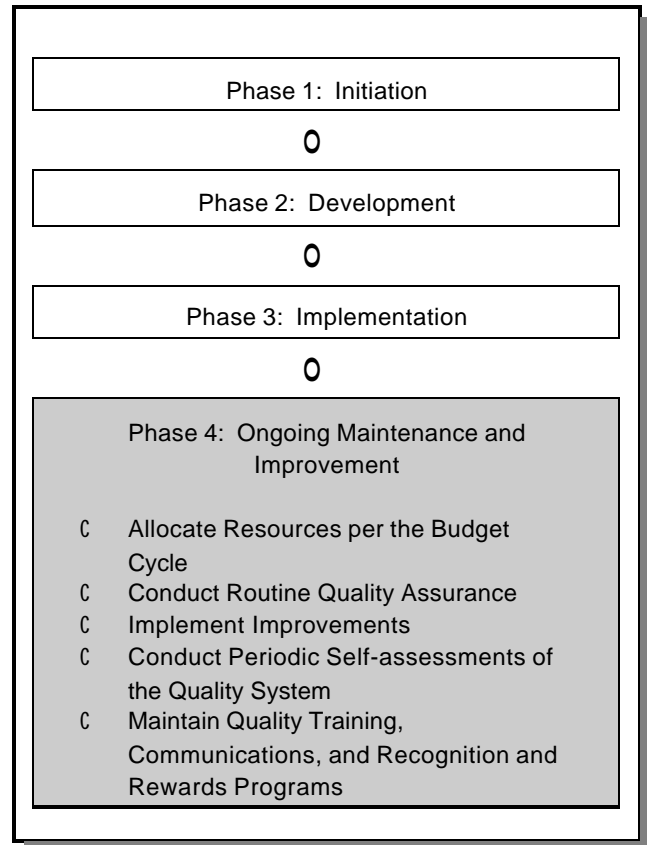

Figure 7. Maintaining and Improving the Quality System (Phase 4)

For example, the contamination level in a blank sample might be a parameter that could be monitored in an analytical laboratory. In an organization involved in reviewing and approving permit applications, the time between the receipt of the application and the notification of the applicant regarding permit approval might be a quality parameter to monitor. This approach requires that enough data has been collected about the process to allow small quality improvements to be detected amid the normal variability of the parameter.

Techniques for continual improvement may have to be altered for research and development organizations because each product of the process is unique. For these organizations, the best approach is to look for ways to monitor the progress of the work constantly so that refinements can be made. Continual improvement becomes ongoing course corrections the first time a path is taken, rather optimizing a path traveled previously. For example, a researcher might reduce and analyze data as it is being collected to determine if data quality objectives are being attained, rather than waiting until the end of the research project to assess whether the entire data set attains the objectives. Another way to improve a research project is to review the procedures used to conduct the work continuously. A researcher may find that a data collection or data analysis technique can be streamlined or that a previously unrecorded measurement parameter yields important insights into the phenomenon being studied. There are opportunities to improve research and development processes if these processes are critically monitored.

“Putting out fires is not improvement. Finding a point out of control, finding the special cause and removing it, is only putting the process back to where it was in the first place. It is not improvement of the process. You are in a hotel. You hear someone yell fire. He runs for the fire extinguisher and pulls the alarm to call the fire department. We all get out. Extinguishing the fire does not improve the hotel. That is not improvement of quality. That is putting out fires.”

– Deming, 2000

3.5.4 Conduct Periodic Self-Assessments of the Quality System

The organization should conduct periodic self-assessments of the quality system to ensure that the organization is functioning as described in the QMP. The results of these assessments may lead to corrective actions for nonconforming processes and also may identify opportunities for improvements in the system.

3.5.5 Maintain Quality Training, Communications, and Recognition and Rewards Programs

Training, communications, recognition, and rewards are essential to the long-term success of the quality system. They are ways to demonstrate senior management’s continued commitment to the

quality system. Regular communications, recognition, and training about the quality system help to decrease resistance to its implementation.

Ongoing training should involve senior and middle management and staff. It should involve new employees and current employees who were trained during the implementation phase. The training should be tailored to each group's specific quality responsibilities in the organization.

Ongoing training should be provided because the organization and the quality system are evolving. This evolution can be considered as a three-step process as outlined below:

1. Analyze work processes to improve them.
2. Experiment with and adopt new ways of performing tasks.
3. Implement new work processes by training the management and staff to do the work in a new way (Cohen and Brand, 1993).

Quality System Development Example

Phase 4: Ongoing Maintenance and Improvement

As part of its routine QA activities, laboratory analysts maintained routine control charts for QC indicators, such as instrument calibration drift, QC spike recoveries, and laboratory and field blanks. Review of these control charts revealed consistent field blank problems associated with a specific sampling site. The SDEP QA specialists used Pareto charts to investigate QC problems for this site. They discovered an unusually high incidence of temperature control problems for the sampler at the site. Senior sampling technicians investigated the sampler and found that the temperature-control printed circuit board had failed. This discovery prompted the sampler manufacturer to redesign the printed-circuit board to make it less vulnerable to power line voltage spikes. The incidence of field blank problems decreased after the redesigned board was installed in all samplers in the network.

The quality system development team analyzed the quality training needs associated with the new method. They decided that these needs would be met by a combination of existing departmental quality training and additional training that would be specifically tailored to the new method. All new SDEP staff are required, as a condition of their employment, to take a one-day basic QA course given annually by SDEP's QA specialists. A small group of senior district field technicians would be trained by the new sampler's factory representatives in operating and maintaining the sampler and in its QC procedures. The senior technicians would then return to the district offices where they would travel to individual monitoring sites to deploy the samplers, train junior technicians, and begin routine sampling. All laboratory analysts and information technology specialists in the central laboratory would attend a multi-day training class given by the EPA Regional Office on the method's analytical procedures.

Summary

The development of a quality system can be viewed as occurring in four main phases:

1. Initiation
2. Development
3. Implementation
4. Ongoing maintenance and improvement

The initiation phase is the first step in building a quality system and requires obtaining management commitment, establishing the quality team, writing quality policy, and obtaining resources for developing the quality system. The development phase includes writing quality documents and SOPs, assigning project tasks and responsibilities, developing system tools, and conducting audits. The implementation phase requires publishing and distributing quality plans and SOPs, training staff, record keeping, and making quality improvements to Agency work processes. The ongoing maintenance and improvement phase requires routine QA activities, periodic system audits, continual quality improvements, and ongoing training, communications, recognition, and rewards.

CHAPTER 4

CASE STUDIES

This chapter presents two case studies that illustrate how the process for developing a quality system described in Chapter 3 would be applied to two types of organizations: one operated like an academic organization and one that is a regulatory agency. In practice, the development of a quality system is a highly individualized process; to be effective it should be tailored to each organization. Thus these case studies represent examples and are not intended to prescribe the development and implementation process.

The successful development of the quality systems described in these case studies is not intended to minimize the difficulties in the process. Within any organization, issues such as organizational structure, mandate, scope of responsibilities, staffing, and other resource limitations may either define or limit the development of a quality system. These issues should be identified during the planning stage so that realistic objectives, schedules, and budgets will be established. Implementing a modest quality system that addresses elements considered critical to their activities is better for organizations with limited resources than to plan an elaborate system that cannot be implemented. Section 3.2.6 discusses the assessment of these issues during the planning stage.

4.1 QUALITY SYSTEM DEVELOPMENT IN AN ENVIRONMENTAL CONSULTING FIRM

This case study illustrates how the quality system development process and tools may be applied at an environmental consulting firm that has several different research departments and relatively limited resources to conduct this process. This case study is a fictitious example that is loosely based on an actual quality system development effort. The example is not intended to portray actual policies or depict actual events at EPA or other organization; it is for illustrative purposes only.

4.1.1 Background

In 1999, the Marine Research Institute (MRI) was awarded a six-year EPA contract to conduct an environmental monitoring study in Massachusetts Bay. The study's purpose was to establish baseline data that could be used to benchmark water quality in Massachusetts Bay before the start-up of a power plant that would use high-sulfur crude oil as a fuel source. One stipulation of the contract award was that before beginning any technical activities, MRI had to provide EPA with a QMP that described its quality system. EPA defined the monitoring program as an assessment of the benthic community within a 5-mile radius of the proposed ocean outfall; the deployment of caged mussels for the analysis of uptake of trace metals, polychlorinated biphenyls, pesticides, and semi-volatile compounds from the water-column; and the analysis of sediments for the same suite of

chemical compounds. This monitoring program involved four separate research departments at MRI: field sampling, ecology, inorganic analytical chemistry, and organic chemistry. The contract's principal investigator was Dr. David Marino, a senior research scientist within MRI's ecology department. Dr. Marino's challenge was to convince his colleagues of the need to work together to establish a quality system within each department.

At MRI, the development of a quality system based on ANSI/ASQ E4 and in compliance with EPA's quality system requirements defined in the contract involved four main phases: (1) initiation, (2) development, (3) implementation, and (4) ongoing maintenance and improvement.

4.1.2 Initiation

The first step in developing the quality system at MRI was to determine if the MRI research director would approve the effort and provide the necessary resources. Dr. Marino met with the research director and the department heads of the field sampling, inorganic analytical chemistry, and organic chemistry departments to introduce them to the key elements of a quality system and to propose establishing a quality system at MRI. All participants raised significant objections during this meeting. Most notably, department heads resisted slowing researchers with time-consuming documentation procedures and systems when their reputations as outstanding scientists were well-recognized. The time necessary to establish quality systems in each department was a major concern, as was the availability of staff to work as part of a team and the lack of funding for the activity. Dr. Marino countered their objections by stressing the importance and value of the work and the EPA contract to the organization and by stating that the establishment of a quality system should be considered an investment for future work. He explained that the philosophy of a quality system is consistent with the mandate of an educational institution. In the end, the research director agreed to limited support of an initial effort that would assess what would be required, how much it would cost, and whether MRI could develop the quality system in time to perform the work for EPA.

Each department head identified a research assistant to work with Dr. Marino on a quality system development team (QSDT). Each team member would be vested with responsibility to represent the department in QSDT meetings. They would routinely report to their departments on progress, quality system issues, and implementation procedures so that concerns and problems could be identified and addressed.

As a first item of business, the QSDT agreed that their combined units should be identified as the MRI Environmental Monitoring Group. This would specify the departments that would be included in the scope of the quality system to be developed. They then drafted the following quality policy statement:

It is the policy of the MRI Environmental Monitoring Group to produce environmental data that meet the quality needs of our clients.

Based on the types of activities to be conducted for the EPA power plant project, the QSDT determined that the quality system should include the elements listed in Table 7. Critical elements were identified as:

- C the establishment of a QA function,
- C the need for up-front project planning,
- C development of a documents and records management system,
- C establishment of basic documentation procedures, and
- C preparation of SOPs.

Table 7. Quality System Elements Required for the MRI Environmental Monitoring Group

Quality System Element	Policy Agreement	Estimated Time and Resources to Complete
Management Policies		
Management and organization	Each department head is responsible for the quality of data generated within the department. Department heads will designate project managers and QA Officers.	
Quality system and description	The quality system for the EPA monitoring project will be described in a QMP that will apply to all departments involved in the project.	80 hours over 2 months
Personnel qualifications and training	There must be a record of personnel proficiency, experience, or training for each staff member. Staff members should not perform work on tasks for which they have not been trained unless they are working under the supervision of a qualified staff member.	80 hours over 1 week (4 hours for each staff member) (based on 20 project team members)
Procurement	Supplies must be of appropriate quality for the intended end-use of any data generated and must be inspected to ensure that they are correct and usable.	16 hours over 1 month (10 hours to develop and document procedure; 2 hours to train; 4 hours to assess)
Documents and records	The following records must be maintained by each department: training, SOPs, equipment maintenance and calibration, and preparation of analytical standards. The following records must be maintained for each project: sample processing, analysis, data reduction procedures.	60 hours over 3 months
Computer hardware and software	Computer hardware must be adequate for the software application. Software must be tested. Noncommercial software must be validated.	20 hours over 2 weeks

**Table 7. Quality System Elements Required for the
MRI Environmental Monitoring Group**

Quality System Element	Policy Agreement	Estimated Time and Resources to Complete
Management Policies, continued		
Planning	A QA Project Plan must be prepared for each project. Each Plan must follow a prescribed format unless another format is specified for the project.	10 hours to develop, document, and train
Implement work processes	The project manager must conduct the project work according to the requirements of the QMP, the QA Project Plan, and the appropriate SOPs.	8 hours to develop, document, and train
Assessment and response	Some form of independent assessment should be performed for each project. The level of assessment should be defined in the work/QA Project Plan. Assessments may include Peer Review, Project Manager Review, external review, and QA review.	8 hours to develop, document, and train; 2 hours per project for the first 6 months.
Quality improvements	Each department should identify areas for quality improvement through the assessment and audit process as well as through initiatives within the department.	2 hours per week for the first 6 months
Environmental Data Policies		
Planning and scoping	Each project must be described in a work plan that defines the objectives, scope, responsibilities, schedule, technical activities, data quality requirements, assessment activities, and reporting requirements.	10 hours to develop, document, and train
Design of data collection	Routine data collection procedures must be described in SOPs. The project work plan must describe procedures for documenting nonroutine, project-specific, or research activities so that the procedures may be reproduced.	10 hours to develop, document, and train
Implementation	Each project must be conducted according to the work plan unless the project manager documents and receives client approval for modifications to that plan.	4 additional hours per week per project
Assessment and response activities	The assessment activities appropriate for each project will be defined in the work plan. At a minimum, each project will be assessed by the project manager. Additional assessments may be conducted by peers, the QA Officer, or external reviewers. Assessment results must be documented. Responses must include correction of deficiencies.	8 hours to develop, document, and train; 2 hours per project for the first 6 months
Assessment and data usability	For projects that include the collection of environmental data, an assessment of data usability based on the project data quality objectives must be conducted. Data that are considered “unacceptable” must be qualified.	8 hours to develop, document, and train; 2 hours per project to implement

**Table 7. Quality System Elements Required for the
MRI Environmental Monitoring Group**

Quality System Element	Policy Agreement	Estimated Time and Resources to Complete
Operation of Environmental Technology Policies		
Planning	Each project must be described in a work plan that defines the objectives, scope, responsibilities, schedule, technical requirements, and the required accuracy, precision, and sensitivity of the technology, assessment activities, and final product.	10 hours to develop, document, and train
Design of systems	A design plan must be prepared and approved prior to fabrication of hardware or development of software.	10 hours to develop, document, and train
Construction and fabrication	The construction and fabrication of equipment or software must be according to the design plan. The materials must meet the quality requirements of the end-use product.	8 hours to develop, document, and train
Operations	Construction, fabrication, and development activities must follow accepted engineering procedures. Routine procedures must be defined in SOPs.	8 hours to develop, document, and train; 2 hours per project for the first 6 months
Assessment and response	Construction and design activities must be reviewed by the project manager at the end of each phase to ensure that the end product will meet the design specifications.	8 hours to develop, document, and train; 2 hours per project for the first 6 months
Verification and acceptance	Both a beta test and an end-use test must be performed to ensure that the final product meets the project objectives.	8 hours to develop, document, and train; 2 hours per project for the first 6 months

The QSĐT drafted simple policy statements for each element of the quality system and reported the statements to the department heads to ensure that there was general acceptance of a skeletal quality system. The QSĐT reviewed these policy statements with Dr. Marino. He focused the QSĐT on creating the simplest quality system that would meet the needs of his project.

The QSĐT members surveyed their department to identify procedures that were currently in place. For efficiency and to ensure that similar elements of the quality system were tallied in each department, the QSĐT re-phrased the quality system elements in general terms (e.g., training requirements and records, written methods, and data reviews). In addition, each department identified any operating policies (e.g., ethics) that should be incorporated into the quality system. Once the inventory was complete, the QSĐT compiled the results in a two-dimensional matrix that listed each quality system element by department. This identified elements that existed (at least to some degree) versus those needing development. Among the elements that existed, at least rudimentarily, were written analytical methods, instrument calibration procedures, and data review procedures.

Dr. Marino used the information compiled by the QSDT to estimate the resources, cost, and schedule required to develop the quality system for his project. He then prepared a formal proposal for the research director, describing the need for a quality system, its advantages, the level of effort required to complete the tasks, and the proposed schedule. At this point, several long-term benefits for MRI were obvious to Dr. Marino and the QSDT. They agreed that the quality system would:

- C improve data quality and comparability through the use of documented and standardized technical procedures to be implemented by all researchers;
- C implement consistent training of graduate students within departments;
- C standardize and improve record-keeping procedures to allow data tracking and reproducibility; and
- C improve stability within a department when graduate students leave and are replaced mid-project.

4.1.3 Development

Using the matrix and simple policy statements developed as part of the initiation stage, a draft QMP was prepared. The QMP addressed, in general terms, the group policy for each element. The organizational structure identified roles (e.g., department head, project manager, chief scientist) rather than individuals for implementing the QMP for each department. Although the QMP was specific to the EPA power plant project, Dr. Marino recognized that it could easily be expanded to include other projects. Preparation of the QMP identified the need for SOPs to provide detail that was not appropriate for the QMP or for the group as a whole.

Each QSDT member analyzed his or her department's work flow process using the matrix developed in the initiation phase. The assessment included management, environmental data, and technological activities within each department. The results of this assessment identified similarities that could be codified as group-wide SOPs. Conversely, some practices were obviously discipline-specific, and department-specific SOPs would be required to address some technical issues. Dr. Marino decided that the QMP would establish the policy for determining the need for group-wide or department-specific SOPs. The QSDT agreed that where group-wide SOPs were impractical, equivalent SOPs would be prepared for each department. (Table 8 summarizes examples of similarities and differences, and the types of SOPs that were identified to document these aspects of the quality system of the group). For example, each department had different sample custody, handling, and storage procedures. It was agreed that a group-wide sample custody SOP was impractical but that each department should prepare a custody SOP describing its procedures. The group-wide SOP would define the elements required in each of the custody SOPs (e.g., sample receipt and rejection criteria, limited access areas, and sample holding times and conditions).

Table 8. Assessment of Department Practices

Practices Common to All Departments	Standard Operating Procedure to Establish Common Policy
The department head assigned project management responsibilities based on the technical requirements of the projects.	Preparation of project work/QA Project Plans
No written planning document was prepared prior to initiation of work.	Preparation of project work/QA Project Plans
Each department maintained staff and equipment files. Although staff appeared to be qualified to perform their assigned functions, records of experience or training were not maintained.	Documentation of technical proficiency
Equipment was calibrated prior to operation, but documentation of calibration was infrequent.	Documentation of equipment calibration and maintenance
Written protocols existed for most procedures, but there was no system of review or approval.	Requirements for the preparation and issuance of SOPs
Documentation of environmental data collection did not allow for sample tracking and did not afford the ability to reproduce experimental results because documentation was incomplete.	Collection and documentation of environmental data
Department-Specific Practices¹	Quality Management Plan Topic to Establish Common Policy
Sample custody, handling, and storage varied based on the intended analysis and department resources.	Requirements for sample handling SOPs
Monitoring of laboratory equipment, such as refrigerators, varied based on the laboratory and required sensitivity.	Requirements for Laboratory Equipment SOPs
Data reduction methods varied based on the type of data, project requirements, and experience of the project staff.	Documentation Requirements for Data Reduction Methods

¹Department-specific SOPs will be prepared for these activities.

The issue of QA personnel was the subject of considerable debate within the QSDT. The group finally agreed that identifying a single person as a QA Officer for the entire group was impractical and that there was no funding for an independent unit. Further, as research scientists, no one person could perform a full-time QA function. Dr. Marino determined that department-specific QA Officers would be identified for his project. These QA Officers would be qualified researchers who were not involved in the project but who could adequately assess the conformance of project activities to the QMP and the project-specific QA Project Plan. For the development and implementation stages, the QSDT members agreed to perform the role of QA Officers for their respective departments.

Central storage of records was the next administrative issue confronted by the QSDT. They recognized that some administrative records were key to the quality system but no department wanted to maintain records for the other departments. These records included SOPs, staff training and

proficiency records, and documentation of assessments. Dr. Marino determined that there was no need to create a central quality systems office; instead, all records would be maintained by the appropriate department. Thus, original SOPs would be kept in the department of the author. SOPs applicable to all departments would be distributed to all departments; department-specific SOPs would be distributed within the group.

Once the draft QMP and the administrative SOPs were complete, a compliance audit was conducted in each department to identify areas of compliance, noncompliance, and inconsistency concerning the plan elements. Each department was assessed by a team of two assessors: the pro-tem department QA Officer and the QA Officer of another department. The results of the audit were reported to Dr. Marino and the appropriate department head and were then used to create a list of tasks to address in the implementation phase. The following items are examples of nonconformance identified during the audit.

- c The field team did not have records of ship maintenance, calibration of navigation equipment, or training records for the crew.
- c The ecology group did not have an established sample custody procedure. Samples were stored on office shelves. There were no procedures for the safe handling and disposal of methanol or formalin.
- c The trace metals laboratory did not document the preparation of standards used for instrument calibration. Standards could not be tracked to stock solutions or purity records.
- c The organics laboratory did not document the expiration dates of spiking solutions and calibration standards. Sample extraction methods were not documented and dilutions were not traceable.
- c Documented experience (e.g., curriculum vitae) existed for only half of the staff.

Based on the results of the compliance audit, Dr. Marino prepared a formal work plan that identified, by department, the areas that were not in conformance with the QMP elements. The level of effort required to implement the quality system and a schedule with milestones and due dates was developed by the QSDT.

4.1.4 Implementation

The QSDT planned an event to start implementation of the quality system. The research director presented awards to the QSDT members. Dr. Marino described the quality system and its benefits and emphasized the key role that a quality system had played in the recent success of another organization in obtaining a prestigious research grant. With speeches and the unveiling of the QMP, the effort received significant advance coverage and was the feature article in the MRI newsletter, which included interviews and pictures.

The QSDT understood the importance of some successes early in the implementation process. They used the compliance audit to divide action items into three categories: (a) those that were easily completed, (b) those that were critical, and (c) those that were necessary and time-consuming but not critical. The QSDT scheduled items in lists A and B to ensure some relatively “easy” successes, while continuing to move forward on items that were critical to the core of the quality system. For MRI, the early “successes” included:

- c Establishing records of personnel experience—Each staff member in the department was required to bring an updated curriculum vitae to his/her annual review, scheduled for the month after the quality system start.
- c Placing a cabinet in a central, locked location in which benthic ecology samples would be stored—A shelf was designated for each project, and project managers were given additional shelf space in their offices.

The preparation of SOPs represented a daunting task to the QSDT. In keeping with a need to use limited resources efficiently, Dr. Marino recognized that most analytical methods are based on established literature. Therefore, each analytical SOP consisted of a table of information required for SOPs but not provided by the method, with the method as an attachment.

Dr. Marino found that it took a significant amount of training to get both department heads and staff members familiar with the concepts, policies, and procedures developed during the initiation stage. Training in the QMP requirements and in the application of any new policies was accomplished by holding short, weekly meetings. Because of the critical nature of this phase, Dr. Marino required attendance at these meetings for all staff who wanted to be a part of the EPA monitoring project. A syllabus was created that defined the topics to be covered each week so that participants would understand the time commitment and schedule their work accordingly. Department head participation and support was essential for the success of the training. Dr. Marino was surprised by the support provided by one department head who was chagrined by the results of the compliance audit and had been struggling to reconstruct the research of a former staff member.

Within three months, a basic quality system was in place. Staff members understood the concept of the quality system, the draft QMP was being implemented, a system for maintaining records had been created, and many new record-keeping procedures had been initiated.

Routine quality system audits were scheduled to review implementation of the newly established quality system. These audits included reviews of records, maintenance, training, completion of SOPs, and compliance with SOPs. Department heads were invited to participate in laboratory reviews and staff members were encouraged to perform self-audits. A schedule was developed for each department with enough detail to ensure that all critical aspects of the quality system could be assessed within six months. The results of the audits were reported to Dr. Marino, and issues that required attention were specifically identified to the appropriate staff member and department head. A database of corrective action issues was created so that all members of the group could track progress, participate in addressing issues, and be recognized for successes.

Audits through the first six months continued to identify areas for improvement. For example, the organic chemistry staff discovered that some members used colored tape to identify expired standards while other members used colored tape to indicate the solvent used in preparation. The staff immediately recognized the need for uniform labeling and prepared a SOP and a wall chart to avoid confusion.

It soon became clear that some central administration or coordination of records was needed. Dr. Marino determined that each department would maintain department-specific records and his secretary would act as the records manager for his project.

4.1.5 Ongoing Maintenance and Improvement

The QSDT continued to operate as an active committee for the first year after the initial start of the quality system. After 6 months, however, several members rotated off and others rotated on. It became evident that implementation of the quality system had to continue to be active because staff quickly fell back into old habits. To maintain the established quality system and improve procedures, a QA Officer and an assistant QA Officer were designated in each department. This allowed for the conduct of routine QA audits, follow-up on old issues, and identification of areas where a procedure was inadequate to ensure data quality. In addition, the need to identify long-term costs associated with the quality system became apparent during the annual budget cycle. It was recognized that other projects conducted within the group were benefitting from the quality system improvements and should share the overhead costs associated with maintaining the quality system.

The QMP specified that quality systems audits are conducted within each department annually. The QA Officers within each department agreed to audit each other's departments. This ensured that inconsistencies in compliance to the QMP were identified between departments and provided an

“outside look” at each department’s operations. The results of these audits were reported to Dr. Marino and the department heads and entered as action items in the corrective action database.

4.2 QUALITY SYSTEM DEVELOPMENT IN AN EPA REGULATORY PROGRAM: SIX-YEAR REVIEW OF NATIONAL PRIMARY DRINKING WATER STANDARDS

This section presents a brief case study to illustrate the quality system development process and tools. This case study is a fictitious example that is loosely based on a real quality system development effort at EPA. The example is not intended to portray actual Agency policies or depict actual events; it is for illustrative purposes only.

4.2.1 Background

National laws governing drinking water protection require EPA to review and revise all primary drinking water regulations promulgated by the Agency no less than every six years. EPA’s Office of Clean Water (OCW) established a Six-Year Review Team to establish a protocol for conducting these reviews on an ongoing basis. EPA conducted its first Six-Year Review process from 1999 to 2001, evaluating 64 contaminants in public and private water systems. In this review, EPA analyzed Federal drinking water regulations to determine whether changes in Maximum Contaminant Level standards, analytical methods, treatment technologies, or occurrence monitoring might provide better protection of human health. Once high-priority contaminants were identified for review, EPA OCW analyzed occurrence patterns in greater detail with the goal of making its database more statistically representative of the nation’s public water systems. Some difficulties encountered in evaluating current drinking water regulations included lack of sufficient occurrence data from certain geographic regions, the need to incorporate information from non-detect sampling, and inconsistent data quality from diverse database sources. Data quality assurance and quality management are essential to EPA’s decision-making process in the ongoing Six-Year Review program.

EPA had established a multidisciplinary Six-Year Review Team to coordinate the overall review program, which spans several offices and divisions within EPA’s Office of Water and Office of Research and Development. The team recognized the need to establish a quality system for their program, so they defined quality system development as one of their early tasks. They knew that this would be challenging because the Six-Year Review process involved staff with very different responsibilities, training, and experiences.

The quality system development process involved four main phases: (1) initiation, (2) development, (3) implementation, and (4) ongoing maintenance and improvement.

4.2.2 Initiation

The Six-Year Review Team initiated their quality system development by establishing a quality system subteam, which included leaders of the other major subteams covering occurrence, health effects, treatment technology, analytical methods, and economics. The quality system subteam identified several early tasks. These included outlining EPA's quality policy for the program, analyzing QA requirements for the program, evaluating OCW's procedures and practices used in previous Six-Year Reviews, and getting management approval for the resources needed to improve the process. Critical to the success of the Six-Year Review process was the identification of a division director to serve as the program's quality champion, helping to bolster top management commitment to QA objectives. This EPA manager helped the quality system subteam get management approval for the quality system development schedule, monitored the overall progress of the project, and effectively communicated QA issues to upper levels of management. The quality system subteam worked to help EPA managers within OCW recognize the value to their program's mission of a quality system. With input from the managers, the subteam established a quality policy endorsed by the office director. Management commitment and continuing improvement were essential to the success of the quality system for the Six-Year Review.

Members of the quality system subteam worked together to develop a diagram that shows how the Six-Year Review quality system relates to the programs that generate new data (see Figure 8). This helped the subteam inventory and review existing quality procedures. An initial assessment of OCW procedures helped identify any needed documentation of practices for collecting and managing contaminant data (analytical methods used in laboratories, databases used, etc.) and to identify gaps where applicable quality requirements were not being addressed. For example, the EPA quality team reviewed existing SOPs, analytical methods, and the overall peer review process to identify steps in the Six-Year Review process that needed improvement.

4.2.3 Development

The quality system subteam carefully planned tasks required to develop its quality system and improve Agency performance in completion of the Six-Year Review. The OCW quality manager worked with the subteam to systematically plan and define key performance and acceptance criteria for the Six-Year Review process so that the quality objectives were tied to the program objectives. The subteam then wrote a QMP. The OCW QA Manager assembled existing documents that described the QA and QC activities within each of the subteam areas. The Six-Year Review QMP then described how the subteam areas relate to each other, and filled in some missing elements related to training and quality system audits. All quality system documents were available on the EPA Intranet site for staff and management review. The quality system subteam reviewed SOPs and QA methods and worked with branch chiefs and their staff to revise two organizational procedures.

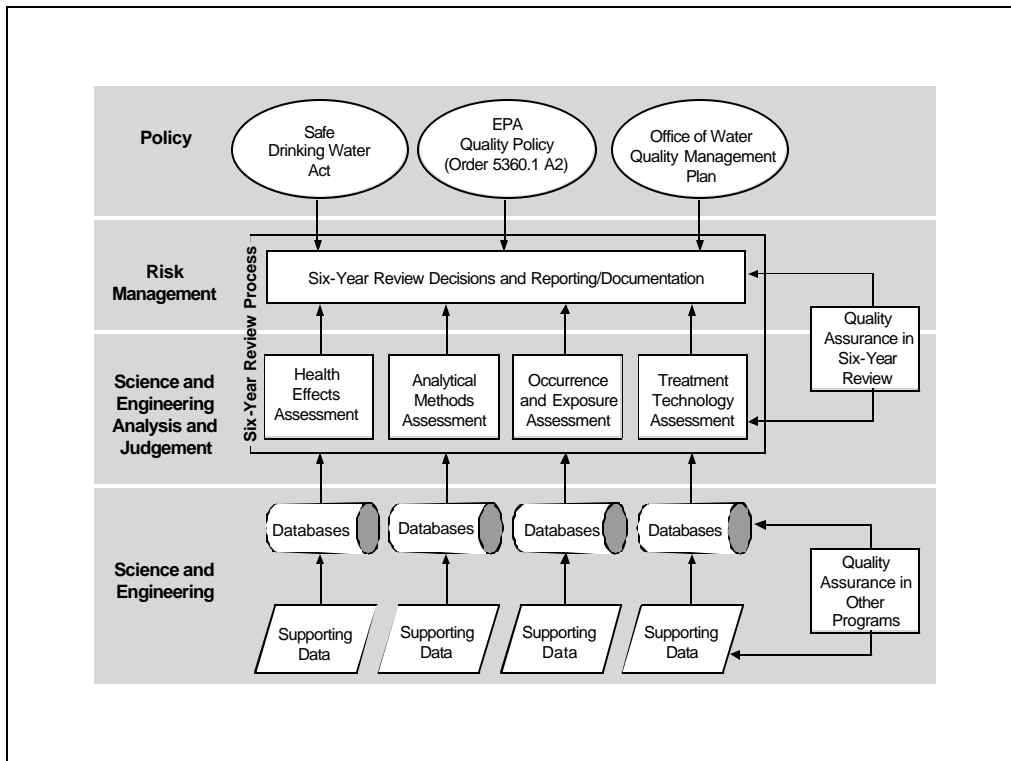

Figure 8. Quality System for the Six-Year Review

After the main quality documents and procedures were developed, the quality system subteam turned its attention to developing a training program to help all staff involved in the Six-Year Review understand their roles and responsibilities in the quality system. To make the training more efficient and useful, the subteam decided to use a combination of Web-based independent study materials and classroom workshops. Staff would be required to use the Web-based training modules before attending a workshop, enabling them to learn the basics at their own pace and schedule. The workshop would be used to explain key points in more detail, answer questions, share problems and insights with colleagues, and give staff a chance to apply the concepts to their own work through exercises.

4.2.4 Implementation

EPA management maintained a commitment to QA through the implementation phases of the Six-Year Review study. The quality system subteam developed an implementation schedule that outlined the time for conducting training, identifying pilot quality improvement projects, and conducting periodic internal quality system audits to determine how well the quality system was working in practice. The training was conducted first and was considered a major success because of the independent study, which prepared staff to come to the workshop with questions and issues. Maintaining quality

records proved to be more challenging. The quality system subteam issued some supplemental guidelines through e-mail about how to use existing routine reports to help satisfy quality documentation requirements, and incorporated those guidelines into updated training. For system audits conducted by quality staff, the QA Manager provided skills training needed to plan, organize, and direct the evaluation of contracting laboratories and data managers that measured and analyzed contaminant information.

An early internal assessment of Agency activities and quality standards was essential for OCW to identify areas where it could improve work procedures or data measurement and reporting methods. An initial quality assessment by management also helped to identify high-priority issues and problems with the data and the reporting system used to record information on health effects and occurrence. The National Contaminant Occurrence Database features built-in QC methods to ensure consistency in contaminant data reporting, identification, and tabulation. The quality team noted data from analytical labs that were suspicious, unreliable, or inaccurate. QA Managers and “process owners” met to discuss what corrective actions were practical and what information would be available in time for review of current drinking water regulations. QA Managers for this study were successful because they created a thorough plan and schedule for all Agency quality activities, demonstrated the benefits of QA and QC activities, and had the resources available to maintain QA activities for the Six-Year Review.

4.2.5 Ongoing Maintenance and Improvement

The OCW conducted routine quality management checks and QC activities over different phases of the process to improve the reliability and consistency of results obtained in the Six-Year Review. Periodic quality system audits were essential to maintaining and improving the quality and efficiency of previous Six-Year Review studies, but were not used in the most recent review. Corrective actions for the review process included changes in lab detection methods for rarely occurring contaminants, use of precision standards for maximum contaminant levels and practical quantitation levels, accurate record-keeping of water quality data, and documentation of current SOPs used in laboratories and by data managers. Any improvements made to data handling, data quality assurance, and management processes were documented on EPA’s Intranet site for use in future rounds of reviews. Table 9 illustrates some quality system actions taken for the most recent Six-Year Review over the four stages of the quality system development process.

**Table 9. Sample Quality System Development Activities
for the 2000 Six-Year Review**

Quality System Development Stage	Sample Quality System Actions for the 2000 EPA Six-Year Review Process
Initiation	Established quality system and Six-Year Review quality policy
	Communicated QA and QC issues and requirements to all levels of management
	Set schedule for gathering and reviewing contaminant occurrence data
	Inventoried and reviewed existing OCW quality procedures and practices
	Reviewed all SOPs for analytical methods; reviewed the peer review process for evaluating contaminant health effects data
Development	Defined performance and acceptance criteria and program objectives for the Six-Year Review
	Reviewed national occurrence estimates and documentation methods used for evaluating contaminant data
	Created process flow diagrams, mapped internal and contractor work processes through each phase of the Review Process, and maintained records
	Documented major revisions to analytical lab procedures, minimum detection limits, and processes for deriving Practical Quantitation Limits (PQLs) for each contaminant
Implementation	Conducted initial quality assessment and developed a quality improvement schedule for the Six-Year Review process
	Created control charts to observe trends in contaminant detection limits and upper and lower warning limits for Practical Quantitation Limits (PQLs)
	Developed an organization chart to document the chain of command and flow of information through the review team
	Used a short quality system checklist and accurate record-keeping to monitor actions taken to ensure data quality
	Process owners met to discuss what QC actions were practical and what information is available in time for review of current drinking water regulations
Ongoing maintenance and improvement	Recommended a detailed quality review of national contaminant occurrence estimates and supporting databases
	Constructed process flow diagrams and reviewed data operations that supported all Agency occurrence estimates
	Periodic quality reviews, communication, and meetings between levels of EPA management
	Completed Six-Year Review <i>QA Appendix</i> to the 2001 Protocol
	Documented quality management procedures and improvements in data quality for future Six-Year Review Processes

After conducting a Six-Year Review quality system audit, the QA Manager recommended a detailed quality review of national occurrence estimates, with the objective of improving the quality, reliability, and efficiency of the current approach. First, the various databases that support the occurrence estimates were mapped out in a diagram (see Figure 9). Process flow diagrams then were constructed for each data source to document the Six-Year Review data operations that supported the occurrence estimates. Mapping the Agency’s work processes through each phase of the review helped avoid duplication of work, identify quality check points, and ensure accountability to EPA managers for data collection, validation, and analysis efforts.

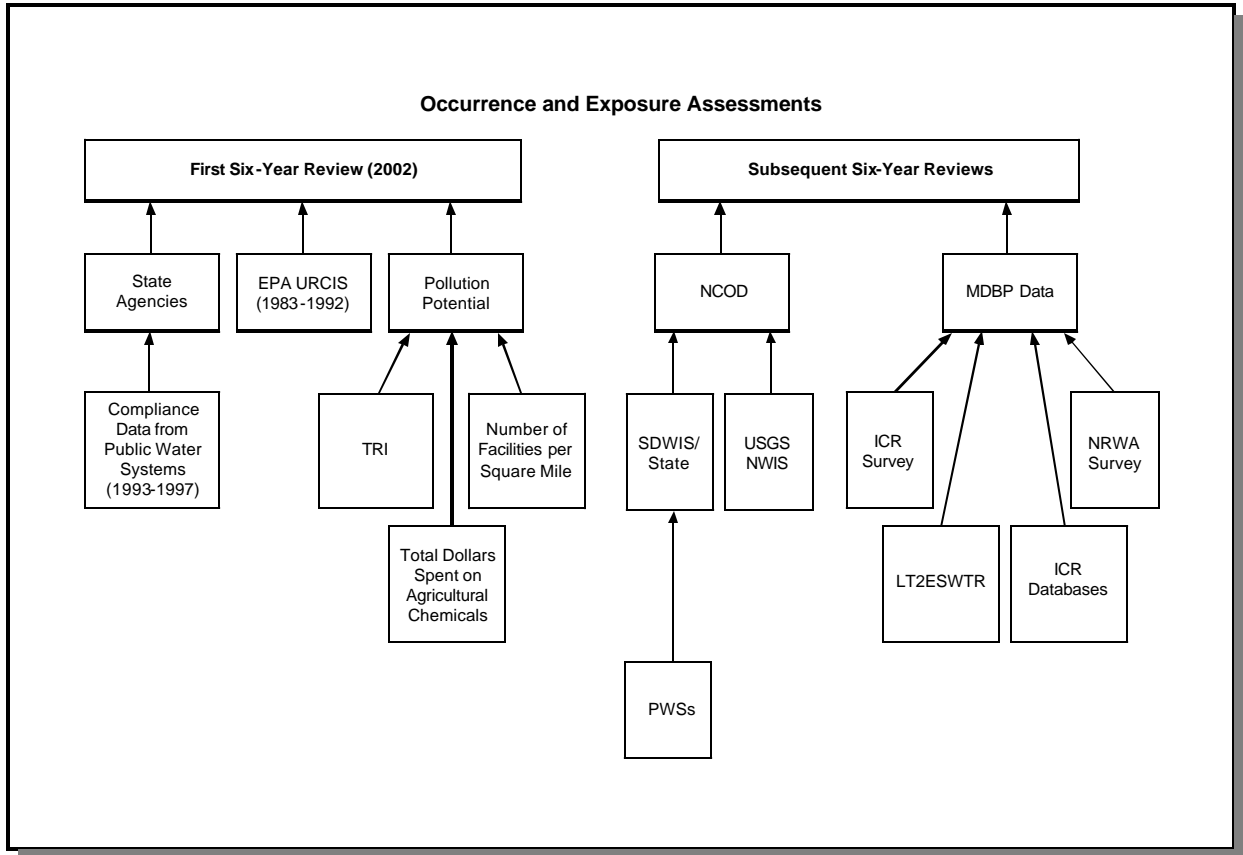

Figure 9. Data Sources for Occurrence and Exposure Assessments

CHAPTER 5

TOOLS AND METHODS USED IN DEVELOPING QUALITY SYSTEMS

This chapter will answer the following questions:

- c What is included in SOP templates?
- c What is included in an EPA Quality Management Plan?
- c What are document control and records management systems?
- c What elements are included in quality system compliance checklists?
- c What are some tools and methods used to analyze and improve work processes?

5.1 INTRODUCTION

This chapter describes a variety of tools and methods that can be useful when developing quality systems. This chapter discusses tools such as SOPs, quality manuals, document control and records management systems, quality system compliance checklists, and work process analysis and improvement tools. This list is not comprehensive, but it describes the tools and methods that are most used in quality systems. Many of these tools are also used in mature quality systems and originally were developed for QC applications, but they can also be used for evaluation and identifying problems during the development of the quality system. References for additional information and examples are included in the text.

5.2 STANDARD OPERATING PROCEDURES TEMPLATES

Standard operating procedures are an organization's written instructions that document a routine or repetitive activity. They detail the work processes within an organization to facilitate consistent conformance to technical and quality system requirements and to support data quality. EPA's *Guidance for the Preparation of Standard Operating Procedures for Quality-Related Documents (EPA QA/G-6)* (EPA, 2001b), suggests that SOPs contain the following elements:

- c title page,
- c table of contents,
- c control documentation,
- c procedural section (see below), and
- c reference section.

The procedural section of a technical SOP contains some or all of the following components:

- | | |
|--------------------------------------------------------|-------------------------------------------------|
| c Scope and applicability | c Sample handling and preservation |
| c Summary of method | c Sample preparation and analysis |
| c Definitions | c Troubleshooting |
| c Health and safety warnings | c Data acquisition, calculations, and reduction |
| c Cautions | c Computer hardware and software |
| c Interferences | c Data management and records management |
| c Personnel qualifications | c Quality control and quality assurance |
| c Equipment and supplies | |
| c Instrument or method calibration and standardization | |
| c Sample collection | |

For administrative SOPs, the procedural section may consist of:

- | | |
|-----------------------------------------|--------------------------------------------------|
| c Title | c Definitions |
| c Purpose | c Personnel, qualifications and responsibilities |
| c Applicability | c Procedure |
| c Summary of procedure | c Records management |
| c Quality control and quality assurance | |

The *Standard Guide for Documenting the Standard Operating Procedures Used for the Analysis of Water* (ASTM D 5172) (ASTM, 1999) notes that significant parts of the variability in results generated by different laboratories using the same methods are because of differences in the way the method is performed in each laboratory. Well-written and detailed SOPs provide increased confidence in a laboratory's ability to reproduce analytical conditions and generate reproducible results. Staff who use a procedure should be involved in the development of the SOP so that it becomes a thorough and precise document. An organization should maintain a master copy of their SOPs. When procedures are modified, the revision should be distributed to all appropriate staff, and staff should destroy the previous version. A master copy of out-of-date versions should be maintained, but separate from the master copy of the current SOPs. Staff should be periodically audited to monitor compliance with the SOPs that they follow. SOPs should include an effective date, revision number, page numbers out of the total number of pages, and the author. SOPs must be approved and signed by the appropriate staff.

5.3 QUALITY MANAGEMENT PLANS

Quality Management Plans (QMPs) are used for EPA organizations to document their quality systems. In *EPA Requirements for Quality Management Plans (QA/R-2)* (EPA, 2001a), the content

for QMPs is described. A QMP documents how an organization structures its quality system, and describes its quality policies and procedures. It outlines criteria for and areas of application, and describes its roles, responsibilities, and authorities. While the graded approach applies to QMPs, the following are the commonly used elements:

- c Management and organization,
- c Quality system components,
- c Personnel qualification and training,
- c Procurement of items and services,
- c Documents and records,
- c Computer hardware and software,
- c Planning,
- c Implementation of work processes,
- c Assessment and response, and
- c Quality improvement.

5.4 QUALITY MANUALS

Another approach is to develop a quality manual for documenting the quality system. Although EPA organizations can only use this approach in conjunction with EPA Manual 5360 (EPA, 2000a), it may be a viable approach for States, tribal governments, and contractors. According to ISO 9001, a quality manual includes:

- c the scope of the quality management system, including details and justification for any exclusions;
- c the documented procedures established for the quality management system or a reference to them; and
- c a description of the interaction between the processes of the quality management system.

The *Guidelines for Developing Quality Manuals* (ANSI/ISO/ASQ Q10013-1995) (ASQ, 1995), notes that a quality manual consists of the documented quality system procedures for the overall planning and administration of activities that have an impact on quality within an organization. A quality manual should accurately, completely, and concisely describe the quality policy, objectives, and governing documented procedures of an organization. A quality manual may be a compilation of quality system procedures or a series of procedures for specific applications, more than one document, a standalone document, or part of another document. Elements for consideration include:

C	Title, scope, and field of application	C	Description of the elements of the quality system and any references to documented quality system procedures
C	Table of contents	C	Definitions section
C	Introductory pages about the organization and manual	C	Guide to the quality manual
C	Quality policy and objectives of the organization	C	Appendix with supporting information
C	Description of the organizational structure, responsibilities, and authorities		

Below is a sample outline for a quality manual.

i.	Approvals
ii.	Revision and approval record
iii.	Introduction
1.	Quality management system
	• General requirements
	• Documentation requirements
2.	Management responsibility
	• Management commitment
	• Customer focus
	• Quality policy
	• Planning
	• Responsibility, authority, and communication
	• Management review
3.	Resource management
	• Provision of resources
	• Human resources
	• Infrastructure
	• Work environment
4.	Product realization
	• Planning
	• Customer-related processes
	• Design and development
	• Purchasing
	• Production and service provision
	• Control of monitoring and measuring devices
5.	Measurement, analysis, and improvement
	• General

- Monitoring and measurement
- Control of nonconforming product
- Analysis of data
- Improvement

5.5 DOCUMENT CONTROL AND RECORDS MANAGEMENT SYSTEMS

As outlined in 41 CFR 101-11, “Creation, Maintenance, and Use of Records,” to develop a records management system involves the five steps outlined below.

- Step 1: Assign specific responsibility for the development and implementation of the records management program to a qualified records manager.
- Step 2: Apply appropriate records management practices to all records, regardless of the medium (e.g., paper, electronic, or other).
- Step 3: Control the creation, maintenance, and use of records and the collection and dissemination of information to ensure that only necessary records are accumulated, that forms and reports used for collecting information are efficient and necessary, that all forms and reports are periodically reviewed, and that records are maintained cost effectively and in a manner that allows them to be retrieved quickly and reliably.
- Step 4: Strive to improve correspondence and design forms that are user friendly, and are easy to read, transmit, process, and retrieve.
- Step 5: Organize files so that records can be easily found to ensure that records are complete, and to facilitate the identification and retention of permanent records and the prompt disposal of temporary records.

For document control, ANSI/ASQ E4-1994 states that documents requiring control should be identified. Documents should be reviewed by qualified personnel for conformance with technical requirements and quality system requirements and approved for release by authorized personnel. Documents used to perform work, such as SOPs, should be kept current by personnel performing the work. Measures should be taken to ensure that users understand the documents. Obsolete documents should not be used and should be removed.

5.6 QUALITY SYSTEM COMPLIANCE CHECKLISTS

During development of the quality system, a quality system compliance checklist is a useful tool to check compliance with ANSI/ASQ E4. Part of an example checklist, based on ANSI/ASQ E4 and ISO 9001, can be found in Appendix A. A checklist of this type can be used to demonstrate strengths and weaknesses in the organization's existing quality system, identify the areas where the system is not compliant with ANSI/ASQ E4 or ISO 9001 standards, and clarify the key areas of focus as the quality system is improved or developed. The checklist can be updated and used to report progress in the development of the quality system.

5.7 PROCESS ANALYSIS AND IMPROVEMENT TOOLS

A variety of business process analysis and improvement tools are used when developing quality systems (Anderson, 1999; PQ Systems, Inc., 1996; Russell, 1997).

- Process Flow Charts
- Control Charts
- Cause-Effect (Fishbone) Diagrams
- Pareto Diagrams
- Benchmarking
- Scheduling Tools

5.7.1 Process Flow Charts

A process flow chart graphically displays the steps, decisions, and actions of any process. The chart includes key points, activities, and roles. For a new process, such as developing a quality system, it serves as a model or blueprint. During development of a quality system, process flow charts are particularly useful for the development activities in Phase 2 for analyzing work processes (see Section 3.3). Processes that could be charted include QA Project Plan reviews or corrective action requests to analyze where problems occur in existing systems. A process flow chart depicts a process sequence succinctly. Three types of process flow charts are outlined below.

1. A process outline—which is a first-cut chart for initial consideration.
2. A material flow process chart—records an object's movements to and from the operation, when it is inspected and tested, and when it is stored, delayed, and queued.
3. A worker process chart—records operations, inspection, transport, movement, and delays for a worker.

A process flow chart can aid in reviews and evaluations of an operation. Redundant operations and points of inspection can be easily identified in process flow charts. An example of a process flow chart is shown in Figure 10.

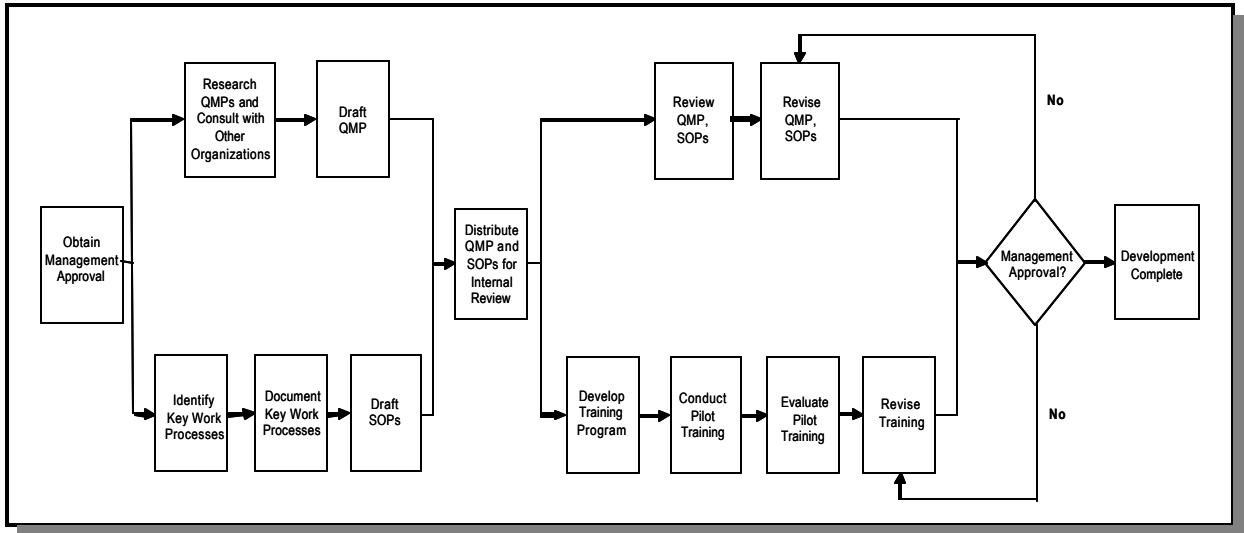

Figure 10. Example of a Process Flowchart

Deming (2000) advocated the use of process flow charts to help people identify how their work relates to others in the organization, both upstream and downstream from their own process. By viewing the work as a system with interdependent elements, staff are more likely to identify opportunities for improvement and see how they can optimize the overall system for peak performance, rather than maximizing the output of individual elements, perhaps at the expense of reduced overall performance.

5.7.2 Control Charts

Control charts provide an easy way to identify trends or instances when a control limit is exceeded. In the 1920s, Shewhart determined that the most economical way to identify when management should investigate a process and take corrective action was to use control charts as a basis for distinguishing between special causes and common causes of variation (Shewhart, 1986). During the development of a quality system, control charts can be used to track scheduling, for instance. Trends in processing permits or requests can also be tracked with control charts.

Control charts can be divided into means charts and range charts. The average and standard deviation are used to construct a means chart. The upper and lower warning levels are typically set at ± 2 standard deviations, and the upper and lower control levels are typically set at ± 3 standard

deviations. For a range chart, differences between two values are plotted so the base line for the chart is zero. Figure 11 shows a control chart of a process under control, which, therefore, does not warrant management intervention.

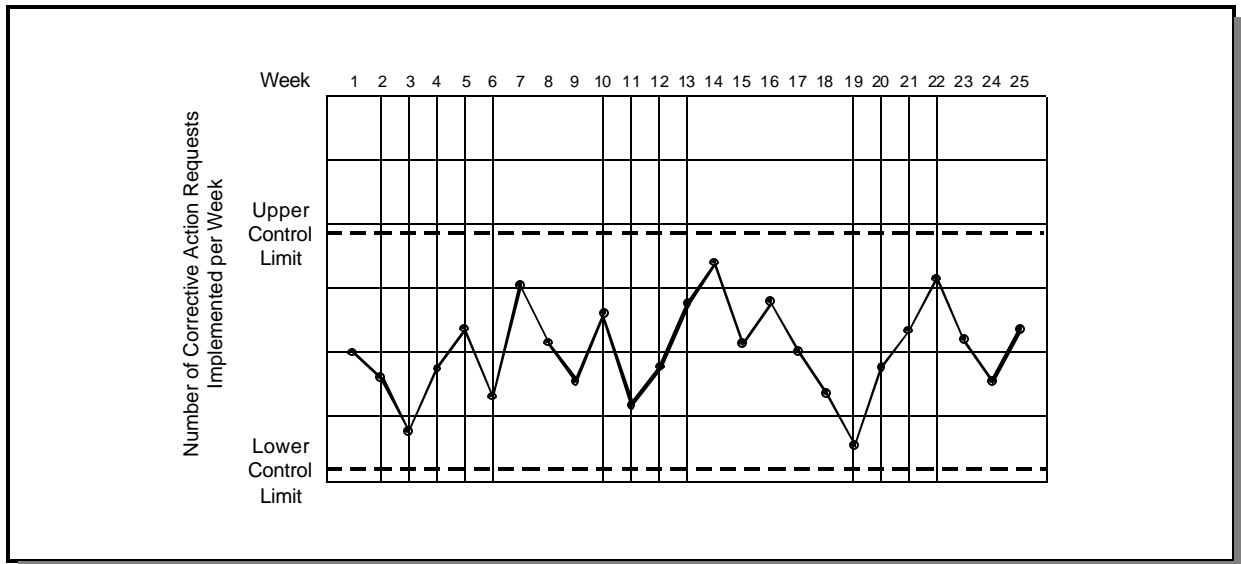

Figure 11. Control Chart Showing a Process Under Statistical Control

5.7.3 Cause-and-Effect (Fishbone) Diagrams

Cause-and-effect diagrams (Figure 12) are graphic tools used to explore and display opinions about sources of variation in a process. They are also called Ishikawa (after the inventor), root cause analysis, or fishbone diagrams. They may be used in the evaluation steps as the quality system is developed. Figure 12 shows a fishbone diagram can be used to discuss the overall problems with implementing a quality system. The basic problem of interest is entered at the right of the diagram at the end of the main backbone. The main possible causes of the problem and its effects are drawn as bones off the backbone. Materials, equipment, labor, and methods are the four categories often used to start the brainstorming about the possible causes. This is a visualization tool. Collecting ideas in a systematic way can aid in understanding and diagnosing the problem. An example fishbone diagram is shown in Figure 12, for more examples, see Oakland (2000); Beckford (1998); Goetsch and Davis (1994).

5.7.4 Pareto Charts

Pareto charts (Figure 13) are based on the Pareto principle that 20 percent of the sources (the vital few) cause 80 percent of the problems. They are bar charts that display the relative frequency of problems in a process or operation. They are used to determine priorities for quality improvement or development activities. Each bar represents the relative frequency of a problem. Data error flags, for

instance, could be used to generate the statistics for creating a Pareto chart. The bars are arranged in decreasing order. A Pareto chart can be used to decide which subset of problems should be solved first. It may also be used to show a before and after comparison of the effect of a quality improvement measure. More information on the use of Pareto charts can be found on the SAS web site.

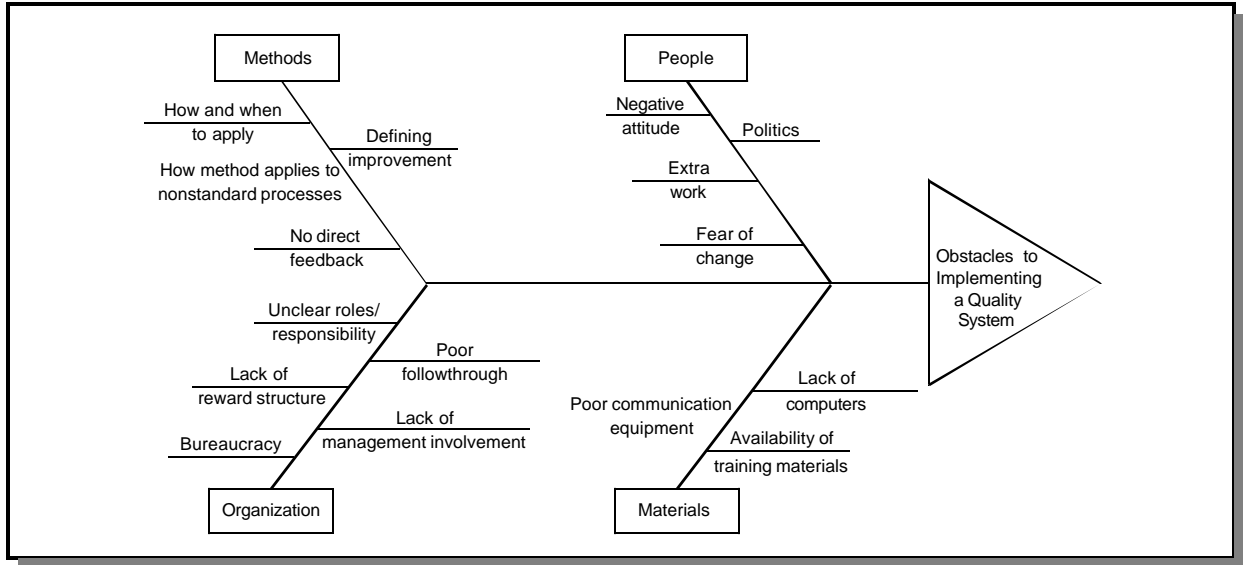

Figure 12. Example of a Cause-and-Effect (Fishbone) diagram)

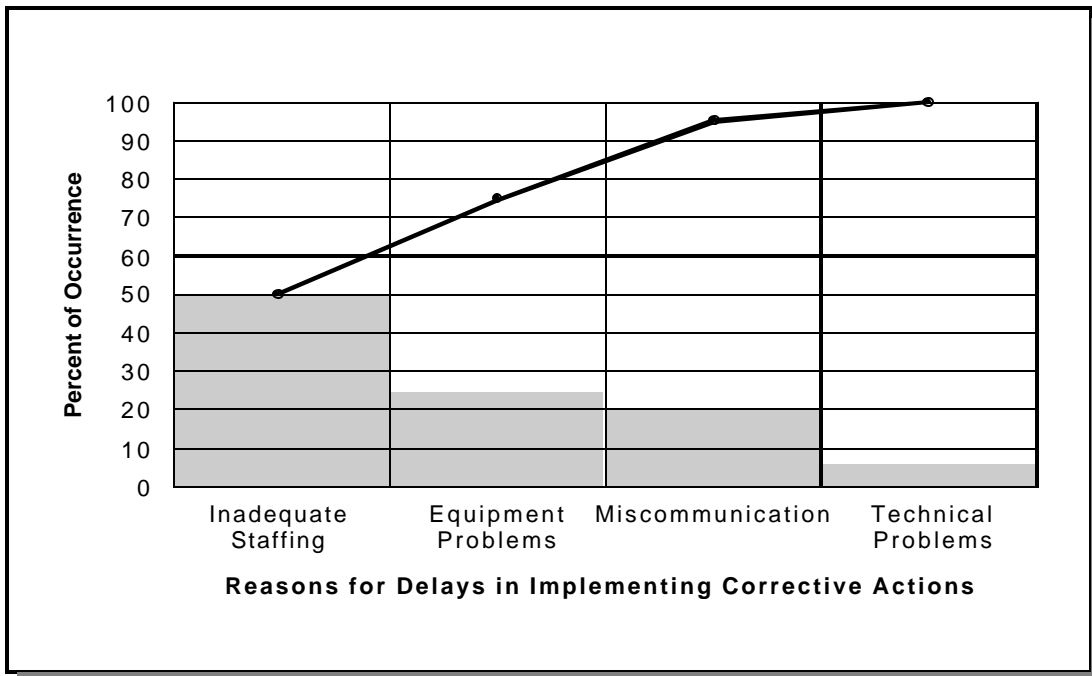

Figure 13. Example of a Pareto Chart

5.7.5 Benchmarking

Continual improvement (see Section 3.5.3) involving slow, incremental changes to a process is one method to enhance the quality and productivity of the process. Deming and other quality experts advocate the use of the iterative Shewart cycle of Plan-Do-Check-Act as the basis of a quality system. This approach assumes that gradual improvement is adequate and that an organization has sufficient commitment and innovation to continue the cycle effectively. However, stronger measures may be needed for organizations that have significant quality problems, for those that are stagnant or for those in which creativity is suppressed.

Benchmarking is the technique of comparing and measuring an organization's operations or its internal processes against those of a best-in-class performer from inside or outside its industry (Goetsch and Davis, 1997). Table 10 presents reasons for benchmarking as a function of organizational quality objectives (Oakland, 1993). Beckford (1998) writes that benchmarking is essentially an exercise in organizational humility. It demands that participants respect the idea that there may be other organizations that carry out a particular process more effectively than they do, rather than being complacent about how good they are. They then have to learn from these high-performance organizations.

The benchmarking technique is straightforward. Variations of the technique are possible, but the technique chosen should address the elements presented in the following 14-step sequence (Goetsch and Davis, 1997):

- Step 1: Obtain Management Commitment—Benchmarking requires a substantial investment of time and resources. The object of benchmarking is to discover processes to replace yours or at least to make major changes to them. Without a mandate from top management, there is no point in attempting to benchmark.
- Step 2: Document Your Organization's Processes as Baselines for Benchmarking—It is critical that you understand your organization's processes thoroughly before comparing them with another organization's. Most organizations think they know their processes well, but that is rarely the case if a deliberate process characterization has not been done. The benchmarking partner (selected in Step 7) will expect to learn about your organization's processes.
- Step 3: Identify Strong and Weak Processes—Strong processes should not be benchmarked initially. Weak processes become candidates for radical change through benchmarking, but other processes should remain open to change as well. If research identifies a better process, add it to the list.

- Step 4: Select Processes to be Benchmarked—When you have a good understanding of your own processes and the expectations of them, decide which ones to benchmark. An important point to remember: never benchmark a process that you do not wish to change.
- Step 5: Form Benchmarking Teams—The teams should include people who operate the process, those who supply the process, and those who are its customers. These people are in the best position to recognize the differences between the process and another organization's process. Every team should have management representation to build the support for change.
- Step 6: Research Best-In-Class Organizations—It is important to select a benchmarking partner from the best-in-class organizations that are willing to be a partner for the selected process. The same processes may be used by many different types of organizations, so do not limit the research only to similar organizations or opportunities for benchmarking may be missed.
- Step 7: Select Candidate Benchmarking Partners—When the best-in-class organizations have been identified, the team decides which ones to work with. The best benchmarking partnerships benefit both parties. If the team can find a way to benefit its potential partner, the linkage between the two organizations will be easier to achieve.
- Step 8: Form Agreements with Benchmarking Partners—After the team has selected a candidate, it contacts the person with the authority in that organization to discuss an agreement covering benchmarking activities. After contact has been made, the team should determine the organization's willingness to be a partner. The terms of any resulting agreement should include mutual visitation arrangements, confidentiality, and points of contact. Care must be taken to ensure that the benchmarking activities do not excessively disrupt the partner's normal operations.
- Step 9: Data Collection—The team visits the partner to observe, collect, and document everything about the process being benchmarked and to determine the underlying factors and processes that make the process best-in-class. Your organization's process operators should talk directly with their operators. Coming away with a good understanding of the benchmarked process is important, its antecedent and successor processes, its support requirements, timing, and control. The team should learn enough about the process to implement it on return to your organization.

- Step 10: Analyze the Benchmarking Data; Establish the Gap Between the Processes—The team should thoroughly compare the data for the benchmarked process with the data taken from your organization's process. The team should establish a quantitative value for the gap (the performance difference) between the two processes.
- Step 11: Plan Action to Close the Gap or Surpass—Implementation requires planning to minimize disruption while the change is being made and while the operators are getting trained and accustomed to the new process. It is important to approach implementation deliberately and with great care. Prepare for all conceivable contingencies. Only after thorough preparation and training should an organization implement the change to the new process. The second objective of benchmarking is to implement a process that is itself best-in-class. Your organization should surpass the performance of the benchmarked process. The planning should provide for the development work necessary to achieve this objective.
- Step 12: Implement the Change—Implementation should be easy if the planning has been thorough and if the execution adheres to the plan. The performance may not equal the benchmark until the new equipment, personnel, and procedures function on a routine basis. After the initial problems are solved, the performance should be close to the benchmark. If not, another visit to the partner may be necessary to determine what has been overlooked.
- Step 13: Monitor—After the process is running routinely, its performance should match and then surpass the benchmark. Constant attention in the form of monitoring is needed. Statistical process control can be used to monitor the performance of the new process.
- Step 14: Update Benchmarks; Continue the Cycle—Whether the benchmark is surpassed or not, the important thing is to maintain the goal of achieving best-in-class. Benchmarks must be updated periodically. Stay in touch with the partner. Continue the benchmarking process. Let continual improvement take over for the best processes, and concentrate the benchmarking on the ones that remain weak.

Table 10. Reasons for Benchmarking

Objectives	Without benchmarking	With benchmarking
Becoming competitive	Internal focus; evolutionary change	Understanding of competition; ideas from proven practices
Industry best practices	Few solutions; frantic catch-up activity	Many options; superior performance
Defining customer requirements	Based on history or gut feeling; perception	Market reality; objective evaluation
Establishing effective goals and objectives	Lacking external focus; reactive	Credible, unarguable; proactive
Developing true measures of productivity	Pursuing pet projects; strengths and weaknesses not understood; route of least resistance	Solving real problems; understanding outputs; based on industry best practices

5.7.6 Scheduling Tools

There are a variety of scheduling tools available, such as Program Evaluation and Review Technique (PERT), the critical path method (CPM), Gantt charts, and commercially-available software. These tools can help the team developing the quality system in keeping the development on schedule. An example schedule is presented below.

A Gantt chart graphically displays a list of tasks along a time line. Numbered tasks are listed sometimes with additional information, such as task duration (in days, weeks, or months), start date, end date, or other information. Tasks are depicted graphically to the right of the task list using a horizontal bar scaled to a calendar time line. Milestones are key events that have zero duration, and often represent the beginning or end of a set of related tasks. The logical sequencing of tasks also can be represented by linking the horizontal task bars using arrows, as shown in Figure 14. For example, in Figure 14 the task “Research QMP and consult with other organizations” must be completed before the task “Write first draft of QMP” can be started. The example also shows the schedule’s critical path, the sequence of tasks that do not have any spare time. A delay in any one task along the critical path will delay the project completion date. Gantt charts can be very effective in quickly communicating schedules because they are easy to understand if constructed properly. Many commercially available software packages use Gantt charts to display schedule data. The ability to analyze the critical path easily, explore potential impacts to changes, and update actual versus planned dates makes scheduling software packages very useful (see Oakland, 2000; Beckford, 1998).

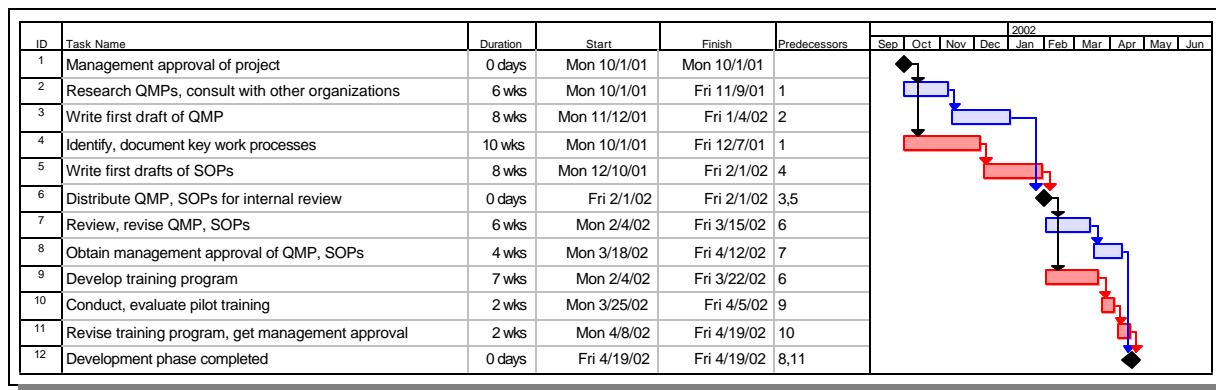

Figure 14. Project Gantt Chart Showing the Durations and Relationships Among Tasks, with the Critical Path Highlighted by Cross-Hatching

PERT is a statistical technique applied to a network schedule. A PERT chart for the early activities of the project shown in the Gantt chart is shown in Figure 15. A PERT chart reduces the overall project time by showing the tasks that can be performed simultaneously, and reducing delays between items performed sequentially. A PERT chart shows project activities and their interrelations and shows the sequence of dependencies between activities. It is used to determine the minimum time needed to complete a project, phase, or task, such as developing a quality system. The four steps are:

1. Identify tasks,
2. Determine the proper sequence of tasks,
3. Estimate the time required to perform each task, and
4. Prepare a time-scaled chart of tasks and events to determine the critical path.

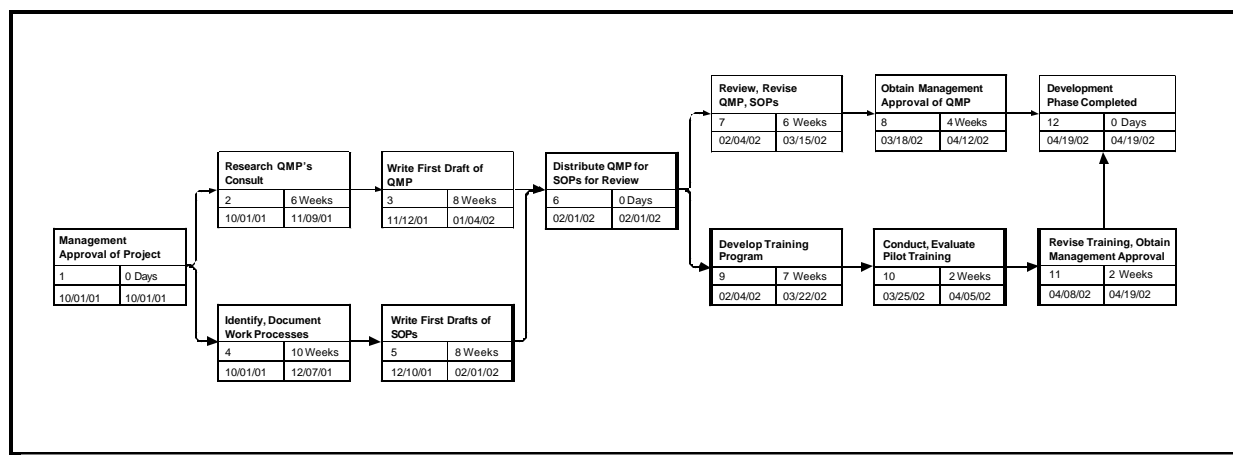

Figure 15. PERT Chart Showing Early Tasks of Projects Critical Path in Bold

The critical path method is a technique for project planning. It can be used to determine how long it will take to finish a project, such as developing a quality system, and which activities are critical to finishing the project on time. Cost information can be added to help determine the optimal plan for speeding up the project. For each activity, the following items should be known:

- the projected time required to complete the activity;
- those activities that need to be completed before another one can start;
- the cost to complete (optional);
- a shorter time to complete on a crash basis (optional); and
- a higher cost to complete on a crash basis (optional).

A diagram is completed showing the sequential order of activities. The critical path is the one that takes the longest. This tells you which activities need to be done on time to finish the project in the least time.

Summary

A variety of tools and methods can be used to develop quality systems and implement quality improvements in EPA work processes, including business process improvement charts, control charts, fishbone diagrams, critical path methods, PERT charts, etc.

Standard operating procedures are sets of written instructions that document a routine or repetitive activity followed by an organization. QMPs satisfy an EPA requirement to document how an organization structures its quality system, describe its quality policies and procedures, and explain roles and responsibilities of the quality staff. Document control and records management systems assign responsibilities and practices for information collection. They ensure that unnecessary records are not created and that project data are stored efficiently and cost effectively. Quality system checklists detail the required elements of management systems, organizational responsibilities, EPA quality policy, design and development of quality systems, personnel training and qualifications, etc.

APPENDIX A

QUALITY SYSTEM CHECKLIST

Standard References		Description/Assessment Questions	Reference	Accepted	Needs Work	Comment
E4	ISO 9001					
PART 2 MANAGEMENT SYSTEMS						
2.1	4.1	MANAGEMENT AND ORGANIZATION				
2.1.a, 2.1.d	4.1.1	<i>Quality Policy</i>				
2.1.a, 2.1.d	4.1.1	Are company policies, objectives, and its commitment to quality documented?				
2.1.a, 2.1.d	4.1.1	Are these documents controlled? <i>See Document and Data Control (4.5).</i>				
2.1.a, 2.1.d	4.1.1	Are the policies understood, implemented, and maintained at all levels of the organization?				
2.1.a, 2.1.d	4.1.1	Does the quality system define what constitutes executive responsibility?				
2.1.a, 2.1.d	4.1.1	Is the stated quality policy relevant to internal organization goals and customer needs/expectations?				
2.1.b, 2.1.g	4.1.2	<i>Organization</i>				
2.1.b, 2.1.g	4.1.2.1	<i>Responsibility and Authority</i>				
2.1.b, 2.1.g	4.1.2.1	Is sufficient responsibility and authority assigned to personnel for the effective resolution of problems related to the quality of process(es), quality system, and the product/service?				

Standard References		Description/Assessment Questions	Reference	Accepted	Needs Work	Comment
E4	ISO 9001					
2.1.b, 2.1.g	4.1.2.1	Are the organizational structure, responsibilities, and authority of management personnel documented (e.g., organization chart, job descriptions, etc.)?				
2.1.b, 2.1.g	4.1.2.1	Is the organizational structure, responsibility and authority of all personnel related to product, process, and quality system activities documented?				
2.1.c		Has management identified both internal and external customers for the work to be performed and the suppliers of items or services?				
2.1.e		Do policies exist for management to negotiate acceptable measures of quality and success when constraints of time, cost, or other problems affect the supplier's ability to fully satisfy the customer's prestated needs and expectations? Does management have the appropriate authority to do so?				
2.1.f		Is appropriate training and outreach in place so as to ensure that applicable elements of the E4 standard are understood and are implemented in environmental programs defined by the E4 standard and under their responsibility?				
2.1.h	4.10.4	Are all OSHA and other relevant safety rules and certifications current and being followed? Is documentation of such rules/certification accessible to employees? Is the responsibility for stopping unsafe work practices specified in these rules or in another central location?				
2.1.i	4.1.2.3	<i>Management Representative</i>				

Standard References						
E4	ISO 9001	Description/Assessment Questions	Reference	Accepted	Needs Work	Comment
2.1.i	4.1.2.3	Has an ISO 9000 management representative been appointed? Underwriters Laboratory's ISO program also requires an alternate to be appointed; therefore has an alternate management representative also been appointed?				
2.1.i	4.1.2.3	Are reports issued by this management representative used for improvement of the quality system?				
2.1.j	4.1.3	<i>Management Review</i>				
2.1.j	4.1.3	Does executive management periodically review and approve all aspects of the quality system to ensure its continuing suitability and effectiveness in satisfying the requirements of the selected ISO 9000 Standard and the company quality policy objectives?				
2.1.j	4.1.3	Does the documentation define an executive management review process, including by whom reviews are conducted?				
2.1.j	4.1.3	Are records maintained of management reviews? See <i>Control of Quality Records</i> (4.16).				
2.1.k	4.2	QUALITY SYSTEM				
2.1.k	4.2.1	<i>General</i>				
2.1.k	4.2.1	Are written procedures and work instructions in place to control all activities affecting product/service quality?				
2.1.k	4.2.1	Have all processes affecting product/service quality been identified and controlled?				
2.1.k	4.2.1	Do procedures exist to identify the method of ensuring that all aspects of the system comply with the applicable standard?				

Standard References		Description/Assessment Questions	Reference	Accepted	Needs Work	Comment
E4	ISO 9001					
2.1.k	4.2.1	Does the quality manual outline the documentation structure used in the quality system?				
2.1.k	4.2.1	Are the response actions required as a result of independent assessments or self-assessments of the quality system documented? Is there a process in place for documenting a schedule for implementation of corrective actions?				
	4.1.2.2	<i>Resources</i>				
	4.1.2.2	Have trained personnel been assigned for management, performance of work, verification activities, and internal quality audits? <i>See Training (4.18).</i>				
2.2		QUALITY SYSTEM OVERVIEW				
2.2.b		(a) Is there an organizational chart with designated responsibilities available and easily accessible by <u>all</u> employees? (b) Is there a quality system diagram available and easily accessible by all employees? (c) Are all the policies, procedures, and guidance documents dictating quality work and management procedures easily accessible by all employees? (d) Are the resources made available for implementation of the quality system documented (including training) on a periodic basis (annually) and easily accessible by relevant staff?				

Standard References						
E4	ISO 9001	Description/Assessment Questions	Reference	Accepted	Needs Work	Comment
2.2.d	4.4.2	<i>Design and Development Planning</i>				
2.2.d	4.4.2	Are plans drawn up to identify the responsibility of each design and development activity?				
2.2.d	4.4.2	Are these plans reviewed and updated as the design evolves?				
2.2.d	4.4.2	Are personnel involved in design verification provided with the necessary resources?				
2.2.d	4.4.2	Are responsibilities defined in design activity plans?				
2.2.e		Has a quality manual been generated and approved for the current period of applicability (annually)?				
2.2.g		Does the quality system in the Project Manual description identify in general terms those items, programs, or activities to which it applies?				
2.2.h		Does the quality system description identify and document activities that directly or indirectly affect quality including: <ul style="list-style-type: none"> C general and specific responsibilities for management and staff; and C responsibilities and authorities for technical activities. 				
2.2.i	4.1.2.3	Is it established that at regular intervals, and at least annually, the quality system shall be reviewed and its description updated to reflect physical changes in the organization as well as changes in ETV quality policy?				
2.3	4.18	PERSONNEL TRAINING AND QUALIFICATIONS				

Standard References		Description/Assessment Questions	Reference	Accepted	Needs Work	Comment
E4	ISO 9001					
2.3.a, 2.3.b, 2.3.d, 2.3.e	4.18	Have documented procedures been established to identify training needs for all personnel performing activities affecting quality?				

APPENDIX B

REFERENCES

- 21 CFR 50, 56, and 312. Code of Federal Regulations. *Good Clinical Practices*.
- 21 CFR 210, 211, and 280. Code of Federal Regulations. *Good Manufacturing Practices*.
- 40 CFR 30. Code of Federal Regulations. *Grants and Agreements with Institutions of Higher Education, Hospitals, and Other Non-profit Organizations*.
- 40 CFR 31. Code of Federal Regulations. *Uniform Administrative Requirements for Grants and Cooperative Agreement to State and Local Governments*.
- 40 CFR 35. Code of Federal Regulations. *State and Local Assistance*.
- 40 CFR 160 and 792. Code of Federal Regulations. *Good Laboratory Practices*.
- 41 CFR 101. Code of Federal Regulations. *Public Contracts and Property Management: Federal Property Management Regulations*.
- 48 CFR 46. Code of Federal Regulations. *Federal Acquisition Regulations System, Quality Assurance*.
- American National Standards Institute/American Society for Quality (ANSI/ASQ). (1995) *Specifications and Guidelines for Quality Systems for Environmental Data Collection and Environmental Technology Programs (E4-1994)*. American National Standard.
- American Society for Quality (ASQ). (1995) *Guidelines for Developing Quality Manuals (ANSI/ISO/ASQ Q10013-1995)*.
- American Society for Testing and Materials (ASTM). (1999) *Standard Guide for Documenting the Standard Operating Procedures Used for the Analysis of Water (ASTM D 5172)*.
- Anderson, B. (1999). *Business Improvement Toolbox*. Milwaukee, WI: ASQ Quality Press.
- Beckford. (1998). *Quality: A Critical Introduction*. New York: Routledge.
- Brown, M.G., Hitchcock, D.E., and Willard, M.L. (1994). *Why TQM Fails and What to do about It*. New York: McGraw-Hill.

- Carr, D.K. and Littman, I.D. (1990). *Excellence in Government. Total Quality Management in the 1990s (Second Edition)*. Arlington, VA: Coopers & Lybrand.
- Crosby, P.B. (1979). *Quality is Free*. New York: McGraw-Hill.
- Deming, W.E. (2000). *Out of the Crisis*. Cambridge, MA: MIT Press.
- Dobyns, L. and Crawford-Mason, C. (1991). *Quality or Else*. Boston: Houghton-Mifflin.
- Flood, R.L. (1993). *Beyond TQM*. New York: John Wiley & Sons.
- Goetsch, D.L. and Davis, S. (1995). *Implementing Total Quality*. Englewood Cliffs, NJ: Prentice-Hall.
- Goetsch, D.L. and Davis, S. (1997). *Introduction to Total Quality*. Upper Saddle River, NJ: Prentice-Hall.
- Goetsch, D.L. and Davis, S. (2001). *Total Quality Handbook*. Upper Saddle River, NJ: Prentice-Hall.
- Hunt, V.D. (1993). *Quality Management for Government*. Milwaukee: American Society for Quality (ASQ) Quality Press.
- International Organization for Standardization (ISO). (1999). *ISO/IEC 17025:1999, General Requirements for the Competence of Testing and Calibration Laboratories*. Geneva: ISO.
- International Organization for Standardization (ISO). (2000a). *ISO 9001:2000, Quality Management Systems—Requirements*. Geneva: ISO.
- International Organization for Standardization (ISO). (2000b). *Quality Management Principles*. ISO, Geneva, Switzerland. Available: www.iso.ch/iso/en/iso9000-14000/iso9000/qmp.html.
- Juran, J.N. (1977). That Uninterested Top Management. Selected Papers, No. 20, The Juran Institute, Wilton, CT. Available: www.juran.com/research/articles/SP7720.html.
- Juran, J.M. (1999). The Quality Improvement Process. In: *Juran's Quality Handbook, Fifth Edition*, Juran, J.M. and Godfrey, A.B., eds. New York: McGraw-Hill.
- Koehler, J.W. and Pankowski, J.M. (1996). *Quality Government: Designing, Developing, and Implementing TQM*. Delray Beach, FL: St. Lucie Press.

- Larson, M. (1999) . Whatever Happened to TQM? *Quality* 38:7. Available: www.qualitymag.com.
- Maine, J. (1994). *Quality Wars. The Triumphs and Defeats of American Business*. New York: Free Press.
- National Institute of Standards and Technology. (1993). *Integration Definition for Function Modeling (IDEF0)*, Federal Information Processing Standards Publication 183.
- Oakland, J.S. (1993). *Total Quality Management, (Second Edition)*. Boston: Butterworth-Heinemann.
- Oakland, J.S. (2000). *Total Quality Management. Text with Cases (Second Edition)*. Boston: Butterworth-Heinemann.
- PQ Systems, Inc. (1996). *Total Quality Tools*, 1st printing, version 2. Dayton, OH: PQ Systems.
- Russell, J.P. (ed.). (1997). *The Quality Audit Handbook*. Milwaukee, WI: ASQ Quality Press.
- Schuler, R.S. and Harris, D.L. (1992). *Managing Quality: The Primer for Middle Managers*. Reading, MA: Addison-Wesley Publishing Company, Inc.
- Senge, P.M. (1990). *The Fifth Discipline: The Art and Practice of the Learning Organization*. New York: Doubleday.
- Shewhart, W.A. and Deming, W.E. (1986). *Statistical Method from the Viewpoint of Quality Control*. New York: Dover.
- U.S. Environmental Protection Agency. (2000a). *EPA Quality Manual for Environmental Programs (EPA 5360 A1)*. Washington, DC.
- U.S. Environmental Protection Agency. (2000b). *Policy and Program Requirements for the Mandatory Agency-wide Quality System (EPA Order 5360.1 A2)*. Washington, DC.
- U.S. Environmental Protection Agency. (2000c). *Guidance for Developing a Training Program for Quality Systems (QA/G-10) (EPA/240/B-00/004)*. Washington, DC.
- U.S. Environmental Protection Agency. (2001a). *EPA Requirements for Quality Management Plans (QA/R-2) (EPA/240/B-01/002)*. Washington, DC.

U.S. Environmental Protection Agency. (2001b). *Guidance for Preparing Standard Operating Procedures (EPA QA/G-6)* (EPA/240/B-01/004). Washington, DC.

U.S. Environmental Protection Agency. (2001c). *Guidance on Assessing Quality Systems (EPA QA/G-3)* (Peer Review Draft). Washington, DC.

U.S. Environmental Protection Agency. (2002). *Overview of the EPA Quality System for Environmental Data and Technology* (EPA/240/R-02/003). Washington, DC.

Wieringa, D., Moore, C. and Barnes, V. (1998). *Procedure Writing. Principles and Practices (Second Edition)*. Columbus, OH: Battelle Press.

SUGGESTED READING

Bendell, T. (1998). *The Quality Gurus*. British Department of Trade and Industry. Available: www.dti.gov.uk/mbp/bpgt/m9ja00001/m9ja000011.html.

—*This document provides a comparative insight into the philosophies and tools of the major quality gurus (e.g., Deming, Crosby, and Juran). It outlines each guru's history, main areas of work, the unique aspects of his message, and what benefits might be extracted by following the philosophy and using the tools.*

Deming, W.E. (2000). *Out of the Crisis*. Cambridge, MA: MIT Press.

—*W. Edwards Deming was one of the original quality gurus and introduced Japanese industry to quality concepts in 1946. This book offers a theory of management based on his 14 points for management. It explains principles of management transformation that establish quality, productivity, and competitive position.*

Mortiboys, R. and Oakland, J. (1997). *Total Quality Management and Effective Leadership*. British Department of Trade and Industry. Available:

www.dti.gov.uk/mbp/bpgt/m9ja91001/m9ja910011.html.

—*“This document helps senior managers focus on the nature and scale of leadership and quality challenge. It discusses the need to shift emphasis away from controlling people and towards developing management styles based on sound common sense and quality. It shows how TQM can be applied to improve the effectiveness, flexibility and competitiveness of a business as a whole”* (—Quoted from the title page).

Oakland, J. and Morris, P. (1998). *Pocket Guide to TQM. A Pictorial Guide for Managers*. Boston: Butterworth-Heinemann.

—*Discussions of quality can get pretty abstract quickly. Oakland and Morris have presented this very complex topic in terms that most people can understand. The abundant*

graphics explain as much about quality as does the clear text. This 90-page book serves as a good starting point for understanding how quality concepts and tools can be applied in everyday workplaces. If necessary, one could then read other books for more detailed information about quality systems.

U.S. Office of Personnel Management. (1993). *Self-Assessment Guide for Organizational Performance and Customer Satisfaction: Based on the Presidential Award for Quality Criteria* (GPO 006-000-01397-0). Washington, DC: Government Printing Office.

—This document provides guidance and instructions for conducting an organizational self-assessment. It is designed to help organizations evaluate their quality management efforts and measure progress. It is appropriate for use in an organization that is well into the implementation phase of a quality system.

U.S. Office of Personnel Management. (1991). *How to Get Started: Implementing Total Quality Management* (GPO No. 006-000-01355-5). Washington, DC: Government Printing Office.

—This booklet is one of a series that offers practical assistance to executives, managers, and employees in applying total quality management principles. It is intended primarily for someone who has a basic understanding of the principles and has at least a tentative commitment to them.

APPENDIX C

GLOSSARY OF QUALITY ASSURANCE CONCEPTS

Continuous Improvement

The organization and its environment are constantly changing and evolving. Consequently, processes that were optimized under a particular set of conditions at one time will eventually degrade unless an effort is made to reexamine the process and make improvements. This illustrates why continuous improvement is an important principle that drives the quality cycle of planning, implementation, assessment, and decision making (also called the “Shewart cycle” of plan, do, check, act).

Customer Focus

Quality itself is largely defined by the customer of a product or service, hence an organization developing a quality system should maintain a focus on the explicit and implicit requirements and expectations of its customers. The organization should clearly understand who its customers are, strive to understand the many facets of their customers’ needs, and stay alert to how those needs are changing over time. Mechanisms for collecting information about customer satisfaction may be a new but important part of quality system development for many environmental organizations.

Graded Approach

The graded approach describes the idea that the level of intensity and rigor devoted to a quality effort should be commensurate with the scope and risks associated with the process. In essence, if the consequences of failure are small, then relatively little is at stake and less effort and resources should be spent on quality assurance and quality control. On the other hand, if a core business process is under consideration and the consequences of poor quality are great (such as loss of highly valuable work or severe damage to the organization’s reputation), then a systematic and rigorous quality system may be needed to assure that the risk of failure is acceptably low. Adherence to the graded approach helps ensure that the quality system is cost effective and valuable to the organization.

Leadership and Management Commitment

Development of a quality system involves organizational change. Effective organizational change requires leadership and commitment from top management to influence positive changes in behavior, minimize fear of and resistance to change, and invest the resources necessary to help people learn new methods and procedures. Organizational change is a challenging endeavor that often requires shifts in organizational culture. Such change is more likely to take hold and have lasting value if the

organization's leaders are committed to the success of the quality system and support its implementation through consistent words and actions.

Measurement and Management by Fact

Quality management relies on objective measurement to assess performance in relation to goals. One of the most challenging aspects of quality system development can be the determination of appropriate quality measures, particularly for processes that deliver services. When done correctly, measurement provides objective information about how well the organization is performing, which provides a more transparent and defensible basis for management decision making.

Staff participation and teamwork

Given that the quality system should be based on a deep understanding of the organization's processes, it follows that the staff who perform those processes should be involved in quality system development. The people who perform the process tasks are usually the ones who understand best the process strengths, weaknesses, and opportunities for improvement. A team approach to quality system development increases the flow of information and sharing of knowledge.

Systems Thinking

Organizations are systems that must be understood as a set of interdependent elements that make up a whole. For example, the work of an organization involved in environmental data operations and decision making encompasses complex processes that transform inputs such as information, energy, and materials into outputs such as measurement data, reports, and decisions. These processes work within a complex environment of customers, suppliers, and numerous stakeholders, and involve feedback loops and time lags. According to systems theory, the properties and behavior of a system cannot be understood by merely analyzing the component parts; one must observe the emergent characteristics that arise from the complex interactions among the system's elements and its environment. It follows that if one wants to change a complex system like an organization successfully, one must use "systems thinking." Systems thinking is a conceptual framework and a set of tools that help make clear the patterns that emerge in complex systems, and how to make effective changes in a system (Senge 1990). Systems thinking focuses on how the dynamics of an organization's processes are determined largely by the system's structure. To increase the likelihood of improving system performance reliably over time, and to avoid unintended consequences, an organization should seek to understand the structure and dynamics of various reinforcing feedback loops, countervailing forces, implicit goals, and time lags at work in the organization.

APPENDIX D

GLOSSARY OF TERMS

acceptance criteria — specific limits placed on the characteristic of an item, process, or service defined in requirements documents.

certification — the process of testing and evaluation against specifications designed to document, verify, and recognize the competence of a person, organization, or other entity to perform a function or service, usually for a specified time.

configuration — the functional, physical, and procedural characteristics of an item, experiment, or document.

conformance — an affirmative indication or judgment that a product or service has met the requirements of the relevant specification, contract, or regulation; also, the state of meeting the requirements.

consensus standard — a standard established by a group representing a cross section of a particular industry or trade, or a part thereof, such as the ISO-9000 series, or the *ANSI/ASQ National Standard--Guidelines for Developing Quality Manuals..*

data quality objectives — qualitative and quantitative statements derived from the outputs of the first six steps of the DQO process that clarify the study objective, define the most appropriate type of data to collect, determine the most appropriate conditions from which to collect the data, and specify tolerable limits on decision errors which will be used as the basis for establishing the quantity and quality of data needed to support the decision.

data quality objectives process — a seven-step systematic planning process developed by EPA which provides a procedure for defining the criteria that a data collection design should satisfy, including when to collect samples, where to collect samples, tolerable level of decision errors, and how many samples to collect.

defensible — the ability to withstand any reasonable challenge related to the veracity or integrity of project and laboratory documents and derived data.

deficiency — an unauthorized deviation from acceptable procedures or practices, or a defect in an item.

demonstrated capability — the capability to meet a procurement’s technical and quality specifications through evidence presented by the supplier to substantiate its claims and in a manner defined by the customer.

design — the specifications, drawings, design criteria, and performance requirements. Also, the result of deliberate planning, analysis, mathematical manipulations, and design processes.

design change — any revision or alteration of the technical requirements defined by approved and issued design output documents and approved and issued changes thereto.

design review — a documented evaluation by a team, including personnel, such as the responsible designers, the client for whom the work or product is being designed, and a quality assurance (QA) representative, but excluding the original designers, to determine if a proposed design will meet the established design criteria and perform as expected when implemented.

environmental data — any measurements or information that describe environmental processes, location, or conditions; ecological or health effects consequences; or the performance of environmental technologies. For EPA, environmental data include information collected directly from measurements, produced from models, and compiled from other sources such as databases or the literature.

environmental processes — manufacturing or natural processes that produce discharges to or impact the ambient environment.

environmental programs — work or activities including, but not limited to characterization of environmental processes and conditions; environmental monitoring; environmental research and development; the design or construction of environmental technologies; and laboratory operations on environmental samples.

environmental technology — an all-inclusive term to describe pollution control devices and systems, waste treatment processes and storage facilities, and site remediation technologies and their components that may be utilized to remove pollutants or contaminants from, or prevent them from entering the environment. Examples include wet scrubbers (air), soil washing (soils), granulated activated carbon (water), and filtration (air, water). Usually this term applies to hardware-based systems; however, it can also apply to methods or techniques used for pollution prevention, reduction, or containment to prevent further movement of the contaminants, such as capping, solidification, vitrification, and biological treatment.

financial assistance — the process by which funds are provided by one organization (usually governmental) to another organization for the purpose of performing work or furnishing services or

items. Financial assistance mechanisms include grants, cooperative agreements, and governmental interagency agreements.

finding — an assessment conclusion that identifies a condition having a significant effect on an item or activity. An assessment finding may be positive or negative, and is normally accompanied by specific examples of the observed condition.

grade — the category or rank given to entities having the same functional use but different requirements for quality.

graded approach — the process of basing the level of application of managerial controls applied to an item or work according to the intended use of the results and the degree of confidence needed in the quality of the results.

guidance — a suggested practice that is not mandatory, intended as an aid or example in complying with a standard or requirement.

guideline — a suggested practice that is not mandatory in programs intended to comply with a standard.

independent assessment — an assessment performed by a qualified individual, group, or organization that is not a part of the organization directly performing and accountable for the work being assessed.

inspection — the examination or measurement of an item or activity to verify conformance to specific requirements.

locational data — latitude/longitude coordinates and other geographic information collected and documented with environmental and related data. This is in addition to, and not precluding, other critical location identification data that may be needed to satisfy individual program or project needs, such as depth, street address, elevation, or altitude.

management system — a structured, nontechnical system describing the policies, objectives, principles, organizational authority, responsibilities, accountability, and implementation plan of an organization for conducting work and producing items and services.

management systems review — the qualitative assessment of a data collection operation and/or organization(s) to establish whether the prevailing quality management structure, policies, practices, and procedures are adequate for ensuring that the type and quality of data needed are obtained.

manager— a member of an organization whose job involves directing work that is performed by others. Managers can be subdivided into:

- C senior manager—strategic decision makers, developers of policy (e.g., agency director, research laboratory director, city manager)
- C middle manager—tactical decision makers, implementors of policy (e.g., office and department heads, branch chief, foreman)
- C operational supervisor—on-the-spot decision makers, immediately responsible for the work of non-management staff members (e.g., section supervisors, team leader)
- C quality manager—technical staff member principally responsible for oversight and implementation of the quality system within an organization.

measurement and testing equipment — tools, gauges, instruments, sampling devices, or systems used to calibrate, measure, test, or inspect in order to control or acquire data to verify conformance to specified requirements.

measurement protocol — a specified procedure for making observations or performing analyses to determine the characteristics of interest for each sampling unit. Measurement protocols include the procedures for collecting a physical sample, handling and preparing the physical sample, and applying an analytical method to obtain a result.

method — a body of procedures and techniques for performing an activity (e.g., sampling, chemical analysis, quantification), systematically presented in the order in which they are to be executed.

mission statement — a short and clear expression of an organization's core principles.

nonconformance — a deficiency in a characteristic, documentation, or procedure that renders the quality of an item or activity unacceptable or indeterminate; nonfulfillment of a specified requirement.

objective evidence — documented statement of fact, other information, or record, either quantitative or qualitative, pertaining to the quality of an item or activity, based on observations, measurements, or tests that can be verified.

observation — an assessment conclusion that identifies a condition (either positive or negative) that does not represent a significant impact on an item or activity. An observation may identify a condition that has not yet caused a degradation of quality.

organization structure — the responsibilities, authorities, and relationships, arranged in a pattern, through which an organization performs its functions.

peer review — a documented critical review of work generally beyond the state of the art or characterized by the existence of potential uncertainty, conducted by qualified individuals (or an organization) who are independent of those who performed the work but collectively equivalent in technical expertise (i.e., peers) to those who performed the original work. Peer reviews are conducted to ensure that activities are technically adequate, competently performed, properly documented, and satisfy established technical and quality requirements. Peer reviews are an in-depth assessment of the assumptions, calculations, extrapolations, alternate interpretations, methodology, acceptance criteria, and conclusions pertaining to specific work and of the documentation that supports them. Peer reviews provide an evaluation of a subject where quantitative methods of analysis or measures of success are unavailable or undefined, such as in research and development.

procedure — a specified way to perform an activity.

process — a set of interrelated resources and activities that transforms inputs into outputs. Examples of processes include analysis, design, data collection, operation, fabrication, and calculation. The transformation of inputs produces a value-added product or service, and the value of each step of a process can be determined by how much it contributes to meeting customer expectations. Process mapping, brainstorming, morphological analysis, and other examination techniques are commonly used to analyze work processes in the pursuit of quality.

project — an organized set of activities within a program.

quality — the totality of features and characteristics of a product or service that bears on its ability to meet the stated or implied needs and expectations of the user.

quality assurance — an integrated system of management activities involving planning, implementation, assessment, reporting, and quality improvement to ensure that a process, item, or service is of the type and quality needed and expected by the client.

quality assurance program description/plan — see Quality Management Plan.

quality assurance project plan — a formal document describing in comprehensive detail the necessary quality assurance, quality control, and other technical activities that must be implemented to ensure that the results of the work performed will satisfy the stated performance criteria. The QA Project Plan components are divided into four classes: (1) Project Management, (2) Measurement/Data Acquisition, (3) Assessment/Oversight, and (4) Data Validation and Usability.

Requirements for preparing QA Project Plans can be found in *EPA Requirements for Quality Assurance Project Plans (EPA QA/R-5)*.

quality control — the overall system of technical activities that measures the attributes and performance of a process, item, or service against defined standards to verify that they meet the stated requirements established by the customer; operational techniques and activities that are used to fulfill requirements for quality. The system of activities and checks used to ensure that measurement systems are maintained within prescribed limits, providing protection against “out of control” conditions and ensuring the results are of acceptable quality.

quality control sample — an uncontaminated sample matrix spiked with known amounts of analytes from a source independent of the calibration standards.

quality management plan — a document that describes a quality system in terms of the organizational structure, policy and procedures, functional responsibilities of management and staff, lines of authority, and required interfaces for those planning, implementing, documenting, and assessing all activities conducted.

quality policy — a written expression of senior management's overall intentions and direction of an organization as regards quality, including objectives for quality and commitment to quality.

readiness review — a systematic, documented review of the readiness for the start-up or continued use of a facility, process, or activity. Readiness reviews are typically conducted before proceeding beyond project milestones and prior to initiation of a major phase of work.

record (quality) — a document that furnishes objective evidence of the quality of items or activities and that has been verified and authenticated as technically complete and correct. Records may include photographs, drawings, magnetic tape, and other data recording media.

repeatability — the degree of agreement between independent test results produced by the same analyst, using the same test method and equipment on random aliquots of the same sample within a short time period.

requirement — a formal statement of a need and the expected manner in which it is to be met.

self-assessment — the assessments of work conducted by individuals, groups, or organizations directly responsible for overseeing and/or performing the work.

service — the result generated by activities at the interface between the supplier and the customer, and the supplier internal activities to meet customer needs. Such activities in environmental programs include design, inspection, laboratory and/or field analysis, repair, and installation.

significant condition — any state, status, incident, or situation of an environmental process or condition, or environmental technology in which the work being performed will be adversely affected sufficiently to require corrective action to satisfy quality objectives or specifications and safety requirements.

specification — a document stating requirements and referring to or including drawings or other relevant documents. Specifications should indicate the means and criteria for determining conformance.

standard operating procedure — a written document that details the method for an operation, analysis, or action with thoroughly prescribed techniques and steps and that is officially approved as the method for performing routine or repetitive tasks.

supplier — any individual or organization furnishing items or services or performing work according to a procurement document or a financial assistance agreement. An all-inclusive term used in place of any of the following: vendor, seller, contractor, subcontractor, fabricator, or consultant.

surveillance (quality) — continual or frequent monitoring and verification of the status of an entity and the analysis of records to ensure that specified requirements are being fulfilled.

technical review — a documented critical review of work that has been performed within the state of the art. The review is accomplished by one or more qualified reviewers who are independent of those who performed the work but are collectively equivalent in technical expertise to those who performed the original work. The review is an in-depth analysis and evaluation of documents, activities, material, data, or items that require technical verification or validation for applicability, correctness, adequacy, completeness, and assurance that established requirements have been satisfied.

technical systems audit — a thorough, systematic, on-site qualitative audit of facilities, equipment, personnel, training, procedures, record keeping, data validation, data management, and reporting aspects of a system.

traceability — the ability to trace the history, application, or location of an entity by means of recorded identifications. In a calibration sense, traceability relates measuring equipment to national or international standards, primary standards, basic physical constants or properties, or reference materials. In a data collection sense, it relates calculations and data generated throughout the project back to the requirements for the quality of the project.

validation — confirmation by examination and provision of objective evidence that the particular requirements for a specific intended use have been fulfilled. In design and development, validation concerns the process of examining a product or result to determine conformance to user needs.

variability — observed difference attributable to heterogeneity or diversity in a population. Sources of variability are the results of natural random processes and stem from environmental differences among the elements of the population. Variability is not usually reducible by further measurement but can be better estimated by increasing sampling.

variance (statistical) — a measure or dispersion of a sample or population distribution.

verification — confirmation by examination and provision of objective evidence that specified requirements have been fulfilled. In design and development, verification concerns the process of examining a result of a given activity to determine conformance to the stated requirements for that activity.