



Fuel and Carbon Dioxide Emissions Savings Calculation Methodology for Combined Heat and Power Systems

**U.S. Environmental Protection Agency
Combined Heat and Power Partnership**

February 2015

The U.S. Environmental Protection Agency (EPA) CHP Partnership is a voluntary program that seeks to reduce the environmental impact of power generation by promoting the use of CHP. The CHP Partnership works closely with energy users, the CHP industry, state and local governments, and other stakeholders to support the development of new CHP projects and promote their energy, environmental, and economic benefits.

The CHP Partnership provides resources about CHP technologies, incentives, emissions profiles, and other information on its website at www.epa.gov/chp. For more information, contact the CHP Partnership Helpline at chp@epa.gov or (703) 373-8108.

Table of Contents

1.0 Introduction	1
2.0 What Is CHP?	3
2.1 How CHP Systems Save Fuel and Reduce CO ₂ Emissions.....	4
3.0 Calculating Fuel and CO ₂ Emissions Savings from CHP	6
3.1 Fuel Use and CO ₂ Emissions from Displaced On-site Thermal Production and Displaced Grid Electricity	7
3.1.1 Fuel Use and CO ₂ Emissions from Displaced On-site Thermal Production	7
3.1.2 Fuel Use and CO ₂ Emissions from Displaced Grid Electricity.....	9
3.2 Fuel Use and CO ₂ Emissions of the CHP System	10
Appendix A: EPA CHP Emissions Calculator Example Calculation	13
Appendix B: Displaced Grid Electricity Fuel Use and CO ₂ Emissions.....	21

1.0 Introduction

Amid growing concerns about energy security, energy prices, economic competitiveness, and climate change, combined heat and power (CHP) has been recognized for its significant benefits and the part it can play in efficiently meeting society's growing energy demands while reducing environmental impacts. Policy makers, project developers, end users, and other CHP stakeholders often need to quantify the fuel and carbon dioxide (CO₂) emissions savings of CHP projects compared to conventional separate heat and power (SHP) in order to estimate projects' actual emissions reductions. An appropriate quantification of the energy and CO₂ emissions savings from CHP plays a critical role in defining its value proposition. At this time, there is no established methodology to quantify and make this estimation.

This paper provides the EPA Combined Heat and Power Partnership's (the Partnership) recommended methodology for calculating fuel and CO₂ emissions savings from CHP compared to SHP.¹ This methodology recognizes the multiple outputs of CHP systems and compares the fuel use and emissions of the CHP system to the fuel use and emissions that would have normally occurred in providing energy services through SHP.

Although the methodology recommended in this paper is useful for the specific purposes mentioned above, it is not intended as a substitute methodology for organizations quantifying and reporting GHG inventories. EPA recommends that organizations use accepted GHG protocols, such as the World Resources Institute's Greenhouse Gas Protocol² or The Climate Registry's General Reporting Protocol³, when calculating and reporting a company's carbon footprint.

However, the CO₂ emissions savings amounts estimated using the methodology recommended in this paper can be reported as supplemental information in an organization's public disclosure of its GHG inventory in order to help inform stakeholders of the emissions benefits of CHP and to highlight the organization's commitment to energy-efficient and climate-friendly technologies.

Summary of Key Points

- To calculate the fuel and CO₂ emissions savings of a CHP system, both electric and thermal outputs of the CHP system must be accounted for.
- The CHP system's thermal output displaces the fuel normally consumed in and emissions emitted from on-site thermal generation in a boiler or other equipment, and the power output displaces the fuel consumed and emissions from grid electricity.
- To quantify the fuel and CO₂ emissions savings of a CHP system, the fuel use of and emissions released from the CHP system are subtracted from the fuel use and emissions that would normally occur without the system (i.e., using SHP).
- A key factor in estimating the fuel and CO₂ emissions savings for CHP is determining the heat rate and emissions factor of the displaced grid electricity. EPA's Emissions & Generation Resource Integrated Database (eGRID) is the recommended source for these factors. See Appendix B for information about these inputs.

¹ CHP can also reduce emissions of other greenhouse gasses such as methane (CH₄) and nitrous oxide (N₂O) along with criteria air pollutants. Although methane and nitrous oxide are not discussed in this paper they are accounted for in the CHP Emissions Calculator. The CHP Emissions Calculator is available at: <http://www.epa.gov/chp/basic/calculator.html>.

² The Greenhouse Gas Protocol is available at: <http://www.ghgprotocol.org/>.

³ The Climate Registry General Reporting Protocol is available at: <http://www.theclimateregistry.org/resources/protocols/general-reporting-protocol/>.

The paper is organized as follows:

- Section 2 introduces CHP and explains the basis for fuel and CO₂ emissions savings from CHP compared to SHP.
- Section 3 presents a methodology for calculating the fuel and CO₂ emissions savings from CHP.
- Appendix A presents a sample calculation of fuel and CO₂ emissions savings using the EPA CHP Emissions Calculator.⁴
- Appendix B explains the use of EPA's Emissions & Generation Resource Integrated Database (eGRID) as a source for two important variables in the calculation of fuel and CO₂ emissions savings from displaced grid electricity: displaced grid electricity heat rate⁵ and CO₂ emissions factors. It also describes how to select values for these variables.

⁴ The EPA CHP Emissions Calculator is available at: <http://www.epa.gov/chp/basic/calculator.html>.

⁵ Heat rate is the ratio of fuel energy input as heat (Btu) per unit of net power output (kWh).

2.0 What Is CHP?

Combined heat and power (CHP) is a highly efficient method of providing power and useful thermal energy (heating or cooling) at the point of use with a single fuel source. By employing waste heat recovery technology to capture a significant portion of the heat created as a by-product of fuel use, CHP systems typically achieve total system efficiencies of 60 to 80 percent. An industrial or commercial entity can use CHP to produce electricity and thermal energy instead of obtaining electricity from the grid and producing thermal energy in an on-site furnace or boiler. In this way, CHP can provide significant energy efficiency, cost savings, and environmental benefits compared to the combination of grid-supplied electricity and on-site boiler use (referred to as separate heat and power or SHP).

CHP plays important roles both in efficiently meeting U.S. energy needs and in reducing the environmental impact of power generation. Currently, CHP systems represent approximately 8 percent of the electric generating capacity in the United States.⁶ Benefits of CHP include:

- **Efficiency benefits:** CHP requires less fuel than SHP to produce a given energy output, and because electricity is generated at the point of use, transmission and distribution losses that occur when electricity travels over power lines from central power plants are displaced.
- **Reliability benefits:** CHP can be designed to provide high-quality electricity and thermal energy on site without relying on the electric grid, decreasing the impact of outages and improving power quality for sensitive equipment.
- **Environmental benefits:** Because less fuel is burned to produce each unit of energy output, CHP reduces emissions of greenhouse gases (GHG) and other air pollutants.
- **Economic benefits:** Because of its efficiency benefits, CHP can help facilities save money on energy. Also, CHP can provide a hedge against fluctuations in electricity costs.

In the most common type of CHP system, known as a topping cycle (see Figure 1), fuel is used by a prime mover⁷ to drive a generator to produce electricity, and the otherwise-wasted heat from the prime mover is recovered to provide useful thermal energy. Examples of the two most common topping cycle CHP configurations are:

- A reciprocating engine or gas turbine burns fuel to generate electricity and a heat recovery unit captures heat from the exhaust and cooling system. The recovered heat is converted into useful thermal energy, usually in the form of steam or hot water.
- A steam turbine uses high-pressure steam from a fired boiler to drive a generator producing electricity. Low-pressure steam extracted from or exiting the steam turbine is used for industrial processes, space heating or cooling, domestic hot water, or for other purposes.

⁶ *CHP Installation Database* developed by ICF International for Oak Ridge National Laboratory and the U.S. DOE; 2014. Available at www.doe.icfwebservices.com/chpdata.

⁷ Prime movers are the devices (e.g., reciprocating engine, gas turbine, microturbine, steam turbine) that convert fuels to electrical energy via a generator.

Figure 1: Typical Reciprocating Engine/Gas Turbine CHP Configuration (Topping Cycle)

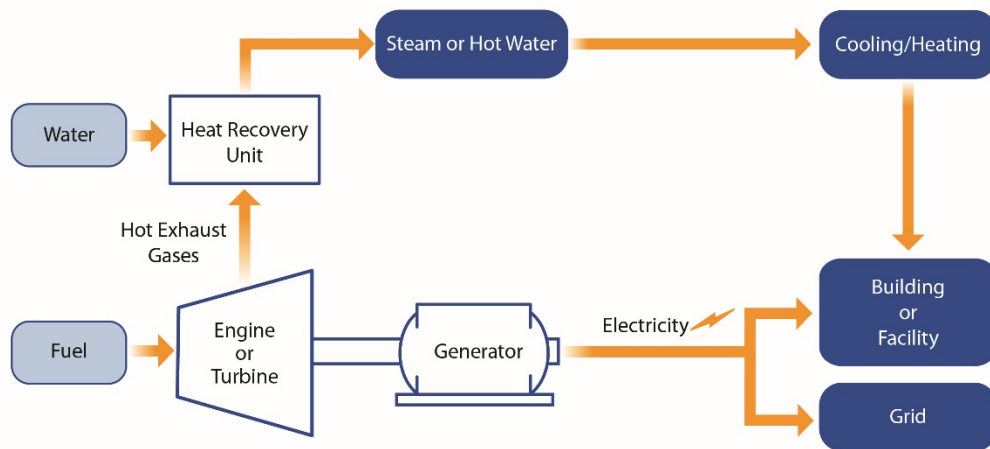

In another type of CHP system, known as a bottoming cycle, fuel is used for the purpose of providing thermal energy in an industrial process, such as a furnace, and heat from the process that would otherwise be wasted is used to generate power.

2.1 How CHP Systems Save Fuel and Reduce CO₂ Emissions

CHP's efficiency benefits result in reduced primary energy⁸ use and thus lower CO₂ emissions.

Figure 2 shows the efficiency advantage of CHP compared to SHP.⁹ CHP systems typically achieve total system efficiencies of 60 to 80 percent compared to about 45 to 55 percent for SHP. As shown in Figure 2, CHP systems not only reduce the amount of total fuel required to provide electricity and thermal energy, but also shift where that fuel is used. Installing a CHP system on site will generally increase the amount of fuel that is used at the site, because additional fuel is required to operate the CHP system compared to the equipment that otherwise would have been used on site to produce needed thermal energy.

In the example shown in Figure 2, the on-site fuel use increases from 56 units in the SHP case to 100 units in the CHP case. However, despite this increase in on-site fuel use, the total fuel used to provide the facility with the required electrical and thermal energy drops from 147 units in the SHP case, to 100 units in the CHP case, a 32 percent decrease in the amount of total fuel used.

⁸ Primary energy is the fuel that is consumed to create heat and/or electricity.

⁹ Like Figure 1, Figures 2 and 3 illustrate the most common CHP configuration known as the topping cycle. See section 2.0 for more information.

Figure 2: Energy Efficiency - CHP Versus Separate Heat and Power (SHP) Production (Topping Cycle)

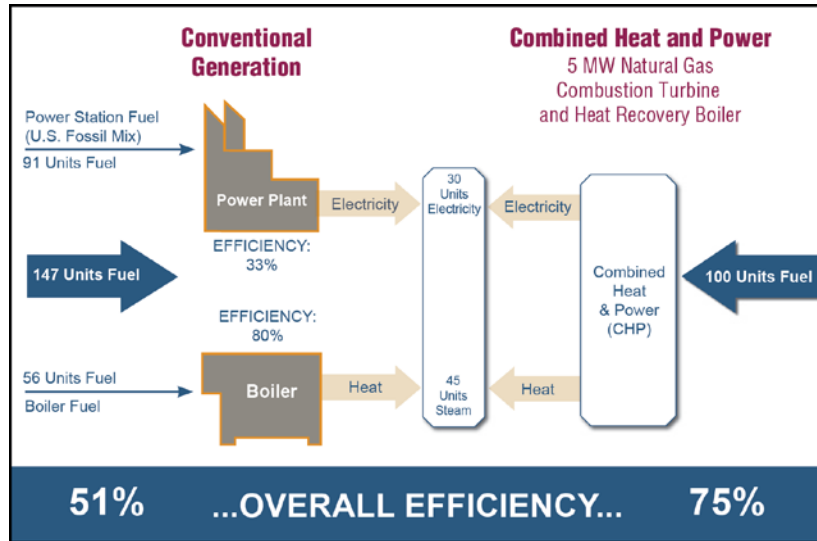

Note: Conventional power plant delivered efficiency of 33% (higher heating value [HHV]) is based on eGRID2012 and reflects the national average all fossil generating efficiency of 36.1% and 8.33% transmission and distribution losses. eGRID provides information on emissions and fuel resource mix for individual power plants, generating companies, states, and subregions of the power grid. eGRID is available at <http://www.epa.gov/cleanenergy/energy-resources/egrid/>.

Using less fuel to provide the same amount of energy reduces CO₂ and other emissions. Figure 3 shows the annual CO₂ emissions savings of a natural gas combustion turbine CHP system compared to SHP. In this case, the CHP system produces about half the annual CO₂ emissions of SHP while providing the same amount of energy to the user.

Figure 3: CO₂ Emissions - CHP Versus Separate Heat and Power (SHP) Production (Topping Cycle)

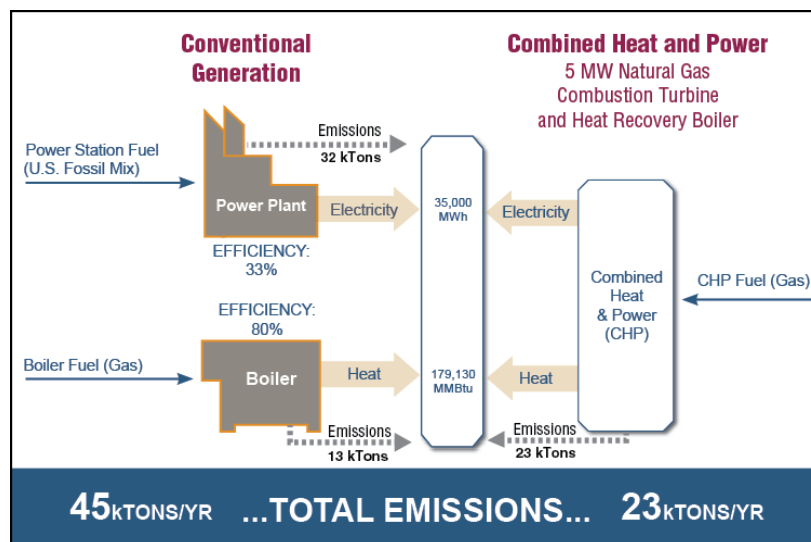

Note: Emissions savings are based on the efficiencies included in Figure 2 for SHP and a 5 MW gas turbine CHP system and 7,000 annual operating hours. Power plant CO₂ emissions are based on eGRID2012 national all fossil generation average.

3.0 Calculating Fuel and CO₂ Emissions Savings from CHP

To calculate the fuel or CO₂ emissions savings of a CHP system, both outputs of the CHP system—thermal energy and electricity—must be accounted for. The CHP system’s thermal output typically displaces the fuel otherwise consumed in an on-site boiler, and the electric output displaces fuel consumed at central station power plants.¹⁰ Moreover, the CHP system’s electric output also displaces fuel consumed to produce electricity lost during transmission and distribution.

The displaced fuel use and CO₂ emissions associated with the operation of a CHP system can be determined by:

- a. Calculating the fuel use and emissions from displaced separate heat and power (SHP) (i.e., grid-supplied electricity and on-site thermal generation such as a boiler)
- b. Calculating the fuel use and emissions from CHP
- c. Subtracting (b) from (a)

Equation 1 presents the recommended approach for calculating the fuel savings of a CHP system. Equation 2 presents the recommended approach for calculating CO₂ emissions savings of a CHP system.

CHP Emission Reductions

CHP systems reduce all types of emissions including greenhouse gases, criteria pollutants, and hazardous air pollutants, through the combustion of less fuel to provide the same energy services. The methodology presented in this paper can be used to calculate the reduction in any type of pollutant, not just carbon dioxide.

Note: Sections 3.1 and 3.2 present the approaches for calculating the individual terms found in Equations 1 and 2. Appendix A presents a sample calculation of CO₂ savings using the EPA CHP Emissions Calculator which uses the methodology and equations outlined in this section.

Equation 1: Calculating Fuel Savings from CHP

$$F_S = (F_T + F_G) - F_{CHP}$$

where:

- F_S = Total Fuel Savings (Btu)
- F_T = Fuel Use from Displaced On-site Thermal Production (Btu)
- F_G = Fuel Use from Displaced Grid Electricity (Btu)
- F_{CHP} = Fuel Used by the CHP System (Btu)

Step 1: Calculate F_T and F_G using Equation 3 (page 8) and Equation 6 (page 10), respectively.

Step 2: Calculate F_{CHP} through direct measurement or using Equations 8 (page 11), 9 (page 11) or 10 (page 12).

Step 3: Calculate F_S.

¹⁰ The thermal output from CHP can also be used to produce cooling in an absorption or adsorption chiller. Accounting for cooling introduces complexities that are not addressed in the methodology presented in this paper. However, the CHP Emissions Calculator does account for cooling.

Equation 2: Calculating CO₂ Savings from CHP

$$C_S = (C_T + C_G) - C_{CHP}$$

where:

C_S = Total CO₂ Emissions Savings (lbs CO₂)

C_T = CO₂ Emissions from Displaced On-site Thermal Production (lbs CO₂)

C_G = CO₂ Emissions from Displaced Grid Electricity (lbs CO₂)

C_{CHP} = CO₂ Emissions from the CHP System (lbs CO₂)

Step 1: Calculate C_T and C_G using Equation 4 (page 8) and Equation 7 (page 10), respectively.

Step 2: Calculate C_{CHP} using Equation 11 (page 12).

Step 3: Calculate C_S .

Note on using Equations 1 and 2 for bottoming cycle CHP systems: In the case of bottoming cycle CHP, also known as waste heat to power, power is generated on site from the hot exhaust of a furnace or kiln with no additional fuel requirement. Therefore, the fuel use and CO₂ emissions for both the CHP system and displaced thermal energy (F_{CHP} , C_{CHP} , F_T , and C_T) are all zero.

3.1 Fuel Use and CO₂ Emissions from Displaced On-site Thermal Production and Displaced Grid Electricity

3.1.1 Fuel Use and CO₂ Emissions from Displaced On-site Thermal Production

The thermal energy produced by a CHP system displaces combustion of some or all of the fuel that would otherwise be consumed for on-site production of thermal energy.¹¹ The fuel and CO₂ emissions savings associated with this displaced fuel consumption can be calculated using the thermal output of the CHP system and reasonable assumptions about the efficiency characteristics of the equipment that would otherwise have been used to produce the thermal energy being produced by the CHP system. Equation 3 presents the approach for calculating the fuel use from displaced on-site thermal production. Equation 4 presents the approach for calculating the CO₂ emissions from displaced on-site thermal production. Table 1 lists selected fuel-specific CO₂ emissions factors for use in Equation 4.

¹¹ In certain circumstances, CHP systems are designed so that supplemental on-site thermal energy production is sometimes utilized.

Equation 3: Calculating Fuel Use from Displaced On-site Thermal Production

$$F_T = \text{CHP}_T / \eta_T$$

where:

F_T = Fuel Use from Displaced On-site Thermal Production (Btu)

CHP_T = CHP System Thermal Output (Btu)

η_T = Estimated Efficiency of the Thermal Equipment (percentage in decimal form)

Step 1: Measure or estimate CHP_T .

Step 2: Select η_T (e.g., 80% efficiency for a natural gas-fired boiler, 75% for a biomass-fired boiler).

Step 3: Calculate F_T .

Equation 4: Calculating CO₂ Emissions from Displaced On-site Thermal Production

$$C_T = F_T * \text{EF}_F * (1 \times 10^{-6})$$

where:

C_T = CO₂ Emissions from Displaced On-site Thermal Production (lbs CO₂)

F_T = Thermal Fuel Savings (Btu)

EF_F = Fuel Specific CO₂ Emission Factor (lbs CO₂ /MMBtu)

1×10^{-6} = Conversion factor from Btu to MMBtu

Step 1: Calculate F_T using Equation 3.

Step 2: Select the appropriate EF_F from Table 1.

Step 3: Calculate C_T .

Table 1: Selected Fuel-Specific Energy and CO₂ Emissions Factors

Fuel Type	Energy Density	CO ₂ Emissions Factor, lb/MMBtu
Natural Gas	1,028 Btu/scf	116.9
Distillate Fuel Oil #2	138,000 Btu/gallon	163.1
Residual Fuel Oil #6	150,000 Btu/gallon	165.6
Coal (Anthracite)	12,545 Btu/lb	228.3
Coal (Bituminous)	12,465 Btu/lb	205.9
Coal (Subbituminous)	8,625 Btu/lb	213.9
Coal (Lignite)	7,105 Btu/lb	212.5
Coal (Mixed-Industrial Sector)*	11,175 Btu/lb	207.1

* This is the default value for coal used in the CHP Emissions Calculator. Users can also manually enter specific factors for type of coal used, if known.

Source: 40 CFR Part 98, Mandatory Greenhouse Gas Reporting, Table C-1: Default CO₂; Emission Factors and High Heat Values for Various Types of Fuel. Available at:

<http://ecfr.gpoaccess.gov/cgi/t/text/text-idx?c=ecfr&sid=1e922da1c1055b070807782d1366f3d1&rgn=div9&view=text&node=40:21.0.1.1.3.3.1.10.18&idno=40>.

3.1.2 Fuel Use and CO₂ Emissions from Displaced Grid Electricity

Grid electricity savings associated with on-site CHP include the grid electricity displaced by the CHP output and related transmission and distribution losses.

When electricity is transmitted over power lines, some of the electricity is lost. The amount delivered to users¹² is therefore less than the amount generated at central station power plants, usually by an average of about 6 to 9 percent.^{13,14} Consequently, generating 1 MWh of electricity on site means that more than 1 MWh of electricity no longer needs to be generated at central station power plants.¹⁵ Fuel and CO₂ emissions savings from displaced grid electricity should therefore be based on the corresponding amount of displaced grid electricity generated and not on the amount of grid electricity delivered (and consumed).

Equation 5 presents the approach for calculating the displaced grid electricity from CHP. Once the displaced grid electricity from CHP is determined, the fuel use (Equation 6) and CO₂ emissions (Equation 7) from displaced grid electricity can be calculated.

Note: Key factors needed to calculate the fuel use and CO₂ emissions from displaced grid electricity are the heat rate and CO₂ emissions factor for the grid electricity displaced. EPA's Emissions & Generation Resource Integrated Database (eGRID) is the recommended source for these factors. CHP fuel and CO₂ emissions savings calculations should be based on the heat rates and emissions factors of the eGRID subregion where the CHP system is located, utilizing the eGRID all fossil or non-baseload emissions factors as appropriate. See Appendix B for information about using eGRID.

Equation 5: Calculating Displaced Grid Electricity from CHP

$$E_G = \text{CHP}_E / (1 - L_{T\&D})$$

where:

E_G = Displaced Grid Electricity from CHP (kWh)

CHP_E = CHP System Electricity Output (kWh)

$L_{T\&D}$ = Transmission and Distribution Losses (percentage in decimal form)

Step 1: Measure or estimate CHP_E .

Step 2: Select $L_{T\&D}$. (Use the eGRID transmission and distribution loss value for the appropriate U.S. interconnect power grid*)

Step 3: Calculate E_G .

* eGRID lists the estimated transmission and distribution loss for each of the five U.S. interconnect power grids (i.e., Eastern, Western, ERCOT, Alaska, and Hawaii). (eGRID Technical Support Document: http://www.epa.gov/sites/production/files/2015-10/documents/egrid2012_technicalsupportdocument.pdf).

¹² For clarity, the amount of electricity generated by a central station power plant is referred to as “generated” electricity and the amount of electricity consumed by a facility supplied by the grid is referred to as “delivered” electricity.

¹³ EPA eGRID Technical Support Document. October 2015.

http://www2.epa.gov/sites/production/files/2015-10/documents/egrid2012_technicalsupportdocument.pdf

¹⁴ DOE Energy Information Administration. State Electricity Profiles.

http://205.254.135.24/cneaf/electricity/st_profiles/e_profiles_sum.html

¹⁵ For example, assume a consumer without CHP requires 1.0 MWh of electricity each year and T&D losses equal 8%. The delivered electricity is 1.0 MWh/yr, and the generated electricity is 1.087 MWh/yr (= 1/(1-0.08)).

Equation 6: Calculating Fuel Use from Displaced Grid Electricity

$$F_G = E_G * HR_G$$

where:

F_G = Fuel Use from Displaced Grid Electricity (Btu)

E_G = Displaced Grid Electricity from CHP (kWh)

HR_G = Grid Electricity Heat Rate (Btu/kWh) for the appropriate subregion

Step 1: Determine E_G using Equation 5.

Step 2: Select HR_G for the appropriate subregion. (See Appendix B for information about appropriate values and eGRID as a source for grid electricity heat rates.)

Step 3: Calculate F_G .

Equation 7: Calculating CO₂ Emissions from Displaced Grid Electricity

$$C_G = E_G * EF_G$$

where:

C_G = CO₂ Emissions from Displaced Grid Electricity (lbs CO₂)

E_G = Displaced Grid Electricity from CHP (kWh)

EF_G = Grid Electricity Emissions Factor (lbs CO₂ /kWh) for the appropriate subregion

Step 1: Determine E_G using Equation 5.

Step 2: Select EF_G for the appropriate subregion. (See Appendix B for information about appropriate values and eGRID as a source for grid electricity CO₂ emission factors).

Step 3: Calculate C_G .

3.2 Fuel Use and CO₂ Emissions of the CHP System

The energy content of the fuel consumed by the CHP system (F_{CHP} in Equation 1) can be determined through several methods. Direct measurement (option 1) produces the most accurate results, but if direct measurement is not an option the Partnership recommends the use of options 2, 3, or 4.

- 1) Direct measurement of the higher heating value (HHV) of the fuel consumed (typically in MMBtu_{HHV}). No calculation required.
- 2) Converting the fuel volume into an energy value (Btu equivalent) using a fuel-specific energy density using Equation 8.
- 3) Converting the fuel weight into an energy value (Btu equivalent) using a fuel-specific energy density (mass basis) using Equation 9.
- 4) Applying the electrical efficiency of the CHP system to the CHP system's electric output using Equation 10.

Equation 8: Calculating Energy Content of the Fuel Used by CHP from the Fuel Volume

$$F_{\text{CHP}} = V_{\text{F}} * ED_{\text{F}}$$

where:

F_{CHP} = Fuel Used by the CHP System (Btu)
 V_{F} = Volume of CHP Fuel Used (cubic foot, gallon, etc.)
 ED_{F} = Energy Density of CHP Fuel (Btu/cubic foot, Btu/gallon, etc.)

Step 1: Measure or estimate V_{F} .

Step 2: Select the appropriate value of ED_{F} . (See Table 1 on page 8)

Step 3: Calculate F_{CHP} .

Equation 9: Calculating Energy Content of the Fuel Used by CHP from the Fuel Weight

$$F_{\text{CHP}} = W_{\text{F}} * ED_{\text{F}}$$

where:

F_{CHP} = Fuel Used by the CHP System (Btu)
 W_{F} = Weight of CHP Fuel Used (lbs)
 ED_{F} = Energy Density of CHP Fuel – Mass Basis (Btu/lb)

Step 1: Measure or estimate W_{F} .

Step 2: Select the appropriate ED_{F} . In order to be used here, the values in Table 1 (page 8) must be converted to a mass basis using the fuel-specific density.

Step 3: Calculate F_{CHP} .

Equation 10: Calculating Energy Content of the Fuel Used by CHP from the CHP Electric Output

$$F_{\text{CHP}} = (\text{CHP}_{\text{E}} / EE_{\text{CHP}}) * 3412$$

where:

F_{CHP} = Fuel Used by the CHP System (Btu)
 CHP_{E} = CHP System Electricity Output (kWh)
 EE_{CHP} = Electrical Efficiency of the CHP System (percentage in decimal form)
3412 = Conversion factor between kWh and Btu

Step 1: Measure or estimate CHP_{E} .

Step 2: Determine EE_{CHP} . (This value should account for parasitic losses, and is usually available in a product specification sheet provided by the manufacturer of the equipment.)

Step 3: Calculate F_{CHP} .

The CO₂ emissions from the CHP system are a function of the type and amount of fuel consumed. CO₂ emissions rates are commonly presented as pounds of emissions per million Btu of fuel input (lb/MMBtu). Table 1 on page 8 lists common fuel-specific CO₂ emissions factors. Equation 11 presents the approach for calculating CO₂ emissions from a CHP system (C_{CHP} in Equation 2).

Equation 11: Calculating CO₂ Emissions from the CHP System

$$C_{\text{CHP}} = F_{\text{CHP}} * EF_F$$

where:

C _{CHP}	=	CO ₂ Emissions from the CHP System (lbs CO ₂)
F _{CHP}	=	Fuel Used by the CHP System (Btu)
EF _F	=	Fuel Specific Emissions Factor (lbs CO ₂ /MMBtu)

Step 1: Measure or calculate F_{CHP} using Equations 8 (page 11), 9 (page 11), or 10 (page 12).

Step 2: Select the appropriate EF_F from Table 1 on page 8.

Step 3: Calculate C_{CHP} the CO₂ emissions from the CHP system.

Appendix A: EPA CHP Emissions Calculator Example Calculation

The Partnership developed the EPA CHP Emissions Calculator to help users calculate the fuel and CO₂ emissions reductions achieved by CHP compared to SHP.¹⁶ The default values in the Calculator are based on the guidelines in this paper. However, users can also input selected CHP system characteristics and emissions factors for CHP fuel, displaced thermal fuel, and displaced grid electricity.

The EPA CHP Emissions Calculator is available at: <http://www.epa.gov/chp/basic/calculator.html>.

The following example shows how a user would operate the CHP Emissions Calculator to determine the fuel and CO₂ savings achieved by a CHP system. The example system is a 5 MW natural gas-fired combustion turbine and heat recovery boiler CHP system that provides heating for an industrial process at a facility in Pennsylvania. The CHP system is displacing thermal energy provided by an existing natural gas boiler and grid electricity in the RFC East subregion (the eGRID subregion that includes Pennsylvania).¹⁷

Calculator Input

The following figures show the calculator inputs that are needed to evaluate this system. Figure 4 shows the Calculator inputs related to the CHP system itself. For this example, the Calculator default values were used for the electric efficiency and the power-to-heat ratio of the CHP system.

¹⁶ The CHP Emissions Calculator also accounts for methane (CH₄), nitrogen oxides (NO_x), nitrous oxide (N₂O), and sulfur dioxide (SO₂).

¹⁷ Information about eGRID subregions is contained in Appendix B.

Figure 4: CHP Emissions Calculator – CHP System Characteristics

1. CHP: Type of System		Combustion Turbine	Submit
2. CHP: Electricity Generating Capacity (per unit)		Normal size range for this technology is 1,000 to 40,000 kW	
		5,000 kW	Submit
3. CHP: How Many Identical Units (i.e., engines) Does This System Have?		1	Submit
4. CHP: How Many Hours per Year Does the CHP System Operate?		I will enter a value	
	As a number of hours per year	7,500	Submit
	OR As a percentage	0%	
5. CHP: Does the System Provide Heating or Cooling or Both?		Heating Only	
If Heating and Cooling: How many of the 7,500 hours are in cooling mode?			
	As a number of hours per year	-	Submit
	as a percentage of the 7,500 hours?	0%	
If Heating and Cooling: Does the System Provide Simultaneous Heating and Cooling?		No	
6. CHP: Fuel		Fuel Type: Natural Gas	View Biomass and Coal Fuel Characteristics
			Submit

12. CHP: Electric Efficiency		I will enter an efficiency in one of the following blocks	Use default for this technology
	Enter Generating Efficiency as %	29% (HHV)	Submit
	OR Enter Generating Efficiency as Btu/kWh HHV	11,806 Btu/kWh (HHV)	
	OR Enter Generating Efficiency as Btu/kWh LHV	10,684 Btu/kWh (LHV)	
13. CHP: Base Power to Heat Ratio			
The Power to Heat Ratio should reflect ONLY the thermal production of the generating unit (i.e., combustion turbine). Thermal Output of the duct burners (if equipped) should not be included.			
	I will enter a Power to Heat ratio	Use default for this technology	Use the Thermal Calculator to calculate my Power to Heat Ratio
	Power to Heat Ratio	0.62	Submit

After entering the information about the CHP system to be evaluated, information is entered related to the displaced on-site thermal energy production (i.e., the thermal energy produced by the CHP system that replaces thermal energy formerly produced by an on-site boiler). Information about the thermal equipment and fuel provides the basis for calculating the displaced thermal fuel use and CO₂ emissions. Figure 5 shows the Calculator inputs related to the displaced thermal energy.

Figure 5: CHP Emissions Calculator – Displaced Thermal Energy

23. Displaced Thermal: Type of System: Existing Gas Boiler

24. Displaced Thermal: If not a Natural Gas System: What is the Sulfur Content?
 I will enter a value or Commercial coal: 1% sulfur
 High sulfur oil: 0.15% or 1,500 ppm
 Low sulfur oil: 0.05% or 500 ppm
 Enter Sulfur Content as a percent: 0.00%
 OR ppm: - ppm

25. Displaced Thermal: What is the CO₂ Emission Rate for this Fuel? (default completed for fuel in Item 23)
 Enter alternative value: 116.9 lb CO₂/MMBtu

26. Displaced Thermal: What is the Heat Content of this Fuel? (Enter a value in only ONE of the boxes)
 1,028 Btu/cubic foot (HHV)
 OR - Btu/gallon (HHV)
 OR - Btu/lb (HHV)

27. Displaced Thermal: Efficiency (usually a boiler)
 I will enter an efficiency Use default for this thermal technology
 Enter Generating Efficiency as %: 80%

The equations for calculating fuel use and CO₂ emissions from displaced on-site thermal energy production are:

Fuel Use from Displaced On-site Thermal Energy Production (Equation 3):

$$F_T = \text{CHP}_T / \eta_T$$

$$257,964 \text{ MMBtu/yr} = 206,371 \text{ MMBtu/yr} / 80\%$$

where:

- F_T = Fuel Use from Displaced On-site Thermal Production (Btu)
- CHP_T = CHP System Thermal Output (Btu)
- η_T = Thermal Equipment Efficiency (%)

CO₂ Emissions from Displaced On-site Thermal Production (Equation 4):

$$C_T = F_T * \text{EF}_F$$

$$30,155,992 \text{ lbs CO}_2 = 257,964 \text{ MMBtu/yr} * 116.9 \text{ lb CO}_2/\text{MMBtu}$$

where:

- C_T = CO₂ emissions from displaced on-site thermal production (lbs CO₂)
- F_T = Thermal Fuel Savings (Btu)
- EF_F = Fuel Specific Emissions Factor (lbs CO₂/MMBtu)

The CHP Emissions Calculator inputs related to the displaced grid electricity are shown in Figure 6 below. A variety of displaced electricity generation profiles are available including eGRID profiles,

specific electricity generation equipment profiles, and user-defined profiles. The eGRID emissions profiles include: Total Output Emissions Rate, Fossil Fuel Output Emissions Rate, Non-Baseload Output Emissions Rate, Coal Output Emissions Rate, Oil Output Emissions Rate, and Gas Output Emissions Rate. The Partnership recommends using the Fossil Fuel Output Emissions Rate because it most accurately reflects the emissions of generation displaced by CHP (see eGRID information in Appendix B). The Partnership also recommends using the rate for the eGRID subregion in which the CHP system is located. In this example the eGRID subregion encompassing eastern Pennsylvania is RFC East. For transmission and distribution (T&D) losses, the Partnership recommends using the eGRID value for grid losses from the appropriate U.S. interconnect power grid. There are five U.S. interconnect power grids (Eastern, Western, ERCOT, Alaska, and Hawaii), and the appropriate grid for this example is the Eastern grid, with an average T&D losses of 9.17%.

Figure 6: CHP Emissions Calculator – Displaced Electricity

The screenshot shows a web-based calculator interface with three main sections, each on a yellow background:

- 29. Displaced Electricity: Generation Profile**: Contains a dropdown menu set to "eGRID Fossil Fuel (2012 data)", a "Submit" button, and a link: [Link to EPA's Fuel and CO2 Emissions Savings Calculation Methodology for CHP](#). A button labeled "Modify one of the Three User-Defined Generating Sources" is also present.
- 30. Displaced Electricity: Select U.S. Average, eGRID Subregion, NERC region, or State**: Contains a dropdown menu set to "US Average", a "Submit" button, and a link: [Link to eGRID Subregion Map](#).
- 31. Displaced Electricity: Select Electric Grid Region for Transmission and Distribution (T&D) Losses**: Contains a dropdown menu set to "Eastern Interconnect" with a value of "9.17%" displayed below it, a "Submit" button, and a link: [Link to NERC Interconnections Map](#).

The total fuel use and CO₂ emissions of displaced grid electricity are calculated using the following equations:

Displaced Grid Electricity from CHP (Equation 5):

$$E_G = \text{CHP}_E / (1 - L_{T\&D})$$

$$41,286 \text{ MWh/year} = 37,500 \text{ MWh/year} / (1 - 9.17\%)$$

where:

- E_G = Displaced Grid Electricity from CHP (kWh)
- CHP_E = CHP System Electricity Output (kWh)
- $L_{T\&D}$ = Transmission and Distribution Losses (%)

Fuel Use from Displaced Grid Electricity (Equation 6):

$$F_G = E_G * HR_G$$

$$429,043 \text{ MMBtu/year} = 41,286 \text{ MWh/year} * 10,392 \text{ Btu/kWh} / 1000$$

where:

- F_G = Fuel Use from Displaced Grid Electricity (Btu)
- E_G = Displaced Grid Electricity from CHP (kWh)

HR_G = Grid Electricity Heat Rate (Btu/kWh)

CO₂ Emissions from Displaced Grid Electricity ([Equation 7](#)):

$$C_G = E_G * EF_G$$
$$90,086,052,000 \text{ lbs CO}_2 = 41,286 \text{ MWh/year} * 2,182 \text{ lb CO}_2/\text{kWh} * 1000$$

where:

- C_G = CO₂ Emissions from Displaced Grid Electricity (lbs)
- E_G = Displaced Grid Electricity from CHP (kWh)
- EF_G = Grid Electricity Emissions Factor (CO₂ lb/kWh)

Calculator Results

Once the user has entered all of the information on the Inputs page of the Calculator and clicked the “Go to Results” button the Results page is displayed. Figure 7 illustrates the results for this example, which shows that the CHP system reduces overall fuel consumption by 244,282 MMBtu/year and CO₂ emissions by 32,241 tons/year.

Figure 7: CHP Emissions Calculator – Fuel and Emissions Savings Results

CHP Results



The results generated by the CHP Emissions Calculator are intended for educational and outreach purposes only; it is not designed for use in developing emission inventories or preparing air permit applications.

The results of this analysis have not been reviewed or endorsed by the EPA CHP Partnership.

Table 1

Annual Emissions Analysis

	CHP System	Displaced Electricity Production	Displaced Thermal Production	Emissions/Fuel Reduction	Percent Reduction
NO _x (tons/year)	34.18	40.76	12.90	19.48	36%
SO ₂ (tons/year)	0.13	105.97	0.08	105.92	100%
CO ₂ (tons/year)	25,877	44,040	15,078	33,241	56%
CH ₄ (tons/year)	0.49	0.503	0.28	0.299	38%
N ₂ O (tons/year)	0.05	0.716	0.03	0.696	93%
Total GHGs (CO ₂ e tons/year)	25,903	44,272	15,093	33,462	56%
Fuel Consumption (MMBtu/year)	442,725	429,043	257,964	244,282	36%
Equal to the annual GHG emissions from this many passenger vehicles:				6,347	
Equal to the annual GHG emissions from the generation of electricity for this many homes:				4,151	

This CHP project will avoid yearly emissions of greenhouse gases by 33,462 tons of carbon dioxide equivalent.

Equal to the annual greenhouse gas emissions from 6,347 passenger vehicles.



Equal to the annual greenhouse gas emissions from the generation of electricity used by 4,151 homes.



The equations for the relationship for total fuel savings and CO₂ savings are as follows:

Total Fuel Savings from CHP ([Equation 1](#)):

$$F_S = (F_T + F_G) - F_{CHP}$$

$$244,282 \text{ MMBtu/year} = (257,964 \text{ MMBtu/year} + 429,043 \text{ MMBtu/year}) - 442,725 \text{ MMBtu/year}$$

where:

- F_S = Total Fuel Savings
- F_T = Fuel Use from Displaced On-site Thermal Production
- F_G = Fuel Use from Displaced Grid Electricity
- F_{CHP} = Fuel Used by the CHP System

Total CO₂ Savings from CHP ([Equation 2](#)):

$$C_S = (C_T + C_G) - C_{CHP}$$

$$33,241 \text{ lbs CO}_2 = (15,078 \text{ lbs} + 44,040 \text{ lbs}) - 25,877 \text{ lbs}$$

where:

- C_S = Total CO₂ Emissions Savings
- C_T = CO₂ Emissions from Displaced On-site Thermal Production
- C_G = CO₂ Emissions from Displaced Grid Electricity
- C_{CHP} = CO₂ Emissions from the CHP System

Figure 8 shows the outputs of the CHP system in more detail, and Figure 9 shows the emissions rates for the CHP system as well as those from the displaced thermal production and displaced electricity generation.

Figure 8: CHP Emissions Calculator, CHP Outputs

Table 2	
CHP Technology: Combustion Turbine	
Fuel: Natural Gas	
Unit Capacity:	5,000 kW
Number of Units:	1
Total CHP Capacity:	5,000 kW
Operation:	7,500 hours per year
Heat Rate:	11,806 Btu/kWh HHV
CHP Fuel Consumption:	442,725 MMBtu/year
Duct Burner Fuel Consumption:	- MMBtu/year
Total Fuel Consumption:	442,725 MMBtu/year
Total CHP Generation:	37,500 MWh/year
Useful CHP Thermal Output:	206,371 MMBtu/year for thermal applications (non-cooling)
	- MMBtu/year for electric applications (cooling and electric heating)
	206,371 MMBtu/year Total
Table 3	
Displaced On-Site Production for Thermal (non-cooling) Applications:	Existing Gas Boiler 0.10 lb/MMBtu NOx 0.00% sulfur content
Displaced Electric Service (cooling and electric heating):	There is no displaced cooling service
Table 4	
Displaced Electricity Profile: eGRID Fossil Fuel (2010 data)	
Egrid State:	RFCE East
Distribution Losses:	9%
Displaced Electricity Production:	37,500 MWh/year CHP generation
	- MWh/year Displaced Electric Demand (cooling)
	- MWh/year Displaced Electric Demand (electric heating)
	3,786 MWh/year Transmission Losses
	41,286 MWh/year Total

Figure 9: CHP Emissions Calculator, Emissions Rates

Table 5
Annual Analysis for CHP

	CHP System: Combustion Turbine		Total Emissions from CHP System
NO _x (tons/year)	34.18	-	34.18
SO ₂ (tons/year)	0.13	-	0.13
CO ₂ (tons/year)	25,877	-	25,877
CH ₄ (tons/year)	0	-	0
N ₂ O (tons/year)	0	-	0
Total GHGs (CO ₂ e tons/year)	25,903	-	25,903
Fuel Consumption (MMBtu/year)	442,725	-	442,725

Table 6
Annual Analysis for Displaced Production for Thermal (non-cooling) Applications

	Total Displaced Emissions from Thermal Production
NO _x (tons/year)	12.90
SO ₂ (tons/year)	0.08
CO ₂ (tons/year)	15,078
CH ₄ (tons/year)	0
N ₂ O (tons/year)	0
Total GHGs (CO ₂ e tons/year)	15,093
Fuel Consumption (MMBtu/year)	257,964

Table 7
Annual Analysis for Displaced Electricity Production

	Displaced CHP Electricity Generation	Displaced Electricity for Cooling	Displaced Electricity for Heating	Transmission Losses	Total Displaced Emissions from Electricity Generation
NO _x (tons/year)	37.02	-	-	3.74	40.76
SO ₂ (tons/year)	96.26	-	-	9.72	105.97
CO ₂ (tons/year)	40,001	-	-	4,038.45	44,040
CH ₄ (tons/year)	0.457	-	-	0.046	0.503
N ₂ O (tons/year)	0.650	-	-	0.066	0.716
Total GHGs (CO ₂ e tons/year)	40,213	-	-	4,060	44,272
Fuel Consumption (MMBtu/year)	389,700	-	-	39,343	429,043

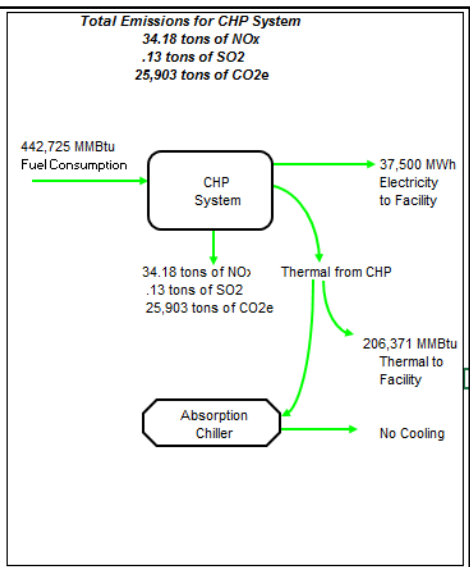
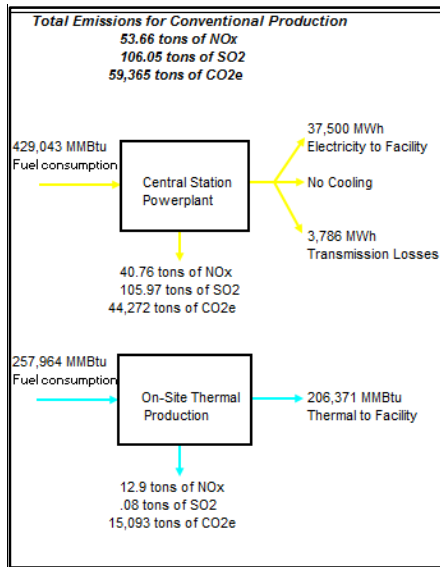

Appendix B: Displaced Grid Electricity Fuel Use and CO₂ Emissions

The displaced fuel use and CO₂ emissions associated with the operation of a CHP system can be determined by:

- a. Calculating the fuel use and emissions from displaced separate heat and power (SHP) (i.e., grid-supplied electricity and on-site thermal generation such as a boiler)
- b. Calculating the fuel use and emissions from CHP
- c. Subtracting (b) from (a)

The challenge of calculating the fuel use and emissions associated with displaced grid electricity stems from the fact that grid electricity is generated by a large number of sources with different fuels and different heat rates. The sources that are reasonably expected to be displaced must therefore be determined in order to estimate the displaced fuel use and emissions.

Section 3.1.1 of this paper presents the Partnership's recommended methodology for calculating the fuel use and emissions from displaced thermal generation, and section 3.1.2 presents the recommended methodology for calculating the fuel use and emissions from displaced grid electricity. Section 3.2 presents the recommended methodology for calculating the fuel use and emissions from CHP.

This appendix complements the methodology provided in section 3.1.2 by:

- Discussing use of EPA's Emissions & Generation Resource Integrated Database (eGRID) as a resource for the grid electricity heat rate (HR_G) and the grid electricity emissions factor (EF_G) needed to calculate the fuel and CO₂ emissions associated with displaced grid electricity from CHP.
- Explaining why, when calculating fuel and CO₂ emissions savings associated with CHP, the Partnership recommends using the following factors:
 - the eGRID all fossil emissions factor and heat rate for the eGRID subregion where the CHP system is located for baseload CHP (i.e., greater than 6,500 annual operating hours), and
 - the eGRID non-baseload emissions factor and heat rate for the eGRID subregion where the CHP system is located for CHP systems with relatively low annual capacity factors (i.e., less than 6,500 annual operating hours) and with most generation occurring during periods of high system demand.

B.1 EPA's Emissions & Generation Resource Integrated Database (eGRID)

Background

EPA's eGRID¹⁸ is a comprehensive and widely-used resource¹⁹ for information about electricity-generating plants that provide power to the electric grid and report data to the U.S. government. eGRID provides data on:

- Generation (MWh)
- Fuel use
- Plant heat rate
- Resource mix (e.g., coal, gas nuclear, wind, solar)
- Emissions associated with power generation in the United States

In order to enhance the usability of this data, eGRID separates and organizes it into useful levels of aggregation, as follows:

- Plant
- State
- Electric generating company (EGC)
- Power control area (PCA)
- eGRID subregion
- North American Electric Reliability Corporation (NERC) region
- U.S. total

Note:

- eGRID consists of historic sets of recent data; it does not include projections of the operating characteristics of generating units in the future.
- The generation data and related data categories provided by eGRID are based on generated electricity, not consumed (i.e., delivered) electricity and therefore do not include the impact of transmission and distribution (T&D) losses (see Section 3.1.2 and Equation 5 for more information on T&D losses).

Aggregation Level – eGRID subregion

EPA defines eGRID subregions based on NERC regions and PCAs. There are 26 eGRID subregions (see Figure B-1) in eGRID2012, and each consists of one PCA or a portion of a PCA. eGRID subregions generally represent sections of the grid that have similar resource mix and emissions characteristics.

^{15 18} EPA has generated and published detailed information on electricity generation and emissions since 1998. The most recent edition of eGRID, was released in 2015 and contains data collected in 2012. More information is available at <http://www.epa.gov/cleanenergy/energy-resources/egrid/>

¹⁹ According to the eGRID Technical Support Document, more than 40 tools, applications, and programs (public and private) rely on eGRID data.

Figure B-1: eGRID Subregion Map²⁰

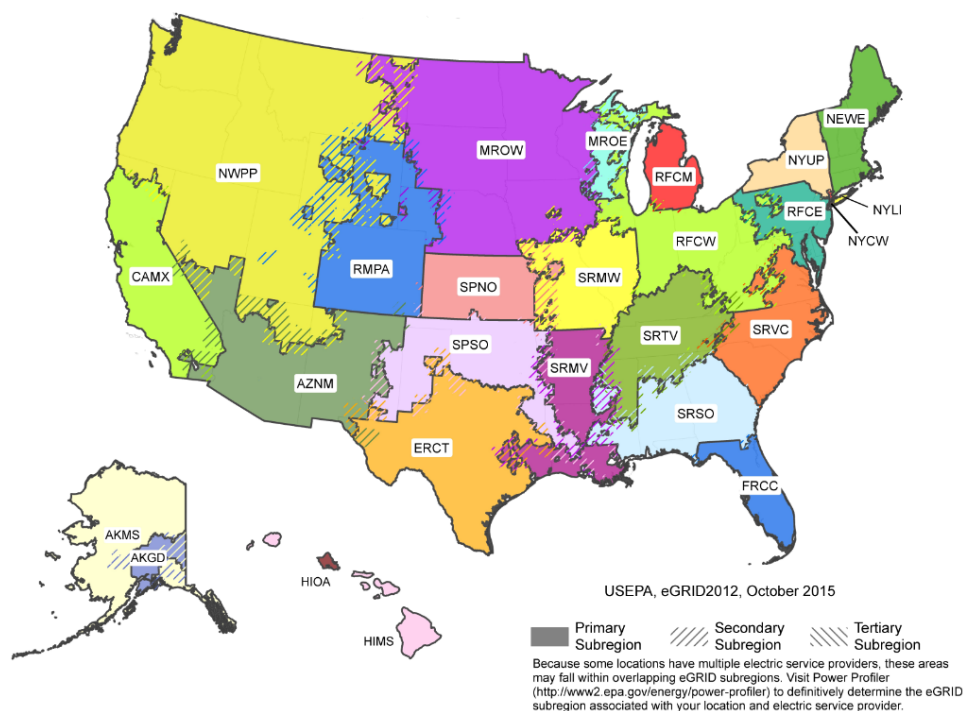

Emissions and Heat Rate Data

eGRID presents the heat rate of each listed plant, and emissions data aggregated by fuel type and by generation source category (e.g., all fossil fuels). eGRID also presents emissions data for several pollutants—carbon dioxide (CO₂), nitrogen oxides (NO_x), sulfur dioxide (SO₂), methane (CH₄), nitrous oxide (N₂O) and mercury (Hg)—in the form of emissions rates on an output basis (lb/MWh) and on a fuel input basis (lb/MMBtu).

Notes on Terminology. For the sake of clarity and consistency, eGRID emission rates (lb/MWh) are referred to in this appendix as *emissions factors*. Also note that, because this document addresses how to calculate avoided CO₂ emissions, all subsequent references to eGRID emissions data in this appendix refer to CO₂ emissions only.

Three types of generation rates provided in eGRID are discussed in this appendix²¹:

- **Total Output**
The Total Output rates are based on data for all power generation regardless of energy source (i.e., fossil, nuclear, hydro, and renewables) within a defined region or subregion. One CO₂

²⁰ Many of the boundaries shown on this map are approximate because they are based on company location rather than on strict geographical boundaries.

²¹ In addition to the three eGRID generation categories listed here, eGRID also includes an “annual combustion output” category. This category is not discussed in this appendix since it was primarily developed to estimate NO_x and SO₂ emissions from combustion generating units that are dispatched to respond to marginal increases in electricity demand, and thus not applicable to CO₂ calculations involving CHP.

emissions factor (lb/MWh) and one heat rate (Btu/kWh) value are associated with the category for each NERC region and eGRID subregion.

- **Fossil Fuel Output**

The Fossil Fuel Output rates are based on data for power generation from fossil fuel-fired plants within a defined region or subregion. One CO₂ emission factor (lb/MWh) and one heat rate (Btu/kWh) value are associated with the category for each NERC region and eGRID subregion. EPA characterizes this emissions factor as “a rough estimate to determine how much emissions could be avoided if energy efficiency and/or renewable energy displaces fossil fuel generation.”²² The EPA CHP Partnership recommends the emissions factor and heat rate from this category to determine emissions and fuel use from displaced grid electricity when evaluating CHP systems.²³ The rationale for this recommendation is presented in section B.3 below.

eGRID also provides emissions factors by specific fossil fuel type (i.e., for coal-, natural gas-, and oil-fired generating plants). These emissions factors are useful in assessing the different impacts of fossil fuels, but they are rarely used to evaluate the relationship between CHP and displaced grid electricity emissions.

- **Non-baseload Output**

The Non-baseload Output rates are based on data for power generation from combustion generating units within a defined region or subregion that do not serve as baseload units. One CO₂ emissions factor (lb/MWh) and one heat rate (Btu/kWh) value are associated with the category for each NERC region and eGRID subregion. The term “baseload” refers to those plants that supply electricity to the grid even when demand for electricity is relatively low. Baseload plants are usually brought online to provide electricity to the grid regardless of the level of demand, and they generally operate continuously except when undergoing routine or unscheduled maintenance. EPA developed the non-baseload output emissions factors to estimate emissions reductions from energy efficiency projects and certain types of clean energy projects based on the emissions from generating units that are dispatched to respond to marginal increases in electricity demand.²⁴ eGRID calculates the non-baseload factors by weighting each plant's emissions and generation according to its capacity factor. The generation and emissions from plants that operate most of the time, (that is, baseloaded plants with annual capacity factors greater than 0.8) are excluded. All the generation and emissions from fuel-based plants that operate infrequently during the year (for example, peaking units with capacity factors less than 0.2) are included. A portion of the emissions and generation from the remaining fuel-based plants (i.e., those with capacity factors between 0.2 and 0.8) are included, with higher portions used for plants with lower capacity factors and lower portions used for plants with higher capacity factors.

Table B-1 provides the all generation, all fossil, and non-baseload emissions factors from eGRID.

²² “EPA eGRID Technical Support Document. October 2015.

http://www2.epa.gov/sites/production/files/2015-10/documents/egrid2012_technicalsupportdocument.pdf

²³ The CHP Emissions Calculator is available at: <http://www.epa.gov/chp/basic/calculator.html>

²⁴ Rothschild, S. and Diem, A., “Guidance on the Use of eGRID Output Emissions Rates”, <http://www.epa.gov/ttn/chief/conference/ei18/session5/rothschild.pdf>

Table B-1: eGRID Ninth Edition CO2 Emission Factors and Heat Rates by NERC Region and eGRID Subregion (2012 year data)

NERC Region and Subregions	All Generation		All Fossil Average		Non-BaseLoad	
	Heat Rate (Btu/kW h)	CO2 Emission Factor (lb/MW h)	Heat Rate (Btu/kW h)	CO2 Emission Factor (lb/MW h)	Heat Rate (Btu/kW h)	CO2 Emission Factor (lb/MW h)
Alaska Systems Coordinating Council	7,969	1087	10,351	1,412	10,171	1,388
ASCC Alaska Grid	9,398	1,269	10,470	1,414	10,206	1,378
ASCC Miscellaneous	3,199	481	9,311	1,400	9,338	1,404
Florida Reliability Coordinating Council	7,767	1,125	8,500	1,217	9,220	1,334
FRCC All	7,767	1,125	8,500	1,217	9,220	1,334
Hawaiian Islands Coordinating Council	8,746	1,471	9,429	1,599	8,055	1,386
HICC Miscellaneous	7,554	1,200	9,867	1,656	8,124	1,331
HICC Oahu	9,210	1,576	9,297	1,583	8,028	1,402
Midwest Reliability Organization	7,188	1,437	10,442	2,142	9,396	1,927
MRO East	7,841	1,523	10,153	2,077	8,659	1,739
MRO West	7,097	1,425	10,488	2,152	9,550	1,965
Northeast Power Coordinating Council	4,987	602	8,775	1,056	9,105	1,141
NPCC Long Island	9,448	1,201	9,489	1,129	10,811	1,303
NPCC New England	6,294	697	10,026	1,176	9,115	1,081
NPCC NYC/Westchester	5,333	638	8,463	980	8,646	1,080
NPCC Upstate NY	3,108	409	8,120	1,086	9,000	1,229
Reliability First Corporation	6,722	1,248	9,780	1,821	9,206	1,725
RFC East	5,292	859	9,272	1,469	9,221	1,492
RFC Michigan	8,597	1,569	9,921	1,854	9,896	1,856
RFC West	7,098	1,379	9,943	1,942	9,151	1,792
Southeast Reliability Corporation	6,819	1,184	9,549	1,688	9,402	1,671
SERC Midwest	8,423	1,711	10,178	2,070	9,430	1,918
SERC Mississippi Valley	7,168	1,053	9,603	1,384	8,631	1,302
SERC South	7,063	1,149	8,928	1,519	10,082	1,697
SERC Tennessee Valley	7,047	1,337	9,962	1,913	9,107	1,744
SERC Virginia/Carolina	5,468	933	9,441	1,666	10,098	1,791
Southwest Power Pool	8,917	1,596	10,215	1,852	9,457	1,709
SPP North	8,694	1,722	10,774	2,150	10,586	2,112
SPP South	9,018	1,539	9,988	1,729	9,222	1,590
Texas Regional Entity	7,006	1,143	8,660	1,418	7,819	1,281
TRE All	7,006	1,143	8,660	1,418	7,819	1,281
Western Electricity Coordinating Council	5,395	879	9,241	1,537	7,625	1,278
WECC California	5,409	650	7,955	986	7,983	1,019
WECC Northwest	3,673	666	9,966	1,859	8,433	1,579
WECC Rockies	9,316	1,823	10,683	2,095	8,525	1,670
WECC Southwest	6,758	1,153	9,427	1,614	7,200	1,236

B.2 Selecting the Appropriate eGRID Aggregation Level

As explained in Section B.1, eGRID data is aggregated in many ways (e.g., plant, state, EGC, eGRID subregion). However, when selecting the appropriate grid electricity emissions factor (EF_G) and heat rate (HR_G) required by Equations 6 and 7 in Section 3.1.2, the aggregation level should reflect the nature of the electricity supply to the site where the CHP system is located. The Partnership therefore recommends using the eGRID emissions factor and heat rate for the eGRID subregion where the CHP system is located. The Partnership bases this recommendation on the following factors²⁵:

- In general, eGRID subregions represent sections of the grid that have similar resource mix and emissions characteristics, operate as an integrated entity, and support most of the demand in the subregion with power generated within the subregion.
- Using the state aggregation level may not be appropriate, because emissions factors and heat rates for this level often omit generation that is imported into the state or generation that is exported to other states, and therefore may less accurately reflect the fuel use and emissions impacts of generation displaced by a specific CHP system than the eGRID subregion aggregation level." The EGC level likely omits an even greater amount of imports and exports than the state level, and, therefore, also may not be appropriate for the same reasons as for the state level.
- Emissions factors and heat rates for the NERC region or U.S. average aggregation levels do not reflect significant regional variations in the emissions from generation, and therefore do not accurately reflect the fuel use and emissions impacts of generation displaced by a specific CHP system.

In summary, in the absence of nationally consistent and complete utility-specific import and export data, the eGRID subregion level heat rates and emissions factors most accurately characterize the generation that is displaced by CHP systems. The CHP Emissions Calculator also provides other regional aggregation levels that may be useful to users in specific situations (eg. when evaluating state impacts).

B.3 Selecting the Appropriate eGRID Emissions and Heat Rate Category

When selecting the eGRID emissions and heat rate category, it is important to select the category that contains central station generators representative of those that are displaced by CHP systems. At first glance, each of the eGRID categories mentioned above (i.e., total output, fossil fuel output, and non-baseload) may seem like reasonable choices for HR_G in Equation 6 and EF_G in Equation 7 of Section 3.1.2; however the Partnership recommends using the following factors:

- the eGRID fossil fuel output emissions factor and heat rate for the eGRID subregion where the CHP system is located for baseload CHP (i.e., greater than 6,500 annual operating hours), and
- the eGRID non-baseload emissions factor and heat rate for the eGRID subregion where the CHP system is located for CHP systems with relatively low annual capacity factors (i.e., less than 6,500 annual operating hours) and with most generation occurring during periods of high system demand.

This section provides a detailed rationale for this recommendation.

²⁵ Rothschild, S. et al., "The Value of eGRID and eGRIDweb to GHG Inventories", http://www.epa.gov/cleanenergy/documents/eGRIDzips/The_Value_of_eGRID_Dec_2009.pdf

Estimating the energy and emissions displaced by CHP requires an estimate of the nature of generation displaced by the use of power produced by the CHP system. Accurate estimates can be made using a power system dispatch model to determine how emissions for generation in a specific eGRID subregion are impacted by the shift in the system demand curve and generation mix resulting from the addition of CHP systems. However, these models are complex and costly to run.

As stated previously, eGRID provides two rates that can be used to estimate the mix of generation that is displaced by the use of clean energy technologies such as CHP: the fossil fuel output rates and the non-baseload output rates. Use of the total output rates is not appropriate since it includes a substantial amount of baseload generation that is not offset by CHP projects.

The following load duration curve analysis demonstrates why CHP typically displaces fossil-fuel fired power generation, and explains appropriate uses of the fossil fuel and non-baseload emissions factors and heat rates.

Load Duration Curve Analysis

Using eGRID data, which accurately characterizes the emissions associated with generation in a given region or subregion, a relatively simple load duration curve analysis can be used to show the impact of CHP additions. The load duration curve analysis presented here first introduces a typical load duration curve, and then shows how the addition of CHP affects the resources dispatched.

Demand for electricity varies widely over the year, and different types and sizes of generators are used to meet the varying load as it occurs. A load duration curve represents the electric demand in MW for a specific region or subregion for each of the 8,760 hours in the year.

Figure B-2 below presents a load duration curve for a hypothetical PCA. The shape of the curve is typical of electric load duration curves. Demand in MW is indicated on the vertical axis and the hours of the year are indicated on the horizontal axis. Hourly demand levels are ordered from highest to lowest. In this example, the graph shows that the highest hourly electric demand is 10,000 MW and the demand for the next highest hour is about 9,800 MW. The minimum demand is 4,000 MW, meaning that every hour of the year had at least this much demand. The area under the curve represents the total generation for the year. The zones defined by horizontal lines represent a typical generating mix and dispatch order. In a competitive electric market, the generators are dispatched based on their bid price into the market (typically a function of the variable costs of generation, fuel, other consumable items, and operation and maintenance costs). Generators with low variable costs will be dispatched first, and will therefore operate many hours per year (i.e., serve as baseload generators).

Figure B-2: Hypothetical Power System Load Duration Curve and Dispatch Order

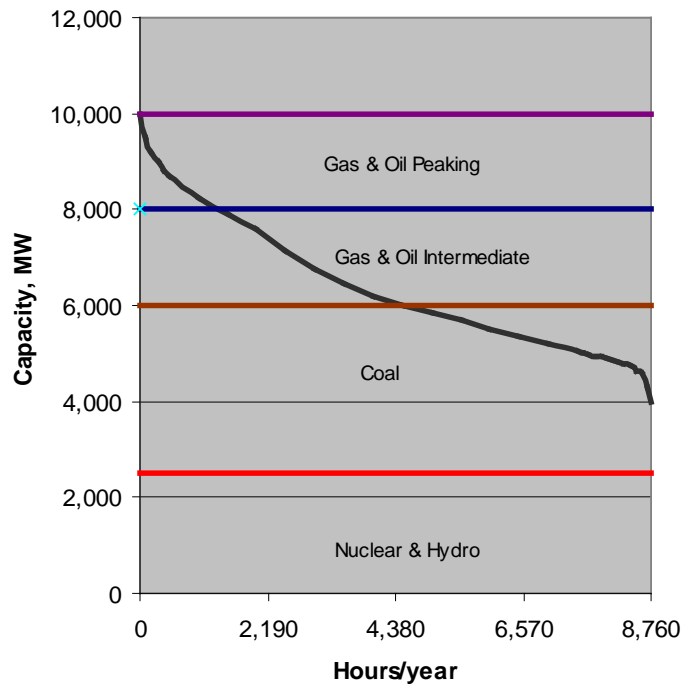

Generators are dispatched in order of operating cost – lowest to highest:

- The lowest-cost generators (nuclear and hydroelectric) operate whenever they are available. This is illustrated in Figure B-2, which shows that these generators operate continuously over the entire year.
- Coal generation is typically the next-lowest operating cost source of power. While coal plants largely serve as baseload plants, there are periods in which coal power must be scaled back or turned off during periods of low demand. This is indicated in Figure B-2 as the area above the curve and below the 'Coal' zone line. Also, some coal capacity—generally older, less efficient systems—are often used as intermediate sources.
- Natural gas and oil-fired systems typically have the highest operating costs, and therefore operate the fewest number of hours. The generators with the very highest operating costs are typically only used to meet peaking loads. Natural gas combined cycle plants have lower costs and are typically used for intermediate loads (and, in some cases, for baseload generation).

Figure B-3 illustrates the effect of baseload CHP capacity that avoids 1,000 MW of central power generation in the aforementioned hypothetical PCA. For simplicity, it is assumed that the CHP system operates for the entire year even though CHP systems may be offline for two or more weeks a year for planned or unplanned maintenance.

Figure B-3: Marginal Displaced Generation due to 1,000 MW of CHP

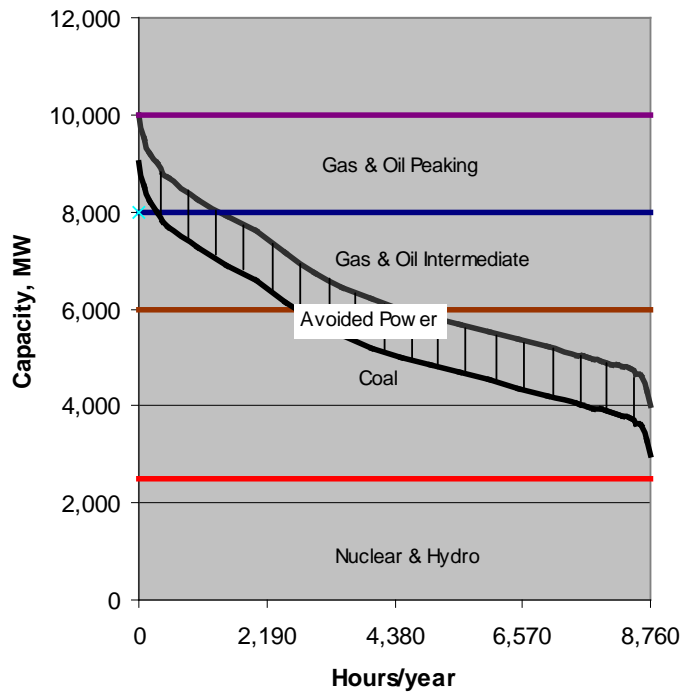

A review of Figure B-3 indicates the following:

- Because the CHP capacity operates continuously, the load duration curve shifts downward to reflect the 1,000 MW reduction in demand for all hours of the year.
- Compared to the base case (the top curve), the additional CHP capacity displaces an equal amount of generation each hour that it runs, shifting the load curve down while it runs. The CHP system therefore displaces power from the last unit of generation that would have been dispatched in each of these hours.
- Depending on the hour, the displaced generator could be a coal, oil, or gas steam unit, a combined cycle generator, a central station peaking turbine, or a reciprocating engine peaking unit.
- Generators with a lower dispatch order, such as nuclear, hydro, and certain renewables, are unaffected. These resources operate whenever they are available so are unaffected by changes in power demand that result from CHP additions.
- The generation (and corresponding emissions) displaced with CHP is therefore the fossil plant output represented by the hash-marked area—a mix of mostly baseload and intermediate generation with some peaking generation.

From Figure B-3, we see that CHP additions typically displace fossil fuel-fired power generation. Therefore, the choice of which eGRID emission factor and heat rate to use for fuel and emissions savings calculations depends on whether the CHP system in question operates as a baseload or non-baseload system. As mentioned previously, CHP is mostly a baseload resource since it operates most of the year, so in most cases the eGRID fossil fuel emissions factor and heat rate should be used. For

those CHP systems with relatively low annual capacity factors as well as with most generation occurring during periods of high system demand, the most appropriate estimate of displaced generation is represented by the eGRID non-baseload emission factor and heat rate.

The graphs in Figure B-4 show the eGRID fossil fuel and non-baseload rates mapped onto the hypothetical load duration curve. The difference between the two categories is largely in the amount of coal-fired power that is included. The all fossil category includes a greater share of coal power whereas the non-baseload category does not include coal-fired generators that do not operate during periods of low demand. The eGRID plant data shows that 65.7 percent of the generation in the all fossil average generation is coal-fired while only 47.7 percent of the generation in the non-baseload measure is coal-fired.

Figure B-4: eGRID Fossil Fuel and Non-baseload Rates Mapped onto Hypothetical Load Curve

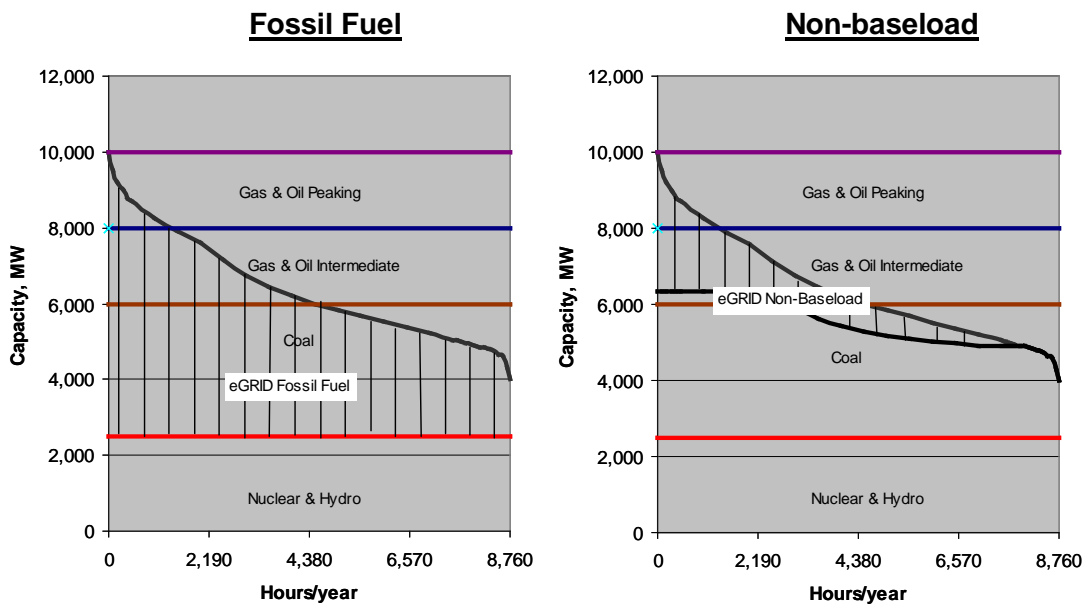

Note: Non-baseload share cannot be mapped exactly onto the load duration curve. An approximation is shown.

B.5 Conclusion

When calculating the fuel and CO₂ emissions savings associated with CHP, the Partnership recommends using the eGRID emissions factors and heat rates for the eGRID subregion where the CHP system is located. Although not as accurate as a detailed dispatch analysis, a comparison of the displaced generation from baseload CHP (Figure B-3) to the all fossil and non-baseload areas (Figure B-4) suggests that the fossil fuel emission factor and heat rate are reasonable estimates for the calculation of displaced emissions and fuel for a baseload CHP system (i.e., greater than 6,500 annual operating hours). Similarly, for non-baseload CHP systems with relatively low annual capacity factors (i.e., less than 6,500 annual operating hours) and with a relatively high generation contribution during periods of high system demand, the most appropriate estimate of displaced generation is represented by the non-baseload emission factor and heat rate. The CHP Emissions Calculator enables users the flexibility to use other emission factor profiles and heat rates as well as geographic aggregation levels, however for cases where there is not a specific reason behind using an alternative rate and aggregation level, the eGRID fossil fuel rates for the appropriate eGRID subregion are recommended.