

EPA 821-R-09-008

Steam Electric Power Generating Point Source Category: Final Detailed Study Report



October 2009

This page intentionally left blank.

CONTENTS

	Page
EXECUTIVE SUMMARY.....	xii
1. INTRODUCTION AND BACKGROUND OF THE STUDY	1-1
2. DATA COLLECTION ACTIVITIES	2-1
2.1 Site Visits.....	2-2
2.2 Wastewater Sampling	2-10
2.3 Questionnaire (“Data Request”)	2-12
2.4 EPA and State Sources.....	2-15
2.4.1 NPDES Permits and Fact Sheets.....	2-16
2.4.2 State Groups and Permitting Authorities	2-16
2.4.3 1974 and 1982 Technical Development Documents for the Steam Electric Power Generating Point Source Category.....	2-16
2.4.4 CWA Section 316(b) - Cooling Water Intake Structures Supporting Documentation and Data.....	2-17
2.4.5 Office of Air and Radiation	2-17
2.4.6 Office of Research and Development	2-18
2.4.7 Office of Solid Waste and Emergency Response	2-18
2.5 Interactions with the Utility Water Act Group	2-18
2.5.1 Database of Power Plant Information	2-19
2.5.2 Wastewater Sampling	2-19
2.5.3 Data Request	2-20
2.5.4 NPDES Form 2C.....	2-20
2.6 Interactions with the Electric Power Research Institute (EPRI).....	2-20
2.7 Department of Energy (DOE).....	2-21
2.8 Other Sources.....	2-22
2.8.1 Wastewater Treatment Equipment Vendors	2-22
2.8.2 U.S. Geological Survey (USGS) COALQUAL Database	2-22
2.8.3 Literature and Internet Searches	2-22
2.8.4 Environmental Groups and Other Stakeholders	2-22
3. STEAM ELECTRIC INDUSTRY PROFILE.....	3-1
3.1 Overview of the Electric Generating Industry	3-1
3.1.1 Demographics of the Electric Generating Industry	3-3
3.1.2 Steam Electric Power Generating Industry.....	3-4
3.2 Steam Electric Process and Wastewater Sources.....	3-12
3.2.1 Fly Ash and Bottom Ash.....	3-15
3.2.2 Flue Gas Desulfurization	3-16
3.2.3 Selective Catalytic Reduction.....	3-17
3.2.4 Condenser Cooling.....	3-18
3.2.5 Low Volume Wastes.....	3-20
3.2.6 Metal Cleaning.....	3-21
3.2.7 Coal Piles	3-21
3.2.8 Landfill Leachate and Runoff.....	3-23

CONTENTS (Continued)

	Page
3.2.9 Combined Cycle Generating Units	3-25
3.2.10 Integrated Gasification Combined Cycle (IGCC).....	3-26
3.2.11 Carbon Capture and Storage	3-29
3.3 Effluent Guidelines for the Steam Electric Power Generating Point Source Category	3-32
4. FLUE GAS DESULFURIZATION SYSTEMS	4-1
4.1 Coal-Fired FGD System Statistics	4-1
4.1.1 Current Coal-Fired FGD System Profile	4-1
4.1.2 Projected Use of FGD Systems at Coal-Fired Plants.....	4-4
4.2 Process Description and Wastewater Generation	4-7
4.2.1 Forced Oxidation FGD Systems	4-7
4.2.2 Inhibited Oxidation FGD System	4-10
4.2.3 Other Types of FGD Systems	4-13
4.3 FGD Wastewater Characteristics.....	4-15
4.4 FGD Wastewater Treatment Technologies.....	4-26
4.4.1 Settling Ponds	4-26
4.4.2 Chemical Precipitation.....	4-27
4.4.3 Biological Treatment	4-30
4.4.4 Constructed Wetlands	4-33
4.4.5 Vapor-Compression Evaporation System.....	4-33
4.4.6 Design/Operating Practices Achieving Zero Discharge	4-36
4.4.7 Other Technologies under Investigation	4-40
4.4.8 Wastewater Treatment System Use in the Coal-Fired Steam Electric Industry.....	4-43
4.5 Comparison of FGD Wastewater Control Technologies.....	4-50
4.6 FGD Pollutant Loads Estimates.....	4-68
4.6.1 FGD Wastewater Treatment Industry Profile.....	4-68
4.6.2 Calculation of Loads.....	4-69
4.6.3 Industry Baseline and Treatment Technology Loads	4-70
5. COAL ASH HANDLING SYSTEMS	5-1
5.1 Fly Ash Handling Operations	5-1
5.2 Bottom Ash Handling Operations.....	5-3
5.3 Ash Transport Water Characteristics	5-5
5.4 Ash Transport Water Treatment Systems	5-11
6. ENVIRONMENTAL ASSESSMENT OF COAL COMBUSTION WASTEWATER	6-1
6.1 Coal Combustion Wastewater Pollutants.....	6-2
6.2 Coal Combustion Wastewater Interactions with the Environment.....	6-7
6.2.1 Discharges to Surface Waters	6-8
6.2.2 Leaching to Groundwater	6-11
6.2.3 Surface Impoundments and Constructed Treatment Wetlands as Attractive Nuisances	6-13

CONTENTS (Continued)

	Page
6.3	Types of Environmental Effects 6-13
6.3.1	Lethal Effects 6-14
6.3.2	Sublethal Effects 6-15
6.3.3	Population and Community Effects 6-16
6.3.4	Human Health Impacts 6-17
7.	PRELIMINARY INVESTIGATION OF OTHER INDUSTRY SEGMENTS 7-1
7.1	Alternative-Fueled Steam Electric Plants 7-2
7.1.1	Demographic Data for Alternative-fueled Steam Electric Plants 7-3
7.1.2	Alternative-Fueled Steam Electric Fuel Types and Processes 7-3
7.1.3	Summary of NPDES Permit Review 7-9
7.2	Industrial Non-Utilities 7-10
7.2.1	Overview of Industrial Non-Utilities 7-11
7.2.2	Demographic Data for Fossil-Fueled Industrial Non-Utilities 7-12
7.2.3	Review of Industrial Non-Utility Discharge Permits 7-18
7.2.4	Contacts with Industrial Non-Utilities 7-20
7.3	Steam and Air Conditioning Supply Plants 7-21
7.3.1	Wastewater Discharge Characterization Data 7-23
7.3.2	NPDES Permit Review 7-23
7.3.3	Contacts with Steam Supply Companies 7-26
7.4	Combination Utility Plants 7-27
7.4.1	Wastewater Discharge Characterization Data 7-28
7.4.2	NPDES Permit Review 7-31
8.	REFERENCES 8-1

LIST OF TABLES

		Page
2-1	Summary of the Detailed Study Site Visits	2-5
2-2	Summary of the Detailed Study Sampling Program.....	2-10
2-3	Analytes Included in the Detailed Study Sampling Program	2-11
2-4	Profile of Coal-Fired Power Plants Operated by Data Request Respondents	2-13
3-1	Distribution of U.S. Electric Generating Plants by NAICS Code in 2002	3-4
3-2	Distribution of Prime Mover Types for Plants Regulated by the Steam Electric Power Generating Effluent Guidelines	3-7
3-3	Distribution of Fuel Types Used by Steam Electric Generating Units.....	3-8
3-4	Types of Fuel Used by Stand-Alone and Combined Cycle Steam Turbines.....	3-10
3-5	Distribution of Fuel Types for Combined Cycle Units Regulated by the Steam Electric Power Generating Effluent Guidelines.....	3-11
3-6	Distribution by Size of Steam Electric Capacity, Plants, and Electric Generating Units Regulated by the Steam Electric Effluent Guidelines.....	3-12
3-7	Coal Pile Runoff Generation Reported for the EPA Data Request	3-22
3-8	Current Effluent Guidelines and Standards for the Steam Electric Power Generating Point Source Category.....	3-33
4-1	Scrubbed Coal-Fired Steam Electric Power Generation as of June 2008.....	4-2
4-2	Characteristics of Coal-Fired Power Plants with Wet FGD Systems	4-3
4-3	Projected Future Use of FGD Systems at Coal-Fired Power Plants.....	4-5
4-4	FGD Scrubber Purge Flow Rates.....	4-16
4-5	Influent to FGD Wastewater Treatment System Concentrations	4-19
4-6	FGD Scrubber Purge Self-Monitoring Data	4-25
4-7	FGD Wastewater Treatment Systems Identified During EPA’s Detailed Study.....	4-44
4-8	Pollutant Concentrations in Sampled Effluent from FGD Wastewater Treatment Systems	4-57
4-9	Monitoring Data: Pollutant Concentrations in Effluent from Settling Ponds.....	4-64

LIST OF TABLES (Continued)

	Page
4-10 Monitoring Data: Pollutant Concentrations in Effluent from Chemical Precipitation Systems.....	4-65
4-11 Monitoring Data: Pollutant Concentrations in Effluent from Biological Treatment Systems	4-67
4-12 Treatment Technology Loads by Model Plant Size.....	4-70
5-1 Fly Ash Handling Practices at Plants Included in EPA’s Combined Data Set.....	5-3
5-2 Bottom Ash Handling Practices at Plants Included in EPA’s Combined Data Set	5-5
5-3 Fly Ash Transport Water Flow Rates	5-6
5-4 Bottom Ash Transport Water Flow Rates from EPA Data Request Responses	5-7
5-5 Ash Pond Influent Concentrations	5-7
5-6 Fly Ash Transport Wastewater Treatment Systems at Plants Included in EPA’s Combined Data Set	5-12
5-7 Bottom Ash Transport Wastewater Treatment Systems at Plants Included in EPA’s Combined Data Set.....	5-13
5-8 Ponds Containing Coal Combustion Residues	5-14
5-9 Ash Pond Effluent Concentrations.....	5-17
6-1 Selected Coal Combustion Wastewater Pollutants	6-3
6-2 Number of Documented Cases of Environmental Impacts from Coal Combustion Wastewater.....	6-7
7-1 Summary of Alternative-Fueled Steam Electric Plants, by Fuel/Energy Source Type	7-4
7-2 Comparison of Available Coal Ash, Municipal Solid Waste Ash, and Wood Ash Composition Data	7-5
7-3 Summary of Fossil-Fueled, Steam Electric Industrial Non-Utilities, by NAICS Code in 2005	7-14
7-4 Distribution of Prime Mover Types Among Fossil-Fueled, Steam Electric Industrial Non-Utilities.....	7-16
7-5 Distribution of Fuel Types Among Fossil-Fueled, Steam Electric Industrial Non- Utilities.....	7-17

LIST OF TABLES (Continued)

	Page
7-6 Steam and Air-Conditioning Supply Plants Identified in <i>DMRLoads2007</i> Database.....	7-24
7-7 Combination Utilities Identified in <i>DMRLoads2007</i> Database.....	7-29

LIST OF FIGURES

		Page
2-1	Locations of Coal-Fired Power Plants Included in EPA Data Collection Activities for the Detailed Study	2-2
2-2	Locations of Coal-Fired Power Plants Included in EPA’s Site Visit and Sampling Program.....	2-4
2-3	Locations of Coal-Fired Power Plants for which Data Request Respondents Provided Technical Information	2-14
3-1	Types of U.S. Electric Generating Plants	3-1
3-2	Steam Electric Process Flow Diagram.....	3-13
3-3	Typical Wet FGD System.....	3-16
3-4	Diagram of a Recirculating Cooling System	3-18
3-5	Diagram of Landfill Leachate and Landfill Runoff Generation and Collection.....	3-24
3-6	Combined Cycle Process Flow Diagram	3-26
3-7	Wabash River ConocoPhillips E-Gas™ Gasification Process	3-28
3-8	AEP’s Chilled Ammonia Process at Mountaineer Power Station	3-31
4-1	Wet FGD Systems at Coal-Fired Power Plants (Current and Projected 2020).....	4-6
4-2	Typical Process Flow Diagram for a Limestone Forced Oxidation FGD System.....	4-8
4-3	Process Flow Diagram for a Lime or Limestone Inhibited Oxidation FGD System.....	4-12
4-4	Distribution of FGD Scrubber Purge Daily Flow Rates	4-17
4-5	Distribution of FGD Scrubber Purge Normalized Daily Flow Rates	4-17
4-6	Process Flow Diagram for a Hydroxide and Sulfide Chemical Precipitation System.....	4-29
4-7	Process Flow Diagram for an Anoxic/Anaerobic Biological Treatment System	4-31
4-8	Process Flow Diagram for a Vapor-Compression Evaporation System.....	4-34
4-9	Distribution of FGD Wastewater Treatment Systems Among Plants Operating Wet FGD Systems.....	4-47
4-10	Comparison of Distribution of FGD Wastewater Treatment Systems by Type of Oxidation System.....	4-48

LIST OF FIGURES (Continued)

	Page
4-11 Distribution of FGD Wastewater Treatment Systems Among Plants that Discharge FGD Wastewater	4-49
4-12A Concentration of Arsenic in FGD Scrubber Purge and Effluent from Chemical Precipitation and Biological Treatment Systems at Belews Creek.....	4-52
4-13A Concentration of Arsenic in FGD Scrubber Purge and Effluent from Settling Pond and Biological Treatment Systems at Roxboro	4-52
4-12B Concentration of Arsenic in Effluent from Chemical Precipitation and Biological Treatment Systems at Belews Creek.....	4-52
4-13B Concentration of Arsenic in Effluent from Settling Pond and Biological Treatment Systems at Roxboro	4-52
4-12C Concentration of Mercury in FGD Scrubber Purge and Effluent from Chemical Precipitation and Biological Treatment Systems at Belews Creek.....	4-53
4-13C Concentration of Mercury in FGD Scrubber Purge and Effluent from Settling Pond and Biological Treatment Systems at Roxboro	4-53
4-12D Concentration of Mercury in Effluent from Chemical Precipitation and Biological Treatment Systems at Belews Creek.....	4-53
4-13D Concentration of Mercury in Effluent from Settling Pond and Biological Treatment Systems at Roxboro.....	4-53
4-12E Concentration of Selenium in FGD Scrubber Purge and Effluent from Chemical Precipitation and Biological Treatment Systems at Belews Creek.....	4-54
4-13E Concentration of Selenium in FGD Scrubber Purge and Effluent from Settling Pond and Biological Treatment Systems at Roxboro	4-54
4-12F Concentration of Selenium in Effluent from Chemical Precipitation and Biological Treatment Systems at Belews Creek.....	4-54
4-13F Concentration of Selenium in Effluent from Settling Pond and Biological Treatment Systems at Roxboro.....	4-54
4-12G Concentration of TDS in FGD Scrubber Purge and Effluent from Chemical Precipitation and Biological Treatment Systems at Belews Creek.....	4-55
4-13G Concentration of TDS in FGD Scrubber Purge and Effluent from Settling Pond and Biological Treatment Systems at Roxboro	4-55
4-14 Estimated Industry-Level FGD Effluent Discharge Loadings By Treatment Scenario.....	4-71

ACRONYMS

AEP	American Electric Power
API	American Petroleum Institute
ASTM	American Society for Testing and Materials
BAT	Best available technology economically achievable
BOD ₅	Biochemical oxygen demand (5-day)
BPJ	Best Professional Judgment
BPT	Best practicable control technology currently available
CaCO ₃	Limestone
Ca(OH) ₂	Lime
CaSO ₃	Calcium sulfite
CaSO ₄	Calcium sulfate
CaSO ₄ • 2H ₂ O	Gypsum
CCR	Coal combustion residues
CFR	Code of Federal Regulations
CO	Carbon monoxide
CO ₂	Carbon dioxide
COD	Chemical oxygen demand
COS	Carbonyl sulfide
CPO	Chlorine-produced oxidants
CWA	Clean Water Act
CWTS	Constructed wetland treatment system
DBA	Dibasic acid (a mixture of glutaric, succinic, and adipic acid)
DCN	Document control number
DMR	Discharge Monitoring Report
DOE	Department of Energy
DRC	Dynamic reaction cell
EIA	Energy Information Administration
EPA	Environmental Protection Agency
EPRI	Electric Power Research Institute
ESP	Electrostatic precipitator
FGD	Flue gas desulfurization
gpd	Gallons per day
gpm	Gallons per minute
gpy	Gallons per year
H ₂	Hydrogen
H ₂ S	Hydrogen sulfide
HEM	Hexane Extractable Material
HERO™	High-efficiency reverse osmosis
HG-AFS	Hydride generation and atomic fluorescence spectrometry
HRSG	Heat recovery steam generator
ICIS	Integrated Compliance Information System
IGCC	Integrated gasification combined cycle
IPM	Integrated Planning Model
MCL	Maximum contaminant level
MDEA	Methyldiethanolamine
mgd	Million gallons per day

MSW	Municipal solid waste
MW	Megawatt
N ₂	Nitrogen
Na ₂ CO ₃	Sodium carbonate
NAICS	Northern American Industry Classification System
NEEDS	National Electric Energy Data System
NETL	National Energy Technology Laboratory
NH ₃	Ammonia
(NH ₄) ₂ SO ₄	Ammonium sulfate
NH ₄ HSO ₄	Ammonium bisulfate
NPDES	National Pollutant Discharge Elimination System
NO	Nitrogen monoxide
NO ₂	Nitrogen dioxide
NO _x	Nitrogen oxides
NSPS	New source performance standards
OAP	Office of Atmospheric Programs
OAQPS	Office of Air Quality Planning and Standards
OAR	Office of Air and Radiation
OECA	Office of Enforcement and Compliance Assistance
ORCR	Office of Resource Conservation and Recovery
ORD	Office of Research and Development
ORSANCO	Ohio River Valley Water Sanitation Commission
OSWER	Office of Solid Waste and Emergency Response
OW	Office of Water
PCS	Permit Compliance System
PPM	Parts per million
PSES	Pretreatment standards for existing sources
PSNS	Pretreatment standards for new sources
SBR	Sequencing batch reactor
SCR	Selective catalytic reduction
SIC	Standard Industrial Classification
SGT-HEM	Silica Gel Treated Hexane Extractable Material
SNCR	Selective non-catalytic reduction
SO ₂	Sulfur dioxide
SO ₃	Sulfur trioxide
TDS	Total dissolved solids
TKN	Total Kjeldahl nitrogen
TMT	Trimercapto-s-triazine
TRI	Toxics Release Inventory
TRO	Total residual oxidants
TSS	Total suspended solids
TVA	Tennessee Valley Authority
TWF	Toxic weighting factor
TWPE	Toxic-weighted pound equivalent
USGS	U.S. Geological Survey
UWAG	Utility Water Act Group

EXECUTIVE SUMMARY

This report summarizes the information collected and analyzed by the United States Environmental Protection Agency (EPA) to review discharges from the steam electric power generating industry and to determine whether the current effluent guidelines for this industry should be revised. EPA's detailed study of wastewater discharges and treatment technologies associated with this industry evaluated a range of waste streams and processes. However, the study ultimately focused largely on discharges associated with coal ash handling operations and wastewater from flue gas desulfurization (FGD) air pollution control systems because these sources comprise a significant fraction of the pollutants discharged by steam electric power plants. In this report, EPA provides an overview of the steam electric power generating industry and its wastewater discharges, and the data collection activities and analyses conducted over the course of EPA's detailed study.

The scope of the study included plants covered by the Steam Electric Power Generating effluent guidelines (40 CFR Part 423), which is a subset of the entire electric generating industry. The Steam Electric Power Generating effluent guidelines apply to wastewater discharges from plants primarily engaged in the generation of electricity for distribution and sale which results primarily from the use of nuclear or fossil fuels in conjunction with a steam-water thermodynamic cycle. During the study, EPA collected data about the industry by performing the following activities: conducting site visits and wastewater sampling episodes at steam electric power plants, distributing a questionnaire to collect data from nine companies (30 coal-fired power plants), reviewing publicly available sources of data, and coordinating with EPA program offices, other government organizations (e.g., state groups and permitting authorities), and industry and other stakeholders.

EPA evaluated several waste streams generated at power plants, including wastewaters from wet FGD systems, fly ash and bottom ash handling, coal pile runoff, condenser cooling, equipment cleaning, and leachate from landfills and impoundments. Additionally, EPA reviewed information on integrated gasification combined cycle (IGCC) and carbon capture technologies. Wastewaters from flue gas mercury control systems (i.e., when the dry mercury capture residues are transported by a wet fly ash handling system to ash ponds) and regeneration of the catalysts used for Selective Catalytic Reduction (SCR) NO_x controls were identified as potential new waste streams that warrant attention; however, EPA was not able to obtain characterization data for these wastes.

The use of wet FGD systems to control SO₂ emissions has increased significantly since the effluent guidelines were last revised in 1982 and is projected to increase substantially in the next decade as power plants take steps to address federal and state air pollution control requirements. FGD wastewaters generally contain significant levels of metals, including bioaccumulative pollutants such as arsenic, mercury, and selenium. The FGD wastewaters also contain significant levels of chloride, total dissolved solids (TDS), total suspended solids (TSS), and nutrients. EPA identified and investigated technologies for treating FGD wastewaters, including settling ponds, chemical precipitation systems, biological treatment systems (anaerobic and aerobic), constructed wetlands, vapor-compression evaporation systems, and other technologies under investigation. From information collected during the study, EPA determined that settling ponds are the most commonly used treatment system for managing FGD wastewater. These ponds can be effective at removing suspended solids and those metals present in the

particulate phase from FGD wastewater; however, they are not effective at removing dissolved metals. Other treatment systems, such as chemical precipitation and certain biological treatment systems, are demonstrated to be effective at removing certain dissolved metals from FGD wastewater. EPA also identified operating/management practices and treatment technologies that are used to reduce the discharge of FGD wastewater, and in some cases, eliminate the discharge completely.

Coal-fired power plants may manage bottom ash and fly ash using either wet or dry handling techniques. For wet handling systems, the plants typically sluice the fly ash and/or bottom ash to a surface impoundment or settling pond where most of the solids settle out of the water. Some plants recycle a portion or all of the settled ash pond effluent, but most plants discharge the pond overflow. Untreated ash transport waters contain significant concentrations of TSS and metals. The treated effluent from ash ponds generally contains low concentrations of TSS; however, metals are still present in the wastewater, predominantly in dissolved form.

Most of the newer electric generating units operate dry fly ash handling systems because of new source performance standards that require "... no discharge of wastewater pollutants from fly ash transport water." [40 CFR Part 423.15] These dry fly ash handling systems use a vacuum or blower to transport the fly ash to a storage silo where it is typically sold for beneficial use or landfilled. The dry bottom ash handling process typically consists of collecting the bottom ash in a quench water bath and conveying it out of the boiler to a dewatering pile.

FGD and ash transport wastewaters, as well as other coal combustion wastewaters, contain pollutants that can have detrimental impacts to the environment. EPA reviewed publicly available data to identify documented cases where environmental impacts were attributable to releases from surface impoundments or landfills containing coal combustion residues. EPA determined that there are a number of pollutants present in wastewaters generated at coal-fired power plants that can impact the environment, including metals (e.g., arsenic, selenium, mercury), TDS, and nutrients. The primary routes by which coal combustion wastewater impacts the environment are through discharges to surface waters, leaching to ground water, and by surface impoundments and constructed wetlands acting as attractive nuisances that increase wildlife exposure to the pollutants contained in the systems. EPA found the interaction of coal combustion wastewaters with the environment has caused a wide range of environmental effects to aquatic life.

As part of the study, EPA also investigated other electric power and steam generating activities that are similar to the processes regulated for the Steam Electric Power Generating Point Source Category, but which are not subject to the effluent guidelines. Such activities include electric generating units fueled by non-fossil or non-nuclear fuels (e.g., municipal solid waste, biomass), electric generating units at industrial facilities (e.g., chemical plants, petroleum refineries), plants that produce steam for distribution and/or sale but do not generate electric power, and facilities that provide a combination of electric power and other utility services. EPA compared the volume and characteristics of wastewaters generated by these activities to the plants regulated by the Steam Electric effluent guidelines and determined that these processes may generate similar types of wastewaters in terms of pollutants present; however, the volume of the wastewaters generated are much smaller than those generated at plants regulated by the effluent guidelines.

1. INTRODUCTION AND BACKGROUND OF THE STUDY

This report summarizes the information collected and analyzed by the United States Environmental Protection Agency (EPA) to review discharges from steam electric power generating facilities and to determine whether the current wastewater discharge regulations for these operations should be revised. EPA's review of wastewater discharges and treatment technologies evaluated a range of waste streams and processes, but has focused primarily on coal ash ponds and wastewater from flue gas desulfurization (FGD) air pollution control systems because these sources comprise a significant fraction of the pollutants discharged by steam electric power plants. In this report, EPA provides an overview of the steam electric power generating industry and its wastewater discharges, and the data collection activities and analyses conducted over the course of the study. Much of the information in this report is associated with the processes, wastewaters, and pollution controls for fly ash, bottom ash, and FGD wastes.

The Steam Electric Power Generating effluent limitations guidelines and standards (referred to in this report as "effluent guidelines") apply to a subset of the electric power industry, namely those plants "primarily engaged in the generation of electricity for distribution and sale which results primarily from a process utilizing fossil-type fuel (coal, oil, or gas) or nuclear fuel in conjunction with a thermal cycle employing the steam water system as the thermodynamic medium." The effluent guidelines are codified in the Code of Federal Regulations (CFR) at Title 40, Part 423 (40 CFR Part 423). EPA's most recent revisions to the effluent guidelines for this industry sector were promulgated in 1982 (see 47 Fed. Reg. 52290; November 19, 1982).

EPA is required by section 304 of the Clean Water Act (CWA) to periodically review all effluent guidelines to determine whether revisions are warranted. In addition, section 304(m) of the CWA requires EPA to develop and publish a biennial plan that establishes a schedule for the annual review and revision of national effluent guidelines required by section 304(b) of the CWA. EPA last published an Effluent Guidelines Program Plan in 2008 [73 Fed. Reg. 53218; September 15, 2008], in which EPA discussed the status of the detailed study of the steam electric power generating industry.

EPA first identified this industry for study during the 2005 annual review of effluent guidelines. At that time, publicly available data reported through the National Pollutant Discharge Elimination System (NPDES) permit program and the Toxics Release Inventory (TRI) indicated that this industry ranked high in discharges of toxic and nonconventional pollutants [U.S. EPA, 2005b]. Because of these findings, EPA initiated a more detailed study of this category to determine if the effluent guidelines should be revised.

During the detailed study, EPA investigated whether pollutant discharges reported under these programs accurately reflected current discharges for the Steam Electric Power Generating Point Source Category, including those associated with recent process and technology changes being implemented by the industry. Additionally, EPA evaluated certain electric power and steam generating activities that are similar to the processes regulated for the Steam Electric Power Generating Point Source Category, but that are not currently subject to effluent guidelines. EPA found that the existing publicly available data were insufficient to fully evaluate the industry's discharges. To fill these data gaps, EPA collected information on wastewater characteristics and treatment technologies through site visits, wastewater sampling, a data

request that was sent to a limited number of companies, and various secondary data sources (see Chapter 2 for more detail about data collection activities).

EPA focused efforts for these data collection activities on certain discharges from coal-fired steam electric power plants (referred to in this report as “coal-fired power plants”). Specifically, these activities focused on: (1) characterizing the mass and concentrations of pollutants in wastewater discharges from coal-fired power plants; (2) identifying the pollutants that comprise a significant portion of the category's toxic-weighted pound equivalent (TWPE) discharge estimate and the corresponding industrial processes responsible for the release of these pollutants; and (3) evaluating process changes and treatment technologies available for reducing these pollutant discharges. EPA's review determined that most of the toxic loadings for this category are associated with metals and certain other constituents, such as selenium, present in wastewater discharges, and that the waste streams contributing the majority of these pollutants are associated with ash handling and wet FGD systems. Other potential sources of these pollutants include coal pile runoff, metal cleaning wastes, coal washing, leachate from landfills and wastewater impoundments, and certain low-volume wastes.

EPA evaluated pollution prevention practices and reviewed examples of water recycle/reuse to identify opportunities to address water quality and water quantity issues. Information was compiled for wastewaters generated by emerging technologies such as carbon capture/sequestration and coal gasification.

EPA also assessed available information on plants that are not currently regulated by the Steam Electric Power Generating effluent guidelines but that use a steam cycle to generate electricity, such as steam electric generating units at industrial facilities and plants that use non-fossil and non-nuclear fuel. Examples of such fuels include wood wastes, landfill methane, and municipal solid wastes.

Throughout the study, EPA's Office of Water (OW) coordinated efforts with ongoing research and activities being undertaken by other EPA offices, including the Office of Research and Development (ORD), the Office of Solid Waste and Emergency Response (OSWER), and the Office of Air and Radiation (OAR), specifically the Office of Air Quality Planning and Standards (OAQPS) and the Office of Atmospheric Programs (OAP). EPA also exchanged information with state NPDES permitting authorities about the characteristics of power plant wastewater, the availability and implementation of treatment technologies, and water quality concerns.

This report, *Steam Electric Power Generating Point Source Category: Final Detailed Study Report* (EPA-821-R-09-008; DCN 06390), documents the data and information that EPA has collected over the course of the detailed study. For additional information about the progression of the detailed study since its inception, see the interim reports supporting the 2006 and 2008 Effluent Guidelines Program Plans: the *Interim Detailed Study Report for the Steam Electric Power Generating Point Source Category* (EPA-821-R-06-015; November 2006) [U.S. EPA, 2006e] and the *Steam Electric Power Generating Point Source Category: 2007/2008 Detailed Study Report* (EPA-821-R-08-011; DCN 05516) [U.S. EPA, 2008e], respectively.

This report is organized into the following chapters:

- Chapter 2 discusses the data sources used in the detailed study;
- Chapter 3 presents a profile of the steam electric power generating industry, including demographic data, a discussion of the steam electric process and wastewaters generated, and a discussion of the Steam Electric Power Generating effluent guidelines;
- Chapter 4 discusses FGD operations at coal-fired power plants, specifically their current use in the industry, their operating characteristics and wastewater generation, potential control technologies for FGD wastewater, and EPA's pollutant load estimates associated with the discharge of FGD wastewaters;
- Chapter 5 discusses ash handling operations at coal-fired power plants, the wastewater generated, and ash wastewater treatment;
- Chapter 6 discusses the environmental effects of coal combustion wastewaters;
- Chapter 7 discusses plants and processes that are not regulated by the Steam Electric Power Generating effluent guidelines, but that use a steam cycle to generate electricity; and
- Chapter 8 presents the references cited in this report.

2. DATA COLLECTION ACTIVITIES

EPA collected and evaluated information from various sources in the course of conducting the detailed study of the steam electric power generating industry. EPA used these data to develop an industry profile, determine wastewater characteristics and potential pollution control technologies, review the potential pollutant load reductions and costs associated with certain treatment technologies, and review environmental impacts associated with discharges from this industry. This section discusses the following data collection activities:

- Site visits, including the site selection process, characteristics of the sites visited, and their locations;
- Wastewater sampling, including information about and the locations of plants sampled, types of samples collected, analytes included in the sampling program, and analytical methods used;
- Industry questionnaire, including the characteristics and location of plants responding to the questionnaire, and a description of the data request instrument;
- Coordination and informal consultations with EPA program offices, EPA regional offices, and state permitting agencies, including information collected from Agency databases;
- Interactions with UWAG, including input from and coordination with UWAG on sampling, site visits, and other data;
- Interactions with EPRI, including input from EPRI on EPA's wastewater sampling and questionnaire activities;
- Use of Department of Energy (DOE) data, including the use of data collected by the Energy Information Administration; and
- Other data sources.

As described in Chapter 1, EPA focused most efforts for the detailed study on certain discharges from coal-fired power plants, including FGD system wastes and ash handling wastes. Figure 2-1 shows the locations of coal-fired power plants at which EPA conducted site visits, collected samples of wastewater, or obtained technical information via the questionnaire.

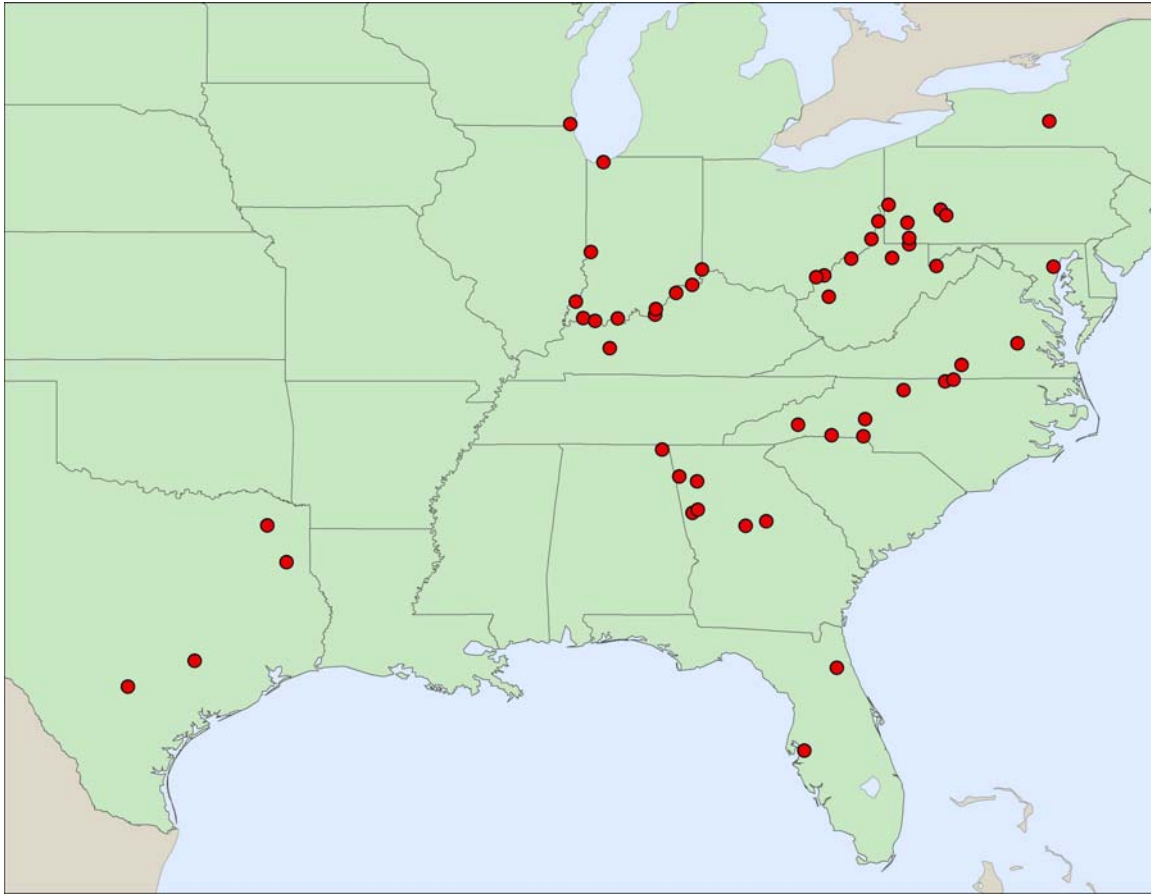

Figure 2-1. Locations of Coal-Fired Power Plants Included in EPA Data Collection Activities for the Detailed Study

2.1 Site Visits

EPA conducted a site visit program to gather information on the types of wastewaters generated by coal-fired power plants, and the methods of managing these wastewaters to allow for recycle, reuse, or discharge. EPA focused data gathering activities primarily on FGD wastewater treatment and management of ash transport water because the FGD and ash transport water stream are the primary sources of metal discharges from the industry. EPA conducted 34 site visits at steam electric power generating plants in 14 states between December 2006 and April 2009.

The purpose of the site visits was to collect information about each site's electric generating processes, wastewater management practices and treatment technologies, and to evaluate each plant for potential inclusion in the sampling program. To identify potential candidate plants for visits, EPA began by compiling a list of U.S. coal-fired power plants believed to operate wet FGD systems, based on information from EPA's Office of Air and Radiation and data provided by the Utility Water Act Group. EPA used the Utility Water Act Group data in conjunction with information from other sources, including publicly available plant-specific information and state and regional permitting authorities.

From its data collection activities, EPA identified 108 plants that as of June 2008 were operating one or more wet FGD systems.¹

EPA considered the following characteristics to select plants for site visits (not listed in any priority order):

- Coal-fired boilers;
- Type of coal;
- Wet FGD system, including:
 - Type of scrubber,
 - Sorbent used,
 - Year operation began,
 - Chemical additives used,
 - Forced oxidation process,
 - Water cycling, and
 - Solids removal process.
- FGD wastewater treatment system;
- Selective catalytic reduction (SCR) and/or selective non-catalytic reduction (SNCR) NO_x controls;
- Ash handling systems;
- Ash treatment system; and
- Advanced flue gas mercury controls.

Using these characteristics, EPA identified plants to contact in order to obtain more detailed information about their operations. From the information obtained during these contacts, EPA selected plants for site visits. Plant conditions, such as type of FGD system and whether target waste streams are segregated or commingled with other wastes, influenced the plant selection process.

The specific objectives of these site visits were to:

- Gather general information about each plant's operations;
- Gather information on pollution prevention and wastewater treatment/operations;
- Gather plant-specific information to develop sampling plans; and
- Select and evaluate potential sampling points.

¹ See the memorandum in the docket entitled "Development of the Current and Future Industry Profile for the Steam Electric Detailed Study," dated 10/9/2009 [ERG, 2009r] for details on the development of this list. The total number of plants operating wet FGD systems is dynamic; additional plants have started operating FGD systems since EPA compiled this profile or are currently in the process of installing FGD systems.

Based on information obtained during these site visits, EPA selected six plants for wastewater sampling episodes, which are discussed further in Section 2.2.

Table 2-1 presents information on the characteristics of each plant visited during the site visit program. The geographic distribution of these plants is illustrated by the map in Figure 2-2.

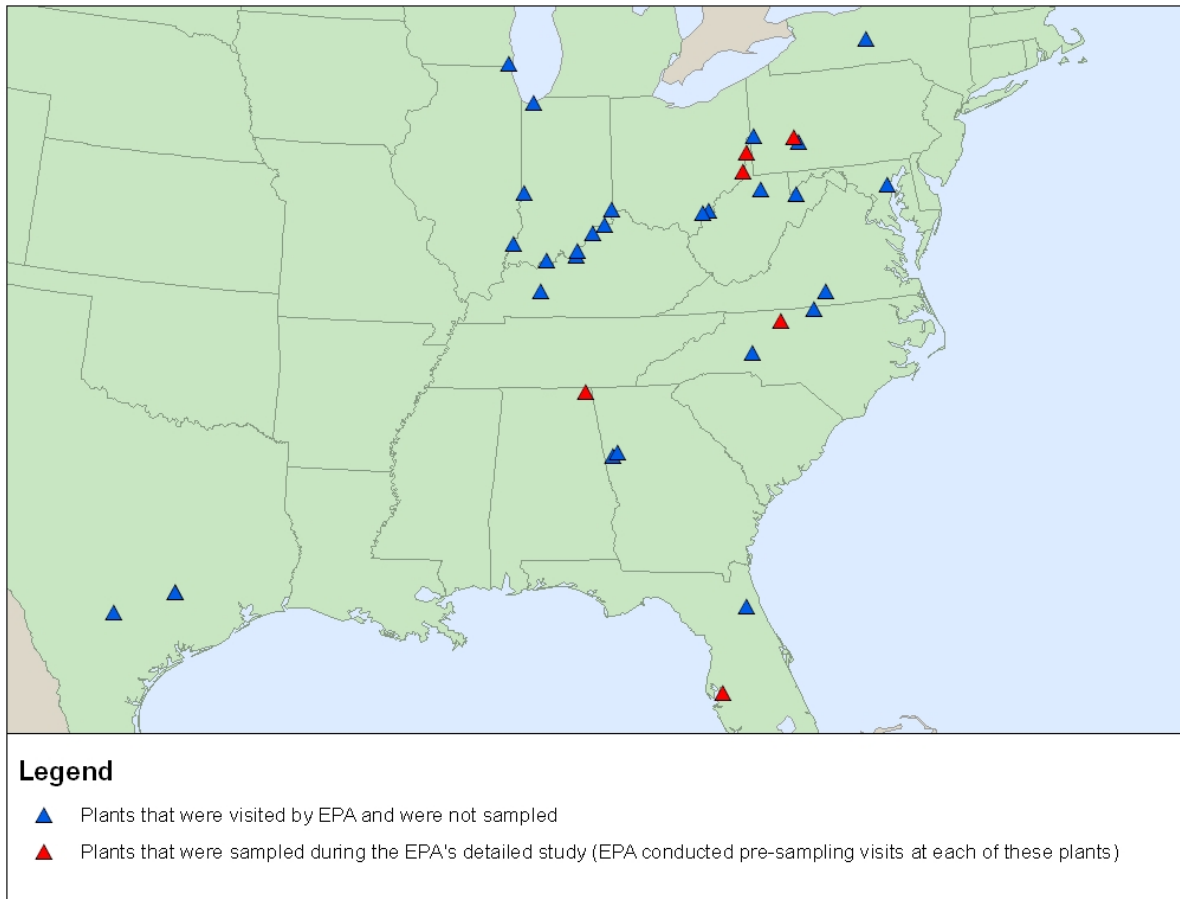

Figure 2-2. Locations of Coal-Fired Power Plants Included in EPA's Site Visit and Sampling Program

Table 2-1. Summary of the Detailed Study Site Visits

Plant Name Location (Reference)	Month/Year of Site Visit	Coal Type	FGD System ^a	Year FGD Began Operation	SCR/SNCR NO_x Control	Type of FGD Wastewater Treatment System	Fly Ash Handling (wet/dry)
Yates Georgia [ERG, 2007f]	December 2006	Eastern Bituminous	Jet-bubbling reactor, limestone forced oxidation, no additives (1 unit)	1992	No SCR or SNCR	Settling pond	Wet
Wansley Georgia [ERG, 2007e]	December 2006	Eastern Bituminous	Installation in progress during site visit	NA	SCRs on 2 units	Visited prior to installation of settling pond	Wet
Widows Creek Alabama [ERG, 2007h; ERG, 2007k]	December 2006	Eastern Bituminous	Spray tower, limestone forced oxidation ^b , no additives (2 units)	1977 and 1981	SCRs on both units with FGD	Settling pond	Wet
Conemaugh Pennsylvania [ERG, 2007l]	February 2007	Eastern Bituminous	Spray tower, limestone forced oxidation, dibasic acid additive (2 units)	1994 and 1995	No SCR or SNCR	Chemical precipitation (lime addition, ferric chloride, sodium sulfide, polymer), followed by aerobic sequencing batch reactors	Dry
Homer City Pennsylvania [ERG, 2007i; ERG, 2007j]	February 2007	Eastern Bituminous	Spray tower, limestone forced oxidation, formic acid additive (1 unit)	2001	SCRs on 3 units	Chemical precipitation (lime addition, ferric chloride, polymer), followed by aerobic biological reactor	Dry
Pleasant Prairie Wisconsin [ERG, 2007d]	April 2007	Subbituminous (Powder River Basin)	Spray tower, limestone forced oxidation, no additives (2 units)	2006 and 2007	SCRs on both units with FGD	Chemical precipitation (lime addition, organosulfide, ferric chloride, polymer)	Dry
Bailly Indiana [Hall, 2007]	April 2007	Bituminous (75%), Eastern Bituminous (25%)	Spray tower, limestone forced oxidation, no additives (2 units)	1992	SCR on one of the units with FGD	Polymer addition only; no pH adjustment	Dry
Seminole Florida [Jordan, 2007]	April 2007	Eastern Bituminous, also burns petroleum coke as a small percentage (up to 30%)	Spray tower, limestone forced oxidation, dibasic acid additive (2 units)	1984	No SCR or SNCR	Chemical precipitation (lime addition, ferrous chloride, polymer)	Dry
Big Bend Florida [ERG, 2007b; ERG, 2007g]	April 2007	Eastern Bituminous, also burns petroleum coke as a small percentage (typically 1-2%; 5% maximum)	Two scrubbers for 4 units (2 units per scrubber): (1) spray tower, limestone forced oxidation, and (2) double loop spray tower, limestone forced oxidation, dibasic acid additive	1985 (double loop) and 2000 (spray tower)	SCR on one unit; will install SCR on the other units over the next 3 years	Chemical precipitation (lime addition, ferric chloride, polymer)	Dry

Table 2-1. Summary of the Detailed Study Site Visits

Plant Name Location (Reference)	Month/Year of Site Visit	Coal Type	FGD System ^a	Year FGD Began Operation	SCR/SNCR NO_x Control	Type of FGD Wastewater Treatment System	Fly Ash Handling (wet/dry)
Cayuga New York [Jordan, 2008b]	May 2007	Eastern Bituminous	Spray tower, limestone forced oxidation, formic acid additive (2 units)	1995	SCR on 1 unit	Chemical precipitation (lime addition, ferric chloride, polymer)	Dry
Mitchell West Virginia [ERG, 2007o]	May 2007	Eastern Bituminous	Spray tower, limestone forced oxidation, no additives (2 units)	NA	SCRs on both units with FGD	Chemical precipitation (lime addition, ferric chloride, polymer)	Wet
Cardinal Ohio [ERG, 2007n]	May 2007	Subbituminous	Installation in progress during site visit	NA	SCRs on 3 units	Currently being installed	Wet
Bruce Mansfield Pennsylvania [U.S. EPA, 2008d]	October 2007	Bituminous	Venturi scrubber, magnesium-enhanced lime, inhibited oxidation (2 units); horizontal spray scrubber, magnesium-enhanced lime, inhibited oxidation (1 unit); additional forced oxidation as separate process for all 3 units	1976, 1977, and 1980	SCRs on 3 units	Surface impoundment (settling)	Wet
Roxboro North Carolina [Jordan, 2008a]	March 2008	Eastern Bituminous	Tray tower, limestone forced oxidation, no additive (2 units operating, 2 more units planned for 2008)	2007 and 2008)	SCRs on 4 units	Settling pond followed by a anaerobic/anoxic biological treatment system for removal of metals and nutrients	Dry (but wet capability)
Belews Creek North Carolina [ERG, 2008h]	March 2008	Eastern Bituminous	Spray tower, limestone forced oxidation (1 unit operating, 1 more unit planned for 2008)	2008	SCRs on 2 units	Chemical precipitation followed by anaerobic/anoxic biological treatment for removal of metals and nutrients followed by a constructed wetland treatment system	Dry (but wet capability)
Marshall North Carolina [ERG, 2008i]	March 2008	Eastern Bituminous, additionally burns a small percentage of South American coal (2%)	Spray tower, limestone forced oxidation. (3 scrubbers for 4 units)	2006 and 2007	SNCRs on 4 units	Clarifier followed by a constructed wetland treatment system	Dry (but wet capability)
Mount Storm West Virginia [ERG, 2008p]	September 2008	Bituminous	Spray tower, limestone forced oxidation, no additives (3 units)	1995 and 2002	SCRs on 3 units	No FGD wastewater discharged; FGD solids landfilled (leachate from FGD landfill treated by settling ponds and discharged)	Dry

Table 2-1. Summary of the Detailed Study Site Visits

Plant Name Location (Reference)	Month/Year of Site Visit	Coal Type	FGD System ^a	Year FGD Began Operation	SCR/SNCR NO_x Control	Type of FGD Wastewater Treatment System	Fly Ash Handling (wet/dry)
Harrison West Virginia [ERG, 2009c]	September 2008	Eastern Bituminous	Spray tower, magnesium-enhanced lime inhibited oxidation (2 units); emulsified sulfur added	1994	SCRs on 3 units	No FGD wastewater discharged; FGD solids landfilled (leachate from lined portion of FGD landfill flows into settling ponds and leachate from unlined portion of FGD landfill is transferred to a constructed wetlands treatment system and then discharged)	Dry
Mountaineer West Virginia [ERG, 2009u]	September 2008	Eastern Bituminous	Spray tower, limestone forced oxidation, no additives (1 unit)	2007	SCR on 1 unit	Chemical precipitation (lime addition, polymer, ferric chloride)	Dry
Gavin Ohio [ERG, 2009b]	September 2008	Eastern Bituminous	Spray tower, magnesium-enhanced lime inhibited oxidation (2 units); emulsified sulfur added	1994 and 1995	SCRs on 2 units	No FGD wastewater discharged; FGD solids landfilled (leachate from FGD landfill collected in settling ponds and discharged)	Dry
Deely Texas [ERG, 2009o]	October 2008	NA	Considering dry and limestone-forced oxidation wet scrubbers (2 units)	Planned for 2012 and 2013	SCRs planned on 2 units by 2015	To be determined	Dry
Clover Virginia [ERG, 2009d]	October 2008	Eastern Bituminous	Spray tower, limestone forced oxidation (2 units)	1995 and 1996	SNCRs on both units	No FGD wastewater discharged; FGD solids landfilled	Dry
JK Spruce Texas [ERG, 2009o]	October 2008	Subbituminous (Powder River Basin)	Spray tower, limestone natural oxidation, no additives (1 unit - but plans to convert to limestone forced oxidation in future); spray tower, limestone forced oxidation, no additives (1 unit planned)	1992, 2010	SCR on 1 unit; SCR expected by 2015 on other unit	Settling pond followed by a clarifier with polymer addition.	Dry
Fayette Power Project/Sam Seymour Texas [ERG, 2009p]	October 2008	Subbituminous (Powder River Basin)	Spray tower, limestone forced oxidation, no additives (1 unit operating, 2 units planned)	1988 (and 2 units planned for 2010)	No SCR	No FGD wastewater discharged	Dry

Table 2-1. Summary of the Detailed Study Site Visits

Plant Name Location (Reference)	Month/Year of Site Visit	Coal Type	FGD System ^a	Year FGD Began Operation	SCR/SNCR NO_x Control	Type of FGD Wastewater Treatment System	Fly Ash Handling (wet/dry)
Ghent <i>Kentucky</i> [ERG, 2009g]	December 2008	Eastern Bituminous, previously would occasionally burn 50/50 mixture of Eastern Bituminous/Powder River Basin in 2 units	Tray tower, limestone forced oxidation, no additives currently used (DBA capability) (3 units operating, 1 unit planned)	1994, 2007, 2008, (and 1 unit planned for 2009)	SCRs on 2 units	Settling pond	Wet
Trimble County <i>Kentucky</i> [ERG, 2009j]	December 2008	Eastern Bituminous in one unit; 70/30 mixture of Eastern Bituminous/Powder River Basin for planned unit	Spray tower, limestone forced oxidation, no additives currently used (DBA capability for operating unit) (1 unit operating, 1 unit planned)	1990 (1 unit planned for 2010)	SCRs on 2 units	No FGD wastewater discharged; FGD solids are stored in a settling pond (plant completely reuses the wastewater in the settling pond) [Note: configuration of treatment system will change in 2010 to settling pond when new unit begins operation]	Wet and dry capability
Cane Run <i>Kentucky</i> [ERG, 2009h]	December 2008	Eastern Bituminous	Spray tower, lime inhibited oxidation (2 units); spray tower, lime inhibited oxidation and sodium carbonate dual-alkali (1 unit); emulsified sulfur added to all three units	1976, 1977, and 1978	No SCRs	Settling pond	Dry
Mill Creek <i>Kentucky</i> [ERG, 2009i]	December 2008	Eastern Bituminous	Tray tower, limestone forced oxidation (4 units)	1978, 1980, 1981, and 1982	SCRs on 2 units	Settling pond	Dry (but wet capability)
Brandon Shores <i>Maryland</i> [ERG, 2009k]	January 2009	Eastern Bituminous	Tray tower, limestone forced oxidation (planned for 2 units)	1 unit planned for 2009 and one planned for 2010	SCRs on 2 units	Chemical precipitation (lime addition, organosulfide, ferric chloride); aerobic/anoxic biological sequencing batch reactors	Dry
Kenneth C Coleman <i>Kentucky</i> [ERG, 2009m]	February 2009	Bituminous	Tray tower, limestone forced oxidation (1 scrubber for 3 units)	2006	No SCRs	Clarifier and filter	Wet

Table 2-1. Summary of the Detailed Study Site Visits

Plant Name Location (Reference)	Month/Year of Site Visit	Coal Type	FGD System ^a	Year FGD Began Operation	SCR/SNCR NO_x Control	Type of FGD Wastewater Treatment System	Fly Ash Handling (wet/dry)
Gibson <i>Indiana</i> [ERG, 2009e]	February 2009	Bituminous	Spray tower, limestone forced oxidation for 3 units (Units 1, 2, and 3); horizontal flow, limestone forced oxidation for 1 unit (Unit 5); spray tower, limestone inhibited oxidation for 1 unit (emulsified sulfur added) (Unit 4)	1982, 1995, 2006, and 2007	No information	No FGD wastewater discharged from the Unit 4 and 5 FGD systems. Chemical precipitation (ferric chloride and polymer) treatment for the FGD wastewater from Units 1, 2, and 3. The treated FGD wastewater is sent to the cooling lake and recycled for plant use. The plant is constructing a system to inject the treated FGD wastewater into underground geological formations.	Wet (3 units) and dry (2 units)
Paradise <i>Kentucky</i> [ERG, 2009l]	February 2009	Bituminous	Spray tower, limestone forced oxidation (3 units)	1982 (2 units) and 2006 (1 unit)	SCRs on 2 units	Settling pond	Wet
Wabash River <i>Indiana</i> [ERG, 2009f; ERG, 2009v]	February 2009	Petroleum coke (IGCC unit); Bituminous (5 pulverized coal units)	No FGD systems	NA	No SCR or SNCR	NA	Wet (but converting one unit to dry)
Miami Fort <i>Ohio</i> [ERG, 2009r]	April 2009	Eastern Bituminous	Spray tower, limestone forced oxidation (2 units); no additives	2007	SCRs on 2 units	Chemical precipitation (lime addition, organosulfide, ferric chloride, polymer)	Wet (1 unit) and dry (2 units)

a – The number of generating units in parentheses is also the number of FGD systems unless otherwise specified.

b – The FGD system is a once-through system in which the gypsum slurry in the scrubber reaction tank is not recycled back through the scrubber, but rather, is continuously discharged.

NA – Not available.

Note: The table reflects the data collected at the time of each individual site visit and does not reflect changes that have occurred since the site visits were conducted.

2.2 Wastewater Sampling

EPA conducted a sampling program to characterize untreated wastewaters generated by coal-fired power plants, as well as to evaluate treatment technologies and best management practices for reducing pollutant discharges. EPA developed a “generic” sampling plan [ERG, 2007c] to provide general sampling procedures and methods that were followed when conducting sampling activities. The generic sampling plan, in combination with plant-specific sampling plans, served as a guide to the field sampling crew and provided procedural information for plant personnel.

Between July 2007 and October 2008, EPA collected and analyzed samples to characterize wastewater streams at six coal-fired power plants. Specifically, EPA characterized wastewater streams associated with wet FGD systems and ash handling operations and evaluated the capability of various types of treatment systems to remove metals and other pollutants of concern prior to discharge. Table 2-2 presents information on the plants selected for the sampling program. The plant locations are shown in Figure 2-2.

Table 2-2. Summary of the Detailed Study Sampling Program

Plant Name	Sampling Episode No.	Date of Sampling Episode	Type of Samples Collected				
			FGD Treatment System			Ash Pond	
			Influent	In-Process	Effluent	Influent	Effluent
Big Bend	6547	July 2007	✓		✓		
Homer City	6548	August 2007	✓	✓	✓		✓ (bottom ash)
Widows Creek	6549	September 2007	✓		✓	✓ (fly + bottom)	✓ (fly + bottom)
Mitchell	6550	October 2007	✓	✓	✓		✓ (fly ash + other)
Cardinal	6551	October 2007				✓ (fly ash)	✓ (fly ash)
Belews Creek	6557	October 2008	✓	✓	✓		

The sampling program consisted of one-day or two-day sampling episodes at the six selected plants. EPA prepared sampling episode reports for each plant, describing the specific sample points, the sample collection methods used, the field quality control samples collected, and the laboratory analytical results. The reports for these six episodes are in the docket for the Preliminary 2010 Effluent Guidelines Program Plan [ERG, 2008l; ERG, 2008m; ERG, 2008k; ERG, 2008n; ERG, 2008o; ERG, 2009q].

Table 2-3 lists the analytes for which EPA collected sampling data. The analytes listed generally reflect the expected characteristics of coal-fired power plant wastewaters, including contributions from coal, scrubber sorbents, treatment chemicals, and other sources. Several analytes, such as yttrium, were included in the analyte list because of pre-established laboratory contracts and perhaps would not have been individually selected for inclusion.

Table 2-3. Analytes Included in the Detailed Study Sampling Program

Parameter	Method Number (Sampling Episodes 6547, 6548, 6549, 6550, 6551)	Method Number (Sampling Episode 6557)
Classicals		
Biochemical Oxygen Demand (5-day) (BOD ₅)	SM 5210 B	SM 5210 B
Chemical Oxygen Demand (COD)	^a	SM 5220 C
Total Suspended Solids (TSS)	SM 2540 D	SM 2540 D
Total Dissolved Solids (TDS)	SM 2540 C	SM 2540 C
Sulfate	ASTM D516-90	EPA 300.0
Chloride	SM 4500–Cl–C	EPA 300.0
Ammonia as Nitrogen	SM 4500—NH ₃ F (18th ed.)	EPA 350.1
Nitrate/Nitrite as Nitrogen	SM 4500-NO ₃ H ^b	EPA 353.2
Total Kjeldahl Nitrogen (TKN)	SM 4500—N, C	EPA 351.2
Total Phosphorus	EPA 365.3 (Rev 1978)	EPA 365.2
Hexane Extractable Material (HEM)	EPA 1664A	EPA 1664A
Silica Gel Treated Hexane Extractable Material (SGT-HEM)	EPA 1664A	EPA 1664A
Metals		
Total and Dissolved Metals (27 Metals: Aluminum, Antimony, Arsenic, Barium, Beryllium, Boron, Cadmium, Calcium, Chromium, Cobalt, Copper, Iron, Lead, Magnesium, Manganese, Mercury, Molybdenum, Nickel, Selenium, Silver, Sodium, Thallium, Tin, Titanium, Vanadium, Yttrium, Zinc)	EPA 200.7 EPA 245.1 EPA 245.5	EPA 200.7 ^c EPA 200.8 ^c EPA 200.8 with DRC ^d
Low-Level Total and Dissolved Metals (11 Metals: Antimony, Arsenic, Cadmium, Chromium, Copper, Lead, Nickel, Selenium, Silver, Thallium, Zinc)	EPA 1638	EPA 1638 EPA 1638 with DRC ^e HG-AFS ^f
Low-Level Total and Dissolved Mercury	EPA 1631E	EPA 1631E
Hexavalent Chromium	ASTM D1687-92	EPA 218.6
Low-Level Hexavalent Chromium	EPA 1636	EPA 1636

a – COD was analyzed only for Sampling Episode 6557.

b – EPA Method 353.2 was used for the nitrate/nitrite analysis for Sampling Episode 6548. Standard Method 4500-NO₃-H was used for Sampling Episodes 6549, 6550, and 6551. Nitrate/nitrite was not analyzed in Sampling Episode 6547 because a laboratory instrument failure delayed analysis until the sample holding time was exceeded.

c – Molybdenum, tin, titanium, and yttrium were not analyzed by EPA Methods 200.7 or 200.8 for Sampling Episode 6557. Additionally, mercury was not analyzed by EPA Method 245.1 for Sampling Episode 6557.

d – Samples were analyzed for arsenic, chromium, iron, manganese, nickel, selenium, vanadium, and zinc using EPA Method 200.8 with a dynamic reaction cell (DRC) instrumentation for Sampling Episode 6557.

e – Samples were analyzed for arsenic, chromium, nickel, selenium, and zinc using EPA Method 1638 with a DRC for Sampling Episode 6557.

f – Samples were analyzed for arsenic and selenium using hydride generation and atomic fluorescence spectrometry (HG-AFS) using Frontier Geosciences Method 055 (modified SM 3114) for Sampling Episode 6557.

During the sampling program, EPA also collected data on the design, operation, and performance of treatment systems at steam electric plants, specifically regarding system design and day-to-day operation. The sampling activities were focused on influent, effluent, and in-process streams for FGD and ash handling wastewater treatment systems. During each sampling

episode, EPA collected engineering information regarding the design and operation of the plant being sampled, such as coal usage, plant capacity, wastewater flow rates, sludge generation rates, and retention times in wastewater treatment process stages. Engineering data collection sheets were completed for each plant.

EPA used data from the sampling program to help identify the pollutants present in wastewater streams generated by or associated with wet ash handling systems and SO₂/NO_x air pollution controls (e.g., wet FGD systems, SCR/SNCR). The data were also used to characterize the performance of wastewater treatment systems.

2.3 **Questionnaire (“Data Request”)**

EPA collected information from a limited number of coal-fired power plants using a questionnaire issued under authority of Section 308 of the Clean Water Act (*Data Request for the Steam Electric Power Generating Industry*), referred to in this report as the “data request” [U.S. EPA, 2007a]. The data request complemented EPA’s site visit and sampling program by obtaining information about wastewater generation rates and management practices for the FGD and ash transport water waste streams, other waste streams not sampled by EPA’s sampling program (e.g., coal pile runoff), and other power plant information as described below.

EPA selected nine power companies to receive the data request based on specific characteristics of plants they operate. These companies all operate coal-fired plants that have wet FGD systems and/or wet fly ash handling systems. Table 2-4 presents a profile of the coal-fired power plants operated by the nine selected companies (referred to in this report as “data request respondents”). As shown in Table 2-4, the data request respondents operated a total of 67 coal-fired power plants and provided technical information for 30 of these coal-fired power plants as instructed by Part B of the data request. These 30 coal-fired power plants (i.e., the “data request plants”) either operated wet FGD systems as of October 2007, and/or were planning to begin constructing wet FGD systems by December 31, 2010. The plants that are most likely to operate FGD systems are those that burn eastern bituminous coal, which has relatively high sulfur content, so the vast majority of the data request plants are located in the eastern United States. Figure 2-3 shows the location of the data request plants.

EPA distributed the data request to the nine selected power companies in May 2007 and received data request responses in August and October 2007². The data requests were divided into two parts: Part A, General Power Company Information; and Part B, Power Plant Technical Information. EPA requested that each power company complete Part A of the data request and to complete Part B of the data request for each coal-fired power plant they operate that meets the following criteria: was in operation in calendar year 2006; and operates at least one wet FGD system and/or is currently constructing/installing (or plans to begin constructing prior to December 31, 2010) at least one wet FGD system.

² EPA received data request responses from each of the nine data request respondents in August 2007. One respondent also provided a Part B response for one data request plant in October 2007.

Table 2-4. Profile of Coal-Fired Power Plants Operated by Data Request Respondents

Company Number	Coal-Fired Power Plants Operated by Data Request Respondents			Plants for which Data Request Respondents Provided Technical Information ^a		
	Total No. of Plants	Number Currently Operating Wet FGD Systems ^b	Number Not Currently Operating Wet FGD Systems, But Planning to Begin Constructing by 12/31/2010 ^b	Total No. of Plants	Number with Segregated FGD Wastewater Treatment System (Operating) ^b	Number with Wet Fly Ash Systems
1	10	3	2	5	0	0
2	6	1	1	2	1	1
3	16	2	1	3	0	1
4	8	1	3	4	1	2
5	10	1	4	6	1	6
6	3	3	0	3	0	3
7	8	1	2	3	1	2
8	4	2	0	2	0	0
9	2	2	0	2	0	2
Total	67	16	13 ^c	30 ^c	4	17

Source: [U.S. EPA, 2008a].

a – Plants within the scope of Part B of the data request.

b – Based on information provided in the data request responses, as of October 2007.

c – EPA received data request technical information for 30 coal-fired power plants. One company initially reported plans to install wet FGD systems at one plant by December 31, 2010; however, during follow-up communications, the company informed EPA that they subsequently decided not to install wet FGD systems as part of the company's long-term air pollution control strategies.

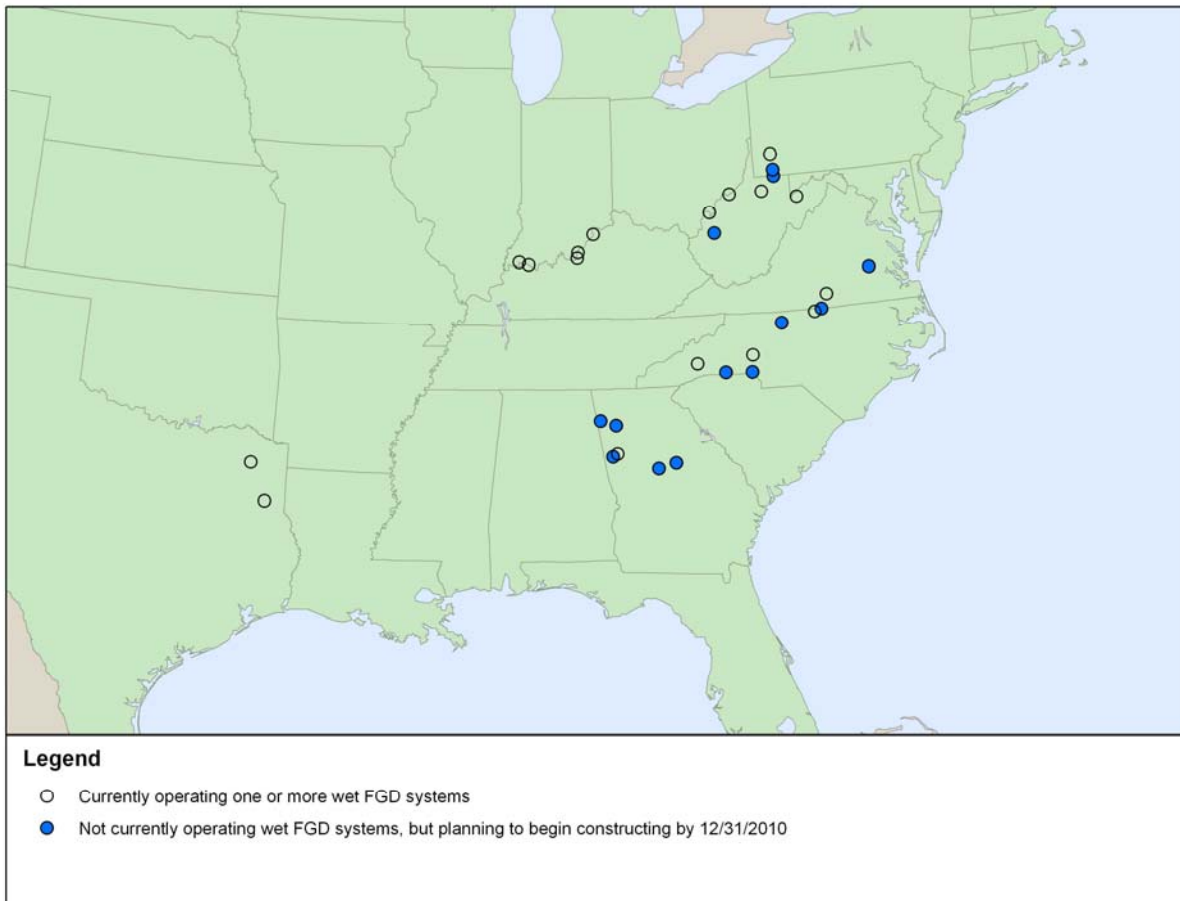

Source: [U.S. EPA, 2008a].

Note: Based on information provided in the data request responses, as of October 2007.

Figure 2-3. Locations of Coal-Fired Power Plants for which Data Request Respondents Provided Technical Information

Part A requested the following: company contact information; corporate structure information; and profile information for the coal-fired power plants that the companies currently operate and that were in operation during 2006. Part B requested the following information:

- General plant information, including address and contact information.
- Steam electric power production information and fuels used for each steam electric unit that the plant operated in 2006.
- Wastewater generation information, including flow rate data, for the following wastewaters: coal pile runoff; coal pulverizer waste streams; wastewaters from ash handling and air pollution control systems (FGD, SCR/SNCR, and enhanced mercury air controls); and cooling water.
- Operation of each wastewater treatment system at each plant and the associated wastewater flow rates; flow rates for untreated wastewaters; and a diagram for each plant including all coal-fired steam electric process operations, wastewater treatment systems, and treated and untreated flows.

- Operation and maintenance cost data for each wastewater treatment system operated in 2006 and capital cost data for each FGD wastewater treatment system constructed between January 01, 1997, and December 31, 2006.
- Monitoring data that the plant collected for any reason during 2006 for coal-fired steam electric wastewater streams that meet certain sample location and analyte criteria.

In developing the data request, EPA worked with industry trade associations and other EPA program offices to develop questions that addressed the needs of the detailed study while minimizing respondent burden. After distributing the data request to the nine data request respondents, EPA provided assistance and clarification regarding the data request questions directly via a help line and indirectly via UWAG.

EPA conducted a technical review of the data request responses to ensure the quality and consistency of the data. Following the technical review of each data request response, EPA communicated with the data request respondents to resolve questions and/or discrepancies found. Once resolved, EPA key-entered the revised data request responses into a database and conducted a quality assurance check of the key-entered data [ERG, 2008j]. A database containing the responses to the data request is included in the docket for the Final 2008 Effluent Guidelines Program Plan. A portion of the information provided by data request respondents was claimed as confidential business information. In these cases, EPA has provided sanitized versions of the data request responses.

2.4 EPA and State Sources

Throughout the detailed study, EPA collected information from the Agency's databases and publications and state groups and permitting authorities, including the following, which are discussed further in the subsections below:

- Information on current permitting practices for the steam electric industry from a review of selected National Pollutant Discharge Elimination System (NPDES) permits and accompanying fact sheets;
- Input from EPA and state permitting authorities regarding implementation of the Steam Electric Power Generating effluent guidelines;
- Background information on the steam electric industry from documents prepared during the development of the Steam Electric Power Generating effluent guidelines;
- Information from a survey of the industry conducted in support of the Clean Water Act Section 316(b) Cooling Water Intake Structures rulemaking;
- Information from EPA's OAR used to predict impacts from environmental policies;
- Information from EPA's ORD characterizing coal combustion residues (CCRs) and the potential leaching of these CCRs from landfills and surface impoundments;
- Information collected by EPA's OSWER regarding surface impoundments or other similar management units that contain CCRs at power plants.

Other data sources include the Permit Compliance System (PCS) and Toxics Release Inventory (TRI) databases, from which EPA obtained initial information on reported pollutant releases from the electric generating industry, and the Office of Enforcement and Compliance Assistance (OECA) Sector Notebook, *Profile of the Fossil Fuel Electric Power Generation Industry* [U.S. EPA, 1997].

EPA's Office of Water has coordinated its efforts with ongoing research and activities being undertaken by other EPA offices, including the Office of Air and Radiation (OAR), the Office of Research and Development (ORD), the Office of Solid Waste and Emergency Response (OSWER), the Office of Enforcement and Compliance Assurance, and EPA regional offices.

2.4.1 NPDES Permits and Fact Sheets

The CWA requires direct dischargers (i.e., industrial facilities that discharge process wastewaters from any point source into receiving waters) to control their discharges according to effluent guidelines and water quality-based effluent limitations included in NPDES permits.

EPA reviewed selected NPDES permits and, where available, accompanying fact sheets to identify the sources of wastewater at steam electric plants and to determine how the wastewaters are currently regulated (i.e., effluent limitations for specific parameters and the basis for selecting the parameters). As part of the NPDES permit review, EPA contacted state permit writers to obtain additional information or clarify permit information.

2.4.2 State Groups and Permitting Authorities

Throughout the detailed study, EPA interacted with states and EPA regional permitting authorities. When contacting and visiting power plants, EPA coordinated with state and regional permit writers. EPA solicited input and suggestions from states and permitting authorities on specific power plant characteristics and implementation of the Steam Electric Power Generating effluent guidelines. EPA hosted a webcast seminar in December 2008 to review information on wastewater discharges from coal-fired power plants for NPDES permitting and pretreatment authorities. The webcast provided an update on EPA's review of the current effluent guidelines (40 CFR Part 423) and presented information on pollutant characteristics and treatment technologies for wastewater from FGD scrubbers. During the webcast, state and interstate approaches for managing steam electric power plant wastewaters were shared by representatives from Wisconsin, North Carolina, and the Ohio River Valley Water Sanitation Commission (ORSANCO).

2.4.3 1974 and 1982 Technical Development Documents for the Steam Electric Power Generating Point Source Category

The 1974 *Development Document for Effluent Limitations Guidelines and New Source Performance Standards for the Steam Electric Power Generating Point Source Category* (referred to in this report as “the 1974 Development Document”) [U.S. EPA, 1974] and the 1982 *Development Document for Effluent Limitations Guidelines and Standards and Pretreatment Standards for the Steam Electric Point Source Category* (referred to in this report as “the 1982 Development Document”) [U.S. EPA, 1982] present the results of studies of the steam electric industry that EPA conducted in developing the Steam Electric Power Generating effluent

guidelines. These development documents contain findings, conclusions, and recommendations on control and treatment technology relating to discharges from steam electric power plants. In this detailed study, EPA used the information presented in the 1974 and 1982 Development Documents for historical background on the Steam Electric Power Generating effluent guidelines and for information on sources of pollutants.

2.4.4 CWA Section 316(b) - Cooling Water Intake Structures Supporting Documentation and Data

For the CWA section 316(b) Cooling Water Intake Structures rulemaking, EPA conducted a survey of steam electric utilities and steam electric non-utilities that use cooling water, as well as facilities in four other manufacturing sectors: Paper and Allied Products (SIC code 26), Chemical and Allied Products (SIC code 28), Petroleum and Coal Products (SIC code 29), and Primary Metals (SIC code 33). The survey requested the following types of information:

- General plant information, such as plant name, location, and SIC codes;
- Cooling water source and use;
- Design and operational data on cooling water intake structures and cooling water systems;
- Studies of the potential impacts from cooling water intake structures conducted by the facility; and
- Financial and economic information about the facility.

Although the Section 316(b) survey was used to create guidelines for cooling water intake structures, the cooling water system information collected in the survey was useful for the detailed study of the steam electric industry. EPA used the information provided by the Section 316(b) survey in the following analyses:

- Linking Energy Information Administration (EIA) facility information to the TRI and PCS discharges;
- Identifying the type of cooling systems used by facilities; and
- Identifying industrial non-utilities.

2.4.5 Office of Air and Radiation

EPA's Office of Air and Radiation (OAR) develops national programs, technical policies, and regulations for controlling air pollution and radiation exposure. EPA used the 2006 Integrated Planning Model (IPM) database used by OAR to estimate the projected scrubbed capacity for the future industry profile [U.S. EPA, 2006]. The IPM was developed by ICF Consulting, Inc. and is used to estimate the projected impacts from environmental policies on the electric power sector. IPM Version 3.0 projects the electric generating capacity for various "plant types" at different run years in the future (i.e., 2010, 2015, 2020, and 2025). EPA used the data from run year 2020 as a basis for future industry profile for this study, which EPA used to assess future growth of FGD usage in the industry. Additionally, EPA used OAR's Acid Rain Database [ERG, 2007a] and NEEDS 2006 database [U.S. EPA, 2006h] to supplement information collected on characteristics of plants within the steam electric industry.

2.4.6 Office of Research and Development

EPA's Office of Research and Development is currently evaluating the impact of air pollution controls on the characteristics of coal combustion residues (CCRs). Specifically, the Office of Research and Development is studying the potential cross-media transfer of mercury and other metals from flue gas, fly ash, and other residues collected from coal-fired boiler air pollution controls and disposed of in landfills or surface impoundments. The key routes of release being studied are leaching into groundwater or subsequent release into surface waters, re-emission of mercury, and bioaccumulation. The Office of Research and Development is also examining the use of CCRs in asphalt, cement, and wallboard production.

This research seeks to better understand potential impacts from disposal practices and beneficial use of CCRs by taking a holistic approach, evaluating life-cycle environmental tradeoffs that compare beneficial use applications with and without using CCRs. The outcome of this research will help to identify potential management practices of concern where environmental releases may occur, such as the development and application of a leach testing framework that evaluates a range of materials and the different factors affecting leaching for the varying field conditions in the environment.

EPA's Office of Water consulted with the Office of Research and Development on the status and findings of current research assessing the potential for CCRs to impact water quality.

2.4.7 Office of Solid Waste and Emergency Response

EPA's Office of Solid Waste and Emergency Response (OSWER) recently issued Information Request Letters to electric utilities that have surface impoundments or similar management units that contain CCRs. EPA's OSWER is using the data collected from the Information Request Letters to evaluate the threat of releases of pollutants from these management units. EPA's Office of Water used the OSWER data as another source of information about the use of ash ponds and FGD ponds at coal-fired power plants.

The OSWER database contains information collected from plants identified as potentially operating ash ponds or FGD ponds, based on data compiled by the Department of Energy's Energy Information Administration (EIA). The EIA data does not include information about waste disposal practices for those plants with nameplate electric generating capacity of less than 100 MW. In addition, due to the nature of EIA's data collection form, the EIA data may also exclude information about the presence of ponds at plants that use the pond as an interim step (e.g., to dewater ash or other CCR solids), but final disposition of the CCRs is an on-site landfill or off-site disposal/use. In requesting information on CCR surface impoundments and similar waste management units, OSWER directed the requests to those plants identified by the EIA data as disposing of CCRs in an on-site pond. As such, the OSWER database potentially underestimates the total number of ash ponds and FGD ponds nationwide.

2.5 Interactions with the Utility Water Act Group

UWAG is an association of over 200 individual electric utilities and four national trade associations of electric utilities: the Edison Electric Institute, the National Rural Electric Cooperative Association, the American Public Power Association, and the Nuclear Energy Institute. The individual utility companies operate power plants and other facilities that generate,

transmit, and distribute electricity to residential, commercial, industrial, and institutional customers. The Edison Electric Institute is an association of U.S. shareholder-owned electric companies, international affiliates, and industry associates. The National Rural Electric Cooperative Association is an association of nonprofit electric cooperatives supplying central station service through generation, transmission, and distribution of electricity to rural areas of the United States. The American Public Power Association is a national trade association representing publicly owned (municipal and state) electric utilities in 49 states. The Nuclear Energy Institute establishes industry policy on legislative, regulatory, operational, and technical issues affecting the nuclear energy industry on behalf of its member companies. These members include the companies that own and operate commercial nuclear power plants in the United States, as well as nuclear plant designers and other organizations involved in the nuclear energy industry. UWAG's purpose is to participate on behalf of its members in EPA's rulemakings under the CWA.

UWAG commented on EPA's selection of the steam electric power generating industry for a detailed study as part of the 2006 Effluent Guidelines Program Plan and submitted comments to EPA regarding the detailed study as part of the Preliminary 2008 Effluent Guidelines Program Plan. UWAG also provided data during a review of PCS and TRI data to assess national discharge loadings associated with this industry, as summarized in the *Interim Detailed Study Report for the Steam Electric Power Generating Point Source Category* (EPA/821-R-06-015, November 2006) [U.S. EPA, 2006e]. As EPA continued with the detailed study and began formulating approaches to data collection, the Agency held a series of discussions with UWAG to streamline and facilitate the data collection process. Specifically, EPA coordinated with UWAG on collecting information on power plant characteristics to support site visit selection, discussing wastewater sampling approaches and recommendations, reviewing the data request for clarity, and collecting existing permit data. At the invitation of individual plants, UWAG also collected split samples during EPA's sampling program and participated in most site visits.

2.5.1 Database of Power Plant Information

UWAG provided EPA with additional power plant information to augment data compiled from other data sources described in this chapter. EPA provided UWAG with a list of 96 coal-fired power plants believed to be operating wet FGD systems and UWAG provided information regarding plant operations at 76 of the plants. UWAG provided information on the operation of the wet FGD systems, including the installation year, sorbent usage, additive usage, oxidation type, solids handling practices, and wastewater treatment system. UWAG also provided the type of bottom and fly ash handling and wastewater treatment systems.

2.5.2 Wastewater Sampling

As discussed in Section 2.2, EPA conducted a sampling program to characterize wastewaters generated by coal-fired power plants and to evaluate treatment technologies and best management practices available to reduce pollutant discharges. EPA held several meetings with UWAG to discuss various approaches to the sampling program, including identifying representative sample points, providing comment on the generic sampling plan, and providing recommendations on laboratory analyses and potential interferences (particularly with handling influent samples with high concentrations of solids). UWAG participated in the plant pre-

sampling site visits and provided review and comment on site-specific sampling plans. At the invitation of the plants being sampled, UWAG also collected split samples during EPA's sampling episodes. EPA met with UWAG to discuss the FGD effluent sampling results and during these meetings, compared analytical results and discussed the challenges associated with laboratory analyses of FGD wastewaters [ERG, 2008d; ERG, 2009n]. UWAG also provided written suggestions to EPA for improving the analytical procedures for the sampling program [Hill, 2008].

2.5.3 Data Request

As discussed in Section 2.3, EPA developed a questionnaire (i.e., data request) to collect information on coal-fired power plants. EPA provided UWAG an opportunity to review the data request and to recommend changes to improve the clarity of the questions involved. For example, UWAG provided input on the industry's definitions of scrubber terminology to ensure that the respondents would understand the questions that EPA included in the request. After EPA distributed the data request to the data request respondents, UWAG requested clarification regarding certain data request questions on behalf of its members. Copies of UWAG's comments and questions on the data request are included in the docket for the Preliminary 2010 Effluent Guidelines Program Plan [UWAG, 2007].

2.5.4 NPDES Form 2C

UWAG and EPA coordinated efforts to create a database of selected NPDES Form 2C data from UWAG's member companies. The NPDES Form 2C (or an equivalent form used by a state permitting authority) is an application for a permit to discharge wastewater that must be completed by existing industrial facilities (including manufacturing, commercial, mining, and silvicultural operations). This form includes facility information, data on facility outfalls, process flow diagrams, treatment information, and intake and effluent characteristics.

The NPDES Form 2C database contains information about the outfalls of coal-fired power plants that receive FGD, ash handling, or coal pile runoff waste streams. EPA received Form 2C data from UWAG for 86 plants in late June 2008. [UWAG, 2008] UWAG did not include data on other outfalls, such as separate outfalls for sanitary wastes, cooling water, landfill runoff, and other waste streams, in the database. The database does not include Form 2C information for plants that have neither a wet FGD system nor wet fly ash handling. For example, if a plant has no wet FGD system and the plant's only wet ash handling is for bottom ash sluicing, UWAG did not include its information in the database. EPA reviewed the Form 2C data for use in developing the industry profile, in particular for ash wastewater treatment operations.

2.6 Interactions with the Electric Power Research Institute (EPRI)

EPRI is a research-oriented trade association for the steam electric industry. EPRI conducts research funded by the steam electric industry and has extensively studied wastewater discharges from FGD systems. The trade association provided EPA with the following reports that summarize the data collected during several EPRI studies:

- *Flue Gas Desulfurization (FGD) Wastewater Characterization: Screening Study* [EPRI, 2006a];
- *EPRI Technical Manual: Guidance for Assessing Wastewater Impacts of FGD Scrubbers* [EPRI, 2006b];
- *The Fate of Mercury Absorbed in Flue Gas Desulfurization (FGD) Systems* [EPRI, 2005];
- *Update on Enhanced Mercury Capture by Wet FGD: Technical Update* [EPRI, 2007b]; and
- *PISCES Water Characterization Field Study, Sites A-G* [EPRI, 1997b-2001].

The EPRI reports provided EPA with background information regarding the characteristics of FGD wastewaters and the sampling techniques used to collect the samples.

In addition, EPRI participated in meetings with EPA and provided comments on EPA's planned data collection activities, including the data request and the sampling program. EPRI specifically commented on the sample collection techniques and considerations for laboratory analysis of FGD and ash handling wastewaters. EPRI also provided comments on EPA's *Generic Sampling and Analysis Plan for Coal-fired Steam Electric Power Plants*. A copy of EPRI's comments on the sampling plan is included in the docket for the Preliminary 2010 Effluent Guidelines Program Plan [EPRI, 2007c].

2.7 Department of Energy (DOE)

DOE is the department of the United States government responsible for energy policy. In the detailed study, EPA used information on electric generating facilities from DOE's Energy Information Administration (EIA) data collection forms.

EIA is a statistical agency of the DOE that collects information on existing U.S. electric generating facilities and associated equipment to evaluate the current status and potential trends in the industry. EPA used information from two of EIA's data collection forms: Form EIA-860, Annual Electric Generator Report, and Form EIA-767, Steam Electric Plant Operation and Design Report. Form EIA-860 collects information annually for all electric generating facilities that have or will have a nameplate capacity³ of one megawatt (MW) or more and are operating or plan to be operating within five years of the filing of the Annual Electric Generator Report. The data collected in Form EIA-860 are associated only with the design and operation of the generators at facilities [U.S. DOE, 2005a]. Form EIA-767 collects information annually from all electric generating facilities with a total existing or planned organic-fueled or renewable steam electric generating unit that has a nameplate rating of 10 MW or larger. The data collected in Form EIA-767 are associated with the operation and design of the entire facility. EPA used Form EIA-767 primarily for information on the facilities operating (or planning to operate) FGD systems [U.S. DOE, 2005b].

³ DOE defines the generator nameplate capacity as the maximum rated output of a generator under specific conditions designated by the manufacturer. Generator nameplate capacity is usually indicated in units of kilovolt-amperes (kVA) and in kilowatts (kW) on a nameplate physically attached to the generator. More generally, generator capacity is the maximum output, commonly expressed in megawatts (MW), that generating equipment can supply to system load, adjusted for ambient conditions.

2.8 Other Sources

EPA obtained additional information on steam electric processes, technologies, wastewaters, pollutants, and regulations from sources including wastewater treatment equipment vendors, the U.S. Geological Survey (USGS), and literature and Internet searches. In addition, EPA considered information provided in public comments during the effluent guidelines planning process, as well as other contacts with interested stakeholders.

2.8.1 Wastewater Treatment Equipment Vendors

EPA contacted companies that manufacture, distribute, or install various components of pollutant removal systems. EPA obtained information about the operation and performance of these systems and the type of equipment used for treating FGD wastewaters.

2.8.2 U.S. Geological Survey (USGS) COALQUAL Database

Since the middle 1970s, the USGS has maintained a national coal quality database, containing data compiled on more than 13,000 coal samples collected by USGS and cooperative state geological surveys. The database contains 136 parameters for each sample, including data on location and sample description, analytical data from American Society for Testing and Materials (ASTM) tests, and USGS tests for major, minor, and trace elements. The COALQUAL database [USGS, 1998] contains data for 7,430 coal samples that represent complete-bed thicknesses at various locations. EPA generally reviewed data from the COALQUAL database when initially studying the industry to determine potential constituents that may be present in coal combustion wastes.

2.8.3 Literature and Internet Searches

EPA conducted literature and Internet searches to obtain information on various aspects of the steam electric process, both for plants regulated by the effluent guidelines and certain operations outside the scope of the regulations. The information collection objectives of these searches included characterizing wastewaters and pollutants originating from these steam electric processes, the environmental impacts of these wastewaters, and applicable regulations. EPA used industry journals, reference texts about the industry, and company press releases obtained from Internet searches. EPA participated in the 2007 and 2008 International Water Conference and reviewed papers presented at these conferences.

2.8.4 Environmental Groups and Other Stakeholders

EPA received information from several environmental groups and other stakeholders as part of public comments submitted for the 2006 and 2008 Effluent Guidelines Plans, and in other discussions over the course of the detailed study. The public comments and other information were reviewed to determine whether they identified new waste streams or pollutant issues that warranted investigation beyond that being conducted as part of the study. In general, the information highlighted environmental concerns associated with the pollutants present in power plant wastewaters, and technological controls for reducing or eliminating pollutant discharges from FGD and ash handling systems.

3. STEAM ELECTRIC INDUSTRY PROFILE

Electric generating plants use various types of prime movers (e.g., combustion turbines, steam turbines, diesel engines) to convert mechanical, chemical, and/or fission energy into electric energy. Within this population of electric generating plants, there are different types of processes employed to produce electricity (e.g., coal-fired power plants, wind turbines) and there are different types of companies that operate these electric generating plants (e.g., utilities, industrial plants). The Steam Electric Power Generating effluent guidelines apply to only certain types of electric generating plants. Figure 3-1 broadly depicts the various types of electric generating plants operating in the United States and identifies which are regulated by the Steam Electric Power Generating effluent guidelines.

This chapter provides an overview of the various types of electric generating processes operating in the United States and then focuses on the categories of processes regulated by the Steam Electric Power Generating effluent guidelines. The chapter also describes the wastewaters generated by these processes.

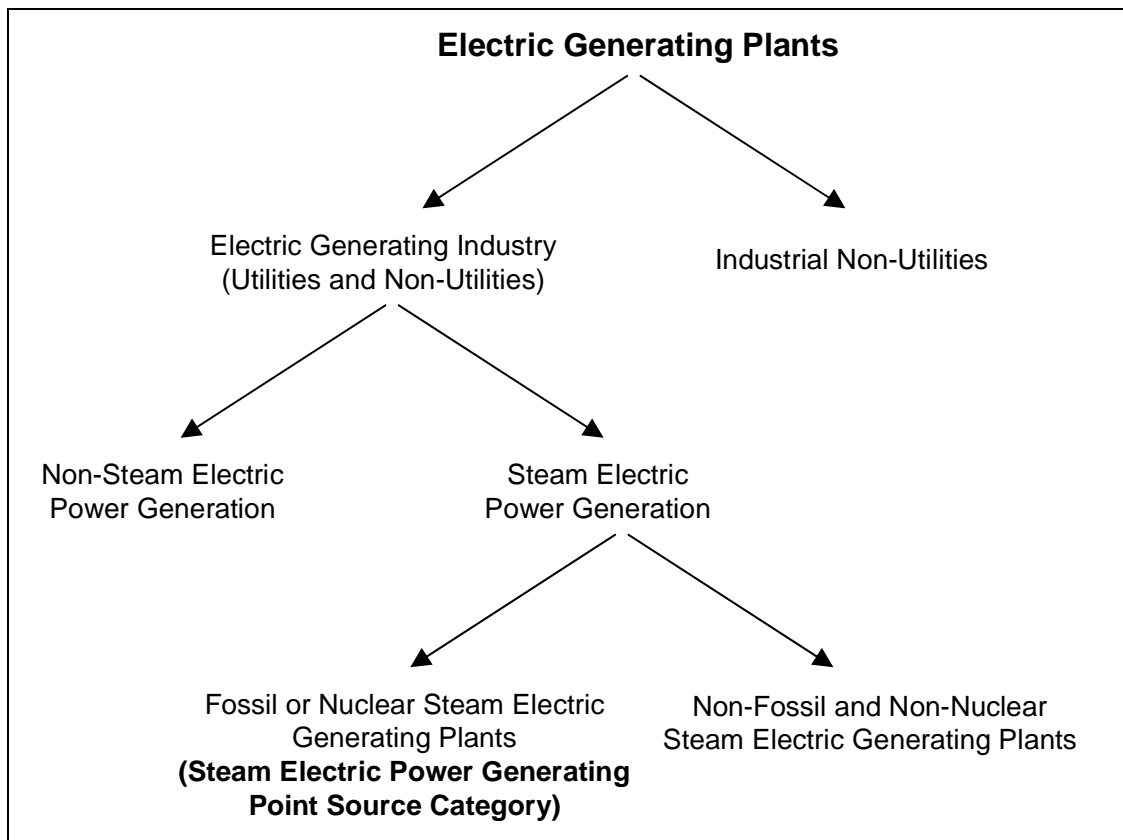

Figure 3-1. Types of U.S. Electric Generating Plants

3.1 Overview of the Electric Generating Industry

This section describes the types of plants that compose the overall electric generating industry. As shown in Figure 3-1, the plants regulated by the Steam Electric Power Generating effluent guidelines are only a portion of the electric generating industry.

In general, the companies generating electrical power are categorized as one of the following types:

1. *Utility*: Any entity that generates, transmits, and/or distributes electricity and recovers the cost of its generation, transmission and/or distribution assets and operations, either directly or indirectly, through cost-based rates set by a separate regulatory authority (e.g., state Public Service Commission), or is owned by a governmental unit or the consumers that the entity serves. According to the Energy Information Administration (EIA), plants that qualify as cogenerators or small power producers under the Public Utility Regulatory Policies Act are not considered electric utilities [U.S. DOE, 2006b].
2. *Non-industrial non-utility*: Any entity that generates, transmits, and/or sells electricity, or sells or trades electricity services and products, where costs are not established and recovered by regulatory authority. Non-utility power producers include, but are not limited to, independent power producers, power marketers and aggregators, merchant transmission service providers, self-generation entities, and cogeneration firms with Qualifying Facility Status. [U.S. DOE, 2006b]. Like utilities, the primary purpose of non-industrial non-utilities is producing electric power for distribution and/or sale.
3. *Industrial non-utility*: Industrial non-utilities are similar to non-industrial non-utilities except their primary purpose is not the distribution and/or sale of electricity. This category includes electric generators that are located at facilities such as chemical manufacturing plants or paper mills. Industrial non-utilities typically provide most of the electrical power they generate to the industrial operation with which they are located, although they may also provide some electric power to the grid for distribution and/or sale.

Industrial non-utilities are generally not included within the scope of the existing Steam Electric Power Generating effluent guidelines because they are not primarily engaged in producing electricity for distribution and/or sale⁴. As described above, these industrial non-utilities typically are industrial plants that are producing, processing, or assembling goods and the electricity generated at these plants is an ancillary operation used to dispose of a by-product or for cost savings. Industrial non-utilities are discussed in greater detail in Chapter 7 of this report.

Because industrial non-utilities are not included in the applicability of the Steam Electric Power Generating effluent guidelines, EPA has excluded them from the discussion of the U.S. electric generating industry for the purposes of this report. Therefore, information presented on plants comprising the electric generating industry include only the utilities and the non-industrial

⁴ The applicability of the Steam Electric Power Generating Point Source Category (40 CFR Part 423.10) states the following: “The provisions of this part are applicable to discharges resulting from the operation of a generating unit by an establishment primarily engaged in the generation of electricity for distribution and sale which results primarily from a process utilizing fossil-type fuel (coal, oil, or gas) or nuclear fuel in conjunction with a thermal cycle employing the steam water system as the thermodynamic medium.”

non-utilities, which are generally categorized by the following four North American Industry Classification System (NAICS) codes⁵:

- 221111 – Hydroelectric Power Generation;
- 221112 – Fossil Fuel Electric Power Generation;
- 221113 – Nuclear Electric Power Generation; and
- 221119 – Other Electric Power Generation.

Although the transmission and distribution entities are included in the definition of utilities and non-industrial non-utilities, they are not included in the Steam Electric Power Generating effluent guidelines; therefore, this report only presents information on the plants and NAICS codes associated with the generation of electricity.

As shown in Figure 3-1, the electric generating industry can be further broken down based on the type of prime mover used to generate electricity. DOE's Energy Information Administration (EIA) defines a prime mover as the engine, turbine, water wheel, or similar machine that drives an electric generator, or a device that converts energy to electricity directly (e.g., photovoltaic solar and fuel cell(s)) [U.S. DOE 2006a]. Because the Steam Electric Power Generating effluent guideline is applicable only to plants generating electricity using a "... thermal cycle employing the steam water system as a thermodynamic medium," EPA categorized the prime movers into "steam electric" and "non-steam electric" categories. The steam electric generating units include steam turbines and combined cycle systems (see Section 3.2 for more details on these types of units). The non-steam electric generating units include, but are not limited to, combustion turbines, internal combustion engines, fuel cells, and wind turbines.

The final criteria for a plant to meet the Steam Electric Power Generating effluent guideline applicability is that they must primarily utilize a fossil-type or nuclear fuel to generate the steam used in the turbine. The fossil-type fuels include coal, oil, or gas, and fuels derived from coal, oil, or gas such as petroleum coke, residual fuel oil, and distillate fuel oil. Fossil-type fuels also include blast furnace gas and the product of gasification processes using fossil-based feedstocks such as coal, petroleum coke, and oil. Examples of non-fossil/non-nuclear fuels used by some steam electric generating power plants include pulp mill black liquor, municipal solid waste, and wood solid waste.

3.1.1 Demographics of the Electric Generating Industry

This section presents available demographic data and other information for the electric generating industry (i.e., excluding industrial non-utilities). EPA analyzed the available demographic information using EIA data for the year 2005 (Form EIA-860 and Form EIA-767) [U.S. DOE, 2005a; U.S. DOE, 2005b], and U.S. Census Bureau data collected in the 2002 Economic Census [USCB, 2002]. EPA used the 2005 EIA data because it is the most recent year for which both EIA-860 and EIA-767 data are available, and the 2002 Census data because it is the most recent year for which data at the six-digit NAICS code are available. Together, these

⁵ Prior to the introduction of NAICS codes, Standard Industrial Classification (SIC) codes were used to classify operations. The SIC codes applicable to the Steam Electric Power Generating effluent guidelines are discussed in Chapter 7.

sources provide the most recent and comprehensive dataset of power plant data available. EPA identified electric generating plants in the EIA database as those reporting NAICS code 22 - Utilities⁶. The 2002 Economic Census data include more specific industry sector information at the six-digit NAICS code level.

According to the Economic Census, there were 2,138 electric generating plants in the United States in 2002, 61 percent (1,311 plants) of which are characterized primarily as using fossil or nuclear fuel [USCB, 2002]. These data include both steam and non-steam electric generation processes. Table 3-1 presents the distribution of plants among each of the electric generating NAICS codes. The Economic Census includes all facilities reporting under NAICS code 22. As a result, it includes entities categorized by U.S. DOE as utilities and non-industrial non-utilities, but does not include industrial non-utilities.

Table 3-1. Distribution of U.S. Electric Generating Plants by NAICS Code in 2002

NAICS Code – Description	Plants
221111 – Hydroelectric Power Generation	416
221112 – Fossil Fuel Electric Power Generation	1,233
221113 – Nuclear Electric Power Generation	78
221119 – Other Electric Power Generation (includes conversion of other forms of energy, such as solar, wind, or tidal power, into electrical energy)	411
22111 – Electric Power Generation (Total)	2,138

Source: [USCB, 2002].

EPA also examined the data on electricity generating plant operations that were reported to the EIA in 2005. Form EIA-860 contains records for 16,807 steam and non-steam electric generating units having at least one MW of capacity operated at 5,267 plants for calendar year 2005 [U.S. DOE, 2005a]. These plants include both the electric generating industry and industrial non-utilities.

3.1.2 Steam Electric Power Generating Industry

EPA used EIA's Form EIA-860 information on plant type, energy source, and capacity to develop a demographic profile of the portion of the electric generating industry regulated by the Steam Electric Power Generating effluent guidelines. As mentioned in Section 3.1.1, these records include data from all plants that produce electricity, including steam electric plants. EPA defined the subset of EIA data for the Steam Electric Power Generating effluent guidelines by the reported NAICS code, as well as the type of turbine and the fuel reported to be used to generate electricity.

All electric generating plants (i.e., utilities, non-industrial non-utilities, and industrial non-utilities) report information about each of their electric generating units to the EIA in Form EIA-860, and each plant identifies a "primary purpose" code for its operations that is analogous to their NAICS code. Utilities and non-industrial non-utilities report under the general NAICS

⁶ NAICS code 22 – *Utilities* is defined as establishments providing the following utility services: electric power, natural gas, steam supply, water supply, and sewage removal. Excluded from this sector are establishments primarily engaged in waste management services [USCB, 2002].

code 22, while industrial non-utilities report under the particular NAICS code for their primary manufacturing or service operation. Because utilities and non-industrial non-utilities are regulated by the Steam Electric Power Generating effluent guidelines, their EIA data are combined in this report.

3.1.2.1 Definition of the Steam Electric Power Generating Industry

The Steam Electric Power Generating effluent guidelines apply to “...discharges resulting from the operation of a generating unit by an establishment primarily engaged in the generation of electricity for distribution and sale which results primarily from a process utilizing fossil-type fuel (coal, oil, or gas) or nuclear fuel in conjunction with a thermal cycle employing the steam water system as the thermodynamic medium.” (40 CFR 423.10) EPA identified the subset of electric generating plants in the EIA database that use steam electric processes as those operating at least one prime mover that utilizes steam. The following electric generating unit or prime mover types are included in the demographic data for the steam electric industry presented in this report:

- Steam turbine;
- Combined cycle system – steam turbine portion;
- Combined cycle system – combustion turbine portion; and
- Combined cycle system – single shaft (i.e., the steam turbine and combustion turbine are used together to drive a single generator).

The subset of steam electric plants that are regulated by the steam electric effluent guidelines use a fossil or nuclear fuel as the primary energy source for the steam electric generating unit. In analyzing the EIA data, EPA included plants using the following EIA-defined nuclear and fossil (or fossil-derived) fuel types:

- Anthracite coal, bituminous coal;
- Lignite coal;
- Subbituminous coal;
- Coal synfuel;
- Waste/other coal;
- Petroleum coke;
- Distillate fuel oil;
- Residual fuel oil;
- Jet fuel;
- Kerosene;
- Oil-other and waste oil (e.g., crude oil, liquid by-products, oil waste, propane (liquid), re-refined motor oil, sludge oil, tar oil);
- Natural gas;
- Blast furnace gas;
- Gaseous propane;
- Other gas; and
- Nuclear (e.g., uranium, plutonium, thorium).

Using the criteria for the prime mover type and energy source described above for all plants (utilities and non-industrial non-utilities) reporting a primary purpose/NAICS code of 22,

EPA identified 1,187 steam electric plants regulated under the Steam Electric Power Generating effluent guidelines that reported to the EIA in 2005. In analyzing the EIA energy source data for the purpose of this report, EPA only identified plants/units that reported one of the above energy sources as a “primary” energy source in the 2005 EIA data. These plants operate an estimated 2,557 stand-alone steam electric generating units or combined cycle systems, which have a total generating capacity of 762,386 MW [U.S. DOE, 2005a].

3.1.2.2 Demographics of the Steam Electric Power Generating Industry

Table 3-2 presents the distribution of the types of steam electric prime movers used by plants subject to the Steam Electric Power Generating effluent guidelines. The table presents the numbers of plants, electric generating units, and capacity for each type of steam electric prime mover. The number of electric generating units represents the number of generators/turbines that are used to generate electricity and does not necessarily relate to the number of boilers.

Based on the 2005 EIA data, the majority (74 percent) of the steam electric power produced by the plants subject to the effluent guideline is generated using stand-alone steam turbines, which are also the most prevalent type of steam electric prime mover used.

In the 2005 EIA database, an estimated 411 plants regulated by the Steam Electric Power Generating effluent guidelines reported operating at least one fossil-fueled combined cycle system. Due to the nature of the EIA data, EPA was able to identify the number of combined cycle turbines (i.e., prime movers), but could not discern the number of actual combined cycle systems. A combined cycle system is comprised of one or more combustion turbines linked to one or more steam turbines; these systems often do not have a one-to-one relationship between the number of combustion turbines and steam turbines. The total combined cycle system generating capacity of 198,660 MW represents 26 percent of the total capacity regulated by the steam electric effluent guidelines [U.S. DOE, 2005a].

Table 3-3 presents the distribution of fossil and nuclear fuels used to power each type of steam electric prime mover. The number of electric generating units represents the number of generators/turbines that are used to generate electricity and is not equal to the number of boilers. The vast majority (90 percent) of these generating units are fueled by either coal or gas. Coal is the primary fuel type for stand-alone steam turbines, while gas is the primary fuel for nearly all combined cycle systems.

Table 3-2. Distribution of Prime Mover Types for Plants Regulated by the Steam Electric Power Generating Effluent Guidelines

Steam Electric Prime Mover	Number of Plants ^a	Number of Electric Generating Units	Total Steam or Combined Cycle Turbine Capacity (MW)
<i>Stand-Alone Steam Turbine</i>	818 (69%)	1,995 (78%)	563,726 (74%)
<i>Combined Cycle Systems ^b:</i>	411 (35%)	562 (22%)	198,660 (26%)
Combined Cycle Steam Turbine ^{c, d}	392	512	70,020
Combined Cycle Single Shaft (steam and combustion turbines share a single shaft)	22	50	9,503
Combined Cycle Combustion Turbine ^{c, d}	390	889	119,137
Total	1,187 (100%)	2,557 ^e (100%)	762,386 (100%)

Source: [U.S. DOE, 2005a].

a – Because a single plant may operate multiple electric generating units of various types, the number of plants by prime mover type is not additive. There are 1,187 plants in the industry that operate at least one steam electric generating unit powered by either fossil or nuclear fuel.

b – Due to the nature of the EIA data, EPA was able to identify the number of combined cycle turbines (i.e., prime movers), but could not discern the number of actual combined cycle systems. EPA estimated the number of combined cycle systems by adding the number of combined cycle steam turbines and the number of combined cycle single shaft turbines. Typically there are multiple combustion turbines to a single steam turbine in a combined cycle system; therefore, EPA believes this methodology is a better representation of the number of combined cycle systems than simply adding the number of combined cycle combustion and steam turbines.

c – The 2005 EIA database contains a total of 506 combined cycle steam turbines, with an additional six plants reporting at least one combined cycle combustion turbine, but not a combined cycle steam turbine. EPA believes that these six plants likely operate a combined cycle steam turbine; therefore, EPA assumed that each of the six plants operates one combined cycle steam turbine and counted six additional turbines and six additional plants to the numbers identified in the 2005 EIA database for the number of combined cycle steam turbines and combined cycle steam turbine plants.

d – One plant in the 2005 EIA database reported having a combined cycle steam turbine electric generating unit and two internal combustion electric generating units. Another plant in the database reported a fossil fuel for its combined cycle steam turbine and a non-fossil/non-nuclear fuel for its three combined cycle combustion turbines. EPA included the combined cycle steam turbines for these plants in the table, but did not include the internal combustion or the combined cycle combustion turbines using fuels not covered by the effluent guidelines.

e – EPA estimated the total number of electric generating units as the sum of the stand-alone steam turbines and the estimated number of combined cycle systems. EPA did not sum the total number of turbines.

Table 3-3. Distribution of Fuel Types Used by Steam Electric Generating Units

Fossil or Nuclear Fuel ^a	Number of Electric Generating Units				Total
	Stand-Alone Steam Turbines	Combined Cycle Steam Turbines ^{b, c}	Combined Cycle Single Shaft	Combined Cycle Combustion Turbine ^{b, c}	
<i>Coal:</i>	1,179	2	0	2	1,183
Anthracite Coal, Bituminous Coal	695	2	0	2	699
Subbituminous Coal	411	0	0	0	411
Lignite Coal	29	0	0	0	29
Coal Synfuel	22	0	0	0	22
Waste/Other Coal	22	0	0	0	22
<i>Petroleum Coke</i>	12	0	0	0	12
<i>Oil:</i>	136	11	0	20	166
Residual Fuel Oil	125	2	0	2	129
Distillate Fuel Oil	11	8	0	16	34
Waste Oil	0	1	0	2	3
<i>Gas:</i>	564	499	50	867	1,975
Natural Gas	559	495	50	866	1,966
Blast Furnace Gas	5	0	0	0	5
Other Gas	0	4	0	1	4
<i>Nuclear</i>	104	0	0	0	104
Total	1,995	512	50	889	2,557 ^d

Source: [U.S. DOE, 2005a].

a – No steam electric generating units were reported to use jet fuel, kerosene, or gaseous propane in the 2005 EIA database.

b – The 2005 EIA database contains a total of 506 combined cycle steam turbines, with an additional six plants reporting at least one combined cycle combustion turbine, but not a combined cycle steam turbine. EPA believes that these six plants likely operate a combined cycle steam turbine; therefore, EPA assumed that each of the six plants operates one combined cycle steam turbine and counted six additional turbines and six additional plants to the numbers identified in the 2005 EIA database for the number of combined cycle steam turbines and combined cycle steam turbine plants.

c – One plant in the 2005 EIA database reported having a combined cycle steam turbine electric generating unit and two internal combustion electric generating units. Another plant in the database reported a fossil fuel for its combined cycle steam turbine and a non-fossil/non-nuclear fuel for its three combined cycle combustion turbines. EPA included the combined cycle steam turbines for these plants in the table, but did not include the internal combustion or the combined cycle combustion turbines using fuels not covered by the effluent guidelines.

d – EPA estimated the total number of electric generating units as the sum of the stand-alone steam turbines and the estimated number of combined cycle systems. EPA did not sum the total number of turbines.

Table 3-4 presents the distribution of fossil and nuclear fuels used by plants applicable to the Steam Electric Power Generating effluent guideline. The 2005 EIA data demonstrate that more than half of the electricity produced by steam turbines is fueled by coal. Natural gas accounts for 27 percent of the electricity produced by steam turbines, nuclear for 16 percent, and oil for 5 percent of the electricity from steam turbines. Table 3-4 includes only the prime movers that are specifically steam-driven turbines (i.e., stand-alone steam turbines, combined cycle steam turbines, and combined cycle single shaft). Therefore, the total numbers of plants, electric generating units, and capacity presented in Table 3-4 do not match the total numbers presented in Table 3-2. EPA included only the steam turbines in Table 3-4 to focus on identifying the fuels used to produce electricity using steam.

Table 3-5 presents the distribution of combined cycle units powered by fossil and nuclear fuels. Table 3-5 includes only the prime movers associated with combined cycle units (i.e., combined cycle steam turbine, combined cycle single shaft, and combined cycle combustion turbine). The stand-alone steam turbines are not included in the table. The 2005 EIA data show that natural gas is the predominant fuel source for combined cycle units, accounting for 99 percent of the total combined cycle capacity. There are a small number of plants that reported operating combined cycle units fueled by oil. The two plants that reported coal as the fuel source are Integrated Gasification Combined Cycle (IGCC) units. These “coal-fired” combined cycle systems are actually powered by syngas generated by a coal gasification process [U.S. DOE, 2005a]. Section 3.2.10 contains additional information about IGCC systems.

Table 3-6 presents the steam electric capacity, as well as the number of steam electric plants and electric generating units in the industry, distributed by *overall plant capacity*⁷. Table 3-6 includes the stand-alone steam turbines and all the combined cycle system turbines (i.e., combined cycle steam turbine, combined cycle single shaft, and combined cycle combustion turbine) in the determination of the number of steam electric plants and steam electric capacity. For the number of electric generating units, EPA only included the stand-alone steam turbines, the combined cycle steam turbines, and the combined cycle single shaft to estimate the number of stand-alone electric generating units and the number of combined cycle systems. According to the 2005 EIA data, the largest capacity plants (>500 MW) comprise nearly half of all steam electric plants, approximately 60 percent of the electric generating units, and 87 percent of the steam electric generating capacity for all plants regulated by the effluent guidelines. Based on the 2005 EIA data, most steam electric plants are either gas or coal-fired and have a generating capacity greater than 500 MWs.

⁷ The overall plant capacity includes all electric power generated by the plant, including electricity produced by non-steam generators and through the use of non-fossil/non-nuclear energy sources.

Table 3-4. Types of Fuel Used by Stand-Alone and Combined Cycle Steam Turbines

Fossil or Nuclear Fuel ^a	Number of Plants ^b	Number of Electric Generating Units	Total Steam Turbine Capacity (MW) ^c
<i>Coal:</i>	488 (41%)	1,181 (46%)	329,211 (51%)
Anthracite Coal, Bituminous Coal	280	697	175,271
Subbituminous Coal	173	411	130,300
Lignite Coal	17	29	14,643
Coal Synfuel	10	22	6,960
Waste/Other Coal	20	22	2,037
<i>Petroleum Coke</i>	11 (0.9%)	12 (0.5%)	778 (0.1%)
<i>Oil:</i>	75 (6.3%)	147 (5.7%)	32,219 (5.0%)
Residual Fuel Oil	60	127	30,983
Distillate Fuel Oil	14	19	1,216
Waste Oil	1	1	20
<i>Gas:</i>	619 (52%)	1,113 (44%)	175,455 (27%)
Natural Gas	613	1,104	175,186
Blast Furnace Gas	2	5	152
Other Gas	4	4	117
<i>Nuclear</i>	66 (5.6%)	104 (4.1%)	105,585 (16%)
Total	1,187 (100%)	2,557 (100%)	643,249 (100%)

Source: [U.S. DOE, 2005a].

Note: The table includes only the stand-alone steam turbines, combined cycle steam turbines, and combined cycle single shaft. The combined cycle combustion turbines are not included in the table.

a – No steam electric generating units were reported to use jet fuel, kerosene, or gaseous propane in the 2005 EIA database.

b – Because a single plant may operate multiple electric generating units utilizing differing fuel types, the number of plants by fuel type is not additive. There are 1,187 plants in the industry that operate at least one stand-alone steam turbine, combined cycle steam turbine, or combined cycle single shaft electric generating unit powered by either fossil or nuclear fuel.

c – The total steam electric capacity shown does not equal the sum of the steam electric capacities for each fuel type due to rounding errors.

Table 3-5. Distribution of Fuel Types for Combined Cycle Units Regulated by the Steam Electric Power Generating Effluent Guidelines

Fossil or Nuclear Fuel ^a	Combined Cycle Steam Turbine			Combined Cycle Single Shaft (steam and combustion turbines share a single shaft)			Combined Cycle Combustion Turbine		
	Number of Plants ^b	Number of Electric Generating Units ^c	Total Turbine Capacity (MW) ^d	Number of Plants ^b	Number of Electric Generating Units	Total Turbine Capacity (MW) ^c	Number of Plants ^b	Number of Electric Generating Units ^e	Total Turbine Capacity (MW) ^d
<i>Coal:</i>	2	2	246	0	0	0	2	2	385
Anthracite Coal, Bituminous Coal	2	2	246	0	0	0	2	2	385
<i>Petroleum Coke</i>	0	0	0	0	0	0	0	0	0
<i>Oil:</i>	10	11	399	0	0	0	8	20	821
Residual Fuel Oil	2	2	97	0	0	0	1	2	238
Distillate Fuel Oil	7	8	280	0	0	0	6	16	536
Waste Oil	1	1	20	0	0	0	1	2	46
<i>Gas:</i>	379	499	69,375	22	50	9,503	380	867	117,932
Natural Gas	376	495	69,258	22	50	9,503	379	866	117,926
Other Gas	4	4	117	0	0	0	1	1	5
<i>Nuclear</i>	0	0	0	0	0	0	0	0	0
Total	392	512	70,020	22	50	9,503	390	889	119,137

Source: [U.S. DOE, 2005a].

Note: The table includes only the combined cycle steam turbines, combined cycle single shaft, and combined cycle combustion turbines. The stand-alone steam turbines are not included in this table, but can be found in Table 3-4.

a – No combined cycle electric generating units were reported to use lignite coal, coal synfuel, subbituminous coal, waste/other coal, jet fuel, kerosene, gaseous propane, or blast furnace gas in the 2005 EIA database.

b – Because a single plant may operate multiple electric generating units utilizing differing fuel types, the number of plants by fuel type is not additive.

c – The 2005 EIA database contains a total of 506 combined cycle steam turbines, with an additional six plants reporting at least one combined cycle combustion turbine, but not a combined cycle steam turbine. EPA believes that these six plants likely operate a combined cycle steam turbine; therefore, EPA assumed that each of the six plants operates one combined cycle steam turbine and counted six additional turbines and six additional plants to the numbers identified in the 2005 EIA database for the number of combined cycle steam turbines and combined cycle steam turbine plants.

d – The total capacity shown does not equal the sum of the steam electric capacities for each fuel type due to rounding errors.

e – One plant in the 2005 EIA database reported having a combined cycle steam turbine electric generating unit and two internal combustion electric generating units. Another plant in the database reported a fossil fuel for its combined cycle steam turbine and a non-fossil/non-nuclear fuel for its three combined cycle combustion turbines. EPA included the combined cycle steam turbines for these plants in the table, but did not include the internal combustion or the combined cycle combustion turbines using fuels not covered by the effluent guidelines.

Table 3-6. Distribution by Size of Steam Electric Capacity, Plants, and Electric Generating Units Regulated by the Steam Electric Effluent Guidelines

Overall Plant Capacity ^a	0-50 MW	50-100 MW	100-200 MW	200-300 MW	300-400 MW	400-500 MW	>500 MW	Total
Total Steam Electric Capacity (MW)	3,033	8,225	20,544	21,075	20,604	27,730	661,476	762,386 ^b
Percentage of Capacity ^c	0.4%	1.1%	2.7%	2.8%	2.7%	3.6%	87%	100%
Number of Plants	112	120	152	91	64	67	581	1,187
Percentage of Plants ^c	9.4%	10%	13%	7.7%	5.4%	5.6%	49%	100%
Number of Steam Electric Generating Units ^d	183	210	257	155	131	148	1,473	2,557
Percentage of Steam Electric Generating Units ^c	7.2%	8.2%	10%	6.1%	5.1%	5.8%	58%	100%

Source: [U.S. DOE, 2005a].

Note: The number of plants, number of steam electric generating units, and total steam electric capacity includes the stand-alone steam turbines, combined cycle steam turbines, combined cycle single shaft, and combined cycle combustion turbines.

a – Overall plant capacity includes electricity produced by both steam and non-steam electric generating units, as well as through the use of non-fossil/non-nuclear energy sources.

b – The total steam electric capacity shown does not equal the sum of the steam electric capacities for each size category due to rounding errors.

c – The sum of the percentages for each size category may not equal 100 percent due to rounding errors.

d – EPA estimated the total number of electric generating units as the sum of the stand-alone steam turbines and the estimated number of combined cycle systems. EPA did not sum the total number of turbines. EPA estimated the number of combined cycle systems by adding the number of combined cycle steam turbines and the number of combined cycle single shaft turbines.

3.2 Steam Electric Process and Wastewater Sources

Steam electric plants generate electricity using a process that includes: a steam generator (i.e., boiler); a steam turbine/electrical generator; and a condenser. Figure 3-2 illustrates the stand-alone steam electric process, in which a combustible fuel is used as the energy source to generate steam. The Steam Electric Power Generating effluent guidelines regulate wastewaters discharged by those steam electric plants that use fossil-type fuel (e.g., coal, oil, or gas) or nuclear fuel to generate the steam. However, other fuel sources such as municipal solid wastes or wood wastes may also be used to produce the steam for generating electricity. Section 7.1 of this report discusses steam electric processes that use alternative fuel sources.

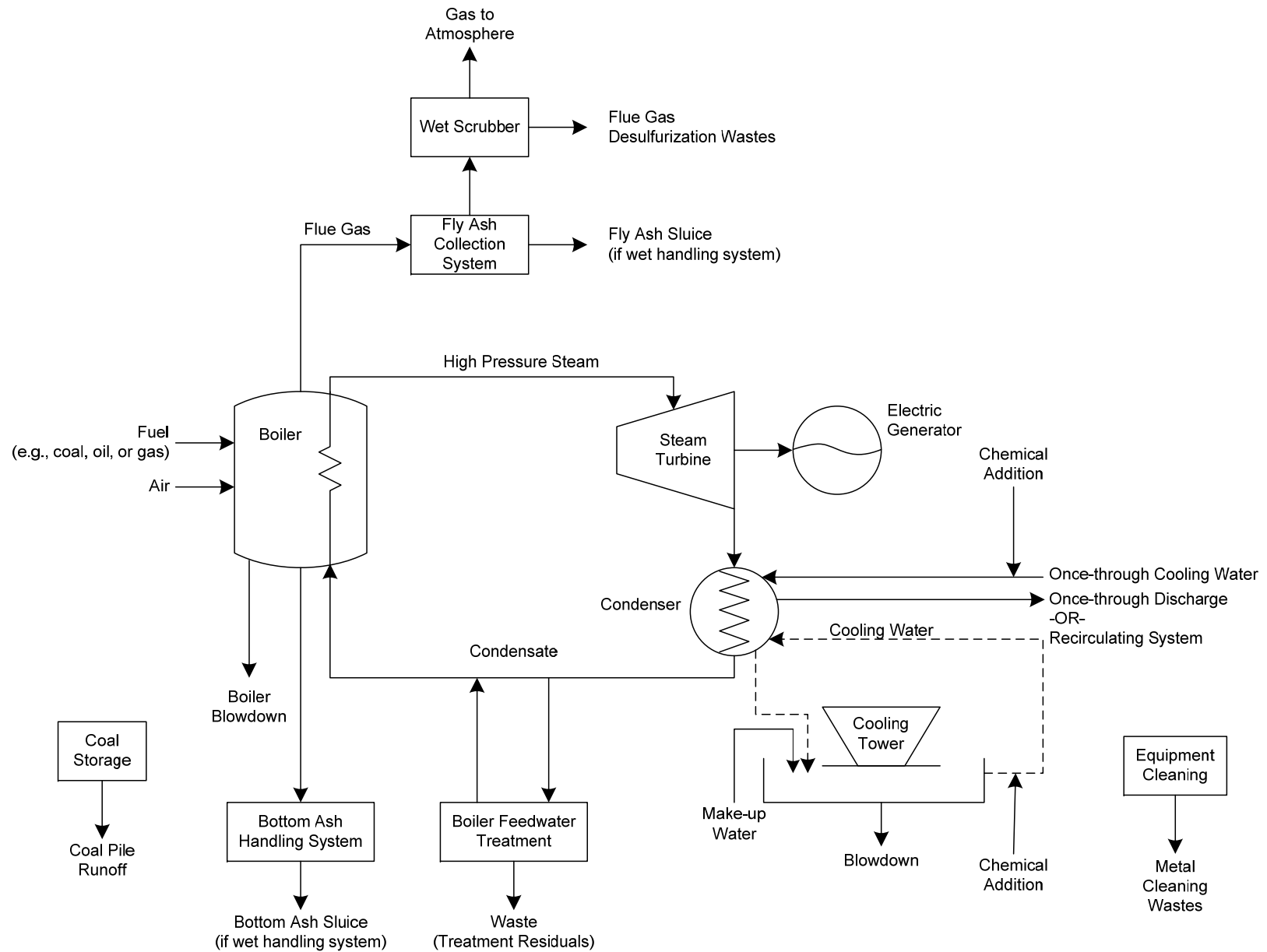

Figure 3-2. Steam Electric Process Flow Diagram

As shown in Figure 3-2, fuels are fed to a boiler where they are combusted to generate steam. Boilers and their associated subsystems often include components to improve thermodynamic efficiency by boosting steam temperature and preheating intake air using superheaters, reheaters, economizers, and air heaters. The hot gases from combustion (i.e., the flue gas) leaves the steam generator subsystem and passes through particulate collection and the sulfur dioxide scrubbing system (if present), then is emitted through the stack. The high-temperature, high-pressure steam leaves the boiler and enters the turbine generator where it drives the turbine blades as it moves from the high-pressure to the low-pressure stages of the turbine. The spinning of the turbine blades drives the linked generator, producing electricity. The lower-pressure steam leaving the turbine enters the condenser, where it is cooled and condensed by the cooling water flowing through heat exchanger (condenser) tubes. The water collected in the condenser (condensate) is sent back to the boiler where it is again converted to steam [Babcock & Wilcox, 2005].

The steam electric process may be used in conjunction with other processes that use a portion of the thermal energy produced in the boiler. Cogeneration facilities, also known as combined heat and power generators, are facilities that use thermal energy to produce electricity and also to produce steam or hot water, typically for use in manufacturing processes or for central heating. Cogeneration technologies are classified as either bottoming-cycle or topping-cycle systems. In a typical bottoming-cycle system, high temperature steam is first used in a manufacturing process and then the waste heat is used to generate steam to drive a turbine for generating electricity. In one of two top-cycling configurations, high-temperature high-pressure steam from a boiler is used to drive a turbine to generate electricity, and the waste heat or steam exhausted from the turbine is then used as a source of heat for an industrial or commercial process, such as space heating or food preparation. In another topping-cycle configuration, a combustion turbine or diesel engine burns fuel to spin a shaft connected to a generator to produce electricity, and the waste heat from the burning fuel is recaptured in a waste-heat recovery boiler for use in direct heating or producing steam for thermal applications [U.S. DOE, 2000b]. Some of the industrial non-utilities discussed in Section 7.2 are cogeneration plants, and some of the alternative-fueled⁸ steam electric plants discussed in Section 7.1 may be cogeneration plants.

The nuclear-fueled steam electric process is similar to the same steam/water system described above. Key differences between the nuclear and non-nuclear systems include fuel handling, nuclear fission within the reactor core replaces the boiler as the heat source for producing steam, and the air pollution control equipment is not needed for the flue gases. No fuel is combusted and no ash is generated in a nuclear-fueled steam electric process. Instead, heat is transferred from the reactor core by creating steam in boiling water reactors or creating superheated water in pressurized-water reactors. The steam turbine/electric generator and condenser portions of the nuclear-fueled steam electric process are the same as those described for the stand-alone steam electric process [U.S. DOE, 2006c].

The remainder of this section discusses the waste streams generated at steam electric plants. This section also discusses the combined cycle system process and emerging technologies such as IGCC and carbon capture processes. Chapters 4 and 5 discuss FGD and ash handling

⁸ An alternative-fueled plant is defined for the purpose of this report as a plant that is not fueled by fossil or nuclear fuel.

systems and wastewaters in greater detail, as these wastewaters were the focus of the detailed study.

3.2.1 Fly Ash and Bottom Ash

Combusting coal and oil in steam electric boilers produces a residue of noncombustible fuel constituents, referred to as ash. Depending on the boiler design, as much as 70 to 80 percent of the ash from a pulverized coal furnace will consist of very fine particles that are light enough to be entrained in the flue gas and carried out of the furnace. This portion of the ash is commonly known as fly ash. The remaining 20 to 30 percent of the heavier ash that settles in the furnace or dislodged from furnace walls is collected at the bottom of the boiler and is referred to as bottom ash. Certain boiler designs, such as cyclone boilers, will produce relatively small amounts of fly ash, on the order of 20 to 30 percent, and upwards of 70 to 80 percent bottom ash.

Some of the fly ash will be collected in hoppers located under the economizer and air heaters as the coarser particles drop out of suspension as the flue gas flow changes direction. The fly ash particles that remain entrained in the flue gases are carried to the particulate control equipment, such as baghouses and electrostatic precipitators, for removal. The captured fly ash is collected in hoppers and then either pneumatically transferred as dry ash to silos for temporary storage or sluiced with water to a surface impoundment (i.e., ash pond). Dry fly ash stored in the silos is periodically transferred, usually by truck, to either a landfill or for use offsite.

Bottom ash is usually hydraulically conveyed (i.e., sluiced with water) to either an ash pond or dewatering bin. In such a system, the hot bottom ash drops to the bottom of the furnace where it is quenched in a water-filled hopper. Ash from the hopper is fed into a conveying line where it is diluted into slurry and pumped to the ash pond or dewatering storage bin. The ash sent to a dewatering bin is separated from the transport water, then sent to a landfill or transported offsite.

An alternative to the hydraulic bottom ash handling system is the mechanical drag system. As is the case with the hydraulic systems, the bottom ash first drops to the bottom of the furnace where it is quenched in a water bath. The ash is then removed from the furnace using a submerged mechanical drag conveyor, which is essentially a parallel pair of chains with crossbars attached at regular intervals. Ash conveyed out of the bottom of the furnace is typically dumped into a nearby bunker and periodically trucked to landfill or sent offsite.

At any given facility, either the fly ash or bottom ash, or both, may be handled in a wet or dry fashion. If handled wet, the fly ash and bottom ash may be stored in a common ash pond or in separate impoundments. Coal-fired power plants typically generate large quantities of both fly ash and bottom ash. Oil-fired plants produce less ash than coal-fired plants, and most of the ash produced is fly ash. Natural gas-fired plants do not produce ash. The characteristics of ash depend to some degree on the type of fuel combusted, how it is prepared prior to combustion, and the operating conditions of the boiler. Fly ash and bottom ash transport waters typically contain heavy metals, including priority pollutants [U.S. EPA, 1982]. Chapter 5 further discusses ash handling operations and wastewater generation at coal-fired power plants.

3.2.2 Flue Gas Desulfurization

Power plants use FGD scrubber systems to remove SO_2 from stack emissions. Typically, FGD scrubber systems can remove over 90 percent of the SO_2 in the flue gas, and in many cases can remove up to or greater than 99 percent. Wet FGD scrubbers are the most common; however, dry FGD scrubbers also exist [U.S. EPA, 2003]. Although dry FGD scrubbers use water in their operation, they do not generate any wastewaters.

In wet FGD scrubbers, the flue gas stream comes in contact with a liquid stream containing a sorbent, which is used to effect the mass transfer of pollutants from the flue gas to the liquid stream. Figure 3-3 presents a simplified diagram of a typical wet FGD system. The sorbents typically used for SO_2 absorption are lime ($\text{Ca}(\text{OH})_2$) or limestone (CaCO_3), which react with the sulfur in the flue gas to form calcium sulfite (CaSO_3). Scrubber systems can be operated with varying levels of oxidation. In forced oxidation systems, the CaSO_3 is fully oxidized to produce gypsum ($\text{CaSO}_4 \cdot 2\text{H}_2\text{O}$). Section 4.2 discusses these processes in further detail.

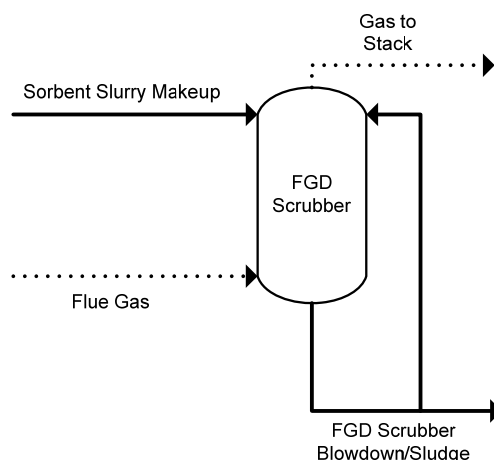

Figure 3-3. Typical Wet FGD System

Limestone forced oxidation systems are the most common scrubbers operated in the steam electric industry today. Plants that generate gypsum using limestone forced oxidation systems can market the gypsum for use in building materials (e.g., wallboard), while plants that do not generate gypsum or only partially oxidize the CaSO_3 must dispose of their scrubber solids, typically in landfills or surface impoundments [U.S. EPA, 2006a]. Plants that are producing a saleable product, such as gypsum, may rinse the product cake to reduce the level of chlorides in the final product. This wash water may be reused or potentially treated and discharged. Both sludge by-products, gypsum and CaSO_3 , typically require dewatering prior to sale, disposal, or processing for reuse. This dewatering process generates a wastewater stream that likely needs to be treated before it is discharged or reused. FGD scrubber system wastewaters, including the wastewater stream from dewatering and scrubber blowdown, may contain significant concentrations of metals, such as arsenic, mercury, and selenium. During the scrubbing process, metals and other constituents that were not removed from the flue gas stream by the electrostatic precipitators (ESPs) may be transferred to the scrubber blowdown and other downstream wastewaters and/or solid products.

FGD wastewaters are currently regulated by the effluent guidelines as *low volume wastes* generated at steam electric plants [40 CFR 423.11(b)]. EPA first identified FGD wastewater as a potential wastewater for regulation during the 1982 rulemaking. At that time, EPA concluded that the available data were not sufficient for characterizing the pollutant loadings from FGD systems and that additional studies would be needed. [U.S. EPA, 1982]. Chapter 4 contains more information on FGD systems, FGD wastewater characteristics, and the treatment of FGD wastewater.

3.2.3 Selective Catalytic Reduction

Selective catalytic reduction (SCR) is a technology used to control nitrogen oxide (NO_x) emissions in the flue gas from the boiler. Ammonia (NH₃) is injected into the flue gas upstream of a catalyst, such as vanadium or titanium. The NO_x in the flue gas (comprising mainly nitrogen monoxide (NO) with lesser amounts of nitrogen dioxide (NO₂)) reacts with the NH₃ in the presence of oxygen and the catalyst to form nitrogen and water:

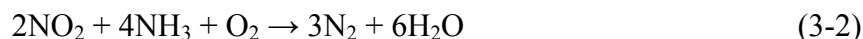

In addition to these primary reactions, a fraction of the SO₂ in the flue gas may be oxidized to sulfur trioxide (SO₃), and other side reactions may produce ammonium sulfate ((NH₄)₂SO₄) and ammonium bisulfate (NH₄HSO₄) as by-products:

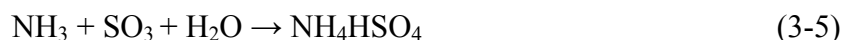

These by-products can foul and corrode downstream equipment. The extent to which they are formed depends upon various factors within the process, including the sulfur content of the coal used in the boiler and the amount of excess NH₃ in the system. Unreacted NH₃ present in the flue gas from the SCR is commonly termed *ammonia slip* [CCT, 1997].

Plants may use different SCR configurations based on the particular operations of the system, including placing the SCR upstream of the air heater⁹ and other emission control devices such as a FGD scrubber and/or particulate controls (e.g., ESP). Although the SCR does not produce a waste stream, it can affect the characteristics of fly ash transport water, air heater wash water, and FGD wastewater. As previously explained, unreacted NH₃ and SO₃ by-product can create (NH₄)₂SO₄ and NH₄HSO₄, which can deposit in the air heater and must be removed through periodic washes. Ammonia that passes unreacted through the SCR may attach to the particulates in the flue gas and be removed from the flue gas in the air pollution control equipment (e.g., ESP, baghouse, FGD scrubber). Because ammonia is soluble, if the ash collected from the particulate removal device is handled with a wet system (e.g., wet sluicing),

⁹ The air preheater utilizes the heat contained in the flue gas to increase the temperature (via heat exchange) of the air injected into the boiler for combustion.

then the ammonia will likely partition into the wastewater and be discharged from the plant [Wright, 2003].

In addition to reducing the ammonia slip, installing an SO_3 removal system before the air heater may further reduce the amount of $(\text{NH}_4)_2\text{SO}_4$ and NH_4HSO_4 formed and deposited in the air heater and, consequently, the amount of NH_3 in the air heater wash water [Wright, 2003].

3.2.4 Condenser Cooling

In the steam electric process, a constant flow of cooling water is required to maintain steam condensation and a low pressure in the condenser. Steam electric plants typically use either once-through cooling water systems or recirculating cooling water systems to condense the steam from the process. In once-through cooling water systems, the cooling water is withdrawn from a body of water, flows through the condenser, and is discharged back to the body of water.

A recirculating cooling system recirculates the cooling water required to maintain steam condensation and a low pressure in the condenser. After it passes through the condenser, the heated water is sent to a cooling tower to lower its temperature. The heated water enters the cooling tower at the top and falls down the packing material in the tower. Air flows upward through the tower, and as the air contacts the droplets of water, some of the water evaporates. The high surface area of the packing material enhances evaporation. As water evaporates, the latent heat required to evaporate the water is transferred from the water to the air, cooling the water. Fresh water is periodically added to the cooling water system to make up for evaporative losses. Additionally, as cooling water evaporates in the cooling tower dissolved minerals present in the water remain behind in the system. Over time, these minerals will increase in concentration. To prevent these minerals from building up to unacceptable levels, a volume of water must be discharged periodically to purge the minerals from the system, which is referred to as “cooling tower blowdown.” Figure 3-4 presents a diagram of a recirculating cooling system.

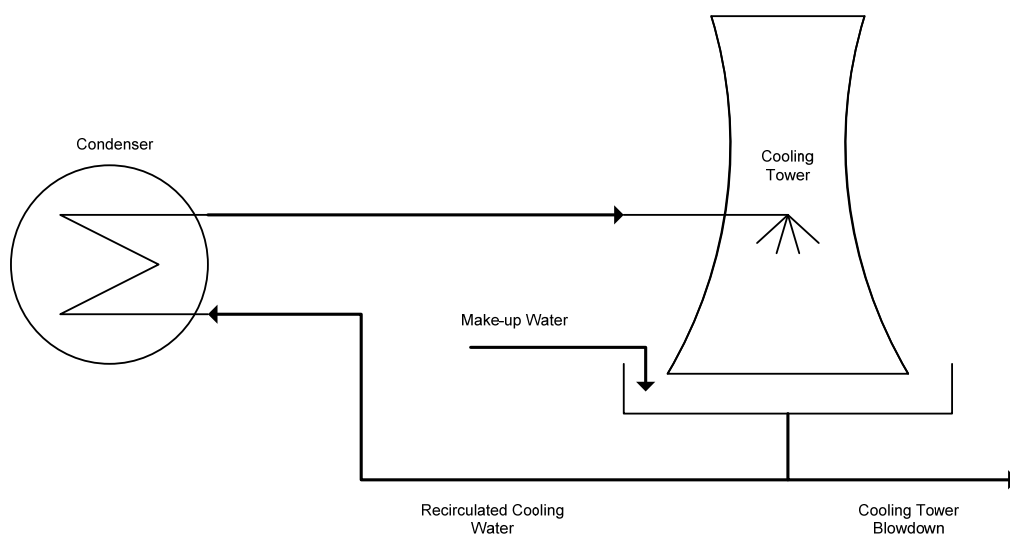

Figure 3-4. Diagram of a Recirculating Cooling System

As the cooling water passes through the condenser, microbiological species (e.g., bacterial slimes and algae) stick to and begin growing on the condenser tubes. This growth,

referred to in the industry as biofouling, reduces heat transfer, decreases flow, and accelerates corrosion of the condenser. Various macro-organisms, such as mussels, mollusks, and clams, can also inhibit condenser performance. Steam electric plants use biocides, such as sodium hypochlorite, sodium bromide, or chlorine gas, to control biofouling on the condenser tubes and cooling tower packing material. Plants may also use chlorine or other antimicrobials, or other methods (e.g., mechanical, thermal) to control macro-organisms.

Once-through cooling water and cooling tower blowdown may contain the following pollutants, often in low concentrations, as a result of chlorination and corrosion and erosion of the piping, condenser, and cooling tower materials: chlorine, iron, copper, nickel, aluminum, boron, chlorinated organic compounds, suspended solids, brominated compounds, and nonoxidizing biocides. Although the pollutants present in cooling water-related wastewaters are often at low concentrations, the overall pollutant mass discharge may be significant due to the large flow rates of cooling water discharges at steam electric power plants.

Once-through cooling water is the largest volume wastewater discharge at coal-fired power plants. EPA's data request obtained information on once-through cooling water flows from 15 plants. The once-through cooling water flow rates at these plants ranged from 178 to 1,860 million gallons per day (mgd), with an average discharge rate of 720 mgd. Recirculating cooling water systems minimize the amount of water used by steam electric plants. On average, recirculating cooling water systems reduce the cooling water flow rate between 92 and 95 percent compared to once-through cooling systems, depending on the water source [U.S. EPA, 2001]. According to information obtained through the data request, the average cooling tower blowdown flow rate (for 16 coal-fired power plants and 39 recirculating cooling water systems) is 37.7 mgd. The recirculating cooling water flow rates for these plants ranged from 0.89 to 512 mgd. These data generally compare to the cooling water flow rate data presented in the 1996 Preliminary Data Study and the 1982 Development Document [U.S. EPA, 1996; U.S. EPA, 1982]¹⁰.

Although recirculating cooling systems reduce the amount of water used by the cooling system, they consume more water than once-through cooling systems. Recirculating cooling systems use evaporation to remove heat from the cooling water, and the water evaporated is lost from the system. In a once-through cooling system, all the water used for cooling is discharged from the cooling water system.

Some plants have implemented dry cooling technology to minimize cooling water usage, due in part to water shortages that exist in arid parts of the world. Dry cooling systems transfer heat to the atmosphere without water evaporation. There are two types of dry cooling systems for power plant applications: direct dry cooling and indirect dry cooling. Direct dry cooling systems use air to directly condense steam, whereas indirect dry cooling systems use a closed-cycle water cooling system to condense steam, and the heated water is then cooled by air.

¹⁰ The 1982 Development Document states that the average flow rate through a once-through cooling system was 305 mgd and the average blowdown flow rate from a recirculating cooling system was 0.94 mgd, based on industry survey data [U.S. EPA, 1982]. The 1996 Preliminary Data Study states that for a 1,150-MW coal-fired power plant, the once-through cooling water flow rate is approximately 1,440 mgd and the cooling tower blowdown flow rate ranges from 13.6 mgd to 36.6 mgd, depending on the cycle of concentration [U.S. EPA, 1996].

After the cooling water has been used to condense the steam in the condenser, the once-through or recirculating cooling water is discharged (treated or untreated) to surface waters or a POTW, or reused in other processes such as FGD make-up or transporting fly ash or bottom ash to the ash pond.

Some plants use the large flow rates of the cooling water discharges to help meet their effluent limits for other process wastewaters by diluting these other process wastes. This dilution allows plants to meet low concentration limits for certain metals or other pollutants, but it does not reduce the overall mass of pollutants discharged from the plant. This could result in nutrient loads or bioaccumulative metals, such as arsenic, mercury, or selenium, accumulating in the receiving water body.

Some plants treat the cooling tower blowdown generated at the plant, including a number of plants that use vapor-compression evaporation systems in combination with a final drying process for treatment system residuals, to treat cooling tower blowdown. Section 4.3 describes the operation of vapor-compression evaporation/distillation systems used to treat FGD wastewaters. The systems used to treat cooling tower blowdown are similar to the system used to treat FGD scrubber purge; however, it is generally easier and more economical for plants to treat cooling tower blowdown because cooling tower blowdown does not contain the types of salts present in FGD scrubber purge. The distillate generated from the vapor-compression evaporation system is reused for processes such as boiler or cooling water make up.

Several best management practices and treatment technologies are available to reduce the discharge of chlorine and other biocides from steam electric plants. The 1982 Development Document describes the following four biocide management practices in use at steam electric plants for once-through and/or recirculating cooling systems [U.S. EPA, 1982; UWAG, 2006]:

- **Low-level biocide application.** Perform optimization study to determine minimum amount of biocide needed to control biofouling;
- **Natural decay of total residual oxidants (TRO)/free available oxidants.** Isolate (i.e., shut off) blowdown from cooling system after biocide application until the biocide has naturally decayed to an acceptable level;
- **Dechlorination (Dehalogenation).** Add reducing agent, typically sulfur dioxide, to the cooling water stream prior to discharge to consume the oxidizing biocide present; and
- **Mechanical cleaning.** Clean the condenser tubes using a mechanical operation (e.g., circulate oversized sponge rubber balls through the condenser tubes) instead of using biocides, or to allow for reduced use of biocides.

3.2.5 Low Volume Wastes

Low volume wastes, as defined by the effluent guidelines, include a variety of waste streams, such as wastewater associated with wet scrubber air pollution control systems, ion exchange water treatment systems, water treatment evaporator blowdown, laboratory and sampling streams, boiler blowdown, floor drains, cooling tower basin cleaning wastes, and

recirculating house service water systems. See 40 CFR 423.11. The wastewater associated with wet scrubber air pollution control systems are described in section 3.2.2 and chapter 4 of this report. The 1982 Development Document presents information on the generation and characteristics of boiler blowdown, boiler feed water treatment wastewaters, and drains and spills. For example, the 1982 Development Document describes that boiler blowdown can be discharged continuously or intermittently to control the build-up of suspended and dissolved solids in the boiler water and that the average blowdown flow rate is 33,000 gpd/plant (for 231 coal-fired power plants) [U.S. EPA, 1982].

Low volume wastes are typically combined with other plant wastewaters for treatment, often in settling ponds. In some cases, low volume wastewaters can be recycled within the plant. One data request plant reported using untreated low volume wastewater as a source for bottom ash sluicing and another reported using it as a source for FGD make-up water. Some plants also report reusing settling pond effluent from systems that receive a variety of wastewaters including ash transport water and low volume wastes.

3.2.6 Metal Cleaning

The Steam Electric Power Generating effluent guidelines define metal cleaning waste as “any wastewater resulting from cleaning [with or without chemical cleaning compounds] any metal process equipment, including, but not limited to, boiler tube cleaning, boiler fireside cleaning, and air preheater cleaning.” (See 40 CFR 423.11). Chemicals are used to remove scale and corrosion products that accumulate on the boiler tubes and retard heat transfer. The major constituents of boiler cleaning wastes are the metals of which the boiler is constructed, typically iron, copper, nickel, and zinc. Boiler firesides are commonly washed with a high-pressure water spray against the boiler tubes while they are still hot. Fossil fuels with significant sulfur content will produce sulfur oxides that adsorb on air preheaters. Water with alkaline reagents is often used in air preheater cleaning to neutralize the acidity due to the sulfur oxides, maintain an alkaline pH, and prevent corrosion. The types of alkaline reagents used include soda ash, caustic soda, phosphates, and detergent.

Metal cleaning wastes are generated infrequently at many plants, with some operations taking place perhaps once every 10 years. The metal cleaning wastewater is often sent to an ash pond, but it may first receive initial treatment in a separate impoundment/basin as necessary to meet NPDES permit limitations such as limitations on pH and selected metals. Some plants handle metal cleaning wastes differently than other wastewaters because the metal cleaning wastes are generated so infrequently and often have high pollutant concentrations. For example, one plant EPA visited transfers its metal cleaning wastes to a concrete basin and allows the water to evaporate over time (e.g., several years). Another plant EPA visited has its metal cleaning wastes hauled off site by a contractor. Some plants have reported that they do not discharge metal cleaning wastewater, accomplishing this by feeding the wastes to the boiler. The 1982 Development Document discusses the use of incineration, ash basin treatment, and physical chemical treatment as options for handling metal cleaning wastes [U.S. EPA, 1982].

3.2.7 Coal Piles

Coal-fired power plants typically receive the coal via train or barge; however, depending on the location of the mine, trucks may also be used to transport the coal to the plant. The coal is unloaded in a designated area and conveyed to an outdoor storage area, referred to as the coal

pile. Power plants generally store between 25 and 40 days worth of coal in the coal pile, but this varies by plant. Some coal-fired plants may operate more than one coal pile depending on the location of the boilers and whether different types of coal are used or blended.

Rainwater and melting snow contacting the coal pile generates a waste stream that contains pollutants associated with the coal, referred to as coal pile runoff. The quantity of runoff depends upon the amount of precipitation, the physical location and layout of the pile, and the extent to which water infiltrates the ground underneath the pile. Coal pile runoff is usually collected in a runoff pond during or immediately after times of rainfall. Table 3-7 presents the estimated coal pile runoff flow rates reported in the data request responses. Most of the flow rates in Table 3-7 were estimated by the plants based on the amount of rainfall at the plant, the size of the coal pile, and a runoff coefficient (based on plant experiences). The flow rates that are normalized on a MW basis are based on the plants' total coal-fired capacity. The average coal-fired capacity for the 30 plants included in the dataset is 1,490 MW per plant, and the median coal-fired capacity per plant is 1,300 MW.

Table 3-7. Coal Pile Runoff Generation Reported for the EPA Data Request

	Number of Plants	Average ^a	Median ^a	Range ^a
Number of days runoff was generated in 2006 ^b	30	133	124	40 – 365
Flow Rate per Plant				
gpy/plant	30	31,100,000	17,600,000	2,070,000 – 364,000,000
Flow Rate Normalized by Coal-Fired Capacity				
gpy/MW ^c	30	19,300	12,600	2,650 – 109,000
Flow Rate Normalized by Tons of Coal Burned				
gpy/Ton of Coal	30	6.61	5.20	1.25 – 26.2

Source: [U.S. EPA, 2008a].

Note: The coal pile runoff flow rate depends upon the geographic location of the plant (determines the amount of rainfall), the capacity of the plant, and the amount of coal reserve at the plant (determines the size of the pile).

a – The flow rates presented have been rounded to three significant figures.

b – Estimated number of days coal pile runoff wastewater was generated in 2006.

c – For this summary, EPA assumed that the total capacity for each coal-fired steam electric unit is associated with coal use. Non-coal-fired units are not included in the capacity calculations.

EPA also obtained coal pile runoff data from the NPDES Form 2C data provided by UWAG. Within this dataset, there were 13 plants which reported a discharge for coal pile runoff. Of these 13 plants, 7 reported flow rates associated with the outfall. The average flow rate for these 7 plants was 213 gpm, but the flow rates ranged from 25 to 953 gpm [UWAG, 2008]. EPA did not calculate the flow rates in gallons per year because EPA does not have data for the duration or the frequency of the discharge from the outfalls in the Form 2C data set.

The type and amount of contaminants generated in coal pile runoff depends upon the coal characteristics and the residence time of water within the coal pile. The rainfall generating the coal pile runoff can dissolve inorganic salts or cause chemical reactions in the coal piles, which will be carried away in the runoff. Coal pile runoff is typically acidic due to the oxidation of iron sulfide, which produces sulfuric acid, and ferric hydroxide or ferric sulfate. Coal pile runoff may contain high concentrations of copper, iron, aluminum, nickel, and other constituents present in

coal [U.S. EPA, 1982]. Plants typically direct coal pile runoff wastewaters to a holding pond along with stormwater runoff from other areas near the coal pile.

During the site visit program, EPA requested that plants report the pH of their coal pile runoff ponds. In some cases, EPA collected the pH measurement directly while on site, while in other cases the plants collected the measurements before, during, or after EPA's site visit. These coal pile runoff ponds were generally acidic with observed pH values often near 3 S.U. The lowest pH observed in a coal pile runoff pond during a site visit was 2.57 S.U. The highest observed pH was 8 S.U.; however, in this case, the plant's coal pile runoff pond also received limestone pile runoff.

Because the transfers to the coal pile runoff are intermittent depending on rainfall, and the transfers from the coal pile runoff pond are based on the level in the pond, the residence time for treating the coal pile runoff is highly variable. For example, if the plant receives a heavy rainfall for several hours causing the pond to overflow and transfer the runoff to surface waters, then some of the runoff may only have been managed in the pond for an hour or two before being discharged. However, if the plant receives a light rainfall that doesn't cause the pond to overflow and the plant receives no rain for several weeks, then the rainfall that was collected will have been in the pond that entire time. Most of the coal pile runoff ponds that EPA visited during the site visit program are designed to manage the volume of coal pile runoff associated with a 10-year, 24-hour storm event.

3.2.8 Landfill Leachate and Runoff

Coal combustion residues (CCR) comprise a variety of wastes from the coal combustion process, including fly ash, bottom ash, boiler slag, and FGD solids (e.g., gypsum and calcium sulfite). CCR may be stored at the plant in on-site landfills or surface impoundments. Leachate is the liquid that drains or leaches from a landfill or an impoundment. The two sources of landfill leachate are precipitation that percolates through the waste deposited in the landfill and the liquids contained within the CCR when it was placed in the landfill. Surface runoff is precipitation that contacts the landfill wastes and flows over the landfill. Landfills typically have some sort of storm water drainage to minimize the amount of rainwater entering the landfill. Figure 3-5 presents a diagram depicting the generation and collection systems for landfill leachate and landfill runoff.

As discussed in Section 4.2, some plants operating FGD systems can completely reuse the FGD wastewater. To do this, most of these plants dispose of the FGD solids (i.e., gypsum or calcium sulfite) in an on-site landfill. Additionally, many plants transfer fly ash or bottom ash to an on-site landfill. These FGD solids and ash contained in the landfill can contaminate the water that contacts it and this wastewater may eventually be discharged as contaminated runoff or leachate.

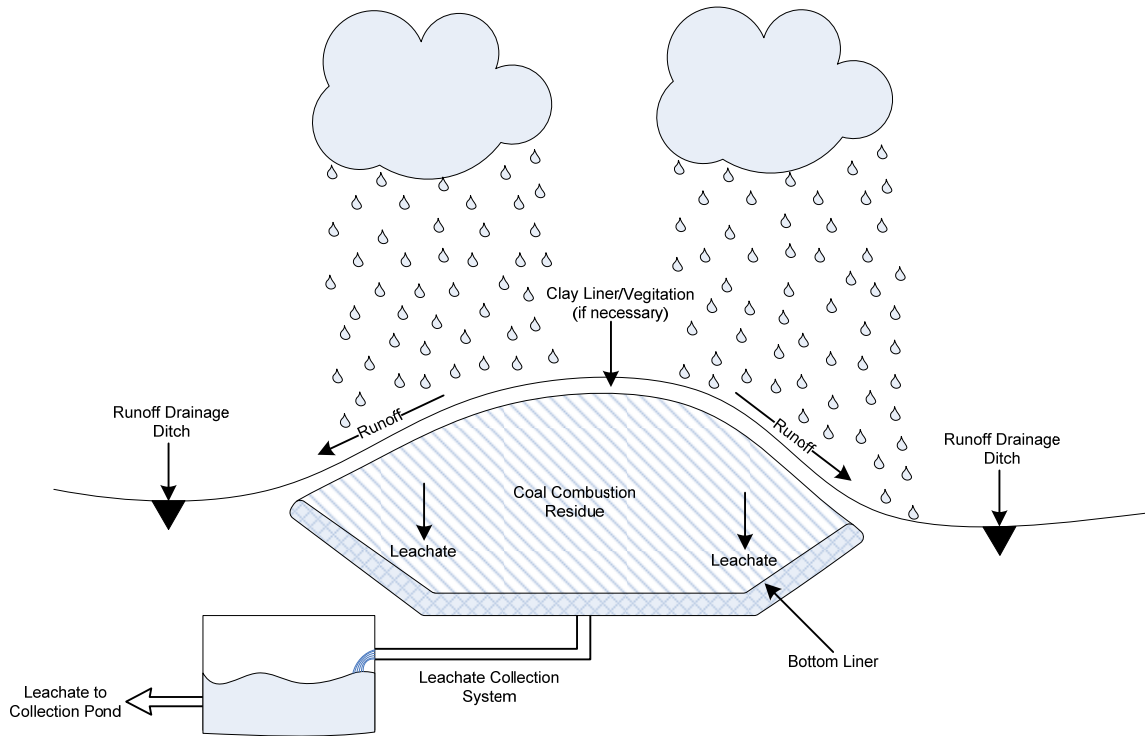

Figure 3-5. Diagram of Landfill Leachate and Landfill Runoff Generation and Collection

Landfill leachate and surface runoff will contain heavy metals and other contaminants through the contact with the CCRs. Because the various CCRs have different characteristics (e.g., pollutant levels, moisture content, leaching ability), the characteristics of the leachate and runoff depend upon the types of CCRs that are contained in the landfill. EPA's ORD is currently conducting research evaluating the potential for pollutants to leach during the disposal or use of CCRs. This research is being conducted to identify any potential cross-media transfers of mercury and other metals and to meet EPA's commitment in the Mercury Roadmap (www.epa.gov/hg/roadmap.htm) to report on the fate of mercury and other metals from implementation of multi-pollutant control at coal-fired power plants. A series of reports are being developed to document the results from the ORD research. Two reports have been published to date:

- Characterization of Mercury-Enriched Coal Combustion Residuals from Electric Utilities Using Enhanced Sorbents for Mercury Control [U.S. EPA, 2006a]; and
- Characterization of Coal Combustion Residues from Electric Utilities Using Wet Scrubbers for Multi-Pollutant Control [U.S. EPA, 2008c].

These reports document changes in fly ash resulting from the addition of sorbents for enhanced mercury capture, and evaluate residues from the expanded use of wet scrubbers. A third report currently being prepared will provide data for additional CCR samples to cover coal types and air pollution control configurations that were not addressed in the first two reports. Adding to the previous research on the leaching potential for fly ash and FGD gypsum, the third report will include data for other types of CCRs including non-gypsum scrubber residues (primarily scrubber sludge containing calcium sulfite), blended CCRs (non-gypsum scrubber

residues, fly ash, and lime), and wastewater treatment filter cake. The data compiled in these reports can be used to evaluate the composition and leaching behavior of CCRs.

Some of the plants that EPA visited during the site visit program have a runoff and/or leachate collection system for the landfills they operate. Typically, the leachate collected from the landfill flows through a collection system consisting of ditches and/or underground pipes. From the collection system, the leachate is transported to a collection pond. The runoff collection systems typically consist of one or more small collection ponds surrounding the landfill area. The leachate and runoff waters may be treated in separate ponds or combined together. Some plants discharge the effluent from these collection ponds, while other plants send the collection pond effluent to the ash pond.

When a landfill has reached its capacity, it will typically be closed (i.e., covered) to protect against environmental release of the pollutants contained in the waste. The covering for these landfills typically comprises several layers of material, which may include a clay liner to keep as much moisture from entering the landfill as possible and a top layer of top soil on which vegetation is planted. After the covering is applied to the landfill, the runoff should not become contaminated from the solids in the landfill, but because the covering may still be permeable, these landfills may continue to generate leachate.

CCRs can also be stored in surface impoundments (i.e., ash ponds and FGD ponds) as well as landfills. Some of these surface impoundments may have liners and collection systems similar to the landfills discussed previously. EPA lacks data quantifying the extent to which the effluent from the surface impoundment collection systems is recycled back to the surface impoundment, rather than discharged directly to surface water.

3.2.9 Combined Cycle Generating Units

Approximately 411 power plants operate one or more combined cycle systems fueled by fossil or fossil-type fuels to produce electricity. A combined cycle system is a combination of one or more combustion turbine electric generating units operating in conjunction with one or more steam turbine electric generating units. Combustion turbines, which typically are similar to jet engines, are usually fueled with natural gas, but may also be fueled with oil.

Exhaust gases from combustion are sent directly through the combustion turbine which is connected to a generator to produce electricity. The exhaust gases exiting the combustion turbine still contain useful waste heat, so they are directed to heat recovery steam generators (HRSGs) to generate steam to drive an additional turbine. The steam turbine is also connected to a generator (which may be a different generator or the same generator that is connected to a combustion turbine) that produces additional electricity. Thus, combined cycle systems use steam turbine technology to increase the efficiency of the combustion turbines. Figure 3-6 illustrates the combined cycle system process.

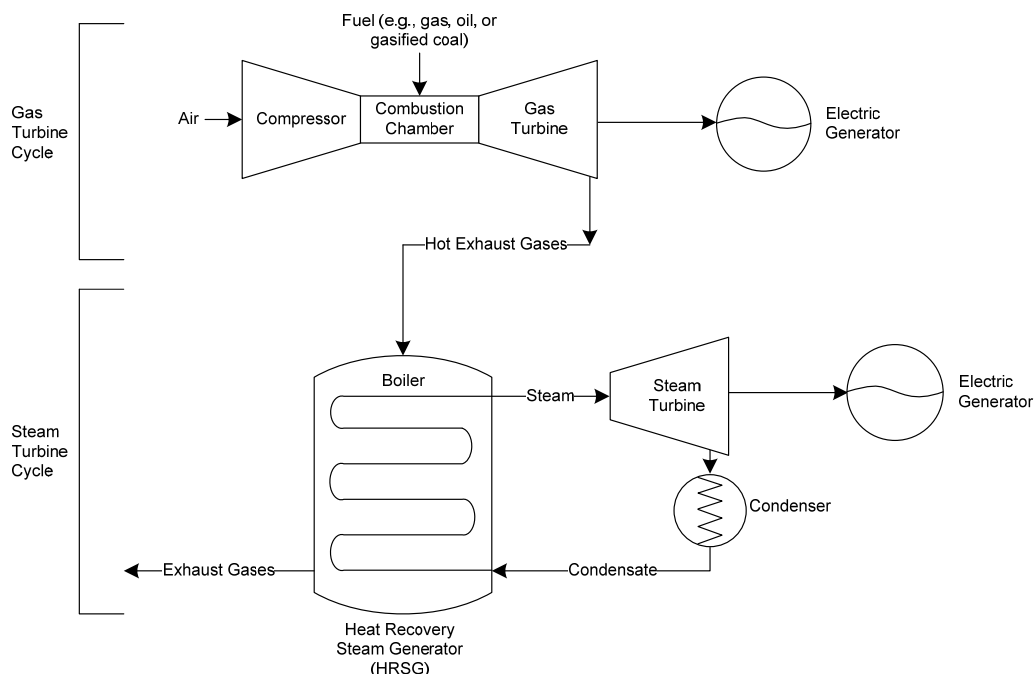

Figure 3-6. Combined Cycle Process Flow Diagram

The operation of steam electric units within combined cycle systems is virtually identical to stand-alone steam electric units, with the exception of the boiler. In a combined cycle system, the combustion turbines and HRSGs functionally take the place of the boiler of a stand-alone steam electric unit. The other two major components of steam electric generating units within combined cycle systems, the steam turbine/electric generator and steam condenser, are virtually identical to those of stand-alone steam electric units. Thus, the wastewaters and pollutants generated from the combined cycle system are the same as those from the stand-alone steam electric process. These wastewaters include cooling water and steam condensate water treatment wastes.

Combustion turbines may generate wastewaters from emissions control, equipment cooling, and equipment cleaning [U.S. EPA, 1996]. Because combustion turbines require clean-burning fuels, combined cycle combustion turbines do not discharge ash wastewaters. Although the amount generated from the combustion turbines is relatively low, these wastewaters may contain similar pollutants and concentrations as the regulated steam electric wastewaters.

3.2.10 Integrated Gasification Combined Cycle (IGCC)

IGCC is an electric power generation process that combines gasification technology with both gas turbine and steam turbine power generation (i.e., combined cycle power generation). In an IGCC system, a gasifier is used to convert carbon-based feedstock (e.g., coal or petroleum coke) into a syngas. The syngas is cleaned of particulates, sulfur, and other contaminants and is then combusted in a high-efficiency combustion gas turbine/generator. Heat from the combustion turbine exhaust is then extracted in a heat recovery steam generator to produce steam and drive a steam turbine/generator. IGCC plants can achieve higher thermodynamic efficiencies, emit lower levels of criteria air pollutants, and consume less water than traditional coal combustion power plants [Ratafia-Brown, 2002].

According to DOE's NETL Gasification World Database, 144 plants around the world operated gasification systems that generate electricity as of 2007 and approximately 10 additional gasification plants were planned to be built between 2008 and 2010. The total 2007 installed global capacity amounts to approximately 29,000 MW of electricity [U.S. DOE, 2007a]. NETL reports that there are currently 15 operating IGCC projects around the world as of March 2009, four of which are commercial-scale [Stiegel, 2009]. Two of these commercial-scale IGCC systems are located in the United States -- the 262-MW Wabash River IGCC Repowering Project (Wabash River) in Indiana and the 250-MW Tampa Electric Polk Power Station IGCC Project (Polk) in Florida. Other U.S. power companies are investigating or planning IGCC systems at new or existing plants, such as the proposed Duke Energy Edwardsport Station in Knox County, Indiana, which is planning to start up an IGCC plant by 2011 or 2012 [Duke Energy, 2009].

This section discusses the IGCC operations at the currently operating U.S. systems and the wastewaters generated from these systems. The majority of information is specific to the Wabash River IGCC gasification process, which EPA visited in February 2009. Supplemental information from the Polk process is also included here. The following stages of the Wabash River IGCC gasification process are discussed below and shown in Figure 3-7:

- **Gasification and slag handling.** A gasifier converts hydrocarbon feedstock into gaseous components by applying heat under pressure in the presence of steam. The feedstock is broken down into a syngas consisting of primarily hydrogen, carbon monoxide, water, and carbon dioxide gases. Sulfur in the fuel is converted to primarily hydrogen sulfide (H_2S) with a small portion converted to carbonyl sulfide (COS). In the gasifier, mineral matter in the fuel forms a molten slag that drops down to the bottom of the gasifier into a water quench bath. The slag/water slurry is dewatered in a dewatering bin and settler, and the overflow water is recycled as slag quench water.
- **Syngas cooling and particulate removal.** Syngas contains impurities from the coal such as sulfides, chlorides, mercury, particulate matter, and other impurities from the feedstock that must be removed prior to combusting the syngas. Particulate matter is removed from the syngas using filter elements.
- **Low-temperature heat recovery, chloride scrubbing, and syngas moisturization.** The particulate-free sour syngas (i.e., syngas containing a significant amount of sulfur compounds) is sent to a water scrubber that removes chlorides and trace metals from the syngas. The syngas then enters the COS hydrolysis unit where COS in the gas is converted to H_2S . The syngas is then cooled, which condenses water from the syngas and transfers ammonia (NH_3), carbon dioxide (CO_2), and H_2S from the syngas into the condensed "sour" water, which is transferred to the sour water treatment system. The cooled sour syngas is transferred to the acid gas removal system, in which the sulfur compounds are removed, producing sweet syngas (i.e. syngas with very few sulfur compounds present). The sweet syngas is then moisturized and superheated prior to use in the combustion turbine.

- **Acid gas removal.** The remaining hydrogen sulfide and carbon dioxide in the sour syngas stream are removed in the absorber of the acid gas removal system, which uses methyldiethanolamine (MDEA) as a solvent.
- **Sulfur recovery.** In the sulfur recovery unit, H₂S from the acid gas removal stripper and the sour water treatment system is converted into pure, molten elemental sulfur (or sulfuric acid, such as in the Polk process).
- **Sour water treatment.** Sour water treatment involves removing the ammonia, CO₂, and H₂S dissolved gases in a two-step stripping process in which steam is used to drive off the dissolved gases. First, the CO₂ and H₂S are stripped, generating a gas stream and a water stream, a large portion of which is recycled for feedstock slurry preparation. A small portion of the water is treated in an ammonia stripping column, which generates a “sweet” water stream, which contains 500 to 1,000 ppm chlorides.

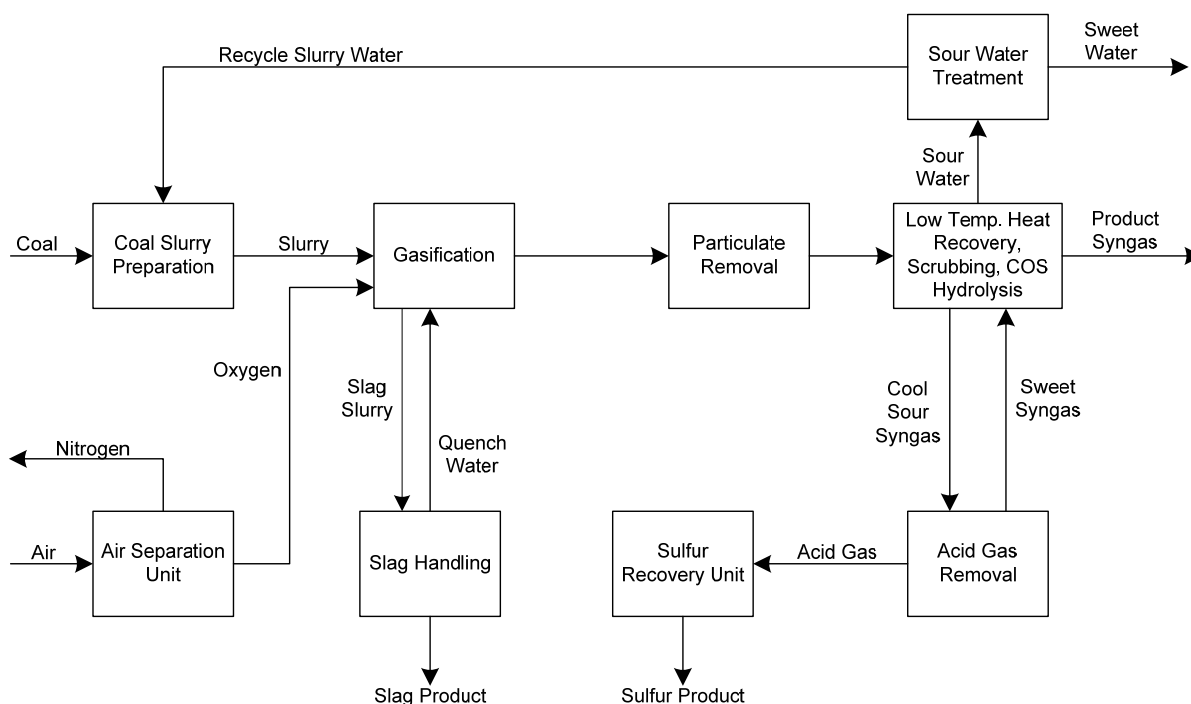

Figure 3-7. Wabash River ConocoPhillips E-Gas™ Gasification Process

Although it has been treated by steam stripping, the sweet water stream contains elements from the gasifier such as selenium, chromium, and arsenic. Additionally, at the high operating temperatures and pressures of a gasification unit, various metal compounds are formed, such as selenocyanate, which are not known to be generated in a traditional coal-fired unit. At Wabash River, prior to 2002, the sweet water was sent to a settling pond but the plant often was unable to meet its permit limits. To resolve this situation, in 2002 a vapor-compression evaporator system was installed at Wabash River to treat the sweet water. The concentrated brine from the evaporator is sent to a rotary drum dryer that concentrates the pollutants through evaporation and deposits solid waste on the drum as a cake. The salt cake, which is treated as a hazardous waste due to selenium and arsenic levels, is hauled away one to two times per week and it is made into

a cement product that is used for stabilization only (i.e., for disposal). The distillate from the rotary drum dryer is sent to the gasification wastewater settling pond. The effluent from the gasification wastewater settling pond is transferred to Wabash River's ash pond and then discharged. Since operation of the evaporator unit, Wabash River has had more success in meeting its permit requirements [ERG, 2009f; EPRI, 2007d].

The following is a list of the key wastewaters that are associated with the operation of the Wabash River IGCC unit:

- Rotary drum dryer distillate;
- Slag handling wastewater;
- Blowdown from the heat recovery steam generator;
- CO₂ stripper wastewater
- Petroleum coke pile runoff pond effluent;
- Air separation unit blowdown;
- Raw water filtration backwash;
- Demineralizer system reject;
- Sump water (miscellaneous liquid waste from the process area); and
- Cooling tower blowdown.

The rotary drum dryer distillate, cooling tower blowdown, and sump water is treated in the gasification wastewater settling pond. Other wastewaters generated in the Wabash River IGCC gasification process are able to be reused in the gasifier or in the feedstock slurry preparation [ERG, 2009f; Wabash River Energy, 2000].

The processes and wastewaters generated at the Polk plant are generally similar to those described above for Wabash River, with a few differences. The major difference is that Polk uses a brine concentrator/evaporator system to treat the gasification process wastewater. The only solid product from the brine evaporator is ammonium chloride, which is transferred to a landfill. The distillate from the brine concentrate displaces boiler make-up boiler feed water for instrument tap purges and pump seal flushes. Because the distillate is reused, there are no wastewaters discharged from Polk's gasification process [EPRI, 2007d; Tampa Electric Company, 2008].

Because IGCC syngas contains high concentrations of carbon compared to post-combustion flue gas, CO₂ capture is expected to be less expensive for pre-combustion capture from IGCC systems than for post-combustion capture. Although no current IGCC plants use carbon capture, several technologies have been proposed. One is to convert the carbon monoxide in the syngas to carbon dioxide and hydrogen gas using a water gas shift reactor [EPRI, 2009]. The following section discusses carbon capture and storage processes in more detail.

3.2.11 Carbon Capture and Storage

Carbon capture and storage is an approach being investigated to reduce or mitigate the contribution of fossil fuel emissions to global warming. Due to potential future regulations on carbon dioxide (CO₂) emissions, many steam electric power plants are considering alternatives available for reducing carbon emissions.

There are three main approaches for capturing the CO₂ associated with generating electricity: post-combustion, pre-combustion, and oxyfuel combustion.

- In *post-combustion capture*, the CO₂ is removed after combustion of the fossil fuel.
- In *pre-combustion capture*, the fossil fuel is partially oxidized, for instance in a gasifier. The resulting syngas (CO and H₂) is shifted into CO₂ and more H₂ and the resulting CO₂ can be captured from a relatively pure exhaust stream before combustion takes place.
- In *oxy-fuel combustion*, also known as oxy-combustion, the fuel is burned in oxygen instead of air. The flue gas consists of mainly carbon dioxide and water vapor, the latter of which is condensed through cooling. The result is an almost pure carbon dioxide stream that can be transported to the sequestration site and stored. Processes based on oxyfuel combustion are sometimes referred to as "zero emission" cycles, because the CO₂ stored is not a fraction removed from the flue gas stream (as in the cases of pre- and post-combustion capture) but the flue gas stream itself. However, a certain fraction of the CO₂ generated during combustion will inevitably end up in the condensed water.

After capture, the CO₂ would be transported to a suitable storage, or sequestration, site. Approaches under consideration include geologic sequestration (injection of the CO₂ into an underground geologic formation), ocean sequestration (typically injecting the CO₂ into the water column at depths to allow dissolution or at deeper depths where the CO₂ is denser than water and would form CO₂ "lakes"), and mineral storage where CO₂ is exothermically reacted with metal oxides to produce stable carbonates.

DOE's National Energy Technology Laboratory (NETL) is currently leading a research effort to develop retrofit technologies for coal-fired power plants, including the oxy-combustion process, and pre-combustion carbon capture technologies specifically for IGCC plants (see Section 3.2.10 for discussion of the IGCC process) [U.S. DOE, 2009]. Based on preliminary information regarding these technologies, EPA believes they may result in new air pollution control wastewaters that will need to be addressed at steam electric power plants. However, as these technologies are currently in the early stages of research and development and/or pilot testing, the industry has little information on the potential wastewaters generated from carbon capture processes or the characteristics of these wastewaters.

American Electric Power's (AEP's) Mountaineer Power Plant and We Energies' Pleasant Prairie Power Plant are participating in EPRI-led pilot tests demonstrating one of Alstom Corporation's post-combustion carbon capture technologies, the chilled ammonia process [Alstom, 2009]. Alstom has several demonstration projects¹¹ either operating or being built for three carbon capture technologies: chilled ammonia, advanced amines, and oxy-combustion. The Pleasant Prairie Power Plant CO₂ capture project started operating in 2008 and the Mountaineer Power Plant CO₂ capture and storage pilot project is expected to start operating this year. The latter project will be the first phase of the Alstom/AEP two-phase process to bring the chilled ammonia process to full scale by 2011. For the second phase, Alstom plans to design, build, and

¹¹ Alstom has four carbon capture projects operating or under construction, and six additional projects scheduled. These projects are taking place in seven different countries using coal, oil, or natural gas as fuels [Alstom, 2008]

add the first commercial-scale CO₂ capture system at one of the AEP plants [Power Magazine, 2008].

The chilled ammonia process planned at Mountaineer absorbs and strips CO₂ from flue gas following the FGD process (see Figure 3-8). First, the water-saturated flue gas is cooled and cleaned by refrigerated water injected directly into the gas stream. As the flue gas is cooled, water condenses from the gas, carrying the residual contaminants with it. The water is then evaporated in cooling towers, which reduces the total flue gas volume prior to entry into the CO₂ absorber unit. In the absorber, a dissolved and suspended mix of ammonium carbonate and ammonium bicarbonate reacts with the flue gas, potentially removing 90 percent or more of the CO₂ in the flue gas. The cleaned flue gas exits the absorber and then exits the stack. Residual ammonia is captured by a cold-water wash and recycled to the absorber. The CO₂-rich slurry is pumped through a heat exchanger, in which the slurry is dissolved. The slurry is then transferred to a high-pressure regenerator, in which additional heat is added by a reboiler and the CO₂ gas is stripped from the solution. The removed CO₂ can be washed, compressed, and sequestered by injection into geologic formations, such as deep saline aquifers or depleted oil and gas reservoirs. [AWMA, 2008; Power Magazine, 2008].

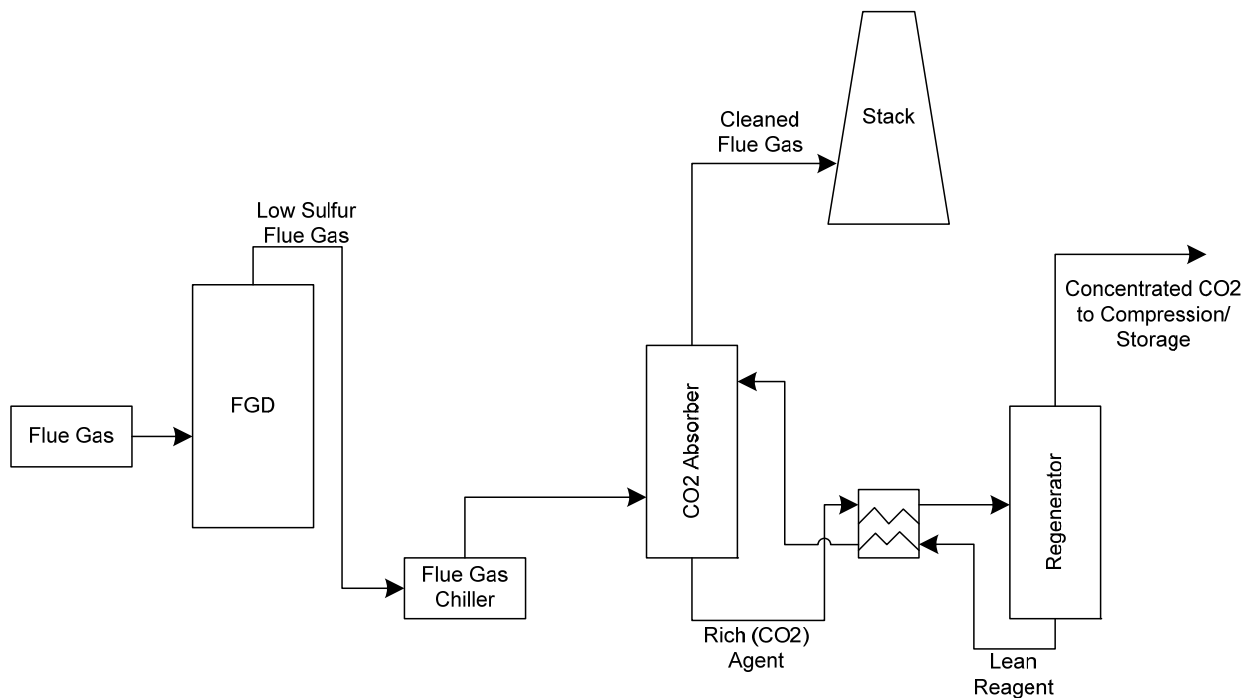

Source: [Power Magazine, 2008].

Figure 3-8. AEP's Chilled Ammonia Process at Mountaineer Power Station

As discussed previously in this section, there are other post-combustion carbon capture technologies currently being developed for the industry. One such technology is planned to be pilot tested at the Alabama Power Company's Plant Barry beginning in 2011. The pilot test is a partnership between DOE, Mitsubishi Heavy Industries, EPRI, and Southern Company. The carbon capture technology is an amine solvent based technology developed by Mitsubishi Heavy Industries [POWERnews, 2009].

3.3 Effluent Guidelines for the Steam Electric Power Generating Point Source Category

The Clean Water Act establishes a structure for regulating discharges of pollutants to surface waters of the United States. As part of the implementation of the Act, EPA issues effluent guidelines for industrial dischargers. EPA first issued effluent guidelines for the Steam Electric Power Generating Point Source Category (i.e., the Steam Electric effluent guidelines) in 1974 with subsequent revisions in 1977 and 1982. The Steam Electric effluent guidelines are codified at 40 CFR Part 423 and include limitations for the following waste streams:

- Once-through cooling water;
- Cooling tower blowdown;
- Fly ash transport water;
- Bottom ash transport water;
- Metal cleaning wastes;
- Coal pile runoff; and
- Low-volume waste sources, including but not limited to wastewaters from wet scrubber air pollution control systems, ion exchange water treatment systems, water treatment evaporator blowdown, laboratory and sampling streams, boiler blowdown, floor drains, cooling tower basin cleaning wastes, and recirculating house service water systems (sanitary and air conditioning wastes are not included) [40 CFR 423.11(b)].

The current effluent guidelines are summarized in Table 3-8 and are applicable to:

“...discharges resulting from the operation of a generating unit by an establishment primarily engaged in the generation of electricity for distribution and sale which results primarily from a process utilizing fossil-type fuel (coal, oil, or gas) or nuclear fuel in conjunction with a thermal cycle employing the steam water system as the thermodynamic medium.” [40 CFR 423.10]

The effluent guidelines do not apply to plants that primarily use a non-fossil or non-nuclear fuel source (e.g., wood waste, municipal solid waste) to power the steam electric generators, nor do they apply to generating units operated by establishments that are not primarily engaged in generating electricity for distribution and sale.

Table 3-8. Current Effluent Guidelines and Standards for the Steam Electric Power Generating Point Source Category

Waste Stream	BPT ^a	BAT ^a	NSPS ^a	PSES and PSNS ^a
All Waste Streams	pH: 6-9 S.U. ^b PCBs: Zero discharge	PCBs: Zero discharge	pH: 6-9 S.U. ^b PCBs: Zero discharge	PCBs: Zero discharge
Low-Volume Wastes	TSS: 100 mg/L; 30 mg/L Oil & Grease: 20 mg/L; 15 mg/L		TSS: 100 mg/L; 30 mg/L Oil & Grease: 20 mg/L; 15 mg/L	
Fly Ash Transport	TSS: 100 mg/L; 30 mg/L Oil & Grease: 20 mg/L; 15 mg/L		Zero discharge	Zero discharge (PSNS only) No limitation for PSES
Bottom Ash Transport	TSS: 100 mg/L; 30 mg/L Oil & Grease: 20 mg/L; 15 mg/L		TSS: 100 mg/L; 30 mg/L Oil & Grease: 20 mg/L; 15 mg/L	
Once-Through Cooling	Free Available Chlorine: 0.5 mg/L; 0.2 mg/L	Total Residual Chlorine: If \geq 25 MW: 0.20 mg/L instantaneous maximum; If < 25 MW, equal to BPT	Total Residual Chlorine: If \geq 25 MW: 0.20 mg/L instantaneous maximum; If < 25 MW, equal to BPT	
Cooling Tower Blowdown	Free Available Chlorine: 0.5 mg/L; 0.2 mg/L	Free Available Chlorine: 0.5 mg/L; 0.2 mg/L 126 Priority Pollutants: Zero discharge, except: Chromium: 0.2 mg/L; 0.2 mg/L Zinc: 1.0 mg/L; 1.0 mg/L	Free Available Chlorine: 0.5 mg/L; /0.2 mg/L 126 Priority Pollutants: Zero discharge, except: Chromium: 0.2 mg/L; 0.2 mg/L Zinc: 1.0 mg/L; 1.0 mg/L	126 Priority Pollutants: Zero discharge, except: Chromium: 0.2 mg/L; 0.2 mg/L Zinc: 1.0 mg/L; 1.0 mg/L
Coal Pile Runoff	TSS*: 50 mg/L instantaneous maximum		TSS*: 50 mg/L instantaneous maximum	

Table 3-8. Current Effluent Guidelines and Standards for the Steam Electric Power Generating Point Source Category

Waste Stream	BPT ^a	BAT ^a	NSPS ^a	PSES and PSNS ^a
Metal Cleaning Wastes	TSS: 100 mg/L; 30 mg/L Oil & Grease: 20 mg/L; 15 mg/L Copper: 1.0 mg/L; 1.0 mg/L Iron: 1.0 mg/L; 1.0 mg/L	See <i>Chemical Metal Cleaning Wastes</i> below	See <i>Chemical Metal Cleaning Wastes</i> below	See <i>Chemical Metal Cleaning Wastes</i> below
Chemical	See <i>Metal Cleaning Wastes</i> above	Copper: 1.0 mg/L; 1.0 mg/L Iron: 1.0 mg/L; 1.0 mg/L	TSS: 100 mg/L; 30 mg/L Oil & Grease: 20 mg/L; 15 mg/L Copper: 1.0 mg/L; 1.0 mg/L Iron: 1.0 mg/L; 1.0 mg/L	Copper: 1.0 mg/L (daily maximum)
Non-chemical	See <i>Metal Cleaning Wastes</i> above	Reserved	Reserved	Reserved

Source: [40 CFR Part 423].

a – The limitations for TSS, oil & grease, copper, iron, chromium, and zinc are presented as daily maximum (mg/L); 30-day average (mg/L). For all effluent guidelines, where two or more waste streams are combined, the total pollutant discharge quantity may not exceed the sum of allowable pollutant quantities for each individual waste stream. BPT, BAT, and NSPS allow either mass- or concentration-based limitations.

b – The pH limitation is not applicable to once-through cooling water.

Free Available Chlorine: 0.5 mg/L; 0.2 mg/L - 0.5 mg/L instantaneous maximum, 0.2 mg/L average during chlorine release period. Discharge is limited to 2 hrs/day/unit. Simultaneous discharge of chlorine from multiple units is prohibited. Limitations are applicable at the discharge from an individual unit prior to combination with the discharge from another unit.

Total Residual Chlorine: 0.20 mg/L instantaneous maximum. Total residual chlorine (TRC) = free available chlorine (FAC) + combined residual chlorine (CRC). TRC discharge is limited to 2 hrs/day/unit. TRC is applicable to plants ≥ 25 MW, and FAC is applicable to plants < 25 MW. The TRC limitation is applicable at the discharge point to surface waters of the United States and may be subsequent to combination with the discharge from another unit.

126 Priority Pollutants: zero discharge - 126 priority pollutants from added maintenance chemicals (refer to App. A to 40 CFR 423). At the permitting authority's discretion, compliance with the zero-discharge limitations for the 126 priority pollutants may be determined by engineering calculations, which demonstrate that the regulated pollutants are not detectable in the final discharge by the analytical methods in 40 CFR part 136.

TSS*: 50 mg/L instantaneous maximum on coal pile runoff streams. No limitation on TSS for coal pile runoff flows ≥ 10 -year, 24-hour rainfall event.

4. FLUE GAS DESULFURIZATION SYSTEMS

This chapter presents an overview of flue gas desulfurization (FGD) systems at coal-fired power plants within the steam electric industry, with particular emphasis on FGD wastewater characteristics and treatment. This chapter also presents a profile of the current and projected future use of FGD systems within the industry.

Power plants use FGD systems to control SO₂ emissions from the flue gas generated in the plants' boilers. Wet FGD scrubbers are the most common type of FGD system; however, approximately 20 percent of electric generating units serviced by SO₂ scrubbers are serviced by dry FGD systems [U.S. DOE, 2005b]. There are several variations of wet FGD systems, but this section focuses on the limestone forced oxidation system and the lime or limestone inhibited oxidation system, which are the designs predominantly used in the industry today. This section also presents some information about other types of FGD systems used at coal-fired power plants, including dry scrubbers, which do not generate wastewaters.

EPA has compiled information on the current and projected use of FGD systems at coal-fired power plants using information collected from the 2005 Form EIA-767 [U.S. DOE, 2005b], the 2005 Form EIA-860 [U.S. DOE, 2005a], EPA's site visit and sampling data, EPA's data request information [U.S. EPA, 2008a], EPA's National Electric Energy Data System (NEEDS) 2006 database [U.S. EPA, 2006h], the Integrated Planning Model [U.S. EPA, 2006b] developed by ICF Consulting, Inc., and other publicly available information (e.g., company websites, vendor news releases). The collective data from these data sources are referred to in this report as the "combined data set"¹². See Chapter 2 for additional information about EPA's data collection activities.

4.1 Coal-Fired FGD System Statistics

This section presents statistics on the number and characteristics of coal-fired power plants that currently operate wet or dry FGD systems, or are expected to install an FGD system in the next decade. Also included in this section are estimates of the coal-fired steam electric industry's current and projected total generating capacity and scrubbed capacity.

4.1.1 *Current Coal-Fired FGD System Profile*

The current coal-fired FGD system profile presents a picture of the coal-fired steam electric industry as of June 2008, including the number of coal-fired power plants with FGD systems, the associated scrubbed capacity, and plant characteristics. EPA used information from the combined data set to generate the profile.

Wet FGD systems are in operation at 108 plants, treating the flue gases from 223 generating units. These 223 electric generating units represent the number of electric generating units scrubbed and is not exactly equal to the number of FGD systems. The two numbers are similar; however, EPA is aware of several plants that use a single FGD scrubber to service more than one electric generating unit. The combined generating capacity of the wet-scrubbed generating units represents approximately 33 percent of the total nationwide coal-fired steam

¹² Due to the limited time available upon receiving the surface impoundment data collected by EPA's ORCR, the ORCR data are not included in the combined data set.

electric power generating capacity. EPA expects that percentage to increase significantly over the next decade, as discussed in Section 4.1.2. Table 4-1 presents statistics on the current coal-fired steam electric power generation associated with FGD systems, relative to total industry coal-fired and fossil-fueled steam electric power generation.

Table 4-1. Scrubbed Coal-Fired Steam Electric Power Generation as of June 2008

Industry Category	Number of Plants ^a	Number of Electric Generating Units ^{a,b}	Capacity (MW) ^{a,c}
Fossil-Fueled Steam Electric Power Generation ^{d, e, f}	1,120	2,450	657,000
Coal-Fired Steam Electric Power Generation ^{d, f}	488	1,180	330,000
Coal-Fired Steam Electric Power Generation with Any FGD System (Wet or Dry) ^g	146	280	123,000 ⁱ
Coal-Fired Steam Electric Power Generation with a Wet FGD System ^{g, h}	108	223	108,000 ⁱ
Coal-Fired Steam Electric Power Generation with a Dry FGD System ^{g, h}	41	57	14,900 ⁱ

a – The numbers presented have been rounded to three significant figures.

b – The number of electric generating units represents the number of electric generating units scrubbed and does not represent the number of FGD systems. The two numbers are similar, but several plants use a single FGD scrubber for more than one electric generating unit.

c – The capacities presented represent the nameplate capacity for the electric generating unit.

d – Source: 2005 EIA-860 [U.S. DOE, 2005a].

e – Fossil-fueled generation includes coal, oil, and natural gas. It does not include nuclear generation.

f – The table includes the stand-alone steam electric and all combined cycle turbines (i.e., combined cycle steam turbine, combined cycle single shaft, and combined cycle combustion turbine).

g – Source: Combined data set (2005 EIA-767 [U.S. DOE, 2005b], UWAG-provided data [ERG, 2008g], data request information [U.S. EPA, 2008a], and site visit and sampling information).

h – The wet and dry FGD system information is a subset of the information for “Any FGD System.” Note that several plants operate both wet and dry FGD systems. Thus, there is overlap between the number of plants with wet FGD systems and the number of plants with dry FGD systems.

i – Includes only the capacity for the scrubbed electric generating units.

The majority of the plants in the combined data set with wet FGD systems (46 percent) use eastern bituminous coal as the primary fuel source. This is to be expected because eastern bituminous coal typically contains a higher sulfur content than other coal types, thus producing higher SO₂ emissions than other types of coal. Other coals reported to be used in wet-scrubbed units include subbituminous (24 percent of plants), lignite (9 percent of plants), and other bituminous coal (20 percent of plants). Table 4-2 summarizes plant characteristics for the currently operating wet scrubbed electric generating units included in the combined data set.

Table 4-2. Characteristics of Coal-Fired Power Plants with Wet FGD Systems

	Combined Data Set ^a		
	Number of Plants with Wet FGD Systems	Number of Wet Scrubbed Electric Generating Units	Wet Scrubbed Capacity ^b (MW)
Total	108	223	108,000
Primary Coal Type ^c			
Bituminous	72	161	76,300
Subbituminous	26	48	22,700
Lignite	10	14	9,060
Type of Oxidation System			
Forced Oxidation	50	111	61,600
Inhibited or Natural Oxidation	36	62	30,000
No Information	26	50	16,700
Sorbent			
Limestone	74	151	78,200
Limestone & Fly Ash	1	1	50
Lime	17	33	11,800
Lime & Fly Ash	2	5	2,750
Magnesium-Enhanced Lime	3	8	7,390
Magnesium Oxide	2	3	896
Fly Ash	3	6	2,360
Soda Ash	1	2	530
Soda Liquor	1	4	2,320
Sodium Carbonate	2	5	938
No Information	3	4	800
NOx Controls			
SCR ^d	40	79	47,000
SNCR	7	15	4,700
None/Other (no SCR/SNCR)	44	80	35,600
No Information	25	49	20,900

Note: All 108 plants are included in the each of the categories presented in this table. Because a plant may operate multiple electric generating units that may represent more than one type of operation in each specific category, the sum of the plants for each category may be greater than 108 plants.

a – Source: Combined Data Set (2005 Form EIA-767 [U.S. DOE, 2005b], the 2005 Form EIA-860 [U.S. DOE, 2005a], EPA’s site visit and sampling data, EPA’s data request information [U.S. EPA, 2008a], EPA’s NEEDS 2006 database [U.S. EPA, 2006h], and other publicly available information (e.g., company web sites, vendor news releases)).

b – The capacities represent the reported nameplate capacity. The capacities presented have been rounded to three significant figures. Due to rounding, the total capacity may not equal the sum of the individual capacities.

c – Some plants/electric generating units use a blend of more than one coal in the electric generating units. This table presents information for only the primary type of coal burned in the electric generating unit.

d – Some of the SCRs included in the table are planned/under construction.

Of these wet scrubbed electric generating units, 111 (50 percent) are serviced by forced oxidation systems and 62 (28 percent) are serviced by natural or inhibited oxidation systems. EPA does not have information regarding the type of oxidation system for the FGD systems servicing the remaining 50 electric generating units (22 percent).

Wet FGD systems use a sorbent to transfer pollutants from the flue gas to the liquid stream. Limestone is by far the predominant sorbent used in wet FGD systems (68 percent of the

currently operating electric generating units), followed by lime (17 percent of electric generating units), and magnesium-enhanced lime (4 percent of electric generating units). Magnesium oxide, fly ash, soda ash, soda liquor, or sodium carbonate sorbents collectively are used in FGD systems servicing 9 percent of electric generating units. EPA does not have sufficient information to determine the type of sorbent used for the remaining 2 percent of electric generating units.

Nearly one-third of the plants reported using additives in their FGD systems. Some plants add organic acids, such as dibasic acid (DBA) or formic acid, to improve the sulfur dioxide removal efficiency. Inhibited oxidation plants typically will add emulsified sulfur or a similar compound to prevent oxidation of the calcium sulfite by-product so that calcium sulfate (gypsum) will not be formed.

Over 40 percent of the wet-scrubbed electric generating units in the combined data set operate either a SCR or SNCR system to reduce NO_x emissions (35 percent SCR; 7 percent SNCR). See Section 3.2 for details regarding the operation of NO_x control systems at power plants.

No plants in the combined data set were identified as currently operating advanced flue gas mercury controls; however, according to the DOE, more than 130 full-scale activated carbon injection systems have been ordered by coal-fired plants [Feeley, 2009]. One outcome of litigation surrounding the Clean Air Mercury Rule has been that in the absence of a specific regulatory requirement, plants are refraining from operating the mercury control systems that have been installed.

4.1.2 Projected Use of FGD Systems at Coal-Fired Plants

EPA used information from EPA's NEEDS 2006 database [U.S. EPA, 2006h], and the IPM [U.S. EPA, 2006b] to evaluate the expected trends in the number and capacity of units that will be scrubbed in the future.

The use of FGD systems has increased substantially since the effluent guidelines were last revised in 1982. Power plants are expected to continue installing new FGD systems in substantial numbers until at least 2025.¹³ Table 4-3 presents the projected use of wet and dry FGD systems, from 2009 through 2025, and compares the projected scrubbed capacity to the projected total coal-fired capacity.¹⁴ EPA models have predicted that over 60 percent of coal-fired capacity will be wet scrubbed by 2020. EPA predicts that the industry's dry scrubbed capacity will increase only slightly into the future and that most new FGD systems will be wet scrubbers [ERG, 2008f].

¹³ EPA projected future generating capacity with FGD systems using IPM Base Case 2006 (v.3.0), which reflects the CAMR mercury reduction requirements and the CAIR NO_x and SO₂ emission reduction requirements for power plants.

¹⁴ The data presented in Table 4-3 is based on the NEEDS 2006 database and IPM Base Case 2006 (v. 3.0). The 2020 capacity presented is the basis for the future FGD wastewater treatment industry profile presented in Section 4.6.1; however, the two data sets are not identical because the future FGD wastewater treatment industry profile does not include the "NEW" plants from the IPM data set and EPA's Office of Water made additional corrections to the IPM data set in some instances for the purpose of the detailed study. The data set corrections were necessary to address conflicting information. For more information about the future FGD wastewater treatment industry profile, see Section 4.6.1 or the memorandum entitled "Development of the Current and Future Industry Profile for the Steam Electric Detailed Study," dated October 9, 2009 [ERG, 2009r].

Table 4-3. Projected Future Use of FGD Systems at Coal-Fired Power Plants

	2009 Capacity (MW)	2010 Capacity (MW)	2015 Capacity (MW)	2020 Capacity (MW)	2025 Capacity (MW)
Wet Scrubbed ^a	136,000	162,000	189,000	231,000	282,000
Dry Scrubbed ^a	21,000	21,500	30,100	36,700	38,600
Total Scrubbed ^a	157,000	184,000	219,000	268,000	321,000
Total Coal-Fired Generating Capacity ^a	316,000	318,000	333,000	371,000	409,000
<i>Percent Wet Scrubbed</i>	<i>43%</i>	<i>51%</i>	<i>57%</i>	<i>62%</i>	<i>69%</i>
<i>Percent Scrubbed (Wet & Dry Combined)</i>	<i>50%</i>	<i>58%</i>	<i>66%</i>	<i>72%</i>	<i>78%</i>

Source: [ERG, 2008f].

a – The capacities presented have been rounded to three significant figures. Due to rounding, the total capacity may not equal the sum of the individual capacities. The 2009 capacities are from the NEEDS 2006 database which preferentially uses summer and winter capacity before nameplate capacity. Capacities presented in this table for the period 2010 through 2025 are from estimates based on the IPM model [U.S. EPA, 2006b], which uses the NEEDS 2006 database [U.S. EPA, 2006h] as a starting point. Because the nameplate capacities are not used in these projections, caution should be used when comparing the capacities in this table to Table 4-1 and the industry profile tables presented in Chapter 3.

Figure 4-1 shows the locations and relative scrubbed capacity of coal-fired plants currently operating wet FGD systems and those plants projected to operate wet FGD systems in 2020. The figure illustrates the expected growth in wet FGD systems, especially in the eastern United States due to the use of higher sulfur coal. Note that the projections for 2020 only include FGD installations for power plants and generating units that are currently in operation. New generating units or power plants that will be built in the future are not depicted, although many if not all new coal-fired generating units are likely to operate wet or dry FGD systems.

Based on communications with industry and corroborated by responses to the data request, EPA expects that new wet FGD systems will be limestone forced oxidation systems that produce a commercial-grade gypsum by-product, even for those plants located in an area where there may be no market available for the sale of such a byproduct. Additionally, EPA expects that the majority of wet scrubbed steam electric generating units will also include SCR systems to meet state and federal requirements to reduce stack emissions of NO_x.

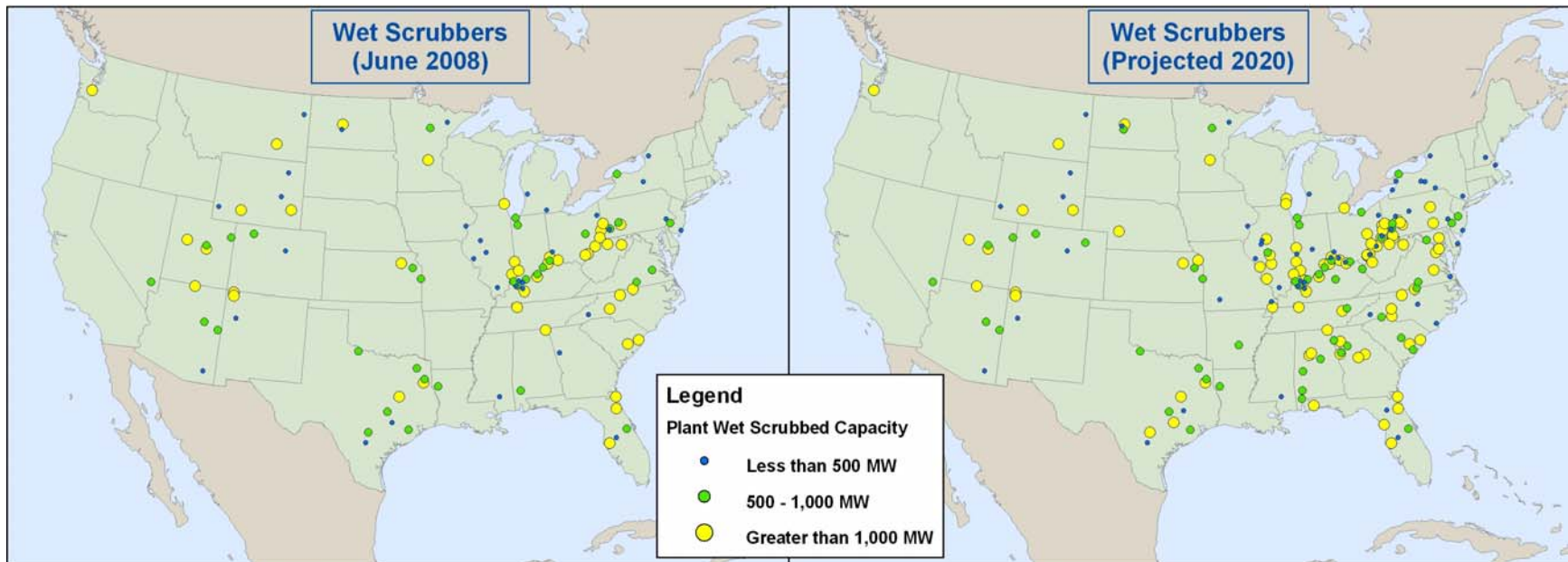

Source: [ERG, 2008b; ERG, 2008c; ERG, 2008g; ERG, 2009s; ERG, 2009w].

Note: The capacities in the figures represent the plant-level wet scrubbed capacity for the entire plant; they do not represent the plant’s total coal-fired or total generating capacity. The capacities in June 2008 figure represent the reported nameplate capacity. The capacities in Projected 2020 figure are from estimates based on the IPM model, which uses a variety of capacities in its estimate, but preferentially uses summer and winter capacity before nameplate capacity.

Figure 4-1. Wet FGD Systems at Coal-Fired Power Plants (Current and Projected 2020)

4.2 Process Description and Wastewater Generation

4.2.1 *Forced Oxidation FGD Systems*

The EPA site visit and sampling program focused primarily on forced oxidation systems because these types of FGD systems are the most common systems operating segregated wastewater treatment systems prior to discharging FGD wastewater. In addition, based on discussions with industry representatives, EPA expects that the majority of future wet FGD systems will be forced oxidation.

Most forced oxidation systems use limestone as the sorbent in the process, but lime can also be used in a forced oxidation system. The limestone forced oxidation FGD system works by contacting the flue gas stream with a liquid slurry stream containing a limestone (CaCO_3) sorbent, which effects the mass transfer of pollutants from the flue gas to the liquid stream. Equation 4-1 shows the reaction that occurs between limestone and sulfur dioxide, producing hydrated calcium sulfite (CaSO_3) [EPRI, 2006a].

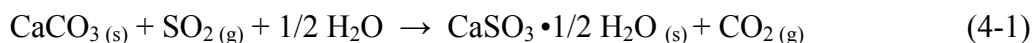

The calcium sulfite is then oxidized to calcium sulfate (gypsum) by injecting air into the calcium sulfite slurry. Equation 4-2 shows the reaction producing gypsum ($\text{CaSO}_4 \cdot 2\text{H}_2\text{O}$) from calcium sulfite [EPRI, 2006a].

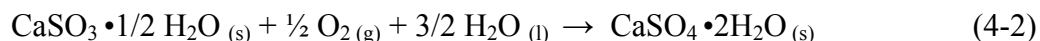

During the site visits to power plants, EPA determined that the operation of these limestone forced oxidation systems varies somewhat by plant; however, most of the systems follow the same general operating procedure. Figure 4-2 presents a typical process flow diagram for a limestone forced oxidation FGD system.

Most of the plants EPA visited operate a spray or tray tower FGD scrubber, in which the flue gas and the limestone slurry are configured with countercurrent flow. The fresh limestone slurry is typically fed to the reaction tank at the bottom of the FGD scrubber to maintain the pH levels in the system. This fresh limestone slurry mixes with the already reacted scrubber slurry and is pumped to the top of the FGD scrubber where it is sprayed downward from several different spray levels. The flue gas enters near the bottom of the FGD scrubber, just above the water level of the reaction tank. As the flue gas rises through the absorber vessel, the spray droplets of the limestone/water slurry contact the flue gas and absorb the sulfur dioxide. The limestone and water react with the sulfur dioxide to produce calcium sulfite (see Equation 4-1). To increase the sulfur dioxide removal efficiency, some plants use additives such as organic acids (e.g., DBA or formic acid) in the FGD system. These additives buffer the scrubber slurry, which controls the sulfur dioxide vapor pressure in the scrubbers, thereby maximizing the sulfur dioxide absorption rate [Babcock & Wilcox, 2005]. The scrubbed flue gas exits the top of the FGD scrubber through a mist eliminator and then is emitted through the stack.

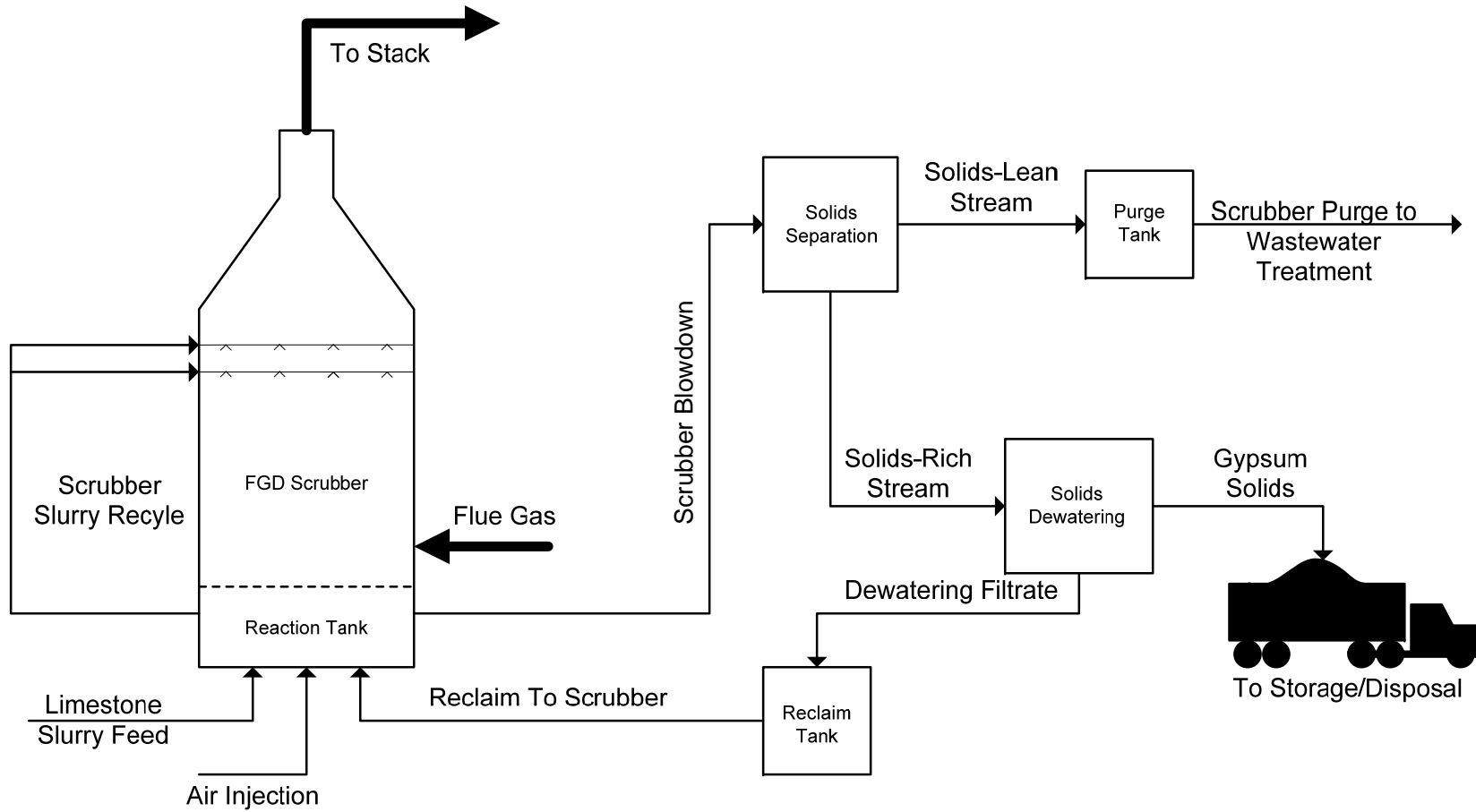

Figure 4-2. Typical Process Flow Diagram for a Limestone Forced Oxidation FGD System

The spray droplets, some containing the calcium sulfite product and others with unreacted limestone, fall to the bottom of the FGD scrubber into a reaction tank. The plant injects air into the reaction tank and vigorously mixes the slurry to oxidize the calcium sulfite to gypsum (see Equation 4-2). The scrubber recycle pumps pump the slurry from the reaction tank to the various spray levels within the FGD scrubber. The plant continuously recirculates the slurry in the FGD scrubber. When the percent solids or the chlorides concentration in the slurry reach a certain high set point in the reaction tank, the plant uses the scrubber blowdown pumps to remove some of the slurry from the FGD scrubber. As the blowdown stream is removed from the scrubber, the levels of solids and chlorides in the scrubber slurry decreases until a low set point is reached within the FGD scrubber. The plant then shuts off the blowdown pumps until the solids and chlorides build up again to the point of triggering a blowdown. Therefore, the scrubber blowdown is typically an intermittent transfer from the scrubber. Some plants, however, operate an FGD scrubber with a continuous blowdown, which can either be a once-through FGD system with no recycle or an FGD system that recycles some of the slurry but is constantly blowing down slurry at a rate that maintains the solids and chlorides levels within a defined operating range.

The parameter used to control the FGD system (e.g., percent solids or chlorides concentration) and the level at which it is controlled varies by plant. Plants maintain a chlorides concentration below the maximum level which the FGD scrubber materials of construction can withstand to prevent corrosion, normally around 12,000 – 20,000 ppm; however, some systems operate with chloride concentrations as low as 2,000 to 3,000 ppm and other plants may operate near 40,000 ppm. Plants also monitor and control the FGD system based on the percent solids because the solids can affect the operation of the FGD system and because the plant must limit the amount of fines (small inert particles) in the gypsum by-product [EPRI, 2006a].

The scrubber blowdown, which for a forced oxidation system is a gypsum slurry, is transferred to a solids separation process. Often, this process uses one or two sets of hydrocyclones, referred to in the industry as hydroclones.¹⁵ The hydroclones separate the gypsum solids from the water using centrifugal force. The gypsum solids are forced outward to the walls of the hydroclones and fall downward, while the water exits the top of the hydroclones. The underflow, or solids-rich stream, from the solids separation process contains the gypsum solids and is transferred to a dewatering process. The overflow, or solids-lean stream (which is mostly water and fines), from the solids separation process is typically transferred to the purge tank.

The solids-rich stream from the solids separation process is transferred to a dewatering process, which is usually a vacuum belt filter or a vacuum drum filter. The dewatering process removes the water from the gypsum, drying the gypsum to its desired moisture content. If the plant intends to market the gypsum for wallboard production, then a vacuum belt filter is typically used because it can dry the gypsum to a lower moisture content than a drum filter. Additionally, the gypsum is usually rinsed with service water at the beginning of the belt filter to reduce the chlorides concentration to meet the wallboard manufacturer's specifications. If the plant does not intend to market the gypsum, then the gypsum does not need to be rinsed and either a vacuum belt or vacuum drum filter can be used for the dewatering because the gypsum

¹⁵ Another approach for solids separation practiced by some plants entails using settling ponds instead of hydroclones or other mechanical devices.

most likely will not need to meet any chloride or moisture content specifications. However, EPA has visited several plants that are currently unable to market the gypsum, but the plant still rinses the gypsum prior to on-site disposal in case a future gypsum market develops for the gypsum. The dried gypsum product is removed from the dewatering process and transferred to a storage area until it is transported off site (for beneficial use or disposal at an off-site landfill) or to a disposal area on site. The filtrate from the dewatering process is recovered in a reclaim tank and either returned to the FGD scrubber or used in the limestone slurry preparation process.

The solids-lean stream from the solids separation process is typically transferred to a purge tank and then sent to a wastewater treatment system and discharged. Alternatively, the solids-lean stream can be transferred to a second solids separation process (e.g., a second set of hydroclones) to remove additional solids prior to wastewater treatment. Many plants that are operating clarifiers in the FGD wastewater treatment system have two stages of solids separation to minimize the size requirements and/or prevent overloading of the clarifier. In this case, the solids-lean stream from the second solids separation process is transferred to the purge tank and the solids-rich stream is typically transferred to the reclaim tank and recycled back to the FGD system or limestone preparation process.

From the purge tank, the scrubber purge¹⁶ is typically transferred to some type of FGD wastewater treatment system, such as a settling pond or a more advanced system (see Section 4.4). It may also be commingled with other wastewater streams (e.g., cooling water or ash pond wastewater) and discharged. Because most FGD treatment systems currently being used do not significantly affect the level of chlorides in the wastewater, the treated FGD wastewater is not recycled back to the FGD scrubber.

Some plants are able to operate their solids removal process in a manner that purges sufficient chlorides along with the solids to allow reuse of the FGD wastewater. For example, plants that dispose of their gypsum solids in a landfill do not typically have to meet specifications for the chlorides or fines content in the gypsum; therefore, these plants can operate the FGD system (including the solids separation and dewatering process) to allow the gypsum to retain more water and, therefore, more chlorides and fines. Operating the system in this manner allows the plant to purge scrubber water (and by extension chlorides and fines) through the solids disposal process. If they are able to purge enough chlorides with the FGD solids, these plants may then be able to recycle the solids-lean stream from the solids separation process. Most of the plants that sell the gypsum for beneficial use have to meet chloride and fines specifications, and therefore, must operate with a scrubber purge stream [Sargent & Lundy, 2007].

4.2.2 Inhibited Oxidation FGD System

Both the forced oxidation and inhibited oxidation FGD systems remove sulfur dioxide from the flue gas; however, in the inhibited oxidation FGD system, a chemical such as emulsified sulfur is added to the system to prevent gypsum from forming during the process.

¹⁶ For the purpose of this document, the scrubber blowdown refers to the slurry stream exiting the FGD scrubber, which is typically transferred to a solids separation process. The scrubber purge refers to the waste stream from the FGD scrubber system (typically from a solids separation process) that is transferred to a wastewater treatment system or discharged. Both the scrubber blowdown and scrubber purge waste streams are depicted in Figure 4-2. In some instances, the scrubber blowdown and scrubber purge may be the same waste stream if the plant does not operate a solids separation process prior to wastewater treatment or discharge.

Many of the plants operating inhibited oxidation systems do not have wastewater treatment systems, other than settling ponds, to treat the scrubber purge. In addition, some plants are able to recycle their FGD wastewater back to the FGD system and, therefore, do not produce a scrubber purge waste stream.

The lime or limestone inhibited oxidation FGD systems work by contacting the flue gas stream with a liquid slurry stream containing a lime ($\text{Ca}(\text{OH})_2$) or limestone sorbent, which effects mass transfer. Equation 4-1 shows the reaction between limestone and sulfur dioxide and Equation 4-3 shows the reaction that occurs between lime and sulfur dioxide, producing hydrated calcium sulfite.

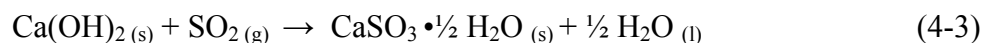

The operation and absorption of the SO_2 in an inhibited oxidation FGD system is similar to the forced oxidation FGD system. A FGD process operation description for a forced oxidation system is presented in Section 4.2.1. The most significant differences between the two systems are that in an inhibited oxidation FGD system, elemental or emulsified sulfur is added to the FGD system, and oxidation air is not introduced to the absorber. The sulfur forms thiosulfate within the FGD system, which is an oxygen scavenger. Because thiosulfate reacts so readily with the dissolved oxygen, it inhibits the calcium sulfite from oxidizing to calcium sulfate, thereby generating a calcium sulfite by-product instead of a gypsum by-product.

Although the operation of the FGD scrubber is similar for the two FGD systems, there are some differences in the solids separation and solids dewatering processes. Figure 4-3 presents a typical process flow diagram for a lime or limestone inhibited oxidation FGD system. One of the major differences between the forced oxidation and inhibited oxidation systems is that inhibited oxidation systems are more likely than forced oxidation systems to be operated in a manner that recycles the solids-lean stream from the solids separation process back to the scrubber, and thus are less likely to discharge a scrubber purge stream.

As is done for the limestone forced oxidation system, the scrubber blowdown is transferred to a solids separation process. The calcium sulfite by-product generated from the inhibited oxidation process is more difficult to dewater than the gypsum by-product generated by the limestone forced oxidation process; therefore, plants operating inhibited oxidation FGD systems typically use a thickener for the solids separation process; however, hydroclones can also be used for inhibited oxidation systems. Thickeners operate with long residence times that allow the solids to settle out of the solution. The underflow, or solids-rich stream, from the solids separation process contains the calcium sulfite and is transferred to a dewatering process which is typically a centrifuge or vacuum drum filter.

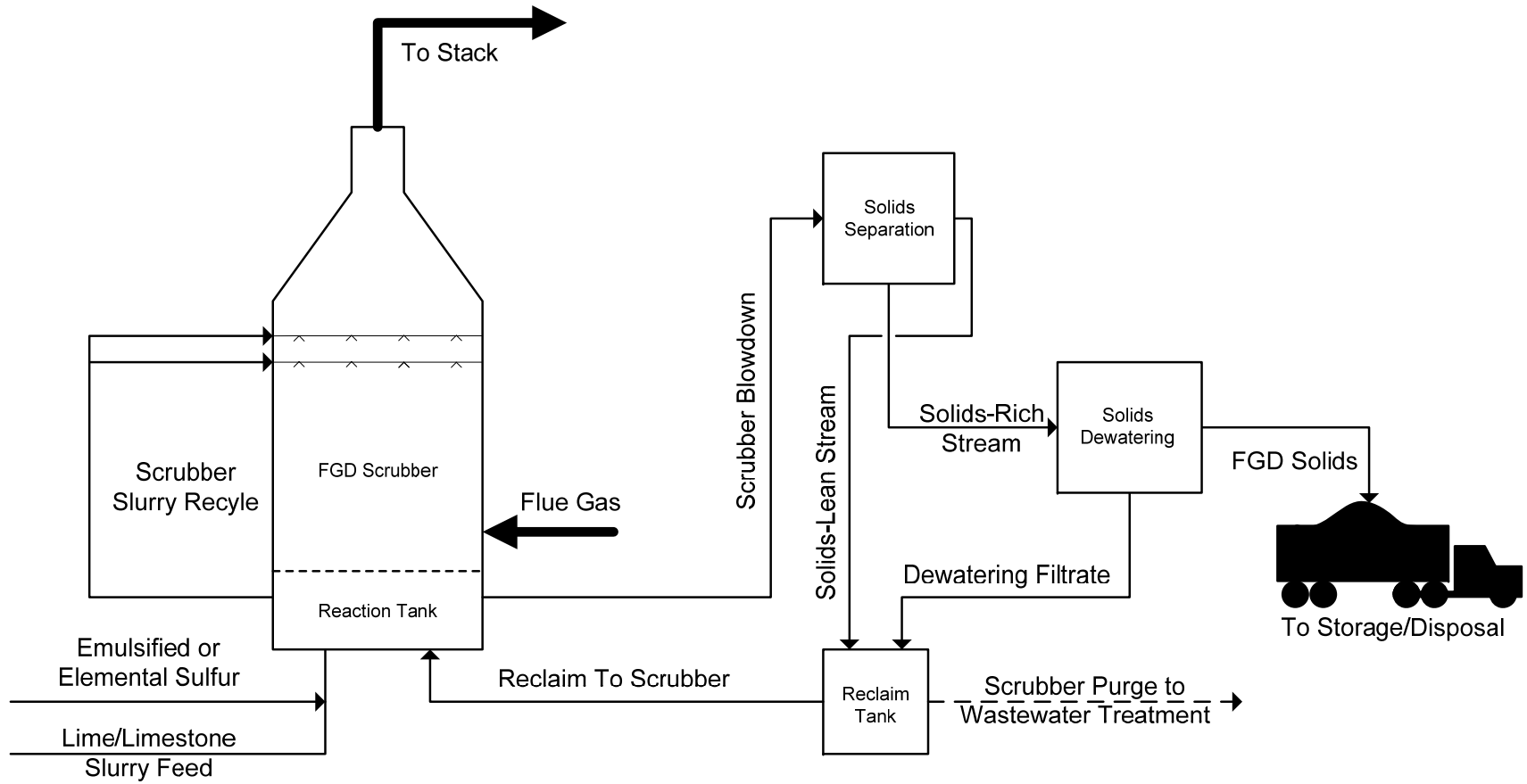

Figure 4-3. Process Flow Diagram for a Lime or Limestone Inhibited Oxidation FGD System

The dewatering process removes water from the calcium sulfite, drying it to its desired moisture content. The filtrate from the dewatering process is transferred to a reclaim tank. The solid cake from the final dewatering process is usually sent to a landfill, either on or off site. Although the calcium sulfite FGD solids can be landfilled after the final dewatering process, some plants operating inhibited oxidation systems further process the calcium sulfite by mixing it with dry fly ash and lime in a pug mill to generate a cementitious material similar to concrete. The resultant cementitious material is transported to a landfill.

The overflow, or solids-lean stream, from the solids separation process and the filtrate from the dewatering process are typically transferred to a reclaim tank. Some of the wastewater collected in the reclaim tank is recycled back to the FGD scrubber process and some may be discharged or transferred to an additional treatment system. Because the inhibited oxidation system typically does not generate a saleable solid product, the solids are typically disposed of in a landfill. Like the limestone forced oxidation systems that are not beneficially using the gypsum, the plant may be able to recycle the FGD wastewater without a purge stream because the chlorides can be removed from the FGD system by retaining the chlorides with the solids that are sent to the landfill [Sargent & Lundy, 2007]. However, not all plants operating inhibited oxidation FGD systems completely recycle the FGD wastewater. For example, Louisville Gas & Electric Company's Cane Run plant stated that they do not achieve complete recycle because of instances where they have accumulated rainfall in their ponds which treat the recycle water. When this happens, they manage the additional water volume by discharging from the FGD ponds.

4.2.3 Other Types of FGD Systems

Natural Oxidation FGD Systems

Sections 4.2.1 and 4.2.2 describe the operation of the forced oxidation and inhibited oxidation systems. A natural oxidation system operates similarly to both the forced oxidation and inhibited oxidation systems, except that air is not fed to the reaction tank to force the oxidation of calcium sulfite to calcium sulfate as in the forced oxidation system; likewise, emulsified sulfur is not added to inhibit the calcium sulfite from oxidizing as in the inhibited oxidation system. In a natural oxidation system, some of the calcium sulfite (typically the majority) is oxidized to calcium sulfate using the dissolved oxygen present in the system; however, because the plant is not forcing the oxidation, some of the calcium sulfite may not oxidize and the FGD process may produce a mixture of calcium sulfite and calcium sulfate. The solids handling associated with the operation of a natural oxidation FGD system is also similar to the solids handling of the forced oxidation and/or the inhibited oxidation systems (see Figure 4-2 and Figure 4-3).

During the detailed study, EPA visited one plant that operates a natural oxidation FGD system. The plant operates a thickener for the solids separation process and a vacuum drum filter for the dewatering process. The FGD solids produced, which consist predominantly of calcium sulfate, are transferred to a third party distributor for sale (primarily to a cement manufacturer). The overflow from the thickeners is transferred to a reclaim tank and is typically reused within the FGD process. The plant occasionally transfers the thickener overflow to a settling pond, which is ultimately discharged [ERG, 2009o].

Dual-Alkali FGD Systems

The dual-alkali FGD process is different from the other FGD processes previously discussed because two alkaline sorbents are used in the process. For this type of FGD system, a soda ash (sodium carbonate, Na_2CO_3) liquor/solution is fed into the FGD scrubber to absorb the sulfur dioxide from the flue gas. The sodium is dissolved in this liquor, and therefore the liquor contains almost no suspended solids. The sodium reacts with the sulfur dioxide and the product is transferred to the reaction tank where the second alkaline sorbent, lime, is added. The lime reacts with this product to generate hydrated calcium sulfite. Additionally, the sodium solution is regenerated in this reaction and can be reused in the scrubbing process. The slurry from the reaction tank is then sent to a solids separation process, such as a thickener. The underflow, or solids-rich stream, from the solids separation process contains mostly calcium sulfite, and is transferred to a dewatering process similar to the description for the lime inhibited oxidation system (see Section 4.2.2). The overflow, or solids-lean stream, that contains the sodium solution is recycled back to the FGD system as the sorbent for the scrubbing process. Because some of the sodium will leave the system with the solids-rich stream from the solids separation process, a make-up soda ash solution is added to the sodium solution that is recycled back to the FGD scrubber.

Dry FGD Systems

A dry FGD system is a spray dryer absorption process in which a lime slurry removes sulfur dioxide from the flue gas. These dry FGD systems are also sometimes referred to as semi-dry FGD systems because a wet slurry is injected into the flue gas; a dry sorbent is not used in the process. In the dry FGD process, the wet lime slurry, which ranges from approximately 18 to 25 percent solids, is atomized and sprayed into the spray dryer. The percent solids in the lime slurry is calculated to control the sulfur dioxide removal from the flue gas but also allows for essentially all the water to evaporate within the spray dryer. The flue gas can enter the spray dryer from one or more different locations and typically enters through a disperser to allow for effective contact with the atomized spray droplets. The sulfur dioxide in the flue gas is absorbed by the spray droplets and reacts with the lime to generate calcium sulfite. These reactions take place in the aqueous phase of the spray droplets at the same time that the heat from the flue gas is evaporating the water from the spray droplets. The evaporation of the water cools the flue gas and produces a calcium sulfite product with low moisture content [Babcock & Wilcox, 2005].

The flue gas exiting the spray dryer is then transferred to a particulate removal system (e.g., electrostatic precipitator (ESP) or baghouse), which collects the solids generated in the spray dryer and some unreacted lime, as well as fly ash if there is no particulate removal system upstream of the spray dryer. A plant may operate a pre-collection particulate removal system if it intends to market the fly ash generated. The particulates removed from the process are usually transferred to a silo for storage until the plant disposes of the material or transfers it off site. Additionally, the solids removed from the particulate removal process can be reused in the process as slurry feed to reduce lime usage. This recycle also has the benefit of using the inherent alkalinity in the fly ash for the sulfur dioxide absorption. In these recycle systems, some of the solids removed from the particulate removal process are mixed with water to approximately 35 to 45 percent solids and returned to the process. Not all of the solids can be recycled for the process; therefore, the remaining solids are stored on site, sold for beneficial use, or disposed of in a landfill [Babcock & Wilcox, 2005].

4.3 FGD Wastewater Characteristics

This section discusses the pollutant characteristics and flow rates for FGD wastewaters based on information EPA collected during the detailed study. Pollutant concentration data are presented for samples collected during the EPA wastewater sampling program and monitoring data provided by the individual plants/companies. These pollutant concentration data represent information from limestone forced oxidation systems. This section also presents flow rate data from EPA's site visit and sampling program and responses to EPA's data request. These flow rate data include information from limestone forced oxidation systems, as well as non-forced oxidation systems. Chapter 2 describes EPA's data collection activities.

The FGD system works by contacting the flue gas stream with a slurry stream containing a sorbent. The contact between the streams allows for a mass transfer of sulfur dioxide as it is absorbed into the slurry stream. Other pollutants in the flue gas (e.g., metals, nitrogen compounds, chloride) are also transferred to the scrubber slurry and leave the FGD system via the scrubber blowdown (i.e., the slurry stream exiting the FGD scrubber that is not immediately recycled back to the spray/tray levels). Depending upon the pollutant, the type of solids separation process and the solids dewatering process used, the pollutants may partition to either the solid phase (i.e., FGD solids) or the aqueous phase (i.e., scrubber purge waste stream).

As described in Section 4.2 and shown in Figure 4-2 and Figure 4-3, the FGD scrubber blowdown is typically intermittently transferred from the FGD scrubber to the solids separation process. As a result, the FGD scrubber purge (i.e., the waste stream from the FGD scrubber system that is transferred to a wastewater treatment system or discharged) is also usually intermittent. Factors that can affect the characteristics and flow rate of the FGD scrubber purge wastewater include the type of coal, scrubber design and operating practices, solids separation process, and solids dewatering process used at the plant.

The type of coal burned at the plant can affect the FGD scrubber purge flow rate associated with the system. Generally, burning a higher sulfur coal will lead to a higher flow rate for the scrubber blowdown and scrubber purge. Higher sulfur coals produce more sulfur dioxide in the combustion process, which in turn increases the amount of sulfur dioxide removed in the FGD scrubber. As a result, more solids are generated in the reaction in the scrubber, which increases blowdown volumes.

Likewise, a high chlorine coal can increase the volume and frequency of the scrubber blowdown and scrubber purge. Many FGD systems are designed with materials resistant to corrosion for specific chloride concentrations. An electric generating unit burning coal with higher chlorine content will more quickly reach the maximum allowable chloride concentration in the scrubber, which may trigger more frequent blowdowns. In addition, the plant will need to purge more FGD wastewater from the system to prevent chlorides from building up to an unacceptable concentration.

Table 4-4 summarizes the FGD scrubber purge flow rates reported in the data request responses and collected during EPA's site visit and sampling program. In Table 4-4, there are 26 plants that operate a total of 57 wet FGD systems, which scrub the flue gas from 65 coal-fired electric generating units. The size of the plants varies from scrubbed capacities of 300 to 2,700 MW. The average scrubbed capacity per plant is 1,310 MW, with a median scrubbed capacity of

1,330 MW/plant. Most of the plants operate limestone forced oxidation systems; however, several plants operate lime inhibited oxidation systems.

Table 4-4. FGD Scrubber Purge Flow Rates

	Number of Plants	Average Flow Rate	Median Flow Rate	Range of Flow Rate
Flow Rate per Plant				
gpm/plant	26	448	340	30.0 – 2,300
gpd/plant	26	598,000	410,000	24,300 – 3,310,000
gpy/plant	26	211,000,000	142,000,000	4,980,000 – 1,210,000,000
Normalized Flow Based on Wet-Scrubbed Capacity				
gpm/scrubbed MW	26	0.423	0.250	0.0365 – 2.04
gpd/scrubbed MW	26	578	301	19.7 – 2,940
gpy/scrubbed MW	26	202,000	106,000	2,500 – 1,070,000

Source: Data request information [U.S. EPA, 2008a] and site visit and sampling information.

a – The flow rates presented have been rounded to three significant figures.

b – The instantaneous (gpm) flow rate represents the rate during the actual purge, unless it is a design scrubber purge flow rate for a planned FGD wastewater treatment system installation.

c – Because some FGD scrubber purge flows are intermittent, instantaneous rates cannot be directly used to calculate daily and annual average flows.

Table 4-4 presents the actual purge flow rates for the 26 plants, as well as calculated normalized purge flow rates that are based on the plants' wet scrubbed capacity. The scrubber purge flow rates reported, including the normalized flow rates, vary significantly from plant to plant. Figure 4-4 and Figure 4-5 present the distribution of the scrubber purge flow rates for the 26 plants included in Table 4-4. The majority of plants report scrubber purge flow rates less than 1.5 mgd. However, one plant operates a once-through FGD system (i.e., no recirculation of the scrubber slurry) and has a scrubber purge flow rate exceeding 3 mgd (see Figure 4-4). There are three plants that have normalized scrubber purge flow rates greater than 2,000 gpd/MW scrubbed. One of the three plants operates a once-through FGD system, as described above. The other two plants operate lime inhibited oxidation systems that transfer the FGD wastewater to a settling pond for treatment. Because these plants are generating a calcium sulfite byproduct, which is not marketable, and the scrubber purge is being transferred to a settling pond for treatment, the plants are transferring the entire scrubber blowdown to the settling pond (i.e., there is no solids separation process). For this reason, the normalized scrubber purge flow rate for these plants is larger than the other plants because the solids, as well as the water retained in the solids, are included in the scrubber purge flow rate.

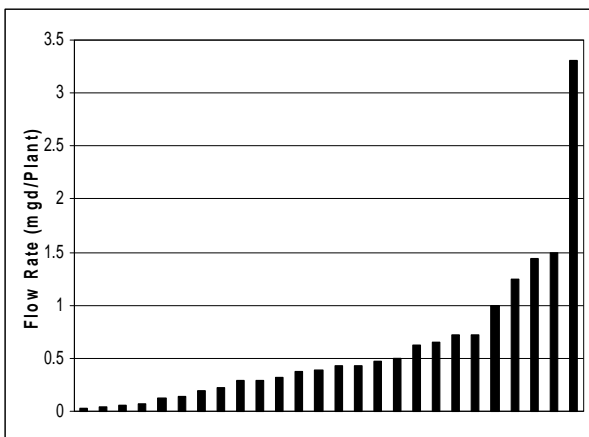

Figure 4-4. Distribution of FGD Scrubber Purge Daily Flow Rates

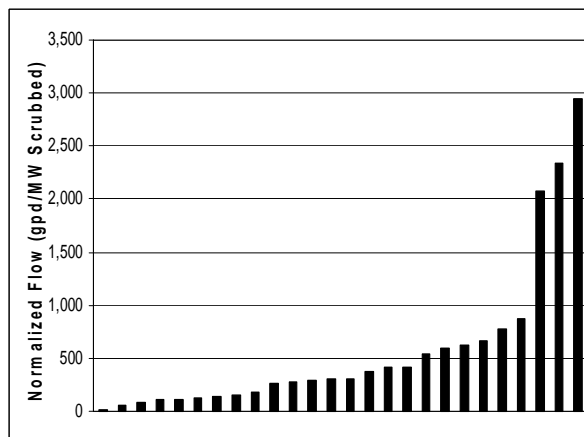

Figure 4-5. Distribution of FGD Scrubber Purge Normalized Daily Flow Rates

Source: Data request information [U.S. EPA, 2008a] and site visit and sampling information.

The average gpd/plant and gpd/scrubbed MW purge flow rates calculated for these 26 plants are similar to the FGD blowdown stream flow rates EPA observed when developing the effluent guidelines promulgated in 1982 (671,000 gpd/plant and 811 gpd/MW) [U.S. EPA, 1982].

The pollutant concentrations in FGD scrubber purge vary from plant to plant depending on the coal type, the sorbent used, the materials of construction in the FGD system, the FGD system operation, and the air pollution control systems operated upstream of the FGD system. The coal is the source of the majority of the pollutants that are present in the FGD wastewater (i.e., the pollutants present in the coal are likely to be present in the FGD wastewater). The sorbent used in the FGD system also introduces pollutants into the FGD wastewater and therefore, the type and source of the sorbent used affects the pollutant concentrations in the FGD wastewater.

The air pollution controls operated upstream of FGD system can also affect the pollutant concentrations in the FGD wastewater. For example, if a plant does not operate a particulate collection system (e.g., ESP) upstream of the FGD system, then the FGD system will act as the particulate control system and the FGD blowdown exiting the scrubber will contain fly ash and other particulates. As a result, the FGD scrubber purge will likely contain increased amounts of pollutants associated with the fly ash.

Research conducted by EPA's ORD has observed that the use of post-combustion NOx controls (e.g., SCR and SNCR) is correlated to an increased fraction of chromium in CCR (including FGD wastes) being oxidized to hexavalent chromium (Cr^{+6}), a more toxic form of chromium than trivalent chromium (Cr^{+3}). Hexavalent chromium is more a soluble form of chromium than the Cr^{+3} usually measured in CCRs, which could explain why ORD has observed increased leachability of chromium when post-combustion NOx controls are operating [U.S. EPA, 2008c].

The materials of construction in the FGD system and the FGD system operation affect the pollutants present in the wastewater, as well as the levels of the pollutants. The use of organic

acid additives contributes to higher levels of BOD5 in the FGD scrubber purge. Additionally, the type of oxidation (i.e., forced oxidation, inhibited oxidation, natural oxidation) in the FGD system has the potential to affect the form of the pollutants present in the FGD wastewater. The materials of construction and the other FGD system operations can also affect the levels of pollutants present in the FGD wastewater because as discussed previously, they affect the rate at which scrubber purge is generated. For example, the larger the maximum allowable chlorides concentration in the scrubber, the lower the scrubber purge flow rate; however, this leads to additional cycling in the scrubber, which increases the pollutant concentrations present in the FGD wastewater.

Table 4-5 presents the pollutant concentrations representing the influent to the FGD wastewater treatment systems for the FGD wastewaters that EPA sampled.¹⁷ FGD wastewater contains significant concentrations of chloride, TDS, nutrients, and metals, including bioaccumulative pollutants such as arsenic, mercury, and selenium. Table 4-5 also shows that some of the pollutants are more likely to be present in the particulate phase (e.g., aluminum, chromium, mercury), whereas other pollutants are almost exclusively present in the dissolved phase (e.g., boron, magnesium, manganese).

For the Big Bend sampling episode, EPA collected a grab sample of the influent to the wastewater treatment system downstream of the equalization tank feeding the treatment system. The equalization tank receives FGD scrubber purge from secondary hydroclones, treatment system recirculation flows, and other related treatment process waste streams. During sampling, the plant was recirculating 154 gpm off-specification filter press filtrate to the equalization tank, which caused the plant to divert some of the FGD scrubber purge away from the equalization tank. As a result, the scrubber purge comprised only one-third (96 gpm of 250 gpm) of the total influent-to-treatment flow sampled by EPA. The sampling episode report for Big Bend contains more detailed information regarding the sampling event [ERG, 2008n].

For the Homer City sampling episode, EPA collected a grab sample of the influent to the wastewater treatment system downstream of the equalization tank feeding the treatment system. The equalization tank receives FGD scrubber purge from the secondary hydroclones and backwash from sand filters. During sampling, the flow rate from the equalization tank to the wastewater treatment system was 109 gpm. The sampling episode report for Homer City contains more detailed information regarding the sampling event [ERG, 2008l].

¹⁷ Note that the influent-to-treatment sample obtained for a given plant does not necessarily represent the unaltered scrubber purge, since the sample collected may include both scrubber purge and treatment system recirculation flow streams.

Table 4-5. Influent to FGD Wastewater Treatment System Concentrations

Analyte	Method	Unit	Big Bend – Influent to FGD Wastewater Treatment ^a	Homer City – Influent to FGD Wastewater Treatment ^a	Widows Creek – FGD Scrubber Blowdown ^a	Mitchell – FGD Scrubber Purge ^a	Belews Creek – FGD Scrubber Purge ^a	
Routine Total Metals – 200.7								
Aluminum	200.7	µg/L	31,200	289,000	234,000	17,900	33,100	R
Antimony	200.7	µg/L	62.5	86.4	ND (86.9)	28.7	18.1	R
Arsenic	200.7	µg/L	75.5	1,590	523	72.5	236	
Barium	200.7	µg/L	1,590	11,900 R	7,200	588	651	
Beryllium	200.7	µg/L	12.9	28.8	44.3	8.04	3.60	R
Boron	200.7	µg/L	626,000	224,000	28,900	229,000	307,000	R
Cadmium	200.7	µg/L	224	150	89.2	19.7	ND (0.250)	
Calcium	200.7	µg/L	6,690,000	3,220,000	5,990,000	3,030,000	6,070,000	
Chromium	200.7	µg/L	757	1,400	1,360	70.7	84.8	R
Cobalt	200.7	µg/L	172	369	ND (217)	68.0	14.7	R
Copper	200.7	µg/L	120	811	653	164	37.6	
Iron	200.7	µg/L	23,500	824,000	299,000	60,600	59,100	R
Lead	200.7	µg/L	69.1	340	436	103	31.2	R
Magnesium	200.7	µg/L	4,830,000	2,760,000	321,000	1,470,000	990,000	
Manganese	200.7	µg/L	21,900	225,000	2,780	28,800	9,020	R
Mercury	245.1	µg/L	ND (10.0)	243	26.5	67.5	NA	
Molybdenum	200.7	µg/L	618	375	1,340	65.0	NA	
Nickel	200.7	µg/L	2,090	2,560 R	489	554	1.59	R
Selenium	200.7	µg/L	4,150	4,000 R	652	2,130	2,930	R
Silver	200.7	µg/L	ND (20.0)	ND (40.0)	ND (86.9)	ND (20.0)	10.0	
Sodium	200.7	µg/L	2,530,000	1,430,000	104,000	314,000	61,000	
Thallium	200.7	µg/L	ND (10.0)	Exclude	ND (43.4)	ND (10.0)	41.2	R
Titanium	200.7	µg/L	420	1,300 R	8,180	377	NA	
Vanadium	200.7	µg/L	724	766	1,580	203	77.6	
Yttrium	200.7	µg/L	245	586	217	64.9	NA	

Table 4-5. Influent to FGD Wastewater Treatment System Concentrations

Analyte	Method	Unit	Big Bend – Influent to FGD Wastewater Treatment ^a	Homer City – Influent to FGD Wastewater Treatment ^a	Widows Creek – FGD Scrubber Blowdown ^a	Mitchell – FGD Scrubber Purge ^a	Belews Creek – FGD Scrubber Purge ^a
Zinc	200.7	µg/L	1,540	1,900	3,140	885	ND (25.0)
Routine Dissolved Metals – 200.7							
Aluminum	200.7	µg/L	ND (50.0)	ND (50.0)	86.6	ND (50.0)	ND (50.0)
Antimony	200.7	µg/L	33.9	ND (20.0)	ND (20.0)	ND (20.0)	ND (4.00)
Arsenic	200.7	µg/L	18.6	ND (10.0)	13.9	ND (10.0)	24.7 R
Barium	200.7	µg/L	1,820	149 R	257	488	489 R
Beryllium	200.7	µg/L	ND (5.00)	10.5	ND (5.00)	6.02	ND (1.00)
Boron	200.7	µg/L	618,000	254,000	24,100	232,000	301,000 R
Cadmium	200.7	µg/L	179	26.2	ND (5.00)	ND (5.00)	ND (0.250)
Calcium	200.7	µg/L	4,470,000	1,990,000	849,000	2,350,000	5,370,000
Chromium	200.7	µg/L	ND (10.0)	ND (10.0)	18.7	ND (10.0)	19.2 R
Hexavalent Chromium	D1687-92	µg/L	24.0	ND (2.00)	ND (2.00)	5.00	4.20
Cobalt	200.7	µg/L	ND (50.0)	201	ND (50.0)	ND (50.0)	8.40 L,R
Copper	200.7	µg/L	27.2	14.5	ND (10.0)	ND (10.0)	ND (2.50)
Iron	200.7	µg/L	ND (100)	ND (100)	ND (100)	ND (100)	ND (25.0)
Lead	200.7	µg/L	ND (50.0)	ND (50.0)	ND (50.0)	ND (50.0)	ND (1.50)
Magnesium	200.7	µg/L	4,110,000	3,100,000	176,000	1,370,000	955,000 R
Manganese	200.7	µg/L	9,610	173,000	583	27,900	8,540
Mercury	245.1	µg/L	ND (10.0)	ND (10.0)	ND (2.00)	ND (10.0)	NA
Molybdenum	200.7	µg/L	581	30.6	876	22.2	NA
Nickel	200.7	µg/L	851	1,350	ND (50.0)	355	105 R
Selenium	200.7	µg/L	3,610	656 R	366	46.9	105 R
Silver	200.7	µg/L	ND (20.0)	ND (20.0)	ND (20.0)	ND (20.0)	7.80
Sodium	200.7	µg/L	1,970,000	1,440,000	76,700	324,000	58,700
Thallium	200.7	µg/L	14.3	61.2	14.3	ND (10.0)	106 R
Titanium	200.7	µg/L	12.5	ND (10.0)	ND (10.0)	ND (10.0)	NA

Table 4-5. Influent to FGD Wastewater Treatment System Concentrations

Analyte	Method	Unit	Big Bend – Influent to FGD Wastewater Treatment ^a	Homer City – Influent to FGD Wastewater Treatment ^a	Widows Creek – FGD Scrubber Blowdown ^a	Mitchell – FGD Scrubber Purge ^a	Belews Creek – FGD Scrubber Purge ^a
Vanadium	200.7	µg/L	108	ND (20.0)	ND (20.0)	ND (20.0)	2.00 R
Yttrium	200.7	µg/L	ND (5.00)	6.28	ND (5.00)	ND (5.00)	NA
Zinc	200.7	µg/L	16.8	ND (10.0)	ND (10.0)	87.8	ND (25.0)
Low-Level Total Metals – 1631E, 1638, HG-AFS							
Antimony	1638	µg/L	24.9	31.1	51.8	9.23	17.6 R
Arsenic	1638	µg/L	165	1,220	617	59.9	1,270
Arsenic	1638 – DRC	µg/L	NA	NA	NA	NA	1,010 R
Arsenic	HG-AFS	µg/L	NA	NA	NA	NA	929
Cadmium	1638	µg/L	238	52.8 R	86.0	5.28	4.84 R
Chromium	1638	µg/L	651 L	1,270	1,380	176 L	256
Chromium	1638 – DRC	µg/L	NA	NA	NA	NA	262 R
Copper	1638	µg/L	103	747	826	139	188 R
Lead	1638	µg/L	69.9	351	545	68.1	193 R
Mercury	1631E	µg/L	16.4	533	24.7	138	85.6
Nickel	1638	µg/L	2,570	2,840	634	650	1,240
Nickel	1638 – DRC	µg/L	NA	NA	NA	NA	396 R
Selenium	1638	µg/L	3,470	3,530	651	1,990	8,660
Selenium	1638 – DRC	µg/L	NA	NA	NA	NA	8,250 R
Selenium	HG-AFS	µg/L	NA	NA	NA	NA	9,100
Thallium	1638	µg/L	39.8	37.3	93.8	6.33	9.51 R
Zinc	1638	µg/L	1,870	2,130	2,720	730	438
Zinc	1638 – DRC	µg/L	NA	NA	NA	NA	526 R
Low-Level Dissolved Metals - 1631E, 1636, 1638, HG-AFS							
Antimony	1638	µg/L	21.9	ND (0.400)	8.90	1.97	3.83
Arsenic	1638	µg/L	137	24.2 R	18.0	20.2	133
Arsenic	1638-DRC	µg/L	NA	NA	NA	NA	17.4 R

Table 4-5. Influent to FGD Wastewater Treatment System Concentrations

Analyte	Method	Unit	Big Bend – Influent to FGD Wastewater Treatment ^a	Homer City – Influent to FGD Wastewater Treatment ^a	Widows Creek – FGD Scrubber Blowdown ^a	Mitchell – FGD Scrubber Purge ^a	Belews Creek – FGD Scrubber Purge ^a
Arsenic	HG-AFS	µg/L	NA	NA	NA	NA	11.4
Cadmium	1638	µg/L	190	24.5	3.16	ND (1.00)	4.47
Chromium	1638	µg/L	ND (160)	ND (16.0)	ND (16.0)	ND (80.0)	19.1
Chromium	1638-DRC	µg/L	NA	NA	NA	NA	ND (5.00)
Copper	1638	µg/L	ND (40.0)	11.3	ND (4.00)	ND (20.0)	ND (5.00)
Lead	1638	µg/L	ND (10.0)	ND (1.00)	ND (1.00)	ND (0.500)	ND (2.00)
Mercury	1631E	µg/L	0.206	0.0809	0.0761	0.0111	0.0844
Nickel	1638	µg/L	1,030	1,450	29.6	433	382
Nickel	1638-DRC	µg/L	NA	NA	NA	NA	316 R
Selenium	1638	µg/L	3,280	584	325	443	468
Selenium	1638-DRC	µg/L	NA	NA	NA	NA	412 R
Selenium	HG-AFS	µg/L	NA	NA	NA	NA	206
Thallium	1638	µg/L	39.4	23.2	22.5	4.47	11.1 R
Zinc	1638	µg/L	ND (100)	34.7	ND (10.0)	160	78.6
Zinc	1638-DRC	µg/L	NA	NA	NA	NA	69.7 R
Classicals							
Ammonia As Nitrogen (NH ₃ -N)	4500-NH ₃ F ^b	mg/L	31.5	4.12	2.26	1.89	1.50
Nitrate/Nitrite (NO ₃ -N + NO ₂ -N)	353.2	mg/L	NA	54.5	1.00	20.6	14.7
Total Kjeldahl Nitrogen (TKN)	4500-N,C ^b	mg/L	51.6	14.2	22.3	13.3	6.20
Biochemical Oxygen Demand (BOD)	5210B	mg/L	1,370	ND (120)	172	21.0	ND (4.00)
Chemical Oxygen Demand (COD)	5220 C	mg/L	NA	NA	NA	NA	304
Chloride	4500-CL-C ^b	mg/L	24,200	11,800	832	7,200	9,680
Hexane Extractable Material (HEM)	1664A	mg/L	ND (6.00)	ND (5.00)	22.0	11.0	ND (5.00)

Table 4-5. Influent to FGD Wastewater Treatment System Concentrations

Analyte	Method	Unit	Big Bend – Influent to FGD Wastewater Treatment ^a	Homer City – Influent to FGD Wastewater Treatment ^a	Widows Creek – FGD Scrubber Blowdown ^a	Mitchell – FGD Scrubber Purge ^a	Belews Creek – FGD Scrubber Purge ^a
Silica Gel Treated HEM (SGT-HEM)	1664A	mg/L	NA	NA	6.00 ^E	ND (5.00)	ND (5.00)
Sulfate	D516-90 ^b	mg/L	3,590	6,920	11,900	1,640	1,290
Total Dissolved Solids (TDS)	2540 C	mg/L	44,600	23,200	4,740	18,100	34,600
Total Phosphorus	365.3 ^b	mg/L	0.990	2.64	10.5	3.57	9.90
Total Suspended Solids (TSS)	2540 D	mg/L	4,970	13,300	25,300 ^E	7,320	5,200

Source: [ERG, 2008l; ERG, 2008m; ERG, 2008n; ERG, 2008o; ERG, 2009q].

Note: EPA used several analytical methods to analyze for metals during the sampling program. For the purposes of sampling program, EPA designated some of the analytical methods as “routine” and some of them as “low-level.” EPA designated all of the methods that require the use of clean hands/dirty hands sample collection techniques (i.e., EPA Method 1669 sample collection techniques) as “low-level” methods. Note that although not required by the analytical method, EPA used clean hands/dirty hands collection techniques for all low-level and routine metals samples.

a – The concentrations presented have been rounded to three significant figures.

b – The method used for the Belews Creek sampling analysis is different than the method presented in the table. See Table 2-3 for details.

DRC – Dynamic reaction cell. For the Belews Creek analysis, a DRC was used in combination with EPA Method 1638 for certain analytes.

E – Sample analyzed outside holding time.

HG-AFS – Hydride generation and atomic fluorescence spectrometry.

L – Sample result between 5x and 10x the blank result.

R – MS/MSD % recovery outside method acceptance criteria.

Exclude – Results were excluded because the MS/MSD samples had a zero percent recovery.

NA – Not analyzed.

ND – Not detected (number in parentheses is the report limit). The sampling episode reports for each of the individual plants contains additional sampling information, including analytical results for analytes measured above the detection limit, but below the reporting limit (i.e., J-values).

Widows Creek operates once-through FGD scrubbers (i.e., no recirculation of slurry within the absorber), with the scrubber blowdown continuously sent to settling ponds. For the Widows Creek sampling episode, EPA collected a four-hour composite sample of the influent to the FGD settling pond from a diked channel containing FGD scrubber blowdown from the two FGD scrubbers. EPA collected the samples from the diked channel at a point downstream of the influent to the channel to allow for some initial solids settling, but upstream of the inlet to the FGD settling pond. At the time of the sampling, although one of the electric generating units operating a FGD system was shut down and therefore not sending flue gases through the scrubber, the plant continued to transfer water from the scrubber to the FGD settling pond. The flow rate entering the open water area of the FGD settling pond at the time of sampling was approximately 1,170 gpm, and plant personnel estimated that approximately 390 gpm of the flow rate (one-third of the entire flow) was from the FGD system of the electric generating unit that was shut down. The sampling episode report for Widows Creek contains more detailed information regarding the sample collection procedures [ERG, 2008o].

For the Mitchell sampling episode, EPA collected a grab sample of the FGD scrubber purge transfer to the FGD wastewater treatment system. The sample collected contained only FGD scrubber purge, which was transferred to the system at a flow rate of approximately 500 gpm. The sampling episode report for Mitchell contains more detailed information regarding the sampling event [ERG, 2008m].

For the Belews Creek sampling episode, EPA collected a grab sample of the FGD scrubber purge transfer to the FGD wastewater treatment system. The sample collected contained only FGD scrubber purge, which was transferred from the purge tank to the system at a flow rate of 489 gpm during the sample collection. The sampling episode report for Belews Creek contains more detailed information regarding the sampling event [ERG, 2009q].

EPA also collected self-monitoring data for the FGD scrubber purge from four plants. Table 4-6 presents the number of facilities that reported concentration data for specific analytes, the total number of samples from all the plants for each analyte, and the average, minimum, and maximum concentrations for all the monitoring data. These monitoring data were used along with EPA's sampling data to calculate the pollutant mass loads in scrubber purge, as discussed in Section 4.6.

The monitoring data collected from industry confirm EPA's sampling data and demonstrate that FGD scrubber purge wastewater contains significant concentrations of chloride, TSS, TDS, and metals. The type of treatment system operated at an individual plant is typically dependent on the permit limits that the plant must meet. Section 4.4 describes the wastewater treatment systems planned or currently operated by coal-fired power plants to treat FGD wastewaters.

Table 4-6. FGD Scrubber Purge Self-Monitoring Data

Analyte	Number of Plants	Number of Samples	Minimum Concentration	Maximum Concentration ^a	Units
Total Metals					
Aluminum	1	38	8,200	333,000	µg/L
Antimony	1	38	4.1	23	µg/L
Arsenic	4	99	58	5,070	µg/L
Barium	1	38	110	2,050	µg/L
Beryllium	1	38	ND (0.7)	113	µg/L
Boron	3	95	7,410	250,000	µg/L
Cadmium	2	51	ND (0.5)	302	µg/L
Chromium	2	51	1.7	350	µg/L
Cobalt	1	38	6.4	148	µg/L
Copper	2	43	12.8	456	µg/L
Iron	3	79	1,100	300,000	µg/L
Lead	1	38	14.7	252	µg/L
Magnesium	1	13	1,200,000	1,800,000	µg/L
Manganese	1	38	339	5,460	µg/L
Mercury	4	132	ND (0.1)	872	µg/L
Molybdenum	1	38	ND (2)	250	µg/L
Nickel	3	67	23.4	710	µg/L
Selenium	4	158	400	21,700	µg/L
Silver	3	44	ND (0.2)	65	µg/L
Thallium	2	46	ND (4)	746	µg/L
Vanadium	1	38	14.2	14,800	µg/L
Zinc	4	72	33.1	1,060	µg/L
Dissolved Metals					
Mercury	1	17	60	440	µg/L
Selenium	2	33	130	3,000	µg/L
Classicals					
BOD ₅	1	8	3.40	21.0	mg/L
COD	2	49	140	1,100	mg/L
Total suspended solids	2	111	24.0	14,000	mg/L
Total dissolved solids	3	106	6,500	26,000	mg/L
Sulfate	4	85	780	4,100	mg/L
Chloride	4	104	1,100	13,000	mg/L
Bromide	1	28	43.0	96.0	mg/L
Fluoride	1	37	6.80	57.0	mg/L
Nitrate/nitrite	2	76	ND (10.0)	270	mg/L
Total Kjeldahl nitrogen	2	37	2.80	24.0	mg/L
Total phosphorus	1	1	4.00	4.00	mg/L

Source: [ERG, 2009x].

a – The maximum concentration presented is the maximum detected value in the data set, unless all the results in the data set were not detected for the analyte.

4.4 FGD Wastewater Treatment Technologies

During this detailed study, EPA identified and investigated wastewater treatment systems operated by steam electric plants for the treatment of FGD scrubber purge, as well as operating/management practices that were used to reduce the discharge of FGD wastewater. This section describes the following technologies:

- Settling ponds;
- Chemical precipitation (using hydroxide and/or sulfide precipitation);
- Biological treatment;
- Constructed wetlands;
- Vapor-compression evaporation system;
- Design/operating practices achieving zero discharge; and
- Other technologies under investigation.

Most plants currently discharging FGD wastewater use settling ponds; however, the use of more advanced wastewater treatment systems is increasing to a limited extent due to more stringent requirements imposed by some states on a site-specific basis. Section 4.4.8 presents information EPA has compiled on the types of FGD wastewater treatment systems currently operating or expected to be installed.

4.4.1 Settling Ponds

Settling ponds are designed to remove particulates from wastewater by means of gravity. For this to occur, the wastewater must stay in the pond long enough to allow sufficient time for particles to fall out of suspension before being discharged from the pond. The size and configuration of settling ponds varies by plant; some settling ponds operate as a system of several ponds, while others consist of one large pond. The ponds are initially sized to provide a certain residence time to reduce the TSS levels in the wastewater and to allow for a certain life-span of the pond based on the expected rate of solids buildup within the pond. Coal-fired power plants do not typically add treatment chemicals to settling ponds, other than to adjust the pH of the wastewater before it exits the pond to bring it into compliance with NPDES permit limits.

Settling ponds can reduce the amount of TSS in wastewater, as well as specific pollutants that are in particulate form, provided that the settling pond has a sufficiently long residence time; however, settling ponds are not designed to reduce the amount of dissolved metals in the wastewater. The FGD wastewater entering a treatment system contains significant concentrations of several pollutants in the dissolved phase, including boron, manganese, and selenium. These dissolved metals are likely discharged largely unremoved from FGD wastewater settling ponds. Additionally, EPRI has reported that adding FGD wastewater to ash ponds may reduce the settling efficiency in the ash ponds, due to gypsum particle dissolution, thus increasing the effluent TSS concentration [EPRI, 2006b]. EPRI has also reported that the FGD wastewater includes high loadings of volatile metals which can impact the solubility of metals in the ash pond, thereby potentially leading to increases in the effluent metal concentrations [EPRI, 2006b]. Section 5.4.1 contains a more detailed discussion of this topic.

EPA compiled data for plants operating wet FGD systems and wastewater treatment systems used to treat the FGD wastewaters generated. Based on these data, settling ponds are the most commonly used systems for managing FGD wastewater. Most plants using ponds transfer

FGD scrubber purge directly to a settling pond that also treats other waste streams, specifically fly ash transport water and/or bottom ash transport water. Approximately one-third of the plants using FGD ponds transfer the FGD scrubber purge to a settling pond specifically designated to treat FGD wastewater. In these cases, the FGD wastewater pond effluent is either discharged directly to surface waters (with or without first mixing with cooling water or other large volume wastes streams) or transferred to an ash pond for further settling and dilution.

EPA has also identified two plants (one currently operating an FGD system and one planned) that transfer the FGD scrubber purge to a settling pond for initial solids removal and then transfer the wastewater to a biological treatment system for further treatment.

EPA reviewed information to determine whether the use of settling ponds to treat FGD wastewater was limited to relatively older scrubbers. Approximately 20 percent of the plants using settling ponds began operating an additional wet FGD system after 2000. Each of these plants was already operating another FGD system prior to 2000. This suggests plants do not replace the settling pond treatment system with a more advanced system when a new FGD system is installed; instead, the plants begin transferring the additional FGD wastewater to the existing treatment system. In addition, some plants currently without scrubbers have announced that they intend to rely on settling ponds to treat their FGD wastewater. The information compiled by EPA for this study indicates that the use of pond systems will continue to be significant in the future, with about half of plants discharging FGD wastewater in 2020 using settling ponds.

4.4.2 Chemical Precipitation

In a chemical precipitation wastewater treatment system, chemicals are added to the wastewater to alter the physical state of dissolved and suspended solids to facilitate settling and removal of the solids. The specific chemical(s) used depends upon the type of pollutant requiring removal. Steam electric plants commonly use the following three types of precipitation systems to precipitate metals out of FGD wastewater:

- Hydroxide precipitation;
- Iron coprecipitation; and
- Sulfide precipitation.

In a hydroxide precipitation system, lime (calcium hydroxide) is often added to elevate the pH of the wastewater and help precipitate metals into insoluble metal hydroxides that can be removed by settling or filtration. Sodium hydroxide can also be used in a hydroxide chemical precipitation system, but it is more expensive than lime and therefore, not used as commonly.

Many plants use iron coprecipitation as a way to increase the removal of metals in a hydroxide precipitation system. Ferric or ferrous chloride can also be added to the precipitation system to coprecipitate additional metals and organic matter. The ferric chloride also acts as a coagulant, forming a dense floc that enhances settling of the metals precipitate in downstream clarification stages.

In a sulfide precipitation system, sulfide chemicals (e.g., trimercapto-s-triazine (TMT), Nalmet®, sodium sulfide) are used to precipitate and remove heavy metals, such as mercury. While hydroxide precipitation can remove some heavy metals, sulfide precipitation can be more

effective because metal sulfides have lower solubilities than metal hydroxides. FGD wastewater chemical precipitation systems may include various configurations of lime, ferric chloride, and sulfide addition stages, as well as clarification stages.

A process flow diagram for a typical chemical precipitation system using both hydroxide and sulfide addition to treat FGD wastewater is illustrated by Figure 4-6. A chemical precipitation system that omits the sulfide precipitation stage would be similar, but would exclude the reaction tank where sulfide is added.

For the system illustrated by Figure 4-6, the FGD scrubber purge from the plant's solid separation/dewatering process is transferred to an equalization tank, where the intermittent flows are equalized, allowing the plant to pump a constant flow of wastewater through the treatment system. The equalization tank also receives wastewater from a filtrate sump, which includes water from the gravity filter backwash and filter press filtrate.

The FGD scrubber purge is transferred at a continuous flow from the equalization tank to reaction tank 1, where the plant adds hydrated lime to raise the pH of the wastewater from between 5.5 – 6.0 to between 8.0 – 10.5 to precipitate the soluble metals as insoluble hydroxides and oxyhydroxides. The reaction tank also desaturates the remaining gypsum in the wastewater, which prevents gypsum scale formation in the downstream wastewater treatment equipment.

From reaction tank 1, the wastewater flows to reaction tank 2, where organosulfide (most commonly TMT) or inorganic sulfide is added. The treatment system can also be configured so that the organosulfide addition occurs before the hydroxide precipitation step, or with a clarification step between the two chemical addition steps.

From reaction tank 2, the wastewater flows to reaction tank 3, where ferric chloride is added to the wastewater for coagulation and coprecipitation. The effluent from reaction tank 3 flows to the flash mix tank, where polymer is added to the wastewater, prior to being transferred to the clarifier. Alternatively, the polymer can be added directly to the waste stream as it enters the clarifier or added to reaction tank 3. The polymer is used to flocculate fine suspended particles in the wastewater.

The clarifier settles the solids that were initially present in the FGD scrubber purge as well as the additional solids (precipitate) that were formed during the chemical precipitation steps. A sand filter may also be included in the process to further reduce solids, as well as metals attached to the particulates. The backwash from the sand filters is transferred to a filtrate sump and recycled back to the equalization tank at the beginning of the treatment system.

The treated FGD wastewater is collected in a wastewater holding tank and either discharged directly to surface waters or, in most cases, commingled with other waste streams prior to discharge to dilute the concentration of pollutants in the wastewater. As described in Section 4.2, plants do not typically reuse this treated FGD wastewater because the chlorides are at levels that have the potential to corrode downstream equipment.

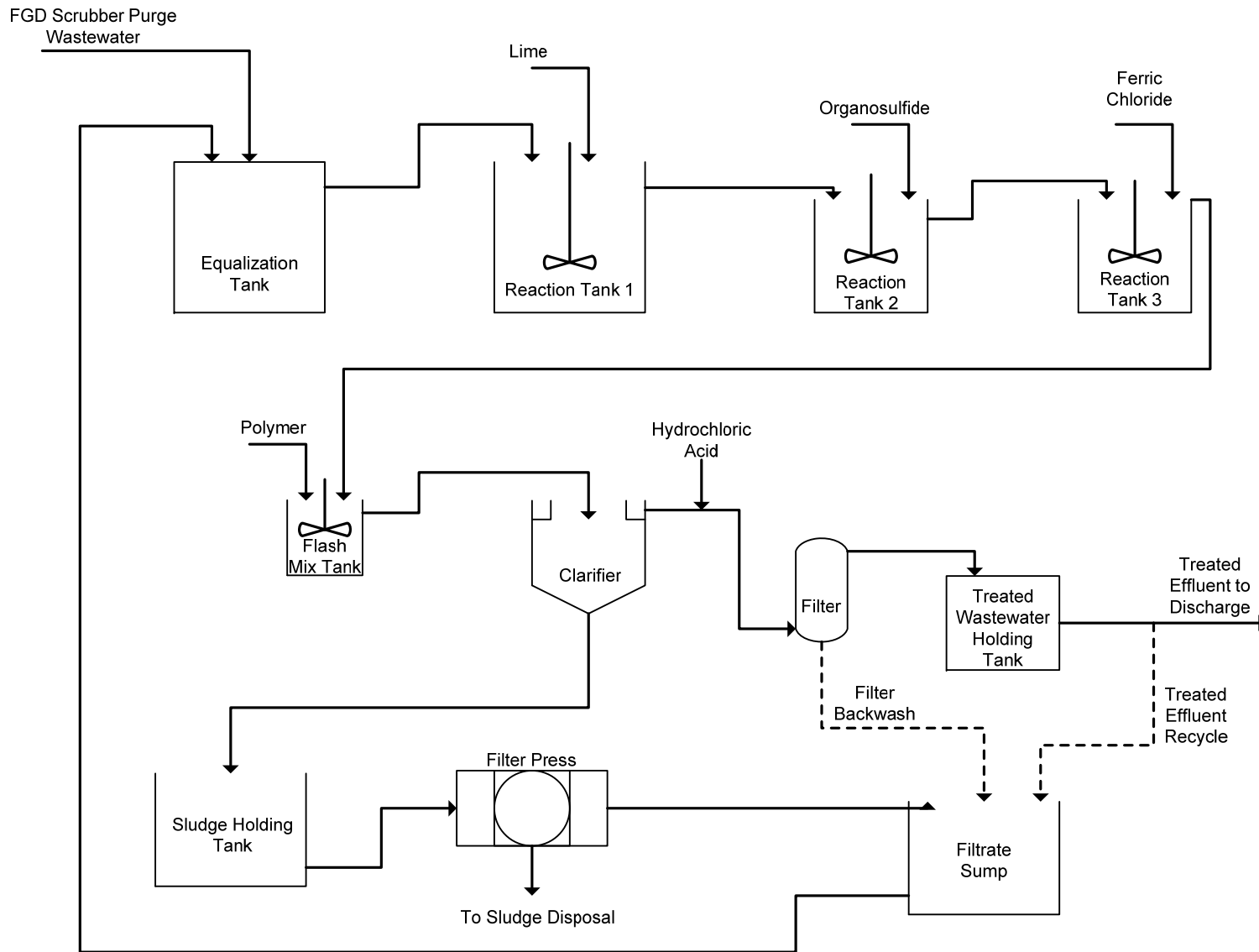

Figure 4-6. Process Flow Diagram for a Hydroxide and Sulfide Chemical Precipitation System

The solids settling in the clarifier (clarifier sludge) are transferred by pumps to the sludge holding tanks, after which the sludge is dewatered using a filter press. The dewatered sludge, or filter cake, is typically sent to an on-site landfill for disposal. The filtrate from the filter press is transferred to a sump and recycled back to the equalization tank at the beginning of the treatment system.

4.4.3 Biological Treatment

Biological wastewater treatment systems use microorganisms to consume biodegradable soluble organic contaminants and bind much of the less soluble fractions into floc. Pollutants may be reduced aerobically, anaerobically, and/or by using anoxic zones. Based on the information EPA collected during the detailed study, two main types of biological treatment systems are currently used (or planned) to treat FGD wastewater: aerobic systems to remove BOD₅ and anoxic/anaerobic systems to remove metals and nutrients. These systems can use fixed film or suspended growth bioreactors, and operate as conventional flow-through or as sequencing batch reactors (SBRs). The wastewater treatment processes for each of these biological treatment systems is discussed below.

Aerobic Biological Treatment

An aerobic biological treatment system can effectively reduce BOD₅ from wastewaters. In a conventional flow-through design, the wastewater is continuously fed to the aerated bioreactor. The microorganisms in the reactor use the dissolved oxygen from the aeration to digest the organic matter in the wastewater, thus reducing the BOD₅. The digestion of the organic matter produces sludge, which may be dewatered with a vacuum filter to better manage its ultimate disposal. The treated wastewater from the system overflows out of the reactor.

An SBR is a type of activated sludge treatment system that can reduce BOD₅ and, when operated to create anoxic zones under certain conditions, can also reduce nitrogen compounds through nitrification and denitrification. Plants often operate at least two identical reactors sequentially in batch mode. The treatment in each SBR consists of a four-stage process: fill, aeration and reaction, settling, and decant. While one of the SBRs is settling and decanting, the other SBR is filling, aerating, and reacting.

When operated as an aerobic system, the SBR operates as follows. The filling stage of the SBR consists of transferring the FGD wastewater into a reactor that contains some activated sludge from the previous reaction batch. During the aeration and reaction stage, the reactor is aerated and the BOD₅ is reduced as the microorganisms digest the organic matter in the wastewater. During the settling phase, the air is turned off and the solids in the SBR are allowed to settle to the bottom. The wastewater is then decanted off the top of the SBR and either transferred to surface water for discharge or transferred for additional treatment. Additionally, some of the solids from the bottom of the SBR are removed and dewatered, but some of the solids are retained in the SBR to retain microorganisms in the system.

Anoxic/Anaerobic Biological Treatment

Some coal-fired power plants are moving towards using anoxic/anaerobic biological systems to achieve better reductions of certain pollutants (e.g., selenium, mercury, nitrates) than has been possible with other treatment processes used at power plants. Figure 4-7 presents a process flow diagram for an anoxic/anaerobic biological treatment system. These biological systems include either a settling pond or chemical precipitation system as a pretreatment step to reduce TSS entering the bioreactors. Additionally, the microorganisms are susceptible to high temperatures, which may require the FGD wastewater to be cooled prior to entering the biological system.

The fixed-film bioreactor consists of an activated carbon bed that is inoculated with microorganisms which reduce selenium and other metals. Growth of the microorganisms within the activated carbon bed creates a fixed-film that retains the microorganisms and precipitated solids within the bioreactor. A molasses-based feed source for the microorganisms is added to the wastewater before it enters the bioreactor [Pickett, 2006].

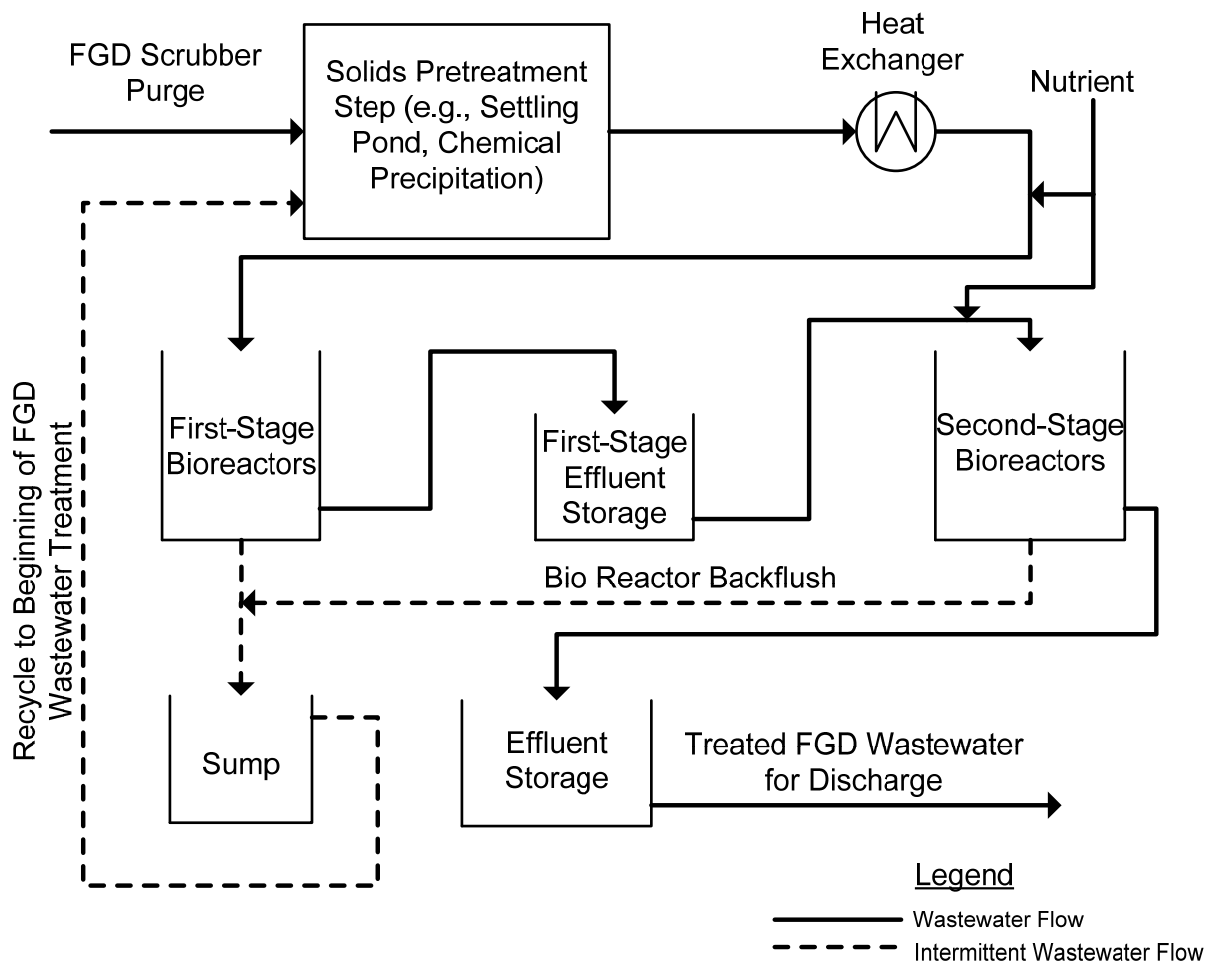

Figure 4-7. Process Flow Diagram for an Anoxic/Anaerobic Biological Treatment System

The bioreactor is designed for plug flow, containing different zones within the reactor that have differing oxidation potential. The top part of the bioreactor is aerobic and allows for nitrification and organic carbon oxidation. As the wastewater moves down through the bioreactor, it enters an anoxic zone where denitrification occurs as well as chemical reduction of both selenate and selenite, which are forms of selenium [Pickett, 2006].

As selenate and selenite are reduced within the bioreactor, elemental selenium forms nanospheres that adhere to the cell walls of the microorganisms. Because the microorganisms are retained within the bioreactor by the activated carbon bed, the elemental selenium is essentially fixed to the activated carbon until it is removed from the system. The bioreactor can also reduce other metals, including arsenic, cadmium, and mercury, by forming metal sulfides within the system [Pickett, 2006].

The bioreactor system typically contains multiple bioreactors; however, they can either be set up in series, as shown in Figure 4-7, or they can be set up in parallel, where the FGD wastewater is split and treated in separate bioreactors. Multiple bioreactors are typically required to allow for additional residence time to achieve the specified removals.

Periodically, the bioreactor must be flushed to remove the solids and inorganic materials that have accumulated within it. The flushing process involves fluidizing the carbon bed by flowing water upward through the system, which dislodges the particles fixed within the activated carbon. The water and solids overflow from the top of the bioreactor and are removed from the system. This flush water must be treated prior to being discharged because of the elevated levels of solids and selenium [Pickett, 2006]. One plant currently operating an anoxic/anaerobic bioreactor system recycles the flush water to the beginning of the chemical precipitation wastewater treatment system so that the solids can be removed by the clarifier. The other plant transfers the flush water to a segregated portion of the settling pond upstream of the bioreactor [ERG, 2008h; Jordan, 2008a].

Another system developed by a treatment system vendor is similarly based on anoxic/anaerobic biological treatment, but relies on using suspended growth flow-through bioreactors instead of fixed-film bioreactors. Both designs share the fundamental processes that lead to denitrification and reduction of metals in anoxic and anaerobic environments. This suspended growth bioreactor system recently completed long-term pilot testing.

SBRs can also be operated to achieve the anoxic/anaerobic conditions described for the flow-through systems. The SBR operation would be similar to that described above for the aerobic biological treatment system; however, to create anoxic conditions, the aeration stage would be followed by periods of air on, air off, which create aerobic zones for nitrification and anoxic zones for denitrification to remove the nitrogen in the wastewater. EPA has collected information on four coal-fired power plants that are planning to operate anoxic/anaerobic biological SBRs, with startup scheduled to occur by 2010. The SBR systems at these plants are expected to be operated in combination with chemical precipitation systems, with the overall systems designed to optimize removal of metals and nitrogen compounds. According to the treatment system vendor, these SBR systems will denitrify the wastewaters, but the oxidation reduction potential in the system will not be conducive for reducing metals.

4.4.4 *Constructed Wetlands*

A constructed wetland treatment system is an engineered system that uses natural biological processes involving wetland vegetation, soils, and microbial activity to reduce the concentrations of metals, nutrients, and TSS in wastewater. A constructed wetland typically consists of several cells that contain bacteria and vegetation (e.g., bulrush, cattails), which are selected based on the specific pollutants targeted for removal. The vegetation completely fills each cell and produces organic matter (i.e., carbon) used by the bacteria. The bacteria reduce metals that are present in the aqueous phase of the wastewater, such as mercury and selenium, to their elemental state. The targeted metals partition into the sediment where they either accumulate or are taken up by the vegetation in the wetland cells [EPRI, 2006b; Rodgers, 2005].

High temperature, COD, nitrates, sulfates, boron, and chlorides in wastewater can adversely affect constructed wetlands performance. To overcome this FGD wastewater is typically diluted with service water before it enters a constructed wetland to reduce the temperature and concentration of chlorides and other pollutants, which can harm the vegetation in the treatment cells. Chlorides in a constructed wetlands treatment system typically must be maintained below 4,000 mg/L. Most plants operate their FGD scrubber system to maintain chloride levels within a range of 12,000-20,000 ppm, so plants must dilute the FGD wastewater prior to transferring it to the wetlands. EPA has observed that power plants operating a constructed wetland tend to operate the FGD scrubber at the lower end of the chloride range. To do this, the plants purge FGD wastewater from the system at a higher flow rate than they otherwise would do if operating the FGD scrubber at a higher chloride level.

4.4.5 *Vapor-Compression Evaporation System*

Evaporators in combination with a final drying process can significantly reduce the quantity of wastewater discharged from certain process operations at various types of industrial plants, including power plants, oil refineries, and chemical plants. One type of evaporation system uses a falling-film evaporator (also referred to as a brine concentrator) to produce a concentrated wastewater stream and a reusable distillate stream. The concentrated wastewater stream may be further processed in a crystallizer or spray dryer, in which the remaining water is evaporated, eliminating the wastewater stream. When used in conjunction with a crystallizer or spray dryer, this process reportedly generates a clean distillate and a solid by-product that can then be disposed of in a landfill. Figure 4-8 presents a process flow diagram for a vapor-compression evaporation system.

Power plants most often use vapor-compression evaporator systems to treat waste streams such as cooling tower blowdown and demineralizer waste, but they have recently begun to operate vapor-compression evaporator systems to treat FGD wastewater as well. One U.S. coal-fired plant and six coal-fired power plants in Italy are treating FGD wastewater with vapor-compression evaporator systems [Rao, 2008; Veolia, 2007; ERG, 2009a].

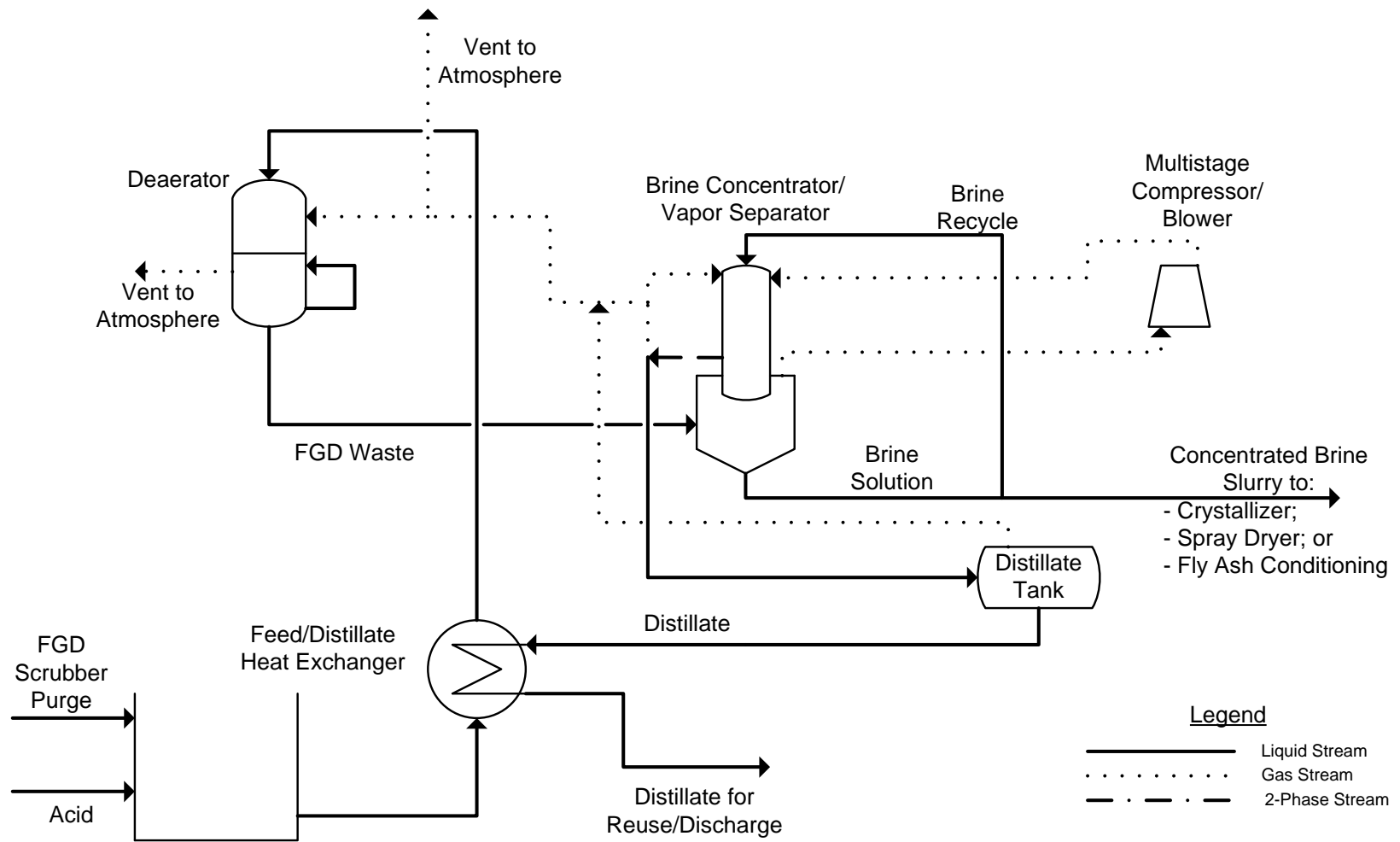

Figure 4-8. Process Flow Diagram for a Vapor-Compression Evaporation System

When a vapor-compression evaporator system is used to treat FGD wastewater, the first step is to adjust the pH of the FGD scrubber purge to approximately 6.5. Following pH adjustment, the scrubber purge is sent through a heat exchanger to bring the waste stream to its boiling point. The waste stream continues to a deaerator where the noncondensable materials such as carbon dioxide and oxygen are vented to the atmosphere [Aquatech, 2006].

From the deaerator, the waste stream enters the sump of the brine concentrator. Brine from the sump is pumped to the top of the brine concentrator and enters the heat transfer tubes. While falling down the heat transfer tubes, part of the solution is vaporized and then compressed and introduced to the shell side of the brine concentrator (i.e., the outside of the tubes). The temperature difference between the compressed vapor and the brine solution causes the compressed vapor to transfer heat to the brine solution, which flashes to a vapor. As heat is transferred to the brine, the compressed vapor cools and condenses as distilled water [Aquatech, 2006].

The condensed vapor (distillate water) can be recycled back to the FGD process, used in other plant operations (e.g., boiler make-up water), or discharged. If the distillate is used for other plant operations that generate a discharge stream (e.g., used as boiler make-up and ultimately discharged as boiler blowdown), then the FGD process/wastewater treatment system is not achieving true zero liquid discharge. Therefore, the operation of the vapor-compression evaporation system itself does not guarantee that the FGD process/wastewater treatment system achieves zero discharge.

To prevent scaling within the brine concentrator as a result of the gypsum present in the FGD scrubber purge, the brine concentrator is seeded with calcium sulfate. The calcium salts preferentially precipitate onto the seed crystals instead of the tube surfaces of the brine concentrator [Shaw, 2008].

The concentrated brine slurry from the brine concentrator tubes falls into the sump and is recycled with the feed (FGD scrubber purge) back to the top of the brine concentrator, while a small amount is continuously withdrawn from the sump and typically transferred to a final drying process. The brine concentrator can typically concentrate the FGD scrubber purge five to ten times, which reduces the inlet FGD scrubber purge water volume by 80 to 90 percent [Shaw, 2008].

Three options are typically considered to be available for eliminating the brine concentrate: (1) final evaporation in a brine crystallizer; (2) evaporation in a spray dryer; or (3) using the brine to condition (add moisture to) dry fly ash or other solids, and disposal of the mixture in a landfill.

Power plants may use brine concentrators to treat a waste stream other than FGD scrubber purge (e.g., cooling tower blowdown). For these non-FGD systems, the concentrated brine withdrawn from the sump is typically sent to a forced-circulation crystallizer to evaporate the remaining water from the concentrate and generate a solid product for disposal. However, the calcium and magnesium salts present in the scrubber purge can pose difficulties for the forced-circulation crystallizer. To prevent this, the FGD scrubber purge can be pretreated using a lime-softening process (i.e., chemical precipitation) upstream of the brine concentrator. With water softening, the magnesium and calcium ions precipitate out of the purge water and are replaced

with sodium ions, producing an aqueous solution of sodium chloride that can be more effectively treated with a forced-circulation crystallizer [Shaw, 2008].

Coal-fired power plants can avoid having to operate the chemical precipitation pretreatment process by using a spray dryer to evaporate the residual waste stream from the brine concentrator. Because the material is hygroscopic (i.e., readily taking up and retaining moisture), the solid residual from the brine concentrator is typically bagged immediately and disposed of in a landfill. Alternatively, the concentrated brine waste stream can be combined with dry fly ash or other solids and disposed of in a landfill.

4.4.6 Design/Operating Practices Achieving Zero Discharge

During its site visit program, EPA observed that many of the plants operating wet FGD systems were able to design and/or manage the FGD system in a manner that prevented the need for a discharge of FGD wastewater. Based on information EPA collected during the detailed study, EPA identified four design/operating practices available to prevent the discharge of FGD wastewater: evaporation ponds, conditioning dry fly ash, underground injection, and several variations of complete recycle. The wastewater treatment processes for each of these practices are discussed below.

Complete Recycle

As discussed in Section 4.2, most plants do not recycle the treated FGD wastewater within the FGD system because of the elevated chloride levels in the treated effluent. Some plants, however, can completely recycle the FGD wastewater within the system without using a wastewater purge stream to remove chlorides. Such plants generally do not produce a saleable solid product from the FGD system (e.g., wallboard-grade gypsum). Because the FGD solid by-product is not being sold and is most likely disposed of in a landfill, there are no specific chloride specifications for the material. Therefore, the plant can operate the FGD system and solids separation/dewatering process such that the moisture retained with the landfilled solids entrains sufficient chlorides that a separate wastewater purge stream is not needed. By operating in this manner, the transfer of the FGD solids to the landfill essentially serves as the chloride purge from the system.

EPA visited four plants that operate limestone forced oxidation FGD systems that do not discharge any FGD wastewaters directly to surface waters. Case Study I describes how one of these plants, Dominion Resources' Mount Storm Plant, is able to completely reuse the FGD wastewaters within the system.

EPA also visited three plants that operate lime or limestone inhibited oxidation FGD systems and do not discharge any FGD wastewaters directly to surface waters. Case Study II describes how one of these plants was able to completely reuse the FGD wastewaters within the system.

**Case Study I: Coal-Fired Power Plant Water Reuse
Limestone Forced Oxidation FGD System
Dominion Resources' Mount Storm Plant**

The Facility

FGD type:	Limestone forced oxidation spray tower
Scrubber chlorides conc.:	40,000 ppm
Materials of construction chlorides limit:	120,000 ppm
FGD WWT system:	None: complete recycle
Gypsum destination:	Landfill, concrete manufacturing, land application

The FGD Wastewater Handling System

The gypsum slurry blowdown from the FGD system is transferred to hydroclones for initial dewatering. The underflow from the hydroclones contains the gypsum solids and is transferred to vacuum rotary drum filters. The hydroclone overflow, which is mostly water and fines, is recycled back to the FGD scrubber.

The hydroclone underflow sent to the vacuum rotary drum filters is not rinsed with service water, as some plants do. The underflow is fed to a tray that holds the underflow as the vacuum drum filter rotates and the bottom of the drum filter is dipped in the underflow water. The vacuum on the rotary drum filter pulls the solids and water to the drum and then pulls the water out of the solids to dry the gypsum. The dry gypsum (20-25% moisture content) is then scraped off the drum as it rotates. The gypsum collected from the vacuum rotary drum filters is conveyed to the storage area until it is either sent to the on-site landfill, transferred off site to a concrete manufacturer, or transferred off site for land application. The filtrate from the vacuum rotary drum filters is either recycled back to the FGD scrubber or to the limestone preparation process.

Why the Plant is Able to Completely Reuse FGD Wastewater

Gypsum is not sold to a wallboard manufacturer; therefore, the gypsum dried on the vacuum rotary drum filters does not need to meet any particular specifications. Since higher levels of chlorides are acceptable, the gypsum does not require washing. Chlorides are purged from the system entrained in the gypsum (20-25% moisture), and the mass removal rate is sufficient to maintain the chlorides in the FGD system at a constant level.

Source: [ERG, 2008p].

Case Study II: Coal-Fired Power Plant Water Reuse Lime or Limestone Inhibited Oxidation FGD System Ohio Power Company's General James M Gavin Plant

The Facility

FGD type: Magnesium-enhanced lime inhibited oxidation spray/tray towers
Scrubber chlorides conc.: 2,500 to 3,000 ppm
FGD WWT system: None: complete recycle
Calcium sulfite destination: Landfilled as cementitious material

The FGD Wastewater Handling System

The calcium sulfite slurry from the FGD system is transferred to a pair of thickeners to separate the solids from the water. The underflow from the thickener contains the calcium sulfite solids and is transferred to centrifuges for final dewatering. The thickener overflow is sent to a reclaim tank and recycled back to the FGD scrubber.

The thickener underflow sent to the centrifuges is not rinsed with service water. The underflow is fed to a centrifuge to dewater the solids. The water leaving the centrifuge, referred to as centrate, is recycled back to the FGD scrubber. The solids stream from the centrifuge contains 40-50 percent moisture. This stream is combined with dry fly ash and lime in a pug mill to generate a cementitious material that can be landfilled.

How FGD Wastewater is Completely Reused

The calcium sulfite does not need to meet any particular specifications; therefore, it is not washed to remove chlorides prior to dewatering. The dewatered calcium sulfite has a moisture content of 40 to 50 percent water (before mixing with fly ash and lime) and chlorides are retained in the cementitious material sent to the landfill. The FGD system has reached a steady state operation in which the chlorides entering the system from the coal are equal to the chlorides that are leaving the system in the cementitious material.

Source: [ERG, 2009b].

Evaporation Ponds

EPA identified three coal-fired power plants located in the southwestern United States using evaporation ponds to avoid discharging FGD wastewater. Because of the warm, dry climate in this region, the plants can send the FGD wastewater to one or more ponds where the water is allowed to evaporate. At these plants, the evaporation rate from the pond is greater than or equal to the flow rate of the FGD wastewater to the pond and no water is discharged from the evaporation pond.

Conditioning Dry Fly Ash

Many plants that operate dry fly ash handling systems need to add water to the fly ash for dust suppression or to improve handling and/or compaction characteristics. EPA has identified one plant that uses FGD wastewater to condition its dry fly ash. In addition, another plant is using a vapor-compression evaporation system in combination with conditioning dry fly ash to prevent the discharge of FGD wastewater [ERG, 2009a]. The plant uses the vapor-compression evaporation system to reduce the volume of the FGD scrubber purge and then mixes the effluent from the brine concentrator with dry fly ash and disposes of it in a landfill.

Underground Injection

Underground injection is a technique used to dispose of wastes by injecting them into an underground well. This technique is an alternative to discharging wastewater to surface waters. One plant began using underground injection to dispose of the FGD wastewater in 2007, but due to unexpected pressure issues and problems with building the wells due to geological formations encountered, which may not be related to the characteristics of the FGD wastewater, the plant has not been able to continuously inject the wastewater. The plant operates a chemical precipitation system as pretreatment for the injection system. When the plant is not injecting the FGD wastewater, the effluent from the chemical precipitation system is transferred to the plant's pond system. Since the pond water is used as make-up for the plant's service water, the chlorides from the FGD wastewater are not purged from the system. The plant needs to sustain continuous injection of the wastewater to avoid chlorides increasing to a level that would promote corrosion of equipment [ERG, 2009e]. Another plant is also scheduled to begin injecting the FGD wastewater underground later this year [Gulf Power, 2009]. Underground injection has its own permitting and regulations, which are not covered under the NPDES program.

Combination of Wet and Dry FGD Systems

The combination of a wet and a dry FGD system operated on the same unit or at the same plant can result in elimination of the scrubber purge associated with the wet FGD process. As described in Section 4.2.3, the dry FGD process involves atomizing and injecting wet lime slurry, which ranges from approximately 18 to 25 percent solids, into a spray dryer. The water contained in the slurry is evaporated from the heat of the flue gas within the system, leaving behind a dry residue which is removed from the flue gas by a fabric filter (i.e., baghouse). By operating a combination of a wet and dry FGD system, the scrubber purge associated with the wet FGD system can be used as make-up water for the lime slurry feed to the dry FGD process, thereby eliminating the FGD wastewater.

From its data collection activities, EPA has identified one plant that is expected to operate a dry FGD system in combination with a wet FGD system to eliminate the need to discharge the FGD wastewater associated with the wet FGD system. Case Study III describes how this plant is expected to operate when the new electric generating unit begins operation in 2012.

4.4.7 Other Technologies under Investigation

Industry-funded studies are being conducted by EPRI to evaluate and demonstrate technologies that have the potential to remove trace metals from FGD wastewater. EPRI is conducting pilot- and full-scale optimization field studies on some technologies already in use by coal-fired power plants to treat FGD wastewater, such as chemical precipitation (organosulfide and iron coprecipitation), constructed wetlands, and an anoxic/anaerobic biological treatment system. EPRI is also conducting lab- and pilot-scale studies for other technologies that may be capable of removing metals from FGD wastewaters. EPA obtained limited information regarding these other technologies, which include iron cementation, reverse osmosis, absorption media, ion exchange, and electro-coagulation. Each of these technologies are discussed below.

Iron Cementation

EPRI conducted laboratory feasibility studies of the metallic iron cementation treatment technology as a method for removing all species of selenium from FGD wastewater. EPRI believes this process may also be effective at removing mercury. The iron cementation process consists of contacting the FGD wastewater with an iron powder, which reduces the metal to its elemental form (cementation). The pH of the wastewater is raised to form metal hydroxides, and the wastewater is filtered to remove the precipitated solids. The iron powder used in the process is separated from the wastewater and recycled back to the cementation step. From the initial studies, EPRI concluded that the metallic iron cementation approach is promising for treating FGD wastewater for multiple species of selenium, including selenite, selenate, and other unknown selenium compounds. EPRI is planning to continue conducting laboratory- and pilot-scale feasibility studies of the technology to evaluate selenium and mercury removal performance [EPRI, 2008b].

**Case Study III: Coal-Fired Power Plant Water Reuse
Integrated Dry and Wet FGD Systems
Duke Energy Carolinas' Cliffside Steam Station**

The Facility

FGD type: Unit 6: Lime spray dryer and wet limestone forced oxidation spray tower; Unit 5: wet limestone forced oxidation spray tower
 FGD WWT system: Unit 6: None; Unit 5: chemical precipitation system
 FGD solids destination: Sold for wallboard production or landfilled

The FGD Operation and Wastewater Handling System

When Unit 6 begins operation (expected in 2012), its flue gas will first be treated with a dry lime FGD system (spray dryer). The flue gas exiting the spray dryer will pass through a fabric filter baghouse to remove the FGD solids, fly ash, and other particulates from the flue gas. The flue gas will then be directed to the wet limestone forced oxidation system. The wet FGD system will operate similarly to Figure 4-2; however, instead of the scrubber purge being transferred to wastewater treatment and discharged, the scrubber purge will be reused in the lime slurry feed to the dry FGD system.

Unit 5 is currently operating at the plant, but its wet FGD system is not yet operating. Once the FGD system is operating, the Unit 5 flue gas will be treated by a cold-side ESP followed by a wet limestone forced oxidation system. When Unit 6 is not operating, the scrubber purge from Unit 5 will be transferred to a chemical precipitation wastewater treatment system. When Unit 6 is operating, most, if not all, of the scrubber purge from Unit 5 can be used in the lime slurry feed for the Unit 6 dry FGD system; the remainder will be transferred to the wastewater treatment system. Units 5 and 6 operate independently from each other and, therefore, the wastewater treatment system will allow the plant to operate Unit 5 and discharge its scrubber purge stream when Unit 6 is not operating.

How the FGD Wastewater Discharge will be Eliminated

The scrubber purge streams from Units 5 & 6 will be reused in the feed stream to Unit 6's dry FGD system, which will evaporate the water during the process and generate only solid residues that are removed in the fabric filter baghouse.

Source: [McGinnis, 2009].

Reverse Osmosis

Reverse osmosis systems are currently in use at power plants, usually to treat boiler make-up water or cooling tower blowdown wastewaters. EPRI has identified a high-efficiency reverse osmosis (HERO™) process which operates at a high pH, allowing the system to treat high silica wastewaters without scaling or membrane fouling because silica is more soluble at higher pHs. The wastewater undergoes a water-softening process to raise the pH of the wastewater prior to entering the HERO™ system.

Although the HERO™ system has been demonstrated for use with power plant cooling tower blowdown wastewater, its use for FGD wastewater is potentially limited due to the osmotic pressure of the FGD wastewater resulting from the high concentrations of chloride and TDS [EPRI, 2007a].

Although many power plants may not be able to use the HERO™ system to treat FGD wastewater, some plants with lower TDS and chloride concentrations may be able to do so. The HERO™ system is of particular interest for treating boron from FGD wastewaters because boron becomes ionized at an elevated pH and, therefore, could be removed using a reverse osmosis system [EPRI, 2007a].

Sorption Media

Sorption media has been used by the drinking water industry to remove arsenic from the drinking water. These sorption processes are designed to adsorb pollutants onto the media's surface area using physical and chemical reactions. The designs most commonly used in the drinking water industry use metal-based adsorbents, typically granular ferric oxide, granular ferric hydroxide, or titanium-based oxides. The sorption media is usually a single use application that can typically be disposed of in a nonhazardous landfill after its use. In addition, the single-use design prevents the plant from needing to further treat the residuals. According to EPRI, these sorption media have been shown to remove the common forms of arsenic and selenium from drinking water [EPRI, 2007a].

Ion Exchange

Ion exchange systems are currently in use at power plants to pretreat boiler make-up water. Ion exchange systems are designed to remove specific constituents from wastewater; therefore, specific metals can be targeted by the system. The typical metals targeted by ion exchange systems include boron, cadmium, cobalt, copper, lead, mercury, nickel, uranium, vanadium, and zinc. Although the ion exchange process does not generate any residual sludge, it does generate a regenerant stream that contains the metals stripped from the wastewater. EPA has compiled information on a plant that is pilot testing two ion exchange resins for treatment of FGD wastewater. The plant and the ion exchange resins tested in the pilot study are focused specifically on the removal of mercury. [EPRI, 2007a].

Electro-Coagulation

Electro-coagulation uses an electrode to introduce an electric charge to the wastewater, which neutralizes the electrically charged colloidal particles. These systems typically use aluminum or iron electrodes, which are dissolved into the waste stream during the process. The dissolved metallic ions precipitate with the other pollutants present in the wastewater and form insoluble metal hydroxides. According to EPRI, additional polymer or supplemental coagulants may need to be added to the wastewater depending on the specific characteristics. These systems are typically used to treat small waste streams, ranging from 10 to 25 gpm, but may also be able to treat waste streams of up to 50 or 100 gpm [EPRI, 2007a].

Other Technologies

Other technologies under laboratory-scale study include polymeric chelates, taconite tailings, and nano-scale iron reagents. In addition, EPRI is investigating various physical treatment technologies, primarily for mercury removal, including filtration [EPRI, 2008a].

4.4.8 Wastewater Treatment System Use in the Coal-Fired Steam Electric Industry

Table 4-7, presents information on the FGD wastewater treatment systems currently operating (as of June 2008) at plants included in EPA's combined data set. Table 4-7 also includes information on FGD wastewater treatment systems projected to be operating in 2020. EPA's combined data set includes wastewater treatment system information for 84 of the 108 plants (78 percent) operating wet FGD scrubber systems as of June 2008, representing 175 of the 223 wet-scrubbed coal-fired electric generating units (78 percent). Of these 84 plants, 32 plants (38 percent) do not discharge FGD wastewater.¹⁸ These plants are able to achieve "zero discharge" by either recycling all FGD wastewater back to the scrubber (28 plants), using evaporation ponds (3 plants), mixing the FGD wastewater with dry fly ash (1 plant), or deep well injecting the FGD wastewater (1 plant¹⁹). Figure 4-9 shows the distribution of FGD wastewater management/treatment within the group of 84 plants.

¹⁸ There is a plant that operates several wet FGD systems and for some of the wet FGD systems there is a wastewater discharge; however, the other wet FGD systems operate without discharging. In Table 4-7, this plant is included in the count of plants for both the "zero discharge" wastewater treatment systems and the other type of wastewater treatment system operated by the plant.

¹⁹ As discussed in Section 4.4.6, the plant began using underground injection to dispose of the FGD wastewater in 2007, but due to issues encountered with the system, has not been able to continuously inject the wastewater.

Table 4-7. FGD Wastewater Treatment Systems Identified During EPA’s Detailed Study

	Wet FGD Systems in the Combined Data Set Operating as of June 2008 ^a			Wet FGD Systems in the Combined Data Set Projected to be Operating in 2020 ^b		
	Number of Plants with FGD Wastewater Treatment Systems	Number of Electric Generating Units Serviced by FGD Wastewater Treatment Systems	Wet Scrubbed Capacity ^c (MW)	Number of Plants With or Expected to Operate FGD Wastewater Treatment Systems	Projected Number of Electric Generating Units Serviced by the Treatment Systems	Projected Wet Scrubbed Capacity ^c (MW)
Settling Ponds	29	63	27,700	35	95	44,000
Combined FGD and Ash Ponds (FGD solids removal prior) ^{d, e}	17	41	14,400	18	48	16,600
Combined FGD and Ash Ponds (No FGD solids removal prior) ^{d, f}	2	4	1,440	2	4	1,440
FGD Ponds (FGD solids removal prior) ^{e, g}	4	8	4,450	7	18	12,500
FGD Ponds (No FGD solids removal prior) ^{f, g}	6	10	7,350	8	25	13,400
Chemical Precipitation (“Chem Precip”)	15	27	14,200	24	52	28,300
Chem Precip (type unknown)	—	—	—	5	11	5,800
Hydroxide Chem Precip	10	18	10,500	11	25	14,800
Hydroxide and Sulfide Chem Precip	2	4	2,350	5	11	6,460
Combination Settling Pond and Chem Precip	2	3	896	2	3	896
Chem Precip and Constructed Wetland	1	2	414	1	2	414
Tank-Based Biological	1	3	2,150	2	6	3,294
Combination Settling Pond and Anoxic/Anaerobic Biological (designed for metals & nitrogen removal)	1	3	2,150	2	6	3,294

Table 4-7. FGD Wastewater Treatment Systems Identified During EPA’s Detailed Study

	Wet FGD Systems in the Combined Data Set Operating as of June 2008 ^a			Wet FGD Systems in the Combined Data Set Projected to be Operating in 2020 ^b		
	Number of Plants with FGD Wastewater Treatment Systems	Number of Electric Generating Units Served by FGD Wastewater Treatment Systems	Wet Scrubbed Capacity ^c (MW)	Number of Plants With or Expected to Operate FGD Wastewater Treatment Systems	Projected Number of Electric Generating Units Served by the Treatment Systems	Projected Wet Scrubbed Capacity ^c (MW)
Combination Chem Precip and Tank-Based Biological	3	5	4,720	8	23	12,500
Chem Precip and Aerobic Biological (designed for metals and BOD ₅ removal)	2	3	2,560	1	2	1,870
Chem Precip and Aerobic/Anaerobic Biological (designed for removing nitrogen and selected metals)	—	—	—	4	11	5,260
Chem Precip and Anoxic/Anaerobic Biological (designed for metals & nitrogen removal)	—	—	—	3	10	5,330
Chem Precip, Anoxic/Anaerobic Biological (designed for metals & nitrogen removal), and CWTS	1	2	2,160	—	—	—
Zero Discharge	33	65	38,700	35	75	43,000
Zero Discharge: Recycle All FGD Water	28	56	33,800	27	58	34,700
Zero Discharge: Evaporation Pond	3	4	1,800	3	4	1,800
Zero Discharge: Conditioning Dry Fly Ash	1	2	1,140	1	2	1,140
Zero Discharge: Deep Well Injection	1	3	2,000	2	7	3,140
Zero Discharge: Evaporator & Conditioning Dry Fly Ash	—	—	—	1	2	1,580
Zero Discharge: Recycled to Dry FGD	—	—	—	1	2	571

Table 4-7. FGD Wastewater Treatment Systems Identified During EPA’s Detailed Study

	Wet FGD Systems in the Combined Data Set Operating as of June 2008 ^a			Wet FGD Systems in the Combined Data Set Projected to be Operating in 2020 ^b		
	Number of Plants with FGD Wastewater Treatment Systems	Number of Electric Generating Units Serviced by FGD Wastewater Treatment Systems	Wet Scrubbed Capacity ^c (MW)	Number of Plants With or Expected to Operate FGD Wastewater Treatment Systems	Projected Number of Electric Generating Units Serviced by the Treatment Systems	Projected Wet Scrubbed Capacity ^c (MW)
Other Handling	5	12	5,010	5	12	5,010
Clarifier	1	3	521	1	3	521
Clarifier and Constructed Wetland	1	4	2,000	1	4	2,000
Commingled with other Wastewater	3	5	2,490	3	5	2,490
No Information	24	48	15,600	85	164	65,900
Subtotal: Wastewater treatment systems for which EPA has information available ^h	84	175	92,500	107	237	123,000
Subtotal: Systems treating FGD wastewater discharged to surface waters ^h	53	110	53,800	74	162	79,900
Total ^h	108	223	108,000	192	401	189,000

a – Source: Combined data set (UWAG-provided data [ERG, 2008g], data request information [U.S. EPA, 2008a], and site visit and sampling information). Includes treatment systems servicing electric generating units identified in the “combined data set” with wet FGD systems operating as of June 2008. Excludes OSWER data for surface impoundments containing CCRs.

b – Source: Combined data set (UWAG-provided data [ERG, 2008g], data request information [U.S. EPA, 2008a], and site visit and sampling information). Includes treatment systems servicing electric generating units identified in the “combined data set” with wet FGD systems operating by 2020.

c – The capacities presented have been rounded to three significant figures. Due to rounding, the total capacity may not equal the sum of the individual capacities. The capacities presented represent the reported nameplate capacity for the unit.

d – The combined FGD and ash pond system refers to a settling pond that handles untreated FGD scrubber purge and ash wastewaters (either bottom ash or fly ash transport water). Some plants transfer treated FGD wastewaters to an ash pond for dilution prior to discharge, but these systems are not reflected in this table.

e – “FGD Solids removal prior” means that gypsum or calcium sulfite sludge was removed prior to treatment.

f – “No FGD Solids removal prior” means that gypsum or calcium sulfite sludge was sent to the settling pond.

g – The FGD pond system refers to settling ponds that handle untreated FGD scrubber purge, but do not handle ash wastewaters. The FGD pond may handle other wastewaters along with the FGD scrubber purge, such as low-volume wastes, but the pond cannot receive ash wastewaters to be considered an FGD pond.

h – There are two plants with multiple types of wastewater treatment systems; therefore, there is overlap in these totals.

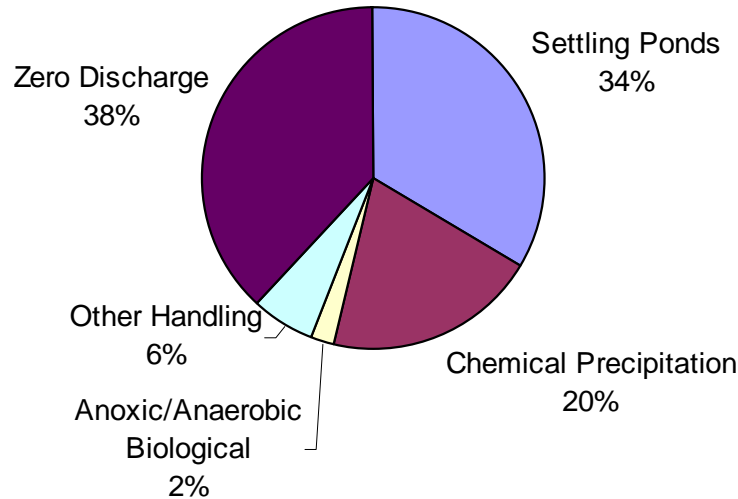

Figure 4-9. Distribution of FGD Wastewater Treatment Systems Among Plants Operating Wet FGD Systems

Figure 4-10 compares the distribution of FGD wastewater treatment systems within the group of plants that operate limestone forced oxidation FGD systems, to the group of plants operating inhibited/natural oxidation FGD systems. EPA has information about FGD wastewater management/treatment for 50 plants operating forced oxidation FGD systems servicing 111 electric generating units, and 36 plants operating inhibited or natural oxidation FGD systems servicing 65 electric generating units²⁰. A larger percentage of the plants operating forced oxidation FGD systems discharge the FGD wastewater, relative to plants that operate inhibited and natural oxidation FGD systems. This is largely due to the fact that inhibited oxidation FGD systems produce calcium sulfite by-product which, since it has little or no value in the marketplace, typically is disposed of in a landfill. This provides plants the opportunity to operate the FGD system in a manner that purges chlorides from the FGD system along with the landfilled solids and eliminates the need for the FGD wastewater discharge. See section 4.2 for additional discussion of this operational practice.

²⁰ EPA has information regarding FGD wastewater treatment systems for 84 plants; however, two of these plants operated both forced oxidation and natural/inhibited oxidation FGD systems.

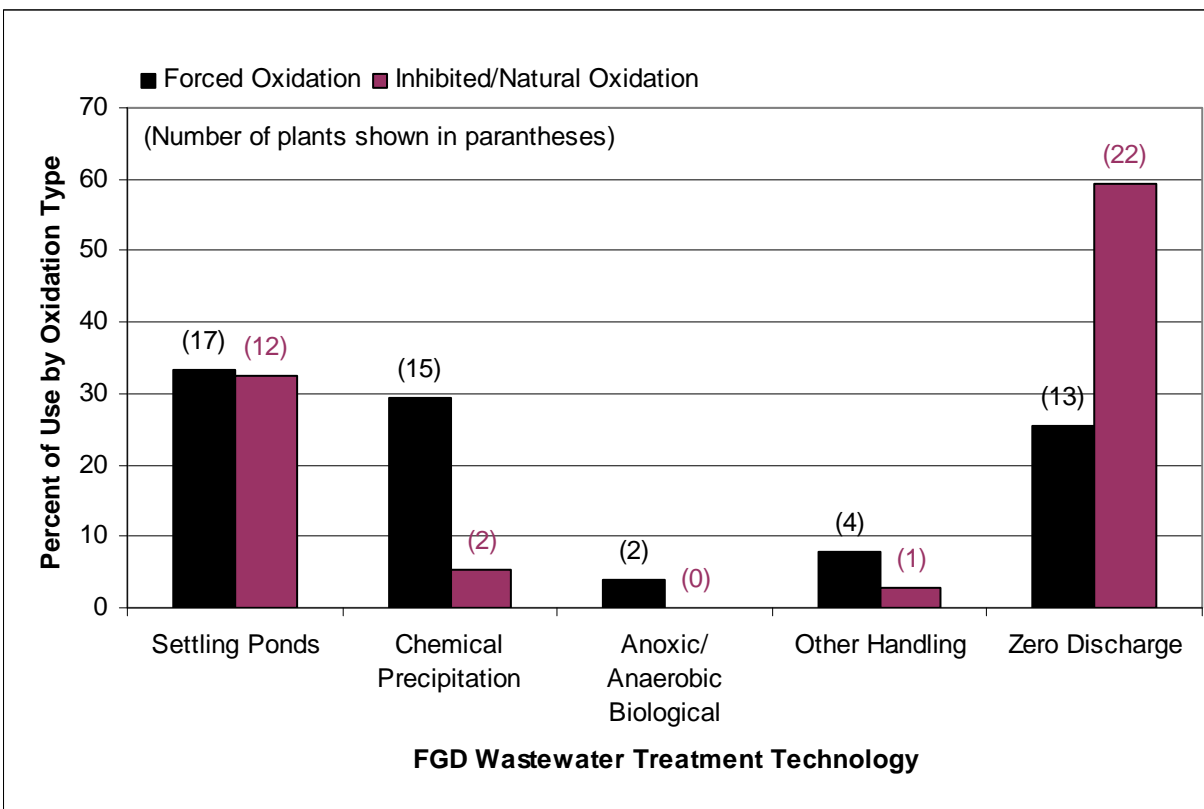

Figure 4-10. Comparison of Distribution of FGD Wastewater Treatment Systems by Type of Oxidation System

Of the 84 plants for which EPA has information about FGD wastewater, 53 discharge the FGD wastewater. The technologies used by these 53 plants to treat FGD wastewater is summarized below, and illustrated by Figure 4-11. It should be noted that most of these plants subsequently commingle the treated FGD wastewater with other waste streams (e.g., ash wastewater or cooling water) to enable dilution to reduce the pollutant concentrations in the discharged wastewater.

- Twenty-nine plants treat the wastewater using a settling pond.²¹
- Eighteen plants operate chemical precipitation systems. Fifteen of these 18 plants operate a hydroxide chemical precipitation system, and three use both hydroxide and sulfide precipitation in the treatment system. Additionally, two of the 15 hydroxide plants currently have equipment installed to also perform a sulfide precipitation step, but are no longer adding sulfide to the system.
- Two of the 18 plants with chemical precipitation systems also operate aerobic biological reactors following the precipitation system. Both of these plants use

²¹ For comparison, note that the OSWER data on surface impoundments identifies 78 plants operating a total of 170 ponds that contain FGD wastes. There is insufficient data to determine whether the FGD wastestream undergoes solids separation to remove gypsum or calcium sulfite prior to the ponds, nor is there information to determine which of these ponds may discharge to surface water. Some of the ponds also contain ash wastes and may be more accurately described as ash ponds that also receive FGD wastes (with or without first removing FGD solids) [Schroeder, 2009].

- organic acid additives in their FGD scrubbers to improve the SO₂ removal efficiency, increasing the BOD₅ concentration in the scrubber purge.
- Two plants operate fixed-film anoxic/anaerobic bioreactors. One of these plants also operates a chemical precipitation system (one of the 18 plants described previously) and the other operates a settling pond as pretreatment to the bioreactor. Two additional plants are in the process of installing similar fixed-film bioreactors. One will operate the biological system in conjunction with chemical precipitation; the other will use a settling pond for pretreatment.
 - One plant uses a clarifier and one plant uses a constructed wetlands treatment system as the primary treatment mechanism. Two other plants also operate constructed wetland systems; however, the constructed wetland acts as a polishing step following chemical precipitation and/or biological treatment.
 - Three plants commingle the FGD wastewater with other waste streams (other than ash transport water).

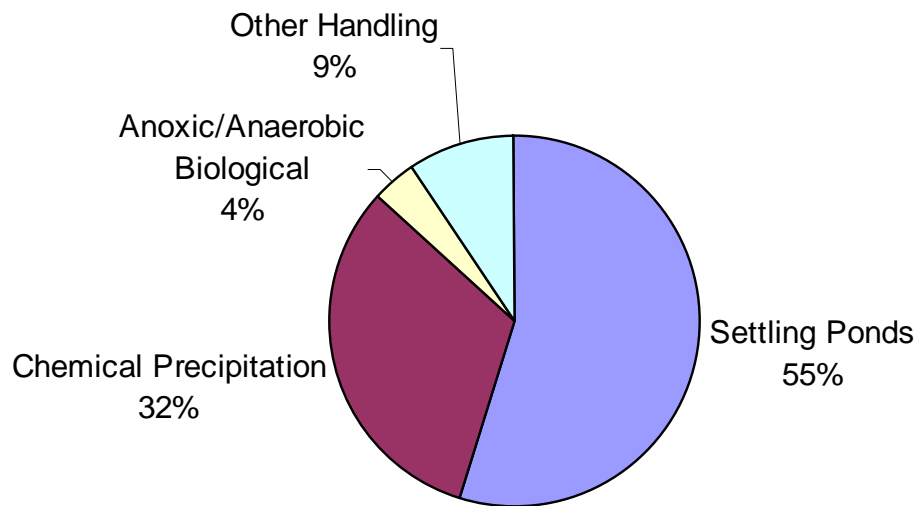

Figure 4-11. Distribution of FGD Wastewater Treatment Systems Among Plants that Discharge FGD Wastewater

Table 4-7 also presents information for the type of treatment systems that, based on the combined data set, EPA anticipates will be used to treat wastewater from the FGD scrubbers that will be operating in 2020. Despite recent interest in the use of more advanced wastewater treatment systems, the data compiled by EPA indicate that widespread use of settling ponds to treat FGD wastewater will continue.

EPA expects that more than 192 plants will be operating wet FGD scrubbers by 2020 and that 158 of these plants will discharge FGD wastewater²². Of these 158 plants, there are 74 for which EPA has information on their expected system use. Below is a description of the type of

²² As discussed in section 4.1.2, EPA's projections for new FGD systems do not include the systems that will be installed at new generating units or new plants. Thus, the projections for 2020 are considered to under-estimate the actual number of FGD systems that will be installed.

wastewater treatment systems either currently operating or expected to be operating at these 74 plants:

- Thirty-five plants are expected to treat the wastewater using a settling pond;
- Thirty-four plants are expected to rely on more advanced treatment such as chemical precipitation or biological treatment;
- One plant is expected to use a clarifier and one plant is expected to use a constructed wetlands treatment system as the primary treatment mechanism; and
- Three plants are expected to commingle the FGD wastewater with other waste streams (other than ash transport water).

4.5 Comparison of FGD Wastewater Control Technologies

As part of the detailed study, EPA evaluated several treatment technologies or combinations of treatment technologies that plants are using to remove heavy metals and other pollutants from FGD wastewater. Using the data available for these systems, EPA evaluated these systems as potential controls for the treatment of FGD wastewater, as follows:

- **Chemical Precipitation.** Physical/chemical precipitation for heavy metals removal using hydroxide or a combination of hydroxide and sulfide precipitation;
- **Chemical Precipitation + Biological Metals Removal.** Chemical precipitation followed by anoxic/anaerobic biological treatment for removing additional metals and to reduce nitrogen compounds; and
- **Chemical Precipitation/Softening + Evaporation + Crystallization.** Chemical precipitation or softening followed by evaporation in a brine concentrator and crystallization for potential elimination of the FGD wastewater stream.

EPA used information collected throughout the detailed study in evaluating these technologies, including operational and performance information from plants, vendors, and EPA's site visit and sampling programs. Data collected during EPA's sampling program and self-monitoring data obtained from individual plants were used to evaluate the performance of the chemical precipitation and biological treatment technologies. These data show that chemical precipitation is an effective means for removing many metals from the FGD wastewater. Biological treatment, specifically fixed-film anoxic/anaerobic bioreactors when paired with a chemical precipitation pretreatment stage, is very effective at removing additional pollutants such as selenium and nitrogen compounds (e.g., nitrates, nitrites). If operated with a nitrification step, the technology would also be expected to remove ammonia that may be present in the waste stream. Coal-fired power plants have only recently begun to use evaporation/crystallization systems to treat FGD scrubber purge, so EPA was able to collect only limited data for these systems.

Figure 4-12 (A-G) and Figure 4-13 (A-G) present a series of graphs of monitoring data collected in 2008 from the FGD wastewater treatment systems at Duke Energy Carolinas' Belevs Creek Steam Station and Progress Energy Carolinas' Roxboro Power Plant, respectively. For each plant, the graphs present the concentrations of arsenic, mercury, selenium, and TDS at the following points in the FGD wastewater treatment systems:

- FGD scrubber purge;
- Intermediate point preceding the biological treatment stage (i.e., settling pond effluent for Roxboro and chemical precipitation effluent for Belews Creek); and
- Effluent from the anoxic/anaerobic biological treatment system.

The Belews Creek FGD wastewater treatment system consists of an equalization tank followed by a chemical precipitation system to reduce dissolved metals using lime for hydroxide precipitation, ferric chloride for iron co-precipitation, and a clarifier and sand filter for solids removal. After the sand filter, the wastewater is transferred to a fixed-film, anoxic/anaerobic biological treatment system designed to remove metals and nitrogen compounds. Belews Creek operates two stages of the biological reactors in series. After the biological system, the wastewater is transferred to a constructed wetland and then to the ash pond and discharged.

The Roxboro FGD wastewater treatment system consists of a settling pond followed by a fixed-film, anoxic/anaerobic biological treatment system designed to remove metals and nitrogen compounds. The settling pond was designed specifically for FGD wastewater, to reduce the wastewater temperature and TSS prior to the bioreactor. The bioreactor operates with four parallel trains that each has two biological cells in series. Wastewater flows from the bioreactor to the ash pond discharge canal and is discharged.

The Belews Creek and Roxboro graphs show that the chemical precipitation system, the settling pond, and the biological treatment systems are all able to remove arsenic, mercury, and selenium to some extent from the FGD scrubber purge. Figure 4-12 and Figure 4-13 show that the chemical precipitation system at Belews Creek is achieving lower pollutant concentrations of metals than the settling pond at Roxboro. Despite the two plants having relatively comparable levels of mercury, selenium, and arsenic in their scrubber purge stream, the chemical precipitation stage at Belews Creek achieved pollutant concentrations approximately an order of magnitude lower than was observed for the settling pond at Roxboro. In addition, the anoxic/anaerobic biological treatment stage at both plants further reduced the metals in the FGD wastewater. The effectiveness of the biological treatment stage is particularly notable for selenium which, depending on the form of selenium present in the wastewater, usually is not effectively nor consistently removed by settling ponds or chemical precipitation. The bioreactor effluent selenium concentrations at Belews Creek are substantially lower than those observed for Roxboro's bioreactor effluent, presumably due to the chemical precipitation stage providing more effective pretreatment than achieved by the settling pond. Finally, the figures show that TDS is not significantly removed by the settling pond, the chemical precipitation system, or the biological treatment system.

Belews Creek Monitoring Data (2008)

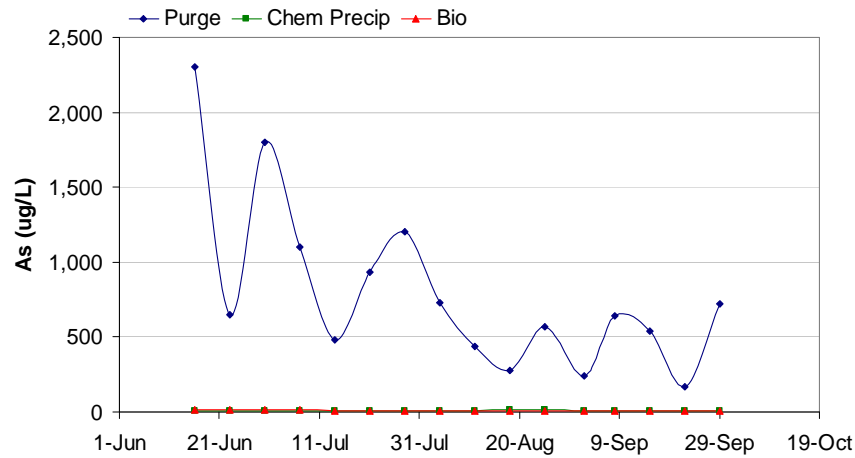

Figure 4-12A. Concentration of Arsenic in FGD Scrubber Purge and Effluent from Chemical Precipitation and Biological Treatment Systems at Belews Creek

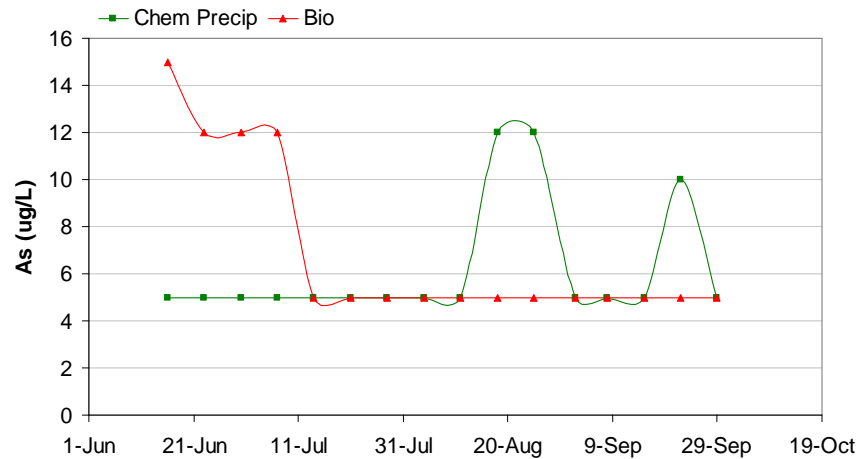

Figure 4-12B. Concentration of Arsenic in Effluent from Chemical Precipitation and Biological Treatment Systems at Belews Creek

Roxboro Monitoring Data (2008)

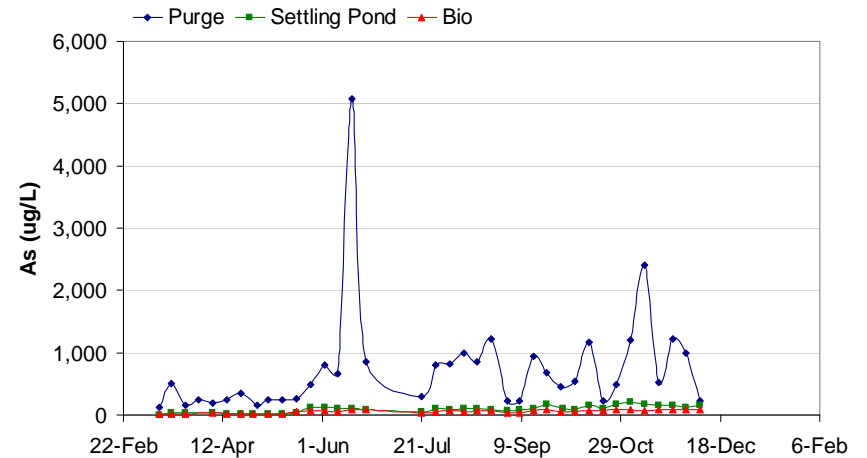

Figure 4-13A. Concentration of Arsenic in FGD Scrubber Purge and Effluent from Settling Pond and Biological Treatment Systems at Roxboro

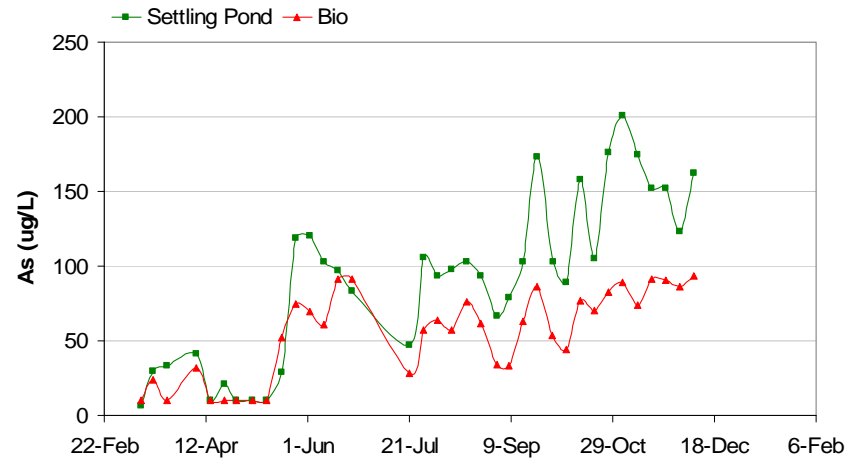

Figure 4-13B. Concentration of Arsenic in Effluent from Settling Pond and Biological Treatment Systems at Roxboro

Belews Creek Monitoring Data (2008)

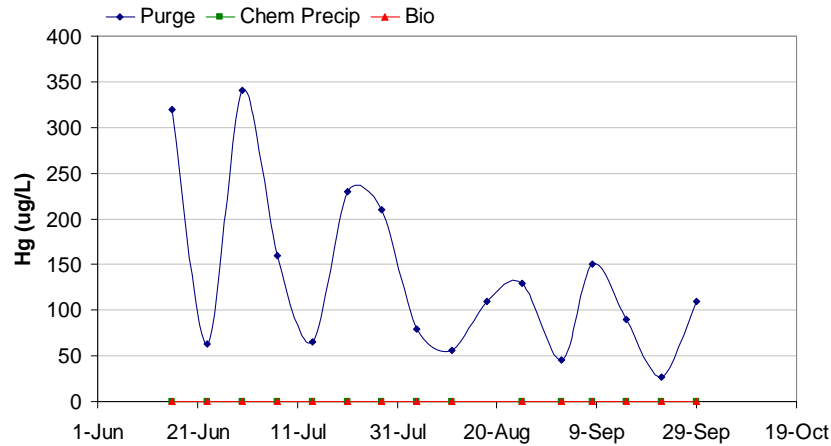

Figure 4-12C. Concentration of Mercury in FGD Scrubber Purge and Effluent from Chemical Precipitation and Biological Treatment Systems at Belews Creek

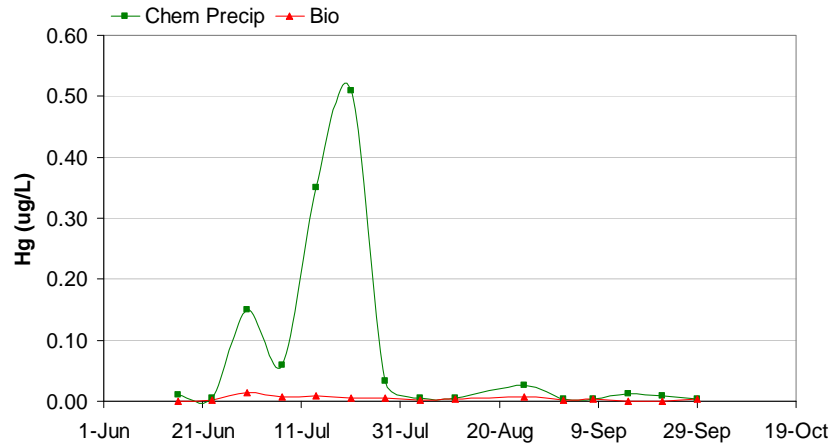

Figure 4-12D. Concentration of Mercury in Effluent from Chemical Precipitation and Biological Treatment Systems at Belews Creek

Roxboro Monitoring Data (2008)

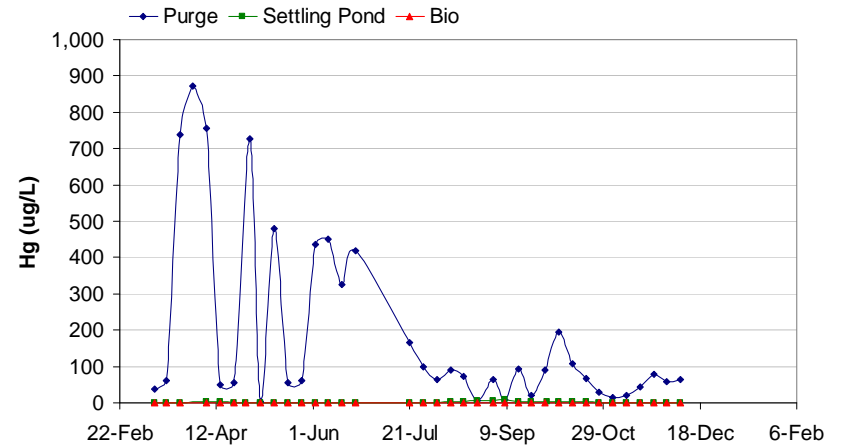

Figure 4-13C. Concentration of Mercury in FGD Scrubber Purge and Effluent from Settling Pond and Biological Treatment Systems at Roxboro

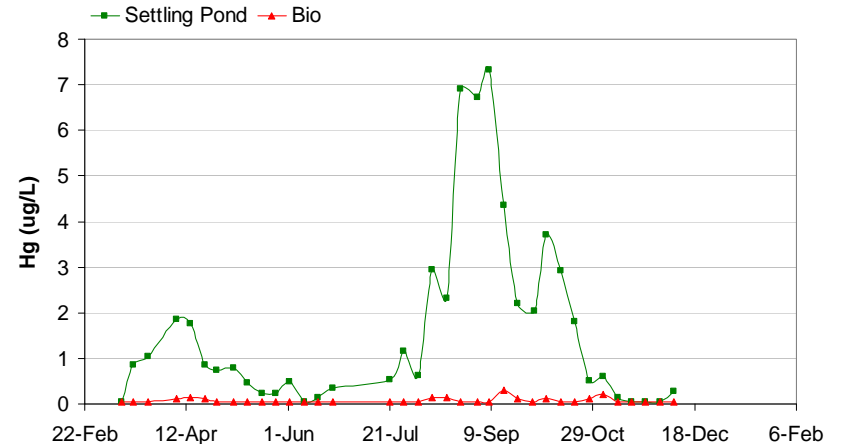

Figure 4-13D. Concentration of Mercury in Effluent from Settling Pond and Biological Treatment Systems at Roxboro

Belews Creek Monitoring Data (2008)

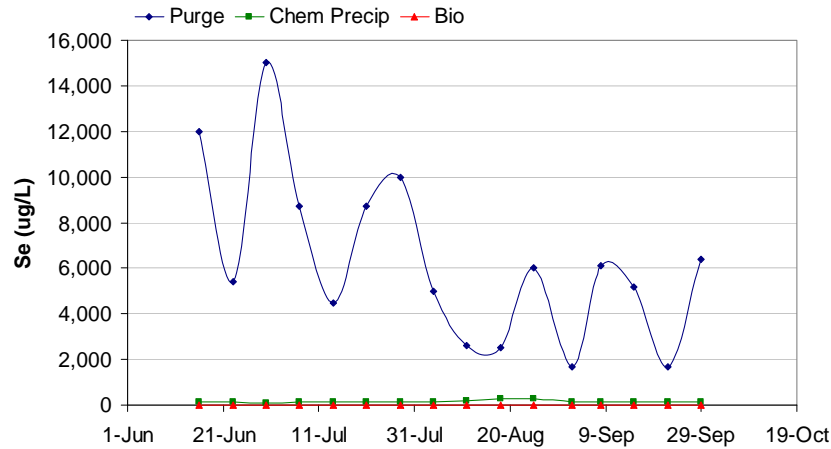

Figure 4-12E. Concentration of Selenium in FGD Scrubber Purge and Effluent from Chemical Precipitation and Biological Treatment Systems at Belews Creek

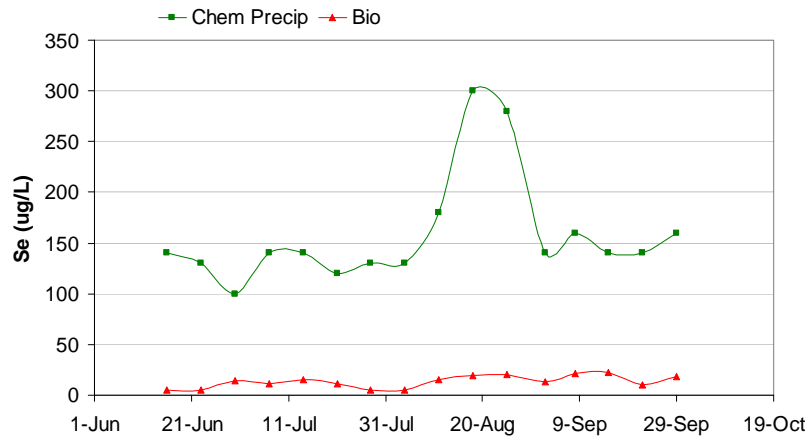

Figure 4-12F. Concentration of Selenium in Effluent from Chemical Precipitation and Biological Treatment Systems at Belews Creek

Roxboro Monitoring Data (2008)

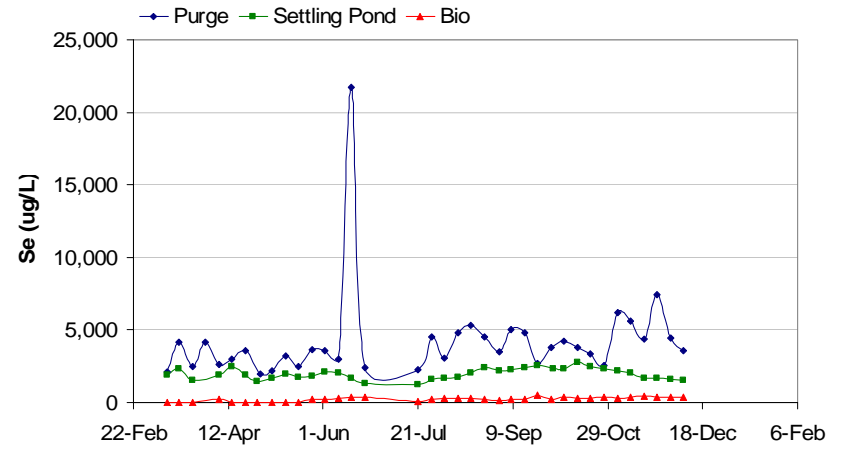

Figure 4-13E. Concentration of Selenium in FGD Scrubber Purge and Effluent from Settling Pond and Biological Treatment Systems at Roxboro

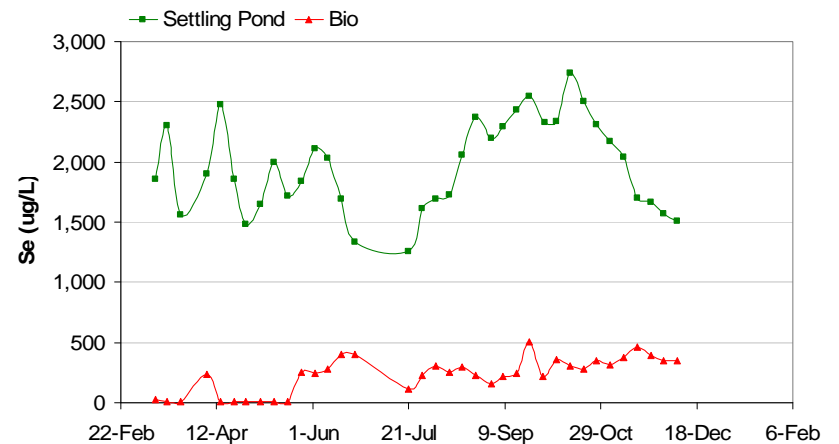

Figure 4-13F. Concentration of Selenium in Effluent from Settling Pond and Biological Treatment Systems at Roxboro

Belews Creek Monitoring Data (2008)

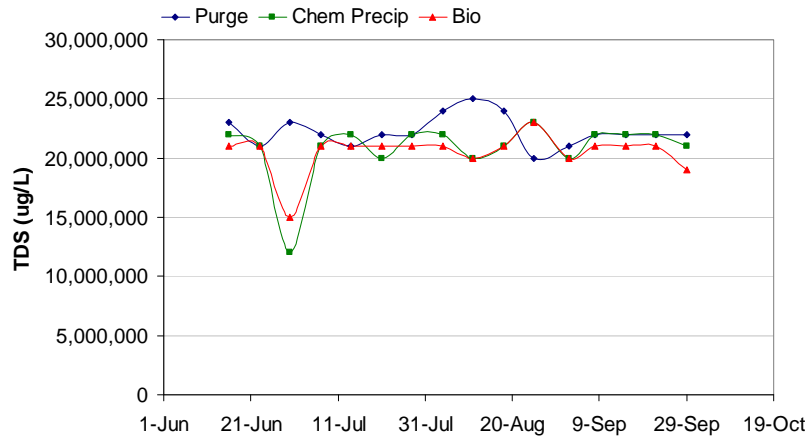

Figure 4-12G. Concentration of TDS in FGD Scrubber Purge and Effluent from Chemical Precipitation and Biological Treatment Systems at Belews Creek

Roxboro Monitoring Data (2008)

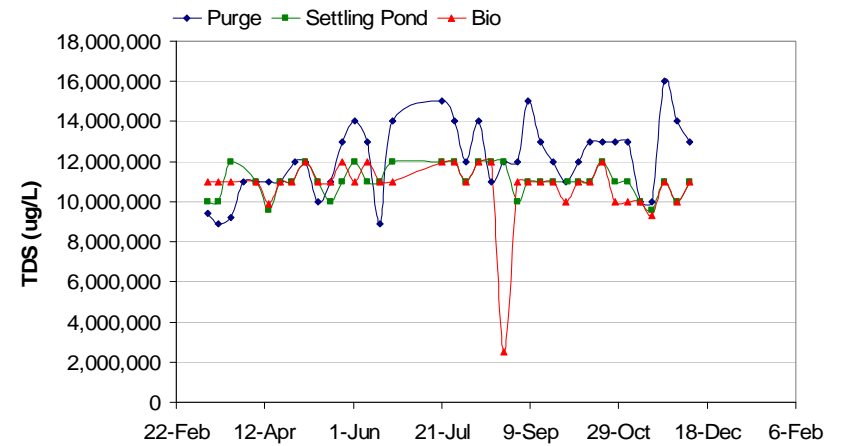

Figure 4-13G. Concentration of TDS in FGD Scrubber Purge and Effluent from Settling Pond and Biological Treatment Systems at Roxboro

Table 4-8 presents the pollutant concentrations associated with the effluent from the FGD wastewater treatment systems for the plants that EPA sampled. For comparison, refer to Table 4-5 in Section 4.3 for the pollutant concentrations representing the influent to the FGD wastewater treatment systems for these plants. Three of these plants operate chemical precipitation systems (Big Bend, Homer City, and Mitchell), and one of these plants operates both chemical precipitation and biological treatment stages (Belews Creek). The Widows Creek plant operates only a settling pond system.

The Widows Creek FGD wastewater treatment system is a pond system that consisted of three settling ponds at the time of sampling; however, during the two site visits prior to the sampling episode, the plant was operating four settling ponds. The FGD scrubber blowdown is pumped to the inlet channels of the pond system, which direct the wastewater to the first FGD settling pond. The overflow from the first FGD settling pond is transferred to a second FGD settling pond and then to a final FGD settling pond. The overflow from the final settling pond is then discharged from the plant. EPA collected a grab sample of the effluent from the third settling pond. [ERG, 2008o].

The Big Bend FGD wastewater treatment system consists of an equalization tank followed by a chemical precipitation system to reduce dissolved metals using lime for hydroxide precipitation and ferric chloride for coagulation and iron co-precipitation. The plant then adds a flocculating polymer to the wastewater and transfers it to a clarifier to remove the solids. The overflow from the clarifiers is filtered using sand gravity filters, transferred to a final holding tank, and then discharged. EPA collected a grab sample of the effluent downstream of the final holding tank. [ERG, 2008n].

The Homer City FGD wastewater treatment system consists of an equalization tank followed by a chemical precipitation system to reduce dissolved metals using lime for hydroxide precipitation, ferric chloride for coagulation and iron co-precipitation, and a clarifier for solids removal. The FGD wastewater is sent through a first stage of lime and ferric chloride precipitation followed by a clarifier, and the wastewater is then treated in a second stage of lime and ferric chloride precipitation followed by a clarifier. After the second clarifier, the wastewater is transferred to an aerobic biological treatment system designed to remove BOD. After the aerobic biological system, the wastewater is filtered, transferred to a final holding tank, and discharged. EPA collected a grab sample of the effluent directly from the final holding tank. [ERG, 2008l].

The Mitchell FGD wastewater treatment system consists of a chemical precipitation system to reduce dissolved metals using lime for hydroxide precipitation followed by a clarifier for solids removal. The overflow from the clarifier is transferred to an equalization tank, where treated effluent is recycled by the plant when the system is not discharging. After the equalization tank, the plant uses ferric chloride for iron co-precipitation and then adds an anionic polymer and transfers the wastewater to a second clarifier. The overflow from the second clarifier is transferred to a final holding tank and either transferred to the bottom ash pond and eventually discharged or recycled back to the equalization tank. EPA collected a grab sample of the effluent from the discharge line of the final holding tank. [ERG, 2008m].

Table 4-8. Pollutant Concentrations in Sampled Effluent from FGD Wastewater Treatment Systems

Analyte	Method	Unit	Settling Pond	Chemical Precipitation				Anoxic/Anaerobic Biological
			Widows Creek – Effluent from FGD Pond System ^{a, b}	Big Bend ^{a, b}	Homer ^{a, b}	Mitchell ^{a, b}	Belews Creek ^{b, c}	Belews Creek ^{b, d}
Routine Total Metals – 200.7								
Aluminum	200.7	µg/L	111	ND (50.0)	ND (50.0)	ND (50.0)	ND (50.0)	ND (50.0)
Antimony	200.7	µg/L	ND (20.0)	22.1 R	<20.8	ND (20.0)	ND (4.00)	ND (4.00)
Arsenic	200.7	µg/L	49.5	ND (10.0)	ND (10.0)	<10.3	ND (2.00)	ND (2.00)
Barium	200.7	µg/L	179	1,490	71.3 R	433	326	296 R
Beryllium	200.7	µg/L	ND (5.00)	ND (5.00)	7.68	ND (5.00)	ND (1.00)	ND (1.00)
Boron	200.7	µg/L	31,500	369,000	191,000	208,000	291,000	283,000 R
Cadmium	200.7	µg/L	ND (5.00)	24.9	ND (5.00)	ND (5.00)	ND (0.250)	ND (0.250)
Calcium	200.7	µg/L	987,000	4,420,000	2,000,000	2,380,000	5,670,000	5,570,000
Chromium	200.7	µg/L	ND (10.0)	ND (10.0)	ND (10.0)	ND (10.0)	25.3	24.2 R
Cobalt	200.7	µg/L	ND (50.0)	ND (50.0)	ND (50.0)	ND (50.0)	ND (2.50)	ND (2.50)
Copper	200.7	µg/L	ND (10.0)	<10.3	12.5	16.2	ND (2.50)	ND (2.50)
Iron	200.7	µg/L	ND (100)	ND (100)	<117	318	ND (25.0)	ND (25.0)
Lead	200.7	µg/L	ND (50.0)	ND (50.0)	ND (50.0)	ND (50.0)	ND (1.50)	ND (1.50)
Magnesium	200.7	µg/L	189,000	2,510,000	2,610,000	1,280,000	983,000	950,000
Manganese	200.7	µg/L	623	60.1	30,100	4,440	3,280	2,340 R
Mercury	245.1	µg/L	ND (2.00)	ND (10.0)	ND (10.0)	ND (10.0)	NA	NA
Molybdenum	200.7	µg/L	1,500	450 R	37.6	22.9	NA	NA
Nickel	200.7	µg/L	ND (50.0)	221	ND (50.0)	ND (50.0)	21.1	ND (1.00)
Selenium	200.7	µg/L	236	2,910 R	771	83.6 R	82.5	ND (5.00)
Silver	200.7	µg/L	ND (20.0)	ND (20.0)	ND (20.0)	ND (20.0)	7.90	7.75
Sodium	200.7	µg/L	69,500	1,590,000	1,280,000	305,000	60,300	58,900
Thallium	200.7	µg/L	ND (10.0)	16.8	ND (10.0)	ND (10.0)	62.5	52.7 R
Titanium	200.7	µg/L	ND (10.0)	13.5	ND (10.0)	<10.1	NA	NA
Vanadium	200.7	µg/L	42.1	ND (20.0)	ND (20.0)	ND (20.0)	2.10	ND (0.500)
Yttrium	200.7	µg/L	ND (5.00)	ND (5.00)	ND (5.00)	ND (5.00)	NA	NA
Zinc	200.7	µg/L	ND (10.0)	ND (10.0)	ND (10.0)	25.4	ND (25.0)	ND (25.0)

Table 4-8. Pollutant Concentrations in Sampled Effluent from FGD Wastewater Treatment Systems

Analyte	Method	Unit	Settling Pond	Chemical Precipitation				Anoxic/Anaerobic Biological
			Widows Creek – Effluent from FGD Pond System ^{a, b}	Big Bend ^{a, b}	Homer ^{a, b}	Mitchell ^{a, b}	Belews Creek ^{b, c}	Belews Creek ^{b, d}
Routine Dissolved Metals – 200.7								
Aluminum	200.7	µg/L	ND (50.0)	ND (50.0)	ND (50.0)	ND (50.0)	97.0 L	<78.5 L
Antimony	200.7	µg/L	ND (20.0)	20.8 T	ND (20.0)	ND (20.0)	4.50	ND (4.00)
Arsenic	200.7	µg/L	46.7	10.8 R,T	ND (10.0)	ND (10.0)	6.40 L	8.70 L,R
Barium	200.7	µg/L	191	1,410	70.6 R,T	389	270	271 R
Beryllium	200.7	µg/L	ND (5.00)	ND (5.00)	7.71	ND (5.00)	ND (1.00)	ND (1.00)
Boron	200.7	µg/L	29,200	397,000	184,000	199,000	306,000	284,000 R
Cadmium	200.7	µg/L	ND (5.00)	19.3	ND (5.00)	ND (5.00)	2.30	<0.875
Calcium	200.7	µg/L	932,000	5,210,000	1,930,000	2,270,000	5,790,000	5,760,000
Chromium	200.7	µg/L	ND (10.0)	ND (10.0)	ND (10.0)	ND (10.0)	ND (0.500)	<10.7 R
Hexavalent Chromium	D1687-92	µg/L	ND (2.00)	ND (2.00)	ND (2.00)	11.0	1.57	ND (0.500)
Cobalt	200.7	µg/L	ND (50.0)	ND (50.0)	ND (50.0)	ND (50.0)	ND (2.50)	ND (2.50)
Copper	200.7	µg/L	ND (10.0)	ND (10.0)	11.8	14.1	ND (2.50)	ND (2.50)
Iron	200.7	µg/L	ND (100)	ND (100)	166 R	ND (100)	ND (25.0)	<27.9
Lead	200.7	µg/L	ND (50.0)	ND (50.0)	ND (50.0)	ND (50.0)	ND (1.50)	ND (1.50)
Magnesium	200.7	µg/L	184,000	2,930,000	2,510,000	1,220,000	970,000	938,000
Manganese	200.7	µg/L	543 R	55.6	29,100	4,120	3,240	2,310
Mercury	245.1	µg/L	ND (2.00)	ND (10.0)	ND (10.0)	ND (10.0)	NA	NA
Molybdenum	200.7	µg/L	1,470	430 T	35.8	21.4	NA	NA
Nickel	200.7	µg/L	ND (50.0)	210	ND (50.0)	ND (50.0)	28.2	<2.15
Selenium	200.7	µg/L	226	2,860 R	741 R	71.7	58.7	ND (5.00)
Silver	200.7	µg/L	ND (20.0)	ND (20.0)	ND (20.0)	ND (20.0)	7.70	8.10
Sodium	200.7	µg/L	66,200	1,880,000	1,230,000	300,000	59,300	58,500
Thallium	200.7	µg/L	ND (10.0)	12.5	ND (10.0)	ND (10.0)	105	120 R
Titanium	200.7	µg/L	ND (10.0)	13.7	ND (10.0)	ND (10.0)	NA	NA
Vanadium	200.7	µg/L	40.0	ND (20.0)	ND (20.0)	ND (20.0)	2.50	0.665 R
Yttrium	200.7	µg/L	ND (5.00)	ND (5.00)	ND (5.00)	ND (5.00)	NA	NA
Zinc	200.7	µg/L	ND (10.0)	ND (10.0)	ND (10.0)	ND (10.0)	ND (25.0)	ND (25.0)

Table 4-8. Pollutant Concentrations in Sampled Effluent from FGD Wastewater Treatment Systems

Analyte	Method	Unit	Settling Pond	Chemical Precipitation				Anoxic/Anaerobic Biological
			Widows Creek – Effluent from FGD Pond System ^{a, b}	Big Bend ^{a, b}	Homer ^{a, b}	Mitchell ^{a, b}	Belews Creek ^{b, c}	Belews Creek ^{b, d}
Routine Total Metals – 200.8								
Aluminum	200.8	µg/L	NA	NA	NA	NA	61.6	67.2 R
Antimony	200.8	µg/L	NA	NA	NA	NA	3.60	0.465
Arsenic	200.8	µg/L	NA	NA	NA	NA	200	194
Arsenic	200.8 – DRC	µg/L	NA	NA	NA	NA	6.94	5.47
Barium	200.8	µg/L	NA	NA	NA	NA	465	466 R
Beryllium	200.8	µg/L	NA	NA	NA	NA	ND (0.300)	ND (0.300)
Boron	200.8	µg/L	NA	NA	NA	NA	260,000	250,000 R
Cadmium	200.8	µg/L	NA	NA	NA	NA	1.77	0.360 R
Calcium	200.8	µg/L	NA	NA	NA	NA	4,920,000	5,030,000
Chromium	200.8	µg/L	NA	NA	NA	NA	13.7	9.25
Chromium	200.8 – DRC	µg/L	NA	NA	NA	NA	0.855	ND (0.500)
Cobalt	200.8	µg/L	NA	NA	NA	NA	17.4	12.1
Copper	200.8	µg/L	NA	NA	NA	NA	2.13	1.08
Iron	200.8	µg/L	NA	NA	NA	NA	173	165
Iron	200.8 – DRC	µg/L	NA	NA	NA	NA	ND (50.0)	66.9
Lead	200.8	µg/L	NA	NA	NA	NA	ND (0.200)	ND (0.200)
Magnesium	200.8	µg/L	NA	NA	NA	NA	973,000	998,000
Manganese	200.8	µg/L	NA	NA	NA	NA	3,110	2,240
Manganese	200.8 – DRC	µg/L	NA	NA	NA	NA	3,330	2,350 R
Nickel	200.8	µg/L	NA	NA	NA	NA	159	102
Nickel	200.8 – DRC	µg/L	NA	NA	NA	NA	72.9	11.5 R
Selenium	200.8	µg/L	NA	NA	NA	NA	1,120	803
Selenium	200.8 – DRC	µg/L	NA	NA	NA	NA	313	159 R
Sodium	200.8	µg/L	NA	NA	NA	NA	48,200	50,000 R
Thallium	200.8	µg/L	NA	NA	NA	NA	7.03	ND (0.0250)
Vanadium	200.8	µg/L	NA	NA	NA	NA	113	154
Vanadium	200.8 – DRC	µg/L	NA	NA	NA	NA	3.67	<1.93

Table 4-8. Pollutant Concentrations in Sampled Effluent from FGD Wastewater Treatment Systems

Analyte	Method	Unit	Settling Pond	Chemical Precipitation				Anoxic/Anaerobic Biological
			Widows Creek – Effluent from FGD Pond System ^{a, b}	Big Bend ^{a, b}	Homer ^{a, b}	Mitchell ^{a, b}	Belews Creek ^{b, c}	Belews Creek ^{b, d}
Zinc	200.8	µg/L	NA	NA	NA	NA	5.87	5.89
Zinc	200.8 – DRC	µg/L	NA	NA	NA	NA	ND (2.00)	ND (2.00)
Routine Dissolved Metals – 200.8								
Aluminum	200.8	µg/L	NA	NA	NA	NA	51.8	58.7
Antimony	200.8	µg/L	NA	NA	NA	NA	3.69	0.430
Arsenic	200.8	µg/L	NA	NA	NA	NA	194	205
Arsenic	200.8 – DRC	µg/L	NA	NA	NA	NA	8.15	4.15
Barium	200.8	µg/L	NA	NA	NA	NA	457	459
Beryllium	200.8	µg/L	NA	NA	NA	NA	ND (0.300)	ND (0.300)
Boron	200.8	µg/L	NA	NA	NA	NA	261,000	238,000 R
Cadmium	200.8	µg/L	NA	NA	NA	NA	1.66	0.250 R
Calcium	200.8	µg/L	NA	NA	NA	NA	5,050,000	4,730,000
Chromium	200.8	µg/L	NA	NA	NA	NA	13.4	6.93
Chromium	200.8 – DRC	µg/L	NA	NA	NA	NA	0.775	ND (0.500)
Cobalt	200.8	µg/L	NA	NA	NA	NA	17.9	12.2
Copper	200.8	µg/L	NA	NA	NA	NA	2.20	ND (1.00)
Iron	200.8	µg/L	NA	NA	NA	NA	151	138
Iron	200.8 – DRC	µg/L	NA	NA	NA	NA	ND (50.0)	59.7
Lead	200.8	µg/L	NA	NA	NA	NA	ND (0.200)	ND (0.200)
Magnesium	200.8	µg/L	NA	NA	NA	NA	1,010,000	960,000
Manganese	200.8	µg/L	NA	NA	NA	NA	3,080	2,250
Manganese	200.8 – DRC	µg/L	NA	NA	NA	NA	3,140	2,300 R
Nickel	200.8	µg/L	NA	NA	NA	NA	158	104
Nickel	200.8 – DRC	µg/L	NA	NA	NA	NA	74.2	10.9
Selenium	200.8	µg/L	NA	NA	NA	NA	1,110	711
Selenium	200.8 – DRC	µg/L	NA	NA	NA	NA	281	151
Sodium	200.8	µg/L	NA	NA	NA	NA	48,700	47,100 R
Thallium	200.8	µg/L	NA	NA	NA	NA	7.04	ND (0.0250)

Table 4-8. Pollutant Concentrations in Sampled Effluent from FGD Wastewater Treatment Systems

Analyte	Method	Unit	Settling Pond	Chemical Precipitation				Anoxic/Anaerobic Biological
			Widows Creek – Effluent from FGD Pond System ^{a, b}	Big Bend ^{a, b}	Homer ^{a, b}	Mitchell ^{a, b}	Belews Creek ^{b, c}	Belews Creek ^{b, d}
Vanadium	200.8	µg/L	NA	NA	NA	NA	131	148
Vanadium	200.8 – DRC	µg/L	NA	NA	NA	NA	4.66	ND (1.00)
Zinc	200.8	µg/L	NA	NA	NA	NA	6.23	5.81
Zinc	200.8 – DRC	µg/L	NA	NA	NA	NA	ND (2.00)	ND (2.00)
Low-Level Total Metals - 1631E, 1638, HG-AFS								
Antimony	1638	µg/L	11.8	14.2	ND (0.400)	<1.37	3.75	0.545
Arsenic	1638	µg/L	47.6	68.0	23.0	<25.2	197	202
Arsenic	1638 – DRC	µg/L	NA	NA	NA	NA	4.86	2.51
Arsenic	HG-AFS	µg/L	NA	NA	NA	NA	2.27	0.247
Cadmium	1638	µg/L	3.73	25.8	ND (2.00)	ND (3.00)	1.51	0.230
Chromium	1638	µg/L	ND (16.0)	ND (80.0)	ND (16.0)	ND (120)	6.06	5.37
Chromium	1638 – DRC	µg/L	NA	NA	NA	NA	0.610	ND (0.500)
Copper	1638	µg/L	ND (4.00)	ND (20.0)	9.67	ND (30.0)	2.13	ND (1.00)
Lead	1638	µg/L	ND (1.00)	ND (5.00)	ND (1.00)	ND (1.50)	ND (0.200)	ND (0.200)
Mercury	1631E	µg/L	0.0438	0.156	0.117	0.788	0.0765	0.0133
Nickel	1638	µg/L	36.2	381	92.1	<155	113	97.1
Nickel	1638 – DRC	µg/L	NA	NA	NA	NA	54.3	9.00
Selenium	1638	µg/L	208	2,500	613	431 T	616	581
Selenium	1638 – DRC	µg/L	NA	NA	NA	NA	300	191
Selenium	HG-AFS	µg/L	NA	NA	NA	NA	139	4.93
Thallium	1638	µg/L	11.1	31.1	16.0	3.96	8.43	ND (0.0250)
Zinc	1638	µg/L	ND (10.0)	ND (50.0)	15.2	<83.5	6.24	4.87
Zinc	1638 – DRC	µg/L	NA	NA	NA	NA	ND (2.00)	ND (2.00)
Low-Level Dissolved Metals - 1631E, 1636, 1638, HG-AFS								
Antimony	1638	µg/L	11.9	13.7	ND (0.400)	1.64	3.73	0.545
Arsenic	1638	µg/L	46.5	72.4	22.5	20.9 T	196	199
Arsenic	1638 – DRC	µg/L	NA	NA	NA	NA	5.79	2.63
Arsenic	HG-AFS	µg/L	NA	NA	NA	NA	2.12	0.227

Table 4-8. Pollutant Concentrations in Sampled Effluent from FGD Wastewater Treatment Systems

Analyte	Method	Unit	Settling Pond	Chemical Precipitation				Anoxic/Anaerobic Biological
			Widows Creek – Effluent from FGD Pond System ^{a, b}	Big Bend ^{a, b}	Homer ^{a, b}	Mitchell ^{a, b}	Belews Creek ^{b, c}	Belews Creek ^{b, d}
Cadmium	1638	µg/L	3.74	22.2	ND (2.00)	ND (1.00)	1.53	0.210
Chromium	1638	µg/L	ND (16.0)	ND (80.0)	ND (16.0)	ND (80.0)	6.23	5.16
Chromium	1638 – DRC	µg/L	NA	NA	NA	NA	0.700	ND (0.500)
Hexavalent Chromium	1636	µg/L	3.20	ND (5.00)	ND (2.50)	ND (2.50)	ND (0.500)	ND (0.500)
Copper	1638	µg/L	ND (4.00)	ND (20.0)	9.39	ND (20.0)	1.57	ND (1.00)
Lead	1638	µg/L	ND (1.00)	ND (5.00)	ND (1.00)	ND (0.500)	ND (0.200)	ND (0.200)
Mercury	1631E	µg/L	0.0107	0.0688	0.0542	0.159	0.00804	<0.00168
Nickel	1638	µg/L	33.3 L	396	93.5	102	84.4	96.2
Nickel	1638 – DRC	µg/L	NA	NA	NA	NA	43.8	10.1
Selenium	1638	µg/L	293	2,560	620	407	651	564
Selenium	1638 – DRC	µg/L	NA	NA	NA	NA	305	194
Selenium	HG-AFS	µg/L	NA	NA	NA	NA	137	2.67
Thallium	1638	µg/L	11.0	31.5	15.8	3.99	8.55	ND (0.0250)
Zinc	1638	µg/L	ND (10.0)	ND (50.0)	15.7	ND (50.0)	4.40	4.93
Zinc	1638 – DRC	µg/L	NA	NA	NA	NA	ND (2.00)	ND (2.00)
Classicals								
Ammonia As Nitrogen (NH ₃ -N)	4500-NH3F	mg/L	0.220	24.1	0.295	3.49	1.80	2.73
Nitrate/Nitrite (NO ₃ -N + NO ₂ -N)	353.2	mg/L	0.0945	NA	36.5 R	25.4	14.0	ND (0.100)
Total Kjeldahl Nitrogen (TKN)	4500-N,C	mg/L	2.51	98.7	3.04	9.74	4.05	5.77
Biochemical Oxygen Demand (BOD)	5210B	mg/L	<10.0	>1,720	ND (120)	<7.50	ND (4.00)	9
Chemical Oxygen Demand (COD)		mg/L	NA	NA	NA	NA	501	451
Chloride	4500-CL-C	mg/L	1,120	22,500	11,800	6,700	9,720	9,960
Hexane Extractable Material (HEM)	1664A	mg/L	ND (5.00)	6.00	ND (5.00)	5.00	ND (5.00)	ND (5.00)
Silica Gel Treated HEM (SGT-HEM)	1664A	mg/L	NA	ND (6.00)	NA	ND (4.00)	ND (5.00)	ND (5.00)
Sulfate	D516-90	mg/L	2,060	1,920	2,790	1,770	1,210	1,240

Table 4-8. Pollutant Concentrations in Sampled Effluent from FGD Wastewater Treatment Systems

Analyte	Method	Unit	Settling Pond	Chemical Precipitation				Anoxic/Anaerobic Biological
			Widows Creek – Effluent from FGD Pond System ^{a, b}	Big Bend ^{a, b}	Homer ^{a, b}	Mitchell ^{a, b}	Belews Creek ^{b, c}	Belews Creek ^{b, d}
Total Dissolved Solids (TDS)	2540 C	mg/L	5,830	40,600	22,600	17,700	34,000	33,800
Total Phosphorus	365.3	mg/L	0.0115 E	0.355	0.520	0.0745	ND (0.100)	ND (0.100)
Total Suspended Solids (TSS)	2540 D	mg/L	8.00 E	31.5	<5.50	17.5	30.0	21.3

Source: [ERG, 2008l; ERG, 2008m; ERG, 2008n; ERG, 2008o; ERG, 2009q].

Note: EPA used several analytical methods to analyze for metals during the sampling program. For the purposes of sampling program, EPA designated some of the analytical methods as “routine” and some of them as “low-level.” EPA designated all of the methods that require the use of clean hands/dirty hands sample collection techniques (i.e., EPA Method 1669 sample collection techniques) as “low-level” methods. Note that although not required by the analytical method, EPA used clean hands/dirty hands collection techniques for all low-level and routine metals samples.

a – The FGD effluent results represent the average of the FGD effluent and the duplicate of the FGD effluent analytical measurements.

b – The concentrations presented have been rounded to three significant figures.

c – The FGD chemical precipitation effluent results represent the average of the FGD chemical precipitation effluent day 1 and FGD chemical precipitation effluent day 2 measurements, if the analyte was collected on both days of sample collection.

d – The FGD effluent results represent the average of the FGD effluent day 1, the FGD effluent day 2, and the duplicate of the FGD effluent analytical measurements, if all three measurements were collected for the analyte. Otherwise, it represents the average of the FGD effluent day 1 and the duplicate of the FGD effluent analytical measurements.

< – Average result includes at least one nondetect value (calculation uses the report limit for nondetected results).

> – Result above measurement range.

E – Sample analyzed outside holding time.

L – Sample result between 5x and 10x blank result.

R – MS/MSD % Recovery outside method acceptance criteria.

T – MS/MSD RPD outside method acceptance criteria.

NA – Not analyzed.

ND – Not detected (number in parenthesis is the report limit). The sampling episode reports for each of the individual plants contains additional sampling information, including analytical results for analytes measured above the detection limit, but below the reporting limit (i.e., J-values).

The Belews Creek FGD wastewater treatment system consists of an equalization tank, chemical precipitation system, clarifier, anoxic/anaerobic biological treatment system, and constructed wetland²³. EPA collected grab samples of the effluents from the chemical precipitation and biological treatment stages. [ERG, 2009q].

Table 4-9 through Table 4-11 summarize the monitoring data EPA collected from individual plants/companies representing the effluent from settling ponds, effluent from chemical precipitation systems, and the effluent from anoxic/anaerobic biological treatment systems, respectively. The tables present the number of plants that reported concentration data for the analyte at the given effluent point, the total number of samples at the point for all the plants, and the minimum and maximum concentrations. Because the data included in these tables were provided by individual plants and the plants may monitor different analytes, the data presented in each table do not necessarily contain the same list of analytes [ERG, 2009x].

Table 4-9. Monitoring Data: Pollutant Concentrations in Effluent from Settling Ponds

Analyte	Number of Plants	Number of Samples	Minimum Concentration	Maximum Concentration ^a	Units
Total Metals					
Aluminum	1	37	ND (50)	632	µg/L
Antimony	1	37	ND (2)	36	µg/L
Arsenic	1	37	6.4	201	µg/L
Barium	1	37	37.5	528	µg/L
Beryllium	1	37	ND (0.7)	1.02	µg/L
Boron	1	37	7,950	108,000	µg/L
Cadmium	1	37	ND (0.5)	6.11	µg/L
Chromium	1	37	ND (0.61)	2,110	µg/L
Cobalt	1	37	ND (1.1)	36	µg/L
Copper	1	37	ND (1.6)	44.4	µg/L
Iron	1	37	ND (20)	13,000	µg/L
Lead	1	37	ND (1.9)	ND (220)	µg/L
Manganese	1	37	ND (11)	3,210	µg/L
Mercury	1	36	ND (0.11)	7.32	µg/L
Molybdenum	1	37	ND (0.11)	47	µg/L
Nickel	1	37	11.5	2,190	µg/L
Selenium	1	37	1,180	2,740	µg/L
Silver	1	37	ND (0.2)	30	µg/L
Thallium	1	37	ND (0.2)	102	µg/L
Vanadium	1	37	ND (0.36)	285	µg/L
Zinc	1	37	ND (3.8)	136	µg/L

²³ At the time sampling was conducted, Belews Creek was transferring the effluent from the biological treatment system to the constructed wetland treatment system (CWTS); however, Belews Creek plans to reroute the biological treatment effluent to bypass the CWTS and be transferred directly to the ash pond.

Table 4-9. Monitoring Data: Pollutant Concentrations in Effluent from Settling Ponds

Analyte	Number of Plants	Number of Samples	Minimum Concentration	Maximum Concentration ^a	Units
Classicals					
COD	1	33	120	370	mg/L
TSS	1	36	2.60	53.0	mg/L
TDS	1	36	9,600	12,000	mg/L
Sulfate	1	34	1,100	1,300	mg/L
Chloride	1	36	3,600	5,300	mg/L
Fluoride	1	36	6.30	10.0	mg/L
Nitrate/nitrite	1	1	12.0	12.0	mg/L
Total Kjeldahl nitrogen	1	1	1.20	1.20	mg/L
Total Phosphorus	1	1	ND (0.050)	ND (0.050)	mg/L

Source: [ERG, 2009x].

a – The maximum concentration presented is the maximum detected value in the data set, unless all the results in the data set were not detected for the analyte.

Table 4-10. Monitoring Data: Pollutant Concentrations in Effluent from Chemical Precipitation Systems

Analyte	Number of Plants	Number of Samples	Minimum Concentration	Maximum Concentration ^a	Units
Total Metals					
Aluminum	1	1	183	183	µg/L
Antimony	2	8	3.7	28	µg/L
Arsenic	5	101	1.6	310	µg/L
Barium	1	1	1,520	1,520	µg/L
Beryllium	3	52	ND (0.03)	0.94	µg/L
Boron	2	7	17,000	474,000	µg/L
Cadmium	3	18	0.07	21.9	µg/L
Calcium	1	7	670,000	790,000	µg/L
Chromium	4	48	0.12	69	µg/L
Cobalt	1	1	ND (10)	ND (10)	µg/L
Copper	4	50	1.3	71	µg/L
Iron	3	16	19	6,000	µg/L
Lead	4	47	ND (0.07)	11	µg/L
Magnesium	2	8	ND (3,000)	9,200,000	µg/L
Manganese	2	7	ND (10)	63,000	µg/L
Mercury	5	275	0.0019	61	µg/L
Molybdenum	1	1	63	63	µg/L
Nickel	5	66	4.7	810	µg/L
Selenium	6	398	16	18,000	µg/L
Silver	3	17	0.02	1.64	µg/L
Sodium	2	7	1,000,000	1,700,000	µg/L

Table 4-10. Monitoring Data: Pollutant Concentrations in Effluent from Chemical Precipitation Systems

Analyte	Number of Plants	Number of Samples	Minimum Concentration	Maximum Concentration ^a	Units
Thallium	1	1	ND (10)	ND (10)	µg/L
Tin	1	1	ND (50)	ND (50)	µg/L
Titanium	1	1	ND (50)	ND (50)	µg/L
Vanadium	1	1	ND (10)	ND (10)	µg/L
Zinc	4	35	1.7	15	µg/L
Dissolved Metals					
Antimony	1	6	4	6	µg/L
Arsenic	1	23	ND (2.4)	240	µg/L
Beryllium	1	19	ND (0.19)	0.94	µg/L
Boron	1	4	17,000	22,000	µg/L
Cadmium	1	3	0.74	0.74	µg/L
Calcium	1	5	660,000	710,000	µg/L
Chromium	1	6	12	27	µg/L
Copper	1	6	11	36	µg/L
Iron	1	5	ND (32)	ND (8,800)	µg/L
Lead	1	4	ND (0.6)	5.2	µg/L
Magnesium	1	6	6,200,000	7,400,000	µg/L
Manganese	1	6	42,000	62,000	µg/L
Mercury	1	195	0.032	54	µg/L
Nickel	1	6	170	810	µg/L
Selenium	1	25	62	4,300	µg/L
Silver	1	4	0.61	1.9	µg/L
Sodium	1	5	1,100,000	1,300,000	µg/L
Zinc	1	5	7.7	17	µg/L
Classicals					
TSS	1	10	3.93	33	mg/L
TDS	1	16	12,000	23,000	mg/L
Sulfate	2	9	930	24,000	mg/L
Chloride	2	21	4,700	20,500	mg/L
Bromide	1	4	180	260	mg/L
Fluoride	1	8	0.91	8.60	mg/L
NH ₃ -N	2	27	2.30	65.6	mg/L
Total Nitrogen, as N	1	30	2.05	165	mg/L
HEM	1	6	ND (5.00)	ND (5.00)	mg/L
n-Hexane	1	29	ND (1.40)	2.70	mg/L

Source: [ERG, 2009x].

a – The maximum concentration presented is the maximum detected value in the data set, unless all the results in the data set were not detected for the analyte.

Table 4-11. Monitoring Data: Pollutant Concentrations in Effluent from Biological Treatment Systems

Analyte	Number of Plants	Number of Samples	Minimum Concentration	Maximum Concentration ^a	Units
Total Metals					
Aluminum	1	37	ND (32)	602	µg/L
Antimony	1	37	ND (2)	92	µg/L
Arsenic	2	53	ND (10)	93	µg/L
Barium	1	37	26.2	2,440	µg/L
Beryllium	1	37	ND (0.7)	1.89	µg/L
Boron	2	38	7,820	666,000	µg/L
Cadmium	1	37	ND (0.5)	3.57	µg/L
Chromium	1	37	ND (1)	4,020	µg/L
Cobalt	1	37	ND (1.1)	241	µg/L
Copper	1	37	ND (1.6)	628	µg/L
Iron	1	37	ND (22)	23,000	µg/L
Lead	1	37	ND (1.9)	291	µg/L
Manganese	1	37	52	3,170	µg/L
Mercury	2	51	ND (0.001)	0.3	µg/L
Molybdenum	1	37	ND (2)	192	µg/L
Nickel	2	53	ND (1.8)	3,770	µg/L
Selenium	2	53	ND (10)	510	µg/L
Silver	1	37	ND (0.2)	36	µg/L
Thallium	1	37	ND (0.36)	97	µg/L
Vanadium	1	37	ND (1)	293	µg/L
Zinc	2	53	ND (1)	432	µg/L
Dissolved Metals					
Selenium	1	16	ND (10)	18	µg/L
Classicals					
COD	1	33	120	380	mg/L
TSS	1	36	1.10	12.0	mg/L
TDS	2	52	2,500	23,000	mg/L
Sulfate	2	39	970	1,300	mg/L
Chloride	1	36	3,800	5,100	mg/L
Fluoride	1	36	5.30	11.0	mg/L
NO ₃ -N + NO ₂ -N	1	1	0.056	0.056	mg/L
TKN	1	1	2.70	2.70	mg/L
Total Phosphorus	1	1	0.160	0.160	mg/L

Source: [ERG, 2009x].

a – The maximum concentration presented is the maximum detected value in the data set, unless all the results in the data set were not detected for the analyte.

4.6 **FGD Pollutant Loads Estimates**

As discussed in Section 4.2, wet FGD systems need to prevent the buildup of certain constituents (e.g., chlorides), which is often accomplished by purging a wastewater stream. Because of the corrosivity of chlorides, plants do not typically reuse the FGD wastewater for other process operations and will typically discharge the FGD purge stream.

EPA used data collected during EPA's sampling program, as well as self-monitoring data obtained from individual plants, to estimate the mass of pollutants (pollutant loads) associated with the FGD scrubber purge (prior to treatment) and the effluent associated with four treatment alternatives: settling ponds; chemical precipitation; biological treatment; and evaporation/crystallization. EPA estimated these loads for two model plant sizes, which are discussed further below. EPA then used these model plant loads to estimate industry-wide total pollutant loads for FGD wastewaters being discharged from the coal-fired steam electric industry. EPA also estimated the pollutant removals that would be achieved by the industry through installing or upgrading existing FGD wastewater controls.

4.6.1 *FGD Wastewater Treatment Industry Profile*

To estimate FGD wastewater loads for the entire steam electric industry, EPA developed an industry profile and determined the number of coal-fired power plants that currently operate wet or dry scrubbers (as of June 2008), and the number of plants that are planning or projected to install wet or dry scrubbers by 2020.

To generate this industry profile, EPA used EIA data to identify power plants that operate at least one coal-fired electric generating unit. From the available information, EPA identified 488 coal-fired power plants that are currently operating a coal-fired generating unit as well as three additional plants that are either planning or constructing a coal-fired generating unit. For each of these 491 plants, EPA then determined whether the plant currently operates a wet or dry scrubber (as of June 2008) and whether the plant has announced plans or is projected to install a scrubber by 2020. EPA additionally used information from the site visit and sampling program, the data request, and other publicly available information to identify the wastewater treatment systems that the plants operate to treat the FGD wastewater stream. If EPA did not have information to identify the type of FGD wastewater treatment system for the plant, EPA assumed that the plant operates a settling pond, which is the most commonly used FGD wastewater treatment system.

As part of this industry profile and for estimating the pollutant loads, EPA also classified the plants into one of two model plant sizes, "small" or "large," based on the FGD purge flow rate and the necessary treatment system capacity. For those plants for which purge flow rate is unknown, EPA classified the plants based on the total wet scrubbed capacity of the plant (i.e., the total capacity of the electric generating units that are wet scrubbed).

EPA used these model plants to better estimate the loads associated with the industry, by grouping the plants into two different sizes instead of assuming that all plants in the industry are the same size. The data and methodologies used to generate the FGD wastewater treatment industry profile are discussed in detail in the memorandum entitled "Development of the Current and Future Industry Profile for the Steam Electric Detailed Study," dated October 9, 2009 [ERG, 2009s].

For each model plant size, EPA calculated a flow rate to use in the loads calculation for each of the model plants. The memorandum entitled “Technology Option Loads Calculation Analysis for Steam Electric Detailed Study,” dated October 9, 2009 [ERG, 2009t], describes in detail the calculation of the model plant flow rates.

4.6.2 Calculation of Loads

EPA used data collected during EPA’s sampling program and monitoring data obtained from individual plants to calculate loads associated with the FGD wastewater discharges from coal-fired power plants. EPA calculated these loads to evaluate the effectiveness of the FGD wastewater treatment systems

To calculate pollutant loads associated with the FGD scrubber purge, EPA calculated plant-specific loads to account for differences in the FGD system configurations and operating characteristics at the plants. EPA first calculated the scrubber purge loads on a plant basis using data from the four plants for which EPA had both scrubber purge concentrations and scrubber purge flow rate data available. After calculating the plant-specific loads for each of these plants, EPA calculated an average load for each pollutant and an average flow rate associated with the load for each pollutant. EPA then divided the average pollutant load by the average flow rate to calculate a weighted-average concentration for each pollutant.

To calculate pollutant loads associated with FGD settling pond effluent, EPA used data representing the effluent from a settling pond treating FGD scrubber purge from all the plants for which EPA had available data. For some plants, EPA estimated the settling pond effluent concentrations based on scrubber purge concentrations obtained during EPA’s sampling program. The assumptions used to estimate the settling pond effluent concentrations are described in the memorandum entitled “Technology Option Loads Calculation Analysis for Steam Electric Detailed Study,” dated October 9, 2009 [ERG, 2009t]. EPA used the settling pond effluent concentration data from all the plants for which data were available to determine an average concentration for each pollutant.

To calculate the effluent pollutant loads for the chemical precipitation and biological treatment technologies, EPA used effluent concentration data from plants that represent these treatment technologies. The effluent data from these plants were used to determine an average concentration for each pollutant. For the evaporation/crystallization treatment technology, EPA assumed the effluent pollutant loads were equal to zero.

After calculating these average pollutant concentrations, EPA multiplied the concentrations by the “small” and “large” model plant flow rates to determine the individual pollutant loads for the FGD scrubber purge, settling pond effluent, and effluent from each of the treatment technologies for both a “small” and a “large” model plant. EPA then multiplied the loads by each pollutant’s individual toxic weighting factor (TWF) to calculate the toxic-weighted pound equivalent (TWPE) for each pollutant. Because the TWPE accounts for each pollutant’s toxicity, it allows for a relative comparison of the pollutant discharges. Finally, EPA summed the individual pollutant TWPE to calculate the total TWPE for the FGD scrubber purge, settling pond effluent, and effluent from each of the treatment technologies for each model plant size.

Table 4-12 presents EPA’s model plant loads, in TWPE per year, for the FGD scrubber purge, settling pond effluent, and effluent from each of the treatment technologies. The

memorandum entitled “Technology Option Loads Calculation Analysis for Steam Electric Detailed Study,” dated October 9, 2009 [ERG, 2009t], describes the data and methodology used to calculate pollutant loads.

Table 4-12. Treatment Technology Loads by Model Plant Size

Waste Stream/Treatment System	Small Model Plant Loads (TWPE/Year)	Large Model Plant Loads (TWPE/Year)
FGD Scrubber Purge (prior to treatment)	28,400	97,300
Settling Pond	10,900	37,300
Chemical Precipitation	6,410	22,000
Chemical Precipitation + Biological Treatment	2,650	9,080
Chemical Precipitation + Evaporation	0	0

Source: [ERG, 2009t].

4.6.3 Industry Baseline and Treatment Technology Loads

EPA used the FGD wastewater treatment industry profile information (see Section 4.6.1) and the model plant treatment technology loads (see Section 4.6.2) to estimate the FGD discharge loads associated with the steam electric industry. EPA calculated the loads for the “current” industry, based on the status of FGD operations as of June 2008, and the “future” industry, based on projections of FGD operations in 2020. EPA estimated the baseline loads for the industry by multiplying the model plant loads for each treatment scenario by the number of small and large plants operating that treatment system. If EPA lacked treatment information for a plant, EPA assumed the plant currently operates or will operate a settling pond treatment system.

Based on information in EPA’s combined data set, 108 plants are currently operating wet FGD systems and EPA estimates that 77 of these plants discharge FGD wastewater. EPA also estimates that more than 192 plants will be operating wet FGD scrubbers by 2020 and that 158 of these plants will discharge FGD wastewater.²⁴

EPA estimated the industry loads for the FGD scrubber purge, settling pond effluent, and the three control technologies by multiplying the model plant loads by the number of plants operating that treatment system. EPA then summed the resulting “small” and “large” model plant TWPE to determine the total TWPE for each scenario. EPA calculated the baseline loads by summing the total TWPE for the settling pond and three treatment technologies.

EPA also calculated industry-level loads that would result from plants installing or upgrading to a particular level of treatment technology (i.e., the industry-level chemical precipitation loads assume that all plants operating a settling pond will install a chemical precipitation system and all other plants will continue operating with their current system). Figure 4-14 presents a comparison of the total baseline industry effluent loads to the effluent loads estimated for each of the different scenarios.

²⁴ As discussed in section 4.1.2, EPA’s projections for new FGD systems do not include the systems that will be installed at new generating units or new plants. Thus, the projections for 2020 are considered to under-estimate the actual number of FGD systems that will be installed.

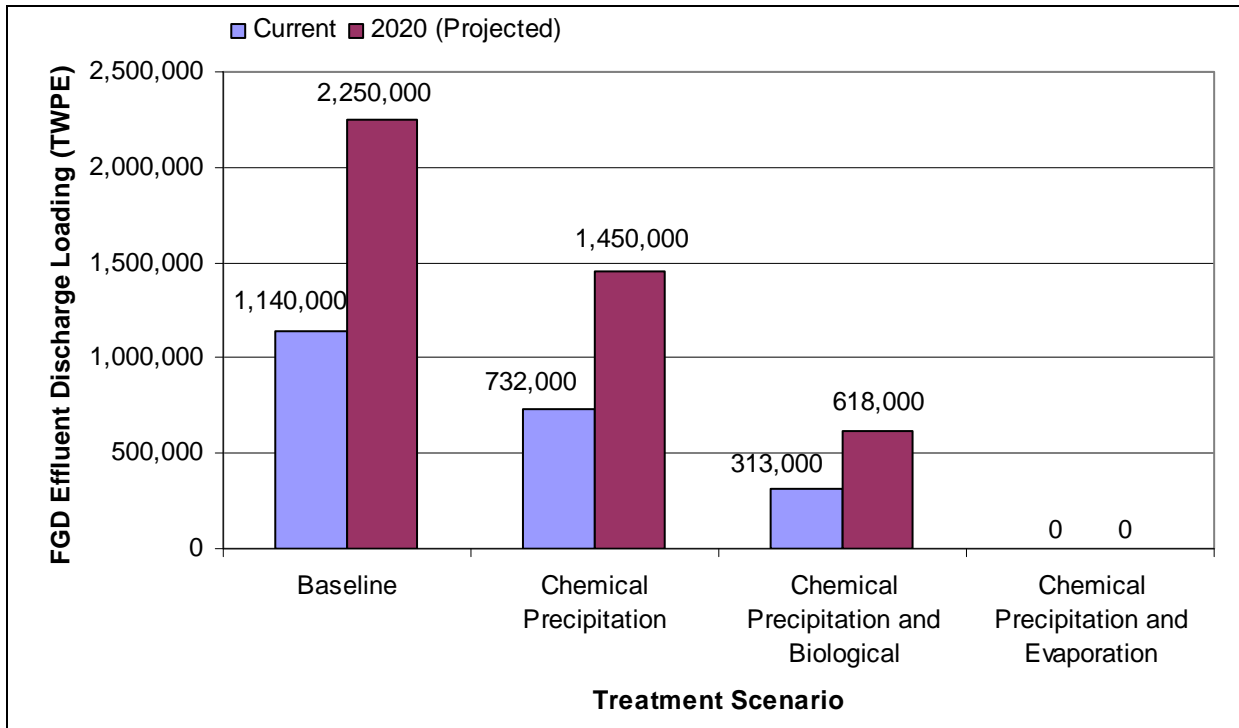

Figure 4-14. Estimated Industry-Level FGD Effluent Discharge Loadings By Treatment Scenario

5. COAL ASH HANDLING SYSTEMS

Combusting coal in steam electric boilers generates solid, noncombustible constituents of the coal, referred to as ash. The heavier ash particles that collect on the bottom of the boiler are referred to as bottom ash and may also be called slag. The finer ash particles that are light enough to be transferred out of the boiler with the flue gas exhaust are referred to as fly ash. Some of the particles that are initially carried with the flue gases collect in the economizer or air preheater sections of the boiler. Depending on operations at the plant, this ash may be handled along with either the fly ash or bottom ash.

This chapter presents an overview of fly ash and bottom ash handling systems at coal-fired power plants within the steam electric industry, with particular emphasis on the wastewaters generated from the process and the treatment of those wastewaters.

5.1 Fly Ash Handling Operations

To remove the fly ash particles from the flue gas at coal-fired power plants, many plants operate electrostatic precipitators (ESPs). ESPs use high voltage to generate an electrical charge on the particles contained in the flue gas. The charged particles then collect on a metal plate with an opposite electric charge. Additionally, some plants may use agglomerating agents, such as ammonia, which help small charged ash particles form larger agglomerates that are more readily attracted to the charged plates, improving the removal efficiency of the ESPs. As the particles begin to layer on the metal plates, the plates are tapped/rapped to loosen the particles, which fall into collection hoppers. ESPs are the most common type of fly ash collection system used by the steam electric industry, and the system can achieve removals of greater than 99.9 percent [Babcock & Wilcox, 2005].

Plants may also use other particulate control technologies, such as baghouse filters. A baghouse system contains several compartments, each containing fabric filter bags that are suspended vertically in the compartment. The bags can be quite long (e.g., 40 feet) and small in diameter [Babcock & Wilcox, 2005].

The reverse air system is the baghouse configuration most commonly used by steam electric plants. In this system, the flue gas enters into the various compartments and is forced to flow into the bottom of the fabric filter bags. The flue gas passes through the fabric filter material, but the fly ash particulates cannot pass and are captured on the inside walls of the baghouses. As the baghouses collect more particulates, the layer of particulates becomes thicker and also helps to remove particulates from the flue gas. After a specified period of time or once the pressure drop in the baghouses reaches a high set point level, the plants reverse the flow in a compartment and send clean flue gas from the outside of the fabric filter bags to the inside, which dislodges the particulates. The particulates are captured in hoppers at the bottom of the compartment [Babcock & Wilcox, 2005].

Additionally, some plants use venturi-type wet scrubbers to remove fly ash and SO₂ emissions. Venturi scrubbers contain a tube with flared ends and a constricted middle section. The flue gas enters from one of the flared ends and approaches the constricted section. The liquid slurry stream is added to the scrubber just prior to or at the constricted section. As the flue gas enters the constricted section, its pressure increases and the velocity of the gas increases, which causes the gas and liquid slurry to mix. The greater the pressure drop in the scrubber, the better

the mixing and the better the reaction rate, which increases the sulfur dioxide and particulate removal efficiency. However, venturi scrubbers must be operated at high pressure drops to remove the same level of particulates as ESPs, which results in higher operating expenses for venturi scrubbers compared to ESPs. The scrubber blowdown from a venturi scrubber is handled similarly to the FGD scrubber blowdown from other FGD operations, which are described in Section 4.2 [Babcock & Wilcox, 2005; U.S. EPA, 2007b].

After the ESP or baghouse deposits the fly ash into the hoppers, the plant can either handle the fly ash in a dry or wet fashion. In either system, dry fly ash is initially drawn away from the hoppers using a vacuum to pneumatically transport the ash. Plants that operate a dry fly ash handling system pneumatically transfer the fly ash from the hoppers to fly ash storage silos. From the silos, the fly ash is loaded into trucks or rail cars and either hauled to a landfill for disposal or hauled off site for beneficial use.

Plants operating a wet fly ash handling system also use vacuum to draw the fly ash away from the hoppers, but this vacuum will typically be created by water flowing through an eductor. These water jet eductors, also known as venture eductors, use the kinetic energy of the water to create the vacuum for the dry portion of the ash handling system. The ash is pulled to a separator/transfer tank, where it combines with the water flowing through the sluice pipes and is transported to the ash pond. Plants usually have a sluice stream for each individual ESP or set of hoppers, with the sluice water flowing continuously to maintain the necessary vacuum and prevent solids from settling in the piping.

EPA compiled information regarding management techniques for fly ash and wastewater treatment systems for fly ash transport water. Table 5-1 presents fly ash handling practices at plants included in EPA's combined data set, which includes UWAG-provided data, site visits and sampling data, and data request information. Approximately one-third of these plants handle the majority of their fly ash wet. In addition to the combined data set, EPA identified 46 additional plants that operate wet fly ash handling systems through application data reported to the NPDES permit program (also known as Form 2C data) [UWAG, 2008]. However, EPA was unable to determine the number of generating units and capacity associated with these wet fly ash handling operations; therefore, these plants are not included in Table 5-1. Nevertheless, these data suggest that at least 80 plants are operating wet fly ash handling systems (34 plants in combined data set plus 46 additional plants in the Form 2C database).

EPA also reviewed data recently collected by EPA's Office of Solid Waste and Emergency Response (OSWER), which sent letters to power plants requiring that they report certain information about waste management units used for the storage or disposal of coal combustion residues. The OSWER database identifies 188 plants that are operating 398 surface impoundments containing fly ash. Sixty-four of these ponds contain only fly ash; the remainder also contain bottom ash (212 ponds), FGD wastes (14 ponds), or both (108 ponds) [Schroeder, 2009].

More plants in the combined data set operate wet bottom ash handling systems than wet fly ash handling systems. Fewer wet fly ash systems are expected because the NSPS promulgated in 1982 prohibit the discharge of wastewater pollutants from fly ash transport water. Not surprisingly, EPA has found that the steam electric units generating wet fly ash transport water tend to be older units, while dry ash handling systems tend to be operated on newer units.

EPA identified several plants that have installed dry fly ash handling systems, either to replace the pre-existing wet handling system or to operate as a parallel system. The reasons for installing the dry handling systems include environmental remediation (i.e., discharges from the fly ash ponds caused environmental impacts), economic opportunity (e.g., revenues from sale of fly ash), and the need to replace ash ponds approaching full storage capacity. Because dry fly ash handling practices do not generate wastewater streams, converting to a dry system eliminates the discharge of fly ash transport water and the pollutants typically present in the wastewater (e.g., arsenic, mercury, and selenium). In addition, it reduces the amount of water used by the plant and eliminates the need for the fly ash pond.

Table 5-1. Fly Ash Handling Practices at Plants Included in EPA’s Combined Data Set

Fly Ash Handling	Number of Plants ^a	Number of Electric Generating Units ^b	Capacity ^c (MW)
Wet-Slucied	34 (35%)	95 (40%)	38,300 (33%)
Handled Dry or Removed in Scrubber	63 (65%)	128 (54%)	73,600 (63%)
Other – Most Ash Handled Dry or Unknown	7 (7%)	14 (6%)	4,950 (4%)
Total	97	237	117,000

Source: Combined Data Set (defined in Chapter 4).

a – Number of plants is not additive because some plants operate units with different types of fly ash handling practices.

b – The number of electric generating units in the table represents the number of boilers, not the number of turbines/generating units associated with fly ash handling systems. The number of boilers does not necessarily correspond to the same number of turbines.

c – Due to rounding, the total capacity may not equal the sum of the individual capacities. The capacities for the UWAG-provided data, data request information, and site visit and sampling information are based on information provided to EPA and may represent various capacities (e.g., nameplate capacity, net summer capacity, gross winter capacity, etc.).

5.2 Bottom Ash Handling Operations

As discussed previously, the combustion of coal produces heavy bottom ash particulates that are collected in the bottom of the boiler. In a typical boiler, the lower portion of the boiler slopes inward from the front and rear walls of the boiler, leaving a three- to four-foot opening that runs the width of the bottom of the boiler. These sloped walls and opening allow the bottom ash to feed by gravity to the bottom ash hoppers that are positioned below the boiler. The bottom ash hoppers are connected directly to the boiler bottom to prevent any boiler gases from leaving the boiler. The hoppers have sloped side walls as well, except the hoppers’ left and right walls slope downward, which allows the hoppers to have a single exit point. Depending on the size of the boiler, there may be more than one bottom ash hopper running along the opening of the bottom of the boiler. Most bottom ash hoppers are filled with water to quench the hot bottom ash as it enters the hopper [Babcock & Wilcox, 2005].

Once the bottom ash hoppers have filled with bottom ash, a gate at the bottom of the hopper opens and the ash is directed to grinders to reduce the bottom ash into smaller pieces. After the bottom ash hoppers below the boiler have been emptied, the gate at the bottom of the hoppers closes and the hoppers again fill with water. The bottom ash hoppers are typically sized to accommodate approximately eight hours of bottom ash generation; therefore, the bottom ash is sluiced about two to four times a day. The frequency of bottom ash sluicing depends upon the

hopper size and the operation of the boiler. The duration of the bottom ash sluicing depends upon the number and size of hoppers and the bottom ash transport water flow rate. From EPA's site visit experiences, the bottom ash sluicing duration is generally between 30 minutes to one hour for each unit [Babcock & Wilcox, 2005].

After the bottom ash has been ground, the ash is sluiced with water and pumped either to a pond or a dewatering bin. Some plants operate large settling ponds for bottom ash, while others use a system of relatively small ponds operating in series and/or parallel.

Because the bottom ash particles are heavier than the fly ash particles, they are more easily separated from the sluice water than the fly ash particles. A dewatering bin system is a tank-based settling operation that is used to separate the bottom ash solids from the transport water. A dewatering bin system generally consists of at least two bins because while one bin is receiving bottom ash, the other bin is decanting the water from the collected bottom ash material. The dewatering bins are cylindrical in shape and have a gate at the bottom of the bin for removing the bottom ash [Babcock & Wilcox, 2005].

The bottom ash transport water is fed to the center of the bin and contacts a bar screen classifier that allows the finer particulates to fall down to the center of the bin while the coarser particulates are forced to the outside walls of the bin. As the dewatering bins are receiving bottom ash, they fill with the bottom ash transport water. The particulates are contained at the bottom of the bin, while the water rises to the top of the bin. At the top of the bin, an underflow baffle prevents finer particulates from floating out of the bin with the overflow. Excess water in the bin flows over a serrated overflow weir and leaves the dewatering bin. This overflow water can either be reused directly as bottom ash transport water, sent to an ash pond for additional settling, or discharged directly to surface water [Babcock & Wilcox, 2005].

As the dewatering bin continues to receive bottom ash transport water, the bin eventually reaches its solids loading capacity, at which time the operator will direct the bottom ash transport water to another dewatering bin and will begin the decanting process in the first bin. As the water is being decanted, the coarser particulates at the outside of the bin act as a filter to prevent the finer particulates at the center of the bin from leaving the bin. After the water has been drained from the system, the gate at the bottom of the bin is opened and the bottom ash is removed, usually by loading trucks that drive under the bin structure [Babcock & Wilcox, 2005].

Most plants operate with a wet bottom ash handling system, as described above; however, some plants operate a dry bottom ash handling system. As seen in Table 5-2, 13 percent of the plants in EPA's combined data set handle at least a portion of their bottom ash dry. The dry bottom ash handling systems that EPA observed during the site visit program operated a drag chain system. In the drag chain system, the bottom ash is collected in a water bath trough at the bottom of the boiler to cool the ash. The plant operates a drag chain that moves along the bottom of the trough and drags the bottom ash out of the boiler. At the end of the trough, the drag chain reaches an incline, which dewateres the bottom ash by gravity, draining the water back to the trough as the ash moves upward. The bottom ash is often conveyed to a nearby collection area, such as a small bunker outside the boiler building, from which it is loaded onto trucks and either sold for beneficial use or stored on-site in a landfill.

Most of the plants in EPA's combined data set (88 percent; 85 plants) operate wet handling systems for bottom ash. EPA also reviewed the OSWER data recently collected for

waste management units at coal-fired power plants. The OSWER data identifies 211 plants operating a total of 417 surface impoundments containing bottom ash. Ninety-one of these ponds contain only bottom ash; the remainder also contain fly ash (212 ponds), FGD wastes (6 ponds), or both (108 ponds). The OSWER database likely does not identify plants using wet handling systems that employ dewatering bins, unless the decant from the bins is sent to a pond [Schroeder, 2009].

Table 5-2. Bottom Ash Handling Practices at Plants Included in EPA’s Combined Data Set

Bottom Ash Handling	Number of Plants ^a	Number of Electric Generating Units ^b	Capacity ^c (MW)
Wet-Sluiced	85 (88%)	214 (90%)	106,000 (91%)
Handled Dry	13 (13%)	22 (9%)	10,200 (9%)
Unknown	1 (1%)	2 (1%)	600 (<1%)
Total	97	238	117,000

Source: Combined Data Set (defined in Chapter 4).

a – Number of plants is not additive because some plants operate units with different types of bottom ash handling practices.

b – The number of electric generating units in the table represents the number of boilers, not the number of turbines/generating units associated with fly ash handling systems. The number of boilers does not necessarily correspond to the same number of turbines.

c – Due to rounding, the total capacity may not equal the sum of the individual capacities. The capacities for the UWAG-provided data, data request information, and site visit and sampling information are based on information provided to EPA and may represent various capacities (e.g., nameplate capacity, net summer capacity, gross winter capacity, etc.).

5.3 Ash Transport Water Characteristics

Fly ash transport water is one of the larger volume flows for coal-fired power plants. Table 5-3 presents the fly ash transport water flow rates reported in the data request responses. The flow rates that are normalized on a MW basis are based on the plant’s total coal-fired capacity. The average coal-fired capacity for the plants in the data set is 1,210 MW and the median coal-fired capacity per plant is 1,140 MW.

Sluice flow rates are not the same as pond overflow rates. Ash ponds typically receive other waste streams in addition to bottom ash and fly ash. Factors acting to reduce the pond overflow rate include pond losses from infiltration through the bottom of the pond or retaining dikes, evaporation, and whether the water held in the ash pond is recycled back to the plant for reuse. The average fly ash pond overflow flow rates collected during the development of the 1982 effluent guidelines are 2,610,000 gpd/plant and 3,810 gpd/MW [U.S. EPA, 1982].

Table 5-3. Fly Ash Transport Water Flow Rates

	Number of Plants	Average Flow Rate ^a	Median Flow Rate ^a	Range of Flow Rate ^a
Flow Rate per Plant				
gpm/plant ^b	17	5,890	3,000	188 - 27,500
gpd/plant ^d	17	7,640,000	4,030,000	270,000 - 39,600,000
gpy/plant ^d	17	2,710,000,000	1,470,000,000	6,480,000 - 14,500,000,000
Normalized Flow Rate based on Total Coal-Fired Capacity				
gpm/Coal-Fired MW ^{b, c}	17	4.59	4.08	0.291 - 9.38
gpd/Coal-Fired MW ^{c, d}	17	5,830	5,140	419 - 11,900
gpy/Coal-Fired MW ^{c, d}	17	2,090,000	1,870,000	2,050 - 4,350,000

Source: [U.S. EPA, 2008a].

a – The flow rates presented have been rounded to three significant figures.

b – The gpm flow rate represents the flow rate during the actual sluice.

c – For this analysis, EPA assumed that the total capacity for each coal-fired steam electric unit is associated with coal use. Non-coal-fired units are not included in the capacity calculations.

d – Because the fly ash transport water flow rate is not always continuous, the gpd cannot be directly calculated from the gpm. Similarly, some of the fly ash transport water flows are not generated 365 days per year, so gpy cannot be directly calculated from gpd.

As described in Section 5.2, bottom ash transport water is an intermittent stream from each of the coal-fired units. The bottom ash transport water flow rates are typically not as large as the fly ash transport water flow rates. However, bottom ash transport water is still one of the larger volume flows for steam electric plants.

Table 5-4 presents the bottom ash transport water flow rates reported in the data request responses. The flow rates that are normalized on a MW basis are based on the plants' total coal-fired capacity. The average coal-fired capacity per plant is 1,570 MW and the median coal-fired capacity per plant is 1,560 MW.

As was noted above, sluice flow rates are not the same as pond overflow rates. The average bottom ash pond overflow flow rates collected during the development of the 1982 effluent guidelines are 2,600,000 gpd/plant and 3,880 gpd/MW [U.S. EPA, 1982]. The bottom ash transport water flow rates presented in Table 5-4 may be lower than the bottom ash pond overflow flow rates collected during the 1982 effluent guideline development because the bottom ash pond overflow likely includes other plant wastewaters, in addition to bottom ash transport water.

Table 5-4. Bottom Ash Transport Water Flow Rates from EPA Data Request Responses

	Number of Plants ^a	Average Flow Rate ^b	Median Flow Rate ^b	Range of Flow Rate ^b
Flow Rate per Plant				
gpm/plant ^c	27	3,370	1,740	358 - 12,600
gpd/plant ^d	27	3,290,000	2,380,000	253,000 - 18,100,000
gpy/plant ^d	27	1,190,000,000	810,000,000	92,400,000 - 6,600,000,000
Normalized Flow Rate Based on Total Coal-Fired Capacity				
gpm/Coal-Fired MW ^{c, e}	27	2.21	1.18	0.479 - 9.38
gpd/Coal-Fired MW ^{d, e}	27	1,940	1,600	222 - 7,070
gpy/Coal-Fired MW ^{d, e}	27	701,000	585,000	81,100 - 2,580,000

Source: [U.S. EPA, 2008a].

a – Twenty-nine of the 30 data request plants reported generating bottom ash transport water; however, two plants are excluded from this summary because they were unable to estimate the bottom ash transport water flow rates.

b – The flow rates presented have been rounded to three significant figures.

c – The gpm flow rate represents the flow rate during the actual sluice.

d – Because the bottom ash transport water flow rate is not always continuous, the gpd cannot be directly calculated using only the gpm. Similarly, some of the bottom ash transport water flows are not generated 365 days per year, so gpy cannot be directly calculated from gpd.

e – For this summary, EPA assumed that the total capacity for each coal-fired steam electric unit is associated with coal use. Non-coal-fired units are not included in the capacity calculations.

The pollutant concentrations in ash transport water vary from plant to plant depending on the coal used, the type of boiler, and the particulate control system used by the plant. In addition, the waste stream characteristics also vary in a cyclical fashion during the discharges. For example, the fly ash transport water characteristics vary depending on which of the ash hoppers is being sluiced. The bottom ash transport water characteristics at the beginning of the intermittent sluicing period are likely to be different than the characteristics at the end of the sluice period. Table 5-5 presents the pollutant concentrations representing the influent to the ash pond systems sampled during EPA's sampling program.

Table 5-5. Ash Pond Influent Concentrations

Analyte	Method	Unit	Widows Creek – Diked Channel Influent to Combined Ash Pond ^{a, b}	Cardinal – Influent to Fly Ash Pond ^a
Routine Metals – Total				
Aluminum	200.7	µg/L	94,800	320,000
Antimony	200.7	µg/L	ND (38.0)	ND (81.2)
Arsenic	200.7	µg/L	131	1,520
Barium	200.7	µg/L	6,080	5,060
Beryllium	200.7	µg/L	11.3	71.5
Boron	200.7	µg/L	4,330	2,790
Cadmium	200.7	µg/L	ND (9.50)	39.6
Calcium	200.7	µg/L	103,000	204,000

Table 5-5. Ash Pond Influent Concentrations

Analyte	Method	Unit	Widows Creek – Diked Channel Influent to Combined Ash Pond ^{a, b}	Cardinal – Influent to Fly Ash Pond ^a
Chromium	200.7	µg/L	107	1,300
Cobalt	200.7	µg/L	ND (95.0)	381
Copper	200.7	µg/L	188	964
Iron	200.7	µg/L	80,700	298,000
Lead	200.7	µg/L	208	786
Magnesium	200.7	µg/L	25,700	35,100
Manganese	200.7	µg/L	337	1,120
Mercury	245.1	µg/L	2.66	2.31
Molybdenum	200.7	µg/L	65.5	333
Nickel	200.7	µg/L	ND (95.0)	739
Selenium	200.7	µg/L	27.5	ND (20.3)
Sodium	200.7	µg/L	31,200	69,900
Thallium	200.7	µg/L	ND (19.0)	ND (40.6)
Titanium	200.7	µg/L	7,150	24,900
Vanadium	200.7	µg/L	346	2,340
Yttrium	200.7	µg/L	133	521
Zinc	200.7	µg/L	785	1,220
Routine Metals – Dissolved				
Aluminum	200.7	µg/L	663	283
Antimony	200.7	µg/L	ND (20.0)	ND (20.0)
Arsenic	200.7	µg/L	46.0	86.8
Barium	200.7	µg/L	178	164
Beryllium	200.7	µg/L	ND (5.00)	ND (5.00)
Boron	200.7	µg/L	2,150	1,380
Cadmium	200.7	µg/L	ND (5.00)	ND (5.00)
Calcium	200.7	µg/L	40,300	94,800
Chromium	200.7	µg/L	ND (10.0)	ND (10.0)
Hexavalent Chromium	D1687-92	µg/L	ND (2.00)	5.00
Cobalt	200.7	µg/L	ND (50.0)	ND (50.0)
Copper	200.7	µg/L	ND (10.0)	ND (10.0)
Iron	200.7	µg/L	ND (100)	ND (100)
Lead	200.7	µg/L	ND (50.0)	ND (50.0)
Magnesium	200.7	µg/L	7,110	15,200
Manganese	200.7	µg/L	ND (15.0)	40.3
Mercury	245.1	µg/L	ND (0.200)	ND (0.200)
Molybdenum	200.7	µg/L	50.1	243
Nickel	200.7	µg/L	ND (50.0)	ND (50.0)
Selenium	200.7	µg/L	26.8	16.6
Sodium	200.7	µg/L	13,400	64,400

Table 5-5. Ash Pond Influent Concentrations

Analyte	Method	Unit	Widows Creek – Diked Channel Influent to Combined Ash Pond ^{a, b}	Cardinal – Influent to Fly Ash Pond ^a
Thallium	200.7	µg/L	ND (10.0)	ND (10.0)
Titanium	200.7	µg/L	ND (10.0)	ND (10.0)
Vanadium	200.7	µg/L	66.8	70.7
Yttrium	200.7	µg/L	ND (5.00)	ND (5.00)
Zinc	200.7	µg/L	ND (10.0)	ND (10.0)
Low-Level Metals – Total				
Antimony	1638	µg/L	13.1 L	33.1
Arsenic	1638	µg/L	88.9	519
Cadmium	1638	µg/L	ND (20.0)	9.51
Chromium	1638	µg/L	ND (160)	569
Copper	1638	µg/L	114	719
Lead	1638	µg/L	104	260
Mercury	1631E	µg/L	1.02	1.16
Nickel	1638	µg/L	ND (200)	291
Selenium	1638	µg/L	ND (200)	ND (200)
Thallium	1638	µg/L	ND (4.00)	43.6
Zinc	1638	µg/L	198	720
Low-Level Metals – Dissolved				
Antimony	1638	µg/L	8.54	17.4
Arsenic	1638	µg/L	49.5	80.7
Cadmium	1638	µg/L	ND (2.00)	ND (1.00)
Chromium	1638	µg/L	ND (16.0)	ND (80.0)
Hexavalent Chromium	1636	µg/L	NA	NA
Copper	1638	µg/L	ND (4.00)	ND (20.0)
Lead	1638	µg/L	ND (1.00)	ND (0.500)
Mercury	1631E	µg/L	ND (0.000500)	0.000550
Nickel	1638	µg/L	ND (20.0)	ND (100)
Selenium	1638	µg/L	ND (100)	21.2
Thallium	1638	µg/L	ND (0.400)	3.10
Zinc	1638	µg/L	ND (10.0)	ND (50.0)
Classicals				
Ammonia As Nitrogen (NH ₃ -N)	4500-NH3F	mg/L	0.400	0.170
Nitrate/Nitrite (NO ₃ -N + NO ₂ -N)	353.2	mg/L	0.360	2.65
Total Kjeldahl Nitrogen (TKN)	4500-N,C	mg/L	7.41	1.01
Biochemical Oxygen Demand (BOD)	5210B	mg/L	53.0	ND (2.00)
Chloride	4500-CL-C	mg/L	21.4	56.8

Table 5-5. Ash Pond Influent Concentrations

Analyte	Method	Unit	Widows Creek – Diked Channel Influent to Combined Ash Pond ^{a, b}	Cardinal – Influent to Fly Ash Pond ^a
Hexane Extractable Material (HEM)	1664A	mg/L	ND (5.00)	7.00
Silica Gel Treated HEM (SGT-HEM)	1664A	mg/L	NA	6.00
Sulfate	D516-90	mg/L	58.1	1,110
Total Dissolved Solids (TDS)	2540 C	mg/L	224	662
Total Phosphorus	365.3	mg/L	16.6	4.03
Total Suspended Solids (TSS)	2540 D	mg/L	9,190 E	23,400

Source: [ERG, 2008k; ERG, 2008o].

Note: EPA used several analytical methods to analyze for metals during the sampling program. For the purposes of sampling program, EPA designated some of the analytical methods as “routine” and some of them as “low-level.” EPA designated all of the methods that require the use of clean hands/dirty hands sample collection techniques (i.e., EPA Method 1669 sample collection techniques) as “low-level” methods. Although not required by the analytical methods, EPA used clean hands/dirty hands collection techniques for all low-level and routine metals samples.

a – The concentrations presented have been rounded to three significant figures.

b – The sample collected from the diked channel influent to the combined ash pond represents only the wastewaters associated with six of the eight generating units. The wastewaters for the other two units enter the combined ash pond at a different point.

E – Sample analyzed outside holding time.

L – Sample result between 5x and 10x blank result.

NA – Not analyzed.

ND – Not detected (number in parenthesis is the report limit). The sampling episode reports for each of the individual plants contains additional sampling information, including analytical results for analytes measured above the detection limit, but below the reporting limit (i.e., J-values).

For the Widows Creek sampling episode, EPA collected a 12-hour composite sample of the influent to the ash pond from a diked channel containing fly ash transport water, bottom ash transport water, and several low-volume wastewaters, including coal pile runoff overflow, boiler blowdown, nonchemical metal cleaning wastewater, roof and switchyard drainage, flow wash water, and miscellaneous cooling water. Due to the very high flow rates and solids loading of the influent stream and the challenge of safely collecting a representative sample, EPA collected the samples from the diked channel at a point downstream of the influent to the channel to allow for some initial solids settling, but upstream of the open water area of the ash pond. The wastewater contained within the diked channel represents the wastewater generated from six of the eight units at the plant, which represents approximately 42 percent of the plant’s generating capacity. The other two units also generate wastewaters that enter the ash pond; however, the wastewaters enter the pond at a different location. Plant personnel estimated that the flow rate entering the ash pond at the time of sampling for the six units was approximately 12.1 mgd. The sampling episode report for Widows Creek contains more detailed information regarding the sample collection procedures [ERG, 2008o].

For the Cardinal sampling episode, EPA collected a three-hour composite sample of the influent to the fly ash pond. The influent to the fly ash pond consisted of fly ash transport water and some dilution water (approximately one-third of the total influent flow). Due to the very high flow rates and solids loading of the influent stream and the challenge of safely collecting a

representative sample, EPA collected the sample near the influent point but was not able to sample the influent stream directly from the ash sluice pipes. The fly ash is collected by ESPs at the plant and sluiced to the fly ash pond. During the sampling episode, the plant personnel estimated the influent flow rate to the fly ash pond was 9.1 mgd. The sampling episode report for Cardinal contains more detailed information regarding the sample collection procedures [ERG, 2008k].

Table 5-5 shows that the ash transport water streams contain significant concentrations of TSS and metals. The ash transport water metals concentrations are typically lower than those of the FGD wastewater (see Table 4-5 and Table 4-6), but the TSS concentration is higher. Many of the metals in the ash transport water stream are primarily present in the particulate phase. The TSS and metals concentrations present in the ash transport water are large enough that the waste stream typically requires some form of treatment prior to being discharged, at a minimum to lower the TSS concentrations to meet the 30 mg/L (30-day average) effluent guidelines limit for fly ash and bottom ash transport water (see Section 3.2.3 for more details).

5.4 Ash Transport Water Treatment Systems

Fly ash transport water and bottom ash transport water are typically treated in large settling pond systems. For plants operating both wet fly ash and wet bottom ash handling systems, the two sluice streams are often commingled within the same settling pond system along with other waste streams. For plants operating only one wet ash handling system (e.g., fly or bottom ash, but typically wet bottom ash), the ash transport water may be treated in an ash pond, which would likely receive other plant wastewaters. The design and operation of ash settling ponds is comparable to that of FGD settling ponds, which is described in Section 4.4.1.

Ash ponds are designed to remove particulates from wastewater by means of gravity. For this to occur, the wastewater must reside in the pond long enough for removal of the desired particle size. The ponds provide residence time for the fly ash, bottom ash, and other solids (e.g., FGD solids) to settle out of the wastewater to the bottom of the pond. Ash ponds can be an effective way to reduce TSS in ash transport water, particularly from bottom ash transport water, which contains relatively dense ash particles. Because ash ponds remove solid particulates, they may also be an effective means of removing some metals from fly ash transport water when these metals are present in particulate form.

Surface impoundments (i.e., ash ponds and FGD ponds) can vary substantially in size, capacity, and age. According to a survey conducted by EPRI, pond surface areas ranged from 5 acres to 1,500 acres, with a median of 91 acres. Disposal capacities ranged from 100,000 cubic yards to 63 million cubic yards, with a median of 3.4 million cubic yards. The ponds in the survey had been in operation for less than two years to nearly 50 years, with a median of 22 years of operation. Some ponds were projected to continue operating beyond 2045 [EPRI, 1997a].

During the summer, some ash ponds become thermally stratified. When this occurs, the top layer of the pond is warmer and contains higher levels of dissolved oxygen, whereas the bottom layer of the pond is colder and has significantly lower levels of oxygen, often being anoxic. Typically during fall, as the air temperature decreases, the upper layer of the pond becomes cooler and more dense, then sinks and causes the entire volume of the ash pond to circulate. Solids that have settled at the bottom of the pond could potentially become

resuspended due to the mixing, increasing the concentrations of pollutants being discharged during the turnover period. In addition, anaerobic conditions at the bottom of the pond may be conducive to the formation of methylmercury, which could then be present in the discharge. Seasonal turnover effects largely depend upon the size and configuration of the ash pond. Smaller, and especially shallow, ponds likely do not experience turnover because they do not have physical characteristics that promote thermal stratification. However, some power plant settling ponds are large (e.g., greater than 300 acres) and deep (e.g., greater than 10 meters deep) and likely experience some degree of turnover [MDC, 2004; Heidorn, 2005].

Table 5-6 shows that 95 percent of the plants in the combined data set that handle any amount of fly ash wet send the fly ash transport water to settling ponds. Sixty-five percent of the fly ash ponds from the combined data set receive both fly ash and bottom ash. Only one of the fly ash ponds included in the combined data set is completely segregated (i.e., it receives only fly ash wastewater).

Table 5-6. Fly Ash Transport Wastewater Treatment Systems at Plants Included in EPA’s Combined Data Set

Type of Fly Ash Wastewater Treatment System	Number of Plants	Number of Electric Generating Units ^a	Capacity (MW) ^b	Number of Treatment Systems That Also Receive FGD Wastewater
Settling pond, fly ash commingled with bottom ash	22 (58%)	74 (68%)	25,300 (59%)	4
Settling pond, fly ash NOT commingled with bottom ash	4 (11%)	9 (8%)	7,240 (17%)	1
Settling pond, not known if fly ash is commingled with bottom ash	10 (26%)	24 (22%)	9,690 (23%)	2
Other (trucked away, no wastewater discharge)	2 (5%)	2 (2%)	747 (2%)	0
Total	38	109	43,000	7

Source: Combined Data Set (defined in Chapter 4).

a – The number of electric generating units in the table represents the number of boilers, not the number of turbines/generating units associated with fly ash handling systems. The number of boilers does not necessarily correspond to the same number of turbines.

b – Due to rounding, the total capacity may not equal the sum of the individual capacities. The capacities for the UWAG-provided data, data request information, and site visit and sampling information are based on information provided to EPA and may represent various capacities (e.g., nameplate capacity, net summer capacity, gross winter capacity).

The plants within EPA’s combined data set that operate wet bottom ash handling systems send their bottom ash transport water to dewatering bins, settling ponds, or both. EPA has observed that most bottom ash settling ponds also receive other plant wastewaters. In response to the data request, no plants reported operating segregated bottom ash ponds. Table 5-7 shows that 90 percent of the plants in the combined data set that handle the bottom ash with a wet system transfer the bottom ash transport water to a settling pond for treatment. Only 18 percent of the plants are operating dewatering bins prior to the settling pond. As shown in Table 5-7, there are more plants that keep their bottom ash transport and fly ash transport waters segregated than not.

Table 5-7. Bottom Ash Transport Wastewater Treatment Systems at Plants Included in EPA's Combined Data Set

Type of Bottom Ash Wastewater Treatment System	Number of Plants	Number of Electric Generating Units	Capacity (MW)	Number of Treatment Systems That Also Receive FGD Wastewater
Dewatering bins, NOT sent to settling pond (not known if commingled with fly ash)	8	18	11,100	0
Dewatering bins, overflow to settling pond (comingled with fly ash)	2	6	3,300	1
Dewatering bins, overflow to settling pond (not comingled with fly ash)	14	28	17,200	3
Dewatering bins, overflow to settling pond (not known if commingled with fly ash)	1	1	176	1
Settling pond (comingled with fly ash)	23	73	25,200	11
Settling pond (not commingled with fly ash)	37	78	44,700	10
Settling pond (not known if commingled with fly ash)	7	14	5,270	2
Unknown	1	2	596	0
Total	93	220	108,000	28

Source: Combined Data Set (defined in Chapter 4).

a – The number of electric generating units in the table represents the number of boilers, not the number of turbines/generating units associated with fly ash handling systems. The number of boilers does not necessarily correspond to the same number of turbines.

b – Due to rounding, the total capacity may not equal the sum of the individual capacities. The capacities for the UWAG-provided data, data request information, and site visit and sampling information are based on information provided to EPA and may represent various capacities (e.g., nameplate capacity, net summer capacity, gross winter capacity).

For all of the fly and bottom ash ponds reported in response to the data request, waste streams other than ash transport water ranged from 3 to 93 percent of the total pond influent flow (in 2006). The major types of influent, other than ash transport water, were cooling tower blowdown, FGD wastewater, and various types of low-volume wastes [U.S. EPA, 2008a]. Other types of wastewater that may be transferred to ash ponds include coal pile runoff, transport water containing mill rejects (which may be pyritic), or coal washing operations (if washed on site). Because these wastewaters are in direct contact with the coal, they often have low pH (i.e., they are acidic wastewaters). According to information that EPRI collected during its PISCES program, coal pile runoff can have a pH as low as 1.5 S.U. EPRI determined when that metals entering an ash pond from the fly ash and/or bottom ash transport water come in contact with an acidic waste stream, such as coal pile runoff, more of the metals will become dissolved. Therefore, because ash ponds are not designed to treat for dissolved metals, the introduction of acidic waste streams to an ash pond can result in an increase in the metals concentration at the effluent of the ash pond [EPRI, 1997b].

From the 2005 EIA data, EPA identified 130 steam electric plants that dispose of their fly ash in a surface impoundment (i.e., ash pond). EPA also identified that 156 steam electric plants dispose of their bottom ash in an ash pond. EPA determined that a total of 186 plants dispose of either their fly ash or bottom ash in a pond. Additionally, EPA determined that all of the 186

plants burn coal in at least one of the electric generating units at the plant. Within the EIA data set, 100 of the 488 coal-fired steam electric plants did not report any information regarding the disposal of the fly ash and bottom ash; therefore, from the EIA data, EPA identified that at least 186 of the 488 coal-fired plants dispose of fly or bottom ash in a pond.

Table 5-8 presents a summary of data recently collected by EPA's OSWER, which sent letters to power plants requiring that they report certain information about waste management units used for the storage or disposal of coal combustion residues. The OSWER data includes information for 214 plants in 35 states operating a total of 537 ponds containing coal combustion residues (i.e., fly ash, bottom ash, boiler slag, or FGD solids)²⁵. All but one of these plants operates at least one ash pond, with a total nationwide population of 213 plants operating 495 ash ponds. Table 5-8 presents summary statistics that identify the type of coal combustion residues contained in ash ponds, most of which also receive other power plant wastewaters. For completeness, the table also includes information OSWER collected for ponds that receive FGD wastes [Schroeder, 2009].

Table 5-8. Ponds Containing Coal Combustion Residues

Type of CCR Contained in Pond	Number of CCR Ponds
Fly ash and bottom ash	212
Fly ash, bottom ash, and FGD	108
Fly ash only	64
Bottom ash only	91
FGD only	42
Fly ash and FGD	14
Bottom ash and FGD	6
Total	537

Source: [Schroeder, 2009].

As shown in Table 5-6 and Table 5-7, some plants combine the FGD wastewater in ash ponds. EPRI conducted settling tests to determine whether transferring FGD wastewater to an ash pond presents any issues with the settling pond treatment. EPRI determined that when the FGD wastewater was mixed with the more dilute ash pond water, the gypsum particles in the water dissolved and became smaller, which caused the solids to settle slower. EPRI determined that this mixing reduces the settling efficiency in the ash pond and therefore, may result in an increase in the effluent TSS concentration from the ash pond [EPRI, 2006b]. Additionally, EPRI reported that the FGD wastewater includes high loadings of volatile metals which can impact the solubility of metals in the ash pond, thereby potentially leading to increases in the effluent metal concentrations from the ash pond [EPRI, 2006b]. According to the OSWER data, 61 power plants operate a total of 128 ponds that combine FGD wastes with fly ash and/or bottom ash wastes.

²⁵ The OSWER database also includes information for another 47 ponds which reportedly contain no coal combustion residues. However, a review of the wastes contained in these additional ponds or the names given these ponds suggests that some of these ponds may also contain CCRs. Some of the non-CCR ponds are located at five plants included in the OSWER database, which reportedly do not operate any ponds containing CCR.

The design, operation, and maintenance of ash ponds in the steam electric industry vary by plant/company. As described above, the ash ponds are designed for TSS removal; therefore, the size of the pond is dependent on the flow rate of the influent waste streams, as well as the settling properties of the solids in the waste stream. The amount of land available to the plant is another factor that may determine the size of the ash pond. Ash ponds may be lined with clay or geosynthetic liners, but many ash ponds are unlined. From EPA's site visit program, EPA determined that relatively new ash ponds may have some type of liner, but older ponds are more likely to be unlined. EPA was unable to identify a comprehensive source of data quantifying the number of lined and unlined ash ponds.

Some plants may add chemicals to the ash ponds to control the pH of the ash pond effluent discharge. The current effluent guidelines pH limit for discharges from steam electric plants is the range of 6.0 to 9.0 S.U. Common chemicals used to control the pH in ash ponds are sodium hydroxide and hydrochloric acid. Other plants, such as Widows Creek, inject CO₂ into the pond, which becomes carbonic acid in the aqueous phase and therefore reduces the alkalinity of the pond [ERG, 2007h]. Some plants may operate additional treatment systems to control the ash pond discharges. For example, Kentucky Utilities' Ghent Generating Station operates a filtration system that treats approximately 50 percent of the ash pond overflow prior to commingling it with the other 50 percent of the ash pond overflow and discharging it [ERG, 2009g]. Polymers may also be added to the ash pond to promote coagulation/flocculation to enhance settling of the solids [ERG, 2009r].

During the site visit program, EPA observed varying ways of maintaining the ash ponds. Some plants constantly remove settled ash solids from the ash pond delta and stack them on the sides of the pond to dewater and build up the height of the pond. Alternatively, some plants periodically dredge the pond to remove the ash from the bottom of the pond and transfer the solids off site for disposal or to an on-site landfill, or use the solids to build up the height of the ash pond. Finally, some plants may not dredge the ash pond at all. These plants leave the ash in the pond permanently and, when the ash pond reaches its capacity, a new ash pond is built and the old pond is decommissioned.

Table 5-9 presents the pollutant concentrations representing the effluent from ash ponds collected during EPA's sampling program. Each of these pond systems treats different types of wastewater; therefore, the various effluents cannot be directly compared with each other. In addition, the influent concentrations presented in Table 5-5 for Widows Creek should not be directly compared with the effluent concentrations in Table 5-9 because the influent represents only a portion of the waste streams entering the pond system. Table 5-9 shows that the treated ash pond effluent wastewaters contain low concentrations of TSS and most nutrients; however, metals are still present in the pond effluent. Table 5-9 also shows that most of the metals present in the treated ash pond wastewater are predominantly in the dissolved phase.

Homer City operates a dry fly ash handling system and a wet bottom ash handling system. The bottom ash transport water from Homer City is first transferred to dewatering bins, which remove approximately 90 to 95 percent of the solids from the wastewater. The overflow from the dewatering bins is transferred to the two bottom ash ponds operating in parallel. The overflow from the bottom ash ponds is transferred to a clearwell and then discharged or reused to sluice more bottom ash. EPA collected a grab sample of the effluent from the bottom ash treatment system at Homer City directly from the clearwell. The average flow rate discharged

from the clearwell during the sampling episode was 0.453 mgd. The sampling episode report for Homer City contains more detailed information regarding the sample collection procedures [ERG, 2008l].

Widows Creek operates a combined fly ash and bottom ash pond system. The fly ash from seven of the eight units (one unit uses the FGD system for particulate control, which sends the wastewater to a separate FGD settling pond system) and bottom ash from all eight units, as well as several other low-volume wastewaters enter the combined ash pond. The wastewater enters the ash pond at two different areas, then flows by gravity through diked channels made of ash until it reaches the open water portion of the main pond. The overflow from the main ash pond flows to a second pond where the plant injects carbon dioxide, if needed, to decrease the pH of the wastewater to within the range of 6.0 to 9.0 S.U. The overflow from the second pond enters the pumping basin, where the treated wastewater is pumped to a stub canal off the river where the plant draws intake water from the river. Alternatively, if the pumping basin begins to overflow, then the plant has an emergency overflow discharge directly to surface water. EPA collected a grab sample of the effluent from the combined ash pond directly from the pumping basin. EPA estimated that the average flow rate discharged from the pumping basin during the sampling episode was 29.9 mgd. The sampling episode report for Widows Creek contains more detailed information regarding the sample collection procedures [ERG, 2008o].

Mitchell operates a fly ash pond treatment system. The fly ash pond receives the fly ash transport water from Mitchell, fly ash transport water from a neighboring power plant, wastewater from a coal washing preparation plant, treated acid mine drainage wastewater, and stormwater runoff. The waste streams enter the fly ash pond at various locations within the pond and flow to the dam located at the end of the pond. The dam controls the flow from the pond into a channel that discharges to surface water. EPA collected a grab sample of the fly ash pond effluent from the channel discharging to the surface water. The average flow rate discharged from the fly ash pond during the sampling episode was 7.8 mgd. The sampling episode report for Mitchell contains more detailed information regarding the sample collection procedures [ERG, 2008m].

Table 5-9. Ash Pond Effluent Concentrations

Analyte	Method	Unit	Homer City – Effluent from Bottom Ash Pond ^a	Widows Creek – Effluent from Combined Ash Pond ^a	Mitchell – Effluent from Fly Ash Pond ^a	Cardinal – Effluent from Fly Ash Pond ^{a, b}
Routine Metals - Total						
Aluminum	200.7	µg/L	323	1,070	404	344
Antimony	200.7	µg/L	ND (20.0)	ND (20.0)	24.6	21.2
Arsenic	200.7	µg/L	ND (10.0)	38.2	150	77.6
Barium	200.7	µg/L	101	227	133	165
Beryllium	200.7	µg/L	ND (5.00)	ND (5.00)	ND (5.00)	ND (5.00)
Boron	200.7	µg/L	396	2,210	2,350	1,100
Cadmium	200.7	µg/L	ND (5.00)	ND (5.00)	ND (5.00)	ND (5.00)
Calcium	200.7	µg/L	186,000	58,500	115,000	88,400
Chromium	200.7	µg/L	ND (10.0)	13.5	15.9	ND (10.0)
Cobalt	200.7	µg/L	ND (50.0)	ND (50.0)	ND (50.0)	ND (50.0)
Copper	200.7	µg/L	ND (10.0)	ND (10.0)	ND (10.0)	ND (10.0)
Iron	200.7	µg/L	355	144	ND (100)	ND (100)
Lead	200.7	µg/L	ND (50.0)	ND (50.0)	ND (50.0)	ND (50.0)
Magnesium	200.7	µg/L	31,800	6,680	21,000	17,900
Manganese	200.7	µg/L	128	ND (15.0)	ND (15.0)	64.7
Mercury	245.1	µg/L	ND (0.200)	ND (0.200)	ND (0.200)	ND (0.200)
Molybdenum	200.7	µg/L	19.7	143	359	361
Nickel	200.7	µg/L	ND (50.0)	ND (50.0)	ND (50.0)	ND (50.0)
Selenium	200.7	µg/L	6.02	16.2	177	44.5
Sodium	200.7	µg/L	106,000	21,300	526,000	70,800
Thallium	200.7	µg/L	ND (10.0)	ND (10.0)	ND (10.0)	ND (10.0)
Titanium	200.7	µg/L	ND (10.0)	14.5	ND (10.0)	12.6
Vanadium	200.7	µg/L	ND (20.0)	68.5	110	104
Yttrium	200.7	µg/L	ND (5.00)	ND (5.00)	ND (5.00)	ND (5.00)
Zinc	200.7	µg/L	21.6	ND (10.0)	ND (10.0)	ND (10.0)

Table 5-9. Ash Pond Effluent Concentrations

Analyte	Method	Unit	Homer City – Effluent from Bottom Ash Pond ^a	Widows Creek – Effluent from Combined Ash Pond ^a	Mitchell – Effluent from Fly Ash Pond ^a	Cardinal – Effluent from Fly Ash Pond ^{a, b}
Routine Metals - Dissolved						
Aluminum	200.7	µg/L	231	357	241	130 L
Antimony	200.7	µg/L	ND (20.0)	ND (20.0)	23.9	20.9
Arsenic	200.7	µg/L	ND (10.0)	30.1	138	74.6
Barium	200.7	µg/L	106	206	128	157
Beryllium	200.7	µg/L	ND (5.00)	ND (5.00)	ND (5.00)	ND (5.00)
Boron	200.7	µg/L	397	2,200	2,290	1,090
Cadmium	200.7	µg/L	ND (5.00)	ND (5.00)	ND (5.00)	ND (5.00)
Calcium	200.7	µg/L	192,000	55,400	113,000	87,200
Chromium	200.7	µg/L	ND (10.0)	11.9	14.1	ND (10.0)
Hexavalent Chromium	D1687-92	µg/L	ND (2.00)	12.0	7.00	<3.50
Cobalt	200.7	µg/L	ND (50.0)	ND (50.0)	ND (50.0)	ND (50.0)
Copper	200.7	µg/L	ND (10.0)	ND (10.0)	ND (10.0)	ND (10.0)
Iron	200.7	µg/L	106	ND (100)	ND (100)	ND (100)
Lead	200.7	µg/L	ND (50.0)	ND (50.0)	ND (50.0)	ND (50.0)
Magnesium	200.7	µg/L	32,600	6,430	20,300	17,700
Manganese	200.7	µg/L	129	ND (15.0)	ND (15.0)	42.9
Mercury	245.1	µg/L	ND (0.200)	ND (0.200)	ND (0.200)	ND (0.200)
Molybdenum	200.7	µg/L	20.2	136	330	352
Nickel	200.7	µg/L	ND (50.0)	ND (50.0)	ND (50.0)	ND (50.0)
Selenium	200.7	µg/L	6.10 L	15.3	162	43.8
Sodium	200.7	µg/L	106,000	20,000	514,000	70,300
Thallium	200.7	µg/L	ND (10.0)	ND (10.0)	ND (10.0)	ND (10.0)
Titanium	200.7	µg/L	ND (10.0)	ND (10.0)	ND (10.0)	ND (10.0)
Vanadium	200.7	µg/L	ND (20.0)	64.7	108	99.9
Yttrium	200.7	µg/L	ND (5.00)	ND (5.00)	ND (5.00)	ND (5.00)
Zinc	200.7	µg/L	35.2	ND (10.0)	ND (10.0)	ND (10.0)

Table 5-9. Ash Pond Effluent Concentrations

Analyte	Method	Unit	Homer City – Effluent from Bottom Ash Pond ^a	Widows Creek – Effluent from Combined Ash Pond ^a	Mitchell – Effluent from Fly Ash Pond ^a	Cardinal – Effluent from Fly Ash Pond ^{a, b}
Low-Level Metals - Total						
Antimony	1638	µg/L	1.09	4.39	25.8	21.9
Arsenic	1638	µg/L	6.52	34.9	142	69.8
Cadmium	1638	µg/L	ND (0.500)	ND (0.500)	1.32	1.14
Chromium	1638	µg/L	ND (4.00)	13.5 L	20.4	4.64 L
Copper	1638	µg/L	2.37	1.49	5.47	2.98
Lead	1638	µg/L	ND (0.250)	0.490	0.580	0.420
Mercury	1631E	µg/L	0.00511	0.00157	0.00212	0.00125
Nickel	1638	µg/L	10.7	ND (5.00)	11.0	10.7
Selenium	1638	µg/L	5.74	17.1	191	45.8
Thallium	1638	µg/L	1.32	1.46	1.72	2.84
Zinc	1638	µg/L	24.2	ND (2.50)	10.1	5.98
Low-Level Metals - Dissolved						
Antimony	1638	µg/L	0.990	4.45	22.5	22.4
Arsenic	1638	µg/L	5.00	29.0	131	68.9
Cadmium	1638	µg/L	ND (0.500)	ND (0.500)	1.17	1.11
Chromium	1638	µg/L	ND (4.00)	12.6 L	16.0	4.49 L
Hexavalent Chromium	1636	µg/L	3.01	14.7	17.4	3.96
Copper	1638	µg/L	2.08	ND (1.00)	4.54	2.27
Lead	1638	µg/L	ND (0.250)	ND (0.250)	ND (0.250)	ND (0.250)
Mercury	1631E	µg/L	0.00141	ND (0.000500)	ND (0.000500)	ND (0.000500)
Nickel	1638	µg/L	10.4	ND (5.00)	9.57	10.6
Selenium	1638	µg/L	5.16	15.6	161	45.0
Thallium	1638	µg/L	1.31	1.49	1.42	2.87
Zinc	1638	µg/L	15.0	ND (2.50)	9.51	4.15

Table 5-9. Ash Pond Effluent Concentrations

Analyte	Method	Unit	Homer City – Effluent from Bottom Ash Pond ^a	Widows Creek – Effluent from Combined Ash Pond ^a	Mitchell – Effluent from Fly Ash Pond ^a	Cardinal – Effluent from Fly Ash Pond ^{a, b}
Classicals						
Ammonia As Nitrogen (NH ₃ -N)	4500-NH ₃ F	mg/L	0.340	0.160	0.150	0.205
Nitrate/Nitrite (NO ₃ -N + NO ₂ -N)	353.2	mg/L	37.0	0.230	0.730	4.73 E
Total Kjeldahl Nitrogen (TKN)	4500-N ₃ C	mg/L	1.36	3.39	ND (0.100)	<0.785 L
Biochemical Oxygen Demand (BOD)	5210B	mg/L	ND (2.00)	4.00	2.00	ND (2.00)
Chloride	4500-CL-C	mg/L	90.0	20.0	240	60.0
Hexane Extractable Material (HEM)	1664A	mg/L	ND (5.00)	6.00	ND (5.00)	10.0
Silica Gel Treated HEM (SGT-HEM)	1664A	mg/L	NA	ND (5.00)	NA	ND (4.00)
Sulfate	D516-90	mg/L	1,290	80.7	1,110	494
Total Dissolved Solids (TDS)	2540 C	mg/L	1,250	281	2,050	673
Total Phosphorus	365.3	mg/L	1.09	0.250 E	0.200	0.0870
Total Suspended Solids (TSS)	2540 D	mg/L	5.00	12.0 E	15.0	6.00

Source: [ERG, 2008l; ERG, 2008m; ERG, 2008k; ERG, 2008o].

Note: EPA used several analytical methods to analyze for metals during the sampling program. For the purposes of sampling program, EPA designated some of the analytical methods as “routine” and some of them as “low-level.” EPA designated all of the methods that require the use of clean hands/dirty hands sample collection techniques (i.e., EPA Method 1669 sample collection techniques) as “low-level” methods. Note that although not required by the analytical method, EPA used clean hands/dirty hands collection techniques for all low-level and routine metals samples.

a – The concentrations presented have been rounded to three significant figures.

b – The ash pond effluent results represent the average of the ash pond effluent and the duplicate of the ash pond effluent analytical measurements.

< – Average result includes at least one non-detect value. (Calculation uses the report limit for non-detected results).

E – Sample analyzed outside holding time.

L – Sample result between 5x and 10x blank result.

NA – Not analyzed.

ND – Not detected (number in parenthesis is the report limit). The sampling episode reports for each of the individual plants contains additional sampling information, including analytical results for analytes measured above the detection limit, but below the reporting limit (i.e., J-values).

Cardinal operates a fly ash pond treatment system. The fly ash pond receives fly ash transport water and occasionally some dilution water. The ash transport water and dilution water enter at the same point in the pond and flow to the dam located at the opposite end of the pond. The dam controls the flow from the pond into a channel that discharges to surface water. EPA collected a grab sample of the fly ash pond effluent from the channel discharging to the surface water. The average flow rate discharged from the fly ash pond during the sampling episode was 7.8 mgd. The sampling episode report for Cardinal contains more detailed information regarding the sample collection procedures [ERG, 2008k].

If the fly ash and/or bottom ash transport water is treated in an ash pond, then the overflow from these systems can be reused as sluice water or recycled elsewhere within the plant. During the site visit program, EPA visited two plants that operate combined ash ponds receiving both fly ash and bottom ash transport water that are completely reusing the overflow from the ash pond as the bottom ash and fly ash transport waters with no discharge. One of these plants is highlighted in Case Study IV.

Additionally, EPA visited two plants with segregated bottom ash handling systems and these plants reused the bottom ash pond overflow as the bottom ash transport waters; however, these plants do discharge some of the overflow from the bottom ash pond. These plants only discharged the bottom ash overflow if the water began accumulating in the system and needed to be discharged to manage the volume of water in the system. One of these plants is highlighted in Case Study V.

Some plants achieve partial recycle from ash ponds. For example, from information obtained through the data request, EPA estimates that Georgia Power's Bowen plant is recycling approximately 85 percent of the water from its ash pond. This ash pond receives and recycles several types of wastewaters including bottom ash and fly ash transport water.

**Case Study IV: Coal-Fired Power Plant Water Reuse
Fly Ash and Bottom Ash Transport Water Reuse
Western Kentucky Energy’s Kenneth C. Coleman Station**

The Facility

Number of coal-fired units:	3 (485 total MW capacity for all three units)
Coal used:	Eastern bituminous
Bottom ash handling:	Wet
Fly ash handling:	Wet
Ash treatment system:	Ash ponds (no discharge)

The Ash Handling and Treatment System

Bottom ash transport water and fly ash transport water are pumped to Ash Pond A, which was built in 1980 and has a discharge point (Outfall 002), but the plant does not typically discharge from the pond. Ash pond A also receives the effluent from the coal pile runoff pond and stormwater collected in Ash Pond C (the old pond, which is now closed). Coleman also has a new ash pond (Ash Pond D), which receives the dredged ash solids from Ash Pond A and the gypsum solids from the FGD process. All of the ponds at the plant have clay liners.

The ash transport water collected in Ash Pond A is treated by the pond and then reused as fly ash and bottom ash transport water by the plant. The plant operates the system with a complete recirculation and does not discharge from the ash pond system, even though the plant has a permitted outfall that allows it to discharge.

Water is removed from the ash system through evaporation from the ponds and evaporation of bottom ash quench water in the boiler. There may also be some loss to infiltration if water is able to pass through the clay liner of the pond. The plant monitors the levels of the ponds closely and adjusts the make-up water to the sluicing system to control the level of the ponds. During the rainy season, the plant keeps the levels lower to allow to additional rainfall to accumulate in the ponds.

Highlights of Ash Transport Water Reuse

Recycle achieved:	Complete recycle from combined ash pond
Type of water reused:	Bottom and fly ash transport water, coal pile runoff, rainfall, stormwater
Recycle destination:	Bottom ash transport water and fly ash transport water

Source: [ERG, 2009m].

**Case Study V: Coal-Fired Power Plant Water Reuse
Bottom Ash Transport Water Reuse
EME Homer City Generation L.P.'s Homer City Power Plant**

The Facility

Number of coal-fired units:	3 (650 MW; 650 MW; 700 MW)
Coal used:	Eastern bituminous
Bottom ash handling:	Wet
Fly ash handling:	Dry
Ash treatment system:	Dewatering bins and bottom ash pond

The Ash Handling and Treatment System

Bottom ash transport water is piped from the boilers to dewatering bins, which remove 90 to 95 percent of the solids. The dewatered bottom ash from the dewatering bins is either used locally for antiskid and road construction or placed in the on-site, unlined ash landfill. The decant overflow from the dewatering bins drains to ash settling ponds.

Homer City operates four ash settling ponds. The plant typically operates two ash settling ponds at one time, which are operated in series. Each ash pond has an approximate volume of 1.76 million gallons. The ash settling ponds receive overflow from the bottom ash dewatering bins, as well as stormwater runoff and rainfall. Runoff from the ash handling and precipitator areas (covering approximately six acres) drains into the ponds. Water from the first pond in a series pair overflows to the second pond, which in turn overflows to a clearwell. From the clearwell, water is recycled for use as bottom ash transport water. There is a periodic discharge from the clearwell through the NPDES outfall as needed to maintain the water balance in the system, the frequency of which depends on the amount of rainfall that has been received. As one pair of ash settling ponds fills with solids, the transport water is shifted to the other pair of ponds so that the settled ash can be removed. The ash settling ponds are dredged every six to eight months. The recovered solids are transported to the on-site, unlined ash landfill.

Highlights of Ash Transport Water Reuse

Recycle achieved:	Significant percentage of recycle from bottom ash pond
Type of water reused:	Bottom ash transport water and contaminated stormwater
Recycle destination:	Bottom ash transport water

Source: [ERG, 2007].

6. ENVIRONMENTAL ASSESSMENT OF COAL COMBUSTION WASTEWATER

Numerous studies have shown that the pollutants found in wastewater associated with coal combustion wastes can impact aquatic organisms and wildlife, and can result in lasting environmental impacts on local habitats and ecosystems. Many of these impacts may not be realized for years due to the persistent and bioaccumulative nature of the pollutants released. The total amount of toxic pollutants currently being released in wastewater discharges from coal-fired power plants is estimated to be significant and raises concerns regarding the long-term impacts to aquatic organisms, wildlife, and human health that are exposed to these pollutants. This chapter presents case study examples to illustrate the impacts that pollutants present in coal-fired power plant wastewater can have on the environment.

As described in Chapters 4 and 5, coal combustion wastes comprise a variety of residuals from the coal combustion process, including fly ash, bottom ash, and FGD solids (i.e., gypsum and calcium sulfite). Coal-fired plants remove these solid wastes through both wet and dry disposal methods. Dry disposal practices typically involve transferring the combustion wastes to a storage silo or outdoor storage pile to either be hauled to a landfill or, depending on the particular residual, sent offsite where it may be used to create beneficial by-products such as drywall or cement. In wet handling systems, bottom ash and fly ash is transported from the boiler and particulate removal units and is typically disposed of in surface impoundment settling ponds. Wet FGD systems use lime or limestone slurry to remove sulfur dioxide from flue gas. The water remaining from the slurry at the end of the FGD process, commonly called scrubber purge, is either discharged to a surface impoundment or sent to an advanced wastewater treatment system prior to discharge to a receiving stream.

Although there are several wastewater streams associated with coal-fired power plants, for the purposes of this chapter, coal combustion wastewater includes the following waste streams:

- FGD wastewater (i.e., scrubber purge) - the wastewater remaining following the use of a sorbent slurry (e.g., lime, limestone) to remove sulfur dioxide from flue gas;
- Fly ash transport water - the wastewater stream used to transport the fly ash away from the electrostatic precipitators (ESPs) or fabric filter baghouses;
- Bottom ash transport water - the wastewater stream used to transport the bottom ash away from the boiler; and
- Leachate or seepage from surface impoundments or landfills containing coal combustion residues.

The most common treatment and disposal practice for coal combustion wastewater involves pumping the slurried wastes into surface impoundments that serve as a physical treatment to remove particulate material through gravitational settling. The coal combustion wastewater present in surface impoundments can include one specific wastewater stream (e.g., fly ash transport water) or a combination of combustion wastewaters (e.g., fly ash transport water and FGD wastewater). The wastewaters sent to surface impoundments can also include coal pile runoff. Although coal pile runoff is not the result of a combustion process, it can contain many of the pollutants present in coal combustion wastewater. Some coal-fired power plants have implemented more advanced wastewater treatment systems such as chemical precipitation,

biological treatment, and evaporation/distillation to treat the FGD wastewater. Chapter 4 describes these advanced treatment practices in more detail. Regardless of whether a plant uses a settling pond or advanced treatment system, coal combustion wastewater is typically discharged into the natural environment where numerous studies have raised concern regarding the toxicity of these waste streams [Rowe et al., 2002; U.S. EPA, 2007c; NRC, 2006].

A number of variables can affect the composition of coal combustion wastewater, including parent coal composition, type of combustion process, flue gas cleaning technologies implemented, and management techniques used to dispose of coal combustion wastewater [Carlson and Adriano, 1993]. In particular, the practice of commingling coal combustion wastewater with other waste streams from the plant in surface impoundments can result in a chemically complex effluent that is ultimately released to the environment [Rowe et al., 2002]. Exposure to coal combustion wastewater has been associated with fish kills, reductions in the growth and survival of aquatic organisms, behavioral and physiological effects in wildlife and aquatic organisms, potential impacts to human health (i.e., drinking water contamination), and changes to the local habitat [Rowe et al., 2002; Carlson and Adriano, 1993]. The bioaccumulative properties of several coal combustion wastewater pollutants and long recovery times associated with many of the ecological impacts emphasize the potential threat these wastes present to the local environment. Research published in the scientific literature demonstrates that coal combustion wastewater is not a benign waste and further study is needed to fully understand how these chemically complex waste streams interact with the environment [Rowe et al., 2002; NRC, 2006].

This chapter examines the potential impacts of coal combustion wastewater on the environment by addressing the following three questions:

- What are the characteristics of coal combustion wastewater?
- How does coal combustion wastewater interact with the environment?
- What are the environmental effects of coal combustion wastewater?

Section 6.1 discusses the characteristics of coal combustion wastewater and why they are a threat to the environment. Section 6.2 explores the various ways that pollutants in coal combustion wastewater can come into contact with the environment through different waste management practices (e.g., surface impoundments and landfills). In addition this section describes how different surface water environments (e.g., lentic and lotic systems) can influence the environmental effect of coal combustion wastewater. Section 6.3 provides an overview of the different environmental effects reported in the literature resulting from exposure to coal combustion wastewater.

6.1 Coal Combustion Wastewater Pollutants

An increasing amount of evidence indicates that the characteristics of coal combustion wastewater have the potential to impact human health and the environment. Many of the common pollutants found in coal combustion wastewater (e.g., selenium, mercury, and arsenic) are known to cause environmental harm and can potentially represent a human health risk. Pollutants in coal combustion wastewater are of particular concern because they can occur in large quantities (i.e., total pounds) and at high concentrations (i.e., exceeding Maximum Contaminant Levels (MCLs)) in discharges and leachate to groundwater and surface waters. In

addition, some pollutants in coal combustion wastewater present an increased ecological threat due to their tendency to persist in the environment and bioaccumulate in organisms, which often results in slow ecological recovery times following exposure.

Constituents present in coal combustion wastewater are primarily derived from the parent coal. A number of these constituents have the potential to cause environmental harm depending on the mass pollutant load, wastewater concentration, and how organisms are exposed to them in the environment. Table 6-1 lists some of the common pollutants found in coal combustion wastewater that have been associated with documented environmental impacts or could have the potential to cause environmental impacts based on the loads and concentrations present in the wastewater. Table 6-1 is intended to highlight the most frequently cited pollutants in coal combustion wastewater associated with environmental impacts and does not include all pollutants that may cause adverse impacts. The remainder of this section provides an overview of the metals and pollutants most frequently cited as causing ecological impacts following exposure to coal combustion wastewater, some of which have been the focus of some state NPDES permit programs.

Table 6-1. Selected Coal Combustion Wastewater Pollutants

Compound	Potential Environmental Concern^{a,b,c,d}
Arsenic	Frequently observed in high concentrations in coal combustion wastewater; causes poisoning of the liver in fish and developmental abnormalities; is associated with an increased risk of cancer in humans in the liver and bladder.
BOD	Can cause fish kills because of a lack of available oxygen; increases the toxicity of other pollutants, such as mercury. Has been associated with FGD wastewaters that use organic acids for enhanced SO ₂ removal in the scrubber.
Boron	Frequently observed in high concentrations in coal combustion wastewater; leachate into groundwater has exceeded state drinking water standards; human exposure to high concentrations can cause nausea, vomiting, and diarrhea. Can be toxic to vegetation.
Cadmium	Elevated levels are characteristic of coal combustion wastewater-impacted systems; organisms with elevated levels have exhibited tissue damage and organ abnormalities.
Chlorides	Sometimes observed at high concentrations in coal combustion wastewater (dependent on FGD system practices); elevated levels observed in fish with liver and blood abnormalities.
Chromium	Elevated levels have been observed in groundwater receiving coal combustion wastewater leachate; invertebrates with elevated levels require more energy to support their metabolism and therefore exhibit diminished growth.
Copper	Coal combustion wastewater can contain high levels; invertebrates with elevated levels require more energy to support their metabolism and therefore exhibit diminished growth.
Iron	Leachate from impoundments has caused elevated concentrations in nearby surface water; biota with elevated levels have exhibited sublethal effects including metabolic changes and abnormalities of the liver and kidneys.
Lead	Concentrations in coal combustion wastewater are elevated initially, but lead settles out quickly; leachate has caused groundwater to exceed state drinking water standards. Human exposure to high concentrations of lead in drinking water can cause serious damage to the brain, kidneys, nervous system, and red blood cells.
Manganese	Coal combustion wastewater leachate has caused elevated concentrations in nearby groundwater and surface water; biota with elevated levels have exhibited sublethal effects including metabolic changes and abnormalities of the liver and kidneys.

Table 6-1. Selected Coal Combustion Wastewater Pollutants

Compound	Potential Environmental Concern ^{a,b,c,d}
Mercury	Biota with elevated levels have exhibited sublethal effects including metabolic changes and abnormalities of the liver and kidneys; can convert into methylmercury, increasing the potential for bioaccumulation; human exposure at levels above the MCL for relatively short periods of time can result in kidney damage.
Nitrogen	Frequently observed at elevated levels in coal combustion wastewater; may cause eutrophication of aquatic environments.
pH	Acidic conditions are often observed in coal combustion wastewater; acidic conditions may cause other coal combustion wastewater constituents to dissolve, increasing the fate and transport potential of pollutants and increasing the potential for bioaccumulation in aquatic organisms.
Phosphorus	Frequently observed at elevated levels in coal combustion wastewater; may cause eutrophication of aquatic environments.
Selenium	Frequently observed at high concentrations in coal combustion wastewater; readily bioaccumulates; elevated concentrations have caused fish kills and numerous sublethal effects (e.g., increased metabolic rates, decreased growth rates, reproductive failure) to aquatic and terrestrial organisms. Short term exposure at levels above the MCL can cause hair and fingernail changes; damage to the peripheral nervous system; fatigue and irritability in humans. Long term exposure can result in damage to the kidney, liver, and nervous and circulatory systems.
Total dissolved solids	High levels are frequently observed in coal combustion wastewater; elevated levels can be a stress on aquatic organisms with potential toxic effects; elevated levels can have impacts on agriculture & wetlands.
Zinc	Frequently observed at elevated concentrations in coal combustion wastewater; biota with elevated levels have exhibited sublethal effects such as requiring more energy to support their metabolism and therefore exhibiting diminished growth, and abnormalities of the liver and kidneys.

a – Source: [Rowe et al., 2002].

b – Source: [NRC, 2006].

c – Source: EPA Drinking Water Contaminants (<http://www.epa.gov/safewater/contaminants/index.html#mcls>)

d – Source: [U.S. EPA, 2007c].

Selenium

Selenium is the most frequently cited pollutant associated with documented environmental impacts following exposure to coal combustion wastewater [NRC, 2006]. Selenium concentrations present in coal combustion wastewater originate from the parent coal used in the combustion process. The toxic potential of selenium is related to its chemical form (i.e., selenite, selenate, elemental selenium) and solubility. The predominate forms of selenium in aquatic systems that receive coal combustion wastewater discharges are selenite and selenate [Besser et al., 1996]. Availability of selenium is controlled by dissolved oxygen levels, hardness, pH, salinity, temperature, and the other chemical constituents present [NPS, 1997].

Selenium has been tied to fish kills, and to developmental and reproductive failure in fish, reptiles, and birds. In a 1991 study, Sorensen found that selenium levels as low as 3-8 µg/L in aquatic environments can be life-threatening to fish [NPS, 1997]. Selenium has the potential to bioaccumulate and can be transferred maternally. As a result, selenium-related environmental impacts can linger for years even after exposure to coal combustion wastewater has ceased [Rowe et al., 2002]. Aquatic organisms exposed to coal combustion wastewater have exhibited elevated selenium concentration in organs such as their kidneys, liver, and gonads, resulting in abnormalities that hinder growth and survival [Rowe et al., 2002]. In addition to ecological

impacts, EPA has documented numerous damage cases where selenium in coal combustion wastewater discharges resulted in the issuance of fish consumption advisories in surface waters and the exceedance of selenium MCLs in groundwater, suggesting that selenium concentrations in coal combustion wastewater has the potential to represent a human health risk [U.S. EPA, 2007c; NRC, 2006].

Arsenic

Arsenic, like selenium, is soluble in near-neutral pH and in alkaline conditions, which are commonly associated with coal combustion wastewater. Because of these solubility characteristics, arsenic is highly mobile and is frequently observed at elevated concentrations at sites located downstream from coal combustion wastewater impoundments [NRC, 2006]. In addition, EPA has documented several damage cases where arsenic levels exceeded drinking water standards in groundwater near coal combustion waste management facilities [U.S. EPA, 2007c]. Groundwater contamination of arsenic at these concentrations represents a potential human health risk if the aquifer is used as a drinking water source or has the potential to impact a drinking water source.

Arsenic is also of concern due to its tendency to bioaccumulate in aquatic communities and potentially impact higher trophic level organisms in the area. For example, studies have documented water snakes, which feed on fish and amphibians, with arsenic tissue concentrations higher than their prey [Rowe et al., 2002]. Elevated arsenic tissue concentrations are associated with several biological impacts such as liver tissue death, developmental abnormalities, and reduced growth [NRC, 2006; Rowe et al., 2002].

Mercury

Although mercury concentrations in coal combustion wastewater are relatively low, mercury is a highly toxic compound that represents an environmental and human health risk even in small concentrations. One of the primary environmental concerns regarding mercury concentrations in coal combustion wastewater is the potential for methylmercury to form in surface impoundments and constructed wetlands prior to discharge. Methylmercury is an organic form of mercury that readily bioaccumulates in fish and other organisms and is associated with high rates of reproductive failure. Bacteria found in anaerobic conditions, such as those that may be present in sediments found on the bottom of coal combustion surface impoundments or in river sediments, convert mercury to methylmercury through a process called methylation. Microbial methylation rates increase in acidic and anoxic environments with high concentrations of organic matter. Studies have documented fish and invertebrates exposed to mercury from coal combustion wastewater exhibiting elevated levels of mercury in their tissues and developing sublethal effects such as reduced growth and reproductive success [Rowe et al., 2002].

Biochemical Oxygen Demand (BOD)

Biochemical oxygen demand (BOD) is a measure of the quantity of oxygen used by microorganisms (e.g., aerobic bacteria) in the oxidation of organic matter. The primary source of BOD in coal combustion wastewater is the addition of organic acid buffers to the FGD scrubbers. High BOD concentrations in surface waters have the potential to decrease dissolved oxygen levels and contribute to fish kills in waters that receive coal combustion wastewater. BOD levels can also influence the availability and toxicity of other coal combustion wastewater

constituents such as metals. For example, the rate of methylation, or the conversion from elemental mercury to methylmercury, increases at high concentrations of BOD, thus increasing the potential toxic effects of mercury present in coal combustion wastewater.

pH

The pH of coal combustion wastewater varies depending on the type of coal and the amount of metal oxides present [NRC, 2006]. Although some coal combustion wastewaters are alkaline, wastewater that is generated from power plants burning bituminous coal from southeastern or mid-Atlantic states is acidic [NRC, 2006]. Many pollutants in coal combustion wastewater, including cadmium, copper, chromium, lead, nickel, and zinc, are highly soluble in acidic, or non-neutral, conditions [NRC, 2006]. As a result, coal combustion wastewater often has high dissolved metal concentrations.

Chlorides and Total Dissolved Solids

Chloride levels in coal combustion wastewater are dependent upon chlorine concentrations present in the parent coal as well as the amount of recirculation in the FGD system. FGD systems with many iterations of circulation between blowdown cycles exhibit high concentrations of chlorides. Studies have found that coal combustion wastewater leachate reaching groundwater has caused chloride levels to exceed secondary MCLs [NRC, 2006]. Chlorides also contribute to the high total dissolved solids (TDS) levels typical of coal combustion wastewater. TDS, a reflection of water's salinity level, is a measure of the amount of dissolved matter in water. Calcium and magnesium also factor heavily into TDS levels of coal combustion wastewater. The remaining composition of TDS consists of other common dissolved metals and constituents, particularly at acidic pH levels when they exhibit high solubilities. Both chloride levels and TDS play a role in determining the availability and toxicity of other coal combustion wastewater constituents, including metals. As TDS and chloride levels fluctuate, so do the amounts of other metals that dissolve due to solubility characteristics.

Nutrients

Nutrient concentrations present in coal combustion wastewater are primarily attributed to the parent coal composition and air pollution controls in the coal combustion process. Phosphorus concentrations in coal combustion wastewater tend to vary based on the parent coal composition with high sulfur coals commonly associated with higher levels of phosphorus.

The primary concern with nutrients in coal combustion wastewater is the potential for the total nitrogen load from coal-fired power plants to significantly increase in the future as air pollution limits become stricter and the use of air pollution controls increases. While the current concentration of nitrogen present in coal combustion wastewater from any individual power plant is probably relatively low, the total nitrogen load from a single plant can be significant due to large wastewater flow rates. There are concerns that nutrient impacts could occur on waterbodies receiving discharges from multiple power plants. This is especially a concern on waterbodies that are nutrient impaired or in watersheds that contribute to downstream nutrient problems. Higher nutrient loads from coal-fired power plants could result in the eutrophication of waters receiving coal combustion wastewater. Eutrophication is the process where excess nutrients stimulate excessive plant and algal growth which can lead to declining dissolved oxygen levels.

6.2 Coal Combustion Wastewater Interactions with the Environment

The interaction of a pollutant source with the environment can be described as either a release from the source that alters the physical, chemical, or biological characteristics of an ecosystem or the attraction of wildlife and humans to the pollutant source (i.e., an attractive nuisance) prior to discharge. In 2007, EPA's Office of Resource Conservation and Recovery (ORCR, formerly named the Office of Solid Waste) evaluated 85 cases of environmental damage to determine if the observed impacts were due to pollutants from coal combustion wastes [U.S. EPA, 2007c]. EPA's Office of Water reviewed this information, along with several other instances where environmental impacts are attributable to coal combustion wastewater. Table 6-2 summarizes the number of environmental impact cases by type of waste management system and type of impacted water body resource.

Table 6-2. Number of Documented Cases of Environmental Impacts from Coal Combustion Wastewater

Source of Pollutant Release (Waste Management System)				Impacted Water Resource		
Surface Impoundment	Landfill	Both Surface Impoundment and Landfill	Not Identified	Surface Water	Groundwater	Both Surface Water and Groundwater
34	30	2	4	10	51	9
Total Number of Cases = 70						

Source: [Jordan, 2009].

The three primary routes through which coal combustion wastewater interacts with the environment are:

- Discharges to surface waters;
- Leaching to groundwater; and
- Surface impoundments and constructed wetlands acting as attractive nuisances.

The method of exposure plays an important role in determining the potential effects of coal combustion wastewater on the environment. For example, the physical and chemical characteristics of receiving waters and groundwater aquifers can affect the fate and transport of pollutants from coal combustion wastewater to the environment and how the pollutants interact with the biological community. This section describes the three primary methods through which coal combustion wastewater interacts with the environment and explores how each route can affect the potential for environmental impact from coal combustion wastewater.

6.2.1 Discharges to Surface Waters

Coal combustion wastewater is commonly discharged directly to surface waters following treatment in settling ponds. More recently, FGD wastewater at some power plants may be treated using advanced wastewater treatment systems employing tanks and similar structures (e.g., chemical precipitation or biological treatment systems) prior to discharge to an ash pond or directly to surface water.

One of the primary factors controlling the environmental impact of coal combustion wastewater on surface waters is the residence time of the pollutants once they enter an aquatic system. Residence times are often determined by the flow rate of the receiving water and type of ecosystem it supports. For example, the potential for pollutant retention in lentic (i.e., still or slow-moving water) aquatic systems and the creation of hot spots in lotic (i.e., actively-moving water) aquatic systems are of particular concern especially when bioaccumulative pollutants are present in coal combustion wastewater. Several coal combustion wastewater constituents (e.g., arsenic, mercury, selenium) can readily bioaccumulate in exposed biota. Bioaccumulation is the process wherein an organism absorbs a toxic substance through food and exposure to the environment at a faster rate than the substance is removed from the body. The bioaccumulation of coal combustion wastewater pollutants is of particular concern due to the potential for impacting higher trophic levels, local terrestrial environments, and transient species in addition to the aquatic organisms directly exposed to coal combustion wastewater. Aquatic systems with long residence times and potentially exposed to bioaccumulative pollutants often experience a persistence of environmental effects and suffer from long recovery times following the introduction of coal combustion wastewater to the system. The following sections describe how the differences in stream flow between lentic and lotic systems can impact the environmental effect of coal combustion wastewater on aquatic organisms and wildlife and the role that sediments in surface waters play in the persistence of these effects in aquatic systems.

Lentic Systems

Many aquatic environments that contain coal combustion wastewater (e.g., surface impoundments) or receive coal combustion wastewater discharges are lentic systems such as lakes, ponds, reservoirs, and swamps. The majority of ecological studies on the impact of coal combustion wastewater in aquatic environments have focused on lentic systems [Rowe et al., 2002]. In lentic aquatic systems, the hydraulic residence time, or the amount of time it takes for the water in the aquatic system to be replaced by influent (i.e., streams, precipitation), is relatively long, allowing pollutants to build up over time and making lentic systems more vulnerable to impacts from coal combustion wastewater. In addition, aquatic organisms are limited in their ability to avoid areas of high pollutant concentrations and are restricted to the food supply available within the water body. Some coal combustion wastewater pollutants (e.g., selenium) are known to bioaccumulate and have been known to concentrate in the upper tiers of the aquatic food web in lentic systems. For example, samples of sediments, plants, and aquatic organisms collected from the swamp near the D-Area Power Facility on the U.S. Department of Energy's Savannah River Site near Aiken, SC, reported elevated concentrations of arsenic, cadmium, chromium, copper, and selenium. In addition to the accumulation of these pollutants in organisms directly exposed to discharges of the coal combustion wastewater, studies of turtles, alligators, and birds living near the drainage swamp have shown these animals transfer trace metals such as selenium to their offspring. Chronic exposure to coal combustion wastewater pollutants in the swamp has been linked to detrimental changes in morphology, behavior, energetics, and endocrinology in local wildlife [Rowe et al. 2002]. In a 1999 study, Hopkins et al. observed that water snakes, which fed on fish and amphibians in the areas contaminated with coal combustion wastes, had accumulated higher arsenic tissue concentrations than their prey [Rowe et al., 2002].

Lentic System Case Study: Belews Lake, North Carolina

In 1970, Duke Power Company constructed Belews Lake, a 1,500 hectare cooling reservoir to support the Belews Creek Steam Station in Stokes County, North Carolina. Following completion of the reservoir, Duke Power began monitoring the fish populations in Belews Lake prior to any discharges of coal combustion wastewater. From 1974 to 1985, ash pond effluent was discharged into Belews Lake. Almost immediately following the introduction of the ash pond effluent to lake employees observed rapid and dramatic changes in the fish populations [Rowe et al., 2002]. By 1975, one year after discharges began, morphological abnormalities were reported for all 19 fish species monitored in the lake. Within two years following the release of coal combustion wastewater into the lake, several species experienced complete reproductive failure with only four species remaining by 1978 (i.e., four years after discharges began). Water samples collected in the lake reported elevated levels of arsenic, selenium, and zinc. The observed fish abnormalities were eventually correlated with high selenium whole-body concentrations with the planktonic community identified as the key source of selenium to the impacted fish.

In 1985 the Belews Creek Steam Station switched to a dry landfilling disposal method for the coal ash and ash pond discharges to the lake ended. In a 1997 study, Lemly determined that there was evidence that the lake was recovering; however, even 11 years after the discharges ceased selenium levels in the sediments still posed a risk to wildlife that feed on benthic organisms [Rowe et al., 2002]. Lemly also observed that despite the reduction in the selenium concentration present in fish ovaries, reproductive abnormalities remained persistent highlighting the long ecological recovery times commonly experienced in lentic systems with high pollutant retention rates and low sedimentation rates such as Belews Lake [Rowe et al., 2002].

Lotic Systems

Lotic systems are water bodies with flowing water such as streams, rivers, and springs that may provide more rapid dilution of coal combustion wastewater discharges than lentic systems. The moving water in lotic systems provides a transport mechanism to disperse coal combustion constituents greater distances from the power plant, and enables aquatic organisms to move away from the areas of coal combustion wastewater contamination [Rowe et al., 2002]. Although the discharge of coal combustion wastewater into a lotic system has the potential to increase the distribution of pollutants across a greater spatial area, changes in flow velocity may result in the concentration of pollutants at a single location further downstream [Rowe et al. 2002]. For example, coal combustion wastewater discharged to a river may encounter areas of slower moving water downstream where pollutants would fall out of suspension and concentrate in a limited area. These pockets of higher pollutant concentrations, or hot spots, could be vulnerable to continued resuspension as stream velocities are affected by rainfall events, resulting in the pollutants being available to aquatic organisms over much longer periods of time [Rowe et al., 2002; Lemly, 1996].

Few studies have demonstrated lethal and sublethal effects to aquatic organisms from the discharge of coal combustion wastewater into lotic systems; however, several studies have demonstrated the bioaccumulation of trace elements in fish and invertebrates in creeks downstream of coal combustion wastewater impoundments [Rowe et al., 2002]. In a 2001 study by Lemly et al., fish and water quality samples were collected downstream from the American Electric Power (AEP) John E. Amos Plant in Winfield, WV along Little Scary Creek and at a reference location along the Ohio River. Water quality samples reported elevated levels of arsenic, copper, and selenium in Little Scary Creek relative to the reference location. Bluegill fish liver concentrations were higher than the reference location for arsenic, cadmium, copper, chromium, selenium, and zinc demonstrating that pollutants from the ash pond discharge are accumulating in fish living downstream from the Amos Plant. Although currently there is a limited amount of information available on the environmental impacts of coal combustion wastewater on lotic systems, Lemly's results show that discharges from coal-fired power plants can affect organisms living downstream in lotic environments [Rowe et al., 2002].

Sediments in Surface Waters

Sediments present in both lentic and lotic aquatic environments play a major role in the residence time of coal combustion wastewater pollutants. Sediments act as long-term storage sites for contaminants, serving as an exposure source for organisms and downstream waters even after coal combustion wastewater discharges have ceased [Rowe et al., 2002]. This characteristic causes recovery of aquatic systems following coal combustion wastewater release to be extremely slow [Rowe et al., 2002]. A 1985 study by Lemly found that detrital pathways (i.e., processes associated with decomposition) in Belews Lake provided toxic doses of sediment-stored selenium to local biota many years after water concentrations of selenium were below levels of concern [Rowe et al., 2002]. The recovery of aquatic systems is particularly slow when sediment release acts in combination with a lentic system to continuously expose and reintroduce bioaccumulative pollutants to aquatic organisms. These factors cause pollutant levels in aquatic organisms to steadily rise because the pollutants remain stationary due to the slow-moving water, the organisms are exposed to additional pollutants that are released from sediments over time,

and the tissue concentrations of aquatic organisms increase beyond levels available in the water due to bioaccumulative properties.

6.2.2 Leaching to Groundwater

Pollutants in coal combustion wastewater and coal combustion wastes (e.g., ash, gypsum, calcium sulfite) can impact local groundwater systems through leaching from surface impoundments, landfills, and minefills. Coal combustion wastewater held in unlined surface impoundments can infiltrate through the subsurface and enter the groundwater system. Unlined landfills and minefills, used to dispose of coal combustion residues, are also subject to leaching as rainfall penetrates the residue pile dissolving pollutants into the pore water, which eventually migrates to aquifers. Pollutants from coal combustion wastewater can also enter the groundwater system when liners fail or when a disposal site is inappropriately situated such that natural groundwater fluctuations come into contact with the disposed-of waste. As Table 6-2 indicates, EPA has identified 51 instances where coal combustion wastes and wastewater have caused impacts to ground water.

Older disposal sites are of particular concern because most of these surface impoundments and landfills were not built with liners. Although the use of liners for surface impoundments and landfills is increasing at new facilities, many states do not require basic environmental protection standards such as leachate collection systems and impermeable liners [Rowe et al., 2002].

Once in the groundwater system, coal combustion wastewater pollutants have the potential to migrate from the site at concentrations that could contaminate drinking water wells and surface waters [NRC, 2006]. The fate of coal combustion wastewater pollutants in groundwater systems is controlled by an array of geochemical (e.g., adsorption, desorption, and precipitation reactions with aquifer materials) and biological processes that can vary over large spatial and temporal scales [NRC, 2006]. For example, pollutants leaching from unweathered coal combustion residues disposed of in landfills and minefills may experience an initial set of rapid dissolution and desorption reactions followed by slower reactions as alkalinity is leached from the residue pile over time [NRC, 2006].

The degree of degradation caused by coal combustion wastewater leaching into groundwater systems depends on the type and concentration level of the pollutants, volume of contaminated water entering the subsurface, and the ability of the aquifer to dilute or attenuate the contamination [NRC, 2006]. Some coal combustion wastewater pollutants may be unaffected by subsurface geochemical processes and move freely with the groundwater flow, readily contaminating local drinking water wells and surface waters [NRC, 2006]. However, other pollutants may be subject to adsorption or precipitation reactions or transformed by microbiotic mediated biological reactions altering the extent of the contamination [NRC, 2006].

The rate of pollutant transport in groundwater systems depends on several factors such as the biogeochemical characteristics of the subsurface (e.g., soil pH and oxidation-reduction potentials), local rates of groundwater recharge, and unsaturated and saturated groundwater flow velocities. Predicting the transport of coal combustion pollutants in groundwater can be challenging due to the wide range of biogeochemical characteristics that can exist between sites and within a given site. Groundwater models that require information on the groundwater chemistry, the mass and form of mineral phases present at the site, and the dominant microbially mediated geochemical reactions can be used to predict the potential for transport. However, the conditions (e.g., pH, oxidation-reduction conditions, and hydraulic conductivity) influencing the field behavior of coal combustion wastes over the extended time frames typically encountered at coal combustion wastewater disposal sites is poorly understood [NRC, 2006]. Pollutant transport times can vary significantly and it might take relatively little time or many years before pollutants from coal combustion wastewater degrade local drinking water wells and surface waters. For example, in the damage case at the Wisconsin Electric Power Company facility in Port Washington, Wisconsin, fly ash had been disposed of in a quarry for over 20 years (1943-1971) prior to the selenium and boron contamination being reported in a down-gradient private drinking water well [U.S. EPA, 2007c]. This suggests that a longer period of groundwater monitoring may be required at some sites to adequately assess the full release of contaminants, which can occur over several decades [NRC, 2006]. In addition to potentially long temporal scales, groundwater contamination can occur on large spatial scales based on the

**Groundwater Case Study: Constellation Ash Disposal at Waugh Chapel and Turner Pits
Anne Arundel County, Maryland**

For over a decade, Constellation Energy Group (Constellation) supplied fly ash for structural fill at the B.B.S.S. Inc. (BBSS) sand and gravel mines in Anne Arundel County, Maryland. Fly ash from Constellation's Brandon Shores and Wagner plants were used to reclaim portions of BBSS' Turner Pit starting in 1995 and the Waugh Chapel Pit starting in 2000. In the fall of 2006, Anne Arundel County Health Department officials documented concentrations of sulfate and metals (i.e., antimony, beryllium, cadmium, manganese, and nickel) exceeding the state's screening criteria for potable aquifers in residential wells located downgradient from Waugh Chapel and Turner Pits [Erbe et al., 2007].

An independent study of the contamination confirmed that the elevated concentrations of sulfate and metals observed in the wells were the direct result of precipitation infiltrating the fly ash deposited in the BBSS sand and gravel mines [Erbe et al., 2007]. In October 2007, MDE fined Constellation and BBSS \$1 million for the ground water contamination and included requirements for the companies to restore the local aquifer water quality [MDE, 2008]. In addition, a group of Anne Arundel homeowners impacted by the contamination filed a class action lawsuit against Constellation and were awarded a \$45 million settlement that required Constellation to pay the costs for converting 84 homes from well water to public water; cease future deliveries of new coal ash to the quarry; and to establish trust funds to compensate impacted property owners, enhance the neighborhood, and remediate and restore a former quarry site [Schultz, 2008].

hydraulic properties of the subsurface traveling long distances before it encounters a drinking water well or discharges as a spring or as seepage into a stream, lake, or ocean [NRC, 2006].

6.2.3 *Surface Impoundments and Constructed Treatment Wetlands as Attractive Nuisances*

The environmental characteristics of settling ponds or surface impoundments and constructed wetlands that are used to treat coal combustion wastewater often support an ecosystem unto themselves that attracts wildlife to these waste and wastewater storage areas. Surface impoundments can be classified as a lentic system supporting aquatic vegetation and organisms, and serving as an attractive nuisance that draws wildlife from other terrestrial habitats. An attractive nuisance is typically defined as an area or habitat that is attractive to wildlife and that is contaminated with pollutants at concentrations high enough to potentially cause harm to exposed organisms.

As an attractive nuisance, surface impoundments holding coal combustion wastewater may impact local wildlife as well as transient species that may rely on them during critical reproduction periods such as seasonal breeding events [Rowe et al., 2002]. Exposure to coal combustion wastewater during sensitive life cycle events is potentially of concern given that exposure to coal combustion wastewater has been associated with complete reproductive failure in various vertebrate species [Rowe et al., 2002].

6.3 Types of Environmental Effects

The discharge of coal combustion wastewater from coal-fired power plants has caused a wide range of environmental effects to local aquatic life. Studies have documented numerous ecological impacts from the intentional and accidental release of coal combustion wastewaters, as well as through detailed laboratory and field studies examining the toxicity of the characteristics of coal combustion wastewater. Environmental effects documented in the literature can be broken into the following three categories:

Surface Impoundment Case Study: Gibson Lake and Cane Ridge Wildlife Management Area (WMA) Gibson County, Indiana

Gibson Lake is a large (3,000-acre) man-made shallow impoundment that provides cooling water for Duke Energy's Gibson Generating Station located near the Wabash River in Gibson County, Indiana. In addition to cooling water discharges, the lake also receives ash pond effluent. Starting in 1986, least terns, an endangered species of migratory birds, began using the dike in Gibson Lake as a nesting ground for breeding [Pruitt, 2000]. By 1993, nearby ash ponds at the Gibson Generating Station were also attracting nesting least terns, placing these sensitive species in direct contact with coal combustion wastewater. To address the attractive nuisance problem presented by the ash ponds and Gibson Lake, the Gibson Generating Station began a cooperative program with the Indiana Department of Natural Resources to protect the nesting birds by creating a nearby alternative habitat known as the Cane Ridge WMA [Pruitt, 2000]. To create the new habitat, water from Gibson Lake was pumped into ponds at the Cane Ridge WMA.

In April of 2007, Duke Energy closed access to Gibson Lake for recreational fishing due to elevated selenium levels [Duke Energy, 2007]. Selenium levels in the lake fish presented a human health risk based on EPA's recommended concentration for subsistence fishers. A year later, the U.S. Fish and Wildlife Service (USFWS) became concerned about selenium levels in the water and fish present in the Cane Ridge WMA. As a result, the USFWS decided to immediately stop the flow of water from Gibson Lake into Cane Ridge, discourage least terns from using the refuge, draw down the water in the ponds, and remove the contaminated fish [USFWS, 2008]. In addition, the pond bottom was plowed to redistribute and bury the selenium in the soil and water was piped in from the Wabash River, instead of from Gibson Lake. Duke Energy paid to stock the Cane Ridge ponds with fathead minnows to lure back migratory birds. As of June 2009 avocets, dunlins, black terns, Forster's terns, Caspian terns and 50 endangered least terns have returned to Cane Ridge [USFWS 2009].

- Lethal effects – fish kills and mortality to other organisms;
- Sublethal effects – histopathological changes, or accumulation of trace elements in tissue, and damage to reproductive and developmental success; and
- Population and community effects – changes in species abundance and composition.

In addition to a direct impact on aquatic ecology and local wildlife, coal combustion wastewater has also resulted in other environmental impacts such as altering local habitats, contaminating drinking water, and resulting in fish advisories.

6.3.1 Lethal Effects

Fish kills are one of the most common lethal effects documented in the literature from exposure to coal combustion wastewater. In many cases, fish kills are the result of the accidental release of coal combustion wastewater; however, fish kills have been associated with the intentional discharge of coal combustion wastewater. In a number of these documented fish kills, coal combustion wastewater was discharged to what appeared to be a healthy aquatic habitat until lethal effects such as fish kills were observed in the system. For example, in 1978 the Texas Utilities Generating Company located in Martin Creek, Texas, began discharging coal combustion wastewater from two fly ash settling ponds into a 2,000-hectare cooling water reservoir located on the facility's property. Within eight months after the discharges began, a major fish kill occurred in the reservoir prompting Texas Utilities to cease discharging coal combustion wastewater into the reservoir. The sudden appearance of fish kills and other ecological effects, such as developmental abnormalities and reproductive failure, in aquatic systems receiving coal combustion wastewater prompted numerous research studies to identify the extent of damage and the specific cause. In a 1981 study conducted by *Carolina Power and Light Company, Environmental Services Station at Hyco Reservoir*, scientists concluded that elevated selenium concentrations were likely the primary factor contributing to fish kills and to lethal effects towards amphibians and crustaceans [Rowe et al., 2002]. Long-term studies of aquatic environments exposed to coal combustion wastewater found that, after experiencing fish kills, the affected environments can experience population and community effects for many years before biomass returns to normal levels [Rowe et al., 2002].

Lethal Effects Case Study: Hyco Reservoir, North Carolina

Hyco Reservoir is a large cooling reservoir located in Roxboro, North Carolina. In addition to receiving cooling tower blowdown, the reservoir also received effluent from fly ash basins prior to 1981. In the fall of 1981, a large-scale fish kill occurred in the reservoir prompting numerous scientific studies to examine the extent and cause of the environmental damage.

In a 1981 study conducted by Carolina Power & Light, fish and water chemistry samples were collected in the reservoir to evaluate the cause of the fish kill. Water samples indicated that dissolved selenium concentrations were quite high (up to 5.5 ppb), whereas concentrations of other coal combustion wastewater-derived trace elements were not elevated. Similarly, fish tissue samples exhibited high concentrations of selenium, while other trace elements were within normal concentration ranges. Bluegill fish livers were found to have selenium concentrations approximately 50 times greater than liver concentrations found in fish not exposed to water from Hyco Reservoir. While other coal combustion wastewater-derived trace elements may also contribute to lethal effects, this case study indicates that elevated selenium concentrations from coal combustion wastewater can result in lethal effects, such as fish kills.

Laboratory and outdoor mesocosm studies have confirmed that both acute and chronic exposure to coal combustion wastewater can be lethal to a wide range of aquatic organisms. For example, in a 1976 study by Guthrie and Cherry, shrimp darters and salamanders were found to be highly sensitive to acute exposures of coal combustion wastewater. In the study, shrimp darters and salamanders caged for five days in a drainage basin outflow located on the D-Area Power Facility grounds experienced nearly 100 percent mortality [Rowe et al., 2002]. Invertebrates and fish in the study were also affected by the exposure to coal combustion wastewater; however, they reported lower rates of mortality [Rowe et al., 2002]. In a 2001 study by Hopkins, juvenile chubsuckers (a benthic fish) demonstrated a high sensitivity to chronic exposure to coal combustion wastewater [Rowe et al., 2002]. In this outdoor mesocosm study, organisms were exposed to sediments, water, and food from the D-Area Power Facility grounds, and experienced a 75 percent mortality rate after 45 days. These studies and others indicate that the lethal effects of coal combustion wastewater exposure can be quite potent, even though extreme differences in species sensitivity have been observed [Rowe et al., 2002].

6.3.2 Sublethal Effects

Sublethal effects from exposure to coal combustion wastewater can vary widely and include changes that impact growth, reproduction, and survival of susceptible organisms. Numerous vertebrate and invertebrate species have demonstrated a sensitivity to coal combustion wastewater and developed sublethal conditions such as increased metabolic rates, decreased growth rates, abnormal teeth and fin morphology, accumulation of trace elements in tissue, and reproductive failure [Rowe et al., 2002]. Sublethal effects documented in the literature are primarily linked to exposure to selenium concentrations present in coal combustion wastewater; however, sublethal effects have also been attributed to a number of other coal combustion wastewater pollutants such as arsenic, cadmium, chromium, copper, and lead [Rowe et al., 2002].

Histopathological effects (i.e., accumulation of trace elements in tissue), increased metabolic rate, and decreased growth rates are typical growth effects caused by coal combustion wastewater contamination. Water and fish samples collected before and after the discharge of coal combustion wastewater to the Texas Utilities Martin Creek Reservoir found that selenium concentrations were significantly elevated in the reservoir and in fish livers, kidneys, and gonads [Rowe et al., 2002]. In 1984, Garrett and Inman reported that elevated selenium concentrations persisted in the livers and kidneys of several species of fish for up to three years after the coal combustion wastewater discharges ceased [Rowe et al., 2002]. Additionally, a 1988 study by Sorensen found that red ear sunfish native to the reservoir exhibited ovary abnormalities related to elevated selenium concentrations up to eight years following the brief exposure to coal combustion wastewater [Rowe et al., 2002]. Although the ash pond discharge was short-lived (i.e., eight months), many of the histopathological effects persisted for years after the discharge had ceased [Rowe et al., 2002].

Fish are not the only organisms with documented sublethal impacts from exposure to coal combustion wastewater. Several studies have demonstrated increased metabolic rates and decreased growth rates in crustaceans exposed to coal combustion wastewater. In Rowe's 1998 study, grass shrimp caged *in situ* in the D-Area Power Facility's secondary settling basin experienced a 51 percent increase in standard metabolic rate after eight months [Rowe et al., 2002]. Similarly, crayfish captured in the vicinity of the secondary basin as well as crayfish

collected from unpolluted sites and exposed to sediments and food collected from the secondary basin both experienced increased metabolic rates and decreased growth rates. These changes in metabolism reflect that the organism wastes energy during normal metabolic processes in response to contaminant exposure and accumulation [Rowe et al., 2002].

Exposure to coal combustion wastewater has caused a number of organisms to experience reproductive failure and other forms of diminished reproductive success. A 1986 study by Gillespie and Baumann at Hyco Reservoir found that bluegill sunfish exposed to coal combustion wastewater accumulated selenium in ovarian tissue. Affected sunfish produced edematous, or fluid-swelled, larvae that died before maturing [Rowe et al., 2002]. Maternal transfer of coal combustion wastewater pollutants to offspring has been observed for several species. A 2001 study conducted by Nagle et al. at the D-Area Power Facility found that turtles, alligators, and birds inhabiting the vicinity of the settling basins and drainage swamp transfer coal combustion wastewater contaminants to developing offspring [Rowe et al., 2002]. Nagle et al., however, concluded that this transfer of contaminants did not cause any noticeable biological ramifications [Rowe et al., 2002].

Morphological changes that affect survival have also been observed for organisms exposed to coal combustion wastewater. A 2003 laboratory study by Hopkins et al. found that the sustained swimming speed and burst swimming speeds of the lake chubsucker (fish) were greatly reduced when exposed to coal combustion wastewaters [Rowe et al., 2002]. This reduction in speed was caused by fin abnormality, a morphological change that can be attributed to exposure to coal combustion wastewater [Rowe et al., 2002]. A study of larval bullfrogs living in the D-Area Power Facility's secondary settling basin found that more than 95 percent of individuals had abnormal oral structures, such as the absence of grazing teeth or entire rows of teeth. Rowe et al.'s 1996 study found that these oral malformations changed the feeding ecology of the affected individuals, limiting their feeding niche and subsequently reducing their growth rate [Rowe et al., 2002]. A 1998 study by Raimondo et al. found that larval bullfrogs also displayed abnormal swimming behavior, which was caused by malformations of their tails [Rowe et al., 2002]. These abnormal larval bullfrogs, living in the secondary basin of the D-Area, were more frequently preyed upon than were bullfrogs from an unpolluted site [Rowe et al., 2002].

6.3.3 Population and Community Effects

In addition to environmental effects on individual organisms, coal combustion wastewater has the potential to modify higher-order ecological processes (i.e., population and community dynamics) in the surrounding ecosystems. Changes to the number of aquatic organisms and wildlife present in a system, interspecies interactions, and the structure of aquatic communities have all been linked to contamination of aquatic habitats by coal combustion wastewater [Rowe et al., 2002].

Numerous studies have documented the decline in invertebrates, fish, and local wildlife populations following exposure to coal combustion wastewater [Rowe et al., 2002]. Population effects (i.e., decline in number of organisms present) have been attributed to lethal effects of pollutants present in coal combustion wastewater, declines in organism survival rates from abnormalities attributed to coal combustion wastewater exposure, and declines in the abundance or quality of prey. For example, many species of benthic fish rely on small invertebrates as a

source of food and, when the food source is diminished (i.e., lower invertebrate abundance and density), benthic fish exhibit higher mortality rates and smaller growth than fish exposed to coal combustion wastewater with high quality food sources [Rowe et al., 2002]. In a 1980 study of Rocky Run Creek by Forbes and Magnuson, fungal decomposition of detritus was extremely limited due to the effects of coal combustion wastewater. Benthic invertebrates, which graze on detrital material, displayed a lower population density as a result. Similarly, benthic fish that prey upon small invertebrates exhibited increased mortality due to a reduction in available resources, and therefore a decreased population density [Rowe et al., 2002].

In addition to density effects, communities have experienced alterations in species diversity due to exposure to coal combustion wastewater. In the Martin Creek Reservoir, during a short eight-month period of coal combustion wastewater input, both planktivorous (i.e., diet primarily consists of plankton) and carnivorous (i.e., diet primarily consists of meat) fish experienced severe reductions in total biomass, while omnivorous (i.e., diet consists of meat and plants) fish increased in biomass [Rowe et al., 2002]. A study by Garrett and Inman in 1984 found that in the three years after the effluent release was halted, planktivorous fish populations remained extremely low, while carnivorous fish populations nearly recovered. This recovery occurred because carnivorous fish have a more diverse diet than planktivorous fish, so food availability increased relatively quickly as the aquatic system recovered [Rowe et al., 2002]. These changes in population diversity indicate a significant change in community structure as a result of exposure to coal combustion wastewater.

In contrast to the Martin Creek Reservoir studies, coal combustion wastewater can also affect species diversity in the top predators of the food chain. In 1993, a study conducted by Lemly at Belews Lake found that large predatory fish were some of the first fish species to die out completely, due to the lethal and sublethal effects of coal combustion wastewater exposure [Rowe et al., 2002]. Because a top predator was no longer present, some fish that exhibited developmental abnormalities were able to survive, despite their otherwise high susceptibility to predation [Rowe et al., 2002].

Density and diversity effects caused by coal combustion wastewater contamination have the potential to be wide-ranging geographically. A 1972 study by Cairns et al. examined the effects of an ash effluent spill from the AEP Clinch River Power Plant into the Clinch River in Virginia. A dike surrounding an ash settling pond collapsed, releasing effluent with a pH greater than 12.0 and killing more than 200,000 fish. The study observed drastic reductions in both diversity and densities of aquatic organisms [Carlson and Adriano, 1993]. A follow-up survey taken two years after the spill indicated that some recovery was occurring, but the diversity and density of benthic fauna was still greatly reduced downstream from the spill [Carlson and Adriano, 1993].

6.3.4 Human Health Impacts

In addition to the individual and community ecological impacts discussed above, coal combustion wastewater has been linked to human health concerns as a result of elevated pollutant concentrations in surface water and groundwater, which have resulted in fish advisories and groundwater that has exceeded SDWA MCLs.

Metals and other pollutants present in coal combustion wastewater may contaminate actual or potential drinking water sources by leaching from surface impoundments or landfills into groundwater or surface waters. For example, at the Chisman Creek Disposal Site, a fly ash landfill in Virginia, water in nearby residential wells turned green and testing revealed the wells were contaminated with selenium and sulfate from groundwater contaminated with leachate from coal combustion wastewater [NRC, 2006]. EPA closed the residential wells to reduce the risk of human exposure to coal combustion pollutants [NRC, 2006]. EPA's ORCR has documented instances where coal combustion wastewater contaminated groundwater at concentrations exceeding EPA's MCL for drinking water [U.S. EPA, 2007c]. Although the contaminated groundwater sources may not directly be used as a drinking water source in all cases, the contamination represents a possible human health risk due to the potential for groundwater to impact other nearby aquifers and surface waters designated as drinking water sources.

EPA has also identified cases of human health concerns related to coal combustion wastewater causing elevated pollutant concentrations in biota. Fish consumption advisories are the most common human health concern and are issued in response to elevated pollutant concentrations in fish that are considered unsafe for human consumption. In 1992, the Texas Parks and Wildlife Department's monitoring program documented elevated levels of selenium in fish at the Southwestern Electric Power Company Welsh Reservoir in Mount Pleasant, Texas. The reservoir received influent from ash settling ponds, which was the likely source of high selenium levels. In response to these elevated levels, the Texas Commissioner of Health issued a fish advisory that lasted for 12 years before it was lifted. A similar case identified by EPA occurred in the Brandy Branch Reservoir in Marshall, Texas. The cooling reservoir received ash pond effluent from Southwestern Electric Power Company's Pirkey Power Plant [U.S. EPA, 2007c]. Studies by the Texas Parks and Wildlife Department reported that average selenium concentrations in fish nearly tripled between 1986 and 1989, once coal combustion wastewater discharges began [U.S. EPA, 2007c]. The Texas Department of Health issued a fish consumption advisory that lasted from 1992 to 2004 [U.S. EPA, 2007c].

7. PRELIMINARY INVESTIGATION OF OTHER INDUSTRY SEGMENTS

As described in Chapter 3, the *electric generating industry* is generally categorized by NAICS Code 2211. However, prior to the introduction of NAICS codes, the electric generating industry had been categorized by three Standard Industrial Classification (SIC) codes:

- **4911 – Electric services.** Establishments engaged in the generation, transmission, and/or distribution of energy for sale.
- **4931 – Electric and other services combined.** Establishments primarily engaged in providing electric services in combination with other services when the electric services are the major part of the services, but are less than 95 percent of the total services.
- **4939 – Combination utilities, not elsewhere classified.** Establishments primarily engaged in providing combinations of electric, gas, and other services, not elsewhere classified.

It should be noted that these SIC codes include all electric generating plants, not just steam electric plants. For example, some of the plants included in SIC code 4911 generate electricity solely by way of combustion turbines or hydroelectric turbines (i.e., steam is not used to move the turbine). EPA did not investigate the operations at power plants that do not use a water/steam thermodynamic medium to generate electricity (e.g., combustion turbines, hydroelectric plants). However, during the detailed study, EPA evaluated certain electric power and steam generating activities that are similar to the processes regulated for the Steam Electric Power Generating Point Source Category, but are not currently subject to the effluent guidelines. EPA assessed information regarding the following types of plants and operations:

- Plants that generate electric power using steam to drive a turbine, but whose energy/heat source used to produce the steam is not a fossil or nuclear fuel (referred to in this report as “alternative-fueled” plants). These energy sources may include combustible fuels (e.g., municipal solid wastes, wood and wood wastes, landfill gas) or other energy sources, such as solar power and geothermal energy.
- Industrial plants that generate electric power using steam to drive a turbine, but that are not primarily engaged in distributing and/or selling that electric power (referred to in this report as “industrial non-utilities”). These industrial steam electric non-utilities provide electric power to an industrial process (e.g., chemical manufacturing, petroleum refining) and in some cases may sell excess electrical power to the grid. EPA’s focus for these plants is on the waste streams generated by the electric generating units, and not the other waste streams generated by the primary industrial processes at the plant.
- Plants that generate steam for distribution and/or sale, but that do not primarily use that steam to drive a turbine and produce electric power (referred to in this report as “steam and air conditioning supply” plants).

- Plants that provide a combination of electric power and other utility services (i.e., SIC Code 4939 - referred to in this report as “combination utilities”). EPA specifically focused on those combination utilities that generate electric power by using steam to drive a turbine.

This chapter describes the information EPA obtained during the detailed study regarding these types of operations and resulting wastewaters. Section 3.1 provides additional definitions and demographics for the electric generating industry.

7.1 Alternative-Fueled Steam Electric Plants

This section describes EPA’s study of alternative-fueled steam electric plants, which produce electricity for distribution and/or sale using steam that is created by means other than fossil-fueled or nuclear-fueled processes. In this report, alternative-fueled steam electric plants refer to those plants that produce steam by combusting a solid or gaseous alternative fuel, those that use steam from geothermal reservoirs (geothermal steam electric plants), and those that produce steam using the sun’s energy (solar steam electric plants).

EPA reviewed NPDES permits for a prioritized subset of alternative-fueled steam electric plants to identify sources of wastewater and determine how wastewater discharges from these plants are currently regulated (e.g., whether the Steam Electric Power Generating effluent guidelines are applied using best professional judgment (BPJ)). Additionally, EPA contacted several companies operating alternative-fueled steam electric plants to discuss the operations and wastewaters generated at the plants related to steam or electricity production.

Wastewater generated by alternative-fueled steam electric processes is not currently regulated by the Steam Electric Power Generating effluent guidelines, because the electricity does not result “...primarily from a process utilizing fossil-type fuel (coal, oil, or gas) or nuclear fuel...”, as defined at 40 CFR Part 423.10. Information that EPA obtained during the detailed study indicate that these alternative-fueled plants use similar processes to plants that are regulated under the Steam Electric Power Generating effluent guidelines. In fact, many of these alternative-fueled plants also combust fossil fuels as a secondary energy source to generate the steam (40 percent of plants), typically within the same generating unit and typically natural gas or oil instead of coal. Because many of the waste streams generated from the operation of combustion processes are associated with the handling of fuel wastes (e.g., ash transport water), the characteristics of the wastewaters may vary depending on the type of fuel used by the plant.

During the detailed study, EPA collected little information about the pollutants and associated concentrations in the wastewater discharged from steam electric processes using alternative fuels. However, EPA determined that these plants generally produce a much smaller amount of electricity and discharge a smaller amount of wastewater to the environment than steam electric plants regulated by the Steam Electric Power Generating effluent guidelines. EPA also determined that permits regulating the discharges from alternative-fueled plants vary from plant to plant and are dependent on both the type of fuel used and the handling of the wastewaters generated. EPA found that some of the permits reviewed contained few limits based on the Steam Electric Power Generating effluent guidelines, while others wholly incorporate the Steam Electric Power Generating effluent guidelines limits.

7.1.1 Demographic Data for Alternative-fueled Steam Electric Plants

The 2005 EIA database includes 198 plants that reported a NAICS code of 22 (Utilities) and the use of an alternative fuel as a primary energy source to drive a steam turbine. Some of these plants use alternative fuels in combination with a fossil-type (i.e., 423-type) fuel. Three of the 198 plants reported operating an electric generating unit burning a fossil fuel as a primary energy source, in addition to the electric generating unit(s) burning alternative fuels. Seventy-six of the 198 plants reported using both an alternative fuel and a fossil fuel to power the same generator (the fossil fuel is reported as the secondary or tertiary energy source); however, these secondary fossil fuel energy sources may be serving as a starter or supplemental fuel in the boiler.

The average electric generating capacity for alternative-fueled plants in the 2005 EIA database is less than 50 MW. Excluding geothermal steam electric plants, the 156 alternative-fueled plants produce less than one percent of the electricity produced by the fossil- and nuclear-fueled steam electric plants currently regulated by the Steam Electric Power Generating effluent guidelines. EPA did not include geothermal steam electric plants in this calculation because they are assumed not to directly discharge wastewater [CEPA, 2006d; CEPA, 2006c; U.S. DOE, 2006a]. Table 7-1 presents a breakdown of plant energy capacity by fuel type. Section 3.1.2.2 of this report provides additional detail on the demographics of the Steam Electric Power Generating Point Source Category.

EPA is not aware of any analyses demonstrating that pollutant loadings are correlated to electric power generated; however, EPA believes it is reasonable to assume that alternative-fueled plants will produce smaller pollutant loadings than those produced by steam electric plants with energy capacities that are one or two orders of magnitude larger.

7.1.2 Alternative-Fueled Steam Electric Fuel Types and Processes

The steam electric generating process used at alternative-fueled steam electric plants is similar to that used by all steam electric plants, as described in Section 3.2, in that these plants use a steam/water system as the thermodynamic medium to produce electricity. Alternative-fueled steam electric plants use steam (which may or may not be produced in a boiler) to drive a steam turbine/electric generator and condense the steam by noncontact cooling.

Because the alternative-fueled process operations are similar to those of the steam electric plants regulated under the Steam Electric Power Generating effluent guidelines, they may generate many of the same types of wastewaters (e.g., ash transport water, boiler blowdown, cooling water). Because there are similar operations between the different types of plants, the wastewaters that do not directly contact the fuel (i.e., boiler blowdown, cooling water) may have similar pollutant characteristics. Because these wastewaters are not associated with the fuels used at the plant, they are likely to be similar in characteristics to the wastewaters generated by the steam electric plants regulated under the Steam Electric Power Generating effluent guidelines. The wastewaters that do contact the fuel (e.g., fuel storage runoff) or the fuel wastes (ash transport water) may not have similar characteristics as the wastewaters generated by steam electric plants regulated under the Steam Electric Power Generating effluent guidelines because the different fuels have different constituents.

Table 7-1. Summary of Alternative-Fueled Steam Electric Plants, by Fuel/Energy Source Type

Fuel/Energy Source	Number of Plants	Total Capacity ^a (MW)
Steam Electric Plants Regulated Under the Steam Electric Power Generating effluent guidelines		
Fossil and Nuclear Fuel	1,187	762,000
Alternative-Fueled Steam Electric Plants		
Municipal Solid Waste	59	2,270
Wood Solid Waste	66	1,830
Solar	9	400
Landfill Gas	12	261
Agricultural By-products	5	184
Other Biomass Solids	2	58
Tires	2	57
Other Biomass Gas	1	23
Total for Alternative-Fueled Facilities (excluding Geothermal)	156 ^b	5,080
Geothermal ^c	42	2,950

Source: [U.S. DOE, 2005a].

Note: The table includes only the capacity associated with stand-alone steam turbines, combined cycle steam turbines, combined cycle single shaft turbines, and combined cycle combustion turbines.

a – The capacities represent the reported nameplate capacity. The capacities presented have been rounded to three significant figures. Due to rounding, the total capacity may not equal the sum of the individual capacities.

b – It is possible that some of these 156 alternative-fueled plants may be cogeneration plants, as discussed in Section 3.2.1.

c – Steam electric processes using geothermal energy sources are assumed not to generate wastewater [CEPA, 2006d; CEPA, 2006c; U.S. DOE, 2006a].

The steam electric process, sources of wastewater, potential wastewater pollutants, current operating practices, and current permitting practices for various types of alternative-fueled steam electric plants are discussed below by type of fuel.

7.1.2.1 Solid Fuels

Steam electric plants fueled by solid alternative fuels (e.g., municipal solid waste (MSW), wood solid waste, agricultural by-products, tires) use a similar process as those plants that are currently regulated under the Steam Electric Power Generating effluent guidelines. These alternative-fueled steam electric plants combust a solid fuel, typically in a boiler, to produce steam, which powers a steam turbine/electric generator. This combustion process generates ash. The steam exiting the turbine is condensed with cooling water and the condensate is typically fed back to the boiler. Thus, steam electric plants fueled by solid alternative fuels generate some of the same types of wastewaters as those currently regulated under the Steam Electric Power Generating effluent guidelines. As described in Section 3.2.1, these wastewaters include fly ash and/or bottom ash transport water, metal cleaning wastes, once-through cooling water and/or recirculating cooling tower blowdown, fuel storage runoff, boiler feedwater treatment wastes, boiler blowdown, and other low-volume wastes [CEPA 2006a; CEPA, 2006b; U.S. DOE, 2000a; IDNR, 2006a; Fairfax, 2006; U.S. EPA, 2006i; FDEP, 2006].

The types of solid alternative fuels included in EPA’s study of alternative-fueled steam electric plants are discussed below.

Municipal Solid Waste

Typical constituents of MSW include paper, paperboard, yard waste, plastics, metals, glass, food waste, wood, rubber, leather, and textiles. Refuse-derived fuel is produced from MSW through processing steps such as, at a minimum, coarse shredding of the MSW and magnetic separation of ferrous metals [Kirk-Othmer, 2000].

At the time of the initial 1974 Steam Electric Power Generating effluent guidelines, EPA identified one steam electric plant in the United States as using refuse-derived fuel for 10 percent of its fuel [U.S. EPA, 1974]. As shown in Table 7-1, there were 59 plants operating electric generating units powered by municipal solid waste in 2005 [U.S. DOE, 2005a]. The 1974 Development Document stated that incinerating “garbage” produces moderate amounts of hydrogen chloride, and that EPA should continue to study the disposal of the effluents from steam electric plants using these alternative fuels.

During the detailed study, EPA obtained data on the pollutant concentrations found in MSW ash, wood ash, and coal ash. Although the compositions of these ashes vary significantly depending on the type of material that is combusted and the location that the ash is sampled (e.g., fly ash, bottom ash), EPA noted general differences between MSW ash and coal ash. Table 7-2 presents the range of concentrations associated with both the bottom and fly ash generated from coal ash, MSW ash, and wood ash (which is discussed below). As shown in Table 7-2, MSW ash can contain significantly higher amounts of barium, cadmium, mercury, molybdenum, nickel, selenium, and zinc than coal ash.

Table 7-2. Comparison of Available Coal Ash, Municipal Solid Waste Ash, and Wood Ash Composition Data

Component	Coal Ash (ppm)	Municipal Solid Waste Ash (ppm)	Wood Ash (ppm)
Aluminum	60,000 - 157,000	NIA	NIA
Antimony	NIA	NIA	9 - 11.58
Arsenic	10.4 - 169.6	2.9 - 50	1 - 28.5
Barium	210 - 310	79 - 2,700	130 - 527
Beryllium	NIA	ND - 2.4	ND - 2
Boron	14 - 618	24 - 174	1 - 16.9
Cadmium	7 - 10	0.18 - 100	1 - 16
Calcium	3,100 - 125,600	NIA	NIA
Chloride	NIA	NIA	382.35 – 3,200
Chromium (III)	NIA	NIA	43
Chromium (VI)	NIA	NIA	0.7 - 4
Chromium - Total	NIA	12 - 1,500	16.8 - 33.55
Cobalt	NIA	1.7 - 91	4.6 - 20
Copper	NIA	40 - 5,900	31.3 - 176.5
Cyanide	NIA	NIA	0.08 - 6

Table 7-2. Comparison of Available Coal Ash, Municipal Solid Waste Ash, and Wood Ash Composition Data

Component	Coal Ash (ppm)	Municipal Solid Waste Ash (ppm)	Wood Ash (ppm)
Iron	3,000 - 163,000	NIA	NIA
Lead	NIA	31 - 36,600	7.7 - 142.5
Magnesium	900 - 60,200	700 - 16,000	NIA
Manganese	NIA	14 - 3,130	NIA
Mercury	ND - 0.08	0.05 - 17.5	ND - 0.6
Molybdenum	5.6 - 39.3	2.4 - 290	3.0 - 14
Nickel	123 - 242	13 - 12,910	11 - 50
Phosphorus	300 - 2,800	NIA	NIA
Potassium	6,500 - 31,900	NIA	23,220 - 59,918
Selenium	7.6 - 36.1	0.1 - 50	ND - 20
Silicon	302,000 - 331,000	NIA	NIA
Silver	NIA	NIA	ND - 4
Sodium	560 - 1,200	NIA	934.25 - 3,110
Strontium	NIA	12 - 640	NIA
Thallium	NIA	NIA	ND - 70.5
Titanium	7,700 - 11,600	NIA	NIA
Vanadium	NIA	NIA	22 - 27
Zinc	13 - 378	92 - 46,000	130 - 886

Source: [Evangelou, 1996; Otero-Rey, 2003; Narukawa, 2003; Kirk-Othmer, 2000; CEPA, 2006b; WAI, 2003].

ND - Not detected.

NIA – No information available.

To obtain additional information about the process operations and wastewaters generated from MSW plants, EPA reviewed EIA information and contacted two companies that operate MSW plants. According to information EPA obtained from EIA and these two companies, most of these plants operate dry FGD systems and baghouses or ESPs to remove the fly ash, sulfur dioxide, hydrogen chloride, and hydrogen fluoride from the flue gas. At these plants, the particulates collected in the baghouse or ESP are handled dry and transported to a landfill. The bottom ash aggregate generated in the boiler is quenched in a water bath, which is drained, and the quenched aggregate then goes through the metal recovery process and is transported to a landfill. The water that drains off of the bottom ash is reused in the water bath. Therefore, most of these plants do not generate and/or discharge FGD or ash transport water waste streams. Additionally, some of the other wastewaters generated during the process (e.g., boiler blowdown, cooling tower blowdown, low-volume wastewaters) are often reused as make-up water for the bottom ash quench process or discharged indirectly to municipal wastewater treatment plants. Therefore, it appears these MSW plants may discharge fewer, if any, wastewater streams directly to surface waters than plants regulated by the Steam Electric Power Generating effluent guidelines [Covanta, 2009; Xcel Energy, 2009c; Xcel Energy, 2009d].

Wood Solid Waste

Wood wastes combusted in steam electric processes typically consist of chipped lumber and residuals from sawmills or other forest industry operations, including bark, trim ends, sawdust, and planer shavings [Kirk-Othmer, 2000].

EPA obtained data on the pollutant concentrations found in wood ash, which is presented in Table 7-2. As with MSW ash, EPA noted general differences between wood ash and coal ash. Wood ash generally has a lower metal content (e.g., arsenic, boron, molybdenum, nickel, and selenium) than coal ash; however, as shown in Table 7-2, wood ash often contains higher amounts of potassium and zinc, and may contain slightly higher amounts of barium, cadmium, and mercury, than coal ash.

To obtain additional information about the process operations and wastewaters generated from wood solid waste plants, EPA contacted two companies that operate these types of plants. According to information EPA obtained from the two companies, some of these plants operate dry FGD systems and baghouses. However, not all of the plants operate a dry FGD system; some just operate the baghouse. These systems remove the fly ash, sulfur dioxide, and hydrogen chloride from the flue gas. The particulates that collect in the baghouse are handled dry and transported to a landfill or beneficially reused. The bottom ash is typically handled dry, but if it is handled wet, the water is drained from the solids and reused in the process. Therefore, these types of plants do not generate and/or discharge any FGD or ash transport water waste streams. The wastewaters that are typically discharged from these plants, indirectly to municipal wastewater treatment plants in some cases, consist of cooling tower blowdown, boiler blowdown, wash waters associated with operation areas, and other low-volume wastewaters [Xcel Energy, 2009a; Xcel Energy, 2009b; U.S. Renewables Group, 2009].

Agricultural By-Products

Typical types of agricultural by-products combusted in steam electric processes include bagasse (plant residue) from sugar-refining operations, rice hulls, orchard and vineyard prunings, cotton gin trash, and the by-products of many other food and fiber-producing operations. Agricultural wastes are relatively low in metals content, and the ash often contains a lower metals content than coal and wood ash [Kirk-Othmer, 2000].

Tires

Scrap tires can be combusted in steam electric processes either in shredded form, which is known as tire-derived fuel, or as whole tires. Scrap tires, which have a high heating value, are often used as a supplement to other fuels, such as coal or wood. Tires produce roughly the same amount of energy as oil and roughly 25 percent more energy than coal, by weight. The ash residues from tire-derived fuel may contain lower heavy metals content than some coals [U.S. EPA, 2006i].

7.1.2.2 Gaseous Fuels

Steam electric plants fueled by gaseous alternative fuels (e.g., landfill gas) use a similar process as those plants that are fueled by natural gas or other gases and are currently regulated under the Steam Electric Power Generating effluent guidelines. These alternative-fueled steam

electric plants combust a gaseous fuel in a boiler to produce steam, which powers a steam turbine/electric generator; however, like the natural gas combustion process, the gaseous alternative fuel combustion process does not generate ash. The steam exiting the turbine is condensed with cooling water and the condensate is typically fed back to the boiler. Thus, steam electric plants fueled by gaseous alternative fuels generate some of the same types of wastewaters as those currently regulated under the Steam Electric Power Generating effluent guidelines and described in Section 3.2.1 (e.g., boiler blowdown, cooling tower blowdown, low-volume wastewaters).

Landfill gas, by volume, consists of approximately 50 percent methane and 50 percent carbon dioxide. It also contains small amounts of nitrogen, oxygen, and hydrogen, less than 1 percent nonmethane organic compounds, and trace amounts of inorganic compounds. The gas is generated in landfills as bacteria degrade organic matter. This gas mixture can be captured and processed for use as fuel in steam electric plants. During processing, a portion of the nonmethane components is typically removed from landfill gas, which results in a fuel with a higher heating value [U.S. EPA, 2006g; CEC, 2006]. A steam electric plant fueled with landfill gas is similar to a steam electric plant fueled with natural gas in terms of fuel composition (natural gas and landfill gas are both composed primarily of methane) and overall process [PDEP, 2006]. Because these gaseous fuel operations do not generate wastewaters that contact the fuel or fuel wastes like the solid-fueled plants, these plants typically only generate wastewaters such as boiler blowdown, cooling water, and other low-volume wastewaters. These wastewaters generally are expected to have similar characteristics as the wastewaters generated from the plants regulated under the Steam Electric Power Generating effluent guidelines.

7.1.2.3 Geothermal

In the geothermal steam electric process, geothermal fluids (typically steam) are extracted from geothermal reservoirs and are used to power steam turbine/electric generators. No fuels are combusted to produce steam. Steam exiting the turbines is condensed with cooling water and the condensate is injected into the geothermal reservoir. Geothermal steam electric plants generate steam condensate wastewater and condenser cooling wastes (typically cooling tower blowdown) [CEPA, 2006d].

EPA addressed geothermal electric generation in developing both the 1974 and 1982 Steam Electric Power Generating effluent guidelines. The 1982 Development Document states that geothermal fluids are disposed of by reinjection to the subsurface geothermal reservoir after use [U.S. EPA, 1982]. Permit writers confirmed this statement, indicating that geothermal steam electric plants do not typically have NPDES permits because they do not discharge their wastewater to surface waters [CEPA, 2006d; CEPA, 2006c]. These plants inject wastewater underground into the geothermal steamfield reservoirs for two major reasons [CEPA, 2006d; CEPA, 2006c; U.S. DOE, 2006a]. First, injecting water into the steamfield reservoirs is required to maintain steam production [CEPA, 2006d; U.S. DOE, 2006a]. Second, the geothermal steam condensate from the steam electric generating process contains high levels of salts and metals, specifically arsenic and boron, which would be costly to remove to meet limits for discharges to surface waters [CEPA, 2006d; CEPA, 2006c].

7.1.2.4 Solar

Solar electric generating plants concentrate sunlight onto receivers using various reflecting devices. Heat transfer fluid is heated as it flows through the receivers and is used to create steam, which, in turn, is used to create electricity in steam turbines/generators. Most solar electric plants that use parabolic trough reflectors to concentrate sunlight (such as the Solar Electric Generating Stations plants in the Mojave Desert, CA) generate cooling water, boiler blowdown, and demineralizer wastewater. These wastewaters are typically transferred to an evaporation pond and are not discharged to surface waters [IEEE, 1989]. Many solar electric plants burn natural gas when necessary to meet electrical demands [IEEE, 1989; Kirk-Othmer, 2000].

According to the 1982 Development Document, all solar electric generating plants at that time were developmental; however, EPA acknowledged that more systems would be developed in the future as traditional fossil fuels were depleted [U.S. EPA, 1982]. Since 1982, the solar power technologies have advanced and the 2005 EIA database includes nine solar-powered plants (see Table 7-1) [U.S. DOE, 2005a].

7.1.3 Summary of NPDES Permit Review

During the detailed study, EPA obtained NPDES permits for 13 alternative-fueled plants. EPA obtained at least one permit for each of the fuels discussed in Section 7.1.2, except solar. EPA reviewed the permits to determine the types of wastewaters generated by the plants and how the wastewaters were being permitted.

Based on the limited number of permits reviewed and communications with permitting authorities, EPA was not able to determine any trends in the regulation of wastewaters based on alternative fuel type; however, EPA was able to make some general observations about the types of wastewaters generated at these operations and determine some general trends in the way the wastewaters are regulated.

EPA found that some of the permits reviewed contained relatively few limits based on the Steam Electric Power Generating effluent guidelines. In each of these cases, the process wastewaters are not discharged directly to surface waters, whereas direct discharge of these wastewaters is the typical practice for plants regulated under the Steam Electric Power Generating effluent guidelines. Specific examples include geothermal electric wastewaters that are reinjected into underground geothermal reservoirs, agricultural-by-product-fueled steam electric wastewaters that are discharged to percolation ponds (these are permitted via state groundwater monitoring program), and other process wastewaters from indirect dischargers (these are usually permitted under a separate state program, not the NPDES program).

In most cases for direct dischargers, permit writers established limitations using BPJ. The bases used for these BPJ limits vary and may include the Steam Electric Power Generating effluent guidelines, more stringent state water quality standards, or general permitting requirements. Most parameters limited appear to have been selected based on state water quality standards.

A small portion of the permits wholly incorporate the requirements of the Steam Electric Power Generating effluent guidelines. These permits are unique in that the plants use a fossil fuel

in addition to the alternative fuel to generate electricity, or the permit only specifies the use of a fossil fuel. In at least one of these cases, the fossil-fueled steam electric wastewaters have separate limits than the alternative-fueled steam electric wastewaters.

7.2 **Industrial Non-Utilities**

This section describes EPA’s review of plants within various industrial sectors operating steam electric generators that produce electricity and/or thermal output primarily to support the activities performed at the plant. These *industrial non-utilities* include cogenerators²⁶, small power plants, and other non-utility generators, and generally do not produce electric power for distribution and/or sale.

EPA reviewed NPDES permits for a prioritized subset of industrial non-utilities to identify sources of wastewater generated from steam electric processes and determine how the wastewater discharges from these operations are currently regulated (e.g., whether the Steam Electric Power Generating effluent guidelines are applied as BPJ). Additionally, EPA contacted several companies operating electric generating units at their industrial plants to discuss the operations and wastewaters generated from the plant related to steam or electricity production.

The steam electric generating process used at industrial non-utilities is similar to that used by all steam electric plants, as described in Section 3.2. A boiler or Heat Recovery Steam Generator (HRSG) is used to generate steam that is in turn used (at least in part) to drive an electric generator or turbine. Finally, the steam is condensed through noncontact cooling before it is returned to the boiler. Additionally, some of the steam generated may be used by the plant for other process operations. Since the processes are similar, EPA expects that industrial non-utilities generate wastewater from the same sources as do steam electric plants regulated under the Steam Electric Power Generating effluent guidelines.

Wastewater generated by the steam electric processes at industrial non-utilities is not currently regulated by the Steam Electric Power Generating effluent guidelines, because the plants are not “...primarily engaged in the generation of electricity for distribution and sale...” With the exception of certain instances (e.g., certain subcategories of the Pulp, Paper and Paperboard effluent guidelines; see 40 CFR Part 430.01(m)), steam electric wastewaters from industrial non-utilities are not directly regulated by effluent guidelines. Information that EPA obtained during the detailed study indicate that industrial plants operating steam electric generating units use a similar process as those plants currently regulated under the Steam Electric Power Generating effluent guidelines. These industrial plants use both fossil and non-fossil fuels to generate the steam to drive the turbines.

The electric generating units at industrial facilities are typically smaller than those at plants regulated under the Steam Electric Power Generating effluent guidelines. Additionally, the industrial non-utilities burning coal as the primary fuel source typically burn significantly less coal than the coal-fired steam electric plants regulated under the Steam Electric Power Generating effluent guidelines. Because industrial non-utilities tend to be smaller in terms of electric power production and coal usage, the relative volume of wastewater discharged by these

²⁶ A *cogenerator* is defined as “a generating plant that produces electricity and another form of useful thermal energy (such as heat or steam), used for industrial, commercial, heating, or cooling purposes” [U.S. DOE, 2006b].

plants associated with electricity generation is likely to be less than that discharged by steam electric plants regulated under the Steam Electric Power Generating effluent guidelines.

The information collected during the detailed study indicates that most industrial plants commingle the wastewaters associated with the electric generating units with the other plant process wastewaters. Because the wastewaters are commingled, they may be treated in the plant's wastewater treatment system. These commingled wastewaters typically have permit limits based on the industry-specific effluent guidelines; the Steam Electric Power Generating effluent guidelines limits are typically not used to set BPJ-based limits.

7.2.1 Overview of Industrial Non-Utilities

EPA identified industrial non-utilities for this detailed study through data collected in 2005 by EIA. Industrial plants that operate an electric power generator having at least one MW of electric generating capacity report to EIA each year. Included in these data is the plant's primary NAICS code. EPA identified industrial non-utilities in the 2005 EIA data as those reporting NAICS codes other than 22 – Utilities.

EPA examined the 2005 EIA data to determine the relative size of electric generating units at industrial non-utilities, as well as the types of fuels used by industrial non-utilities to generate the steam. EPA also performed a more detailed analysis of the EIA data for the subset of industrial non-utilities that use fossil fuels to power a steam generator. Section 7.2.2 summarizes the available demographic data for fossil-fueled, steam electric industrial non-utilities.

According to the 2005 EIA data, there are 855 industrial non-utilities, most of which (over 75 percent) produce a relatively small amount of electric power (no more than 50 MW per plant) [U.S. DOE, 2005a]. These 855 industrial non-utilities include plants operating both steam and non-steam generating units (e.g., stand-alone combustion turbines, internal combustion engines, and hydraulic turbines) powered by either fossil or non-fossil fuel types. No nuclear-powered industrial non-utilities were reported to EIA in 2005.

For comparison, only 10 percent of steam electric plants regulated under the Steam Electric Power Generating effluent guidelines each produce less than 50 MW of electricity. In fact, nearly half of the Part 423 steam electric plants each generate more than 500 MW of electric power [U.S. DOE, 2005a]. Section 3.1.2.2 contains additional information on steam electric plants regulated under the Steam Electric Power Generating effluent guidelines.

Industrial non-utilities may be fueled either by a fossil fuel (e.g., coal, oil, or natural gas) or an alternative, non-fossil fuel. The fuels used by these industrial non-utilities are often derived from a by-product of the primary industrial process. These non-utilities may also use a combination of fossil and non-fossil fuels to power the steam electric generating unit. No industrial non-utilities were found to use nuclear fuels [U.S. DOE, 2005a].

The following non-fossil fuels were reported to EIA by industrial non-utilities as the primary fuel for the steam electric generating unit:

- Agricultural Crop By-Products, Straw, Energy Crops;
- Black Liquor;

- Municipal Solid Waste;
- Other Biomass Gases (e.g., digester gas, methane);
- Other Biomass Solids (e.g., animal manure and waste, solid by-products);
- Other Fuels (e.g., batteries, chemicals, coke breeze, hydrogen, pitch, sulfur, tar coal);
- Wood Waste Liquids (e.g., red liquor, sludge wood, spent sulfite liquor); and
- Wood and Wood Waste Solids (e.g., paper pellets, railroad ties, utility poles, wood chips).

In 2005, 160 steam electric industrial non-utilities reported using at least one of these non-fossil fuel types. Among these non-fossil fuel types, black liquor and wood and wood waste solids were the most prevalently used primary fuels for steam electric power generation by industrial non-utilities [U.S. DOE, 2005a].

As previously mentioned, it is not uncommon for an industrial non-utility to use more than one type of fuel; in fact, these plants often will use a combination of fossil and non-fossil fuels to power the same steam electric generating unit. For example, several industrial non-utilities that reported using natural gas as the primary fuel also reported using black liquor and other gases as alternates, as did several coal-burning industrial non-utilities. In addition, several of the 160 primarily non-fossil-fueled industrial non-utilities reported using coal, oil, or natural gas as alternate fuels for the steam electric generating unit [U.S. DOE, 2005a].

7.2.2 Demographic Data for Fossil-Fueled Industrial Non-Utilities

EPA identified industrial non-utilities through data collected in 2005 by EIA for plants reporting a primary NAICS code other than 22 – Utilities²⁷. Similar to the analysis of the steam electric plants regulated by the Steam Electric Power Generating effluent guidelines described in Section 3.1.2.2, EPA used the NAICS code, prime mover, and energy source information reported in Form EIA-860 to develop a demographic profile for steam electric industrial non-utilities. EPA identified the subset of industrial non-utilities in the EIA database that are fossil-fueled steam electric as those operating at least one prime mover that utilizes steam, produced by burning a fossil fuel, to generate electricity.

Using the criteria for the prime mover type and fossil fuel described above for plants reporting a primary purpose/NAICS code other than 22, EPA estimates that 314 fossil-fueled, steam-electric, industrial non-utilities reported to EIA in 2005. These plants are estimated to operate 813 stand-alone steam generators or combined cycle systems²⁸, which have a total steam or combined cycle turbine electric generating capacity of 19,393 MW²⁹ [U.S. DOE, 2005a]. The total steam or combined cycle turbine electric generating capacity for all industrial non-utilities, including non-fossil fuels, is 25,512 MW [U.S. DOE, 2005a]; therefore, 76 percent of the

²⁷ Additionally, EPA identified 14 plants reporting a NAICS code of 22 that are, in fact, industrial non-utilities. For the analyses presented in this report, these 14 plants were placed in the appropriate industrial category and were not included in the steam electric industry analyses presented in Section 3.1.

²⁸ Refer to Section 3.2.9 for a description of the combined cycle system of electric power generation.

²⁹ The total steam or combined cycle electric generating capacity includes capacity associated with stand-alone steam turbines, combined cycle steam turbines, combined cycle single shaft turbines, and combined cycle combustion turbines.

industrial non-utility capacity is associated with fossil fuels. The industrial non-utility steam turbine electric generating capacity, including fossil and non-fossil fuels, is less than four percent³⁰ of the electricity produced by the steam electric industry regulated under the Steam Electric Power Generating effluent guidelines.

Because not all of the steam generated by industrial non-utilities is necessarily used to generate electricity, EPA compared the amount of coal burned by the coal-fired industrial non-utilities to the amount of coal burned by coal-fired steam electric plants regulated under the Steam Electric Power Generating effluent guidelines. According to 2005 EIA information, the average amount of coal burned by an industrial non-utility is 318,000 tons per year (median is 182,000 tons) and the average amount of coal burned by a steam electric plant regulated under the Steam Electric Power Generating effluent guidelines is 2,155,000 tons per year (median is 1,221,000 tons) [U.S. DOE, 2005b]. Based on these numbers, EPA expects that the amount of wastewater generated by the industrial non-utilities associated with the steam electric process operations is substantially less than that generated by steam electric plants regulated under the Steam Electric Power Generating effluent guidelines.

Table 7-3 summarizes the industries that reported industrial non-utilities to EIA in 2005, the number of plants, and the number of fossil fuel-burning steam electric generating units. The top five industries reporting operation of steam electric generating units, ranked by steam electric generating capacity include:

- Chemical Manufacturing;
- Paper Manufacturing;
- Petroleum and Coal Products Manufacturing;
- Primary Metal Manufacturing; and
- Food Manufacturing [U.S. DOE, 2005a].

The top five industries comprise an estimated 221 non-utilities operating 575 steam or combined cycle generating units and producing 16,963 MW of electric power (87 percent of the steam electric generating capacity of all fossil-fueled, steam-electric industrial non-utilities reported to EIA) [U.S. DOE, 2005a]. The remainder of this section presents more detailed demographic information for these five industries.

³⁰ EPA estimates that the total steam electric generating capacity of the steam electric industry regulated under the Steam Electric Power Generating effluent guidelines in 2005 was 762,386 MW (refer to Section 3.1.4.2) [U.S. DOE, 2005a].

Table 7-3. Summary of Fossil-Fueled, Steam Electric Industrial Non-Utilities, by NAICS Code in 2005

NAICS Code - Description	Number of Plants	Number of Electric Generating Units ^a	Total Steam and Combined Cycle Turbine Electric Generating Capacity (MW) ^b
Fossil-Fueled and Nuclear Steam Electric Plants Regulated Under 40 CFR Part 423			
22 – Utilities	1,187	2,557	762,386
Fossil-Fueled Steam Electric Industrial Non-Utilities			
325 - Chemical Manufacturing	55	129	7,535
322 - Paper Manufacturing	81	169	3,348
324 - Petroleum and Coal Products Manufacturing	29	69	2,571
331 - Primary Metal Manufacturing	18	53	2,383
311 - Food Manufacturing	38	80	1,127
Total for Top 5 Industries, by Capacity (Percentage of Total Fossil-Fueled Industrial Non-Utilities)	221 (70%)	500 (71%)	16,963 (87%)
611 - Educational Services	33	75	770
314 - Textile Product Mills	6	15	325
211 - Oil and Gas Extraction	8	12	261
212 - Mining (Except Oil and Gas)	3	6	238
3345 - Navigational, Measurement, Electromedical, and Control Instruments Manufacturing	1	11	200
92 - Public Administration	5	15	96
339 - Miscellaneous Manufacturing	2	8	90.7
327 - Nonmetallic Mineral Product Manufacturing	4	10	83.3
622 - Hospitals	9	16	83.2
336 - Transportation Equipment Manufacturing	2	4	64.5
221 - Utilities ^c	3	7	43.9
326 - Plastics and Rubber Products Manufacturing	1	4	40
481 - Air Transportation	1	1	31
333 - Machinery Manufacturing	2	7	24
3122 - Tobacco Manufacturing	2	3	20.6
321 - Wood Product Manufacturing	3	3	14.8
332 - Fabricated Metal Product Manufacturing	1	2	12.5
521 - Monetary Authorities - Central Bank	1	2	12
814 - Private Households	1	1	6
514 - Information Services and Data Processing Services	1	1	4.7
482 - Rail Transportation	1	2	4
561 - Administrative and Support Services	1	1	2.3

Table 7-3. Summary of Fossil-Fueled, Steam Electric Industrial Non-Utilities, by NAICS Code in 2005

NAICS Code - Description	Number of Plants	Number of Electric Generating Units ^a	Total Steam and Combined Cycle Turbine Electric Generating Capacity (MW) ^b
624 - Social Assistance	1	2	2
562212 - Solid Waste Landfill	1	1	1
Total Fossil-Fueled Industrial Non-Utilities	314	709	19,393

Source: [U.S. DOE, 2005a].

a – The number of electric generating units represents the number of stand-alone steam turbines and the estimated number of combined cycle systems. EPA estimated the number of combined cycle systems by adding the number of combined cycle steam turbines and the number of combined cycle single shaft turbines. Typically there are multiple combustion turbines to a single steam turbine in a combined cycle system; therefore, EPA believes this methodology is a better representation of the number of combined cycle systems than simply adding the number of combined cycle combustion and steam turbines.

b – The table includes stand-alone steam turbines, combined cycle steam turbines, combined cycle single shaft turbines, and combined cycle combustion turbines.

c – Operations included in NAICS code 221 include natural gas distribution, water sewage and other systems, water supply and irrigation systems, and sewage treatment plants. Based on these descriptions, EPA believes that these plants should be treated as industrial non-utilities.

7.2.2.1 Prime Movers/Generating Units

Table 7-4 shows the distribution of the types of steam electric prime movers used by industrial non-utilities within each of the top five industries. The table presents the numbers of plants and electric generating units and capacities for each type of steam electric prime mover. Based on the 2005 EIA data, industrial non-utilities generate over half of their electricity (54 percent) through stand-alone steam turbines, which are also the most prevalent type of steam electric prime mover used by the regulated steam electric plants regulated under the Steam Electric Power Generating effluent guidelines.

The two exceptions to this among the top five industries are the chemical manufacturing and the petroleum and coal products manufacturing industries, which reported more electric generating capacity for combined cycle systems than stand-alone steam turbines in 2005 [U.S. DOE, 2005a]. Comments received on the preliminary 2006 effluent guidelines program plan from the American Petroleum Institute (API) indicate that most petroleum refineries use natural gas or residual gases from the refinery process to power a combustion turbine, the waste heat of which is used to produce steam either to generate additional electric power or to be used directly within the refining process [API, 2005]. According to API's description of petroleum refinery non-utilities, not only are these plants using combined cycle systems, but they are considered to be cogenerators (i.e., steam is produced both to power a generator and to use in other operations).

Table 7-4. Distribution of Prime Mover Types Among Fossil-Fueled, Steam Electric Industrial Non-Utilities

Steam Electric Prime Mover	Number of Plants ^a	Number of Electric Generating Units ^b	Total Steam and Combined Cycle Turbine Electric Generating Capacity (MW) ^c
All Industrial Non-utilities			
Stand-Alone Steam Turbine	264 (84%)	625 (88%)	10,378 (54%)
Combined Cycle System	102 (32%)	84 (12%)	9,015 (46%)
Total	314	709	19,393
NAICS 325 – Chemical Manufacturing			
Stand-Alone Steam Turbine	41	97	1,579
Combined Cycle System	28	32	5,955
Total	55	129	7,535
NAICS 322 – Paper Manufacturing			
Stand-Alone Steam Turbine	78	164	3,107
Combined Cycle System	8	5	241
Total	81	169	3,348
NAICS 324 – Petroleum and Coal Products Manufacturing			
Stand-Alone Steam Turbine	21	50	756
Combined Cycle System	18	19	1,815
Total	29	69	2,571
NAICS 331 – Primary Metal Manufacturing			
Stand-Alone Steam Turbine	18	53	2,383
Combined Cycle System	0	0	0
Total	18	53	2,383
NAICS 311 – Food Manufacturing			
Stand-Alone Steam Turbine	36	78	1,108
Combined Cycle System	4	2	18.7
Total	38	80	1,127

Source: [U.S. DOE, 2005a].

a – Because a single plant may operate multiple generating units of various types, the number of plants by prime mover type is not additive. The totals reflect the number of industrial non-utilities that are operating at least one steam electric generating unit powered by a fossil fuel.

b – The number of electric generating units represents the number of stand-alone steam turbines and the estimated number of combined cycle systems. EPA estimated the number of combined cycle systems by adding the number of combined cycle steam turbines and the number of combined cycle single shaft turbines. Typically there are multiple combustion turbines to a single steam turbine in a combined cycle system; therefore, EPA believes this methodology is a better representation of the number of combined cycle systems than simply adding the number of combined cycle combustion and steam turbines.

c – The table includes stand-alone steam turbines, combined cycle steam turbines, combined cycle single shaft turbines, and combined cycle combustion turbines.

7.2.2.2 Fossil Fuel Types

Table 7-5 shows the distribution of the fossil fuels used by industrial non-utilities by electric generating capacity, specifically broken out for the top five industries. The 2005 EIA data demonstrate that fossil-fueled industrial non-utilities generally use either coal or natural/other gas to fuel their steam electric generating units; however, some industries tend to use a particular type of fossil fuel more than other types of fuels. For example, most food manufacturing non-utilities reported using coal, while most petroleum and coal products manufacturing non-utilities reported using natural/other gas [U.S. DOE, 2005a]. These trends coincide with the predominant types of generators used in these industries (e.g., nearly all combined cycle systems are powered by natural/other gas).

Table 7-5. Distribution of Fuel Types Among Fossil-Fueled, Steam Electric Industrial Non-Utilities

Fossil Fuel ^a	Number of Plants ^b	Number of Electric Generating Units ^c	Total Steam and Combined Cycle Turbine Electric Generating Capacity (MW) ^d
All Fossil-Fueled Industrial Non-Utilities			
Coal:	132 (42%)	337 (48%)	6,651 (34%)
Anthracite Coal, Bituminous Coal (BIT)	104	275	5,077
Subbituminous Coal (SUB)	25	57	1,142
Lignite Coal (LIG)	2	4	365
Waste Coal (WC)	1	1	67
Petroleum Coke (PC)	4 (1%)	6 (1%)	197 (1%)
Oil:	29 (9%)	50 (7%)	395 (2%)
Residual Fuel Oil (RFO)	26	45	367
Distillate Fuel Oil (DFO)	2	4	20
Waste/Other Oil (WO)	1	1	8
Natural/Other Gas:	155 (49%)	316 (44%)	12,150 (63%)
Natural Gas (NG)	125	241	10,663
Blast Furnace Gas (BFG)	9	28	834
Other Gas (OG)	21	47	654
Total	314	709	19,393
NAICS 325 – Chemical Manufacturing			
Coal (BIT, LIG, and SUB)	18	56	1,116
Petroleum Coke (PC)	1	2	46
Oil (DFO and WO)	2	4	27
Natural/Other Gas (NG and OG)	35	67	6,346
Total	55	129	7,535

Table 7-5. Distribution of Fuel Types Among Fossil-Fueled, Steam Electric Industrial Non-Utilities

Fossil Fuel ^a	Number of Plants ^b	Number of Electric Generating Units ^c	Total Steam and Combined Cycle Turbine Electric Generating Capacity (MW) ^d
NAICS 322 – Paper Manufacturing			
Coal (BIT, SUB, and WC)	38	88	1,871
Petroleum Coke (PC)	1	2	90
Oil (RFO)	14	21	250
Natural/Other Gas (NG)	29	58	1,137
Total	81	169	3,348
NAICS 324 – Petroleum and Coal Products Manufacturing			
Petroleum Coke (PC)	2	2	61
Oil (RFO)	1	1	0.4
Natural/Other Gas (NG and OG)	27	66	2,509
Total	29	69	2,571
NAICS 331 – Primary Metal Manufacturing			
Coal (BIT, LIG and SUB)	5	12	1,410
Natural/Other Gas (BFG, NG, and OG)	13	41	973
Total	18	53	2,383
NAICS 311- Food Manufacturing			
Coal (BIT and SUB)	30	63	1,056
Oil (RFO)	1	2	8
Natural/Other Gas (NG)	7	15	63
Total	38	80	1,127

Source: [U.S. DOE, 2005a].

a – No steam electric generating units operated at industrial non-utilities were reported to use jet fuel, kerosene, coal synfuel, gaseous propane, or nuclear fuel in the 2005 EIA database.

b – Because a single plant may operate multiple generating units utilizing differing fuel types, the number of plants by fuel type is not additive. EPA estimates there are 314 industrial non-utilities operating at least one steam electric generating unit powered by a fossil fuel.

c – The number of electric generating units represents the number of stand-alone steam turbines and the estimated number of combined cycle systems. EPA estimated the number of combined cycle systems by adding the number of combined cycle steam turbines and the number of combined cycle single shaft turbines. Typically there are multiple combustion turbines to a single steam turbine in a combined cycle system; therefore, EPA believes this methodology is a better representation of the number of combined cycle systems than simply adding the number of combined cycle combustion and steam turbines.

d – The total steam electric generating capacity shown does not equal the sum of the steam electric capacities for each fuel type due to rounding errors. The table includes stand-alone steam turbines, combined cycle steam turbines, combined cycle single shaft turbines, and combined cycle combustion turbines.

7.2.3 Review of Industrial Non-Utility Discharge Permits

EPA reviewed NPDES permits for 28 industrial plants operating a steam electric industrial non-utility on site to determine the extent to which steam electric process wastewater is segregated from other process wastewaters and whether Steam Electric Power Generating effluent guidelines are applied to the wastewaters on the basis of BPJ. These plants use either a

fossil fuel or other non-fossil fuel to power the steam electric generating unit(s), and were identified within the following four industries:

- Chemical Manufacturing;
- Paper Manufacturing;
- Primary Metal Manufacturing; and
- Petroleum and Coal Products Manufacturing.

EPA found that the NPDES permits for the plants within these industries rarely provide enough detail about the plant waste streams to identify the steam electric process wastewaters; however, some permits generally described waste streams that could include the steam electric waste streams or waste streams from other on-site operations (e.g., “cooling water,” “boiler blowdown”). The final effluent wastewaters from industrial sites are commingled with all plant wastewater at the point of discharge, if not upstream; therefore, the steam electric wastewaters are typically commingled with the other plant wastewaters.

The 28 plants are covered by seven existing industrial point source effluent guidelines. EPA determined that wastewaters discharged from these industrial sites are often regulated only by the effluent guidelines for the primary industrial process (e.g., Organic Chemicals, Plastics, and Synthetic Fibers, Petroleum Refining). Rarely are the discharges associated with steam electricity generation limited specifically with the Steam Electric Power Generating effluent guidelines limits. Additionally, the Steam Electric Power Generating effluent guidelines limits are rarely used as a BPJ basis to regulate pollutants that may not be covered under the specific industrial effluent guideline.

EPA researched three of these seven existing effluent guidelines (i.e., Iron and Steel Manufacturing, Petroleum Refining, and Pulp, Paper & Paperboard Point Source Categories) to determine whether the waste streams from the steam electric operations were considered in developing the final effluent limitations. The Pulp, Paper & Paperboard effluent guidelines (40 CFR Part 430) specifically define Part 430-regulated process wastewater (in certain subparts) as including wastewaters generated by co-located non-utility power plants (see 40 CFR Part 430.01(m)).

Comments received on the preliminary 2006 effluent guidelines program plan from API stated that petroleum refinery steam electric generating units primarily generate wastewater from boiler and cooling tower blowdown and demineralizer streams that are typically permitted as low-contaminant streams (i.e., streams containing low concentrations of toxics, oxygen demand, and nonconventional pollutants). API also commented that these streams possess the same wastewater characteristics as the petroleum refining wastewater with which they are commingled prior to discharge [API, 2005]. On the preliminary 2008 effluent guidelines program plan, the American Chemistry Council provided similar comments stating that the wastewaters associated with the steam electric generating units are considered low-contaminant streams by permit writers and are controlled by BPJ-based limits [Walls, 2007]

While the Pulp, Paper, & Paperboard effluent guidelines were developed incorporating wastewaters from on-site steam electric power plants, this is not the case for all industrial effluent guidelines. For example, the Iron and Steel effluent guidelines (40 CFR Part 420) identify that wastewaters from the operation of steam electric generating units may be discharged

and are identified as non-process wastewaters; however, the effluent guideline does not set limits for these non-process wastewaters nor incorporate them into the effluent guideline limits.

In many cases, the primary industry effluent guidelines (or the permit for the industrial plant discharge) either does not address or contains a less stringent limit for the pollutants included in the Steam Electric Power Generating effluent guidelines. For example, the Pulp, Paper, & Paperboard effluent guidelines, which include wastewaters generated from on-site power plants, do not currently regulate chlorine discharges.

7.2.4 *Contacts with Industrial Non-Utilities*

As part of the detailed study, EPA contacted several companies that operate steam electric generating units colocated at their industrial plants. EPA contacted these companies to determine the types of fuels used, process operations, wastewaters generated, and the handling/treatment of the wastewaters associated with the operation of the steam electric generating units. EPA contacted at least one company in each of the top five industries, ranked by electric generating capacity.

From these contacts, EPA identified a primary metal manufacturer with steam electric generating units at one of its plants that operates similarly to some coal-fired power plants regulated under the Steam Electric Power Generating effluent guidelines. This non-utility operates four coal-fired units, each of which has a wet FGD system. The FGD scrubber purge is transferred to an ash pond for treatment, where it is commingled with fly ash transport and bottom ash transport waters. The ash pond does not receive any wastewater associated with the other plant operations. The ash pond effluent is discharged to surface water and this discharge is required to comply with the Steam Electric Power Generating effluent guidelines limits [Alcoa, 2009].

The food manufacturing company that EPA contacted operates eight plants with coal-fired electric generating units. EPA only discussed the operation of one of the plants with the company; however, the contact stated that the operations at the other seven plants are similar. The plant discussed does not operate any wet FGD systems. Additionally, both the bottom ash and fly ash are collected using dry handling practices. The cooling tower blowdown generated by the steam electric process is commingled with the plant's sanitary wastewaters and transferred to a publicly owned treatment works [ADM, 2009].

The paper manufacturing company that EPA contacted operates electric generating units powered by several different types of fuels. One of the most common types of fuels used is black liquor, which is a by-product of the pulping process. The company also burns coal, wood wastes, tires, and other solid fuels. The company has over 20 paper mills that operate steam electric generating units, and the operations at these mills differ by site. According to the contact, the company does not operate any wet FGD systems; however, it does operate a few dry FGD systems. The company operates a mixture of wet and dry ash handling systems, and some of the mills operate ash ponds to treat the fly and/or bottom ash transport waters. The other types of wastewaters generated by the steam electric generating operations consist of boiler blowdown, cooling water, and process area wash waters. All these wastewaters are commingled with the other mill wastewaters and treated in a pond or clarifier followed by an aerated stabilization basin, some of which have activated sludge treatment [International Paper, 2009].

The petroleum refining company that EPA contacted operates three refineries that have electric generating units on site. These units burn gases that are by-products of the industrial operations. The flue gas generated from the electric generating units is combined with the other gases in the plant operations and treated with those gases. The wastewaters generated from the steam electric generating units are cooling tower blowdown, boiler blowdown, and process area wash waters. These wastewaters are treated in the plants' wastewater treatment systems, which typically consist of oil/water separators, an activated sludge biological systems, and clarifiers [Valero, 2009].

The chemical manufacturing company that EPA contacted operates two plants that have coal-fired electric generating units on site. One of the plants is only capable of burning coal, while the other can use oil as a secondary fuel. Both plants generate steam primarily for the plants' process operations and not for generating electricity (i.e., one plant uses 10 percent of the steam generated to produce electricity and the other uses 16 percent of the steam to produce electricity). Neither of the plants operates a FGD systems for sulfur dioxide control. Both plants operate dry fly ash handling systems. One plant operates a dry bottom ash handling system and the other operates a wet system and trucks the wet bottom ash to a sand filter and the filtrate is transferred to the plant's wastewater treatment facility. Both plants generate coal pile runoff, boiler blowdown, and cooling tower blowdown waste streams. The coal pile runoff is sent through a settling treatment system prior to discharge. The boiler blowdown and cooling tower blowdown are discharged directly by one of the plants; the other plant treats the wastes in a settling pond prior to discharge [Vasavada, 2009].

7.3 Steam and Air Conditioning Supply Plants

As part of the detailed study, EPA reviewed data from other industry segments that may have similar operations to steam electric plants, but are not currently subject to the Steam Electric Power Generating effluent guidelines. These industry segments include plants within SIC Code 4939 (Combination utilities, not elsewhere classified), discussed further in Section 7.4, and SIC Code 4961 (Steam and air conditioning supply), discussed in this section. EPA reviewed available discharge data from plants within these SIC codes to determine if these plants have operations and wastewater characteristics similar to those in the Steam Electric Power Generating Point Source Category.

This section discusses steam and air conditioning supply plants and the findings of EPA's examination of the processes and wastewaters generated by their operation. According to the 2002 Economic Census, 63 establishments were engaged in steam and air conditioning supply³¹ in the United States in 2002 [USCB, 2002]. Types of plants within the Steam and Air Conditioning Supply sector include the following:

- Air conditioning supply services;
- Cooled air suppliers;
- Distribution of cooled air;
- Chilled water suppliers;
- Geothermal steam production;

³¹ The 2002 Economic Census is based on the North American Industrial Classification System (NAICS). The NAICS code for steam and air conditioning supply (22133) corresponds directly to SIC code 4961.

- Steam heating systems (suppliers of heat); and
- Steam supply systems, including geothermal.

Many of these plants combust fossil fuels in a boiler to generate steam, which is similar to the operation at steam electric plants regulated under the Steam Electric Power Generating effluent guidelines; however, the primary purpose of this steam is not electricity generation. The steam generated from the process is typically distributed to off-site customers and, therefore, it does not power a steam turbine/electric generator.

Wastewater generated by these steam and air conditioning supply plants is not currently regulated by the Steam Electric effluent guidelines, because the plants are not “... engaged in the generation of electricity...”, as defined at 40 CFR Part 423.10. As part of the detailed study, EPA investigated steam and air conditioning supply plants and compared their processes and types of wastewaters generated to those of fossil-fueled plants currently regulated by the Steam Electric Power Generating effluent guidelines. EPA also compared the way the wastewater discharges are regulated for these plants to the plants subject to the Steam Electric Power Generating effluent guidelines.

Information that EPA obtained during the detailed study indicate that these steam and air conditioning supply plants generate similar types of wastewaters as steam electric plants regulated under the Steam Electric Power Generating effluent guidelines; however, most of the plants combust natural gas or oil and, therefore, do not generate the quantity of FGD and/or ash transport wastewaters that are generated by coal-fired power plants. EPA identified that some of the wastewater discharges contain similar pollutants to those discharged by steam electric plants. Additionally, some of the wastewaters from these plants are regulated using the Steam Electric Power Generating effluent guidelines as the basis for BPJ-derived limits. EPA also identified that there are relatively few of these plants in operation and most of them discharge a relatively small amount of wastewater compared to the steam electric plants regulated under the Steam Electric Power Generating effluent guidelines.

The remainder of this section summarizes data and information that were available for the Steam and Air Conditioning Supply sector during EPA’s study of this sector. EPA reviewed data for SIC code 4961 reported to PCS and ICIS-NPDES³². EPA also reviewed several permits and contacted three companies that operate steam supply plants to learn about the operations and wastewaters generated at these plants. These sources provided information about potential types of wastewater generated by steam supply plants, as well as the relative number of these plants that are likely to generate and discharge wastewater.

³² In 2007, some states’ discharge monitoring report (DMR) data were reported to the PCS database, while the remaining states reported DMR data to the Integrated Compliance Information System – National Pollutant Discharge Elimination System (ICIS-NPDES) database.

7.3.1 Wastewater Discharge Characterization Data

EPA extracted effluent monitoring data reported to PCS and ICIS-NPDES in 2007 for plants within SIC code 4961. Table 7-6 summarizes the data extracted for these plants along with their calculated total TWPE, which is a loading that accounts for the toxicity of the pollutants discharged. The *Technical Support Document for the Annual Review of Existing Effluent Guidelines and Identification of Potential New Point Source Categories* [U.S. EPA, 2009c], discusses EPA's method of calculating TWPE. EPA in particular identified whether these operations reported discharges of chlorine, total residual oxidants (TRO), chlorine-produced oxidants (CPO), or metals, which are pollutants typically discharged from steam electric plants regulated under the Steam Electric Power Generating effluent guidelines.

Table 7-6 also indicates whether the plants are classified as “major” or “minor” dischargers. To provide an initial framework for setting permit issuance priorities, EPA developed a major/minor classification system for industrial and municipal wastewater dischargers. Each permitting authority establishes its own definitions, but major dischargers almost always have the capability to impact receiving waters if not controlled and, therefore, have been accorded more regulatory attention than minor dischargers. Plants are classified as major based on an assessment of six characteristics: (1) toxic pollutant potential; (2) flow/stream flow volume; (3) conventional pollutant loading; (4) public health impact; (5) water quality factors; and (6) proximity to coastal waters. Facilities with major discharges must report compliance with NPDES permit limits via monthly Discharge Monitoring Reports (DMRs) submitted to the permitting authority. Minor discharges may, or may not, adversely impact receiving water if not controlled. The *DMRLoads2007* database includes data only for a limited set of minor dischargers when the states choose to include these data. As shown in Table 7-6, the 2007 PCS and ICIS-NPDES contain data for 46 steam and air conditioning supply plants, 42 of which are classified as minor dischargers [U.S. EPA, 2009b]. This suggests that steam and air conditioning supply plants may discharge relatively small volumes of wastewater and/or pollutants.

7.3.2 NPDES Permit Review

In researching the operations, waste streams, and existing discharge requirements currently applied to steam and air conditioning supply wastewaters, EPA reviewed NPDES permits for four steam and air conditioning supply plants (plants identified with bolded text in Table 7-6). All four plants generate steam; however, none use the steam to generate electricity. Some of the plants produce chilled water in addition to steam. The five plants generate wastewaters that are similar to those of steam electric plants regulated under the Steam Electric Power Generating effluent guidelines, including boiler blowdown, coal pile runoff, and cooling tower blowdown; however, the cooling water waste streams and cooling tower blowdown listed in the permits could be associated with the chilled water production process.

Table 7-6. Steam and Air-Conditioning Supply Plants Identified in *DMRLoads2007* Database

NIDD	Name	City	Type of Discharger	Monitoring Data in Database?	Total TWPE^a	CI/TRO/CPO Discharged^b	Metals Discharged
AL0052400	Powell Avenue Steam Plant	Birmingham	Minor	Y	NA	CI	
CA0029106	GAFF Power Systems-Site I	Pittsburg	Minor	N	NA		
CA0029122	GAFF Power Systems-Site V	Pittsburg	Minor	N	NA		
CA0082406	Alturas High School Geothermal	Alturas	Minor	N	NA		
CA8000015	San Bernardino Geothermal Facility	San Bernardino	Minor	N	NA		
CO0043427	Thermal Energy Distribution	Denver County	Minor	N	NA		
CT0004014	Hartford Steam Company	Hartford	Major	Y	4,645	CI	Fe, Pb, Zn, Cu
DC0000035	GSA - (West Heating Plant)	Washington	Minor	Y	NA		
ID0025488	Boise, City Of	Boise	Minor	N	NA		
IL0001368	MED Thermal Technologies Inc	Chicago	Minor	Y	NA		
IL0037613	MED Thermal Technologies-Pl. #5	Chicago	Minor	Y	NA	CI	
IL0072320	SIC Physical Plant, SUIT	Carbondale	Minor	Y	NA		Fe
IL0073741	Metro Pier & Expo Authority	Chicago	Minor	Y	NA		
IN0004677	Citizens Thermal Energy	Indianapolis	Minor	Y	NA	CI	
MD0001554	Trigged-Baltimore Energy Corp	Baltimore	Minor	N	NA		
MD0061930	Trigged-Energy Baltimore – SPRY	Baltimore	Minor	Y	NA	CI	Cu
MD0065986	Housing Authority of Baltimore	Baltimore	Minor	N	NA		
MD0066249	Trigged-Baltimore Energy Corp	Baltimore	Minor	N	NA		
MD0066877	Trigged-Energy Baltimore – SARA	Baltimore	Minor	Y	NA	CI	Cu
MN0054739	Energy Park Utility Co	Saint Paul	Minor	N	NA		
MN0055719	Duluth Steam Cooperative Assoc	Duluth	Minor	N	NA		
MN0056995	North Riverfront Plant	Minneapolis	Minor	N	NA		
MN0066559	Minnesota Power Rapids Energy	Grand Rapids	Minor	N	NA		
MO0004847	Trigged KC Dist. Energy CUR	Kansas City	Minor	Y	NA		
MO0099236	BASF Corp Agra Products	Palmyra	Minor	Y	NA		
MO0127825	University Of MO-Physical	Rolla	Minor	Y	NA		
MT0030651	Don Abbey Residence	Rollins	Minor	Y	NA		

Table 7-6. Steam and Air-Conditioning Supply Plants Identified in *DMRLoads2007* Database

NIDD	Name	City	Type of Discharger	Monitoring Data in Database?	Total TWPE^a	Cl/TRO/CPO Discharged^b	Metals Discharged
NJ0109673	Central Heat Plant Bldg 2401	New Hanover Twp	Major	Y	NA	CPO	
NY0005134	59th Street Steam Station	New York	Major	Y	NA		
NY0005151	Hudson Ave. Steam Plant	Brooklyn	Minor	Y	NA		
NY0005177	74th Street Steam Plant	New York	Major	Y	NA		
NY0227153	South Nassau Communities Hosp	Oceanside	Minor	N	NA		
NY0245097	Remington Arms Co, Inc	Ilion	Minor	Y	NA		Zn
OK0002461	Trigged - Tulsa Energy Corp	Tulsa	Minor	Y	NA	Cl	
PA0000493	Pittsburgh Allegheny County	Pittsburgh	Minor	N	NA		
PA0008427	NRG Energy Center Hag, Inc	Harrisburg	Minor	N	NA		
PA0239542	Impact PA Geothermal Well	Warren	Minor	N	NA		
PA0253235	Tarentum Senior Housing - Geothermal Well	Tarentum	Minor	N	NA		
SD0025569	Haakon School District No. 27-1	Philip	Minor	Y	NA		
SD0025798	St Joseph's Indian School	Chamberlain	Minor	Y	NA		
TX0008851	Texas Medical Center Central	Houston	Minor	Y	NA		
VA0032000	US Department Of Defense - Pentagon	Arlington	Minor	N	NA		
VA0091995	Reston Lake Anne Air Condition	Reston	Minor	N	NA		
WA0001503	Seattle Steam	Port of Seattle	Minor	Y	NA		
WI0038296	U W Madison Charter Street	Madison	Minor	N	NA		
WI0040282	WI University Milwaukee Power	Milwaukee	Minor	N	NA		

Source: [U.S. EPA, 2009b].

a – TWPE was not calculated for minor plants in the *DMRLoads2007* database.

b – Cl – Chlorine; TRO – Total residual oxidants; and CPO – Chlorine produced oxidants (EPA has not developed TWFs for TRO and CPO; therefore, these loads are not included in TWPE totals).

NA – Not available. The plant is either a minor discharger, in which case ERG does not calculate TWPE, or the plant did not report both concentration and flow data and/or the plant reported only parameters for which EPA has not developed a TWF (e.g., TSS, BOD₅).

Note: The rows with bold text in the table identify the plants for which EPA reviewed NPDES permits.

Some of the permits reviewed showed that the Steam Electric Power Generating effluent guidelines standards were used as the basis for BPJ limits, although not all of the steam electric regulated pollutants are necessarily included in the steam and air conditioning supplier permits. This shows that some permit writers feel the operations at these steam supply plants are similar enough to the operations at Part 423-regulated steam electric plants that the wastewaters may have similar characteristics and, therefore, should have the same effluent limitations.

Upon review of the permit for the Hartford Steam Company, EPA learned that, in addition to steam and chilled water production, the plant used to generate electricity with excess steam; however, the electricity generation portion of the process has been closed since 1995. The permit has retained the limits of the Steam Electric Power Generating effluent guidelines as the basis for the current wastewater discharge requirements. This plant continues to report significant discharges of chlorine, zinc, copper, and lead, which shows that the wastewaters from the steam and air conditioning supply operations are discharging chlorine and metals to surface waters.

7.3.3 *Contacts with Steam Supply Companies*

During the detailed study, EPA contacted three companies operating a total of 20 plants³³ to obtain information on the operations and wastewaters generated at steam supply plants. These steam supply plants typically provide steam for district heating and cooling purposes in large cities. Many steam supply plants provide chilled water and/or hot water in addition to providing steam. Some of the steam supply plants are providing electricity (i.e., they are cogeneration plants).

From communications with the companies, EPA found that the majority of the steam supply plants burn either oil or natural gas in their boilers. Because these fuels are generally low in sulfur, these plants do not operate FGD scrubbers. Steam supply plants that use natural gas as a fuel do not typically generate any ash or residual solid waste in their boilers and therefore do not generate any ash transport waters. Some of the oil-fired plants generate a small amount of ash that they remove from the boiler by periodic washes. One of the oil-fired plants transports its ash wastewater and/or ash sludge off site to a treatment, storage, and disposal facility.

In addition to ash transport waters that may be generated by oil-fired plants, typical wastewaters generated at natural gas or oil-fired steam supply plants are:

- Boiler blowdown;
- Cooling water;
- Demineralizer wastewater;
- Equipment drains and overflows; and
- Plants sumps.

According to one of the companies EPA contacted, the steam supply plants operated by the company neutralize the boiler blowdown and demineralizer wastewaters to meet the pH limits in their permits. Because most of the steam supply plants are located in large cities, they

³³ Of the 20 plants operated by the three steam supply companies, only seven were identified as steam supply plants reporting SIC code 4961 to PCS or ICIS-NPDES in 2007. The remaining 13 plants are identified either as combination utilities (SIC Code 4931) or steam electric generating plants.

do not operate treatment ponds due to limited space availability, but typically neutralize the boiler blowdown in large tanks [Consolidated Edison, 2009; Hartford Steam Company, 2009].

Of the 20 plants that were reviewed, only one plant reported using coal in their boilers. The plant burns a low-sulfur coal and therefore, does not operate a FGD system. The plant is a cogeneration plant that generates 5 MW of electricity and provides steam and chilled water for a commercial district.

7.4 Combination Utility Plants

EPA reviewed available discharge information for plants within SIC Code 4939 (Combination utilities, not elsewhere classified) to determine if these plants have operations and wastewater characteristics similar to those in the Steam Electric Power Generating Point Source Category. The U.S. Census Bureau defines combination utilities as:

“Establishments primarily engaged in either providing electric services in combination with other services, with electric service as the major part though less than 95 percent of the total or providing gas services in combination with other services, with gas services as the major part though less than 95 percent.” [USCB, 2000]

According to the U.C. Census Bureau’s Comparative Statistics, there were 1,989 combination utilities in the United States in 1997³⁴ [USCB, 2000]; however, not all of these plants are relevant to the detailed study. By definition, combination utilities perform services other than electric power generation, and more specifically services other than steam electric power generation.

Wastewaters generated by plants classified as combination utilities are likely not currently subject to existing effluent guidelines; however, combination utilities by definition include plants that generate electric power, albeit in combination with providing other utility services. Because at least a portion of these plants are expected to be engaged in the generation of electricity for distribution and sale, EPA determined that the electric generating activities performed at some combination utilities might be similar to those at plants regulated by the Steam Electric Power Generating effluent guidelines, in terms of processes and wastewaters generated. EPA examined effluent monitoring data reported in DMRs, as well as pollutants reported to TRI as discharged, and determined that the pollutants are similar in nature to those discharged by the steam electric plants currently regulated by the Steam Electric Power Generating effluent guidelines [U.S. EPA, 2005b]. However, the wastewater discharge characterization data suggests that combination utilities may discharge relatively small volumes of wastewater and/or pollutants, particularly as compared to those plants regulated under the Steam Electric Power Generating effluent guidelines.

EPA’s review of NPDES permits for five combination utilities revealed that four of these plants do not produce electricity, even as an auxiliary activity, and the processes and wastewaters generated by these non-electric generating plants are not similar to those of steam electric plants

³⁴ EPA used 1997 Economic Census data instead of 2002 Economic Census data because the 1997 data was reported by SIC code and the 2002 data was reported by NAICS code. SIC code 4939 does not have a direct correlation to a NAICS code; therefore, EPA could not determine the number of combination utilities from the 2002 Economic Census data.

regulated under the Steam Electric Power Generating effluent guidelines. The wastewater-generating activities performed at these plants may be classified within other existing SIC codes, including Electric Services, Sewerage Systems, and Water Supply.

7.4.1 Wastewater Discharge Characterization Data

EPA extracted data reported to TRI in 2005 for all plants within SIC code 4939. EPA used 2005 TRI data because they were the most recent TRI data for which the plants reported their SIC code, for years after 2005, plants began reporting NAICS codes. Only 13 combination utilities reported to TRI, and of these, only one reported a direct release to water (barium and barium compounds with a TWPE of 0.003). The remaining seven reported no discharge of a TRI chemical to water [ERG, 2008a]. TRI does not specifically identify the process source(s) of the wastewater and pollutants discharged.

EPA also extracted effluent monitoring data reported to PCS and ICIS-NPDES in 2007 for plants within SIC code 4939. Table 7-7 summarizes the data extracted for these plants (47 combination utilities) along with their calculated total TWPE, which is a loading that accounts for the toxicity of the pollutants discharged. The 2009 screening-level analysis report, *2009 Annual Screening-Level Analysis: Supporting the Annual Review of Existing Effluent Limitations Guidelines and Standards and Identification of Potential New Categories for Effluent Limitations Guidelines and Standards* [U.S. EPA, 2009c], discusses EPA's method of calculating TWPE. Table 7-7 identifies whether these operations reported discharges of chlorine, TRO, CPO, or metals, which are pollutants typically discharged from steam electric plants regulated under the Steam Electric Power Generating effluent guidelines. As shown in Table 7-7, 10 of the 47 combination utilities reported discharges of chlorine.

Table 7-7 also indicates whether the plants are classified as “major” or “minor” dischargers. To provide an initial framework for setting permit issuance priorities, EPA developed a major/minor classification system for industrial and municipal wastewater dischargers. Each permitting authority establishes its own definitions, but major dischargers almost always have the capability to impact receiving waters if not controlled and, therefore, have been accorded more regulatory attention than minor dischargers. Plants are classified as major based on an assessment of six characteristics: (1) toxic pollutant potential; (2) flow/stream flow volume; (3) conventional pollutant loading; (4) public health impact; (5) water quality factors; and (6) proximity to coastal waters. Facilities with major discharges must report compliance with NPDES permit limits via monthly DMRs submitted to the permitting authority. Minor discharges may, or may not, adversely impact receiving water if not controlled. Therefore, EPA does not require DMRs for facilities with minor discharges. For this reason, the *DMRLoads2007* database includes data only for a limited set of minor dischargers when the states choose to include these data. As shown in Table 7-7, 45 of the 47 combination utilities are classified as minor dischargers [U.S. EPA, 2009b]. This suggests that combination utilities may discharge relatively small volumes of wastewater and/or pollutants.

Table 7-7. Combination Utilities Identified in DMRLoads2007 Database

NPDES ID	Plant Name	City	Type of Discharger	Monitoring Data in Database?	Total TWPE ^a	CI/TRO/CPO Discharged ^b	Metals Discharged
AR0034363	Shumaker Public Service Corp.	East Camden	Minor	N	NA		
CA0047953	Paso Robles WWTP	Paso Robles	Major	Y	173	Cl	Na, Cu, Se
CO0042447	Rifle Station	Garfield County	Minor	N	NA		
CT0030279	City of Stamford	Stamford	Minor	N	NA		
IA0062421	Coats Utility Company	Fort Dodge	Minor	N	NA		
IL0045527	Aqua II Inc-Candlewick Lake	Poplar Grove	Minor	Y	NA	Cl	
IL0048593	Otter Creek Lake Utility Stp	Davis	Minor	Y	NA	Cl	
IL0052817	Stonewall Utility Co Stp	Oakbrook Terrace	Minor	Y	NA	Cl	
IL0071030	Emmett Utilities Inc. Stp	Colchester	Minor	Y	NA	Cl	
ILG551012	Sheridan Estates Disp Stp	Quincy	Minor	Y	NA	Cl	
ILG640079	Aqua Illinois-Woodhaven	Sublette	Minor	Y	NA	Cl	
IN0000311	BPC Manufacturing Operations	Plymouth	Minor	N	NA		
IN0002941	Western Electric Co	Indianapolis	Minor	N	NA		
IN0031011	USDAF USAF Grissom AFB	Grissom AFB	Minor	N	NA		
IN0031836	Gateway Utilities, Inc.	Terre Haute	Minor	N	NA		
KY0105091	Western Lewis Rectorville Wtr	Mason County	Minor	N	NA		
LA0116424	US 165 North Regional WWTF	West Monroe	Minor	N	NA		
LA0119679	North Vermilion WTP	Maurice	Minor	N	NA		
LA0119687	Pecan Island WTP	Kaplan	Minor	N	NA		
ME0102512	Hampden WWTF	Hampden	Minor	N	NA		
MN0041271	Franklin Heating Station	Rochester	Minor	N	NA		
MO0000345	Tractebel Power Incorporated	Saint Louis	Minor	N	NA		
NY0005894	Glenwood Landing Energy Center	Glenwood Landing	Minor	Y	NA		
NY0026344	Shoreham Combustion Turbine Facility	Shoreham	Major	Y	<1	Cl	
NY0106259	Covanta Niagara, L.P.	Niagara Falls	Minor	Y	NA		Al, Fe
NY0200778	East 60th Street Steam Plant	New York	Minor	Y	NA		Al, Zn
NY0201138	Consolidated Edison Co Of NY	Long Island City	Minor	Y	NA		
NY0201154	Astoria Liquified Nat Gas Storage	Astoria	Minor	Y	NA		
NY0225282	Brookhaven Combustion Turbine	Wading River	Minor	Y	NA		
NY0225860	Shoreham Nuclear Power Station	Shoreham	Minor	N	NA		
NY0226009	Southold Internal Combustion	Greenport	Minor	Y	NA		

Table 7-7. Combination Utilities Identified in *DMRLoads2007* Database

NPDES ID	Plant Name	City	Type of Discharger	Monitoring Data in Database?	Total TWPE^a	Cl/TRO/CPO Discharged^b	Metals Discharged
NY0226017	Keyspan - East Hampton Icf	East Hampton	Minor	Y	NA		
NY0226025	Keyspan - Montauk Icf	Montauk	Minor	Y	NA		
NY0226033	Southampton Icf	Southampton	Minor	Y	NA		
NY0259055	DTE Tonawanda LLC	Buffalo	Minor	Y	NA	Cl	
NY0265039	White Plains Substation	White Plains	Minor	Y	NA		
NY0266515	Brookhaven Energy	Yaphank	Minor	N	NA		
NY0267538	Astoria Energy Power Plt	Astoria	Minor	Y	NA	Cl	
NY0268003	Consolidated Edison Co Of NY	White Plains	Minor	Y	NA		
NY0270407	TBG Cogen Partners	Hicksville	Minor	Y	NA		
NY0270423	Bayswater/Jamaica Bay Peak Fac	Far Rockaway	Minor	Y	NA		
NY0271438	Tomson Converter Station	Shoreham	Minor	Y	NA		
OH0041335	Prince Inland Terminal Co Belpre	Belpre	Minor	N	NA		
PA0020435	White Haven WWTP	White Haven	Minor	N	NA		
PA0061590	Eagle Rock Community Assoc	Hazleton	Minor	N	NA		
PAR900004	Convanta Delaware Valley LP	Chester	Minor	N	NA		
UTS000002	Salt Lake City Corporation	Salt Lake City	Minor	N	NA		

Source: [U.S. EPA, 2009b].

a – TWPE was not calculated for minor plants in the *DMRLoads2007* database.

b – Cl – Chlorine; TRO – Total residual oxidants; and CPO – Chlorine produced oxidants (EPA has not developed TWFs for TRO and CPO; therefore, these loads are not included in TWPE totals).

Plants shown in bold identify plants for which EPA was able to acquire and review the plant's NPDES permit.

NA – Not Available. The plant is either a minor discharger, in which case EPA does not calculate TWPE, or the plant did not report both concentration and flow data and/or the plant reported only parameters for which EPA has not developed a TWF (e.g., TSS, BOD₅).

Note: The rows with bold text in the table identify the plants for which EPA reviewed NPDES permits. EPA had initially selected the five plants for permit review based on combination utilities identified in the 2002 PCS database; however, two of these five plants are not identified as combination utilities in the *DMRLoads2007* database. Therefore, only three of the plants for which EPA reviewed permits are identified in the table.

7.4.2 NPDES Permit Review

During the detailed study, EPA obtained NPDES permits for five³⁵ plants initially believed to be combination utilities. EPA reviewed the permits to determine the operations at the plants, the types of wastewaters generated by the plants, and how the wastewaters were being permitted.

Through the permit review, EPA identified one of the five combination utilities as an electric generating plant. The Rifle Station plant in Rifle, Colorado, operates a natural gas-powered combined cycle system with a total electric generating capacity of 108 MW. According to the 2003 Summary of Rationale for the permit, the Rifle plant is an electric peaking power generation plant categorized by the permitter to be within SIC code 4911 – Electric Services. Until 2002, the plant was operated in conjunction with a large greenhouse that utilized steam heat provided by the plant. The plant still provides steam heat to the greenhouse; however, the peaking plant and greenhouse are currently under separate ownership [CDPHE, 2003].

The NPDES permit for this plant also indicated that the cooling tower blowdown contributes 50 to 70 percent of the total discharge, which is intermittent due to the sporadic demand for electric power from this peaking plant. The wastewater discharged by this plant is currently limited by the requirements of the Steam Electric Power Generating effluent guidelines³⁶, since it meets the applicability at 40 CFR Part 423.10 [CDPHE, 2003].

EPA found the remaining four plants to be wastewater treatment and water supply plants. None of these plants reported an electric generating unit to the EIA. In addition, the limited amount of information on the waste streams provided in the permits indicated they had little in common with the waste streams expected from a steam electric generating plant, as previously described in Section 3.2. Since these plants do not appear to be "...primarily engaged in the generation of electricity for distribution and sale..." [40 CFR Part 423.10], they do not meet the current applicability of the Steam Electric Power Generating effluent guidelines. Further, the processes and wastewaters generated by these non-electric-generating plants are not similar to those of steam electric plants regulated under the Steam Electric Power Generating effluent guidelines.

³⁵ EPA selected these five plants based on combination utilities identified in the 2002 PCS database. Two of these five plants are not identified as combination utilities in the *DMRLoads2007* databases. The other three plants are listed in Table 7-7.

³⁶ The permit did not address limitations on copper and iron discharged with chemical metal cleaning wastewaters.

8. REFERENCES

1. Air and Waste Management Association (AWMA). 2008. CCS with Alstom’s Chilled Ammonia Process at AEP’s Mountaineer Plant: Paper # 167. Available online at: http://secure.awma.org/presentations/Mega08/Papers/a167_1.pdf. Date accessed: May 29, 2009. DCN 06444.
2. Alcoa Generating Corp. 2009. Telephone conversation with Danny Wene of Alcoa Generating and T.J. Finseth of Eastern Research Group, Inc. “Alcoa Warrick Operations’ On-site Power Plant.” DCN 06521.
3. Alstom Corporation. 2008. *Alstom Annual Information Document (June 2007-June 2008)*. Available online at: http://www.alstom.com/home/investors/publications/annual_information_document/_files/file_43348_50660.pdf. Date accessed: May 29, 2009. DCN 06443.
4. Alstom Corporation. 2009. *Alstom Officials Say Preliminary Data Shows That Carbon Capture Demonstration Project Is Successful*. Available online at: http://www.we-energies.com/home/alstom_newsrelease051109.pdf. Date accessed: May 29, 2009. DCN 06442.
5. API. 2005. Letter from R.E. Claff, American Petroleum Institute, to U.S. EPA Water Docket. “Comments of the American Petroleum Institute on the 2006 Effluent Guidelines Program Plan.” (29 November). Docket Number EPA-HQ-OW-2004-0032-1067.
6. Aquatech. 2006. Telephone conversation with Manoj Sharma of Aquatech and T.J. Finseth of Eastern Research Group, Inc. “Aquatech Boron Mitigation System.” (11 April). DCN 03639.
7. Archer Daniels Midland (ADM) Company. 2009. Telephone conversation with Levi LaMothe of ADM and T.J. Finseth of Eastern Research Group, Inc. "Archer Daniels Midland On-Site Electric Generating Units." (29 April). DCN 06522.
8. Babcock Power Services, Inc. 1997. *Dry Fly Ash System and Conversion for an Existing 480MW Power Plant - Justification, Design, and Construction*. Available online at: <http://www.babcockpower.com/pdf/rst-145.pdf>. (9 December). DCN 06523.
9. Babcock & Wilcox Company. 2005. *Steam: Its Generation and Use*. 41st edition. Edited by J.B. Kitto and S.C. Stultz. Barberton, Ohio. DCN 05759.
10. Besser, J. M., Giesy, J. P., Brown, R. W., Buell, J. M., and Dawson, G. A. 1996. Selenium bioaccumulation and hazards in a fish community affected by coal fly ash effluent. *Ecotoxicol. Environ. Saf.* 35, 7-15. (17 January). DCN 06038.
11. Carlson, C.L., D.C. Adriano. 1993. Environmental Impacts of Coal Combustion Residues. *Journal of Environmental Quality* 22:227-247. DCN 06313.

12. CCT. 1997. Clean Coal Technology Program. *Control of Nitrogen Oxide Emissions: Selective Catalytic Reduction (SCR)*. Topical Report No. 9. Report produced cooperatively by U.S. DOE and Southern Company Services, Inc. (July). Available online at: <http://www.p2pays.org/ref/16/15940.pdf>. DCN 03355.
13. CDPHE. 2003. Colorado Department of Public Health and Environment. *Summary of Rationale – Tri-State Generation and Transmission Association, Inc., Rifle Station*. CDPS Permit No. CO-0042447. Garfield County. (25 November). DCN 02524.
14. CEC. 2006. California Energy Commission. *Landfill Gas Power Plants*. Available online at: http://cacx.org//development/biomass/landfill_gas.html. Date accessed: August 2006. DCN 03559.
15. CEPA. 2006a. California Environmental Protection Agency. Telephone conversation with Jim Rohrbach of the Central Valley Water Resources Control Board, and Sarah Holman of Eastern Research Group, Inc. “Wheelabrator Shasta Power Plant (CA0081957).” (24 March). DCN 03637.
16. CEPA. 2006b. California Environmental Protection Agency. Telephone conversation with Mey Bunte of the Central Valley Water Resources Control Board, and Sarah Holman of Eastern Research Group, Inc. “Telecon with spreadsheet attachment. Wheelabrator Shasta Power Plant (CA0081957).” (27 March). DCN 03638.
17. CEPA. 2006c. California Environmental Protection Agency. Telephone conversation with Pat Leary of the Central Valley Water Resources Control Board, and Sarah Holman of Eastern Research Group, Inc. “Calistoga Geothermal Power Plant (Federal Lease CA5636).” (27 March). DCN 03642.
18. CEPA. 2006d. California Environmental Protection Agency. Telephone conversation with Jim Rohrbach of the Central Valley Water Resources Control Board, and Sarah Holman of Eastern Research Group, Inc. “Calistoga Geothermal Power Plant (Federal Lease CA5636).” (29 March). DCN 03641.
19. Chiyoda Corporation. 2006. *Integrated Gasification Combined Cycle*. Available online at: <http://www.chiyoda-corp.com/biz/e/hpi/igcc.shtml>. Date accessed: August 2006. DCN 03558.
20. Consolidated Edison, Inc. 2009. Email to Kurt Blohm, Eastern Research Group, Inc. from Mike Trofinoff, Con Edison. “Responses to Questions Sent to Con Edison.” (29 April). DCN 06565.
21. Covanta Holding Co. 2009. Telephone conversation with Brian Bahor of Covanta and T.J. Finseth of Eastern Research Group, Inc. “Covanta Municipal Solid Waste Power Plants.” (23 April). DCN 06525.
22. Duke Energy. 2007. “Gibson Lake Will Not Reopen for Fishing April 1.” (27 March). Available online at: <http://www.duke-energy.com/news/releases/2007032701.asp>. Date accessed: April 7, 2009. DCN 06939

23. Duke Energy. 2009. Project Overview. "Rendering of the proposed IGCC power plant located at Duke Energy's Edwardsport Station in Knox County, Indiana." Available online at: <http://www.duke-energy.com/about-us/edwardsport-overview.asp>. DCN 06527.
24. Eastern Research Group, Inc (ERG). 2007a. Acid Rain Program Results for Coal-Fired Units Operating Wet FGD Systems in 2006. (4 January). DCN 05837.
25. Eastern Research Group, Inc. (ERG). 2007b. Memorandum to Ron Jordan, US EPA. "Notes from Site Visit at Tampa Electric Company's Big Bend Station on April 27, 2007." (24 May). DCN 04728.
26. Eastern Research Group, Inc (ERG). 2007c. Final Generic Sampling and Analysis Plan for Coal-Fired Steam Electric Power Plants. (1 June). DCN 04296.
27. Eastern Research Group, Inc (ERG). 2007d. Sampling Plan, Wisconsin Electric Power Company's Pleasant Prairie Power Plant. (14 June). DCN 04298.
28. Eastern Research Group, Inc (ERG). 2007e. Final Engineering Site Visit Report for Georgia Power's Plant Wansley. (27 June). DCN 04302.
29. Eastern Research Group, Inc (ERG). 2007f. Final Engineering Site Visit Report for Georgia Power's Plant Yates. (27 June). DCN 04301.
30. Eastern Research Group, Inc (ERG). 2007g. Sampling Plan, Tampa Electric Company's Big Bend Station. (10 July). DCN 04815A1.
31. Eastern Research Group, Inc (ERG). 2007h. Final Engineering Site Visit Report for Tennessee Valley Authority's Widows Creek Fossil Plant. (18 July). DCN 04714.
32. Eastern Research Group, Inc (ERG). 2007i. Engineering Site Visit Report for EME Homer City Generation L.P.'s Homer City Power Plant. (09 August). DCN 04718.
33. Eastern Research Group, Inc (ERG). 2007j. Sampling Plan, EME Homer City Generation L.P.'s Homer City Power Plant. (17 August). DCN 04860A1.
34. Eastern Research Group, Inc (ERG). 2007k. Sampling Plan, Tennessee Valley Authority's Widows Creek Fossil Plant. (4 September). DCN 04840A1.
35. Eastern Research Group, Inc (ERG). 2007l. Final Engineering Site Visit Report for Reliant Energy's Conemaugh Power Plant. (17 September). DCN 04717.
36. Eastern Research Group, Inc (ERG). 2007m. Memorandum to Ron Jordan: Addendum to the Generic Sampling and Analysis Plan for Coal-Fired Steam Electric Power Plants (27 September). DCN 04296A1.
37. Eastern Research Group, Inc (ERG). 2007n. Sampling Plan, Buckeye Power Company's Cardinal Power Plant. (9 October). DCN 05917A1.
38. Eastern Research Group, Inc (ERG). 2007o. Sampling Plan, Ohio Power Company's Mitchell Plant. (9 October). DCN 05912A1.

39. Eastern Research Group, Inc (ERG). 2008a. *TRI Releases 2005_v02*. (30 June). DCN 05796.
40. Eastern Research Group, Inc (ERG). 2008b. Coal-Fired Power Plants Expected to be Operating Wet FGD Scrubber Systems by 2020. (14 July). DCN 06168.
41. Eastern Research Group, Inc (ERG). 2008c. Coal-Fired Power Plants Operating Wet FGD Scrubber Systems As of June 2008. (14 July). DCN 06167.
42. Eastern Research Group, Inc (ERG). 2008d. Memorandum to Ron Jordan, EPA. "Meeting Between EPA and UWAG on April 10, 2008: Draft Summary of Discussion." (24 July). DCN 05847.
43. Eastern Research Group, Inc. (ERG). 2008e. Memorandum to Public Record for the Effluent Guidelines Program Plan 2007/2008, EPA Docket Number OW-2006-0771. "Documentation for the Historical and Projected Capacities for Coal-Fired and Wet FGD Plants." (25 July). DCN 05853.
44. Eastern Research Group, Inc (ERG). 2008f. Memorandum to Ron Jordan, EPA. "Model Plant Size Distributions and IPM Future Scrubbed Capacity Projections." (25 July). DCN 05850.
45. Eastern Research Group, Inc. (ERG). 2008g. Memorandum to Public Record for the Effluent Guidelines Program Plan 2007/2008, EPA Docket Number OW-2006-0771. "Development of Version One of the Power Plant FGD System Data Set." (29 July). DCN 06128.
46. Eastern Research Group, Inc. (ERG). 2008h. Final Site Visit Notes for Duke Energy Carolina's Belews Creek Steam Station (Non-CBI). (19 August). DCN 06145.
47. Eastern Research Group, Inc. (ERG). 2008i. Final Site Visit Notes for Duke Energy Carolina's Marshall Steam Station. (19 August). DCN 06143.
48. Eastern Research Group, Inc. (ERG). 2008j. Memorandum to Ron Jordan and Ahmar Siddiqui, US EPA. "Quality Assurance Procedures Used for the Steam Electric Data Request Responses." (20 August). DCN 06172.
49. Eastern Research Group, Inc (ERG). 2008k. Final Sampling Episode Report, Buckeye Power Company's Cardinal Power Plant. (August). DCN 05836.
50. Eastern Research Group, Inc (ERG). 2008l. Final Sampling Episode Report, EME Homer City Generation L.P.'s Homer City Power Plant. (August). DCN 05823.
51. Eastern Research Group, Inc (ERG). 2008m. Final Sampling Episode Report, Ohio Power Company's Mitchell Plant. (August). DCN 05834.
52. Eastern Research Group, Inc (ERG). 2008n. Final Sampling Episode Report, Tampa Electric Company's Big Bend Station. (August). DCN 05816.

53. Eastern Research Group, Inc (ERG). 2008o. Final Sampling Episode Report, Tennessee Valley Authority's Widows Creek Fossil Plant. (August). DCN 05844.
54. Eastern Research Group, Inc (ERG). 2008p. Final Site Visit Notes for Dominion Resources Mount Storm Power Plant. (8 December). DCN 06198.
55. Eastern Research Group. 2009a. Telephone conversation with Paul Ling of Kansas City Power & Light and Sarah Holman of Eastern Research Group, Inc. "Zero Liquid Discharge System at Iatan Generating Station. (6 January). DCN 06287.
56. Eastern Research Group, Inc (ERG). 2009b. Final Site Visit Notes for Ohio Power Company's Gavin Plant. (19 January). DCN 06201.
57. Eastern Research Group, Inc (ERG). 2009c. Final Site Visit Notes for Allegheny Energy's Harrison Plant. (20 January). DCN 06199.
58. Eastern Research Group, Inc (ERG). 2009d. Final Site Visit Notes for Dominion Resource's Clover Power Plant. (12 February). DCN 06202.
59. Eastern Research Group, Inc (ERG). 2009e. Memorandum to Ron Jordan, EPA. "Notes from Pre-Visit Call with Duke Energy and Gibson Station Personnel on February 13, 2009." (19 February). DCN 06299.
60. Eastern Research Group, Inc (ERG). 2009f. Memorandum to Ron Jordan, EPA. "Notes from Pre-Visit Call with Wabash Valley Power Association and Wabash River Station Personnel on February 18, 2009." (20 February). DCN 07090.
61. Eastern Research Group, Inc (ERG). 2009g. Final Site Visit Notes for Kentucky Utilities Company's Ghent Power Plant. (1 June). DCN 06205.
62. Eastern Research Group, Inc (ERG). 2009h. Final Site Visit Notes for Louisville Gas and Electric's Cane Run Station. (1 June). DCN 06207.
63. Eastern Research Group, Inc (ERG). 2009i. Final Site Visit Notes for Louisville Gas and Electric's Mill Creek Station. (1 June). DCN 06208.
64. Eastern Research Group, Inc (ERG). 2009j. Final Site Visit Notes for Louisville Gas and Electric's Trimble County Station (Non-CBI). (2 June). DCN 06206.
65. Eastern Research Group, Inc (ERG). 2009k. Final Site Visit Notes for Constellation Energy's Brandon Shores Generating Station (CBI). (30 September). DCN 06284.
66. Eastern Research Group, Inc (ERG). 2009l. Final Site Visit Notes from Tennessee Valley Authority's Paradise Fossil Plant. (30 September). DCN 06984.
67. Eastern Research Group, Inc (ERG). 2009m. Final Site Visit Notes for Western Kentucky Energy's Kenneth C. Coleman Station. (30 September). DCN 06292.

68. Eastern Research Group, Inc (ERG). 2009n. Memorandum to Ron Jordan, EPA. “Meeting between EPA and UWAG on June 25, 2009: Draft Summary Discussion” (1 October). DCN 07103.
69. Eastern Research Group, Inc (ERG). 2009o. Final Site Visit Notes for CPS Energy’s Calaveras Power Station. (5 October). DCN 06203.
70. Eastern Research Group, Inc (ERG). 2009p. Final Site Visit Notes for Fayette Power Project/Sam Seymour Power Plant (Non-CBI). (6 October). DCN 06204.
71. Eastern Research Group, Inc (ERG). 2009q. Final Sampling Episode Report, Duke Energy Carolinas’ Belews Creek Steam Station. (9 October). DCN 06197.
72. Eastern Research Group, Inc (ERG). 2009r. Final Site Visit Notes for Duke Energy’s Miami Fort Power Station. (9 October). DCN 06300.
73. Eastern Research Group, Inc (ERG). 2009s. Memorandum to Ron Jordan, EPA. “Development of the Current and Future Industry Profile for the Steam Electric Detailed Study.” (9 October). DCN 07085.
74. Eastern Research Group, Inc (ERG). 2009t. Memorandum to the Public Record for the Effluent Guidelines Program Plan 2009/2010. “Technology Option Loads Calculation Analysis for Steam Electric Detailed Study.” (9 October). DCN 07086.
75. Eastern Research Group, Inc (ERG). 2009u. Final Site Visit Notes for American Electric Power’s Mountaineer Power Plant (Non-CBI). (12 October). DCN 06200.
76. Eastern Research Group, Inc (ERG). 2009v. Final Site Visit Notes for Duke Energy’s Wabash River Generating Station (Non-CBI). (12 October). DCN 07095.
77. Eastern Research Group, Inc (ERG). 2009w. Steam Electric Detailed Study Facility Database. (13 October). DCN 07098.
78. Eastern Research Group, Inc (ERG). 2009x. Memorandum to Ron Jordan, EPA. “Monitoring Data for FGD Wastewater Collected During the Steam Electric Detailed Study” (14 October). DCN 07099.
79. Electric Power Research Institute (EPRI). 1997a. *Coal Combustion By-Products and Low-Volume Wastes Comanagement Survey*. TR-108369. Palo Alto, CA. (December). Available online at: <http://mydocs.epri.com/docs/public/TR-108369.pdf>. Date accessed: 9 October 2009. DCN 07096.
80. Electric Power Research Institute (EPRI). 1997b - 2001. PISCES Water Characterization Field Study, Sites A-G. Palo Alto, CA. DCNs 05060-05065.
81. Electric Power Research Institute (EPRI). 2005. *The Fate of Mercury Absorbed in Flue Gas Desulfurization (FGD) Systems*. 1009955. Palo Alto, CA. (March). DCN 04538.

82. Electric Power Research Institute (EPRI). 2006a. *Flue Gas Desulfurization (FGD) Wastewater Characterization: Screening Study*. 1010162. Palo Alto, CA. (March). DCN 04539.
83. Electric Power Research Institute (EPRI). 2006b. *EPRI Technical Manual: Guidance for Assessing Wastewater Impacts of FGD Scrubbers*. 1013313. Palo Alto, CA. (December). Available online at: <http://www.epriweb.com/public/000000000001013313.pdf>. Date accessed: 16 May 2008. DCN 04537.
84. Electric Power Research Institute (EPRI). 2007a. *Treatment Technology Summary for Critical Pollutants of Concern in Power Plant Wastewaters*. 1012549. Palo Alto, CA. (January). Available online at: <http://www.epriweb.com/public/000000000001012549.pdf>. Date accessed: 26 June 2008. DCN 05794.
85. Electric Power Research Institute (EPRI). 2007b. Update on Enhanced Mercury Capture by Wet FGD: Technical Update. 1012673. Palo Alto, CA. (March). DCN 04536.
86. Electric Power Research Institute (EPRI). 2007c. Memorandum to Ron Jordan, US EPA. "EPRI Comments on EPA Draft Sampling and Analytical Plan of March 31, 2007." (16 April). DCN 04829.
87. Electric Power Research Institute (EPRI). 2007d. EPRI Comments On US Environmental Protection Agency Notice of Availability of Preliminary 2008 Effluent Guidelines Program Plan. (30 October). EPA-HQ-OW-2006-0771-0850.1.
88. Electric Power Research Institute (EPRI). 2008a. Environment Quick News: A Monthly Report from EPRI's Environment Sector. Program 56: Effluent Guidelines and Water Quality Management. Available online at: <http://mydocs.epri.com/docs/CorporateDocuments/Newsletters/ENV/QN-2008-02/ENV-QN-2008-02.pdf>. Date accessed: 16 May 2008. DCN 05793.
89. Electric Power Research Institute (EPRI). 2008b. Program on Technology Innovation: Selenium Removal from FGD Wastewaters Using Metallic Iron Cementation. Available online at: http://my.epri.com/portal/server.pt?Abstract_id=000000000001016191. Date accessed: 16 May 2008. DCN 05692.
90. Electric Power Research Institute (EPRI). 2009. "Integrated Gasification Combined-Cycle (IGCC) With CO2 Capture and Storage Demonstration." Available online at: <http://mydocs.epri.com/docs/public/000000000001018746.pdf>. DCN 06529.
91. Erbe, M.W., Aeiker, D.M., Keating, R.W. 2007 Assessment of Water Quality Impacts Associated with Use of Coal Combustion Products as Structural Fill at the BBSS Site. Maryland Power Plant Research Program. June 2007. Maryland DNR 12-6182007-221 PPRP-142. (June). DCN 06940.

92. Evangelou, V.P. 1996. "Coal Ash Chemical Properties and Potential Influence on Water Quality". In: *Proceedings of Coal Combustion By-Products Associated with Coal Mining: Interactive Forum*. Southern Illinois University at Carbondale, Carbondale, IL. (October 29-31). Available online at: <http://www.ott.wrcc.osmre.gov/library/proceed/ccb1996/session5.pdf>. DCN 02259.
93. Fairfax County, Virginia. 2006. *Energy Resource Recovery Facility*. Available online at: <http://www.fairfaxcounty.gov/dpwes/trash/dispomsf.htm>. Date accessed: August 2006. DCN 03560.
94. FDEP. 2006. Florida Department of Environmental Protection. Telephone conversation with Charles Davault of the Industrial Discharge Program, and Sarah Holman of Eastern Research Group, Inc. "Okeelanta Cogeneration Plant (FLA150355)." (29 March). DCN 03640.
95. Feeley, Thomas III. et al. 2009. An update on DOE's Phase II and Phase III mercury control technology R&D program. (12 May). DCN 06746.
96. GEA. 2006. Geothermal Energy Association. *All About Geothermal Energy – Mythbusters*. Available online at: <http://www.geo-energy.org/aboutGE/mythbusters.asp#extract>. Date accessed: August 2006. DCN 03561.
97. Gulf Power Co. 2009. Telephone conversation with Jim Vick of Gulf Power and Sarah Holman of Eastern Research Group, Inc. "Deep well injection and water reuse at Plant Crist." (6 January). DCN 06286.
98. Hall, Josh. 2007. Letter to Dean McDevitt. "Notes from Site Visit at Northern Indiana Public Service Company's Bailly Generating Station on April 19, 2007." (2 August). DCN 05701.
99. Hartford Steam Company. 2009. Telephone conversation with David Ninesling of Hartford Steam Company and Kurt Blohm of Eastern Research Group, Inc. "Hartford Steam Supply Plant Operations." (28 April). DCN 06563.
100. Heidorn, Keith C. 2005. Weather Phenomenon and Elements: Fall/Spring Lake Turnover. (1 September). DCN 06706.
101. Hill, Donna (UWAG). 2008. Letter to Ron Jordan. (19 September). DCN 06886A1.
102. IDNR. 2006a. Iowa Department of Natural Resources. Telephone conversation with Steven Williams of the Wastewater Division, and Sarah Holman of Eastern Research Group, Inc. "Ames Municipal Electric System (IA0033235)." (30 March). DCN 03636.
103. IDNR. 2006b. Iowa Department of Natural Resources. Telephone conversation with Steven Williams of the Wastewater Division, and T.J. Finseth of Eastern Research Group, Inc. "Bromine Toxicity and Biocide Questions." (13 April). DCN 03657.
104. IEEE. 1989. "Solar Electric Generating Stations (SEGS)." *Power Engineering Review*. 9:4-8. (August). DCN 06530.

105. International Paper. 2009. Telephone conversation with Jeffrey Shumaker of International Paper and T.J. Finseth of Eastern Research Group, Inc. "International Paper Electric Generating Units." (27 April). DCN 06532.
106. Jordan, Ron. 2007. Notes from EPA Site Visit at Seminole Electric Cooperative's Seminole Power Plant on April 26, 2007. (5 July). DCN 04731.
107. Jordan, Ronald (U.S. EPA). 2008a. Site Visit Notes for Progress Energy Carolinas' Roxboro Steam Electric Plant. (7 July). DCN 05789.
108. Jordan, Ron. 2008b. Site Visit Notes for the AES Cayuga Generation Plant." (14 July). DCN 05791.
109. Jordan, Ron. 2009. Memorandum to Record for the Steam Electric Detailed Study. "Documented Cases of Environmental Impacts from Coal Combustion Wastewater: Pollutant Sources and Impacted Water Resources." (14 October). DCN 07097.
110. Kilgore, T. 2009. Testimony of Tom Kilgore President and Chief Executive Officer, Tennessee Valley Authority, before the U.S. House Committee on Transportation and Infrastructure Subcommittee on Water Resources and Environment. (31 March). DCN 06941.
111. Kirk-Othmer. 2000. *Kirk-Othmer Encyclopedia of Chemical Technology*. "Renewable Energy Resources." John Wiley & Sons, Inc. (4 December). DCN 03562.
112. Lemly, A. D. 1996. Ecosystem recovery following selenium contamination in a freshwater reservoir, *Ecotoxicol. Environ. Saf.* 36, 275–281. (28 August). DCN 06035.
113. Lohner, T. W., Reash, R. J., Willet, V. E. and Rose, L. A. 2000. Assessment of tolerant sunfish populations (*Lepomis* sp.) Inhabiting selenium-laden coal ash effluents. 1. Hematological and population level assessment. *Ecotoxicol. Environ. Saf.* 50, 203–216. (20 October). DCN 06045.
114. Pruitt, Lori. 2000. "Indiana's First HCP Conserves Least Tern - Brief Article". *Endangered Species Bulletin*. FindArticles.com. http://findarticles.com/p/articles/mi_m0ASV/is_4_25/ai_69652201/ Accessed April 7, 2009. (July). DCN 06942.
115. Maryland Department of the Environment. 2008. MDE's Highest Polluter Penalties. Gary Kelman, Permitting and Customer Service Center and Kim Lamphier, Office of Communications. (October). DCN 06693.
116. McGinnis, Gregory et al. 2009. "Cliffside 6 Integrated Emissions Control System." *Power Engineering*. (28 April). Available on-line at: http://pepei.pennnet.com/display_article/358960/6/ARTCL/none/none/1/Cliffside-6-Integrated-Emissions-Control-System/. DCN 06524.

117. Micheletti, W.C. and Burns, J.M. 2002. "Emerging Issues and Needs in Power Plant Cooling Systems." In: Proceedings from the Workshop on Electric Utilities and Water: Emerging Issues and R&D Needs. U.S. Department of Energy, Office of Fossil Energy, National Energy Technology Laboratory. Pittsburgh, PA. (23-24 July). Available online at: <http://www.netl.doe.gov/publications/proceedings/02/EUW/euw02.html>. DCN 03658.
118. Missouri Department of Conservation (MDC). 2004. Aquaguide: Pond Turnover. Available online at: <http://mdc4.mdc.mo.gov/Documents/10937.pdf>. (October). DCN 06705.
119. Narukawa, T. et al. 2003. "Investigation into the Relationship Between Major and Minor Element Contents and Particle Size and Leachability of Boron in Fly Ash from Coal Fuel Thermal Power Plants." *Journal of Environmental Monitoring*. 5: 831-836. (7 August). DCN 03564.
120. Nicholson, Mark C. 2007. "Evaporation of Purge Water from Wet FGD Scrubbers." IWC. (21 October). DCN 06536.
121. Northeastern States for Coordinated Air Use Management (NESCAUM). 2000. *Environmental Regulation and Technology Innovation: Controlling Mercury Emissions from Coal-Fired Boilers*. Boston, MA. (September). Available online at: http://www.nescaum.org/documents/rpt000906mercury_innovative-technology.pdf/. DCN 05691.
122. NPS. 1997. National Parks Service. Environmental Contaminants Encyclopedia Selenium Entry. (1 July). DCN 06333.
123. NRC. 2006. National Research Council of the National Academies. *Managing Coal Combustion Residues in Mines*. National Academies Press, Washington, DC. DCN 03356.
124. Otero-Rey, J.R. et al. 2003. "As, Hg, and Se Flue Gas Sampling in a Coal-Fired Power Plant and Their Fate During Coal Combustion." *Environmental Science and Technology*. 37: 5262-5267. (18 October). DCN 03566.
125. PDEP. 2006. Pennsylvania Department of Environmental Protection. Telephone conversation with Sohan Garg of the Wastewater Division, and Sarah Holman of Eastern Research Group, Inc. "Fairless Hills Steam Generating Station (PA0057088)." (30 March). DCN 03643.
126. Pickett, Tim, et al. 2006. "Using Biology to Treat Selenium." *Power Engineering*. (November). Available online at: http://pepei.pennnet.com/display_article/278443/6/ARTCL/none/none/Using-Biology-to-Treat-Selenium/. Date accessed: May 16, 2008. DCN 05689.

127. Power Magazine. 2008. *Alstom's chilled ammonia CO₂-capture process advances toward commercialization*. Available online at: [http://www.powermag.com/environmental/Alstoms-chilled-ammonia-CO₂-capture-process-advances-toward-commercialization_86.html](http://www.powermag.com/environmental/Alstoms-chilled-ammonia-CO2-capture-process-advances-toward-commercialization_86.html). (28 February). Date accessed: May 29, 2009. DCN 06445.
128. POWERnews. 2009. "Planned U.S. CCS Demonstration Will Be Largest Test of MHI's Amine Technology." POWER Magazine. (May) DCN 06533.
129. Rao, M.N. 2008. Aquatech International Corporation. ZLD Systems Installed for ENEL Power Plants in Italy. International Water Conference. (27 - 29 October). DCN 06933.
130. Ratafia-Brown, J. *et al.* 2002. An Environmental Assessment of IGCC Power Systems. Nineteenth Annual Pittsburgh Coal Conference, (23 – 27 September). Available online at: <http://www.netl.doe.gov/technologies/coalpower/gasification/pubs/pdf/18.pdf>. Date accessed: May 07, 2009. DCN 07021.
131. Rodgers, J. H., et al. 2005. Clemson University. *Specifically Designed Constructed Wetlands: A Novel Treatment Approach for Scrubber Wastewater*. Available online at: <http://www.netl.doe.gov/technologies/coalpower/ewr/water/pp-mgmt/pubs/42178%20final%20report%200905.pdf>. Date accessed: 5 September 2007. DCN 04979.
132. Rowe, C.L., W.A. Hopkins, and J.D. Congdon. 2002. Ecotoxicological Implications of Aquatic Disposal of Coal Combustion Residues. *Environmental Monitoring & Assessment* 80(3):207-276. (14 March). DCN 06057.
133. Sargent & Lundy, L.L.C. 2007. *Flue Gas Desulfurization Technology Evaluation: Dry Lime vs. Wet Limestone FGD*. 11311-001. Chicago, IL. (March). Available online at: <http://www.lime.org/FGD/FGDTechEvalDryLimevWetLimestoneFGD11311001.pdf>. Date accessed: June 12, 2008. DCN 05792.
134. Schroeder, Cuc. 2009. Memorandum to Ronald Jordan. "Summary statistics for the data collected from March 09, 2009 coal ash survey conducted by the Office of Solid Waste and Emergency Response (OSWER)." (30 September). DCN 07104.
135. Schultz, Sue. 2008. Baltimore Business Journal. "Constellation reaches \$54M settlement on fly ash lawsuit." (31 December). DCN 06943.
136. Shaw, William A. 2008. "Benefits of Evaporating FGD Purge Water." *Power*. (March). 59-63. Available online at: http://www.powermag.com/powerweb/archive_article.asp?a=60-F_WM&y=2008&m=march. Date accessed: March 14, 2008. DCN 05907.
137. Shell. 2006. The Shell Coal Gasification Process: For Sustainable Utilisation of Coal. Available online at: http://www-static.shell.com/static/global_solutions/downloads/innovation/coal_gasification_brochure.pdf. DCN 06541.

138. Stiegel, Gary J. 2009. NETL Presentation: Overview of DOE's Gasification Program. Available on-line at: <http://www.netl.doe.gov/technologies/coalpower/gasification/pubs/pdf/DOE%20Gasification%20Program%20Overview%202008%2012-05%20v1g.pdf>. (12 March). DCN 06535.
139. Tampa Electric Co. 2002. *Tampa Electric Polk Power Station Internal Gasification Combined Cycle Project: Final Technical Report*. Available on-line at: <http://www.tampaelectric.com/data/files/PolkDOEFinalTechnicalReport.pdf>. (August). DCN 06537.
140. Tampa Electric Co. 2008. Letter to Ron Jordan, EPA. (30 January). DCN 06539.
141. Tennessee Valley Authority Office of the Inspector General. 2009. Kingston Fossil Plant Ash Slide Interim Report. Inspection 2008-12283-01. (12 June). DCN 07022.
142. USCB. 2000. U.S. Census Bureau. *Comparative Statistics: 1997 Economic Census Core Business Statistics Series*. EC97X-CS2. (issued June 2000). Document and data are available online at: <http://www.census.gov/epcd/ec97sic/97x-cs2.pdf> and <http://www.census.gov/epcd/ec97sic/E97SUS.HTM>. DCN 03357.
143. USCB. 2002. U.S. Census Bureau. *Electric Power Generation, Transmission, and Distribution: 2002 Economic Census Utilities Industry Series*. EC02-221-03. (issued December 2004). Document and data are available online at: http://www.census.gov/econ/census02/data/us/US000_22.HTM and <http://www.census.gov/prod/ec02/ec0222i03.pdf>. DCN 01565.
144. U.S. DOE. 2000a. U.S. Department of Energy. *Lessons Learned from Existing Biomass Power Plants*. NREL/SR-570-26946. National Renewable Energy Laboratory; Golden, CO. (February). Available online at: <http://www.nrel.gov/docs/fy00osti/26946.pdf>. DCN 03573.
145. U.S. DOE. 2000b. U.S. Department of Energy. *The Changing Structure of the Electric Power Industry 2000: An Update*. Energy Information Administration (EIA). Washington, DC. (October). Available online at: http://www.eia.doe.gov/cneaf/electricity/chg_stru_update/update2000.pdf. Date accessed: August 2009. DCN 02314.
146. U.S. DOE. 2003. U.S. Department of Energy. *Electric Power Annual 2001*. DOE/EIA-0348(2001). Energy Information Administration (EIA). Available online at: <http://tonto.eia.doe.gov/ftproot/electricity/034801.pdf>. (March). DCN 05786.
147. U.S. DOE. 2005a. U.S. Department of Energy. *Annual Electric Generator Report* (collected via Form EIA-860). Energy Information Administration (EIA). The data files are available online at: <http://www.eia.doe.gov/cneaf/electricity/page/eia860.html>. DCN 05705.

148. U.S. DOE. 2005b. U.S. Department of Energy. *Annual Steam-Electric Plant Operation and Design Data* (collected via Form EIA-767). Energy Information Administration (EIA). The data files are available online at: <http://www.eia.doe.gov/cneaf/electricity/page/eia767.html>. DCN 05706.
149. U.S. DOE. 2006a. U.S. Department of Energy. *Energy Efficiency and Renewable Energy - Geothermal Technologies Program*. Available online at: <http://www1.eere.energy.gov/geothermal/faqs.html> and <http://www1.eere.energy.gov/geothermal/powerplants.html>. (January). DCN 03571.
150. U.S. DOE. 2006b. U.S. Department of Energy. *Glossary*. Energy Information Administration (EIA). Available online at: <http://www.eia.doe.gov/glossary/index.html>. Date accessed: June 2006. DCN 03359.
151. U.S. DOE. 2006c. U.S. Department of Energy. *Introduction to Nuclear Power*. Energy Information Administration (EIA). Available online at: <http://www.eia.doe.gov/cneaf/nuclear/page/intro.html>. Date accessed: August 2006. DCN 03567.
152. U.S. DOE. 2007a. NETL Gasification World Database 2007. Available on-line at: http://www.netl.doe.gov/technologies/coalpower/gasification/database/Gasification2007_web.pdf. (October). DCN 06534.
153. U.S. DOE. 2007b. U.S. Department of Energy. *Electric Power Annual 2006*. DOE/EIA-0348(2006). Energy Information Administration (EIA). Available online at: http://www.eia.doe.gov/cneaf/electricity/epa/epa_sum.html. (November). DCN 05690.
154. U.S. DOE. 2009. *NETL Carbon Sequestration/Capture Website*. Available online at: http://www.netl.doe.gov/technologies/carbon_seq/core_rd/co2capture.html. Date accessed: May 29, 2009. DCN 06446.
155. U.S. EPA. 1974. *Development Document for Effluent Limitations Guidelines and New Source Performance Standards for the Steam Electric Power Generating Point Source Category*. Washington, DC. (October). DCN 07020.
156. U.S. EPA. 1982. *Development Document for Effluent Limitations Guidelines and Standards and Pretreatment Standards for the Steam Electric Point Source Category*. EPA-440-1-82-029. Washington, DC. (November). DCN 03589.
157. U.S. EPA. 1989. Memorandum to Regional Permit Branch Chiefs and State Directors. “Combined Cycle Electric Generation Plants – Steam Electric Power Generating Point Source Category.” (19 December). DCN 01574.
158. U.S. EPA. 1996. *Preliminary Data Summary for the Steam Electric Point Source Category*. EPA 821-Z-96-010. Washington, DC. (April). DCN 00610.
159. U.S. EPA. 1997. *Profile of the Fossil Fuel Electric Power Generation Industry*. EPA/310-R-97-007. Washington, DC. (September). Available online at: <http://www.epa.gov/compliance/resources/publications/assistance/sectors/notebooks/fossil.html>. DCN 02203.

160. U.S. EPA. 2001. *Technical Development Document for the Final Regulations Addressing Cooling Water Intake Structures for New Facilities*. EPA-821-R-01-036. Washington, DC. (9 November). Available online at: <http://www.epa.gov/waterscience/316b/phase1/technical/index.html>. DCN 03592.
161. U.S. EPA. 2003. *Air Pollution Control Technology Fact Sheet*. EPA-452/F-03-034. Available online at: <http://www.epa.gov/ttn/catc/dir1/ffdg.pdf>. DCN 03777.
162. U.S. EPA. 2005a. *Control of Mercury Emissions from Coal Fired Electric Utility Boilers: An Update*. Research Triangle Park, NC. (18 February). Available online at: http://www.epa.gov/ttn/atw/utility/ord_whtpaper_hgcontroltech_oar-2002-0056-6141.pdf. DCN 03590.
163. U.S. EPA. 2005b. *2005 Annual Screening Level Analysis: Supporting the Annual Review of Existing Effluent Limitations Guidelines and Standards and Identification of Potential New Categories for Effluent Limitation Guidelines and Standards*. EPA 821-B-05-003. Washington, DC. (August). Available online at: http://www.epa.gov/waterscience/guide/304m/sla_report.pdf. DCN 02173.
164. U.S. EPA. 2005c. *Preliminary Engineering Report: Steam Electric Detailed Study*. EPA 821-B-05-005. Washington, DC. (August). Available online at: http://www.epa.gov/waterscience/guide/304m/report_steam_electric.pdf. DCN 02176.
165. U.S. EPA. 2006a. *Characterization of Mercury – Enriched Coal Combustion Residues from Electric Utilities Using Enhanced Sorbents for Mercury Control*. EPA/600/R-06/008. Research Triangle Park, NC. (February). DCN 03036.
166. U.S. EPA. 2006b. *Integrated Planning Model (IPM)*. “EPA Base Case 2006 (v.3.0).” (28 March). Available online at: <http://www.epa.gov/airmarkt/progsregs/epa-ipm/index.html>. DCN 05775.
167. U.S. EPA. 2006c. *PCSLoads2002 Database v.04*. Washington, DC. (September). DCN 03654.
168. U.S. EPA. 2006d. *TRIRelases2002 Database v.04*. Washington, DC. (September). DCN 03653.
169. U.S. EPA. 2006e. *Interim Detailed Study Report for the Steam Electric Power Generating Point Source Category*. EPA 821-R-06-015. Washington, DC. (November). Available online at: <http://www.epa.gov/guide/304m/steam-interim.pdf>. DCN 03401.
170. U.S. EPA. 2006f. *Controlling Mercury with Existing Controls*. Available online at: http://www.epa.gov/mercury/control_emissions/tech_exist.htm. Date accessed: August 2006. DCN 03574.
171. U.S. EPA. 2006g. *Landfill Methane Outreach Program*. Available online at: <http://www.epa.gov/lmop/overview.htm>. Date accessed: August 2006. DCN 03585.

172. U.S. EPA. 2006h. *National Electric Energy Data System (NEEDS) 2006*. “2006 NEEDS Database”. Available online at: <http://www.epa.gov/airmarkt/progsregs/epa-ipm/index.html>. DCN 04924.
173. U.S. EPA. 2006i. *Tire Derived Fuel*. Available online at: <http://www.epa.gov/garbage/tires/tdf.htm>. Date accessed: August 2006. DCN 03586.
174. U.S. EPA. 2007a. Data Request for the Steam Electric Power Generating Industry. (7 May). DCN 04322.
175. U.S. EPA. 2007b. Particulates-Venturi Scrubbers. Available online at: <http://www.epa.gov/apti/course422/ce6a3.html>. Date accessed: August 2009. DCN 06691.
176. U.S. EPA. 2007c. Coal Combustion Waste Damage Case Assessments. Office of Solid Waste. (9 July). DCN 06393.
177. U.S. EPA. 2008a. Non-CBI Steam Electric Data Request Database. (12 June). DCN 05754.
178. U.S. EPA. 2008b. Fly Ash. Available online at: <http://www.epa.gov/osw/conserves/rrr/imr/ccps/flyash.htm>. Date accessed: June 2009. DCN 06528.
179. U.S. EPA. 2008c. Characterization of Coal Combustion Residues from Electric Utilities Using Wet Scrubbers for Multi-Pollutant Control. EPA-600-R-08-077. (July). Available online at: <http://www.epa.gov/nrmrl/pubs/600r08077/600r08077.pdf>. DCN 07023.
180. U.S. EPA. 2008d. Final Engineering Site Visit Report for First Energy Generation Corp’s Bruce Mansfield Power Plant. (21 August). DCN 06147.
181. U.S. EPA. 2008e. *Steam Electric Power Generating Point Source Category: 2007/2008 Detailed Study Report*. EPA 821-R-08-011. Washington, DC. (August). Available online at: <http://www.epa.gov/guide/304m/2008/steam-detailed-200809.pdf>. DCN 05516.
182. U.S. EPA. 2009a. Testimony of Barry Breen, U.S. EPA, on Water Resources and the Environment to the U.S. House of Representatives. (30 April). Available online at: <http://www.epa.gov/osw/nonhaz/industrial/special/fossil/coalashtest409.pdf>. DCN 07101.
183. U.S. EPA. 2009b. *DMRLoads2007_v3*. Washington, DC. (July). DCN 06887.
184. U.S. EPA. 2009c. Technical Support Document for the Annual Review of Existing Effluent Guidelines and Identification of Potential New Point Source Categories. EPA-821-R-09-007. Washington, DC. (October). EPA-HQ-OW-2008-0517. DCN 06557.
185. U.S. EPA 2009d. US EPA website. Clean Air Mercury Rule. Available online at: <http://epa.gov/air/mercuryrule/>. Date accessed: October 15, 2009. DCN 07100.
186. U.S. Fish and Wildlife Service. 2008. Steps Taken to Address Selenium Concerns at Cane Ridge Wildlife Management Area.” News Release. (13 June). DCN 06944.

187. U.S. Fish and Wildlife Service. 2009. *Selenium Threat Averted*. News Release. (24 June). DCN 06695.
188. U.S. Renewables Group. 2009. Telephone conversation with Joel Lepoutre, U.S. Renewables Group and T.J. Finseth of Eastern Research Group, Inc. "Tracy Biomass Plant Operations." (30 April). DCN 06540.
189. Utility Water Act Group (UWAG). 2006. Utility Water Act Group. Letter to Carey Johnston, U.S. EPA, from D.B. Hill, UWAG. "UWAG responses to various requests for information made by EPA." (13 February). DCN 03538.
190. Utility Water Act Group (UWAG). 2007. "Comments of the Utility Water Act Group on EPA's Draft Data Request for the Steam Electric Generating Industry." (23 March). DCN 04998.
191. Utility Water Act Group (UWAG). 2008. Form 2C Effluent Guidelines Database. (30 June). DCNs 05856 and 05861.
192. Valero Energy Corp. 2009. Telephone conversation with Doug Duncan, Valero and T.J. Finseth of Eastern Research Group, Inc. "Valero On-Site Electric Generating Units." (11 May). DCN 06542.
193. Vasavada, Nish. 2009. E-mail to Ronald Jordan. "INVISTA Electric Power Generation Information." (21 July). DCN 07091.
194. Veolia Water Solution & Technologies Company. 2007. "HPD Awarded Flue Gas Desulfurization (FGD) Effluent Treatment for Monfalcone Coal-Fired Generating Station." News Release. (16 January). DCN 06989.
195. Wabash River Energy Ltd. 2000. *Wabash River Coal Gasification Repowering Project: Final Technical Report*. (August). DCN 06543.
196. WAI. 2003. Wood Ash Industries, Inc. Range in Elemental Composition of Industrial Fly Ash and Bottom Ash Samples. Available online at: <http://www.woodash.net/chart.html>. DCN 03594.
197. Walls, Michael; ACC. 2007. Letter from the ACC to EPA. "Comments on EPA's Preliminary 2008 Effluent Guidelines Program Plan." (28 December). EPA- HQ-OW-2006-0771-0843.
198. Wright, Thomas. 2003. "SCR Operation Optimization: SO₃ Removal to Optimize Catalyst Life & NH₃ Distribution in Wastewater." In: Proceedings from the Selective Catalytic/Non-Catalytic Reduction Conference. Chattanooga, TN. (October 30). DCN 03360.
199. Xcel Energy. 2009a. Xcel Energy's Response to Questions Regarding Bay Front Plant. (28 April). DCN 06545A1.
200. Xcel Energy. 2009b. Xcel Energy's Response to Questions Regarding French Island Plant. (28 April). DCN 06545A2.

201. Xcel Energy. 2009c. Xcel Energy's Response to Questions Regarding Red Wing Plant. (28 April). DCN 06545A3.
202. Xcel Energy. 2009d. Xcel Energy's Response to Questions Regarding Wilmarth Plant. (28 April). DCN 06545A4.