

Tailings Cell Design Report Piñon Ridge Project Montrose County, Colorado



Prepared for:

Energy Fuels Resources Corporation

44 Union Boulevard, Suite 600

Lakewood, Colorado 80228



Submitted by:

Golder Associates Inc.

44 Union Boulevard, Suite 300

Lakewood, Colorado 80228

October 2008

073-81694.0003

Golder Associates Inc.
44 Union Boulevard, Suite 300
Lakewood, CO USA 80228
Telephone: (303) 980-0540
Fax: (303) 985-2080
www.golder.com



**TAILINGS CELL DESIGN REPORT
PIÑON RIDGE PROJECT
MONTROSE COUNTY, COLORADO**

Submitted to:

*Energy Fuels Resources Corporation
44 Union Boulevard, Suite 600
Lakewood, Colorado 80228*



Submitted by:

*Golder Associates Inc.
44 Union Boulevard, Suite 300
Lakewood, Colorado 80228*

October 2008

073-81694.0003

EXECUTIVE SUMMARY

Energy Fuels Resources Corporation (EFRC) is in the process of completing designs for a new uranium mill, termed the Piñon Ridge Project, located in Montrose County, Colorado. Golder Associates Inc. (Golder) was contracted to provide geotechnical design for construction of the tailings cells, evaporation ponds and ore pads at the Piñon Ridge Project. Golder's tailings cell design scope of work includes:

- Conducting a geotechnical field and laboratory investigation of the proposed tailings cell areas (Golder, 2008a);
- Reviewing available data and regulatory requirements, and development of project design criteria;
- Evaluation of tailings cell alternative layouts and selection of the preferred alternative;
- Conducting engineering analyses and design for the tailings cells, including design of liner systems, underdrain system, leak collection and recovery system, water balance, and stability evaluations; and
- Development of design drawings and specifications for three tailings cells with a total combined capacity to contain tailings at a production rate of 500 tons per day (tpd) and a mill life of approximately 40 years, with expansion capacity for a production rate of 1,000 tpd.

The tailings cells are designed to have a total capacity of approximately 7.3 million tons (Mt). Three tailings cells (A, B, and C) of approximately equal tailings storage volume have been designed to meet this total capacity. The plan area of the lined portions of each tailings cell is 30.5 acres. Tailings Cell A has been designed as essentially two ponds within a pond, with a central divider berm constructed to mid-height of the facility, and two independent leak collection and recovery systems and tailings underdrain systems. The purpose for dividing this cell is to allow contingency storage in the early years of production in case the liner system within one of the sub-cells is not operating properly and requires inspection and/or repair. Expansion Tailings Cells B and C are each designed as single cells, with one leak collection and recovery system in each cell, as well as one underdrain outlet location. However, depending upon operations at the time of construction, Tailings Cells B and/or C may be constructed with a split cell configuration similar to Tailings Cell A.

Based on a production rate of 500 tpd, each tailings cell has a design life of approximately 13 years and a minimum capacity to accommodate storage of 2.45 Mt of tailings with three feet of freeboard.

The tailings cells are designed as permanent, zero-discharge, single-use facilities and are lined accordingly.

The tailings cells are designed for stability and tailings containment under static and seismic (pseudo-static) loading conditions for both operating and post-closure conditions. The tailings will be deposited into the cells via pumping from the mill to perimeter discharge pipes located at the surface of the active tailings cells, feeding perforated drop pipes extending down the lined slope on textured geomembrane rubsheets. Near the end of tailings deposition within each of the tailings cells, tailings discharge pipes will be extended onto the tailings beach to allow discharge near the center of the cells, assisting in development of grades consistent with the proposed closure cover design (presented elsewhere).

The tailings cells are each designed with a primary and secondary liner system, an intervening leak collection and recovery system, and a tailings underdrain system, consistent with the State of Colorado Rules and Regulations Pertaining to Radiation Control (6 CCR 1007-1, Part 18). Additionally, the tailings pool within each cell will be equipped with a surface water pump-back system as the water input rate is expected to exceed the rate at which water can percolate through the tailings to the underdrain system.

Leak collection and recovery system (LCRS) sumps have been included in the design of each tailings cell, with Tailings Cell A having two LCRS sumps. The LCRS design provides for capture and conveyance of the seepage through the upper (primary) tailings cell liner to a sump. Water collected in the LCRS sumps will be pumped back into the tailings pond. A critical consideration of this system is to maintain minimal hydraulic head on the lower (secondary) composite liner, thereby preventing a driving hydraulic force required for any seepage to occur to the environment.

Per Criterion 5E(3) of 6 CCR 1007-1, Part 18, Appendix A, the tailings cells have been designed with an underdrain system installed on top of the primary geomembrane liner at the base of the impoundment. This feature provides added effectiveness to the proposed liner system by lowering the hydraulic pressure within the overlying tailings, thereby reducing the driving head for seepage.

TABLE OF CONTENTS

EXECUTIVE SUMMARY ES-1

1.0 INTRODUCTION 1

 1.1 Property Location 1

 1.2 Tailings Cell Facility Alternatives Analyses 2

2.0 GENERAL SITE CONDITIONS 4

 2.1 Climate 4

 2.2 Seismicity 5

 2.3 Geotechnical Conditions 5

3.0 TAILINGS CELL DESIGN 7

 3.1 Design Criteria 7

 3.1.1 Design Regulations 7

 3.1.2 Project Design Criteria 7

 3.2 Design Concepts 9

 3.2.1 General Tailings Cell Design Concepts 9

 3.2.2 Surface Water Control Design Concepts 10

 3.2.3 Closure Design Concepts 10

 3.3 Liner System Design 11

 3.3.1 Upper (Primary) Liner 11

 3.3.2 Leak Collection and Recovery System 13

 3.3.3 Lower (Secondary) Composite Liner System 13

 3.4 Underdrain Design 15

 3.5 Leak Collection and Recovery System Design 16

 3.6 Stability Evaluation 17

 3.7 Water Balance Modeling 18

 3.8 Tailings Deposition Modeling 19

4.0 CONSTRUCTION CONSIDERATIONS 21

 4.1 Confirmatory Testing 21

 4.2 Electrical Leak Integrity Survey 21

 4.3 Tailings Deposition 22

 4.4 Geomembrane Exposure 23

 4.4.1 Exposure Period and Consequences 23

 4.4.2 Background on the Science 23

 4.4.3 Summary 24

 4.5 GCL Underliner Construction Considerations 25

5.0 USE OF THIS REPORT 27

6.0 REFERENCES 28

LIST OF TABLES

Table 1	Monthly Precipitation and Evaporation Values
Table 2	Results of Stability Evaluation

LIST OF FIGURES

Figure 1	Tailings Alternative – Option A
Figure 2	Tailings Alternative – Option B
Figure 3	Tailings Alternative – Option C
Figure 4	Tailings Cell Liner Concept
Figure 5	Tailings Cell Stage-Storage Relationship
Figure 6	Tailings Cell Water Balance Flow Sheet
Figure 7	Tailings Cell Deposition Model

LIST OF DRAWINGS

Drawing 1	Title Sheet with Drawing List and Location Map
Drawing 2	General Project Layout and Locations of Geotechnical Investigations
Drawing 3	Tailings Cell A Excavation Grading Plan and Isopach
Drawing 4	Tailings Cell B Excavation Grading Plan and Isopach
Drawing 5	Tailings Cell C Excavation Grading Plan and Isopach
Drawing 6	Tailings Cell Typical Sections
Drawing 7	Tailings Cell A Underdrain Plan and Sections
Drawing 8	Tailings Cells B and C Underdrain Plan and Sections
Drawing 9	Underdrain Sections and Details
Drawing 10	Leak Collection and Recovery System Sections and Details
Drawing 11	Tailings Facility Liner Details

LIST OF APPENDICES

Appendix A	Alternative Liner Flow Comparison
Appendix A-1	Flow Comparison Calculation
Appendix B	GCL Compatibility Testing
Appendix B-1	Compatibility Test Report – Polymer-Treated GCL
Appendix B-2	Compatibility Test Report – Standard GCL
Appendix C	Anchor Trench Evaluation
Appendix C-1	Geomembrane Wind Uplift Analyses
Appendix C-2	Anchor Trench Capacity Calculations
Appendix C-3	Design of Geomembrane Buttressing
Appendix D	Tailings Underdrain System Design
Appendix D-1	Filter Compatibility Analyses
Appendix D-2	Piping Crushing Calculations
Appendix E	Leak Collection and Recovery System Design
Appendix E-1	Leak Collection and Recovery System Sump Sizing
Appendix E-2	Piping Crushing Calculations

Appendix F	Action Leakage Rates
Appendix F-1	ALR Calculations
Appendix G	Chemical Resistance Information
Appendix G-1	Chemical Resistance Chart
Appendix H	Stability Evaluation
Appendix H-1	Global Stability Evaluation
Appendix H-2	Liner System Stability Evaluation
Appendix I	Tailings Cell Water Balance
Appendix I-1	Climatic Data Analysis
Appendix J	Tailings Deposition Modeling
Appendix K	Site-Wide Mass Balance
Appendix K-1	Site-Wide Mass Balance Calculations

1.0 INTRODUCTION

Energy Fuels Resources Corporation (EFRC) is in the process of completing designs for a new uranium mill, termed the Piñon Ridge Project, located in Montrose County, Colorado. Golder Associates Inc. (Golder) was contracted to provide geotechnical design for construction of the tailings cells, evaporation ponds and ore pads at the Piñon Ridge Project. Golder's tailings cell design scope of work includes:

- Conducting a geotechnical field and laboratory investigation of the proposed tailings cell areas (Golder, 2008a);
- Reviewing available data and regulatory requirements, and development of project design criteria;
- Evaluation of tailings cell alternative layouts and selection of the preferred alternative;
- Conducting engineering analyses and design for the tailings cells, including design of liner systems, underdrain system, leak collection and recovery system, water balance, and stability evaluations; and
- Development of design drawings and specifications for three tailings cells with a total combined capacity to contain tailings at a production rate of 500 tons per day (tpd) and a mill life of approximately 40 years, with expansion capacity for a production rate of 1,000 tpd.

The tailings cells are designed to have a total cumulative capacity of approximately 7.3 million tons (Mt). Three tailings cells (A, B and C) of approximately equal tailings storage volume have been designed to meet this total capacity. The plan area of the lined portions of each tailings cell is 30.5 acres.

1.1 Property Location

The Piñon Ridge Project is located in Montrose County, Colorado in the Paradox Valley, approximately 15 miles northwest of the town of Naturita on Highway 90. The physical address of the site is 16910 Highway 90, Bedrock, Colorado. The site coordinates are approximately latitude 38° 15' N and longitude 108° 46' W, at approximately 5,500 feet above mean sea level (amsl). The property is located within Sections 5, 8, and 17, Township 46 North, and Range 17 West. The site lies in the gently sloping base of the northwest-trending Paradox Valley with steep ridges on either side. Drawing 1 presents a general location map for the Piñon Ridge property.

1.2 Tailings Cell Facility Alternatives Analyses

As part of the work conducted by Golder, an alternatives analysis was conducted to evaluate various design options for the tailings cells. For the initial alternatives concept evaluation, only two tailings cells were considered (Tailings Cells A and B), each with a tailings storage capacity of 2.45 Mt. A third cell of approximately the same volume and dimensions of these tailings cells will be required to store the design tailings volume for the ultimate mine life. The primary focus of the alternatives analysis was to compare tailings cell design concept options:

- **Option A** – Balanced Below Grade Disposal (local cut-to-fill balance);
- **Option B** – Full Below Grade Disposal; and
- **Option C** – Mostly Below Grade Disposal (incorporating site-wide mass balance considerations, which include generating excess cut for future closure cover construction).

The three alternatives evaluated are presented in Figures 1, 2, and 3, respectively. Although 6 CCR 1007-1 Part 18, Appendix A, Criterion 3 states *“the ‘prime option’ for disposal of tailings is placement below grade,”* the regulations also state that *“flexibility is provided in the criteria to allow achieving an optimum tailings disposal program on a site-specific basis,”* and that the *“Department may find that the proposed alternatives meet the Department’s requirements if the alternative will achieve a level of stabilization and containment of the sites concerned...which is equivalent to, to the extent practicable, or more stringent than the level which would be achieved by the...standards promulgated by the Environmental Protection Agency in 40 CFR Part 192, Subparts D and E.”*

Based on site-specific considerations at the Piñon Ridge Project, Golder recommends construction of Option C, which is the mostly below grade disposal option with generation of excess cut for future closure cover construction, for all of the tailings cells. The primary reasons for this recommendation are:

- Full below grade disposal is most applicable to relatively flat, wide open sites where relatively shallow excavation depths over large areas can be used to generate fill as needed for miscellaneous construction activities as well as interim and long-term cover materials. The Piñon Ridge site is not well-suited for this application as it has a natural ground slope (approximately two percent) and the available area for the tailings cells is constrained by natural drainages, other important project facilities, and ultimately, the property boundary. To stay fully below grade with a sloping ground surface and the noted spaced limitations, a

substantial percentage of the excavation volume would be devoted to site leveling, without contributing materially to tailings storage and potentially impacting other facilities;

- A mostly below grade design will reduce the amount of excavated material to be stockpiled, temporarily or permanently, elsewhere on site. A large stockpile would be difficult to site within the property boundary without impacting natural drainages and/or other facilities;
- Though the depth to groundwater at the tailings cell location is in excess of 450 feet below the ground surface, the mostly below grade option results in a greater separation between groundwater and the base of the tailings cells than Option B;
- Improved surface water management, using the raised perimeter berms to divert and control upgradient runoff, such that the only surface water impacting the tailings cells is the result of direct precipitation (per Criterion 4A, 6 CCR 1007-1, Part 18, Appendix A);
- Potentially less wind disturbance of deposited tailings due to the presence of surrounding perimeter berms (per Criterion 4B, 6 CCR 1007-1, Part 18, Appendix A); and
- Shallow bedrock has been encountered in several areas across the tailings cell site, increasing the difficulty of attaining full below grade tailings disposal.

Accordingly, the recommended approach for tailings cell development includes achieving a site-wide material mass balance which accommodates construction of the mill facilities for the operational period, while also providing excess cut for future use as tailings cell closure cover materials. The site-wide mass balance is presented in Appendix K. This approach makes the best use of the available property, while limiting unnecessary site disturbance.

Further optimization of the tailings alternative evaluation resulted in design of Tailings Cell A as essentially two ponds within a pond, with a central divider berm constructed to mid-height of the facility, and two independent leak collection and recovery systems and tailings underdrain systems. The purpose for dividing this cell is to allow contingency storage in the early years of production in case the liner system within one of the sub-cells is not operating properly and requires inspection and/or repair. Tailings Cells B and C are each designed as single cells, with one leak collection and recovery system in each cell. However, depending upon operations at the time of construction, Tailings Cell B and/or C may be constructed in a similar manner to Tailings Cell A.

2.0 GENERAL SITE CONDITIONS

The Piñon Ridge Project is situated in the Paradox Valley of western Colorado at an approximate elevation of 5,500 feet above mean sea level (amsl). The site terrain slopes downward toward the north, with shallow to moderately incised arroyos across the property. The northern half of the site is generally covered in dense sagebrush while the southern half is sparsely vegetated with grass and cacti.

From a geological perspective, the Paradox Valley was formed by an anticline heavy in evaporites. As the evaporites began to dissolve, part of the anticline sank forming the Paradox Valley. The bedrock underlying the site primarily consists of claystone and gypsum of the Hermosa Formation. The gypsum generally shows a massive texture, whereas the claystone is typically highly fractured. Less significant zones of sandstone, conglomerate, and siltstone of the Cutler and Moenkopi Formations were also found during the field investigation. Groundwater in the vicinity of the tailings cells is greater than 450 feet below the ground surface.

2.1 Climate

The macro-climate of the Piñon Ridge Project area is classified by the Koppen Climate Classification System as a BSk, which indicates a semi-arid steppe with much of the characteristics of a desert (Kleinfelder, 2007a).

Meteorological towers have been installed on-site to provide baseline site data; however, on-site climatic data is not yet available. Golder conducted a review of climatic data obtained from the Western Regional Climate Center for the Uravan, Nucla, Grand Junction (Airport and 6 ESE), and Montrose weather stations. The evaluation of climate data for these nearby weather stations indicates that the Uravan weather station is likely to provide reasonable precipitation estimates for the site (see Appendix I-1). Climatic data available for the Uravan weather station included precipitation, air temperature, and snow cover for the years of record of 1960 through 2007.

The Hargreaves (1985) method was used to estimate monthly evaporation values at the Piñon Ridge site, using the available climate data from Uravan. The calculated evaporation values were scaled by a factor of 0.7 to represent lake evaporation. The average monthly climatic data used for design of the Piñon Ridge facilities is summarized in Table 1. Considering this climatic data, the annual evaporation exceeds annual precipitation on average by about three times.

The predominant wind directions for the site are east and east-southeast, with an average wind speed of 5.3 miles per hour (mph) (Kleinfelder, 2007b). The maximum wind speed used for facility design is 23.4 mph, which was recorded at the Grand Junction weather station (see Appendix I-1).

2.2 Seismicity

The design ground motions for the Piñon Ridge Project site were identified by Kleinfelder (2008), including a moment magnitude **M** 4.8 earthquake occurring at a distance of 15.5 kilometers (km) from the site. The design peak ground acceleration (PGA) is 0.11g. The Maximum Credible Earthquake (MCE) event corresponds to a PGA of 0.16g. Kleinfelder (2008) indicates that these values were derived from the International Building Code (IBC).

2.3 Geotechnical Conditions

Based on investigations by EFRC and their consultants, it appears that there have been no historical geotechnical investigations done on the site. Accordingly, EFRC initiated a geotechnical investigation to be conducted by Kleinfelder West Inc. (Kleinfelder) and Golder in accordance with Criterion 5(G)(2), 6 CCR 1007 Part 18 (Appendix A). Phase 1 of the investigation was directed by Kleinfelder to develop general characterization of the site. Phase 2 was conducted jointly by Kleinfelder and Golder to support geotechnical design work for the site, including the tailings cells.

As part of the Phase 1 geotechnical investigations, Kleinfelder drilled twenty (20) geotechnical boreholes (PR1-1 to PR-20) spaced across the site to depths ranging from 30.3 to 98.8 feet below the ground surface, installed six monitoring wells (MW-1 to MW-6) at depths of 100 to 600 feet below the ground surface, and completed three seismic reflection/refraction geophysical lines trending north-south across the site.

The Phase 2 geotechnical field investigation conducted by Golder (2008a) consisted of 48 drill holes and 11 test pits within the proposed tailings cells, evaporation pond, and ore pad areas. The geotechnical conditions encountered in the 26 drill holes (GA-BH-18 through GA-BH-43) completed in the tailings cell areas consisted of bedrock depths ranging from 13 feet to 103 feet. Bedrock was not encountered in several borings at exploration depths ranging from 44 to 70 feet. The overburden soils generally consist of windblown loess (i.e., ML, SM, SW) with occasional layers of alluvium (i.e., GW, ML, SM). Bedrock encountered generally consists of claystone, shale, gypsum and anhydrite of the Hermosa Formation; with conglomerate and sandstone of the Cutler Formation; and

sandstone, claystone, and conglomerate of the Moenkopi Formation interpreted in some locations. Blowcounts in the overburden materials underlying the tailings cell areas ranged from 9 to refusal (i.e., greater than 50 blows per 6 inches).

Findings from the geotechnical investigations reveal the following general site characteristics:

- Groundwater was encountered in two monitoring wells (MW-8 and MW-9) located approximately 870 feet and 340 feet, respectively, south of the tailings cell, with no groundwater encountered to the north of these wells. The depth to groundwater was on the order of 380 to 400 feet below the ground surface in these wells. However, it is believed that the water encountered in MW-9 which is nearest to the location of the tailings cells is not groundwater but instead interstitial water, as the low hydraulic conductivity of the unit (2.4×10^{-8} cm/sec) is representative of an aquitard instead of an aquifer. The groundwater has a high sulfur content.
- The site is underlain by a number of aquitards. Additionally, evaporite rock of the Hermosa Group, which does not host any measurable amount of water, underlies the area of the site that is the proposed location of the tailings cells. These site-specific factors significantly reduce any potential impact to groundwater during the Mill's "Active Life" (as defined in Criterion 5A of Appendix A to include the closure period).
- While the geophysical investigation identified some possible fault traces underlying the proposed mill and tailings cell areas, trenching and mapping confirmed that these features are overlain by a minimum of 20 feet of undisturbed alluvial/colluvial soil. Accordingly, this data evidences that the possible faults are at least 10 million years old which demonstrates that the possible faults are not capable faults as defined in section III(g) of Appendix A of 10 CFR Part 100.

3.0 TAILINGS CELL DESIGN

This section provides the engineering analyses and technical details to support design of the tailings cells for the Piñon Ridge Project.

3.1 Design Criteria

3.1.1 Design Regulations

Regulations relevant to the design of the uranium tailings cells presented here in Section 3.0 are summarized below.

Key Regulatory Agencies and Documents:

Colorado Department of Public Health and Environment (CDPHE): 6 CCR 1007-1, Part 18 – “*State Board of Health Licensing Requirements for Uranium and Thorium Processing,*” specifically Appendix A (Criteria relating to the operation of mills and the disposition of the tailings or wastes from these operations).

Environmental Protection Agency (EPA): 40 CFR Part 264 – “*Standards for Owners and Operators of Hazardous Waste Treatment, Storage, and Disposal Facilities,*” Subpart K (Surface Impoundments); and 40 CFR Part 192 – “*Health and Environmental Protection Standards for Uranium and Thorium Mill Tailings,*” Subpart D (Standards for management of uranium byproduct materials pursuant to section 84 of the Atomic Energy Act of 1954, as amended).

Note: Per Rule 17 (Exempt Structures) of the State of Colorado, Department of Natural Resources, Division of Water Resources (Office of the State Engineer [OSE], 2007) “Rules and Regulations for Dam Safety and Dam Construction,” uranium mill tailings dams are exempt from these rules with permitting authority provided by the Colorado Department of Public Health and Environment (CDPHE).

3.1.2 Project Design Criteria

Design criteria relevant to the analyses presented here in Section 3.0 are summarized below.

Geometry:

Number of Tailings Cell Expansion Phases: Three (3), with each expansion having a plan area of 30.5 acres.

Milling Operations: Design capacity of 500 tons per day (tpd) of tailings disposal, with potential expansion capacity to 1,000 tpd.

Tailings Storage Capacity: Minimum 2.45 million tons (Mt) per cell, for a total minimum capacity of 7.3 Mt.

Mine Design Life: 40 years (dependent upon milling rate).

Beach Slope: Beach slope assumed as compound slope with 5 percent for the first 50 feet horizontally, 2 percent to the pool, followed by a 10 percent slope below the pool surface (10 feet depth), and 0.5 percent in the slimes zone. Prior to cell closure, tailings discharge pipes will be extended from the cell perimeter to the cell center, changing the beach slope characteristics and more efficiently utilizing the available tailings storage space.

Perimeter Access Road Width (includes allowance for berms): 15 feet.

Tailings Properties:

Average In-Place Tailings Dry Density: 95 pounds per cubic foot (pcf).

Tailings Percent Solids: 27.3 percent by weight (slurry density) (CH2M Hill, 2008).

Tailings Gradation: Tailings are anticipated to classify according to the Unified Soil Classification System (USCS) as silty sand (SM).

Tailings Solution: Sulphuric acid leach with a pH generally ranging between 1.8 and 2.

System Requirements:

Tailings Cell Liner System: Double layer liner system as follows (top to bottom): (1) upper (primary) geomembrane liner; (2) leak collection and recovery system; (3) lower (secondary) geomembrane liner; underlain by (4) minimum 3 feet of low permeability soil liner with a hydraulic conductivity no more than 1×10^{-7} centimeters per second (cm/sec), or approved equivalent (per 40 CFR 264.221 by reference from 10 CFR 40 and 6 CCR 1007-1, Part 18).

Leak Collection and Recovery System: Per 40 CFR 264.221 (by reference from 10 CFR 40 and 6 CCR 1007-1, Part 18), the leak detection system shall meet the following requirements: (1) constructed with a bottom slope of one percent or more; (2) constructed of granular drainage materials with a hydraulic conductivity of 1×10^{-1} cm/sec or greater and a thickness of 12 inches or more, or constructed of a synthetic or geonet drainage material with a transmissivity of 3×10^{-4} square meters per second (m^2/sec) or more; (3) constructed of materials that are chemically resistant to the waste and leachate; (4) designed and operated to minimize clogging during the active life and post-closure care period; and (5) constructed with sumps and liquid removal methods (i.e., pumps).

Underdrain System: Per Criterion 5E of 6 CCR 1007-1 (Part 18, Appendix A), tailings must be dewatered by a drainage system installed on top of the primary liner at the bottom of the impoundment to lower the phreatic surface and reduce the driving head of seepage, unless tests show tailings are not amenable to such a system.

Seismic Design:

Maximum Credible Earthquake (MCE): 0.161g peak ground acceleration (PGA) based on a Magnitude 4.8 earthquake at 15.5 km (Kleinfelder, 2008).

Design Earthquake (DE): 0.107g PGA based on two-thirds of MCE PGA (Kleinfelder, 2008).

Stability Requirements:

Minimum Static Factor of Safety: 1.5 (industry standard practice).

Minimum Pseudo-static Factor of Safety: 1.1 (industry standard practice).

3.2 Design Concepts

This section presents the general tailings cell design concepts with the technical details for these concepts discussed in detail in the following sections.

3.2.1 General Tailings Cell Design Concepts

The Piñon Ridge Mill is designed to operate at 500 tons per day (tpd) with an expected life of 40 years. The tailings cells have been designed to provide capability for expansion to 1,000 tpd operations. Each of the three proposed tailings cells have been designed (i) to provide capacity for 13.3 years, (ii) with plan footprint areas of 30.5 acres, and (iii) minimum capacity to accommodate storage of 2.45 million tons (Mt) of tailings with three feet of freeboard. Applicable criteria of 6 CCR 1007-1, Part 18, Appendix A have been considered in the tailings cell investigation and design work.

The tailings cells were designed for construction predominantly in the existing subgrade, with a combined total excess cut of approximately 2.5 million cubic yards (cy) dedicated primarily to future closure cover construction. The excess cut material will be stockpiled on the west side of the site (see proposed soil stockpile locations illustrated on Drawing 2), or used in construction of other site facilities. The tailings cells were developed by designing a perimeter embankment with a width of 15 feet to facilitate berms and one-way light truck traffic. The top elevations of the tailings cell perimeter berms are 5525 ft amsl, 5511 ft amsl, and 5496 ft amsl for Tailings Cells A, B, and C, respectively. The tailings cells have internal side slopes of 3H:1V, and a minimum base grade of one percent. The limits of the tailings cells are lined with a double layer liner system with an intervening leak collection and recovery system to contain process solutions, enhance solution collection, and protect the groundwater regime. Intermediate benches have been incorporated in the design to

provide additional anchorage of the underlying geosynthetic clay liner (GCL) component of the liner system (discussed in Section 3.3.4), as well as buttressing of the liner to limit wind uplift.

As a precautionary measure, Tailings Cell A has been designed as a split cell to facilitate separate collection of process solutions for redundancy during facility start-up if unforeseen problems with the liner system develop, allowing half of the cell to be decommissioned and repaired while continuing mill operations. Tailings Cells B and C may also be designed as split cells, depending on operations at the time of construction.

3.2.2 Surface Water Control Design Concepts

Surface water design for the Piñon Ridge Mill includes diversion around the license boundary, including diversion around the tailings cells. Site-wide surface water design was conducted by Kleinfelder, and will be presented under separate cover. Surface water run-on into the tailings cells is limited to surface water run-off from the perimeter access roads and direct precipitation onto the tailings cells.

3.2.3 Closure Design Concepts

The tailings cells for the Piñon Ridge Project have been designed to consider closure and to integrate the design for compatibility with the following concepts:

- Minimize the need for long-term active site care and maintenance during the post-closure period;
- Perimeter berms developed with external side slopes of 10H:1V (per Criterion 4C of 6 CCR 1007-1, Part 18, Appendix A);
- Placement of an interim cover over the tailings as deposition is complete within the tailings cell to limit exposure to radiation until construction of the final cover;
- Dewatering of the tailings as feasible prior to placement of closure cover materials;
- Provide additional capacity within the tailings cells to accommodate future closure considerations, such as disposal of the liner systems removed from the evaporation ponds and ore pads, etc., during site closure activities; and
- Construction of a final closure cover which meets the requirements of Criterion 4D (6 CCR 1007-1, Part 18, Appendix A) with regard to erosion protection, as well as limiting radon flux to acceptable levels (per Criterion 6, 6 CCR 1007-1, Part 18, Appendix A), design of which is presented under separate cover.

3.3 Liner System Design

As noted in Section 2.3, investigative drilling did not encounter the presence of any aquifers beneath the planned location of the tailings cells. The nearest discovery of groundwater was to the southeast of the proposed tailings cell location. Additionally, a number of aquitards were identified during the geotechnical field investigation, further limiting any potential impacts to the groundwater regime during the Active Life of the Mill. Despite this site specific characteristic, the tailings cells were nevertheless designed with the standards applicable to hazardous waste treatment, storage and disposal facilities in accordance with 40 CFR 264.221, by reference from 10 CFR 40 and 6 CCR 1007-1 (Part 18), and utilize a double layer liner system with an intervening Leak Collection and Recovery System (LCRS) for groundwater protection, as follows (from top to bottom) (see Figure 4):

- 60-mil high density polyethylene (HDPE) upper (primary) geomembrane;
- LCRS consisting of HDPE geonet on the base of the tailings cells, and a drainage geocomposite on the side slopes;
- 60-mil HDPE lower (secondary) geomembrane;
- Reinforced geosynthetic clay liner (GCL) as the underliner component of the secondary composite liner system; and
- Prepared subgrade.

Liner system details for the tailings cell slope liner and base liner systems are provided as details 2 and 3, respectively, on Drawing 11.

3.3.1 Upper (Primary) Liner

The upper primary liner will consist of a conductive textured 60-mil HDPE geomembrane. An HDPE geomembrane liner was chosen for its long-term performance characteristics. It has excellent chemical resistance properties (see Chemical Resistance Chart in Appendix G), resistance to ultraviolet (UV) radiation, high tensile strength, and high stress-crack resistance (Lupo & Morrison, 2005). Single-sided texturing (textured side down) on the upper primary geomembrane is considered to increase frictional resistance at the contact with the LCRS layer. Textured rubsheets will be extrusion welded where required by mill operations to facilitate tailings deposition and access during operations.

Interface shear testing was conducted to evaluate the performance and stability of the proposed HDPE geomembrane versus drainage geocomposite material. Results of interface shear testing are presented in Golder (2008a), with results from the critical interfaces utilized in the stability evaluation calculation (provided in Appendix H). The peak friction angle for the geomembrane/drainage geocomposite interface is 21 degrees, which compared to the proposed slope angle of 18.4 degrees (i.e., 3H:1V) indicates a stable liner system with a local short-term factor of safety of at least 1.2 (see Appendix H-2). Anchor trenches, anchor benches, and buttressing of the liner were incorporated into the design to further enhance stability of the liner system, as discussed in detail in Appendix C.

With operations at the mill proceeding at the design rate of 500 tpd, the upper portion of the tailings cells could be exposed for 13 to 14 years. Considering this potential long-term exposure combined with the long slope runs and large lined area (i.e., 30.5 acres), the liner system was designed for long-term exposure to solar radiation. The upper primary geomembrane liner has been designed with the upper exposed side of the liner covered with a light-reflective surface. The light-reflective surface is resistant to ultraviolet radiation and coextruded with the primary black geomembrane liner. All of the physical properties of a standard black HDPE geomembrane remain the same but the light-reflective design feature provides the following benefits (www.gseworld.com):

- Minimizes wrinkles caused by liner expansion thereby reducing the risk of damage to liner resulting from wrinkles;
- Reduces heat build-up and thermal expansion of the liner by reflecting solar radiation;
- Reduces desiccation effects to the subgrade soil materials; and
- Improves detection of installation damage.

The light-reflective surface layer is approximately 5 mils thick. If damage to the geomembrane occurs, the black primary layer of the geomembrane will be exposed, making visual inspection of liner defects more reliable. This design enhancement, while not necessary, will reduce UV degradation and should also improve constructability, aid quality assurance, and improve system performance. To further ensure quality assurance during installation of the liner system, the upper primary geomembrane liner will be conductive to facilitate spark testing of the liner surface upon completion of the installation.

3.3.2 Leak Collection and Recovery System

An important feature of the tailings cell liner system is the Leak Collection and Recovery System (LCRS) layer, designed per 40 CFR 264.221 (by reference from 10 CFR 40 and 6 CCR 1007-1, Part 18). The LCRS is designed to minimize the hydraulic heads on the lower geomembrane liner by utilization of HDPE geonet in the base of the tailings cells and a drainage geocomposite on the side slopes. The drainage geocomposite is comprised of a geonet laminated on both sides to a nonwoven geotextile filtration media to increase frictional resistance with the overlying and underlying textured geomembrane liners.

In the event that leakage occurs through the upper geomembrane liner, it will be collected in the LCRS layer and routed (via gravity flow) to a LCRS sump located in each tailings cell (or sub-cell in the case of a divided tailings cell). The LCRS design is discussed in greater detail in Section 3.5.

3.3.3 Lower (Secondary) Composite Liner System

Beneath the LCRS layer is a 60 mil HDPE secondary geomembrane liner. This liner provides secondary containment of process solutions should leakage occur through the upper primary geomembrane liner. The lower secondary geomembrane liner will be double-sided textured to increase frictional resistance with the overlying LCRS layer and the underlying low permeability GCL layer.

The lower secondary geomembrane liner will be underlain by a GCL, which consists of a layer of sodium bentonite encapsulated between two geotextiles with an upper woven geotextile and lower nonwoven geotextile, needle-punched together to form a hydraulic barrier material (i.e., CETCO Bentomat ST, or equivalent). The GCL is approximately 0.4 inches thick with a reported hydraulic conductivity of 5×10^{-9} centimeters per second (cm/sec). Since the mid-1980s, GCLs have been increasingly used as an alternative to compacted clay liners on containment projects due to ease of construction/installation, resistance to freeze-thaw and wet-dry cycles, and relatively low cost.

Interface shear testing was conducted to evaluate the performance and stability of the HDPE geomembrane versus the proposed GCL underliner (i.e., Bentomat ST with woven side up). The local stability of the textured HDPE geomembrane versus the proposed drainage geocomposite is discussed in Section 3.3.1. Results of interface shear testing are presented in Golder (2008a), with results from the critical interfaces utilized in the stability evaluation calculation (provided in

Appendix H). The peak friction angle for the geomembrane/GCL interface is 23 degrees, which compared to the proposed slope angle of 18.4 degrees (i.e., 3H:1V) indicates a stable liner system with a local short-term factor of safety of at least 1.3 (see Appendix H-2). Anchor trenches, anchor benches, and buttressing of the liner were incorporated into the design to further enhance stability of the liner system, as discussed in detail in Appendix C.

Compatibility testing of the proposed GCL with the anticipated tailings solution chemistry provided by the process designers (CH2M Hill, 2008) was conducted by TRI/Environmental, Inc. (TRI) under contract to CETCO Lining Technologies (CETCO), the manufacturer of the proposed GCL material. Results of this testing program indicate that the anticipated tailings leachate may result in an increase to the permeability of the standard GCL from 5×10^{-9} cm/sec to approximately 1.1×10^{-8} cm/sec. Testing of a polymer-treated GCL in contact with the anticipated tailings leachate indicates negligible change in GCL permeability. A more detailed description of the GCL compatibility testing program is provided in Appendix B.

An analysis was conducted using the method proposed by Giroud et al. (1997) to demonstrate that the secondary composite liner system consisting of a 60 mil HDPE geomembrane overlying a GCL has equivalent or improved fluid migration characteristics when compared to a secondary composite liner system consisting of a 60 mil HDPE geomembrane overlying the prescriptive compacted clay liner (i.e., 3 feet of 10^{-7} cm/sec soil, per 40 CFR 264.221). Based on this site-specific analysis (included in Appendix A), which accounts for the loading conditions and anticipated head on the secondary liner system, as well as the potential for an increase in the GCL hydraulic conductivity in the unlikely event that leakage through both the primary and secondary geomembrane liners occurred in sufficient quantity to saturate the GCL with tailings leachate, the amount of flow through the secondary liner system with the prescriptive compacted clay liner was evaluated to be nearly five times greater than the flow through the secondary liner system with a standard GCL underliner, and more than eight times greater than the flow through the secondary liner system with a polymer-treated bentonite GCL underliner. Therefore, the secondary liner system containing a standard GCL performs better than the secondary liner system containing the prescriptive clay liner, and the use of a polymer-treated bentonite within the GCL is not warranted.

3.4 Underdrain Design

Per Criterion 5E(3) of 6 CCR 1007-1, Part 18, Appendix A, the tailings cells have been designed to facilitate dewatering of the tailings (i.e., lower the phreatic surface and reduce the driving head for seepage) via an underdrain system installed at the base of the impoundment. Based on information available, the tailings are expected to consist of silty sand to sandy silt materials, which are considered amenable to dewatering, particularly if some segregation by particle size results from deposition as dilute slurry. The tailings underdrain system is comprised of the following components:

- Perforated corrugated HDPE collection pipes (8-inch diameter) to convey fluids to the underdrain sump. The pipes will be placed in trenches, which are backfilled with imported granular drainage materials;
- An underdrain sump constructed above the leak collection and recovery system sump with a depth of 2 feet to provide head for pumping of collected seepage. The sump will be backfilled with coarse underdrain fill overlain by fine underdrain fill to ensure filter compatibility with the overlying tailings; and
- Two underdrain riser pipes within each sump to add redundancy to the system, consisting of two 10-inch diameter, SDR-11 HDPE pipes. The lower ends of the pipes are slotted in the sump area to provide solution access into the risers. Solution is recovered via an automated submersible pump installed in the riser (designed by others). Collected solutions will be returned to the mill circuit.

The underdrain collection trenches and underdrain sump area will be backfilled with granular drainage materials, with an underlying coarse underdrain fill in contact with the underdrain collection pipes and slotted portion of the underdrain riser pipes, and an overlying fine underdrain fill. The underdrain fill zones (coarse and fine) have been designed for filter compatibility with each other, the pipe perforations, and the overlying tailings materials. The filter design calculations are provided in Appendix D-1.

The perforated corrugated HDPE underdrain collection pipe and the solid HDPE underdrain riser pipes are designed according to the Burns & Richard (1964) method to resist crushing and wall buckling due to the anticipated loading associated with the maximum height of overlying tailings. The pipe deformation analyses are presented in Appendix D-2.

A cushion geotextile has been incorporated within the underdrain collection trenches and underdrain sump to protect the underlying primary HDPE geomembrane liner from puncture due to the overlying

underdrain drainage materials, and the anticipated loading conditions associated with the maximum height of the overlying tailings.

The underdrain sump, constructed above the LCRS sump, will include two sideslope underdrain riser pipes per underdrain sump for redundancy. The underdrain riser pipes will allow installation of a submersible pump for manual collection of tailings liquids. An underdrain plan for Tailings Cell A is included on Drawing 7, while underdrain plans for Tailings Cells B and C are included on Drawing 8. Note that Tailings Cells B and C may be constructed as a divided cell, depending on operations at the time of construction, and therefore the underdrain layout would replicate that of Tailings Cell A. Underdrain sump, riser pipe, and collection trench details are included on Drawing 9.

3.5 Leak Collection and Recovery System Design

As part of the tailings cell design, a leak collection and recovery system (LCRS) has been incorporated to meet the requirements of the regulations. If a leak occurs in the upper primary geomembrane, the LCRS is designed to minimize the hydraulic heads on the lower geomembrane liner. Details of the leak collection and recovery system are shown on Drawing 10.

The LCRS layer has been designed as an HDPE geonet on the base of the tailings cells, and a drainage geocomposite on the side slopes. The drainage geocomposite is comprised of a geonet laminated on both sides to a nonwoven geotextile filtration media to increase frictional resistance with the overlying and underlying textured geomembrane layers. The geonet and drainage geocomposites have been designed with transmissivities of 6×10^{-3} square meters per second (m^2/sec) and 2.5×10^{-3} m^2/sec , respectively, which exceeds the minimum transmissivity requirement of 3×10^{-4} m^2/sec (per 40 CFR 264.221). The drainage layer is designed with a thickness of 275 mil (see calculations provided in Appendix A). Beneath the LCRS layer is a 60 mil HDPE secondary geomembrane liner. This liner provides secondary containment of process solutions should leakage occur through the primary 60-mil HDPE upper geomembrane liner.

In the event that leakage occurs through the upper geomembrane liner, it will be collected in the LCRS layer and routed (via gravity flow) to a LCRS sump located in each tailings cell (or sub-cell). The LCRS sumps were conservatively sized for eight (8) hours of maximum flow in the LCRS layer (i.e., geonet or drainage geocomposite) assuming one liner defect per acre for good installation (Giroud & Bonaparte, 1989), an effective porosity of 30 percent in the sump (i.e., available pore

space within the gravel backfill materials), and applying a factor of safety of 1.5. The LCRS sump sizing calculations are provided in Appendix E-1. Based on these calculations, a sump with base dimensions of 10 feet by 10 feet with 3H:1V side slopes and 5-foot depth provides sufficient containment for leak solutions.

Two LCRS risers are provided within each sump to add redundancy to the system. The risers consist of two 10-inch diameter, SDR-17 HDPE pipes. The lower ends of the pipes are slotted in the sump area to provide solution access into the risers. Solution is recovered via an automated submersible pump (designed by others) installed in the riser. The LCRS risers will be instrumented and fully automated to report to the mill control system with an alarm in the mill. Recovered solutions will be returned to the tailings cells, and then to the mill circuit via tailings return pumps. The perforated solid HDPE LCRS riser pipes are designed according to the Burns & Richard (1964) method to resist crushing and wall buckling due to the anticipated loading associated with the maximum height of overlying tailings (see Appendix E-2).

Action Leakage Rates (ALRs) were evaluated for each of the LCRS sumps using the guidelines published by the U.S. Environmental Protection Agency (EPA, 1992). The ALR is defined in 40 CFR 264.222 as “*the maximum design flow rate that the leak detection system (LDS) can remove without the fluid head on the bottom liner exceeding 1 foot.*” The ALR calculations are provided in Appendix F. Based on these calculations, the ALR for the LCRS sumps contained within Tailings Cells A1 and A2 is 4,705 gallons per acre per day (gpad), and the ALR for the LCRS sumps contained within Tailings Cells B and C is 2,376 gpad.

3.6 Stability Evaluation

In addition to the local liner interface stability analyses discussed in Sections 3.3.1 and 3.3.3, Golder conducted global stability analyses for the proposed tailings facility. These analyses are presented in detail in Appendix H. Three cross-sections were developed to represent a typical section through a tailings cell at three critical points in time: (i) end of tailings cell construction (prior to tailings deposition), (ii) post-tailings deposition, and (iii) post-closure of the tailings cell.

Stability analyses were conducted using RocScience’s limit equilibrium program *SLIDE* (RocScience, 2000). Stability analyses considered both circular and non-circular slip surfaces when searching for

the critical surface with the minimum factor of safety (*FS*). The stability analyses utilized the Spencer method (Spencer, 1967).

The pseudo-static coefficient for the stability analyses was developed by Kleinfelder (2008) for this evaluation based on the 2006 International Building Code (IBC). This seismicity analysis concluded that the peak ground acceleration (PGA) for the Maximum Credible Earthquake (MCE) is 0.161g. The peak ground acceleration for the design earthquake is 0.107g. Hence, the pseudo-static acceleration used in the stability analyses for operational considerations was 0.05g, or approximately one-half of the design earthquake PGA (Hynes & Franklin, 1984). For the post-closure analyses, the pseudo-static coefficient was increased to 0.08g, half of the PGA for the MCE.

The limit equilibrium stability analyses yielded the estimated minimum safety factors summarized in Table 2 for static and pseudo-static loading conditions for all three evaluated scenarios. As indicated, the stability analyses show that the static and pseudo-static critical failure surfaces have factors of safety greater than the minimum allowable values of 1.5 under static loading conditions, and 1.1 under pseudo-static loading conditions.

3.7 Water Balance Modeling

A probabilistic water balance was developed for the tailings cell design to estimate the available quantity of make-up water available for reclaim using the computer program *Goldsim*TM. The water balance is presented in detail in Appendix I.

Since three tailings cells (Cells A, B, and C) of approximately equal tailings storage volume and dimensions have been designed for the Piñon Ridge Project to meet the total design capacity of 7.3 Mt, the probabilistic water balance has been performed only for a single tailings cell (i.e., Tailings Cell A). The water balances for the other tailings cells would produce similar results. Each of the tailings cells is designed for 13.3 years based on a milling capacity of 500 tpd (with expansion capabilities to 1,000 tpd).

For the purpose of developing the water balance for the tailings cell, the following components were considered: (1) the amount of water entering the tailings cell from the mill in the tailings slurry (i.e., based on 27.3 percent solids by weight), (2) water entering the system through meteoric precipitation, (3) the amount of water released to the atmosphere through evaporation, (4) the amount of water

returning to the mill from the tailings cell (provided by CH2M Hill), and (5) the excess water available to be pumped from the tailings cell as mill make-up or sent to the evaporation pond system. Figure 6 presents the tailings cell water balance flow sheet.

3.8 Tailings Deposition Modeling

Tailings deposition within Tailings Cell A was modeled using Golder's proprietary software *GoldTail*. The purpose of the tailings deposition modeling is to provide mill operations personnel with a method for tailings discharge which enhances design of the tailings cells by providing protection to the constructed underdrain system from potential slimes clogging, as well as provides initial buttressing to the geomembrane liner system. The tailings deposition modeling is presented in Appendix J.

Tailings deposition was modeled within Tailings Cell A in the following five simplified phases:

- Phase 1 – Deposition commences within sub-cell A1 (or A2) in the vicinity of the underdrain sump to provide approximately 10 feet of tailings deposition over the sump area. This phase of deposition provides coarse-grained underflow tailings over the underdrain sump to enhance the effectiveness of the tailings underdrain system;
- Phase 2 – Continued deposition within the remainder of the first sub-cell to push the pond toward the sump area;
- Phase 3 – This phase was modeled with deposition commencing within the other sub-cell in the vicinity of the underdrain sump, again providing approximately 10 feet of coarse-grained underflow tailings over the underdrain sump area. During actual operations, Golder recommends reversing the order of the modeled Phases 2 and 3 in order to buttress the geomembrane liner system within both sub-cells at the on-set of operations, prior to completely filling the first sub-cell;
- Phase 4 – Continued deposition within the remainder of the second sub-cell to push the pond toward the sump area; and
- Phase 5 – Once both sub-cells are filled, tailings deposition will proceed along the perimeter of the entire tailings cell in stages (as dictated by tailings operations), until the tailings cell is full (with 3 feet of freeboard provided at the perimeter of the cell).

The perimeter discharge of Phase 5 will leave a depression in the center of the cell resulting from the tailings beach slopes and perimeter discharge arrangement. Although not modeled, a sixth and final phase of deposition would involve extending the tailings discharge pipes to the center of the cell to more efficiently use the available tailings storage space, and develop grades which support closure cover construction.

4.0 CONSTRUCTION CONSIDERATIONS

This section presents considerations for construction of the tailings cells. A number of these items were developed as a result of project meetings with the Colorado Department of Public Health and Environment (CDPHE) during the course of the design, especially those that relate to Construction Quality Assurance (CQA) and addressing CDPHE concerns regarding long-term exposure of the tailings cell liner system.

4.1 Confirmatory Testing

To support permitting-level design of the tailings cell liner system, interface shear testing was conducted using select geosynthetic materials (Golder, 2008a). If use of a geosynthetic material which was not tested is proposed for construction, interface shear testing is required prior to initiation of construction to confirm that the minimum required strength parameters are achieved for the various interfaces. It should be noted that interface shear testing was conducted using a drainage geocomposite material which differs from that specified for construction, as design calculations later revealed that the initially proposed drainage geocomposite did not meet design requirements. The Geosynthetic CQA Plan (Section 1400.2 of the Technical Specifications; Golder, 2008c) includes a requirement for confirmatory testing of the geosynthetic interfaces prior to procurement of geosynthetics for tailings cell construction.

4.2 Electrical Leak Integrity Survey

An electrical leak integrity survey will be conducted after completion of tailings cell liner installation, prior to tailings deposition. Requirements of the electrical leak detection survey have been incorporated into the Geosynthetics CQA Plan (Section 1400.2 of the Technical Specifications; Golder, 2008c).

At present, there are many ways of conducting electrical leak detection surveys of geomembranes. Some of these methods involve filling the lined area with water prior to testing, while others are only applicable to specific liner configurations (such as single liner systems and liners covered with soil). Based on the available methods (ASTM D 6747) and considering the limited supply of locally-available water as well as the expansive size of the tailings cells, the most appropriate method involves installation of an electrically conductive geomembrane as the primary geomembrane in the system.

Electrically conductive geomembrane is constructed with a thin conductive layer adhered to and underneath a polyethylene geomembrane, which is naturally non-conductive. Once installed, the exposed geomembrane is tested for leak paths according to ASTM D 7240 (Conductive Geomembrane Spark Test) in the following manner:

- The conductive (under) side of the geomembrane is charged; and
- A conductive element is swept over the upper surface of the geomembrane, creating a spark where potential leak paths exist. An alarm is built into the system to sound each time a spark is detected.

This system is capable of detecting leak paths smaller than 1 millimeter (mm) in diameter and repairs can be made immediately upon leak path detection. Due to the nature of the test and the fact that the conductive layers of adjacent rolls are not necessarily in good contact, traditional non-destructive seam testing is still needed. This test does not require the use of any water.

4.3 Tailings Deposition

At start-up of tailings deposition within each tailings cell (or sub-cell), the operations plan should provide for deposition to commence in the vicinity of the underdrain sump. The purpose of initiating deposition in this manner is to provide coarse-grained underflow material over the underdrain sump system, in contact with the underdrain filter materials. As discussed previously, the underdrain filter materials were designed for filter compatibility with each other and with the anticipated tailings stream; however, additional protection to the underdrain sump system would be provided by initial placement of the coarse-grained tailings materials over the system preventing clogging due to fine-grained tailings slimes. After initial placement of coarse-grained tailings in this area, then deposition would proceed to maintain the tailings pool area(s) above the underdrain sump(s).

When the tailings cell is constructed with two internal cells, as is the case with Tailings Cell A (and possibly Cells B and C), tailings should be placed within each of the sub-cells immediately after commencement of deposition in order to provide additional buttressing of the liner system. It is recommended to cover the floor of each of the sub-cells with tailings prior to discharging to a single sub-cell. Operations personnel may opt to discharge to both sub-cells simultaneously, which is considered appropriate, pending that initial deposition proceed as discussed.

4.4 Geomembrane Exposure

Where liner will be exposed to ultraviolet (UV) radiation for an extended period of time, such as the case of the tailings cells, standard practice for the mining industry includes incorporation of an upper exposed HDPE geomembrane liner (Golder, 2008b). The HDPE's resistance to UV radiation is one of the primary reasons that it was selected as the geomembrane for the tailings cell (and evaporation pond) construction at the Piñon Ridge Project. To further reduce the risk of UV damage, the upper primary geomembrane liner has been designed with a white light-reflective surface as discussed in Section 3.3.1. Refer to Golder (2008b) for a literature review and presentation of results supporting the use of HDPE geomembrane for the Piñon Ridge Project. Major points from Golder (2008b) are summarized in the following sections.

4.4.1 Exposure Period and Consequences

As tailings are deposited within each tailings cell, the surface area of exposed geomembrane will be reduced incrementally with time. The liner in the pond bottom will be exposed for a few months to a year, and the liner near the top of each cell will remain exposed for the full tailings cell design life. However, the upper perimeter portion of the exposed liner, which will have the greatest UV exposure, will be subject to the lowest operational loads from deposited tailings and stored water and will be required to provide hydraulic containment for only a short period before the cell is drained and decommissioned. Conversely, the lower, centrally located portion of the exposed liner, which will be called upon to resist the highest operational loads, will be exposed to degradation from UV radiation for only a short period. Therefore, considering the combination of potential loading conditions with the potential for degradation from UV exposure, the longer-term exposure of liner at the top of the cells represents, overall, a reduced potential to impact soil and groundwater at the site (Golder, 2008b). In addition, following closure, the cover will control infiltration into the cells, thereby limiting subsequent hydraulic loading on the liner system and further reducing the containment requirement.

4.4.2 Background on the Science

When exposed to atmospheric conditions, plastic materials containing impurities can absorb ultraviolet energy which can excite photons and create free radicals within the plastic (Zeus, 2005). These free radicals then proceed to degrade the plastic by causing a chain reaction of molecule damage that can accelerate breakdown of the material (Layfield, 2008). However, a variety of

methods are available to both limit the production of free radicals and inhibit the chain reaction of molecule degradation in plastics, including use of stabilizers, absorbers or blockers (Zeus, 2005).

HDPE geomembrane is manufactured with 2 to 3 percent carbon black, a material produced by the incomplete combustion of petroleum products, which provides protection to the geomembrane structure by blocking the degradation process (Layfield, 2008). The chemical properties of carbon black further act to absorb molecular-damaging free radicals, preventing them from causing additional damage. Carbon black is universally accepted as being resistant to significant deterioration caused by weathering for 50 years or more (GSE, 2003). In addition to carbon black, many HDPE manufacturers, such as GSE, utilize highly effective chemical UV stabilizers that further extend the life of the material to which it is added (GSE, 2003). Properly formulated and compounded polyethylenes, achieved through the use of carbon black and chemical stabilizers, have an estimated projected life in excess of 100 years for resistance to weathering due to exposure (GSE, 2003).

Koerner & Hsuan (2003) stated that HDPE geomembrane is quite possibly the most stable polymer, resulting in the longest lifetime, but that research is on-going. Review of the literature confirmed numerous cases of proposed and on-going research into the lifetime of HDPE geomembrane under exposed and unexposed conditions (e.g., Hsuan et al., 2005; Koerner et al., 2005a and 2005b; Jeon et al., 2005).

4.4.3 Summary

Evaluations of HDPE geomembrane from field performance and laboratory test data presented in Golder (2008b) provide evidence that exposure of a 60 mil HDPE geomembrane to UV for 20 or more years will not result in significant degradation of the geomembrane. The results of field tests of actual operating facilities utilizing HDPE geomembrane (Golder, 2008b) support the conclusion that the use of HDPE geomembrane as designed for the tailings cells will maintain sufficient integrity despite UV exposure during their estimated lifetimes. Laboratory test results presented in Golder (2008b) predict an even longer life and improved UV resistance for HDPE geomembrane, even when stabilized only with the standard percentages of carbon black (i.e., no additional antioxidants or UV stabilizers).

An additional design feature has been incorporated into the tailings cell design to further reduce the potential for UV damage to the exposed portion of the liner system. The upper primary

geomembrane liner includes a requirement for a light-reflective surface that is resistant to UV radiation and is coextruded with the primary black geomembrane liner. This design enhancement, while not necessary, will reduce UV degradation and should also improve constructability, aid quality assurance, and improve system performance.

It is important to note that standard HDPE geomembrane, without the additional feature of the light-reflective surface, is the industry standard-of-practice for design of mine facilities for exposed applications, such as evaporation ponds, process solution ponds, heap leach perimeter channels and tailings impoundments for mining operations (i.e., gold, uranium), and that the exposure periods are consistent with those proposed for the Piñon Ridge Project. Further, the portions of the tailings cell liner systems that will be exposed to UV radiation are located near the top of the cells, which are the least critical from a hydraulic containment standpoint (i.e., the hydraulic heads will be low to nonexistent during a short operating life followed by negligible hydraulic loading in the post-closure period). The base of the tailings cells, which will be subjected to the highest hydraulic heads, will be covered with tailings at the on-set of operations, and therefore exposed to UV radiation for a very short time.

4.5 GCL Underliner Construction Considerations

Due in part to the lack of locally-available low permeability soil sources for underliner, geosynthetic clay liner (GCL) has been designed as the underliner component of the secondary composite liner system for the tailings cells (see Section 3.3.3). Where geomembrane composite-lined slopes underlain by compacted clay liner materials have been exposed for long periods of time, desiccation and cracking of the clay component often occurs (Giroud, 2005). The use of GCL as the underliner component prevents the issue of clay desiccation, but shrinkage has been documented to occur due to long-term exposure (i.e., numerous drying [i.e., day] and hydration [i.e., night] cycles) of the liner system (Giroud, 2005). In addition to the use of white geomembrane to limit the temperature variations in the liner system, the design drawings and Technical Specifications (Golder, 2008c) include the following provisions to limit effects of GCL shrinkage within the tailings cells:

- Construction of anchor benches to provide additional anchorage to the GCL layer;
- Increasing the manufacturer-recommended longitudinal overlap from 6 inches to 12 inches; and

- Increasing the manufacturer-recommended end-of-roll overlaps from 2 feet to 4 feet.

In addition to the construction considerations discussed previously, pre-hydration of the GCL is provided during the construction process to enhance the permeability characteristics of the GCL. The reader is referred to Shackelford et al. (2000) for the benefits of prehydration of the GCL with regard to the resulting permeability. Prior to GCL placement, the subgrade soils will be moisture-conditioned and compacted to a minimum 95 percent of the standard Proctor (ASTM D 698) maximum dry density at optimum to plus 4 percent of the optimum moisture content. This recommended specification is based on the results of a study conducted by Bonaparte et al. (2002) which shows that prehydration of the GCL is obtained via subgrade moisture absorption.

5.0 USE OF THIS REPORT

This report has been prepared exclusively for the use of Energy Fuels Resources Corporation (EFRC) for the specific application to the Piñon Ridge Project. The engineering analyses reported herein were performed in accordance with accepted engineering practices. No third-party engineer or consultant shall be entitled to rely on any of the information, conclusions, or opinions contained in this report without the written approval of Golder and EFRC.

The site investigation reported herein was performed in general accordance with generally accepted Standard of Care practices for this level of investigation. It should be noted that special risks occur whenever engineering or related disciplines are applied to identify subsurface conditions. Even a comprehensive sampling and testing program implemented in accordance with a professional Standard of Care may fail to detect certain subsurface conditions. As a result, variability in subsurface conditions should be anticipated and it is recommended that a contingency for unanticipated conditions be included in budgets and schedules.

Golder sincerely appreciates the opportunity to support EFRC on the Piñon Ridge Project. Please contact the undersigned with any questions or comments on the information contained in this report.

Respectfully submitted,

GOLDER ASSOCIATES INC.



Kimberly Finke Morrison, P.E., R.G.
Senior Project Manager



James M. Johnson, P.E.
Principal, Project Director

6.0 REFERENCES

- 6 CCR 1007-1, Part 18 – “*State Board of Health Licensing Requirements for Uranium and Thorium Processing*,” specifically Appendix A (Criteria relating to the operation of mills and the disposition of the tailings or wastes from these operations).
- 10 CFR Part 40 – “*Domestic Licensing of Source Material*,” Appendix A to Part 40 (Criteria Relating to the Operation of Uranium Mills and the Disposition of Tailings or Wastes Produced by the Extraction or Concentration of Source Material from Ores Processed Primarily for their Source Material Content).
- 40 CFR Part 192 – “*Health and Environmental Protection Standards for Uranium and Thorium Mill Tailings*,” Subpart D (Standards for management of uranium byproduct materials pursuant to section 84 of the Atomic Energy Act of 1954, as amended).
- 40 CFR Part 264 – “*Standards for Owners and Operators of Hazardous Waste Treatment, Storage, and Disposal Facilities*,” Subpart K (Surface Impoundments).
- ASTM D 6747. 2004. Standard Guide for Selection of Techniques for Electrical Detection of Potential Leak Paths in Geomembranes.
- ASTM D 7240. 2006. Standard Practice for Leak Location using Geomembranes with an Insulating Layer in Intimate Contact with a Conductive Layer via Electrical Capacitance Technique (Conductive Geomembrane Spark Test).
- Bonaparte, R., Daniel, D.E., and Koerner, R.M. 2002. “Assessment and Recommendations for Optimal Performance of Waste Containment Systems.” EPA/600/R-02/099, December, U.S. EPA, ORD, Cincinnati, Ohio.
- Burns, J.Q. & Richard, R.M. 1964. Attenuation of Stresses for Buried Cylinders. Proceedings, Symposium on Soil-Structure Interaction, University of Arizona. September. 378 p.
- CH2M Hill. 2008. “Piñon Ridge Project, Tailings Stream Analysis (Rev. 2).” Memo issued by Brett Berg. 12 March 2008.
- Giroud, J.P. 2005. “Contribution of the Geosynthetics to the Geotechnical Aspects of Waste Containment.” *The Mercer Lecture, 2005-2006*. Sponsored by Tensar International with the endorsement of the International Society for Soil Mechanics and Geotechnical Engineering and the International Geosynthetics Society (ISSMGE & IGS).
- Giroud, J.P., Pelte, T., and Bathurst, R.J. 1995. “Uplift of geomembrane by wind.” *Geosynthetics International*, 2(6), 897-953.
- Giroud, J.P., Badu-Tweneboah, K., and Soderman, K.L. 1997. “Comparison of leachate flow through compacted clay liners and geosynthetic clay liners in landfill liner systems.” *Geosynthetics International*, 4 (3-4), 391-431.
- Giroud, J.P., and Bonaparte, R. 1989. “Leakage through liners constructed with geomembranes – Part I. Geomembrane Liners.” *Geotextiles and Geomembranes*, No. 8, 27-67.

- Golder Associates Inc. (Golder). 2007. “*Proposed Facility Layout Concepts and Details, Piñon Ridge Plant and Tailings Facilities, Paradox Valley, Colorado.*” Letter report prepared for the Colorado Department of Public Health and Environment (CDPHE). 7 November 2007.
- Golder Associates Inc. (Golder). 2008a. “*Phase 2 Geotechnical Field and Laboratory Test Program, Piñon Ridge Project, Montrose County, Colorado.*” Report prepared for Energy Fuels Resources Corporation, September 2008.
- Golder Associates Inc. (Golder). 2008b. “*Resistance of HDPE Geomembrane to Degradation from Ultraviolet (UV) Radiation in Support of Design Work for the Piñon Ridge Project, Montrose County, Colorado.*” Letter report prepared for the Colorado Department of Public Health and Environment (CDPHE), 8 August 2008.
- Golder Associates Inc. (Golder) 2008c. “*Technical Specifications, Piñon Ridge Project, Montrose County, Colorado.*” Prepared for Energy Fuels Resources Corporation, September 2008.
- Gundle/SLT Environmental Inc. (GSE). 2003. “Technical Note – HDPE, UV Resistance for GSE Geomembranes.” <http://www.truslate.com/grid/techspec.pdf>.
- Hargreaves, G.L., Hargreaves, G.H., and Riley, J.P. 1985. “Agricultural benefits for Senegal River Basin.” *Journal of Irrigation and Drainage Engineering*. ASCE 111:113-124.
- Hsuan, Y.G., Li, M., and Koerner, R.M. 2005. “Stage ‘C’ lifetime prediction of HDPE geomembrane using acceleration tests with elevated temperatures and high pressure.” *Proceedings, Geo-Frontiers 2005*, Austin, Texas.
- Hynes, M.E. and Franklin, A.G., 1984. *Rationalizing the Seismic Coefficient Method*. U.S. Department of the Army. Waterways Experiment Station. U.S. Army Corps of Engineers (USACE). Miscellaneous Paper GL-84-13.
- Jeon, H.-Y., Kim, H.-K., and Koerner, G.R. 2005. “Prediction of long-term behavior of Korean HDPE geomembranes.” *Proceedings, Geo-Frontiers 2005*, Austin, Texas.
- Kleinfelder. 2007a. “*Energy Fuels Resource Corporation, Uranium Mill Licensing Support, Climatological Report, Piñon Ridge Mill Site, Montrose County, Colorado.*” 4 December 2007.
- Kleinfelder. 2007b. “*Climatology Report – Addendum No. 1.*” Letter to B. Monok of EFRC and K. Morrison of Golder dated 7 December 2007.
- Kleinfelder. 2008. “*Design Ground Motions at Piñon Uranium Mill, Colorado.*” Draft Memo to K. Morrison, Golder Associates Inc. 14 January 2008.
- Koerner, R.M. 1998. *Designing With Geosynthetics*. Prentice Hall: Upper Saddle River, New Jersey.
- Koerner, R.M. and Hsuan, Y.G. 2003. “Lifetime prediction of polymeric geomembranes used in new dam construction and dam rehabilitation.” *Proceedings, Assoc. of State Dam Safety Officials Conference*, Lake Harmony, Pennsylvania, June 4-6, 16 pp.

- Koerner, R.M., Hsuan, Y.G., and Koerner, G.R. 2005a. "Geomembrane lifetime prediction: unexposed and exposed conditions." GRI White Paper #6, Geosynthetic Institute, Folsom, PA, 19 pp.
- Koerner, R.M., Koerner, G.R., and Hsuan, Y.G. 2005b. "Lifetime prediction of exposed geomembranes." *Proceedings, Geo-Frontiers 2005*, Austin, Texas.
- Layfield Geosynthetics (Layfield). 2008. "UV Resistance." <http://www.geomembranes.com>.
- Lupo, J.F., and Morrison, K.F. 2005. "Innovative Geosynthetic Liner Design Approaches and Construction in the Mining Industry." Geotechnical Special Publication (GSP) 140, *Proceedings, Geo-Frontiers 2005*, Austin, Texas.
- Rocscience, 2000. Users Manual *Slide* Version 5.0, Rocscience.
- Shackelford, C.D., Benson, C.H., Katsumi, K., Edil, T. and Lin, L. 2000. "Evaluation the Hydraulic Conductivity of GCLs Permeated with Non-Standard Liquids." *Geotextiles and Geomembranes*, 18, 133-161.
- Spencer, E., 1967. "A Method of Analysis of the Stability of Embankments Assuming Parallel Inter-Slice Forces." *Geotechnique*, Vol. XVII, No. 1, pp. 11-26.
- State of Colorado, Department of Natural Resources, Division of Water Resources, Office of the State Engineer (Office of the State Engineer). 2007. *Rules and Regulations for Dam Safety and Dam Construction*. January.
- U.S. Environmental Protection Agency (U.S. EPA). 1992. "Action leakage rates for detection systems (supplemental background document for the final double liners and leak detection systems rule for hazardous waste landfills, waste piles, and surface impoundments)."
- Youd, T.L., I.M. Idriss, R.D. Andrus, I. Arango, G. Castro, J.T. Christian, R. Dobry, W.D. Liam Finn, L. F. Harder Jr., M.E. Hynes, K. Ishihara, J. P. Koester, S. S. C. Liao, W. F. Marcuson III, G. R. Martin, J. K. Mitchell, Y. Moriwaki, M. S. Power, P.K. Robertson, R. B. Seed, K. H. Stokoe II. 2001. "Liquefaction Resistance of Soils: Summary Report from the 1996 NCEER and 1998 NCEER/NSF Workshops on Evaluation of Liquefaction Resistance of Soils." *J. Geotechnical and Geoenvironmental Engineering*, Vol. 127, No. 10, ASCE.
- Zeus Technical Whitepaper (Zeus). 2005. "UV Properties of Plastics: Transmission & Resistance." http://www.zeusinc.com/pdf/Zeus_UV_Properties.pdf

TABLES

TABLE 1

MONTHLY PRECIPITATION AND EVAPORATION VALUES

Month	Average* Precipitation (inches)	Calculated Lake Evaporation (inches)
January	0.9	0.8
February	0.8	1.2
March	1.0	2.2
April	1.0	3.3
May	0.9	4.8
June	0.5	5.8
July	1.2	6.3
August	1.4	5.4
September	1.5	3.8
October	1.5	2.5
November	1.1	1.2
December	0.9	0.7
Total	12.7	38.0

Precipitation values obtained for Uravan weather station from 1961 to 2007

TABLE 2



RESULTS OF STABILITY EVALUATION

Scenario	Minimum Static Factor of Safety [Peak (Residual)]	Minimum Pseudo- Static Factor of Safety [Peak (Residual)]
Pre-Deposition	2.0 (1.9)	1.7 (1.7)
Post-Deposition	3.0 (3.0)	2.4 (2.4)
Post-Closure	4.9 (4.4)	2.7 (2.3)

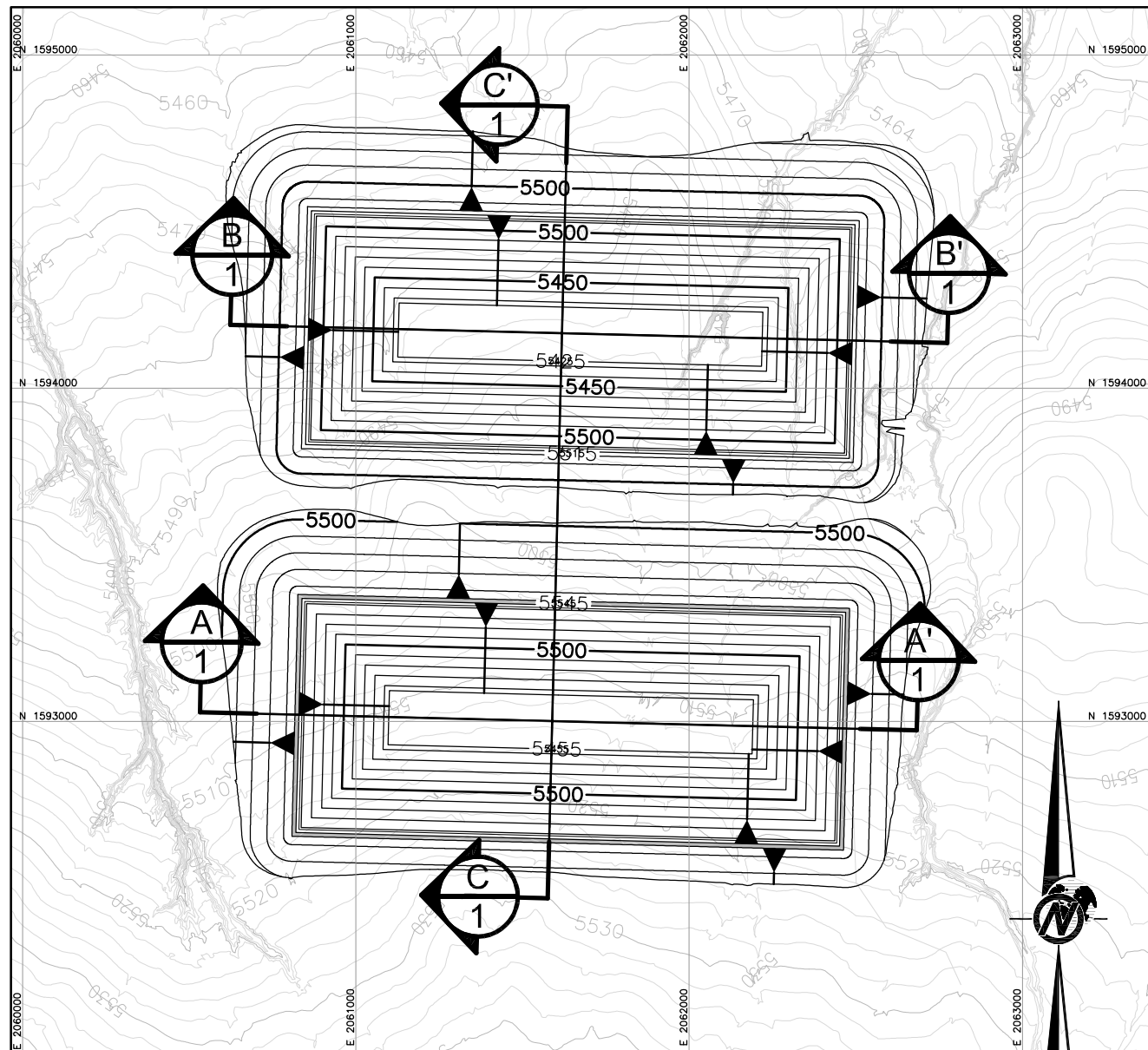
FIGURES



LEGEND

-  EXISTING GROUND TOPOGRAPHY (SEE REFERENCE 1)
-  PROPOSED FINISHED GRADE TOPOGRAPHY

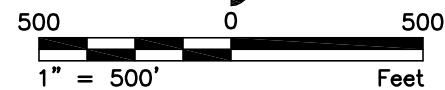
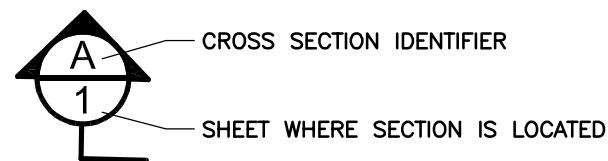

REFERENCES

1. TWO-FOOT CONTOUR MAP PROVIDED BY KLEINFELDER IN SEPTEMBER 2007.

NOTES

1. EACH TAILINGS CELL IS DESIGNED FOR A MINIMUM CAPACITY OF 2.45 MILLION TONS ASSUMING A DRY DENSITY OF 95 PCF AND A 13.3 YEAR DESIGN LIFE.

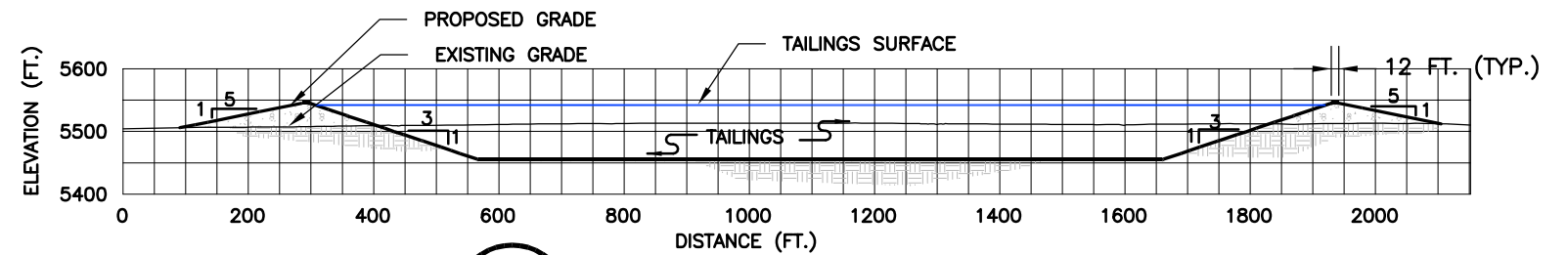

A
1
1"=300'

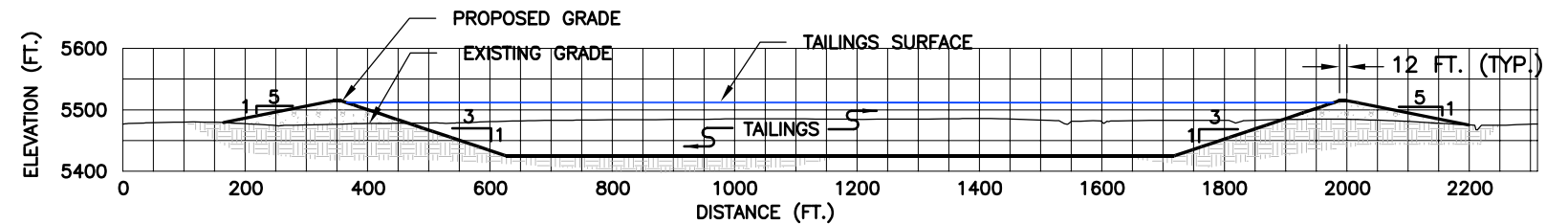

B
1
1"=300'

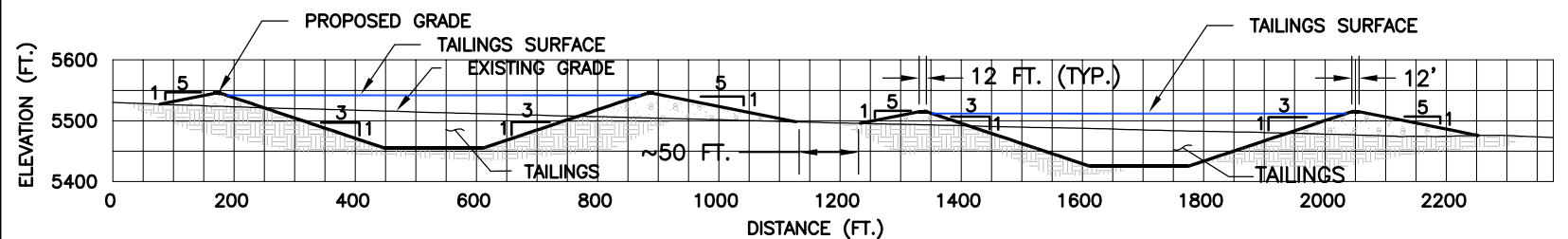

C
1
1"=300'

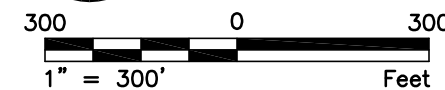

GRADING QUANTITIES

	CUT (CU. YDS.)	FILL (CU. YDS.)
SOUTH CELL	926,000	962,000
NORTH CELL	950,000	900,000

REV	DATE	DES	ISSUED FOR DESIGN REPORT	JWR	KFM	JMJ
			REVISION DESCRIPTION	CADD	CHK	RWV

PROJECT ENERGY FUELS RESOURCES CORPORATION
PIÑON RIDGE PROJECT
MONTROSE COUNTY, COLORADO

TITLE
**TAILINGS ALTERNATIVE
OPTION A**

	PROJECT No.	073-81694	FILE No.	07381694A005
	DESIGN	JWR	11/07	SCALE AS SHOWN REV. A
	CADD	JWR	11/07	
	CHECK	KFM	11/07	
REVIEW	JMJ	11/07		

FIGURE 1



A
2
1"=300'

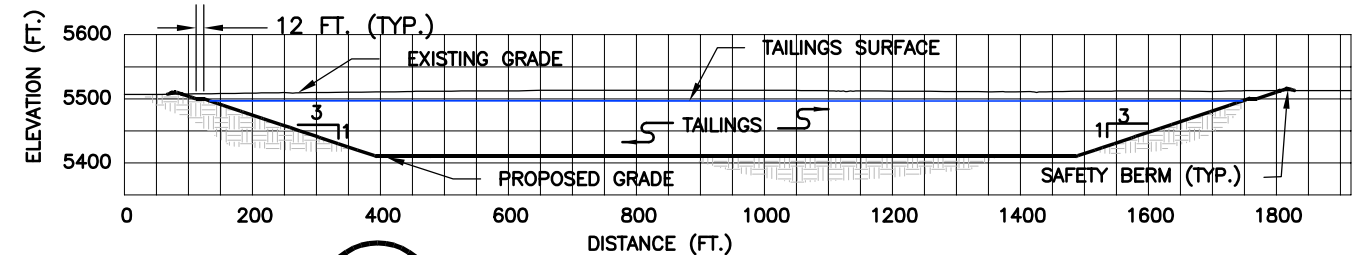
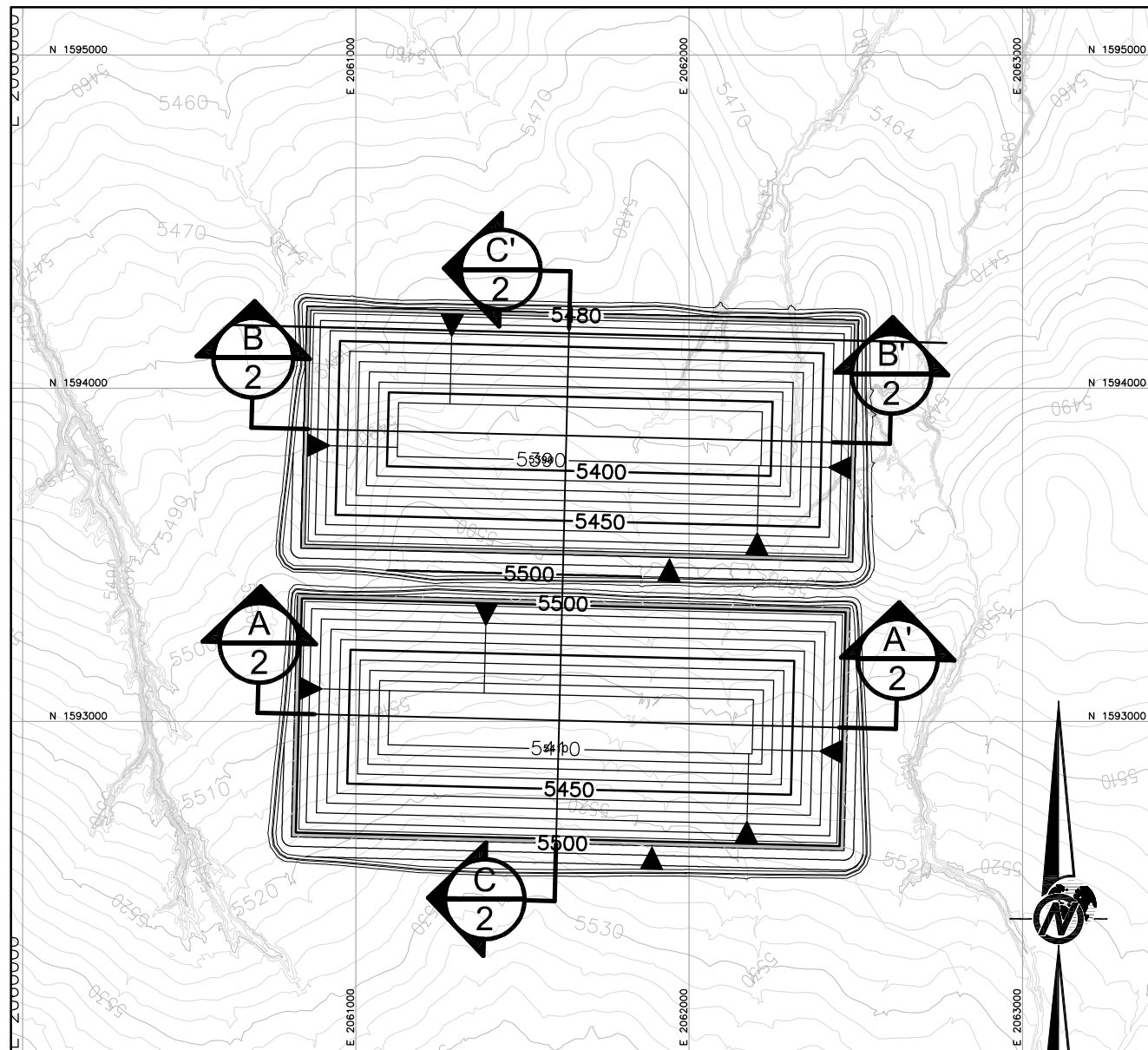
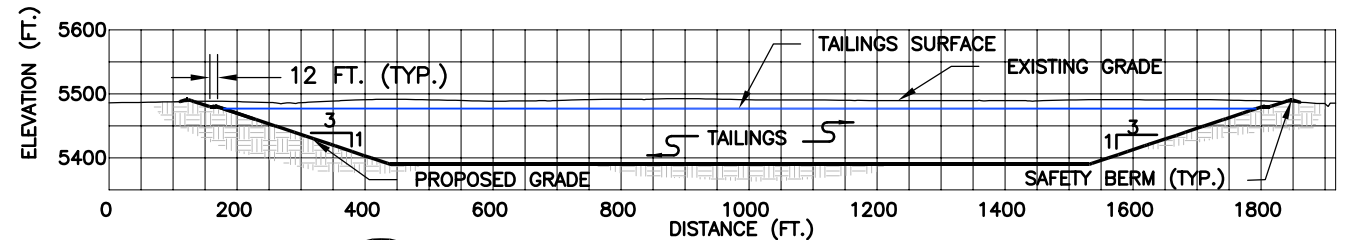

B
2
1"=300'

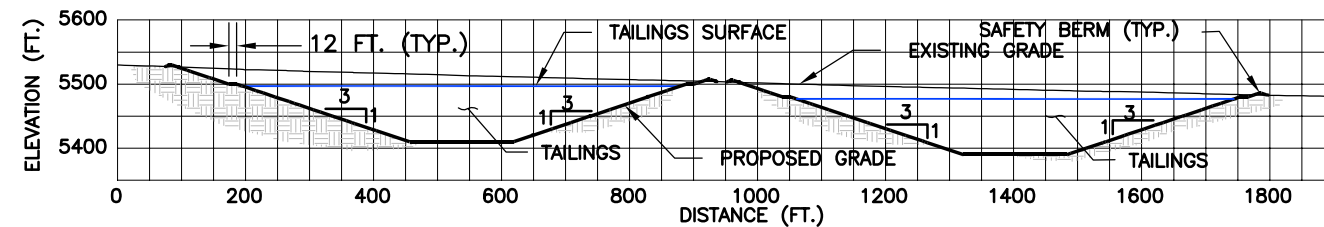

C
2
1"=300'

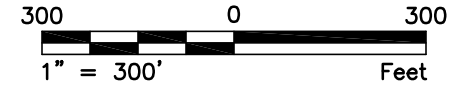

LEGEND

- EXISTING GROUND TOPOGRAPHY (SEE REFERENCE 1)
- PROPOSED FINISHED GRADE TOPOGRAPHY

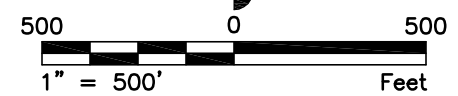

- PERIMETER SAFETY BERM
- SLOPE DIRECTION

- CROSS SECTION IDENTIFIER
- SHEET WHERE SECTION IS LOCATED

REFERENCES

1. TWO-FOOT CONTOUR MAP PROVIDED BY KLEINFELDER IN SEPTEMBER 2007.

NOTES

1. EACH TAILINGS CELL IS DESIGNED FOR A MINIMUM CAPACITY OF 2.45 MILLION TONS ASSUMING A DRY DENSITY OF 95 PCF AND A 13.3 YEAR DESIGN LIFE.

GRADING QUANTITIES

	CUT (CU. YDS.)	BERM FILL (CU. YDS.)
SOUTH CELL	2,644,000	7,000
NORTH CELL	2,542,000	9,000

REV	DATE	DES	REVISION DESCRIPTION	JWR	KFM	JMJ
				CADD	CHK	RWV
PROJECT ENERGY FUELS RESOURCES CORPORATION PIÑON RIDGE PROJECT MONTROSE COUNTY, COLORADO						
TITLE TAILINGS ALTERNATIVE OPTION B						
PROJECT No. 073-81694			FILE No. 07381694A006			
DESIGN	JWR	11/07	SCALE	AS SHOWN	REV.	A
CADD	JWR	11/07				
CHECK	KFM	11/07				
REVIEW	JMJ	11/07				



FIGURE 2

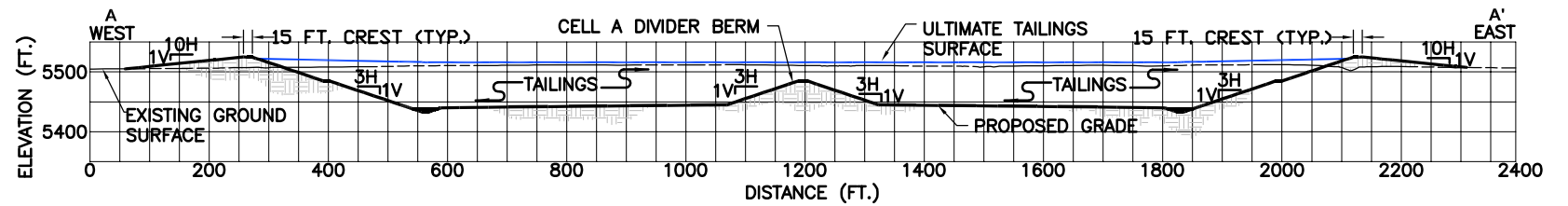
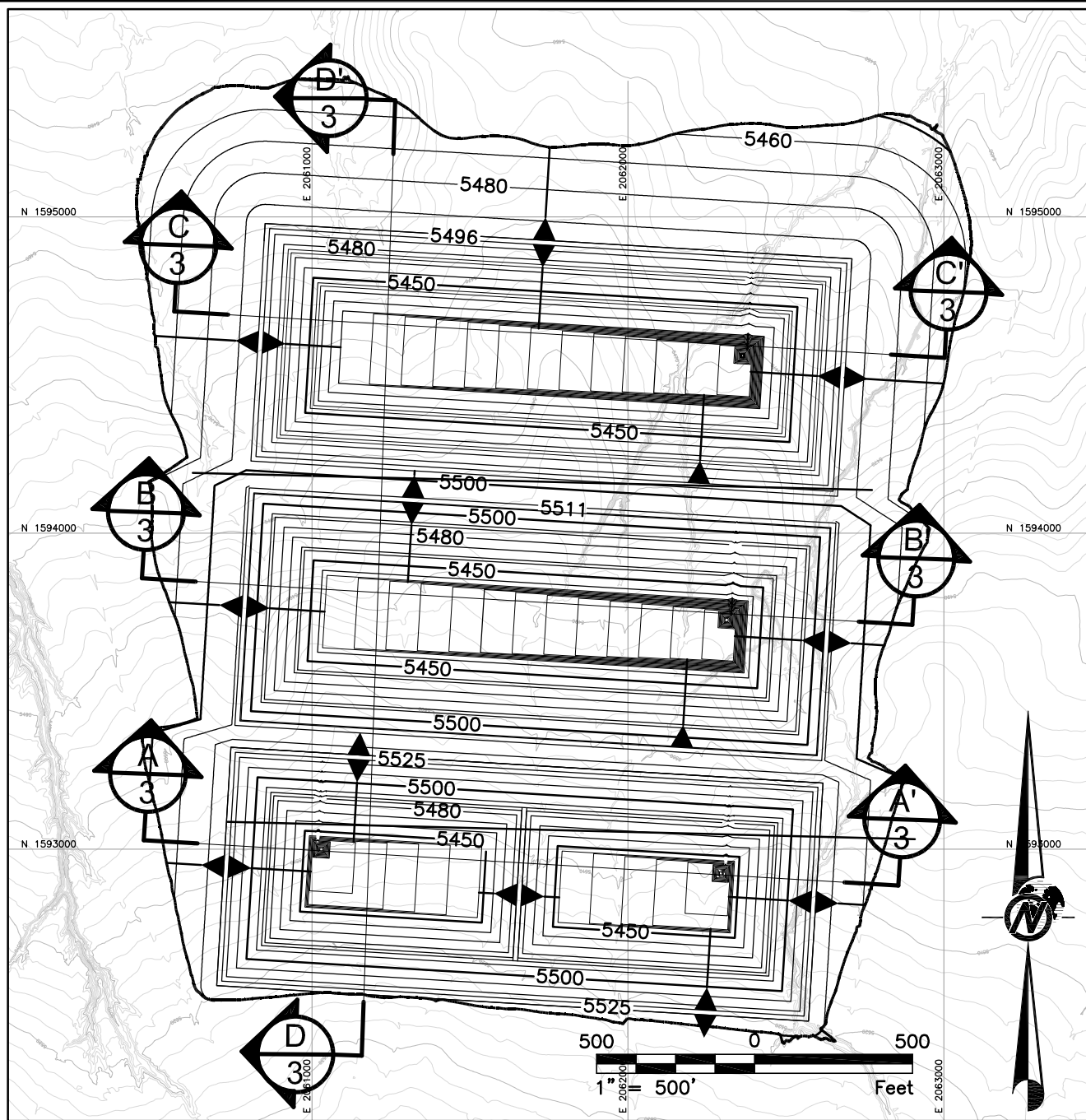

A
3
1"=300'

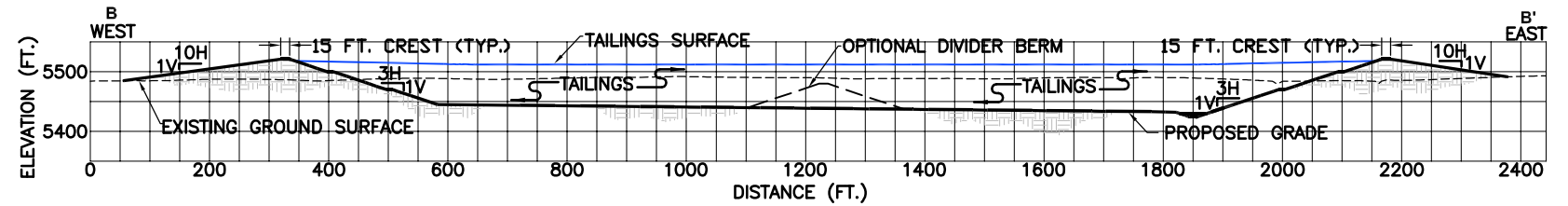

B
3
1"=300'

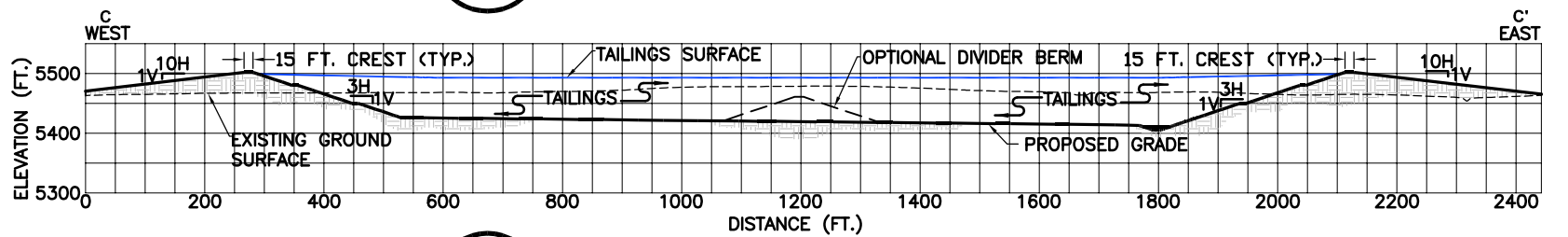

C
3
1"=300'

LEGEND

- EXISTING GROUND TOPOGRAPHY (SEE REFERENCE 1)
- PROPOSED FINISHED GRADE TOPOGRAPHY
- PERIMETER SAFETY BERM
- SLOPE DIRECTION
- CROSS SECTION IDENTIFIER
- FIGURE WHERE SECTION IS LOCATED

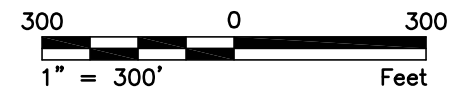

REFERENCES

- TWO-FOOT CONTOUR BASE MAP PROVIDED BY KLEINFELDER IN JUNE 2008. CREATED BY DRAWING BY ACCURATE SURVEY & ENGINEERING DATED 9/6/2007.

NOTES

- EACH TAILINGS CELL IS DESIGNED FOR A MINIMUM CAPACITY OF 2.45 MILLION TONS ASSUMING A DRY DENSITY OF 95 PCF AND A 13.3 YEAR DESIGN LIFE.

GRADING QUANTITIES

	CUT (CU. YDS.)	BERM FILL (CU. YDS.)
SOUTH CELL	1,713,000	307,000
MIDDLE CELL	1,386,000	522,000
NORTH CELL	1,270,000	1,036,000

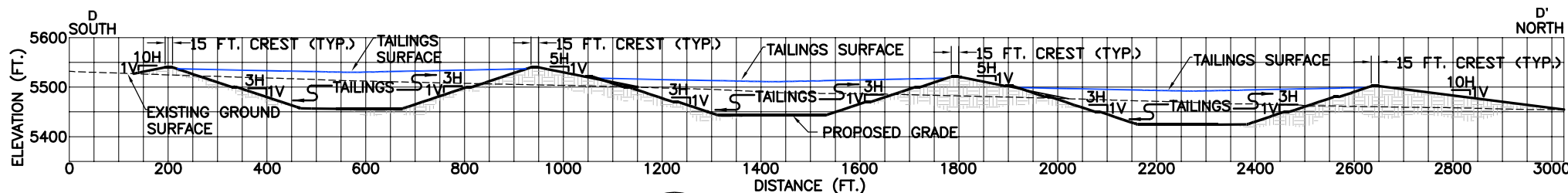

D
3
1"=300'

REV	DATE	DES	ISSUED FOR DESIGN REPORT	JWR	KFM	JMJ
			REVISION DESCRIPTION	CADD	CHK	RW
PROJECT ENERGY FUELS RESOURCES CORPORATION PIÑON RIDGE PROJECT MONTROSE COUNTY, COLORADO						
TITLE TAILINGS ALTERNATIVE OPTION C						
PROJECT No. 073-81694			FILE No. 07381694A058			
DESIGN	JWR	11/07	SCALE	AS SHOWN	REV.	A
CADD	JWR	11/07				
CHECK	KFM	11/07				
REVIEW	JMJ	11/07				



FIGURE 3

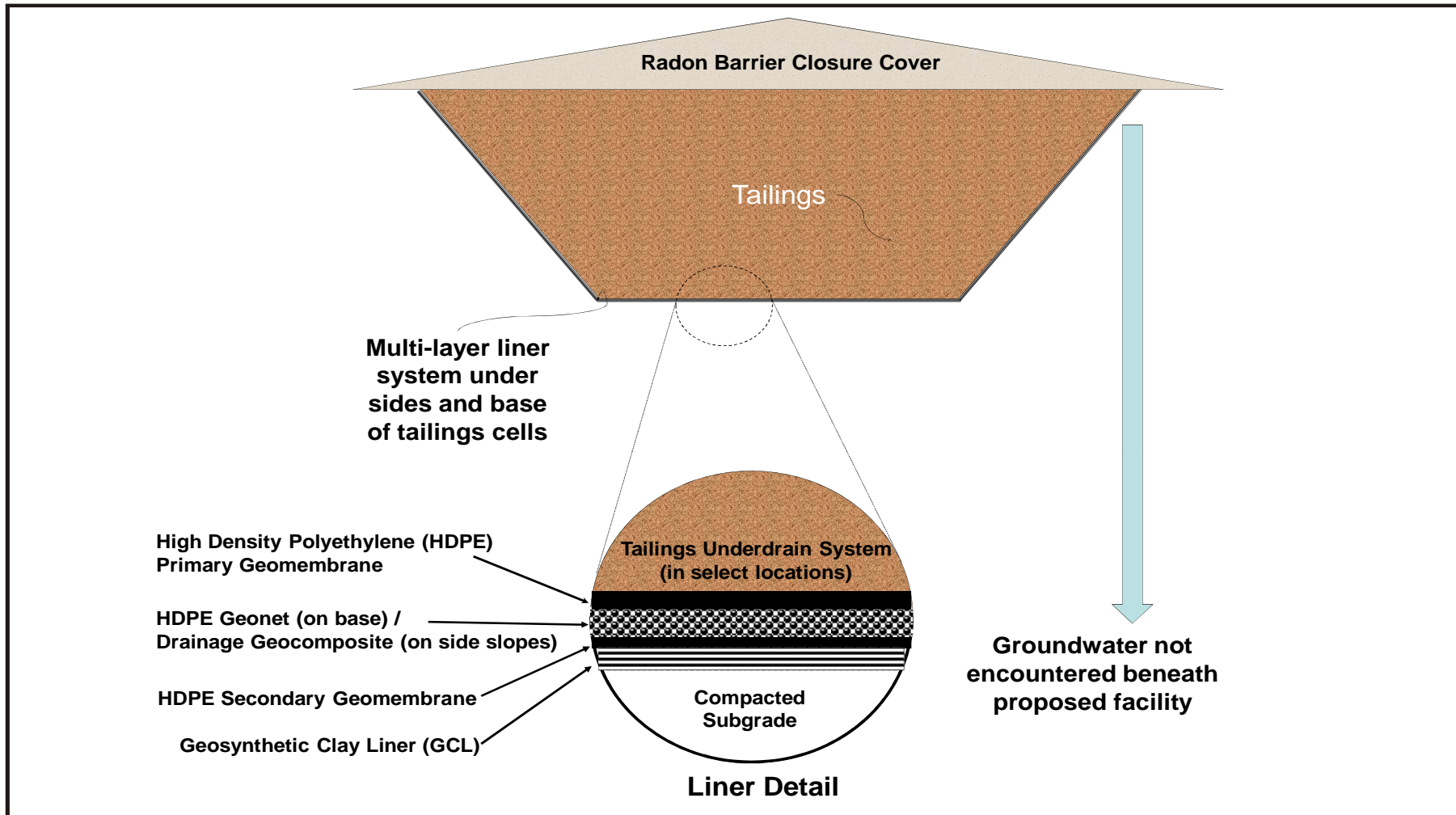

Denver, Colorado

CLIENT/PROJECT

**ENERGY FUELS RESOURCES CORP.
PIÑON RIDGE PROJECT**

TITLE

Tailings Cell Liner Concept

DRAWN **KFM**

DATE **Sep-08**

JOB NO. **073-81694**

CHECKED **KFM**

SCALE **NTS**

DWG. NO. **NA**

REVIEWED **JMJ**

FILE NO. **Figure4.xls**

FIGURE NO. **4**

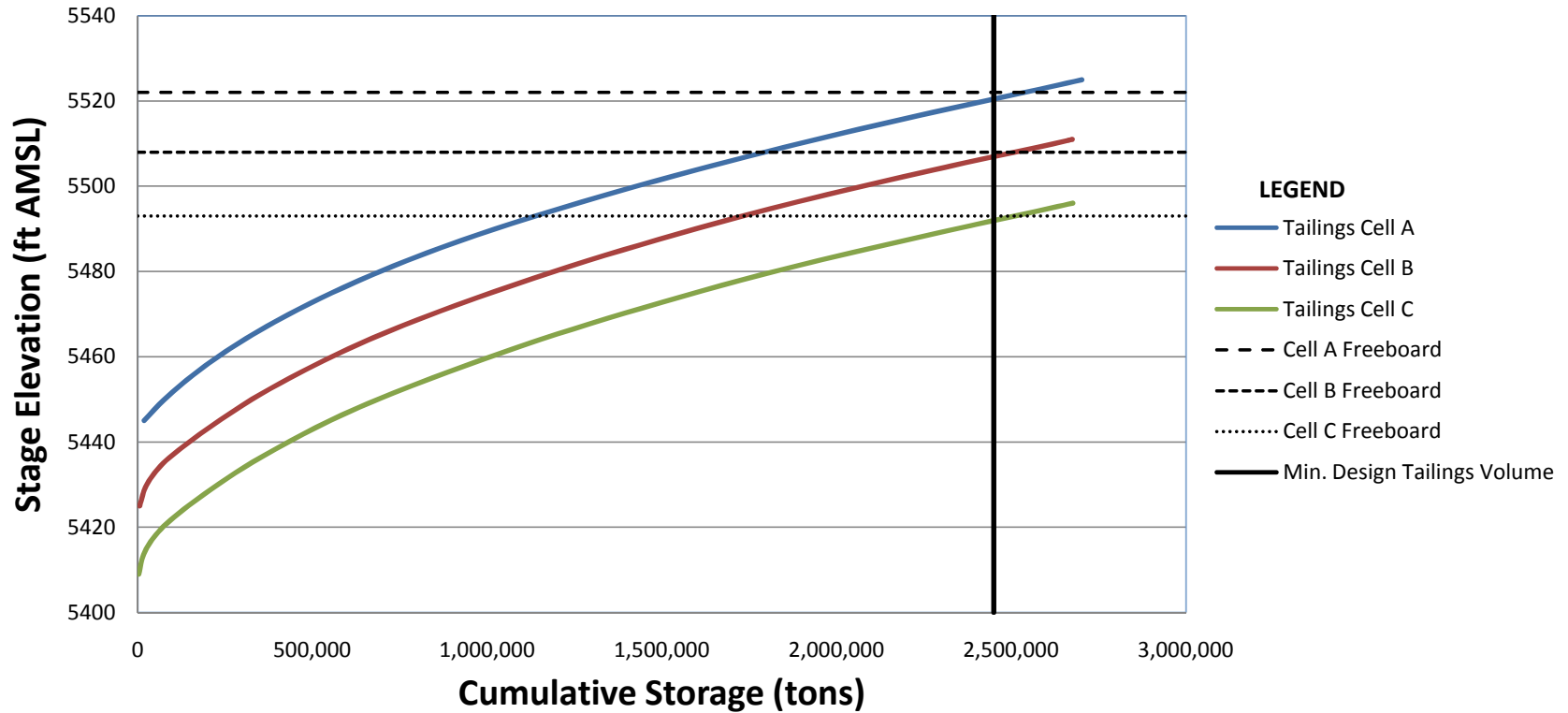

Notes:

1. Cumulative storage was calculated assuming a dry density of 95 pounds per cubic foot on placed tailings.
2. Stage-storage curve was developed assuming a two percent tailings slope for 500 feet from the perimeter, flattening to 0.5 percent.



Denver, Colorado

TITLE

Tailings Cell Stage-Storage Relationship

CLIENT/PROJECT

**ENERGY FUELS RESOURCES CORP.
PIÑON RIDGE PROJECT**

DRAWN **KFM**

DATE **Sep-08**

JOB NO. **073-81694.0003**

CHECKED **KFM**

SCALE **NTS**

DWG. NO. **NA**

REVIEWED **JMJ**

FILE NO. **Figure5-StageStorage.xls**

FIGURE NO. **5**

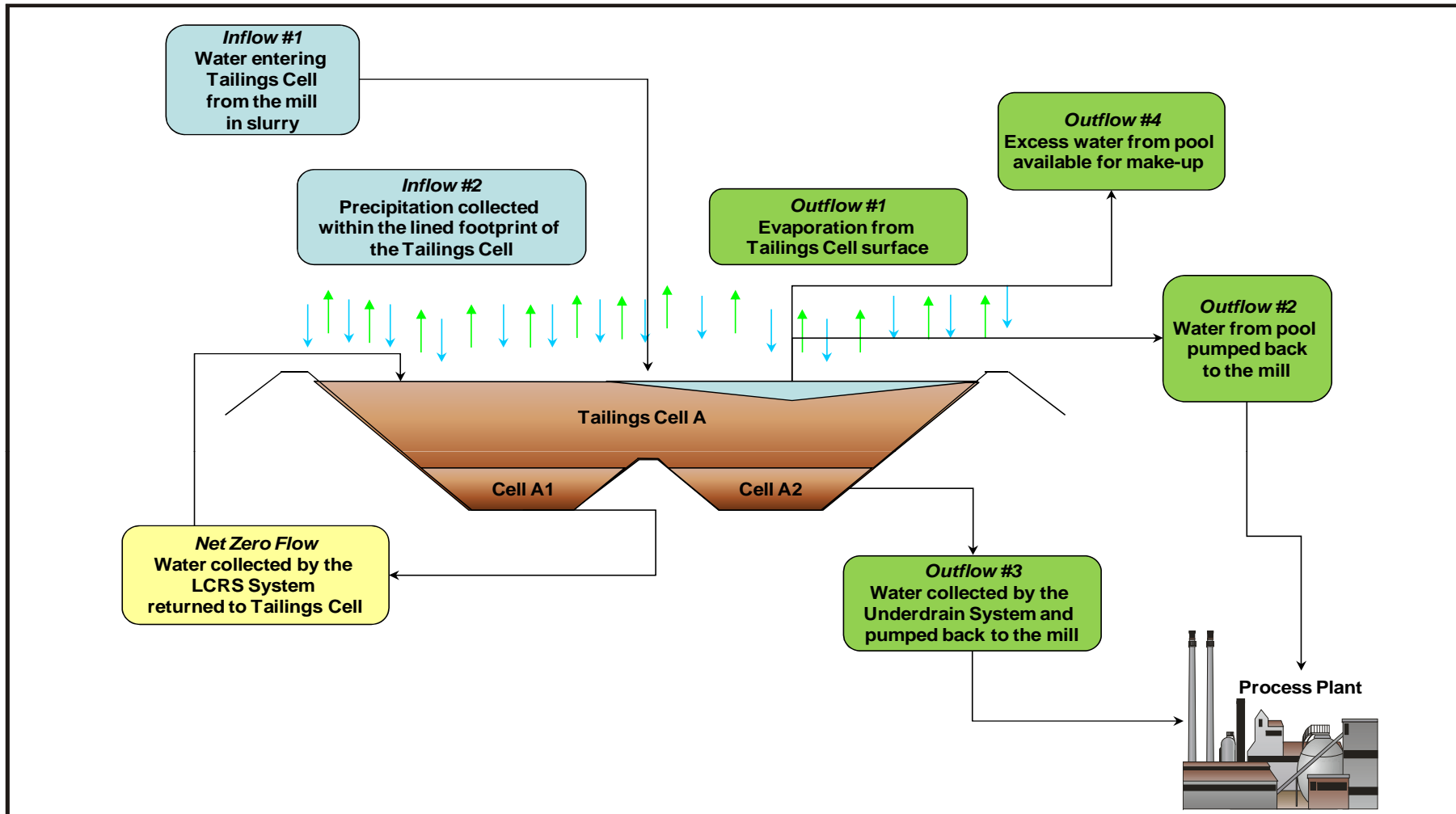

Denver, Colorado

CLIENT/PROJECT

**ENERGY FUELS RESOURCES CORP.
PIÑON RIDGE PROJECT**

TITLE

Tailings Cell Water Balance Flow Sheet

DRAWN	KFM	DATE	May-08	JOB NO.	073-81694
CHECKED	KFM	SCALE	NTS	DWG. NO.	NA
REVIEWED	JMJ	FILE NO.	Figure-TC-H2OBal.xls	FIGURE NO.	6

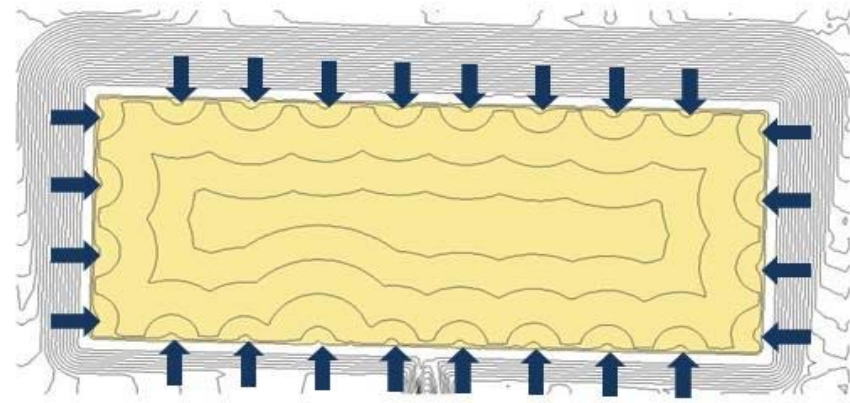
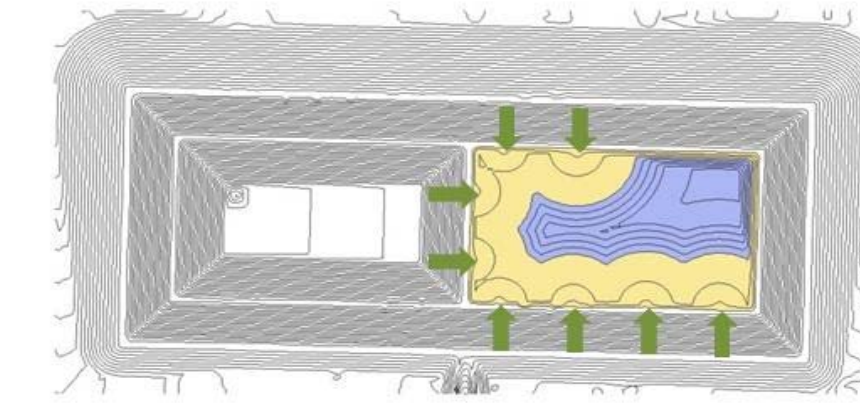
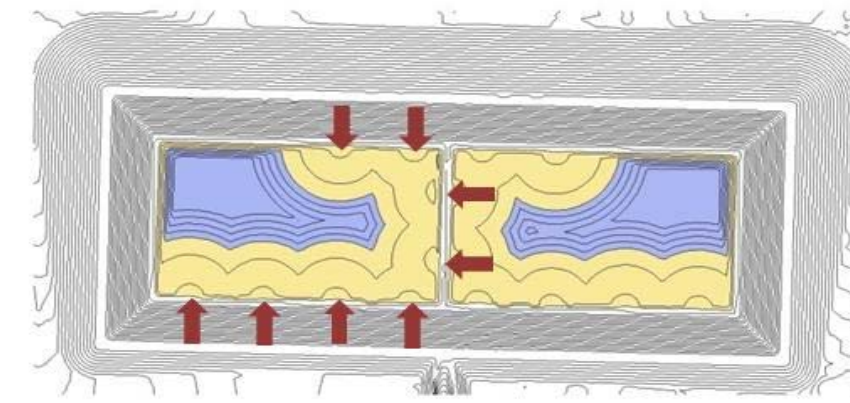
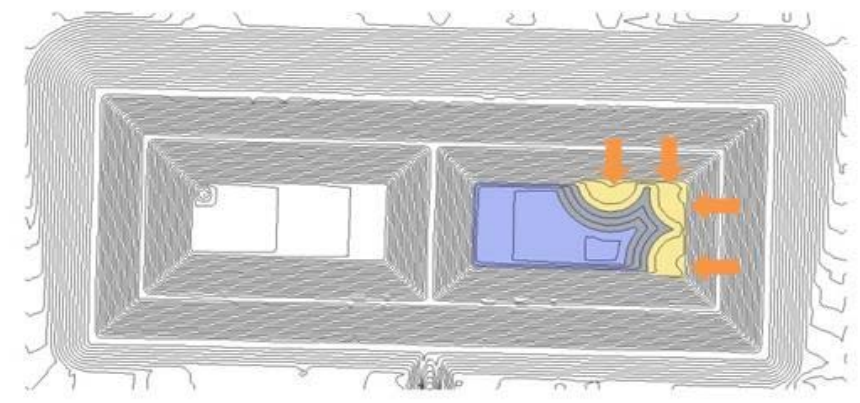
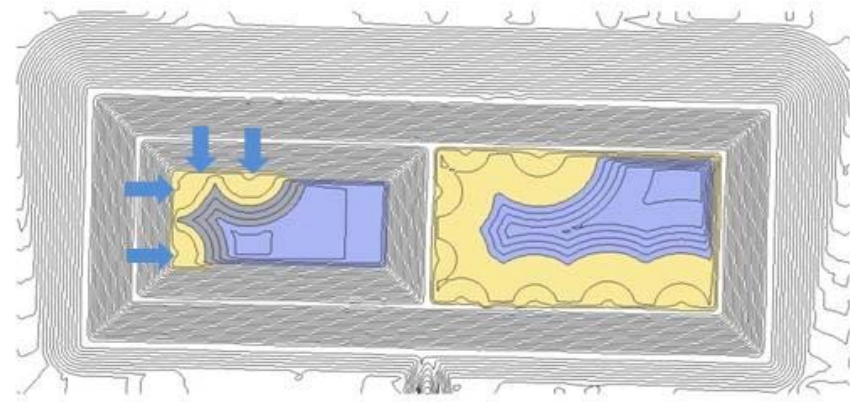
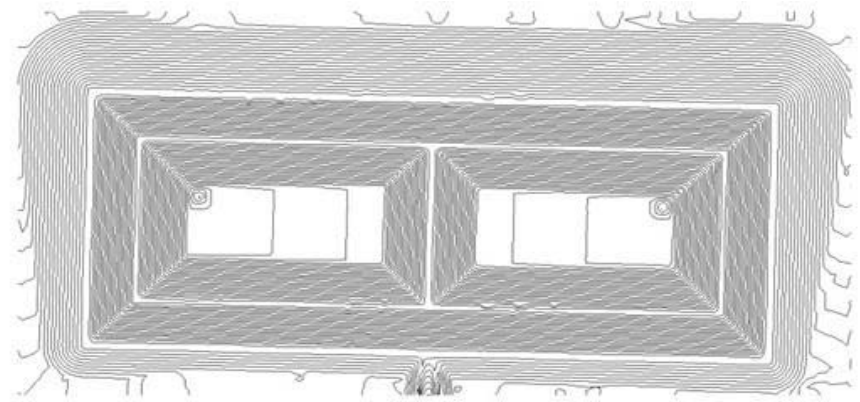

LEGEND

- ➔ PHASE 1 DEPOSITION POINT
- ➔ PHASE 2 DEPOSITION POINT
- ➔ PHASE 3 DEPOSITION POINT
- ➔ PHASE 4 DEPOSITION POINT
- ➔ PHASE 5 DEPOSITION POINT
- POND
- TAILINGS

Notes:

1. Actual deposition during operations will be determined by operations personnel.
2. The Phase 1 and Phase 3 deposition phases illustrated should occur at start-up of operations to provide additional buttressing of the liner on the base of the cells and protection to the tailings underdrain system by deposition of coarse-grained underflow material over the sump area.

<p>Golder Associates Denver, Colorado</p>	Tailings Cell Deposition Model		
	CLIENT/PROJECT	DRAWN	DATE
ENERGY FUELS RESOURCES CORP. PIÑON RIDGE PROJECT	EF	5/2/2008	073-81694
	CHECKED	SCALE	DWG. NO. / REV. NO.
	KFM	NTS	N/A
	REVIEWED	FILE NO.	FIGURE
	JMJ	Figure-TC-DepModel.xls	7

DRAWINGS



PIÑON RIDGE PROJECT TAILINGS CELL DESIGN

DESIGN DRAWINGS PREPARED BY
GOLDER ASSOCIATES INC.

FOR
ENERGY FUELS RESOURCES CORPORATION
MONTROSE COUNTY, COLORADO

DRAWING NUMBER	REVISION	DRAWING TITLE
1	△	TITLE SHEET WITH DRAWING LIST AND LOCATION MAP
2	△	GENERAL PROJECT LAYOUT AND LOCATIONS OF GEOTECHNICAL INVESTIGATIONS
3	△	TAILINGS CELL A EXCAVATION GRADING PLAN AND ISOPACH
4	△	TAILINGS CELL B EXCAVATION GRADING PLAN AND ISOPACH
5	△	TAILINGS CELL C EXCAVATION GRADING PLAN AND ISOPACH
6	△	TAILINGS CELL TYPICAL SECTIONS
7	△	TAILINGS CELL A UNDERDRAIN PLAN AND SECTIONS
8	△	TAILINGS CELLS B AND C UNDERDRAIN PLANS AND SECTIONS
9	△	UNDERDRAIN SECTIONS AND DETAILS
10	△	LEAK COLLECTION AND RECOVERY SYSTEM SECTIONS AND DETAILS
11	△	TAILINGS FACILITY LINER DETAILS

GENERAL NOTES

- THIS DRAWING SET ILLUSTRATES THE DESIGN REQUIREMENTS FOR CONSTRUCTION OF THREE TAILINGS CELLS, EACH WITH PLAN AREAS OF APPROXIMATELY 30 ACRES, FOR THE PIÑON RIDGE PROJECT.
- THE PROPOSED FACILITY IS LOCATED IN SECTIONS 5, 8, AND 17, TOWNSHIP 46 NORTH, RANGE 17 WEST, MONTROSE COUNTY, COLORADO.
- GOLDER ASSOCIATES INC. (GOLDER) HAS PREPARED THIS DESIGN PACKAGE CONSISTENT WITH THE REQUIREMENTS OF THE COLORADO DEPARTMENT OF PUBLIC HEALTH AND ENVIRONMENT (CDPHE) RULES AND REGULATIONS PERTAINING TO RADIATION CONTROL 6 CCR 1007-1, PART 18, AND OTHER APPLICABLE REGULATIONS (I.E. ENVIRONMENTAL PROTECTION AGENCY).

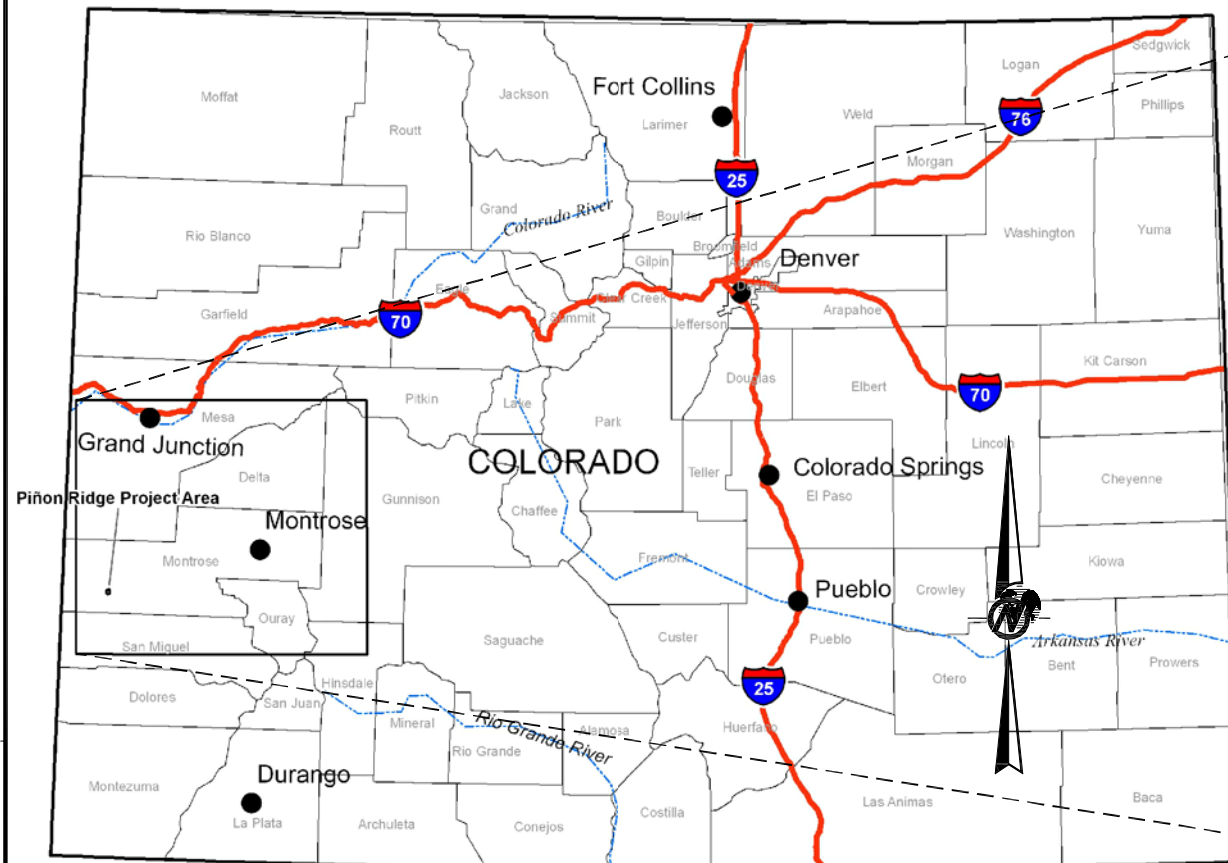

VICINITY MAP
SCALE 0 30 MILES

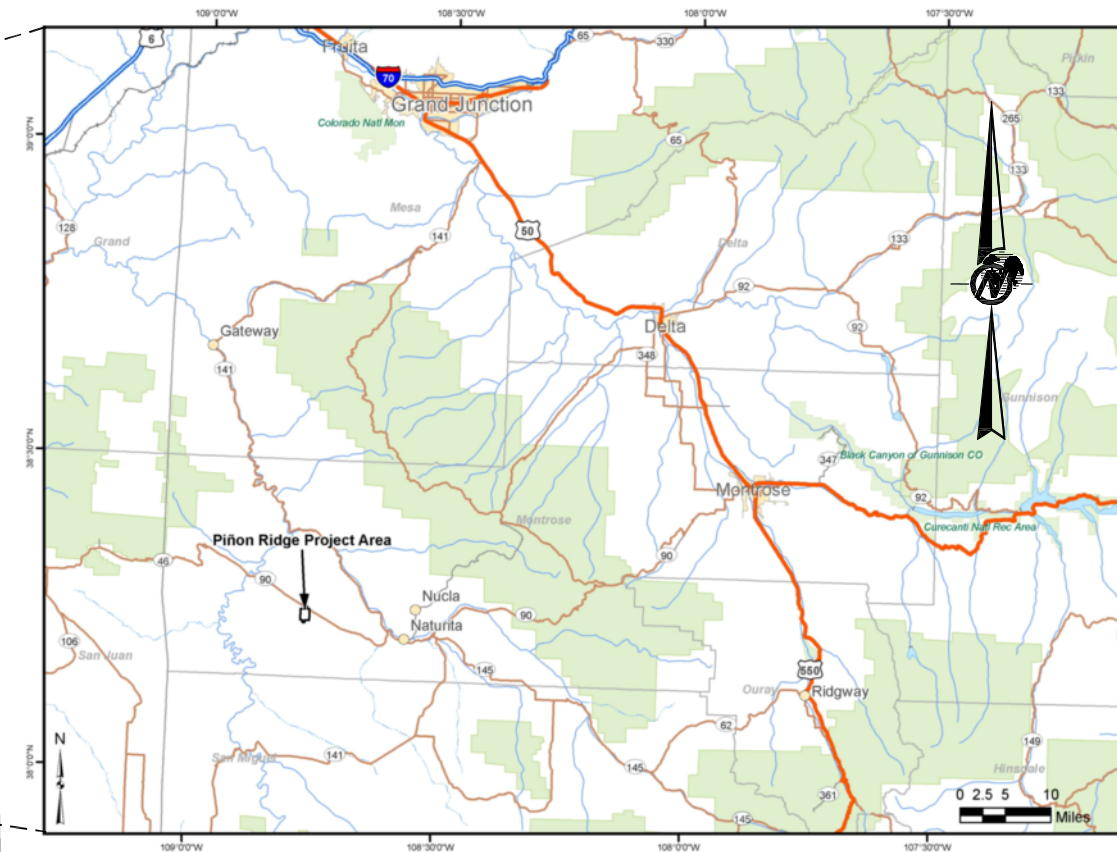

LOCATION SITE MAP
SCALE 0 10 MILES

REV	DATE	DES	ISSUED FOR DESIGN REPORT	JDE	KFM	JMJ
			REVISION DESCRIPTION	CADD	CHK	RW

PROJECT
ENERGY FUELS RESOURCES CORPORATION
PIÑON RIDGE PROJECT - TAILINGS CELL DESIGN
MONTROSE COUNTY, COLORADO

TITLE
TITLE SHEET WITH DRAWING LIST
AND LOCATION MAP

	PROJECT No.	073-81894	FILE No.	07381894A031
	DESIGN	KFM	2/08	SCALE AS SHOWN
	CADD	MTM	2/08	DRAWING
	CHECK	KFM	5/08	1
	REVIEW	JMJ	5/08	

I.D.	Northing	Easting	Elevation
GA-TP-01	1596508.7	2060410.5	5425.1
GA-TP-02	1596555.9	2062587.4	5444.3
GA-TP-03	1595901.2	2060958.5	5439.9
GA-TP-04	1595889.0	2062566.9	5445.8
GA-TP-05	1594959.4	2061470.7	5467.1
GA-TP-06	1594887.2	2062632.2	5456.6
GA-TP-07	1593460.0	2061496.2	5498.2
GA-TP-08	1592971.3	2062039.9	5508.4
GA-TP-09	1591630.0	2061943.2	5542.5
GA-TP-10	1591765.7	2062391.3	5536.1
GA-TP-11	1593903.6	2062412.6	5483.8

I.D.	Northing	Easting	Elevation
PR1-1	1597859.9	2061661.5	5452
PR1-2	1597335.7	2059249.5	5417
PR1-3	1595950.5	2060110.2	5436
PR1-4	1596313.6	2062461.3	5448
PR1-5	1596763.4	2063490.6	5426
PR1-6	1594993.8	2058978.2	5456
PR1-7	1594770.9	2060386.1	5461
PR1-8	1595232.8	2061816.9	5466
PR1-9	1594698.5	2062045.7	5471
PR1-10	1594329.5	2063839.4	5487
PR1-11	1594197.1	2061358.2	5481
PR1-12	1593384.0	2060405.0	5495
PR1-13	1593400.8	2062173.2	5497
PR1-14	1593338.1	2063190.8	5496
PR1-15	1592361.9	2058840.1	5551
PR1-16	1592065.8	2060628.5	5530
PR1-17	1591874.2	2061530.4	5543
PR1-18	1592020.5	2062213.4	5533
PR1-19	1590853.4	2061719.5	5571
PR1-20	1591043.5	2063607.1	5545

I.D.	Northing	Easting	Elevation
GA-BH-01	1596809.5	2060098.5	5419.8
GA-BH-02	1596809.4	2060648.6	5430.7
GA-BH-03	1596809.4	2061198.8	5442.3
GA-BH-04	1596809.4	2061749.0	5441.2
GA-BH-05	1596809.5	2062299.1	5432.7
GA-BH-06	1596809.4	2062849.3	5443.9
GA-BH-07	1596186.8	2060098.5	5430.5
GA-BH-08	1596186.8	2060648.7	5433.0
GA-BH-09	1596186.8	2061198.8	5448.9
GA-BH-10	1596186.8	2061749.0	5453.3
GA-BH-11	1596186.8	2062299.1	5443.9
GA-BH-12	1595564.1	2060148.5	5444.4
GA-BH-13	1595564.1	2060698.7	5446.3
GA-BH-14	1595564.1	2061248.8	5459.6
GA-BH-15	1595564.1	2061799.0	5459.3
GA-BH-16	1595564.1	2062349.2	5451.2
GA-BH-17	1595564.1	2062899.4	5446.7
GA-BH-18	1595158.9	2060648.7	5453.5
GA-BH-19	1595158.9	2061198.8	5456.2
GA-BH-20	1595158.9	2062299.2	5458.0
GA-BH-21	1595158.9	2062849.3	5449.5
GA-BH-22	1594658.9	2061198.8	5467.7
GA-BH-23	1594658.9	2061749.0	5476.9
GA-BH-24	1594658.8	2062299.1	5465.7
GA-BH-25	1594658.8	2062849.4	5458.6
GA-BH-26	1594158.7	2060648.7	5472.6
GA-BH-27	1594158.7	2061749.0	5484.4
GA-BH-28	1594158.7	2062299.2	5482.3
GA-BH-29	1594158.7	2062849.3	5473.8
GA-BH-30	1593658.6	2060648.7	5492.3
GA-BH-31	1593658.6	2061198.8	5494.2
GA-BH-32	1593658.5	2061749.0	5491.4
GA-BH-33	1593658.6	2062299.2	5490.7
GA-BH-34	1593658.5	2062849.3	5493.0
GA-BH-35	1593158.4	2061198.8	5506.9
GA-BH-36	1593158.4	2061749.0	5505.3
GA-BH-37	1593158.4	2062299.1	5504.2
GA-BH-38	1593158.4	2062849.3	5500.4
GA-BH-39	1592658.3	2060648.7	5515.8
GA-BH-40	1592658.2	2061198.8	5520.5
GA-BH-41	1592658.3	2061749.0	5517.0
GA-BH-42	1592658.2	2062299.2	5515.4
GA-BH-43	1592658.2	2062849.3	5512.1
GA-BH-44	1591993.8	2062619.9	5531.0
GA-BH-45	1591533.7	2062620.0	5538.8
GA-BH-46	1591533.6	2062159.8	5545.0
GA-BH-47	1591301	2061116	5558
GA-BH-48	1591262	2061811	5556
TB-01	1592383.1	2061089.0	5529.8
TB-02	1592345.1	2061329.2	5530.2
TB-03	1592286.4	2061605.6	5528.5
TB-04	1592228.4	2061863.5	5528.1
TB-05	1592172.2	2062129.9	5528.6
TB-06	1592130.7	2061064.0	5534.2
TB-07	1592093.6	2061309.1	5537.1
TB-08	1592055.3	2061581.3	5536.4
TB-09	1592033.5	2061801.0	5533.1
TB-10	1591994.2	2062062.5	5532.9
TB-11	1591973.6	2061069.1	5538.4
TB-12	1591922.9	2061313.4	5540.6
TB-13	1591810.9	2061522.9	5543.6
TB-14	1591791.3	2061733.9	5540.0
TB-15	1591729.8	2061977.1	5539.5
TB-16	1591740.8	2061024.6	5543.7
TB-17	1591703.0	2061276.2	5547.1
TB-18	1591664.8	2061491.4	5547.3
TB-19	1591639.0	2061662.5	5544.6
TB-20	1591580.9	2061923.1	5543.8
PB-01	1595665.3	2063972.7	5457.5
PB-02	1594878.7	2063676.3	5470.1
PB-03	1594100.2	2063616.5	5486.4
PB-04	1592683.7	2063259.2	5509.7
PB-05	1591673.0	2062844.7	5531.8

I.D.	Northing	Easting	Elevation
MW1	1597208.6	2060295.0	5423
MW2	1597132.0	2062819.0	5432
MW3	1595226.9	2059204.8	5448
MW4	1594834.3	2063802.6	5477
MW5	1591190.9	2060280.6	5570
MW6	1591044.0	2062551.0	5553
MW7	1589982.8	2060959.6	5287
MW8	1591822.2	2062942.1	5149
MW9	1592244.1	2060677.5	5122

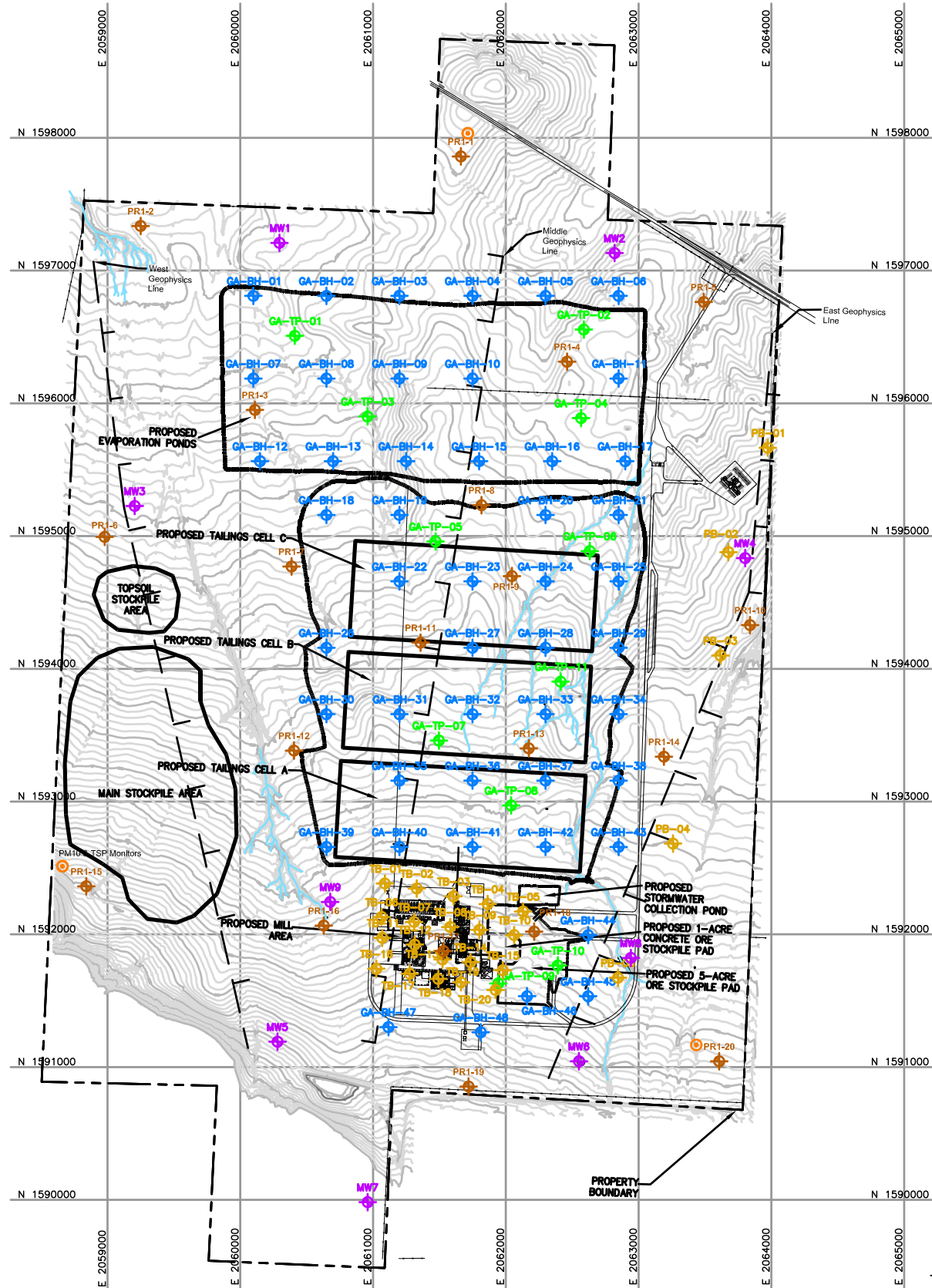

LEGEND

- PR1-20 ◆ KLEINFELDER 2007 GEOTECHNICAL PHASE 1 BORING LOCATIONS
- GA-BH-44 ◆ GOLDER 2007 GEOTECHNICAL PHASE 2 BORING LOCATIONS
- PB-4 ◆ TB-15 ◆ KLEINFELDER 2007 GEOTECHNICAL PHASE 2 BORING LOCATIONS
- GA-TP-10 ◆ GOLDER 2007 GEOTECHNICAL PHASE 2 TEST PIT LOCATIONS
- MW1 ◆ MW9 ◆ KLEINFELDER MONITORING WELL BORING LOCATIONS
- METEOROLOGICAL TOWER / AIR MONITORING STATION
- - - EFR PROPERTY BOUNDARY
- - - SEISMIC REFLECTION / REFRACTION LINES
- ▭ PROPOSED APPROXIMATE FACILITY AREAS
- EXISTING FENCE LINES
- PROPOSED ROADS

- ### NOTES
- THE PHASE 1 INVESTIGATION CONDUCTED BY KLEINFELDER INCLUDED INSTALLATION OF MONITORING WELLS (MW-1 THROUGH MW-9), GEOTECHNICAL BOREHOLES (PR-1 THROUGH PR-20), AND THREE GEOPHYSICAL SURVEY LINES. ADDITIONAL MONITORING WELLS (MW-7 THROUGH MW-9) WERE INSTALLED IN 2008.
 - DRILLHOLES GA-BH-1 THROUGH GA-BH-48, TB-1 THROUGH TB-20, AND PB-1 THROUGH PB-5 WERE ADVANCED BY DAKOTA DRILLING OF DENVER, COLORADO, FROM OCTOBER 23 THROUGH DECEMBER 15, 2007. AUGER DRILLING FOR SHALLOW SOIL BORINGS WAS CONDUCTED USING EITHER A CME-85 OR A DIETRICH 50 DRILL RIG. A DIETRICH 120 DRILL RIG WAS USED FOR THE DRILLHOLES REQUIRING CORING CAPABILITIES.
 - FOR DRILLHOLES GA-BH-1 THROUGH GA-BH-48, A GOLDER FIELD REPRESENTATIVE LOGGED THE SOIL AND ROCK MATERIALS ENCOUNTERED, COLLECTED SAMPLES OF MATERIALS FOR LABORATORY TESTING, AND OBSERVED AND/OR CONDUCTED IN-SITU TESTING. OTHER PHASE 2 DRILLING WAS OBSERVED BY A KLEINFELDER FIELD REPRESENTATIVE.
 - TEST PITS GA-TP-1 THROUGH GA-TP-11 WERE EXCAVATED ON 11/1/2007 AND 11/2/2007, USING A CATERPILLAR MODEL 430D BACKHOE OPERATED BY HIGH DESERT CONSTRUCTION. A GOLDER FIELD REPRESENTATIVE LOGGED THE TEST PITS AND COLLECTED SAMPLES OF MATERIALS FOR LABORATORY TESTING.
 - SITE GRADING AND DRAINAGE DESIGN BY OTHERS.

- ### REFERENCES
- TWO-FOOT CONTOUR BASE MAP PROVIDED BY KLEINFELDER IN JUNE 2008, CREATED FROM DRAWING BY ACCURATE SURVEY & ENGINEERING DATED 9/6/2007.
 - COORDINATES ARE PROVIDED IN A SCALED VERSION (ADJUSTED TO GROUND) OF THE COLORADO STATE PLANE (SOUTH ZONE) COORDINATE SYSTEM USING NAD83 AS THE HORIZONTAL DATUM.
 - ELEVATIONS PROVIDED ARE IN FEET ABOVE MEAN SEA LEVEL USING NAV88 AS THE VERTICAL DATUM.
 - TABLES 2-1 AND 2-2 REFLECT THE PROPOSED DRILLING LOCATIONS. ACTUAL DRILLING LOCATIONS TYPICALLY VARY BY 5 FEET LATERSL. THE COORDINATES AND ELEVATIONS LISTED FOR GA-BH-47 AND GA-BH-48 ARE ESTIMATIONS AS THEIR PROPOSED LOCATIONS WERE NOT SURVEYED.
 - ELEVATIONS LISTED IN TABLES 2-3 AND 2-4 ARE ESTIMATED BASED ON THE TOPOGRAPHY AT THE I.D. LOCATION.

Draw Name: N:\07\0715-81694\071581694.dwg
 Last Update: Oct 02, 2008 08:36
 By: Jellinek
 Last Plot: Oct 03, 2008 09:30

REV	DATE	DES	ISSUED FOR DESIGN REPORT	JDE	KFM	JMJ
10/8/08	KFM		REVISION DESCRIPTION	CADD	CHK	RW
PROJECT: ENERGY FUELS RESOURCES CORPORATION PIÑON RIDGE PROJECT - TAILINGS CELL DESIGN MONTROSE COUNTY, COLORADO						
TITLE: GENERAL PROJECT LAYOUT AND LOCATIONS OF GEOTECHNICAL INVESTIGATIONS						
PROJECT No. 073-81694		FILE No. 07381694A034				
DESIGN	JDE	02/08	SCALE AS SHOWN	REV. A		
CADD	JDE	02/08	DRAWING			
CHECK	KFM	05/08				
REVIEW	JMJ	05/08				
				2		

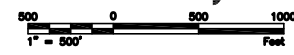

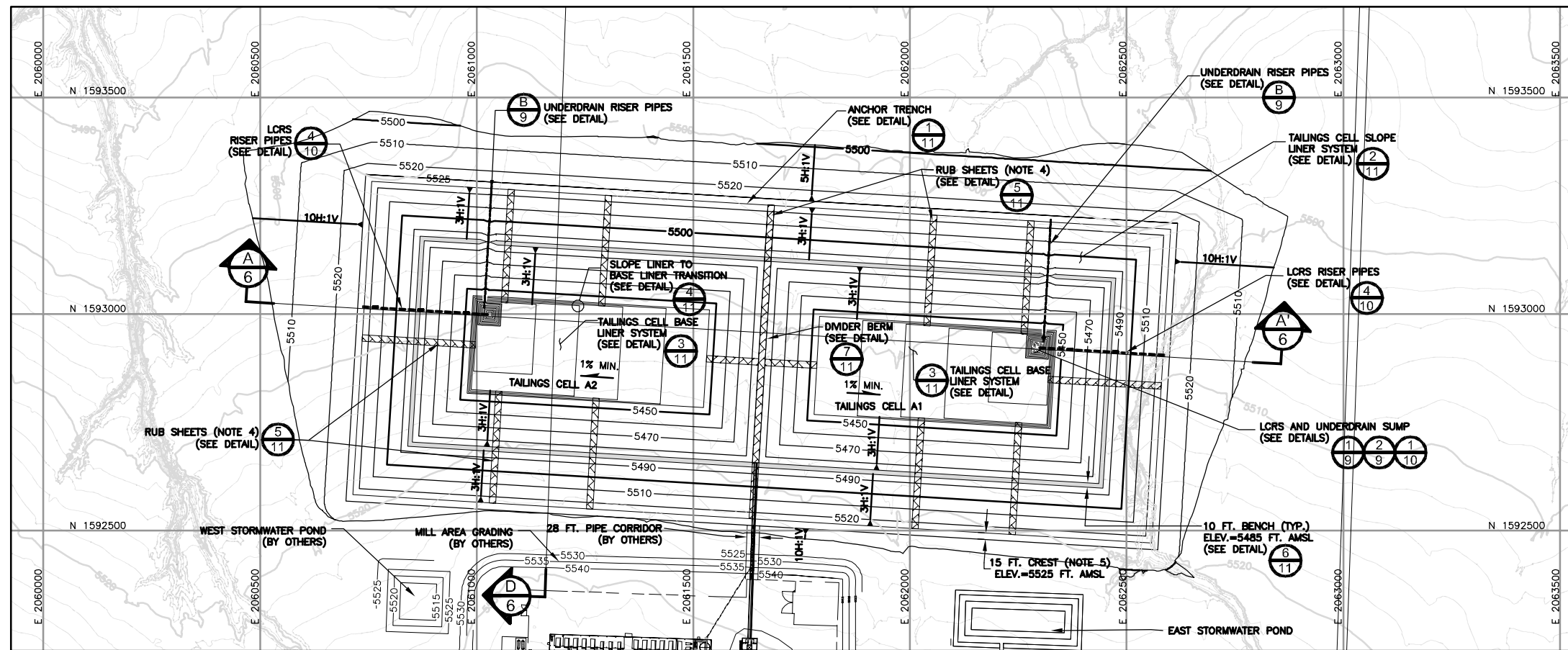

1 TAILINGS CELL A GRADING PLAN
SCALE: 1 IN. = 150 FT.

LEGEND

- EXISTING GROUND TOPOGRAPHY (SEE REFERENCE 1)
- PROPOSED FINISHED GRADE TOPOGRAPHY
- RUB SHEET (NOTE 4)
- ANCHOR BENCH
- LCRS RISER PIPES
- UNDERDRAIN RISER PIPES
- ISOPACH CUT CONTOUR
- ISOPACH FILL CONTOUR
- ISOPACH ZERO CONTOUR
- SLOPE DIRECTION
- CROSS SECTION IDENTIFIER
- SHEET WHERE SECTION IS LOCATED

NOTES

1. EACH TAILINGS CELL IS DESIGNED FOR A MINIMUM CAPACITY OF 2.45 MILLION TONS ASSUMING A DRY DENSITY OF 95 PCF.
2. GRADING PLAN DEVELOPED TO PROVIDE EXCESS MATERIAL FOR FUTURE USE AS CLOSURE COVER BORROW. MATERIAL TO BE STOCKPILED ON SITE WITH MAXIMUM SLOPES OF 3H:1V.
3. GRADING PLAN CONTOURS REPRESENT TOP OF UPPER GEOMEMBRANE WITHIN TAILINGS CELL, AND TOP OF STRUCTURAL FILL OUTSIDE THESE LIMITS.
4. RUB SHEETS PLACED PER CLIENT RECOMMENDATION WHERE NEEDED AROUND TAILINGS CELL PERIMETER TO FACILITATE TAILINGS DELIVERY.
5. EMBANKMENT CREST TO BE SLOPED AT A MINIMUM OF ONE PERCENT INTO THE TAILINGS CELL.

REFERENCES

1. TWO-FOOT CONTOUR BASE MAP PROVIDED BY KLEINFELDER IN JUNE 2006, CREATED FROM DRAWING BY ACCURATE SURVEY & ENGINEERING DATED 9/6/2007.

GRADING QUANTITIES

	CUT (CU. YDS.)	FILL (CU. YDS.)	EXCESS (CU. YDS.)
CELL A	1,713,000	307,000	1,406,000 (CUT)

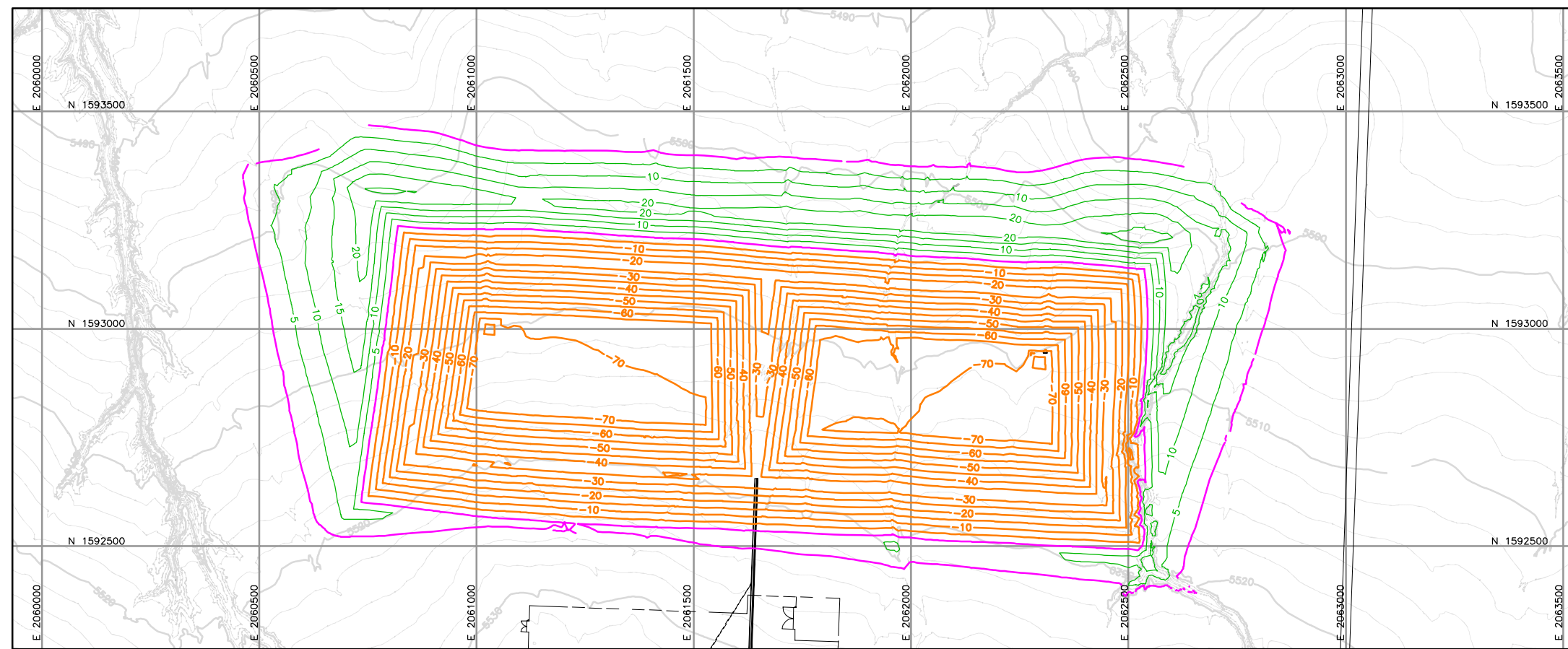
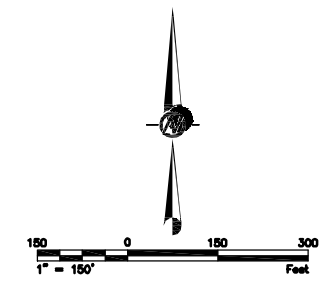

2 TAILINGS CELL A ISOPACH PLAN
SCALE: 1 IN. = 150 FT.

10/8/08	KFM	ISSUED FOR DESIGN REPORT	JWR	KFM	JMJ	
REV	DATE	DES	REVISION DESCRIPTION	CADD	CHK	RW
ENERGY FUELS RESOURCES CORPORATION PIÑON RIDGE PROJECT - TAILINGS CELL DESIGN MONTROSE COUNTY, COLORADO						
TITLE TAILINGS CELL A EXCAVATION GRADING PLAN AND ISOPACH						
Golder Associates DENVER, COLORADO		PROJECT No. 073-81694 DESIGN JWR 02/08 CADD JWR 02/08 CHECK KFM 05/08 REVIEW JMJ 05/08	FILE No. 07381694A039 SCALE AS SHOWN DRAWING 3	REV. A		

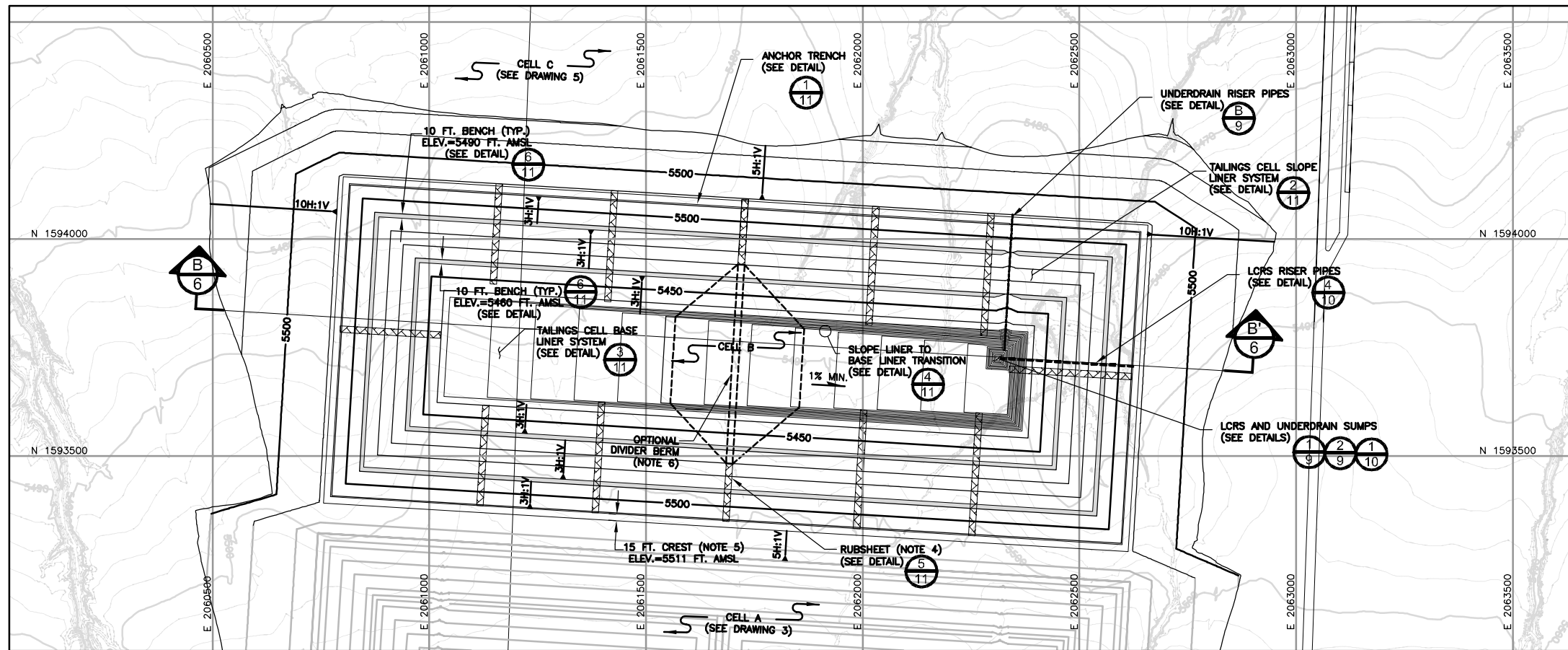

1 TAILINGS CELL B GRADING PLAN
 SCALE: 1 IN. = 150 FT.

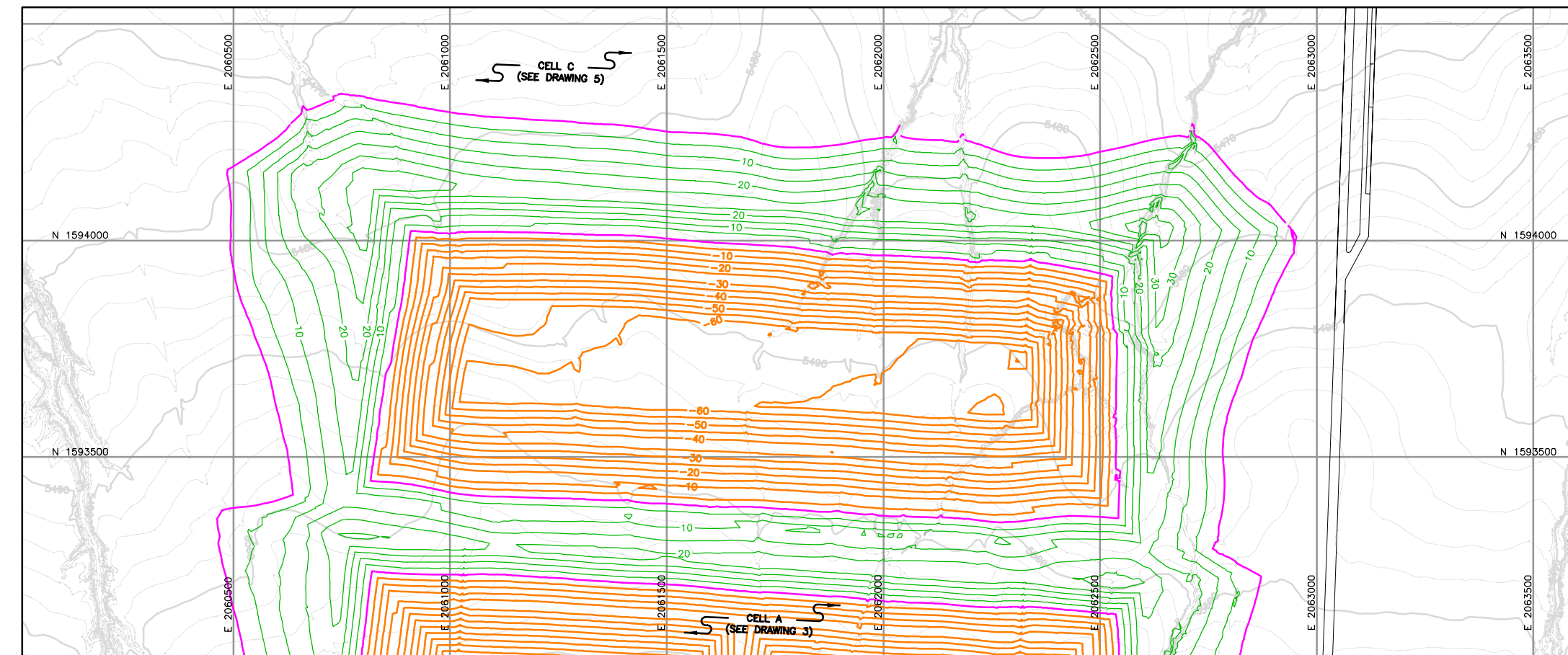

2 TAILINGS CELL B ISOPACH PLAN
 SCALE: 1 IN. = 150 FT.

LEGEND

- EXISTING GROUND TOPOGRAPHY (SEE REFERENCE 1)
- PROPOSED FINISHED GRADE TOPOGRAPHY
- RUB SHEET (NOTE 4)
- ANCHOR BENCH
- UNDERDRAIN RISER PIPES
- LCRS RISER PIPES
- ISOPACH CUT CONTOUR
- ISOPACH FILL CONTOUR
- ISOPACH ZERO CONTOUR
- OPTIONAL DIVIDER BERM LOCATION
- TOE CREST SLOPE DIRECTION
- CROSS SECTION IDENTIFIER
- SHEET WHERE SECTION IS LOCATED

NOTES

1. EACH TAILINGS CELL IS DESIGNED FOR A MINIMUM CAPACITY OF 2.45 MILLION TONS ASSUMING A DRY DENSITY OF 95 PCF.
2. GRADING PLAN DEVELOPED TO PROVIDE EXCESS MATERIAL FOR FUTURE USE AS CLOSURE COVER BORROW. MATERIAL TO BE STOCKPILED ON SITE WITH MAXIMUM SLOPES OF 3H:1V.
3. GRADING PLAN CONTOURS REPRESENT TOP OF UPPER GEOMEMBRANE WITHIN TAILINGS CELL, AND TOP OF STRUCTURAL FILL OUTSIDE THESE LIMITS.
4. RUB SHEET PLACED PER CLIENT RECOMMENDATION WHERE NEEDED AROUND TAILINGS CELL PERIMETER TO FACILITATE TAILINGS DELIVERY.
5. EMBANKMENT CREST TO BE SLOPED AT A MINIMUM OF ONE PERCENT INTO THE TAILINGS CELL.
6. DEPENDING ON OPERATIONS AT THE TIME OF CELL B CONSTRUCTION, A DIVIDER BERM SIMILAR TO THAT IN CELL A MAY BE CONSTRUCTED IN CELL B. IN THIS EVENT, GRADING WEST OF THE CELL CENTERLINES WILL SLOPE AT 1 PERCENT DOWN TO LCRS AND UNDERDRAIN SUMPS AT THE NORTHWEST CORNER OF THE CELL BASE. ADDITIONALLY, THE 2-BENCH SYSTEM SHOWN WILL BE REPLACED BY A 1-BENCH SYSTEM SIMILAR TO THAT SHOWN FOR CELL A.

REFERENCES

1. TWO-FOOT CONTOUR BASE MAP PROVIDED BY KLEINFELDER IN JUNE 2008, CREATED FROM DRAWING BY ACCURATE SURVEY & ENGINEERING DATED 9/6/2007.

GRADING QUANTITIES

	CUT (CU. YDS.)	FILL (CU. YDS.)	EXCESS (CU. YDS.)
CELL B	1,386,000	522,000	864,000 (CUT)

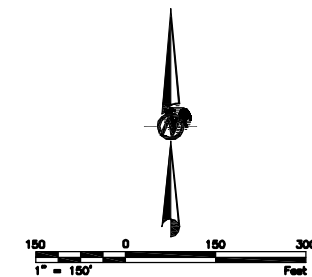

REV	10/8/08	KFM	ISSUED FOR DESIGN REPORT	JWR	KFM	JMJ
DES			REVISION DESCRIPTION	CADD	CHK	RW
PROJECT ENERGY FUELS RESOURCES CORPORATION PIÑON RIDGE PROJECT - TAILINGS CELL DESIGN MONTROSE COUNTY, COLORADO						
TITLE TAILINGS CELL B EXCAVATION GRADING PLAN AND ISOPACH						
PROJECT No. 073-81694		FILE No. 07381694AD40		SCALE AS SHOWN REV. A		
DESIGN	JWR	02/08	DRAWING	4		
CADD	JWR	02/08				
CHECK	KFM	05/08				
REVIEW	JMJ	05/08				



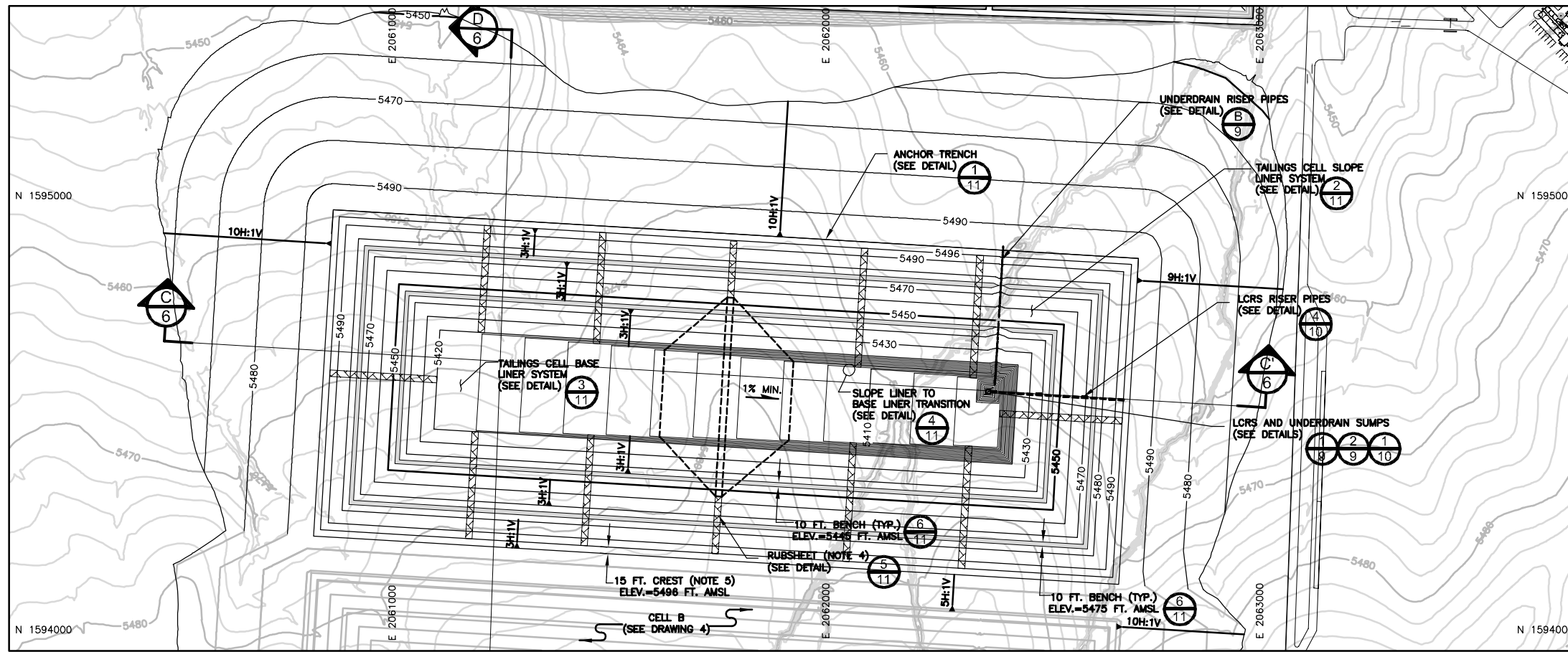

1 TAILINGS CELL C GRADING PLAN
 SCALE: 1 IN. = 150 FT.

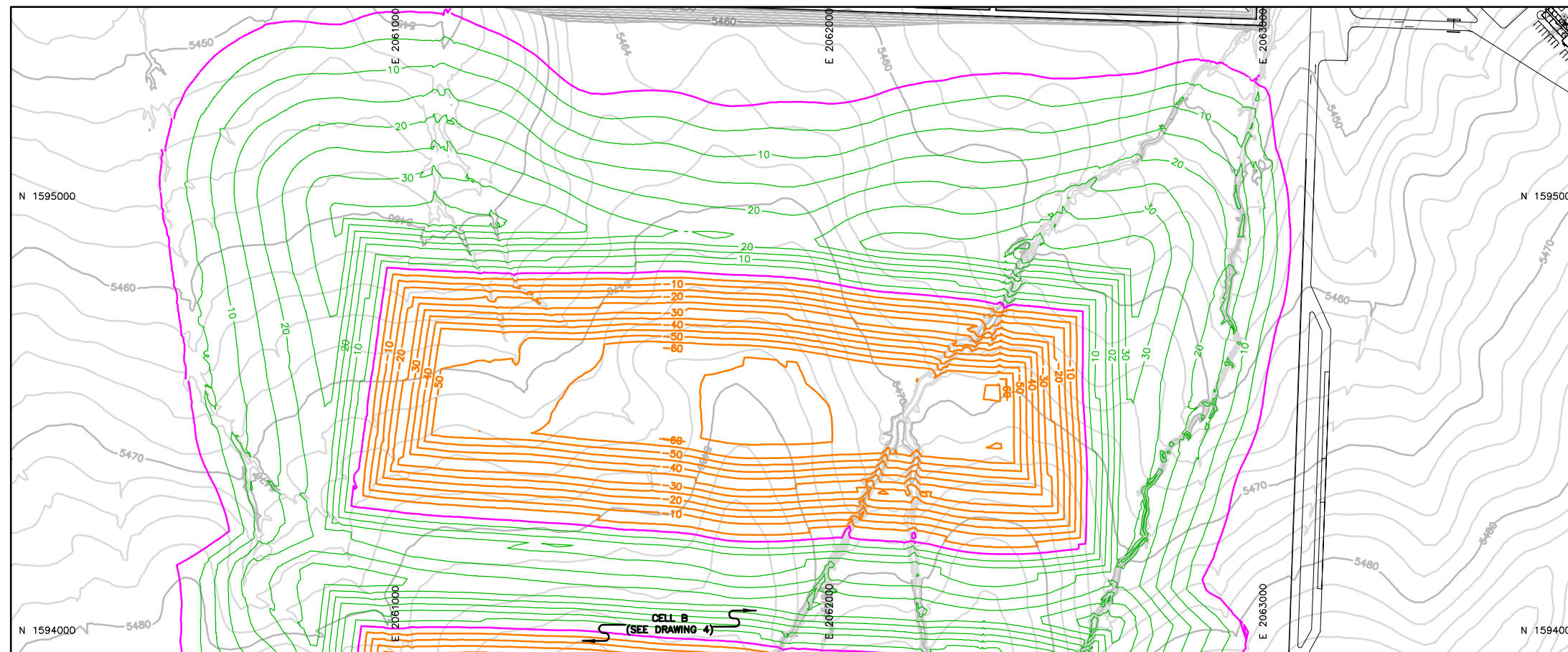

2 TAILINGS CELL C ISOPACH PLAN
 SCALE: 1 IN. = 150 FT.

LEGEND

- EXISTING GROUND TOPOGRAPHY (SEE REFERENCE 1)
- PROPOSED FINISHED GRADE TOPOGRAPHY
- RUB SHEET (NOTE 4)
- ANCHOR BENCH
- UNDERDRAIN RISER PIPES
- LCRS RISER PIPES
- ISOPACH CUT CONTOUR
- ISOPACH FILL CONTOUR
- ISOPACH ZERO CONTOUR
- OPTIONAL DIVIDER BERM LOCATION
- SLOPE DIRECTION
- CROSS SECTION IDENTIFIER
- SHEET WHERE SECTION IS LOCATED

NOTES

1. EACH TAILINGS CELL IS DESIGNED FOR A MINIMUM CAPACITY OF 2.45 MILLION TONS ASSUMING A DRY DENSITY OF 95 PCF.
2. GRADING PLAN DEVELOPED TO PROVIDE EXCESS MATERIAL FOR FUTURE USE AS CLOSURE COVER BORROW. MATERIAL TO BE STOCKPILED ON SITE WITH MAXIMUM SLOPES OF 3H:1V.
3. GRADING PLAN CONTOURS REPRESENT TOP OF UPPER GEOMEMBRANE WITHIN TAILINGS CELL, AND TOP OF STRUCTURAL FILL OUTSIDE THESE LIMITS.
4. RUB SHEET PLACED PER CLIENT RECOMMENDATION WHERE NEEDED AROUND TAILINGS CELL PERIMETER TO FACILITATE TAILINGS DELIVERY.
5. EMBANKMENT CREST TO BE SLOPED AT A MINIMUM OF ONE PERCENT INTO THE TAILINGS CELL.
6. DEPENDING ON OPERATIONS AT THE TIME OF CELL C CONSTRUCTION, A DIVIDER BERM SIMILAR TO THAT IN CELL A MAY BE CONSTRUCTED IN CELL C. IN THIS EVENT, GRADING WEST OF THE CELL CENTERLINES WILL SLOPE AT 1 PERCENT DOWN TO LCRS AND UNDERDRAIN SUMPS AT THE NORTHWEST CORNER OF THE CELL BASE. ADDITIONALLY, THE 2-BENCH SYSTEM SHOWN WILL BE REPLACED BY A 1-BENCH SYSTEM SIMILAR TO THAT SHOWN FOR CELL A.

REFERENCES

1. TWO-FOOT CONTOUR BASE MAP PROVIDED BY KLEINFELDER IN JUNE 2006, CREATED FROM DRAWING BY ACCURATE SURVEY & ENGINEERING DATED 9/6/2007.

GRADING QUANTITIES

	CUT (CU. YDS.)	FILL (CU. YDS.)	EXCESS (CU. YDS.)
CELL C	1,270,000	1,036,000	234,000 (CUT)

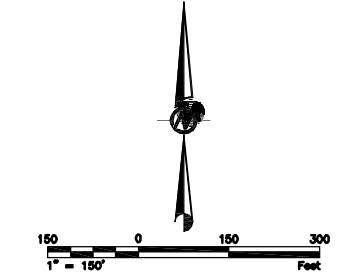

10/8/08	KFM	ISSUED FOR DESIGN REPORT	JWR	KFM	JMJ	
REV	DATE	DES	REVISION DESCRIPTION	CADD	CHK	RW
PROJECT: ENERGY FUELS RESOURCES CORPORATION PIÑON RIDGE PROJECT - TAILINGS CELL DESIGN MONTROSE COUNTY, COLORADO						
TITLE: TAILINGS CELL C EXCAVATION GRADING PLAN AND ISOPACH						
PROJECT No. 073-81694		FILE No. 07381684042				
DESIGN	JWR	02/06	SCALE	AS SHOWN	REV. A	
CADD	JWR	02/06	DRAWING			
CHECK	KFM	05/06				
REVIEW	JMJ	05/06				
			5			

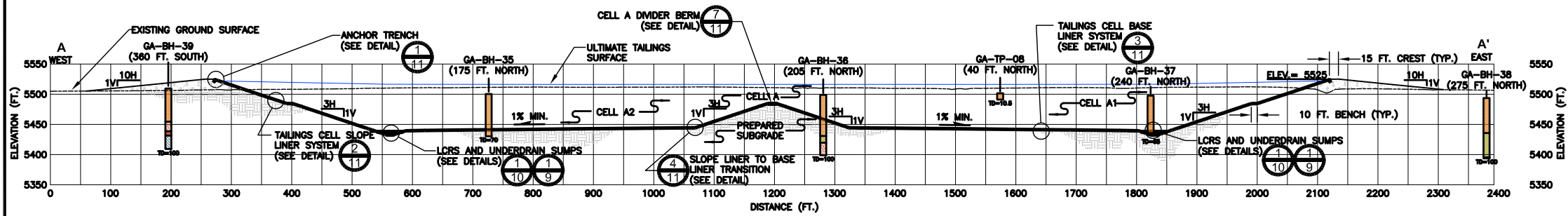

A TAILINGS CELL A, SECTION A-A'
SCALE: 1 IN. = 100 FT.

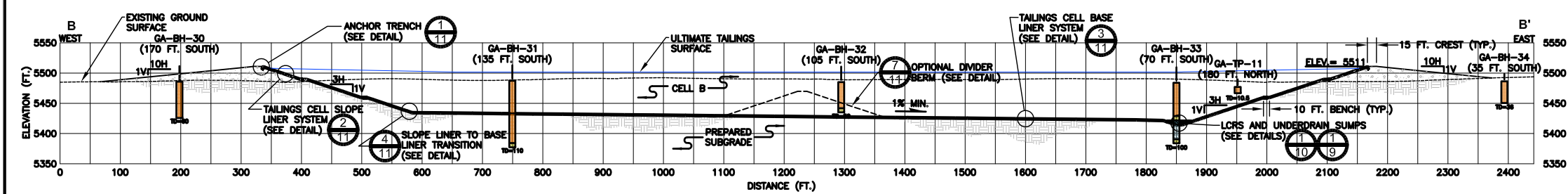

B TAILINGS CELL B, SECTION B-B'
SCALE: 1 IN. = 100 FT.

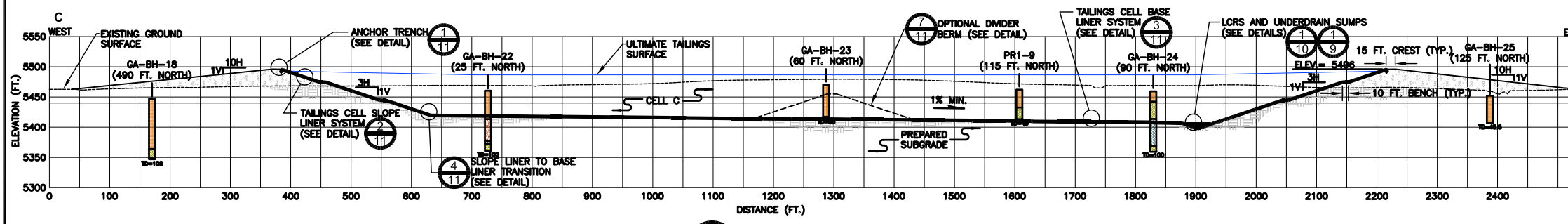

C TAILINGS CELL C, SECTION C-C'
SCALE: 1 IN. = 100 FT.

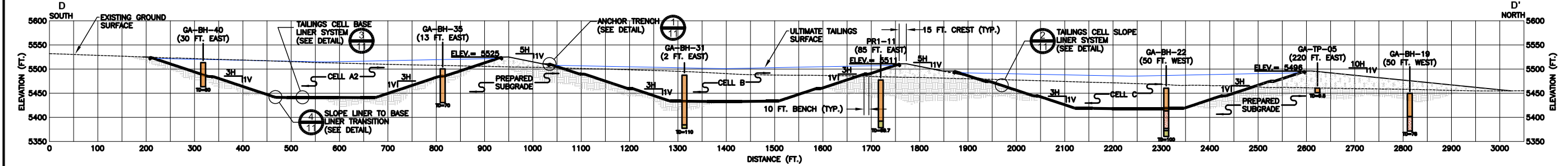

D TAILINGS CELLS A, B AND C, SECTION D-D'
SCALE: 1 IN. = 100 FT.

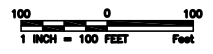

LEGEND

- EXISTING GRADE
- ULTIMATE TAILINGS SURFACE
- PROPOSED TOP OF LINER
- GRADING SURFACE
- FINISHED GRADE AFTER PREVIOUS CELL CONSTRUCTION
- DETAIL IDENTIFIER
- SHEET WHERE DETAIL IS LOCATED

- GA-BH-36 BORING/TEST PIT DESIGNATION (205 FT. NORTH) OFFSET FROM SECTION LINE
- SIMPLIFIED GEOLOGY
- TOTAL DEPTH OF INVESTIGATION (FEET)
- OVERBURDEN SOILS: CONSISTING PRIMARILY OF LOESS. SOIL CLASSIFIES AS SILTY SAND (SM) AND LEAN SILT (ML) WITH OCCASIONAL LAYERS OF LEAN CLAY (CL), CLAYEY SAND (SC), AND SILTY GRAVEL (GM). BLOW COUNTS FOR 12 INCHES OF PENETRATION TYPICALLY RANGED FROM 10 TO 50 NEAR THE SURFACE (0-10 FT.) AND GREATER THAN 50 BELOW 10 FEET DUE TO SOIL CEMENTATION.
- CLAYSTONE: PREDOMINATELY HERMOSA FORMATION, OCCASIONAL MOENKOPI FORMATION - MODERATELY TO HIGHLY WEATHERED, VERY STIFF TO HARD, OLIVE COLORED, TYPICALLY INTENSELY AND IRREGULARLY FRACTURED.
- GYPSUM: HERMOSA FORMATION, PARADOX MEMBER - FRESH TO SLIGHTLY WEATHERED, VERY WEAK TO WEAK, MOTTLED IN COLOR (BLACK, GRAY, AND WHITE).
- SANDSTONE/SILTSTONE: MOENKOPI AND CUTLER FORMATIONS - SLIGHTLY TO HIGHLY WEATHERED, VERY WEAK TO MEDIUM STRONG, FINE TO VERY FINE GRAINED SAND.
- CONGLOMERATE: MOENKOPI FORMATION - SLIGHTLY TO HIGHLY WEATHERED, VERY WEAK TO WEAK, REDDISH BROWN WITH PARTICLES SIZES RANGING FROM SILT TO COBBLES, HIGHLY FRACTURED WITH OCCASIONAL ZONES OF INTACT ROCK.
- PREPARED SUBGRADE OR EXISTING SUBGRADE.
- STRUCTURAL FILL

REV	DATE	DES	ISSUED FOR DESIGN REPORT	JWR	KFM	JMJ
			REVISION DESCRIPTION	CADD	CHK	R/W
PROJECT ENERGY FUELS RESOURCES CORPORATION PIÑON RIDGE PROJECT - TAILINGS CELL DESIGN MONTROSE COUNTY, COLORADO						
TITLE TAILINGS CELL TYPICAL SECTIONS						
PROJECT No. 073-81894		FILE No. 07381894A043				
DESIGN	JWR	02/08	SCALE AS SHOWN	REV. A		
CADD	JWR	02/08	DRAWING			
CHECK	KFM	05/08	6			
REVIEW	JMJ	05/08				



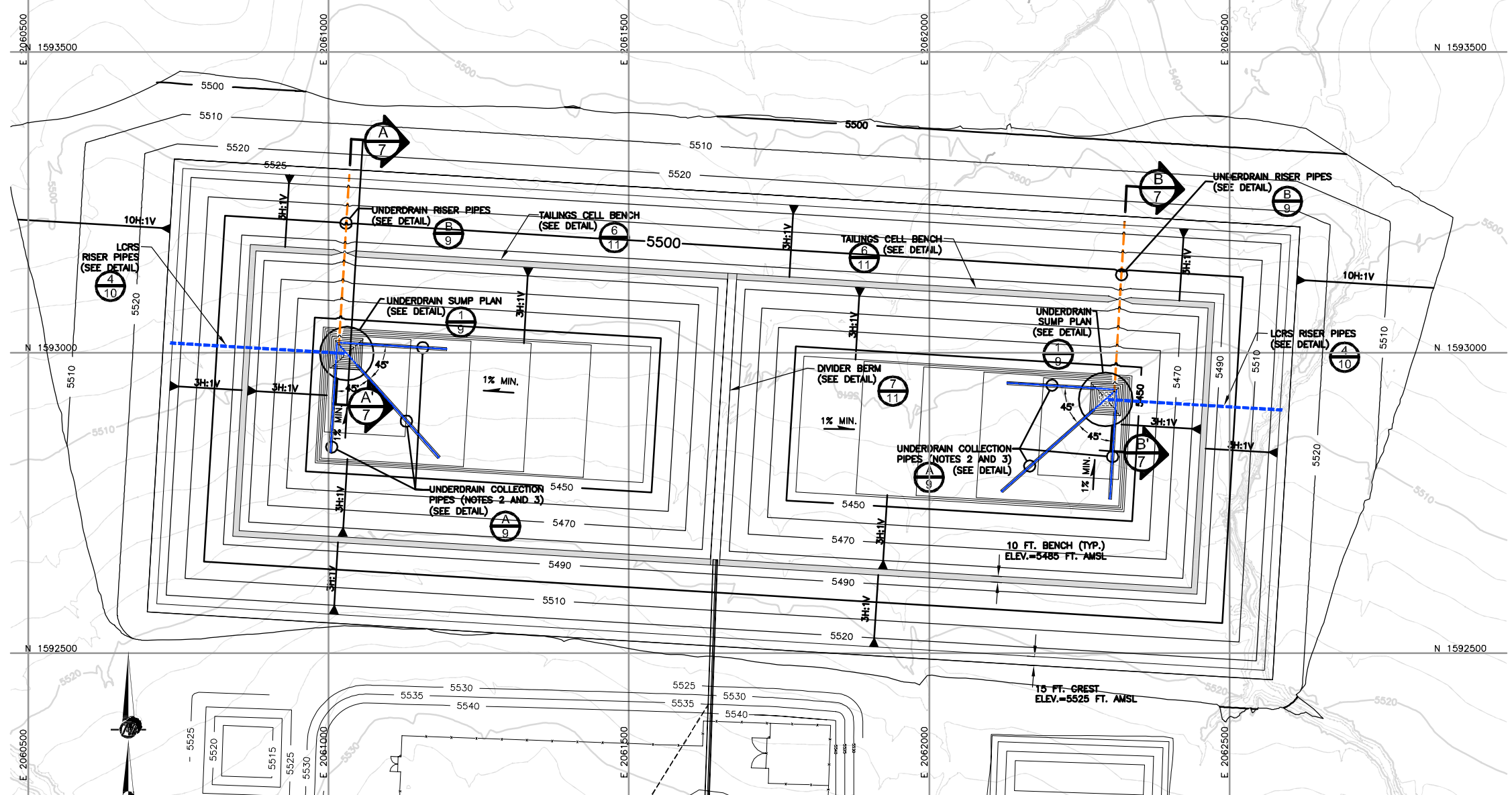

1 TAILINGS CELL A UNDERDRAIN SYSTEM
SCALE: 1 IN. = 100 FT.

LEGEND

- PROPOSED FINISHED GRADE TOPOGRAPHY
- EXISTING GROUND TOPOGRAPHY
- ANCHOR BENCH
- TOE / CREST SLOPE DIRECTION
- CROSS SECTION IDENTIFIER
- SHEET WHERE SECTION IS LOCATED
- 8-INCH DIA. PERFORATED CORRUGATED HDPE UNDERDRAIN COLLECTION PIPE
- 2 EA. 10-INCH DIA. SDR-11 HDPE UNDERDRAIN RISER PIPE
- 10-INCH DIA. SDR-17 HDPE LCRS RISER PIPE
- PREPARED OR EXISTING SUBGRADE
- STRUCTURAL FILL
- FINE UNDERDRAIN FILL
- COARSE UNDERDRAIN FILL
- LEAK DETECTION FILL

- ### NOTES
- GRADING PLAN CONTOURS REPRESENT TOP OF UPPER GEOMEMBRANE WITHIN TAILINGS CELL, AND TOP OF STRUCTURAL FILL OUTSIDE THESE LIMITS.
 - RUB SHEETS PLACED PER CLIENT RECOMMENDATION WHERE NEEDED AROUND TAILINGS CELL PERIMETER TO FACILITATE TAILINGS DELIVERY.
 - PLACE PIPE CAPS ON ALL PIPE ENDS.
 - MAINTAIN A MINIMUM ONE PERCENT SLOPE ON BASE OF UNDERDRAIN COLLECTION PIPE TRENCH.

- ### REFERENCES
- TWO-FOOT CONTOUR BASE MAP PROVIDED BY KLEINFELDER IN JUNE 2008, CREATED FROM DRAWING BY ACCURATE SURVEY & ENGINEERING DATED 9/6/2007.

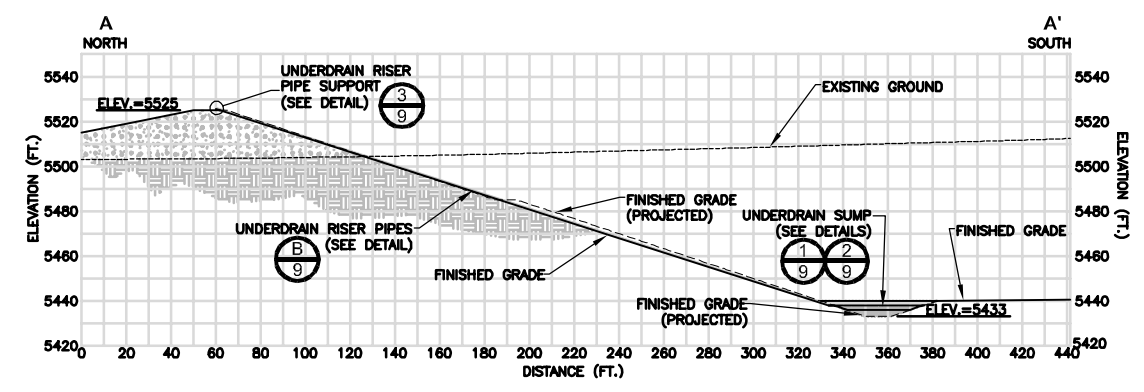

A UNDERDRAIN RISER SECTION A-A'
SCALE: 1 IN. = 40 FT.

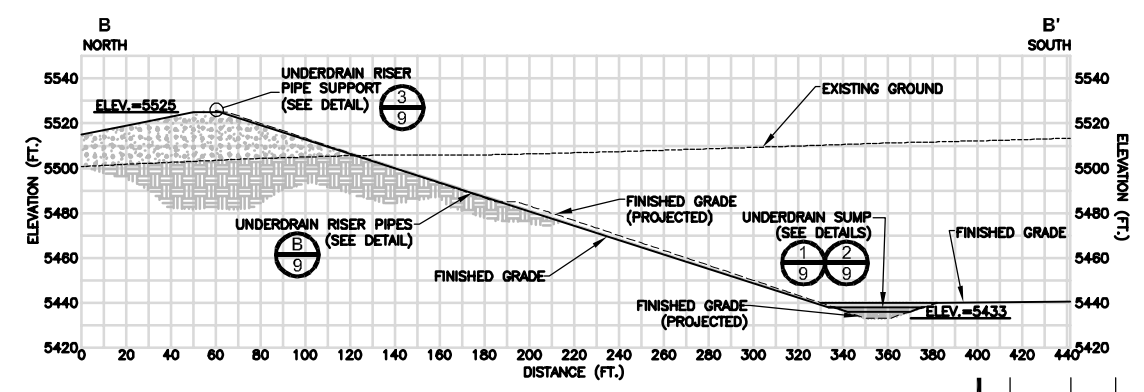

B UNDERDRAIN RISER SECTION B-B'
SCALE: 1 IN. = 40 FT.

REV	DATE	DES	ISSUED FOR DESIGN REPORT	JWR	KFM	JMJ
			REVISION DESCRIPTION	CADD	CHK	RW
PROJECT ENERGY FUELS RESOURCES CORPORATION PIÑON RIDGE PROJECT - TAILINGS CELL DESIGN MONTROSE COUNTY, COLORADO						
TITLE TAILINGS CELL A UNDERDRAIN PLAN AND SECTIONS						
PROJECT No. 073-81694		FILE No. 07381694048				
DESIGN	KFM	02/08	SCALE AS SHOWN	REV.	A	
CADD	JDE	02/08	DRAWING	7		
CHECK	KFM	05/08				
REVIEW	JMJ	05/08				

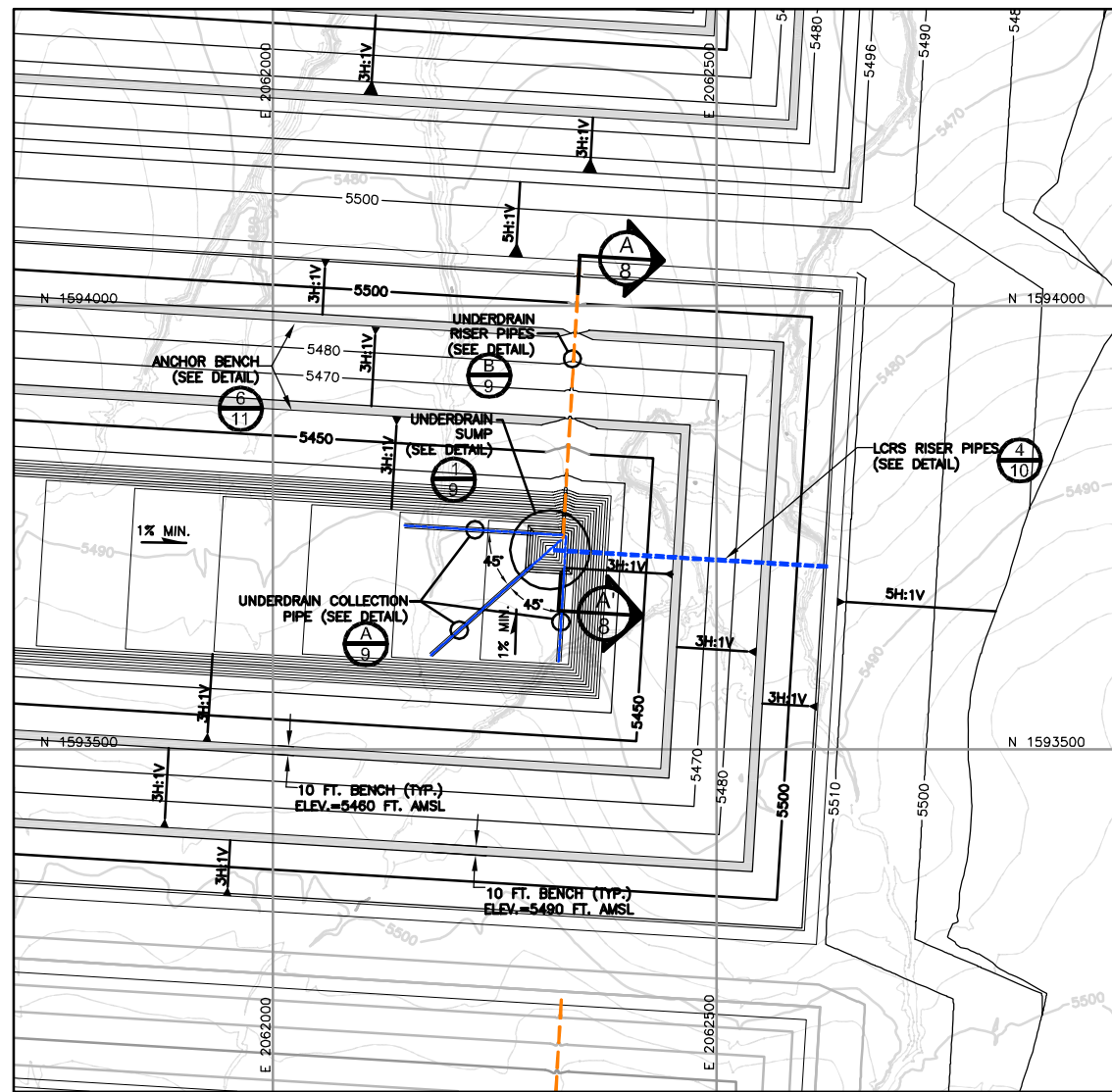

1 TAILINGS CELL B UNDERDRAIN SYSTEM
 SCALE: 1 IN. = 100 FT.

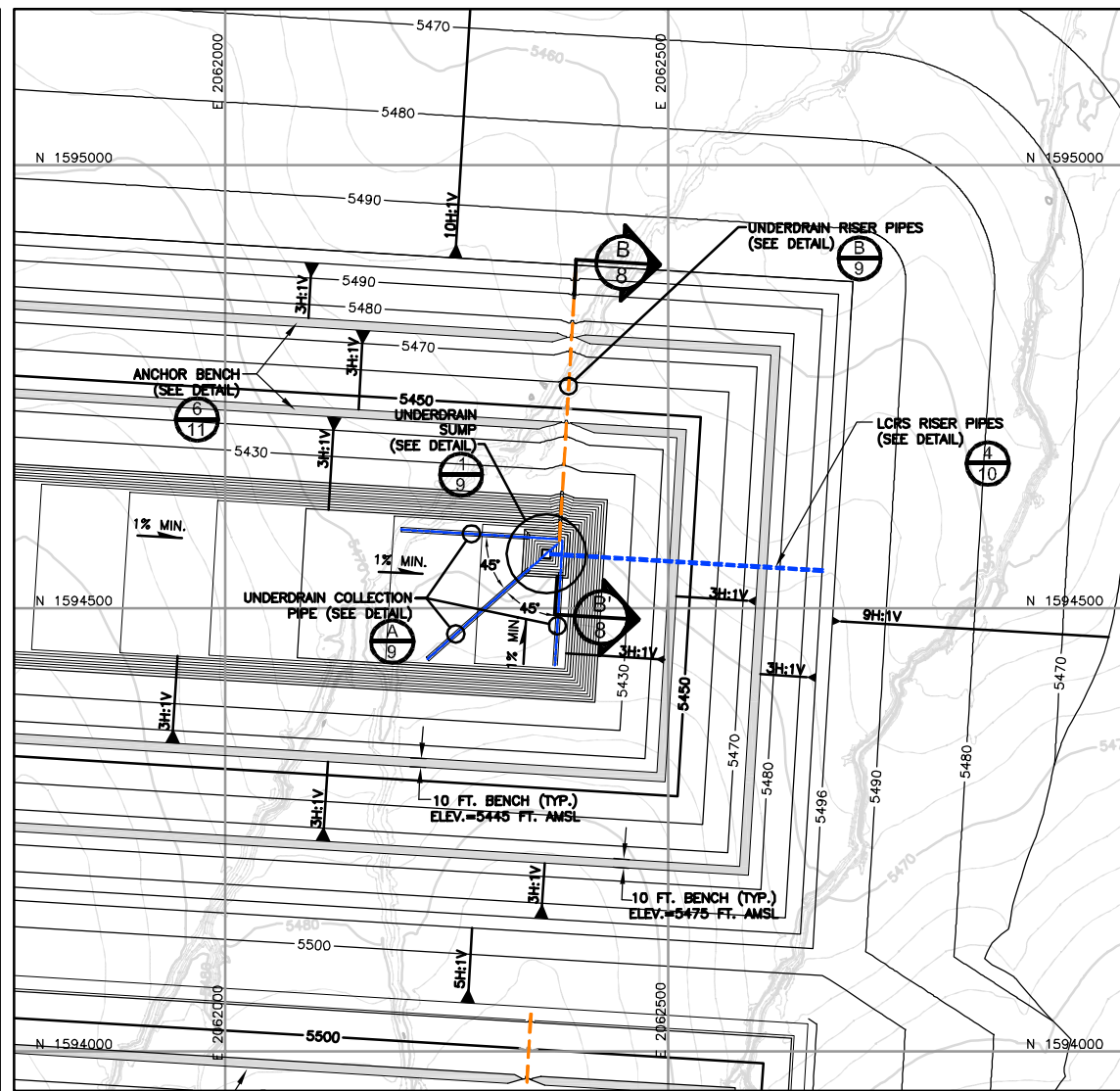

2 TAILINGS CELL C UNDERDRAIN SYSTEM
 SCALE: 1 IN. = 100 FT.

LEGEND

- PROPOSED FINISHED GRADE TOPOGRAPHY
- EXISTING GROUND TOPOGRAPHY
- ANCHOR BENCH
- SLOPE DIRECTION
- CROSS SECTION IDENTIFIER
- SHEET WHERE SECTION IS LOCATED
- 8-INCH DIA. PERFORATED CORRUGATED HDPE UNDERDRAIN COLLECTION PIPE
- 2 EA. 10-INCH DIA. SDR-11 HDPE UNDERDRAIN RISER PIPE
- 10-INCH DIA. SDR-17 HDPE LCRS RISER PIPE
- PREPARED OR EXISTING SUBGRADE
- STRUCTURAL FILL
- FINE UNDERDRAIN FILL
- COARSE UNDERDRAIN FILL
- LEAK DETECTION FILL

- ### NOTES
- GRADING PLAN CONTOURS REPRESENT TOP OF UPPER GEOMEMBRANE WITHIN TAILINGS CELL, AND TOP OF STRUCTURAL FILL OUTSIDE THESE LIMITS.
 - PLACE PIPE CAPS ON ALL PIPE ENDS.
 - MAINTAIN A MINIMUM ONE PERCENT SLOPE ON BASE OF UNDERDRAIN COLLECTION PIPE TRENCH.

- ### REFERENCES
- TWO-FOOT CONTOUR BASE MAP PROVIDED BY KLEINFELDER IN JUNE 2008, CREATED FROM DRAWING BY ACCURATE SURVEY & ENGINEERING DATED 9/6/2007.

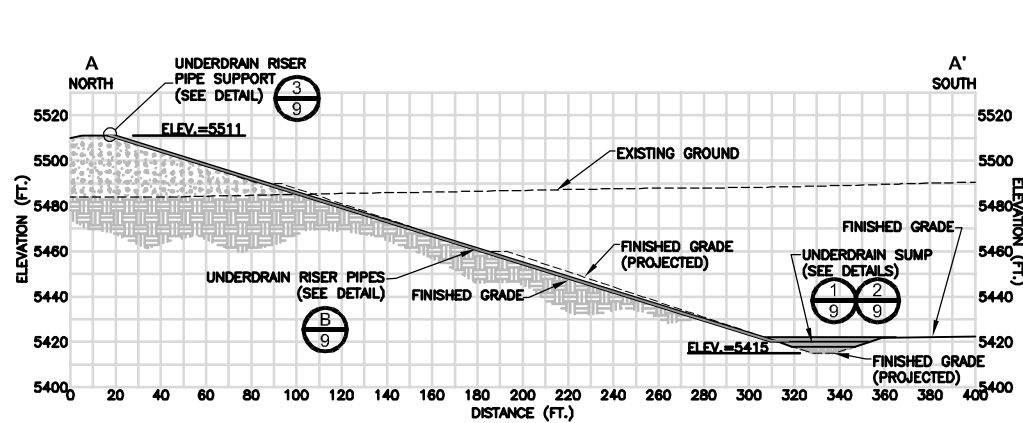

A TAILINGS CELL B UNDERDRAIN SYSTEM SECTION A-A'
 SCALE: 1 IN. = 40 FT.

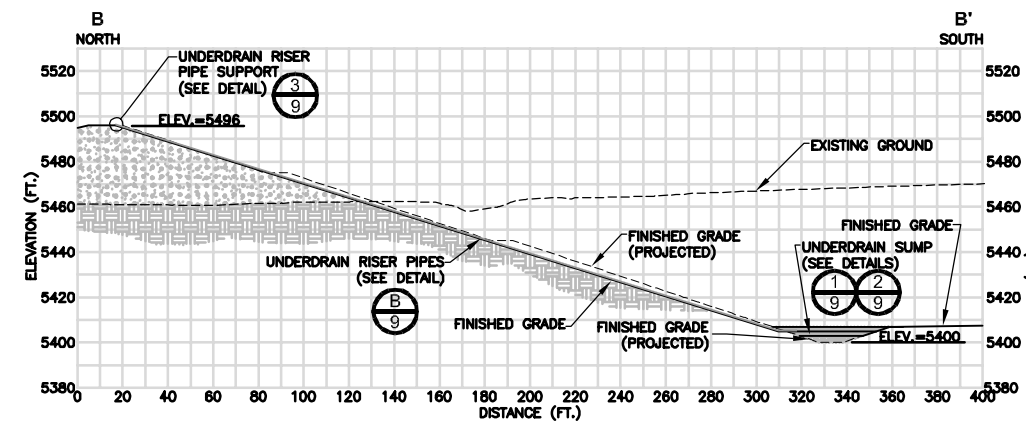

B TAILINGS CELL C UNDERDRAIN SYSTEM SECTION B-B'
 SCALE: 1 IN. = 40 FT.

REV	DATE	DES	ISSUED FOR DESIGN REPORT	JWR	KFM	JMJ
10/8/08	KFM					
REV	DATE	DES	REVISION DESCRIPTION	CADD	CHK	RW
PROJECT ENERGY FUELS RESOURCES CORPORATION PIÑON RIDGE PROJECT - TAILINGS CELL DESIGN MONTROSE COUNTY, COLORADO						
TITLE TAILINGS CELLS B AND C UNDERDRAIN PLANS AND SECTIONS						
PROJECT No. 073-81694			FILE No. 07381694A049			
DESIGN	KFM	02/08	SCALE	AS SHOWN	REV.	A
CADD	JDE	03/08	DRAWING		8	
CHECK	KFM	05/08				
REVIEW	JMJ	05/08				



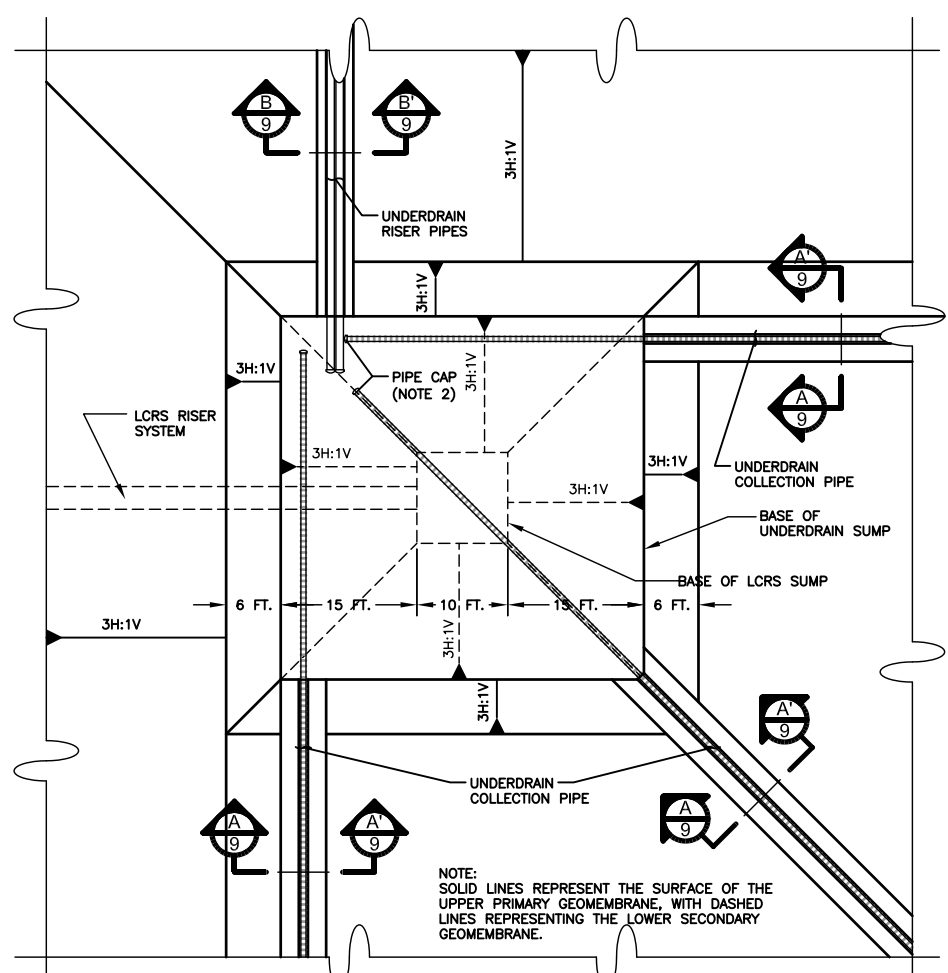

1 UNDERDRAIN SUMP GRADING PLAN
1 IN. = 10 FT.

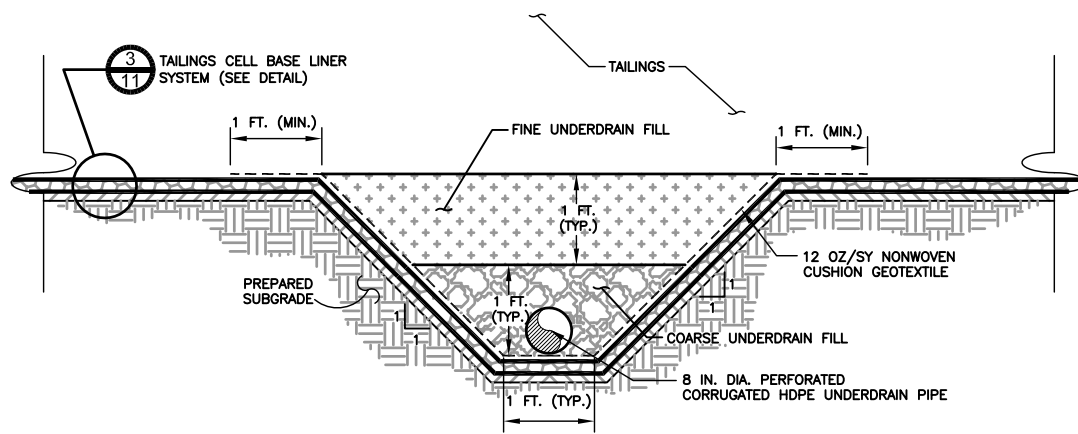

A UNDERDRAIN COLLECTION PIPE SECTION A-A'
N.T.S.

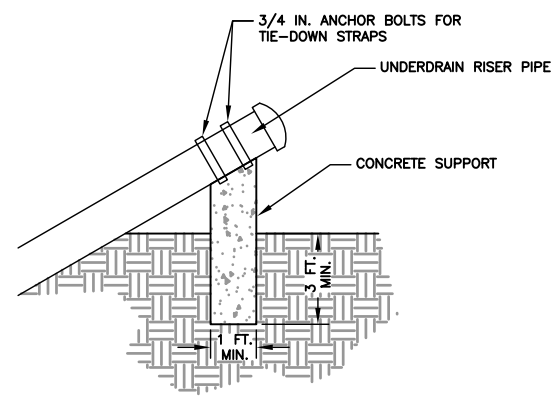

3 UNDERDRAIN RISER PIPE SUPPORT
N.T.S.

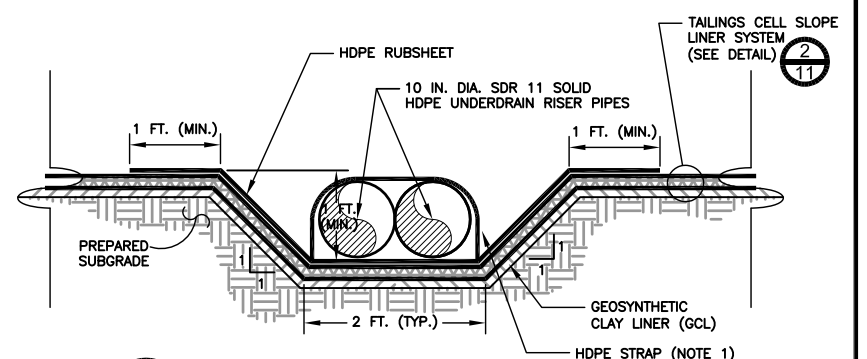

B UNDERDRAIN RISER PIPE SECTION B-B'
N.T.S.

NOTES

- TEMPORARY RISER PIPE SUPPORT HDPE STRAPS TACK-WELDED TO HDPE RUBSHEET AS NEEDED, FIELD-FIT AS APPROVED BY ENGINEER.
- PLACE PIPE CAPS ON ALL PIPE ENDS.
- MAINTAIN MINIMUM ONE PERCENT SLOPE ON BASE OF UNDERDRAIN COLLECTION PIPE TRENCH.
- PUMP FOR UNDERDRAIN SYSTEM TO BE SUPPLIED BY OTHERS. COLLECTED SOLUTIONS TO BE RETURNED TO THE MILL CIRCUIT.

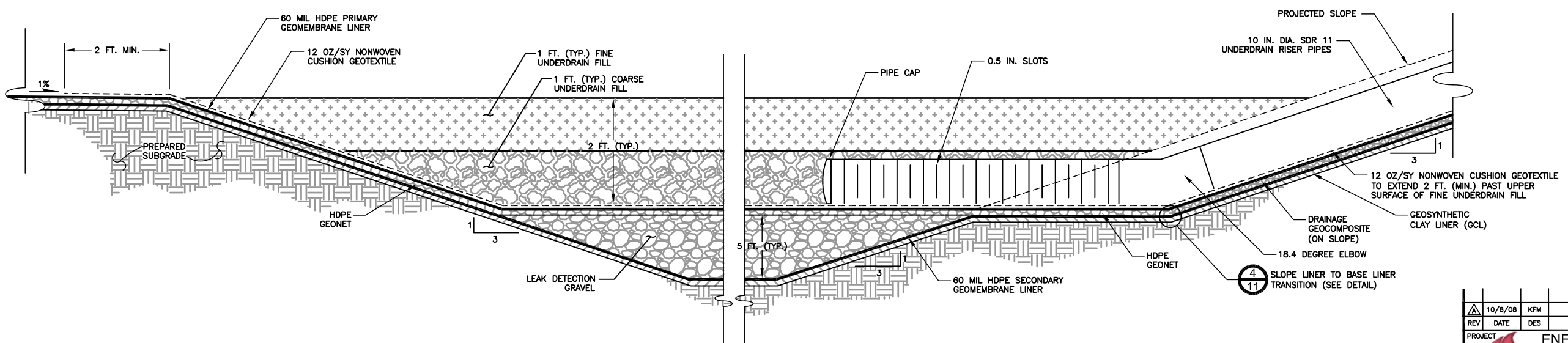

2 UNDERDRAIN SUMP SECTION
N.T.S.

REV	DATE	DES	REVISION DESCRIPTION	JWR	KFM	JMJ
10/8/08	KFM		ISSUED FOR DESIGN REPORT			
				CADD	CHK	RWV
PROJECT ENERGY FUELS RESOURCES CORPORATION PIÑON RIDGE PROJECT - TAILINGS CELL DESIGN MONTROSE COUNTY, COLORADO						
TITLE UNDERDRAIN SECTIONS AND DETAILS						
PROJECT No. 073-81694			FILE No. 07381694A044			
DESIGN	KFM	02/08	SCALE	AS SHOWN	REV.	A
CADD	JDE	02/08	DRAWING		9	
CHECK	KFM	05/08				
REVIEW	JMJ	05/08				



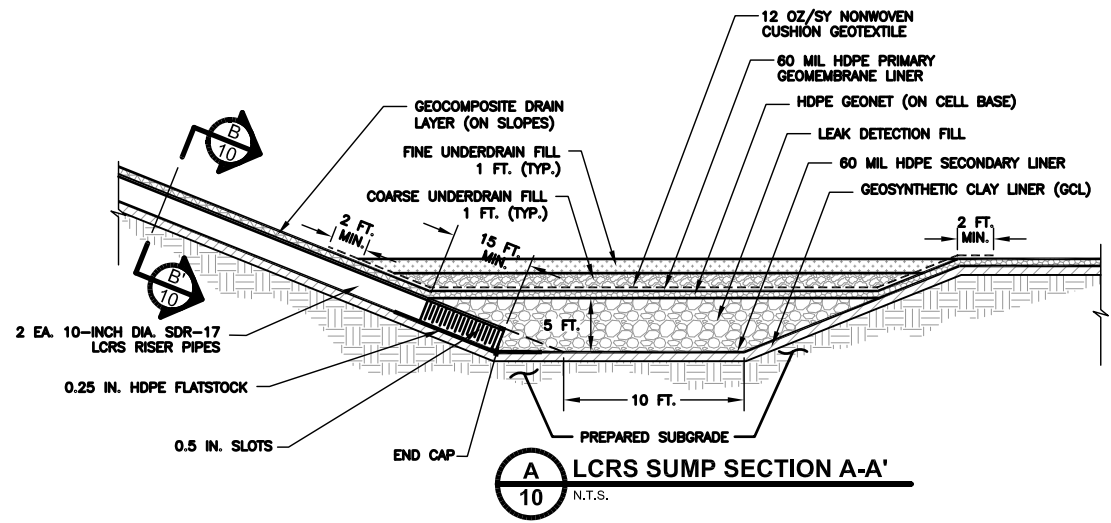

A LCRS SUMP SECTION A-A'
10 N.T.S.

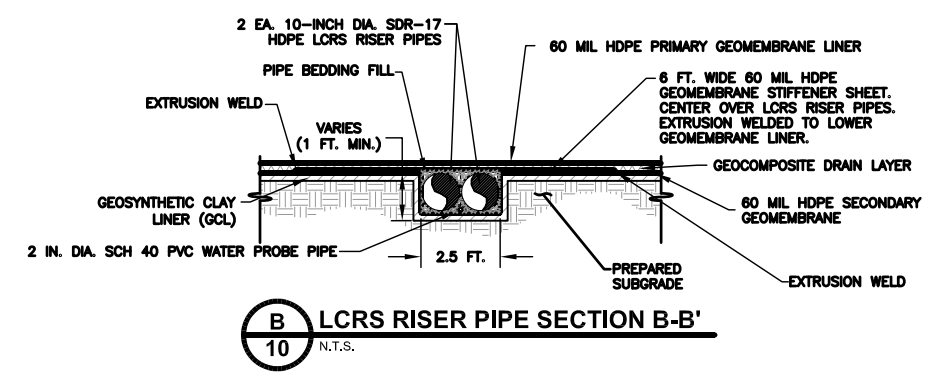

B LCRS RISER PIPE SECTION B-B'
10 N.T.S.

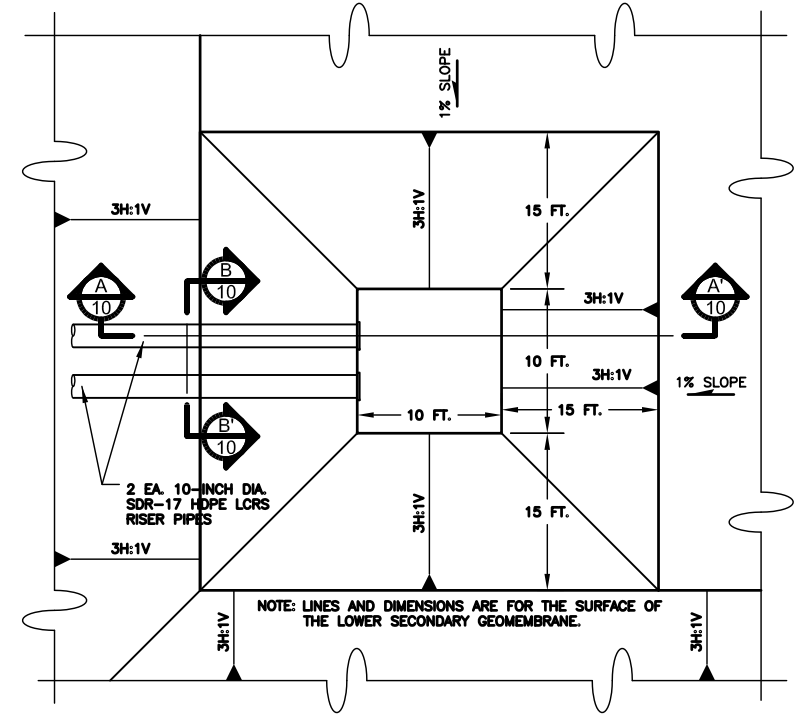

1 LCRS SUMP PLAN
10 N.T.S.

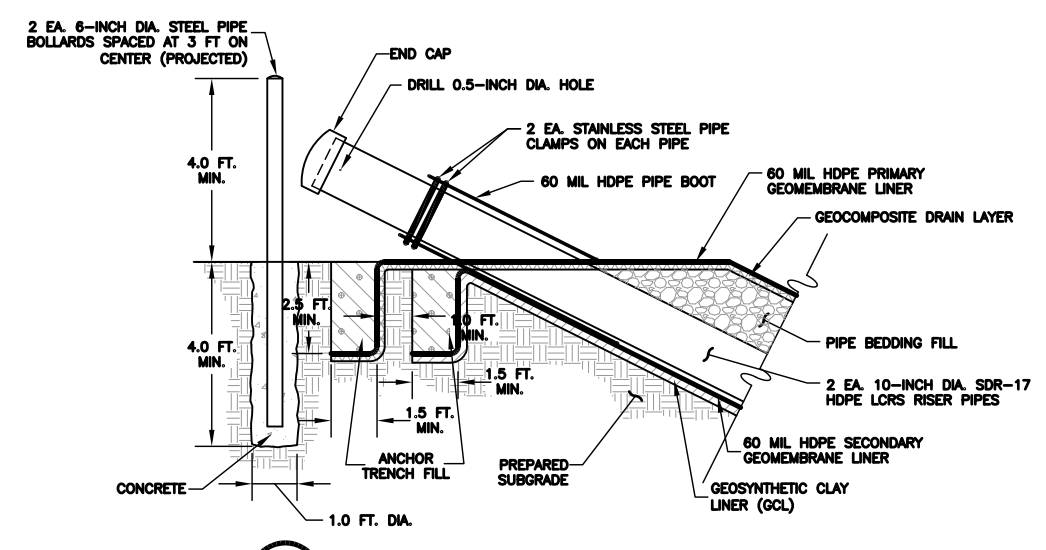

2 LCRS RISER OUTLET DETAIL
10 N.T.S.

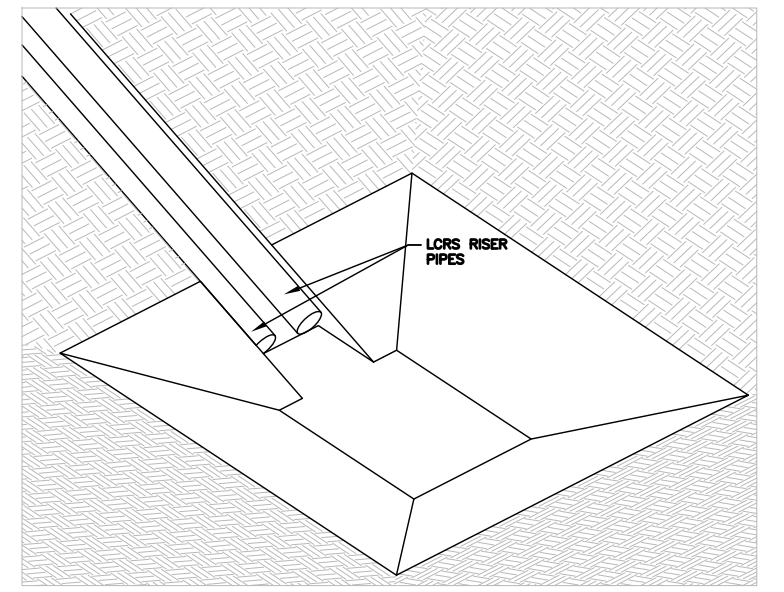

3 LCRS SUMP ISOMETRIC VIEW
10 N.T.S.

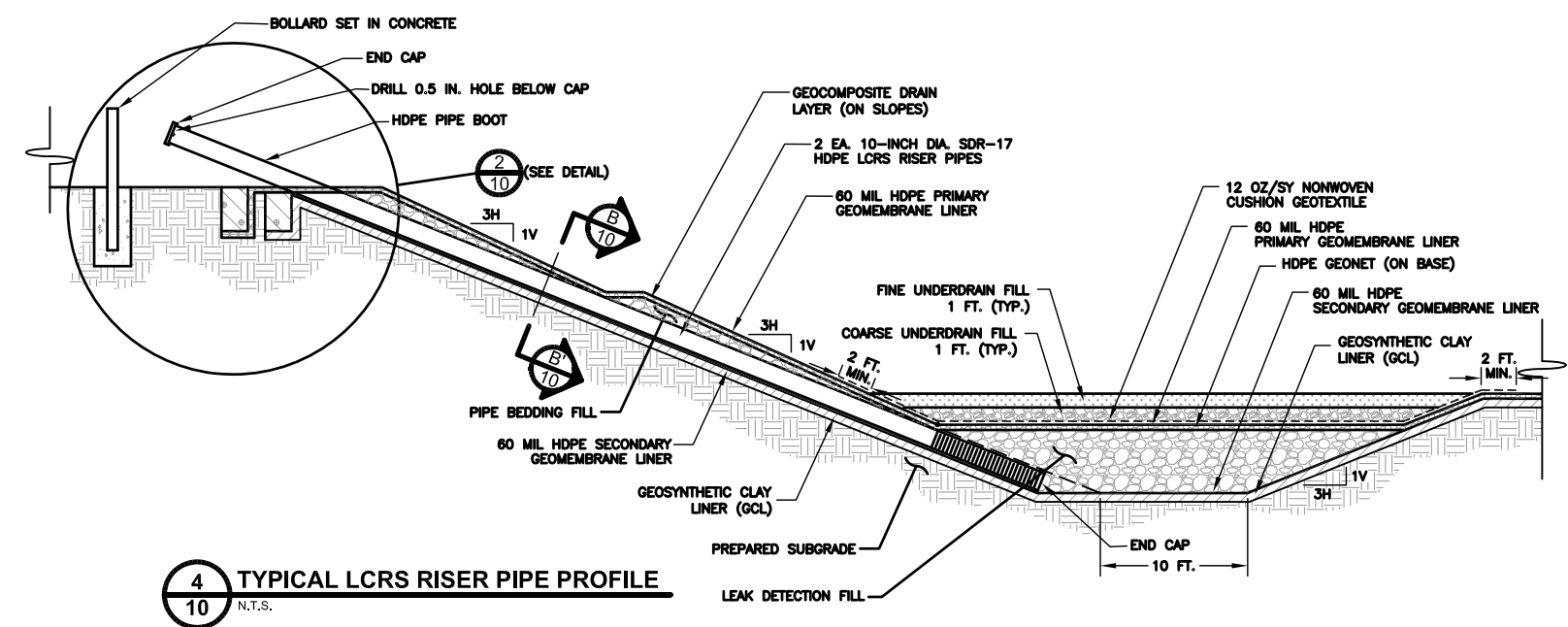

4 TYPICAL LCRS RISER PIPE PROFILE
10 N.T.S.

NOTES

- PUMP FOR LEAK COLLECTION AND RECOVERY SYSTEM TO BE SUPPLIED BY OTHERS. COLLECTED SOLUTIONS TO BE RETURNED TO TAILINGS CELL.

Draw Name: N:\V\073-81894\07381894\041.dwg
 User: jw
 Date: 10/03/08 10:09
 Plot Date: 10/03/08 10:09
 Plotter: HP DesignJet 5000

REV	DATE	DES	ISSUED FOR DESIGN REPORT	JWR	KFM	JMJ
			REVISION DESCRIPTION	CADD	CHK	RWV
PROJECT ENERGY FUELS RESOURCES CORPORATION PIÑON RIDGE PROJECT - TAILINGS CELL DESIGN MONTROSE COUNTY, COLORADO						
TITLE LEAK COLLECTION AND RECOVERY SYSTEM SECTIONS AND DETAILS						
PROJECT No. 073-81894		FILE No. 07381894041				
DESIGN	JDE	02/08	SCALE AS SHOWN	REV.	A	
CADD	JDE	02/08	DRAWING			
CHECK	KFM	05/08	10			
REVIEW	JMJ	05/08				



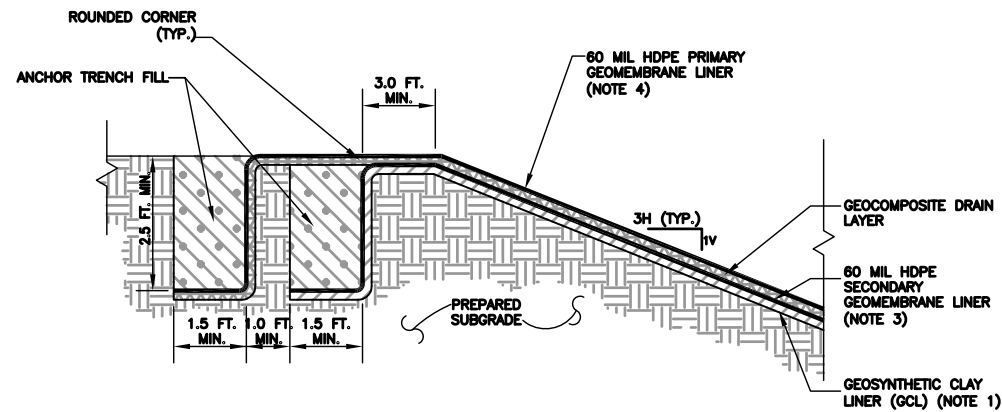

1 TAILINGS CELL LINER ANCHOR TRENCH DETAIL
11 N.T.S.

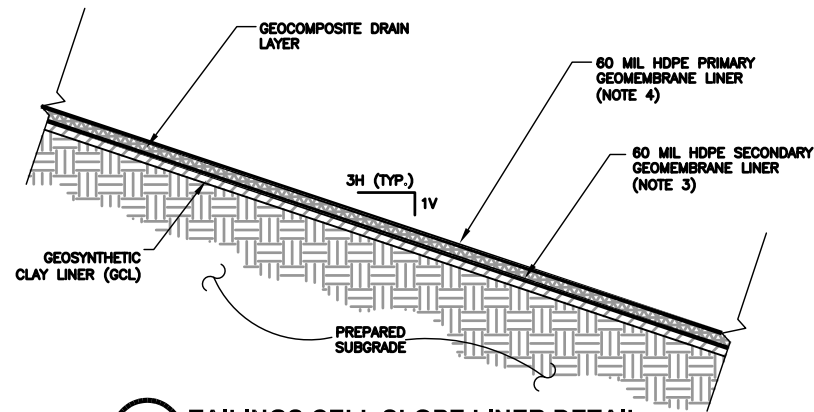

2 TAILINGS CELL SLOPE LINER DETAIL
11 N.T.S.

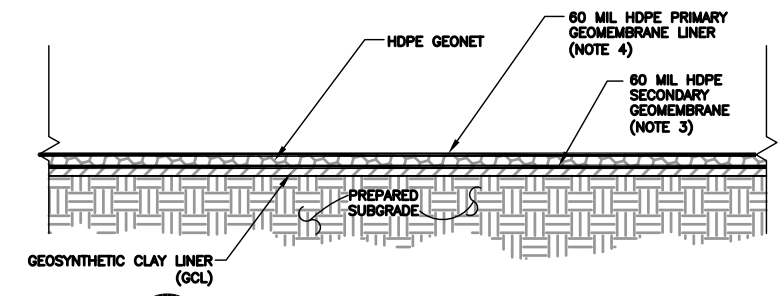

3 TAILINGS CELL BASE LINER DETAIL
11 N.T.S.

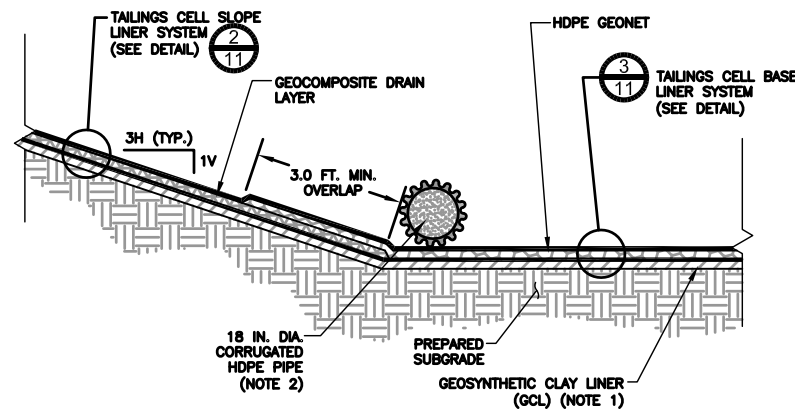

4 SLOPE LINER TO BASE LINER TRANSITION
11 N.T.S.

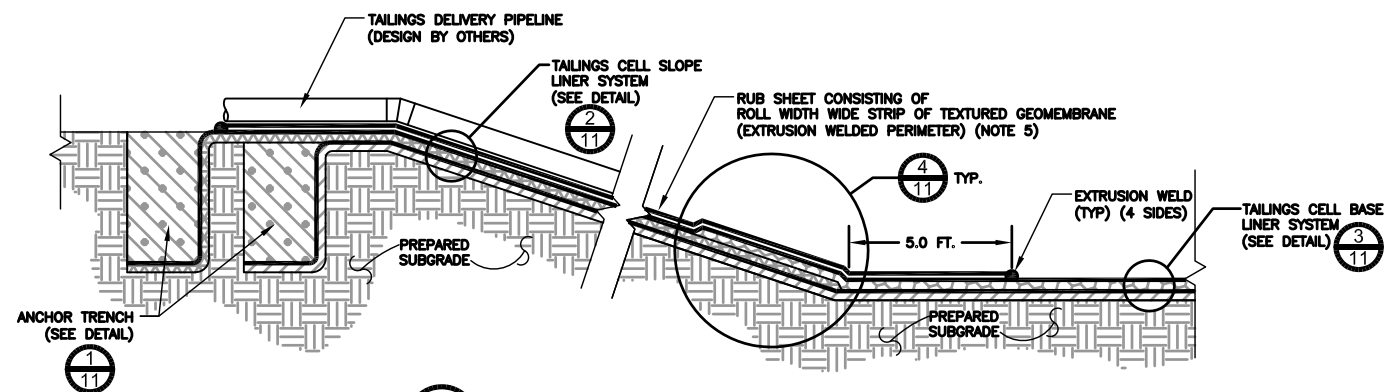

5 RUB SHEET SECTION
11 N.T.S.

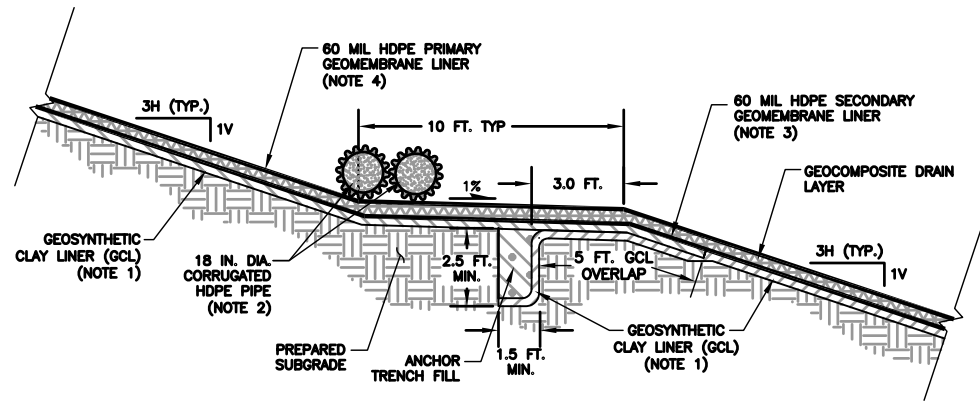

6 TYPICAL TAILINGS CELL BENCH ANCHORAGE DETAIL
11 N.T.S.

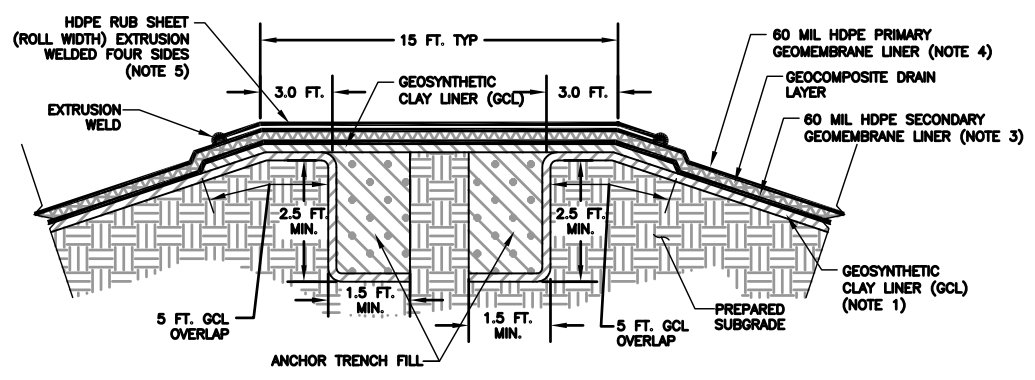

7 DIVIDER BERM DETAIL
11 N.T.S.

- NOTES**
- USE BENTOMAT ST OR APPROVED EQUIVALENT REINFORCED GCL ON SIDE SLOPES AND BASE OF TAILINGS CELLS AS THE UNDERLINER COMPONENT OF THE SECONDARY COMPOSITE LINER, WOVEN SIDE UP.
 - AT THE TOE OF THE TAILINGS CELL SLOPES AND ON THE ANCHOR BENCHES, PLACE CONTINUOUS 18 IN. DIA. CORRUGATED HDPE PIPE BACKFILLED WITH SAND OR GROUT (ANCHORED WITH SAND BAGS) TO PROVIDE BUTTRESSING AGAINST WIND EFFECTS. ON ANCHOR BENCHES, TWO PIPES ARE REQUIRED, STRAPPED TOGETHER.
 - SECONDARY GEOMEMBRANE LINER SHALL CONSIST OF DOUBLE-SIDED TEXTURED HIGH DENSITY POLYETHYLENE (HDPE) GEOMEMBRANE.
 - PRIMARY GEOMEMBRANE LINER SHALL CONSIST OF SINGLE-SIDED TEXTURED HDPE GEOMEMBRANE (TEXTURED SIDE DOWN). PRIMARY GEOMEMBRANE LINER SHALL BE COATED WHITE TO LIMIT EXPANSION AND CONTRACTION OF EXPOSED LINER, AND CONDUCTIVE TO FACILITATE SPARR TESTING AT COMPLETION OF INSTALLATION.
 - RUBSHEET SHALL CONSIST OF DOUBLE-SIDED TEXTURED HDPE GEOMEMBRANE WITH A WHITE UPPER SURFACE.

REV	DATE	DES	REVISION DESCRIPTION	JDE	KFM	JMJ
10/8/08	KFM		ISSUED FOR DESIGN REPORT			
PROJECT	ENERGY FUELS RESOURCES CORPORATION PIÑON RIDGE PROJECT - TAILINGS CELL DESIGN MONTROSE COUNTY, COLORADO			CADD	CHK	RWW
TITLE	TAILINGS FACILITY LINER DETAILS					
PROJECT No.	073-81694	FILE No.	07381694A022			
DESIGN	JDE	02/08	SCALE	AS SHOWN	REV.	A
CADD	JDE	02/08	DRAWING			
CHECK	KFM	05/08				
REVIEW	JMJ	05/08				



APPENDIX A

ALTERNATIVE LINER FLOW COMPARISON

APPENDIX A

ALTERNATIVE LINER FLOW COMPARISON

Analyses were conducted using the method proposed by Giroud et al. (1997) to demonstrate that the secondary composite liner system consisting of a 60 mil high density polyethylene (HDPE) geomembrane overlying a geosynthetic clay liner (GCL) has equivalent or improved fluid migration characteristics when compared to a secondary composite liner system consisting of a 60 mil HDPE geomembrane overlying the prescriptive compacted clay liner (i.e., 3 feet of 10^{-7} cm/sec soil, per 40 CFR 264.221). The liner flow comparison calculation is provided in Appendix A-1.

Compatibility testing was conducted to evaluate the potential for the GCL to increase in permeability when exposed to the synthetic tailings solution chemistry. The results of the compatibility testing are presented in Appendix B. The certified hydraulic conductivity of the proposed GCL material is 5×10^{-9} centimeters per second (cm/sec) when tested with deaired/distilled/deionized water. Testing of a polymer-treated GCL in contact with the synthetic leachate indicated no increase in hydraulic conductivity. However, the standard GCL exhibited an increase in permeability when tested with the synthetic leachate to approximately 1.1×10^{-8} cm/sec.

Based on this site-specific analysis, which accounts for the loading conditions and anticipated head on the secondary liner system, as well as the potential for an increase in the GCL hydraulic conductivity when exposed to the tailings leachate, the amount of flow through the secondary liner system with the prescriptive compacted clay liner was evaluated to be nearly 5 times greater than the flow through the secondary liner system with a standard GCL underliner, and more than 8 times greater than the flow through the secondary liner system with a polymer-treated GCL underliner. Therefore, in terms of limiting fluid flow through the composite secondary liner system, the secondary liner system containing a GCL performs better than the secondary liner system containing the prescriptive clay liner.

REFERENCES

40 CFR Part 264 – “*Standards for Owners and Operators of Hazardous Waste Treatment, Storage, and Disposal Facilities*”, Subpart K (Surface Impoundments).

Giroud, J.P., Badu-Tweneboah, K., and Soderman, K.L. 1997. “Comparison of leachate flow through compacted clay liners and geosynthetic clay liners in landfill liner systems.” *Geosynthetics International*, 4 (3-4), 391-431.

APPENDIX A-1
FLOW COMPARISON CALCULATION



Subject Piñon Ridge Project
Tailings Cell Design
Comparison of Flow through CCL liner and GCL liner

Made by EF/KFM
Checked by <i>KFM</i>
Approved by <i>[Signature]</i>

Job No 073-81694
Date 10/01/08
Sheet No 1 of 4

OBJECTIVE:

Evaluate the use of a geosynthetic clay liner (GCL) as the underliner in the secondary liner system to demonstrate equivalent or better fluid migration resistance when compared to a prescriptive compacted clay liner (CCL) for design of the tailings cells.

GIVEN:

- The tailings cells will be designed with a double composite liner system which meets the requirements of 40 CFR Part 264, Subpart K (EPA).
- Results of GCL compatibility testing with a synthetic tailings leachate (see GCL compatibility testing appendix).

GEOMETRY:

- Base lining system configuration alternatives shown in Figure 1.

MATERIAL PROPERTIES:

Table 1 summarizes the hydraulic conductivity properties for the considered materials in this analysis:

Table 1. Material Hydraulic Properties

Material	Hydraulic Conductivity / *Transmissivity		Thickness (in)	Notes
	(cm/sec) / *(m ² /sec)	(ft/sec) / *(gal/min/ft)		
CCL	1x10 ⁻⁷	3.28x10 ⁻⁹	36	Prescriptive liner 40 CFR §264.221
GCL ^{1,2}	(a) 5x10 ⁻⁹ (b) 3x10 ⁻⁹ (c) 1.1x10 ⁻⁸	(a) 1.6x10 ⁻¹⁰ (b) 9.8x10 ⁻¹¹ (c) 3.6x10 ⁻¹⁰	0.4	i.e., CETCO Bentomat ST, or equivalent
Geonet ¹	*6x10 ⁻³	*29	0.28	i.e., HyperNet HS geonet manufactured by GSE or equivalent

¹ See Attachment 2.

² Range of GCL hydraulic conductivity values obtained from: (a) published values as tested with water; (b) polymer-treated GCL tested with synthetic leachate; and (c) standard GCL tested with synthetic leachate.

ASSUMPTIONS:

- A good contact exists between the secondary geomembrane and the underliner in the secondary composite liner system;
- According to the EPA, common practice is to assume a circular defect with a diameter equal to the thickness of the geomembrane (Giroud and Bonaparte 1989). Accordingly, these calculations assume circular defects with a diameter of 60 mil (0.005 ft, or 0.06 inches);
- A frequency of 1 defect per acre is assumed, which reflects good to excellent installation quality of the geomembrane installation (Giroud and Bonaparte 1989);
- The flow is assumed to be steady state;
- The flow in the leakage collection layer is laminar;



Subject Piñon Ridge Project
Tailings Cell Design
Comparison of Flow through CCL liner and GCL liner

Made by EF/KFM
Checked by <i>KFM</i>
Approved by <i>[Signature]</i>

Job No 073-81694
Date 10/01/08
Sheet No 2 of 4

- It is assumed that flows through various defects do not interfere with each other; and
- The maximum height of liquid above the primary geomembrane is conservatively assumed to be equal to the ultimate height of the tailings in the cells (e.g. 76 ft).

METHOD:

In this analysis the method proposed by Giroud et al. (1997a) is used to compare the leachate flow through a GCL to the prescriptive CCL liner. The comparison between the GCL alternative liner and a CCL prescribed liner is performed by calculating the ratio between the rates of leachate flow through these composite liner systems. The following equation can be used to calculate the advective flow rate ratios.

$$\frac{q_{comp\ CCL}}{q_{comp\ GCL}} = qratio = \left(\frac{k_{CCL}}{k_{GCL}}\right)^{0.74} \frac{1 + 0.1\left(\frac{h}{t_{CCL}}\right)^{0.95}}{1 + 0.1\left(\frac{h}{t_{GCL}}\right)^{0.95}}$$

where:

- $q_{comp\ CCL}$ = unit rate of flow through a composite liner where the soil component is a CCL;
- $q_{comp\ GCL}$ = unit rate of flow through a composite liner where the soil component is a GCL;
- k_{CCL} = hydraulic conductivity of the CCL;
- k_{GCL} = hydraulic conductivity of the GCL;
- t_{CCL} = thickness of the CCL in the composite liner;
- t_{GCL} = thickness of the GCL in the composite liner; and
- h = maximum head of liquid above the geomembrane.

The maximum liquid head on the secondary geomembrane (h) is calculated by assuming that a pinhole in the primary geomembrane exists to allow liquids to flow through and reach the leak collection and recovery system and create a potential head on the secondary geomembrane. According to Giroud et al. (1997b) the flow rate through a geomembrane defect is given by the following equation:

$$Q = \frac{2}{3} d^2 \sqrt{g h_{prim}}$$

where:

- Q = flow rate through one geomembrane defect;
- d = defect diameter;
- g = acceleration due to gravity; and
- h_{prim} = head of liquid on top of primary liner.

The head of liquid above the secondary lower geomembrane in the double composite liner system is calculated by the method proposed by (Giroud et al. 1997b):

$$t_o = \sqrt{\frac{Q}{k}} \quad \text{for the case where the leakage collection layer is not full.}$$

where:

- t_o = thickness of leachate in the leakage collection layer;



Subject	Piñon Ridge Project
	Tailings Cell Design
	Comparison of Flow through CCL liner and GCL liner

Made by	EF/KFM
Checked by	<i>KFM</i>
Approved by	<i>JMJ</i>

Job No	073-81694
Date	10/01/08
Sheet No	3 of 4

Q = steady-state rate of leachate flow in the leakage collection layer, which results from a defect in the primary geomembrane liner; and
 k = hydraulic conductivity of the leakage collection layer material.

The calculated head of liquid above the secondary lower geomembrane (t_o) represent the maximum head of liquid above the geomembrane (h), which allows us to calculate the advective flow rate ratio.

The geonet for the leak collection and recovery system layer was selected to drain the maximum flow rate through a defect in the primary upper geomembrane liner.

CALCULATIONS:

Calculations are provided in Attachment 1.

RESULTS:

Table 2 summarizes the results obtained from the calculations provided in Attachment 1.

Table 2. Calculation Results

Parameter	Value	Notes
Q	8.4×10^{-4} ft ³ /sec	Maximum flow rate through a defect in the primary upper geomembrane liner.
k	2.8 ft/sec	Minimum required geonet hydraulic conductivity.
Q _{full}	1.5×10^{-3} ft ³ /sec	Maximum flow in the minimum leak collection and recovery system layer.
t_o	0.017 ft (0.20 in, 5.2 mm)	Liquid build-up on the secondary geomembrane.
$q_{comp\ CCL} / q_{comp\ GCL}$	Ranges from 4.9 to 12.8, depending on GCL used.	Ratio between the rates of leachate flow.

CONCLUSIONS:

According to the calculations, the amount of liquid head over the secondary geomembrane is 0.20 inches (i.e., 0.017 ft) due to a circular defect in the primary geomembrane with a diameter equal to 0.005 ft. For this liquid head, the flow through the secondary liner system with a standard GCL underliner exposed to the tailings leachate was evaluated to be nearly 5 times less than the flow rate through a secondary liner system with a CCL underliner. If a polymer-treated GCL is used instead, the flow through the secondary liner system may be reduced up to nearly 13 times less than a secondary liner system with a CCL underliner. Conservatively, however, the polymer-treated GCL was assumed to result in no change in permeability from the manufacturer-specified permeability, and therefore the flow is more than 8 times less than the flow through a secondary liner system with a CCL underliner.

In conclusion, a double composite liner system comprised of a geomembrane/geonet/geomembrane/GCL (option B) performs better than a double composite liner system comprised of a geomembrane/geonet/geomembrane/CCL (option A) for the assumed conditions.



Subject Piñon Ridge Project
Tailings Cell Design
Comparison of Flow through CCL liner and GCL liner

Made by EF/KFM
Checked by
Approved by

Job No 073-81694
Date 10/01/08
Sheet No 4 of 4

In order to prevent liquid build-up above the secondary geomembrane that could fill the leak collection and recovery system layer, the properties for the geonet should be equal to or greater than those assumed in these calculations (see Table 1).

REFERENCES:

Environmental Protection Agency (EPA), 40 CFR Part 264 - "Standards for Owners and Operators of Hazardous Waste Treatment, storage, and Disposal Facilities", Subpart K (Surface Impoundments).

Giroud, J. P., Badu-Tweneboah, K., and Soderman, K. L. (1997a). "Comparison of leachate flow through compacted clay liners and geosynthetic clay liners in landfill liner systems." *Geosynthetics International*, 4(3-4), 391-431.

Giroud, J. P., and Bonaparte, R. (1989). "Leakage through liners constructed with geomembranes-Part I geomembranes liners." *Geotextiles and Geomembranes*, 8, 27-67.

Giroud, J. P., Gross, B. A., Bonaparte, R., and McKelvey, J. A. (1997b). "Leachate flow in leakage collection layers due to defects in geomembrane liners." *Geosynthetics International*, 4(3-4), 215-292.

FIGURES

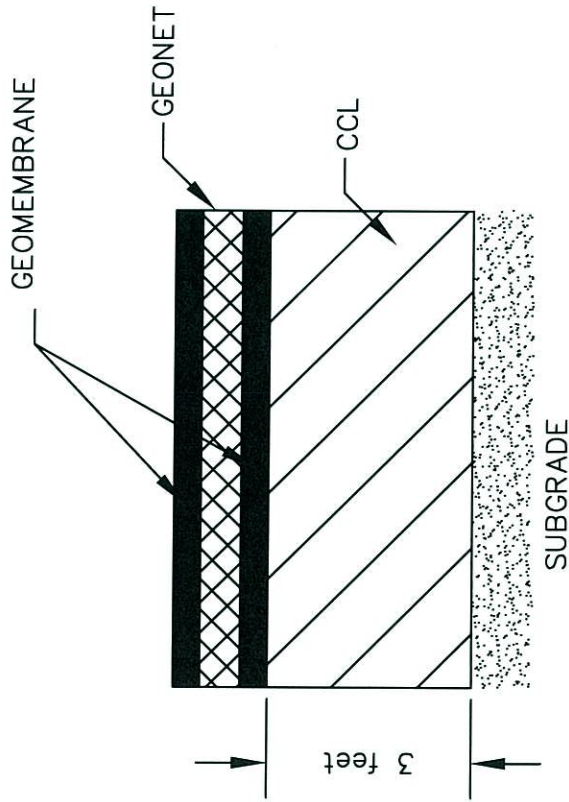

OPTION A

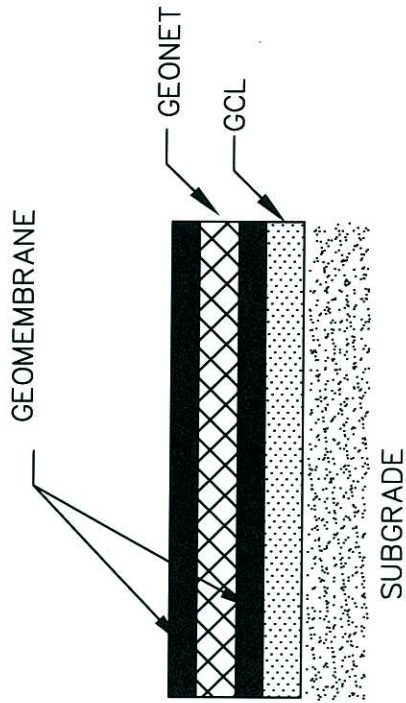

OPTION B

TITLE

LINER SYSTEM CONFIGURATION ALTERNATIVES

DRAWN	EF	DATE	FEBRUARY 15, 2008	JOB NO.	073-81694
CHECKED	<i>KAM</i>	SCALE	N.T.S.	DWG. NO.	
REVIEWED	<i>KAM</i>	FILE NO.	Figures CCL-GCL.dwg	FIGURE NO.	1



CLIENT/PROJECT
 ENERGY FUELS RESOURCES CORPORATION
 PIÑON RIDGE PROJECT - TAILINGS CELL DESIGN
 MONTROSE COUNTY, COLORADO

ATTACHMENT 1
LINER COMPARISON CALCULATIONS



Made by: EF/KFM
 Checked by: *KFM*
 Approved by: *JW*

Subject: Piñon Ridge
 Job No.: 073-81694.0003
 Date: 9/29/2008
 Sheet No. 1 of 3

COMPARISON OF FLOW THROUGH CCL AND GCL LINER CALCULATIONS

The ratio between the rates of leachate flow through a composite liner with compacted clay (CCL) underliner and a composite liner with a geosynthetic clay (GCL) underliner is given by (Giroud et al. 1997a):

$$Q_{\text{ratio}} = \left(\frac{k_{\text{CCL}}}{k_{\text{GCL}}} \right)^{0.74} \cdot \frac{\left[1 + 0.1 \cdot \left(\frac{h}{t_{\text{CCL}}} \right)^{0.95} \right]}{\left[1 + 0.1 \cdot \left(\frac{h}{t_{\text{GCL}}} \right)^{0.95} \right]}$$

In order to solve the above equation, the maximum height of liquids above the secondary geomembrane liner must be evaluated. The maximum head on the secondary liner is derived by assuming that a defect in the primary geomembrane liner exists to allow liquids to flow through the primary geomembrane to the leak detection system. The flow rate through the geomembrane defect is calculated by conservatively assuming a maximum height of liquid above the primary geomembrane to be equal to the ultimate height of the tailings in the cells (e.g. 76 ft).

The flow rate through a defect in the geomembrane is given by the following equation (Giroud et al. 1997b):

$d := 0.005 \text{ ft}$ defect diameter

$h_{\text{prim}} := 78 \text{ ft}$ total liquid head over primary geomembrane

$g := 32.2 \text{ ft / sec}^2$ gravity

$$Q := \frac{2}{3} d^2 \cdot \sqrt{g \cdot h_{\text{prim}}}$$

where the maximum flow rate through the primary liner geomembrane is:

$$Q = 8.35 \times 10^{-4} \text{ ft}^3 / \text{sec}$$

The permeability of the geonet can be defined by:

$t_{\text{LCL}} := 0.023 \text{ ft}$ thickness of the geonet

$\theta := 0.0646 \text{ ft}^2 / \text{sec}$ geonet transmissivity

$$k := \frac{\theta}{t_{\text{LCL}}} \text{ geonet hydraulic conductivity}$$

$k = 2.81 \text{ ft / sec}$



Made by: EF/KFM
Checked by: *KFM*
Approved by: *JWJ*

Subject: Piñon Ridge
Job No.: 073-81694.0003
Date: 9/29/2008
Sheet No. 2 of 3

The maximum steady-state rate of leachate migration through a defect in the primary liner that a leakage collection layer can accommodate without being filled with leachate (Giroud et al. 1997b):

$$Q_{full} := k \cdot t_{LCL}^2$$

$$Q_{full} = 1.49 \times 10^{-3} \quad \text{ft}^3/\text{sec}$$

The liquid head build-up on the secondary geomembrane liner can be calculated by using the following equation (Giroud et al. 1997b):

$$t_o := \sqrt{\frac{Q}{k}}$$

$$t_o = 0.017 \quad \text{ft}$$

Since the flow rate through a defect in the geomembrane (Q) is lower than the maximum flow rate that the leakage collection layer can accommodate (Q_{full}), and the estimated liquid head build-up (t_o) is less than the thickness of the geonet (t_{LCL}), the use of the Hyper Net HS Geonet is validated.

The ratio between the rates of leachate flow through a composite liner with CCL underliner and a composite liner with a GCL underliner is:

$$k_{CCL} := 3.28 \times 10^{-9} \quad \text{ft/sec}$$

(a) Published GCL Value: $k_{GCL} := 1.64 \cdot 10^{-10} \quad \text{ft/sec}$

$$t_{CCL} := 3 \quad \text{ft}$$

$$t_{GCL} := 0.033 \quad \text{ft}$$

$$h := t_o$$

$$h = 0.017 \quad \text{ft}$$

$$q_{ratio} := \left(\frac{k_{CCL}}{k_{GCL}} \right)^{0.74} \cdot \frac{\left[1 + 0.1 \cdot \left(\frac{h}{t_{CCL}} \right)^{0.95} \right]}{\left[1 + 0.1 \cdot \left(\frac{h}{t_{GCL}} \right)^{0.95} \right]}$$

$$q_{ratio} = 8.71$$



Made by: EF/KFM
Checked by: *KFM*
Approved by: *JWJ*

Subject: Piñon Ridge
Job No.: 073-81694.0003
Date: 9/29/2008
Sheet No. 3 of 3

(b) Polymer-treated GCL: $k_{GCL} := 9.8 \cdot 10^{-11}$ ft / sec

$$q_{ratio} := \left(\frac{k_{CCL}}{k_{GCL}} \right)^{0.74} \cdot \frac{\left[1 + 0.1 \cdot \left(\frac{h}{t_{CCL}} \right)^{0.95} \right]}{\left[1 + 0.1 \cdot \left(\frac{h}{t_{GCL}} \right)^{0.95} \right]}$$

$$q_{ratio} = 12.76$$

(c) Standard GCL: $k_{GCL} := 3.6 \cdot 10^{-10}$ ft / sec

$$q_{ratio} := \left(\frac{k_{CCL}}{k_{GCL}} \right)^{0.74} \cdot \frac{\left[1 + 0.1 \cdot \left(\frac{h}{t_{CCL}} \right)^{0.95} \right]}{\left[1 + 0.1 \cdot \left(\frac{h}{t_{GCL}} \right)^{0.95} \right]}$$

$$q_{ratio} = 4.87$$

References

- Giroud, J. P. (1997). "Equations for calculating the rate of liquid migration through composite liners due to geomembrane defects." *Geosynthetics international*, 4(3-4), 335-348.
- Giroud, J. P., Badu-Tweneboah, K., and Soderman, K. L. (1997a). "Comparison of leachate flow through compacted clay liners and geosynthetic clay liners in landfill liner systems." *Geosynthetics International*, 4(3-4), 391-431.
- Giroud, J. P., Gross, B. A., Bonaparte, R., and McKelvey, J. A. (1997b). "Leachate flow in leakage collection layers due to defects in geomembrane liners." *Geosynthetics International*, 4(3-4), 215-292.

ATTACHMENT 2
PRODUCT DATA SHEETS



GSE STANDARD PRODUCTS

Product Data Sheet

GSE HyperNet Geonets

GSE HyperNet geonets are synthetic drainage materials manufactured from a premium grade high density polyethylene (HDPE) resin. The structure of the HyperNet geonet is formed specifically to transmit fluids uniformly under a variety of field conditions. HDPE resins are inert to chemicals encountered in most of the civil and environmental applications where these materials are used. GSE geonets are formulated to be resistant to ultraviolet light for time periods necessary to complete installation. GSE HyperNet geonets are available in standard, HF, HS, and UF varieties.

The table below provides index physical, mechanical and hydraulic characteristics of GSE geonets. Contact GSE for information regarding performance of these products under site-specific load, gradient, and boundary conditions.

Product Specifications

TESTED PROPERTY	TEST METHOD	FREQUENCY	MINIMUM AVERAGE ROLL VALUE ^(c)			
			HyperNet	HyperNet HF	HyperNet HS	HyperNet UF
Product Code			XL4000N004	XL5000N004	XL7000N004	XL8000N004
Transmissivity ^(a) , gal/min/ft (m ² /sec)	ASTM D 4716-00	1/540,000 ft ²	9.66 (2 x 10 ⁻³)	14.49 (3 x 10 ⁻³)	28.98 (6 x 10 ⁻³)	38.64 (8 x 10 ⁻³)
Thickness, mil (mm)	ASTM D 5199	1/50,000 ft ²	200 (5)	250 (6.3)	275 (7)	300 (7.6)
Density, g/cm ³	ASTM D 1505	1/50,000 ft ²	0.94	0.94	0.94	0.94
Tensile Strength (MD), lb/in (N/mm)	ASTM D 5035	1/50,000 ft ²	45 (7.9)	55 (9.6)	65 (11.5)	75 (13.3)
Carbon Black Content, %	ASTM D 1603, modified	1/50,000 ft ²	2.0	2.0	2.0	2.0
Roll Width, ft (m)			15 (4.6)	15 (4.6)	15 (4.6)	15 (4.6)
Roll Length, ft (m) ^(b)			300 (91)	250 (76)	220 (67)	200 (60)
Roll Area, ft ² (m ²)			4,500 (418)	3,750 (348)	3,300 (305)	3,000 (278)

NOTES:

- ^(a)Gradient of 0.1, normal load of 10,000 psf, water at 70° F (20° C), between steel plates for 15 minutes.
- ^(b)Please check with GSE for other available roll lengths.
- ^(c)These are MARV values that are based on the cumulative results of specimens tested by GSE.

DS017 R07/07/03

This information is provided for reference purposes only and is not intended as a warranty or guarantee. GSE assumes no liability in connection with the use of this information. Please check with GSE for current, standard minimum quality assurance procedures and specifications.

GSE and other marks used in this document are trademarks and service marks of GSE Lining Technology, Inc; certain of which are registered in the U.S.A. and other countries.

Americas	GSE Lining Technology, Inc.	Houston, Texas	800-435-2008	281-443-8564	Fax: 281-230-8650
Europe/Middle East/Africa	GSE Lining Technology GmbH	Hamburg, Germany		49-40-767420	Fax: 49-40-7674233
Asia/Pacific	GSE Lining Technology Company Ltd.	Bangkok, Thailand		66-2-937-0091	Fax: 66-2-937-0097

This product data sheet is also available on our website at:

www.gseworld.com



Certified Properties

BENTOMAT® ST CERTIFIED PROPERTIES

MATERIAL PROPERTY	TEST METHOD	TEST FREQUENCY ft ² (m ²)	REQUIRED VALUES
Bentonite Swell Index ¹	ASTM D 5890	1 per 50 tonnes	24 ml/2g min.
Bentonite Fluid Loss ¹	ASTM D 5891	1 per 50 tonnes	18 ml max.
Bentonite Mass/Area ²	ASTM D 5993	40,000 ft ² (4,000 m ²)	0.75 lb/ft ² (3.6 kg/m ²) min
GCL Grab Strength ³	ASTM D 4632 ASTM D 6768	200,000 ft ² (20,000 m ²)	90 lbs (400 N) MARV 22.5 lbs/in (40 N/cm) MARV
GCL Peel Strength ³	ASTM D 4632 ASTM D 6496	40,000 ft ² (4,000 m ²)	15 lbs (65 N) min 2.5 lbs/in (4.4 N/cm) min
GCL Index Flux ⁴	ASTM D 5887	Weekly	1 x 10 ⁻⁸ m ³ /m ² /sec max
GCL Hydraulic Conductivity ⁴	ASTM D 5887	Weekly	5 x 10 ⁻⁹ cm/sec max
GCL Hydrated Internal Shear Strength ⁵	ASTM D 5321 ASTM D 6243	Periodic	500 psf (24 kPa) typ @ 200 psf

Bentomat ST is a reinforced GCL consisting of a layer of sodium bentonite between a woven and a nonwoven geotextiles, which are needlepunched together.

Notes

¹ Bentonite property tests performed at a bentonite processing facility before shipment to CETCO's GCL production facilities.

² Bentonite mass/area reported at 0 percent moisture content.

³ All tensile strength and peel strength testing is performed in the machine direction using 4 inch grips per modified ASTM D 4632. Results are reported as minimum average roll values unless otherwise indicated. Upon request, tensile strength can be reported per ASTM D 6768 and peel strength can be reported per ASTM D 6496.

⁴ Index flux and permeability testing with deaired distilled/deionized water at 80 psi (551kPa) cell pressure, 77 psi (531 kPa) headwater pressure and 75 psi (517 kPa) tailwater pressure. Reported value is equivalent to 925 gal/acre/day. This flux value is equivalent to a permeability of 5x10⁻⁹ cm/sec for typical GCL thickness. Actual flux values vary with field condition pressures. The last 20 weekly values prior the end of the production date of the supplied GCL may be provided.

⁵ Peak values measured at 200 psf (10 kPa) normal stress for a specimen hydrated for 48 hours. Site-specific materials, GCL products, and test conditions must be used to verify internal and interface strength of the proposed design.

CETCO has developed an edge enhancement system that eliminates the need to use additional granular sodium bentonite within the overlap area of the seams. We call this edge enhancement, SuperGroove™, and it comes standard on both longitudinal edges of Bentomat® ST. It should be noted that SuperGroove™ does not appear on the end-of-roll overlaps and recommend the continued use of supplemental bentonite for all end-of-roll seams.



1500 W. Shure Drive Arlington Heights, IL 60004 USA 800.527.9948 Fax 847.577.5571

For the most up-to-date information please visit our website, www.cetco.com

A wholly owned subsidiary of AMCOL International

The information and date contained herein are believed to be accurate and reliable. CETCO makes no warranty of any kind and accepts no responsibility for the results obtained through application of this information.

Revised 05/06
TR 401-BMST

APPENDIX B
GCL COMPATIBILITY TESTING

APPENDIX B

GCL COMPATIBILITY TESTING

This appendix presents the results of leachate compatibility testing on the geosynthetic clay liner (GCL) proposed for use at the Piñon Ridge Project in Montrose County, Colorado. Bentomat ST, manufactured by CETCO Lining Technologies (CETCO), is the GCL proposed for construction as the underliner component of the secondary composite liner system for the tailings cells and evaporation ponds. Compatibility testing was conducted by TRI/Environmental, Inc. (TRI) under contract to CETCO.

MATERIALS

Two samples of GCL were tested for compatibility with synthetic acidic leachates:

- Bentomat ST (Roll No. 82) – polymer-treated bentonite, using preliminary leachate chemistry
- Bentomat ST (Roll No. 1979) – standard sodium bentonite, using updated leachate chemistry

The synthetic leachates were composed of the reagents summarized in Table B-1. These reagent concentrations were provided by CH2M Hill (the process designers) in January 2008 (Preliminary; CH2M Hill, 2008a) and March 2008 (Updated; CH2M Hill, 2008b) for the tailings cell solution.

TABLE B-1
TESTED SYNTHETIC LEACHATE COMPOSITIONS

Reagent	Preliminary Tailings Leachate Chemistry (CH2M Hill, 2008a) (g/L)	Updated Tailings Leachate Chemistry (CH2M Hill, 2008b) (g/L)
H ₂ SO ₄	1.479	0.084
FeSO ₄	0.182	0.014
Fe ₂ (SO ₄) ₃	13.870	35.989
(NH ₄) ₂ SO ₄	18.575	34.9
Na ₂ SO ₄	2.538	3.917

The preliminary synthetic leachate solution was reported to have an initial pH of 1.9 and an electrical conductivity of 30.4 mS. The updated synthetic leachate solution was reported to have an initial pH of 1.3 and an electrical conductivity of 73.7 mS.

TESTING PROGRAM

GCL compatibility testing followed the procedure outlined in ASTM D 6766, Scenario 2 (modified). Both GCL samples were moistened with tap water to reach an initial moisture content of about 70 percent, and then hydrated with the low-pH synthetic leachate for 48 hours under an effective stress of 5 pounds per square inch (psi). After hydration, the samples were permeated with their respective synthetic leachates at the 5 psi confining pressure.

The GCL samples were subjected to increasing confining pressures. The specimen was allowed to consolidate overnight with each increase in effective stress. The final confining pressure of 60 psi for the test samples is equivalent to approximately 85 feet of tailings at an assumed density of 100 pounds per cubic foot (pcf).

RESULTS

The certified hydraulic conductivity for Bentomat ST is 5×10^{-9} cm/sec, per the manufacturer data sheet (see Appendix A). This permeability value is obtained for a GCL of standard thickness (i.e. 0.4 inches) using standard bentonite tested with deaired/distilled/deionized water at 80 psi cell pressure.

The results of the GCL permeability tests are presented in Appendices B-1 and B-2 for the polymer-treated and standard samples, respectively. Graphs of the permeability versus time and permeability versus pore volume are presented in Appendix B-1 for the polymer-treated GCL testing. Graphs of the permeability versus time, permeability versus pore volume, and permeability versus effective stress are presented in Appendix B-2 for the standard GCL testing.

At the end of each test, the measured permeability of the standard and polymer-treated GCL samples were 1.1×10^{-8} and 3×10^{-9} cm/sec, respectively. These results represent an increase in the reported hydraulic conductivity by nearly half an order of magnitude for the standard sample, and virtually no change in hydraulic conductivity for the polymer-treated sample.

Although there is an increase in hydraulic conductivity measured for the standard bentonite GCL in response to the leachate, test results show that use of Bentomat ST GCL exceeds the permeability requirements for the prescriptive underliner (i.e. 3 feet of 10^{-7} cm/sec clay, refer to Appendix A). Consequently, polymer-treatment of the bentonite in the GCL is not required.

REFERENCES

American Society for Testing and Materials (ASTM). ASTM D 6766. “*Standard Test Method for Evaluation of Hydraulic Properties of GCLs Permeated with Potentially Incompatible Fluids.*”

CH2M Hill. 2008a. “Piñon Ridge Project, Tailings Stream Analysis.” Memo issued by Mike Blois. 27 January 2008.

CH2M Hill. 2008b. “Piñon Ridge Project, Tailings Stream Analysis (Rev. 2).” Memo issued by Brett Berg. 12 March 2008.

APPENDIX B-1

COMPATIBILITY TEST REPORT
POLYMER-TREATED GCL



September 11, 2008

Chris Athanassopoulos, P.E.
CETCO
1500 West Shure Drive - 5th floor
Arlington Heights, Illinois 60004
(847) 818-7945 (office)
(847) 323-8750 (cell)
chris.athanassopoulos@amcol.com

Subject: Results for permeability of the Bentomat ST GCL for the Pinon Ridge Uranium Mill Tailings Pond, (TRI Log #: E2308-20-10)

Dear Mr. Athanassopoulos,

The intent of letter is to provide you with the results for the compatibility of the Bentomat ST GCL with a synthetic acidic leachate in support of the Pinon Ridge Uranium Mill Tailings Pond. A representative specimen of the Bentomat ST GCL from roll number 82 was selected for permeability testing per ASTM D 6766, Scenario 2 modified. The specimen was hydrated with tap water to achieve an initial moisture content of 70%. The specimen was mounted in the triaxial cell and allowed to hydrate with the synthetic leachate for a minimum 48 hours under an effective stress of 5 psi. The cell pressure was 80 psi, the head water pressure was 77 psi and the tail water pressure was 75 psi.

The synthetic leachate was composed of the reagents listed in Table 1. The reagents were mixed with deionized water and allowed to rest for 48 hours prior to being used in the permeability testing. The initial pH of the synthetic leachate was measured and recorded as 1.9 and the electrical conductivity was 30.4 mS. The pH and electrical conductivity of the effluent after 2160 hours of testing was 2.7 and 17.4 mS.

Table 1 Synthetic Leachate Composition

Reagent	Concentration (g/L)
H ₂ SO ₄	1.479
FeSO ₄	0.182
Fe ₂ (SO ₄) ₃	13.870
(NH ₄) ₂ SO ₄	18.575
Na ₂ SO ₄	2.538



Permeability with time and cumulative pore volumes of fluid have been plotted in the attached tables. If you have any questions regarding this testing or the results please feel free to contact me.

Sincerely,

A handwritten signature in black ink, appearing to read 'John M. Allen'. The signature is fluid and cursive, with the first name 'John' being particularly prominent.

John M. Allen, E.I.T.
Director of the Geosynthetics Interaction Laboratory
TRI/Environmental, Inc.

Attachments (1)

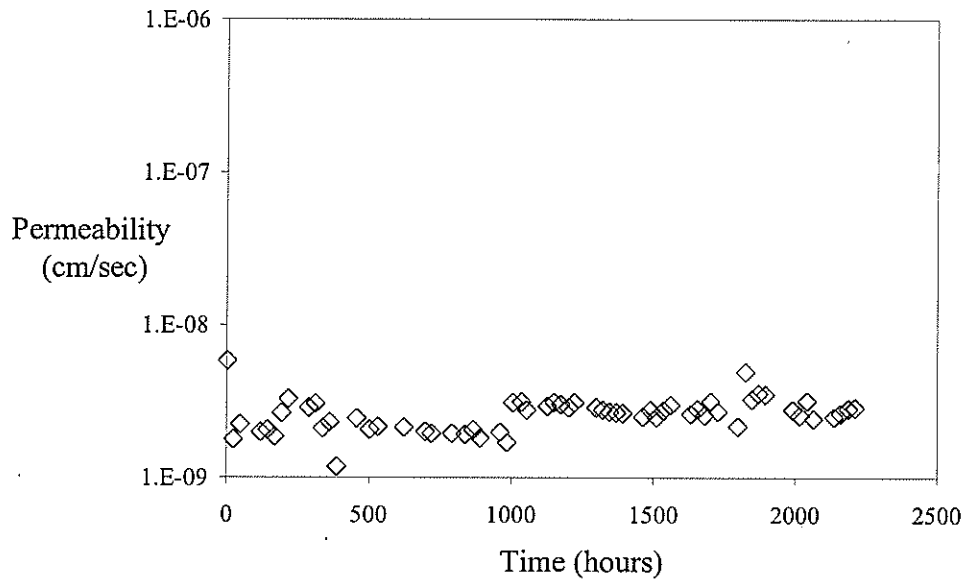

Figure 1 Permeability with time for Bentomat ST GCL (Roll 82) Note: GCL specimen was hydrated and permeated with synthetic leachate in accordance with ASTM D 6766, Scenario 2

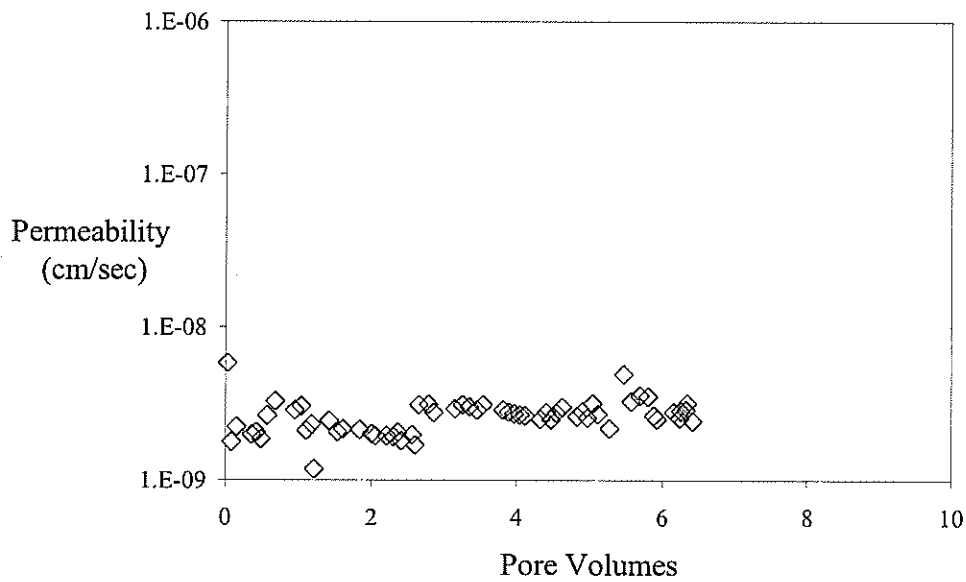

Figure 2 Permeability with pore volumes for Bentomat ST GCL (Roll 82) Note: GCL specimen was hydrated and permeated with synthetic leachate in accordance with ASTM D 6766, Scenario 2

APPENDIX B-2
COMPATIBILITY TEST REPORT
STANDARD GCL



September 15, 2008

Chris Athanassopoulos, P.E.
CETCO
1500 West Shure Drive - 5th floor
Arlington Heights, Illinois 60004
(847) 818-7945 (office)
(847) 323-8750 (cell)
chris.athanassopoulos@amcol.com

Subject: Results for permeability of the Bentomat ST GCL for the Pinon Ridge Uranium Mill Tailings Pond, (TRI Log #: E2308-20-10)

Dear Mr. Athanassopoulos,

The intent of letter is to provide you with the preliminary results for the compatibility of the Bentomat ST GCL with a provided synthetic acidic leachate in support of the Pinon Ridge Uranium Mill Tailings Pond. A representative specimen of the Bentomat ST GCL from roll number 1979 was selected for permeability testing per ASTM D 6766, Scenario 2 modified. The specimen was hydrated with tap water to achieve an initial moisture content of 70%. The specimen was mounted in the triaxial cell and allowed to hydrate with the provided synthetic leachate for a minimum 48 hours under an effective stress of 5 psi. The cell pressure was 80 psi, the head water pressure was 77 psi and the tail water pressure was 75 psi.

The initial pH of the synthetic leachate was measured and recorded as 1.3 and the electrical conductivity was 73.7 mS. Permeability data was recorded at three different effective stresses in increasing order. The cell pressure remained at 80 psi during the entire test with a 2 psi difference in head and tailwater pressures. The specimen was allowed to consolidate overnight with each increase in effective stress. At the end of testing the effective stress was 45 psi and the permeability was 3.8×10^{-8} cm/sec.

Permeability with time, cumulative pore volumes of fluid, and effective stress have been plotted in the attached tables. A raw data table has also been provided. If you have any questions regarding this testing or the results please feel free to contact me.

Sincerely,

A handwritten signature in black ink, appearing to read 'John M. Allen', is written over a white background.

John M. Allen, E.I.T.
Director of the Geosynthetics Interaction Laboratory
TRI/Environmental, Inc.
Attachments (1)

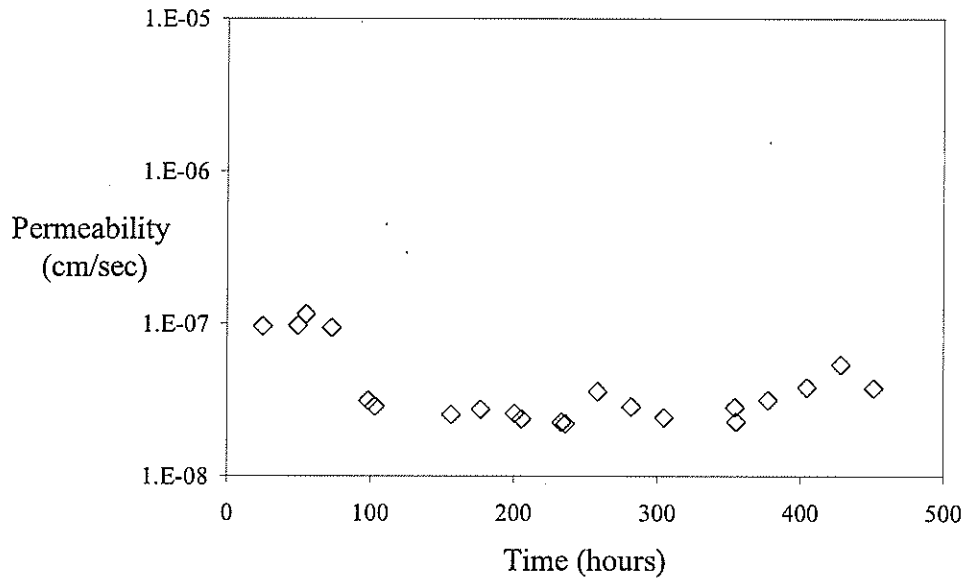

Figure 1 Permeability with time for Bentomat ST GCL (Roll 1979) Note: GCL specimen was hydrated and permeated with synthetic leachate in accordance with ASTM D 6766, Scenario 2

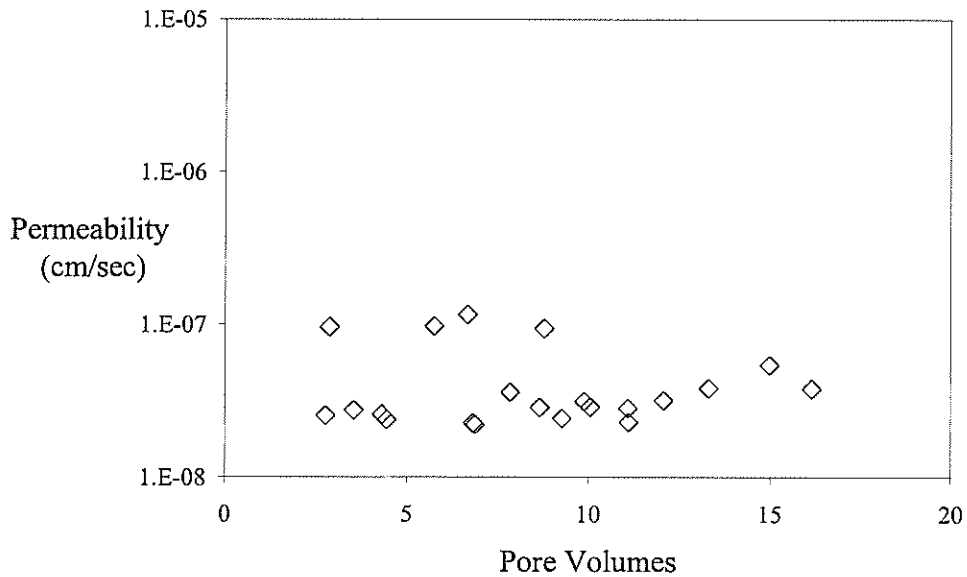

Figure 2 Permeability with pore volumes for Bentomat ST GCL (Roll 1979) Note: GCL specimen was hydrated and permeated with synthetic leachate in accordance with ASTM D 6766, Scenario 2

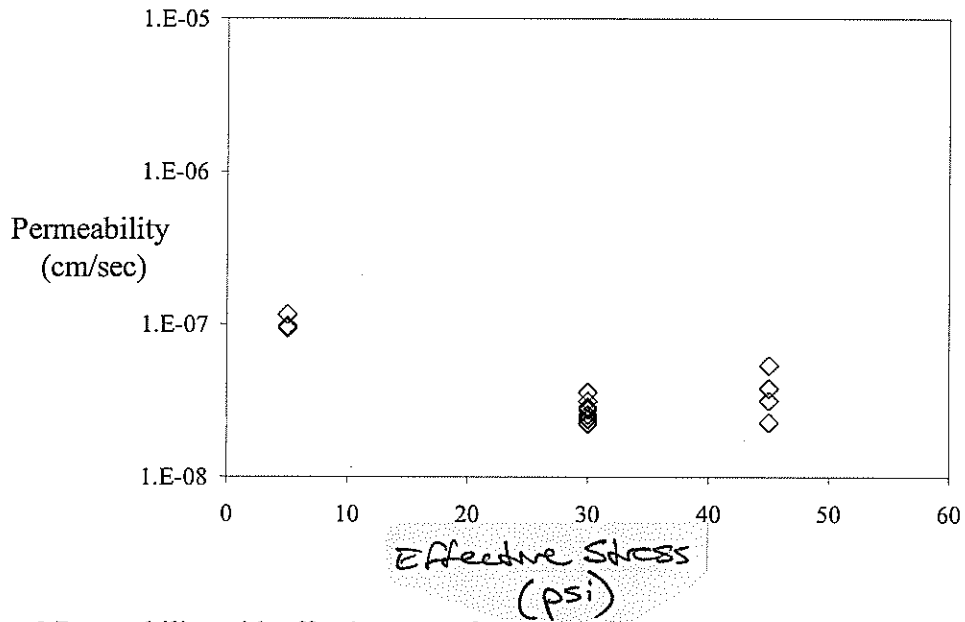

Figure 3 Permeability with effective stress for Bentomat ST GCL (Roll 1979) Note: GCL specimen was hydrated and permeated with synthetic leachate in accordance with ASTM D 6766, Scenario2



Table 1 Raw data for Bentomat ST GCL Permeability Testing with Synthetic Leachate

Time (hours)	Cumulative Pore Volumes	i	k at 20 °C (cm/sec)	s _v (psi)	pH	Electrical Conductivity (mS)
24.8	2.9	185	9.6E-08	5.0	1.3	73.7
49.3	5.8	185	9.7E-08	5.0		
55.1	6.7	209	1.2E-07	5.0		
72.8	8.8	194	9.4E-08	5.0		
98.3	9.9	207	3.1E-08	30.0		
103.0	10.0	191	2.9E-08	30.0		
156.3	2.8	170	2.5E-08	30.0		
176.8	3.5	211	2.7E-08	30.0		
200.6	4.3	192	2.6E-08	30.0		
205.5	4.4	181	2.4E-08	30.0		
233.4	6.8	170	2.3E-08	30.0		
236.0	6.9	161	2.2E-08	30.0		
258.5	7.8	183	3.6E-08	30.0		
281.9	8.7	186	2.9E-08	30.0		
304.8	9.3	169	2.4E-08	30.0		
354.2	11.1	198	2.8E-08	30.0		
355.1	11.1	175	2.3E-08	45.0	1.6	60.4
377.4	12.1	209	3.2E-08	45.0		
404.7	13.3	181	3.8E-08	45.0		
428.4	15.0	200	5.4E-08	45.0		
451.4	16.2	206	3.8E-08	45.0		

Note: leachate initial pH is 1.3 and electrical conductivity was 73.7 mS

APPENDIX C
ANCHOR TRENCH EVALUATION

APPENDIX C

ANCHOR TRENCH EVALUATION

Due to both the long-term exposure of the tailings cell liner system to wind effects and the long slope runs (i.e., on the order of 300 feet), the liner system design incorporates anchorage and buttressing considerations. This appendix presents the following calculations related to liner anchorage against wind uplift forces:

- Appendix C-1 presents an analysis of wind uplift forces;
- Appendix C-2 presents the anchor trench capacity calculations; and
- Appendix C-3 presents a calculation for buttressing at the tailings cell benches.

A design wind velocity of 23.4 miles per hour (mph) was used based on the highest recorded wind speed at the Grand Junction Airport over the past 23 years. Geomembrane wind uplift analyses, presented in Appendix C-1, were conducted using the method proposed by Giroud et al. (1995). These analyses indicate that the maximum strain on the high density polyethylene (HDPE) geomembrane liner is expected to be 1.5 percent, which is well below the yield elongation of 12 percent for 60 mil HDPE geomembrane liner. Therefore, permanent deformations are not expected in the geomembrane due to wind effects.

The wind uplift analyses also provided design forces and inclinations required for evaluation of the geomembrane anchor trench. Results show the maximum tension in the liner to be 151 pounds per foot (lb/ft) at an inclination of 17 degrees with respect to the surface of the side slope.

The tensile strength capacity of the proposed tailings cell liner anchor trench was evaluated using the methodology presented by Koerner (1998), included in Appendix C-2. These analyses indicate that the anchor trench, as designed, will provide sufficient resistance to the forces developed in the geomembrane due to wind uplift, with a factor of safety greater than 8.

The tailings cells were designed with intermediate benches to provide additional anchorage of the geomembrane liner system. Tailings Cell A is designed with an anchor bench at the mid-height of the tailings cell, while Tailings Cells B and C are designed with two intermediate anchor benches. The following design components have been incorporated into the anchor benches:

- An anchor trench will be constructed to provide additional anchorage of the underlying geosynthetic clay liner (GCL) layer; and
- Buttressing of the liner system will be employed by placement of corrugated HDPE pipes backfilled with soil or grout, and secured by sandbags, to limit uplift of the liner system due to wind effects (see calculation provided in Appendix C-3).

REFERENCES

Giroud, J.P., Pelte, T., and Bathurst, R.J. 1995. "Uplift of geomembrane by wind." *Geosynthetics International*, 2(6), 897-953.

Koerner, R.M. 1998. *Designing With Geosynthetics*. Prentice Hall: Upper Saddle River, New Jersey.

APPENDIX C-1
GEOMEMBRANE WIND UPLIFT ANALYSES



Subject Piñon Ridge
Tailings Cell Design
Geomembrane Wind Uplift Analysis

Made by EF
Checked by <i>Jh</i>
Approved by <i>KM</i>

Job No 073-81694
Date 04/07/08
Sheet No 1 of 3

OBJECTIVE:

The objective is to estimate the tensions and deformations of the geomembrane during wind uplift considering anchor trenches at the top of the slopes and buttressing at the base of the slope for the leeward slopes. The cases to be investigated are:

- Case 1 At the base of the tailings cells;
- Case 2 On the leeward slope of the tailings cells A1 and A2; and
- Case 3 On the leeward slope of the tailings cells B and C.

GIVEN:

- The tailings cell layout plan;
- Geomembrane typical properties; and
- Design wind velocity of 23.4 mph (37.7 km/hr) (see Attachment 7).

GEOMETRY:

- The assumed geometrical configuration of the base of the tailing cells and the leeward slopes are shown in Figure 1.

MATERIAL PROPERTIES:

- Geomembrane (Textured HDPE geomembrane, see Attachment 8)
 - Density 58.7 lb/ft³
 - Thickness 60 mil
 - Yield Strength 126 lb/in = 1,512 lb/ft = 22 KN/m
 - Break Strength 90 lb/in = 1,080 lb/ft = 15.8 KN/m
 - Yield Elongation 12%
 - Break Elongation 100%
 - Mass 0.284 lb/ft² = 1.43 Kg/m²

METHOD:

- The analysis of the tension and deformations of the geomembrane during uplift is performed according to Giroud et al.(1995).

ASSUMPTIONS:

- A HDPE pipe filled with sand or grout at the bottom of the cell sideslope is placed to provide anchorage to the geomembrane;
- Two HDPE pipe filled with sand or grout are placed on sideslope benches to provide anchorage to the geomembrane;
- The magnitude of suction does not change in response to changes in geomembrane shape after initial uplift;
- The geomembrane is sealed around its perimeter;
- The problem is assumed to be two dimensional;

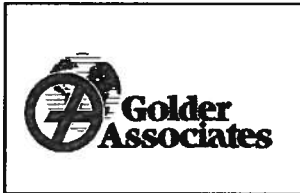

Subject Piñon Ridge
Tailings Cell Design
Geomembrane Wind Uplift Analysis

Made by EF
Checked by <i>Jh</i>
Approved by <i>KFM</i>

Job No 073-81694
Date 04/07/08
Sheet No 2 of 3

- The tensile characteristics of the geomembrane do not depend on temperature;
- The geomembrane did not experience initial uplift leading to a change in aerodynamic flow;
- The tension-strain curve has a peak;
- The suction factors (λ) according to Giroud et al.(1995) assumed in these calculations are: 0.4 for the base of the tailings cells; 0.8 for the leeward slope of the reservoir upper portion tailing cells A1 and A2, 0.6 for the leeward slope of the reservoir, lower portion, tailing cells A1 and A2; 0.9 for the leeward slope of the reservoir, upper portion, tailing cells B and C; 0.7 for the leeward slope of the reservoir, middle portion, tailing cells B and C; and 0.55 for the leeward slope of the reservoir, lower portion, tailing cells B and C

CALCULATIONS:

The calculations are presented in the following Attachments:

- Attachment 1 Case 1 At the base of the reservoir;
- Attachment 2 Case 2 On the leeward slope of the reservoir, upper portion, tailing cells A1 and A2;
- Attachment 3 Case 2 On the leeward slope of the reservoir, lower portion, tailing cells A1 and A2;
- Attachment 4 Case 4 On the leeward slope of the reservoir, upper portion, tailing cells B and C;
- Attachment 5 Case 4 On the leeward slope of the reservoir, middle portion, tailing cells B and C; and
- Attachment 6 Case 4 On the leeward slope of the reservoir, lower portion, tailing cells B and C;

Figure 2 shows a schematic representation of uplifted geomembrane used for developing equations to estimate the deformation in the geomembrane due to wind suctions.

RESULTS:

The following table summarizes the results:

		length (ft)	Strain (%)	u (ft)	T (lb/ft)	θ (degrees)
Cells A,B and C	Cell base	253	1.1	16.6	93	14.6
Cells A1 and A2 Slopeside	upper portion (0.5L) ¹	131	1.5	9.8	151	17.0
	lower portion (0.5L) ¹	131	1.1	8.5	82	14.8
Cells B and C Slopeside	upper portion (0.25L) ¹	66	1.1	4.2	103	14.6
	middle portion (0.33L) ¹	87	1.2	5.9	89	15.5
	lower portion (0.42L) ¹	110	1.0	6.9	82	14.3

¹ L = total length of the slope



Subject Piñon Ridge
Tailings Cell Design
Geomembrane Wind Uplift Analysis

Made by EF
Checked by <i>Jh</i>
Approved by <i>KJM</i>

Job No 073-81694
Date 04/07/08
Sheet No 3 of 3

CONCLUSIONS:

The analyses shows that the tensions produced in the geomembrane by the wind uplift forces are significantly below the tensile yield strength for the considered geomembrane (i.e. $FS > 10$). Nevertheless due to the tensile behavior of the geomembrane, deformations are a controlling parameter.

The maximum strain expected in the geomembrane is 1.5%. For all considered cases, the strain in the geomembrane is less than 12%. Therefore permanent deformations are not expected in the geomembrane.

The anchor trench at the top of the cell sideslope should resist a minimum force equal to 151 lb/ft with an inclination (θ) of 17 degrees with respect to the surface of the sideslope.

REFERENCES:

Giroud, J. P., Pelte, T., and Bathurst, R. J. (1995). "Uplift of geomembranes by wind." *Geosynthetics International*, 2(6), 897-953.

FIGURES

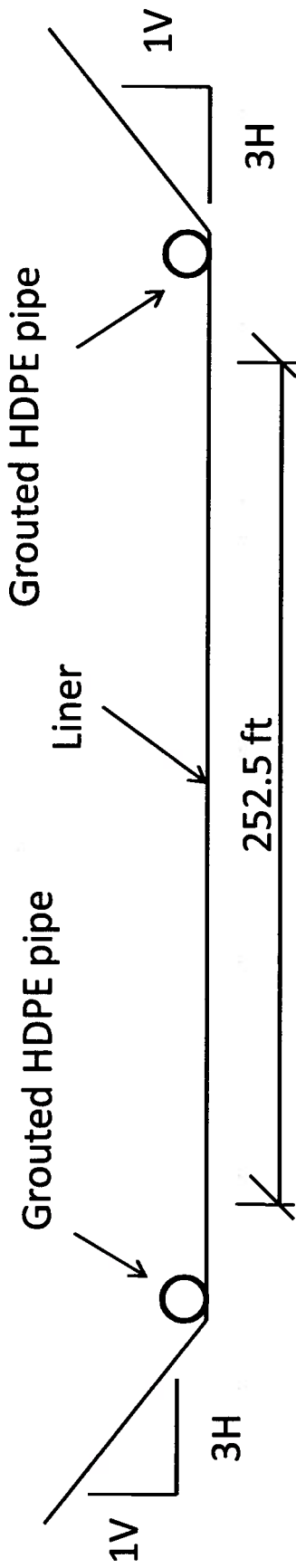

CASE 1: BASE OF TAILINGS CELL

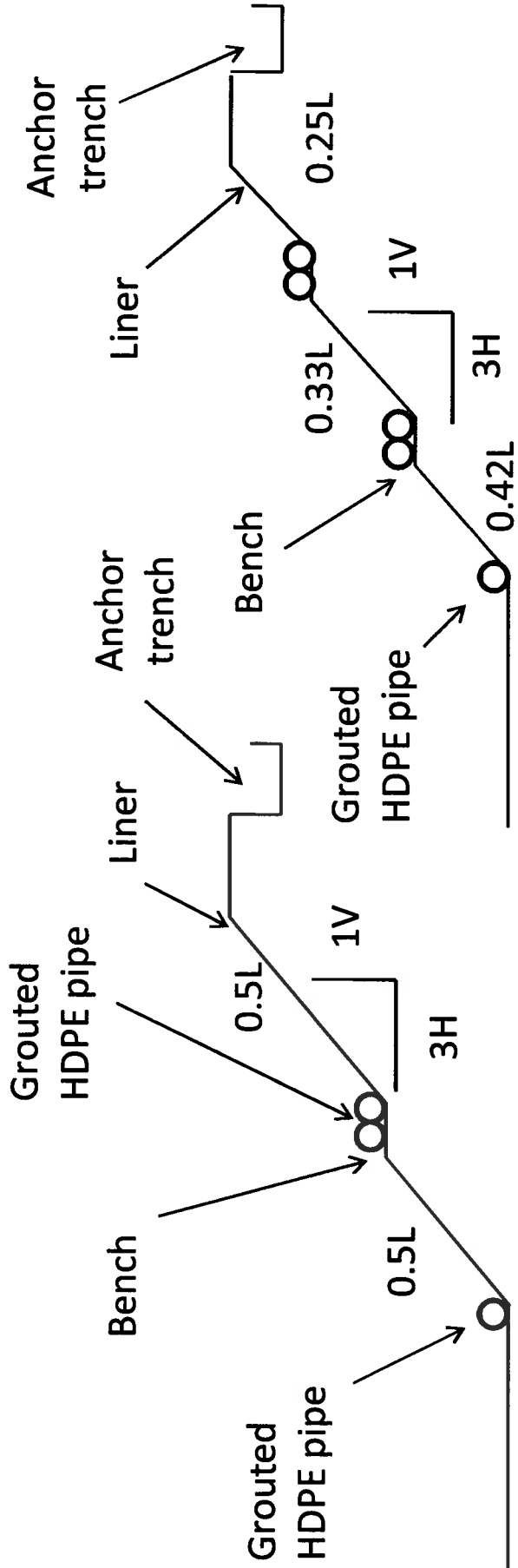

CASE 2: TAILINGS CELLS A.1 AND A.2

CASE 3: TAILINGS CELLS B AND C

 <p>Denver, Colorado</p>	<p>TITLE</p> <p>GEOMETRICAL CONFIGURATION FOR CASE 1, CASE 2, AND CASE 3</p>
<p>CLIENT/PROJECT</p> <p>ENERGY FUELS RESOURCES CORPORATION PIÑON RIDGE PROJECT</p>	<p>DRAWN EF</p> <p>CHECKED <i>[Signature]</i></p> <p>REVIEWED <i>[Signature]</i></p> <p>DATE APRIL 7 2008</p> <p>SCALE N.T.S.</p> <p>FILE NO. Figures-uplift.pptx</p>
<p>JOB NO. 073-81694</p> <p>DWG. NO.</p>	<p>FIGURE NO. 1</p>

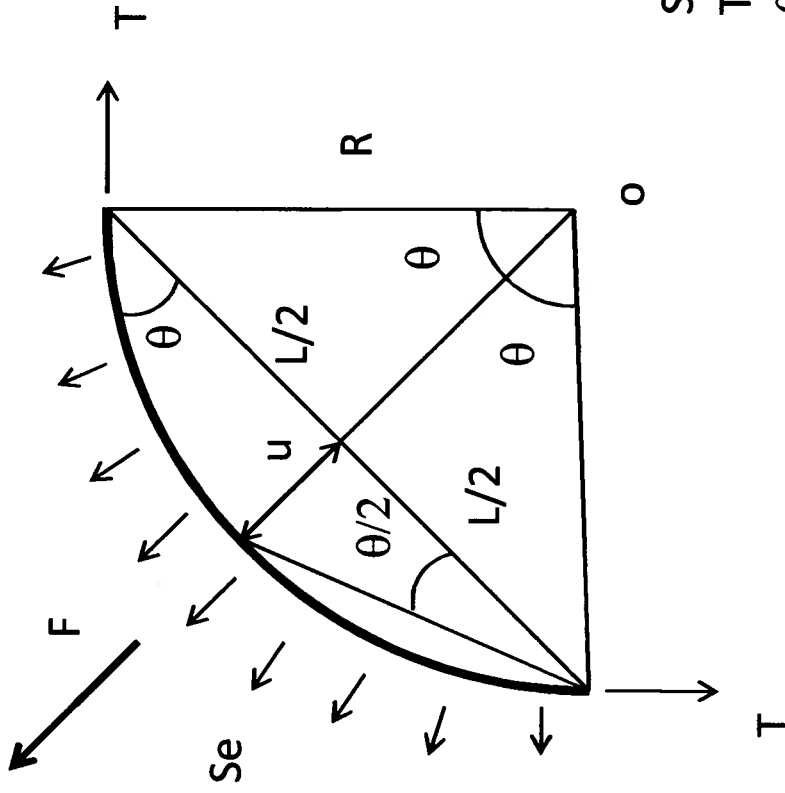

- Se = effective suction
- T = geomembrane tension
- θ = angle
- u = uplift
- L = considered length
- F = resultant force

Reproduced from Giroud et al. (1995) pp. 918

 ENERGY FUELS RESOURCES CORPORATION PIÑON RIDGE PROJECT	SCHEMATIC REPRESENTATION OF UPLIFT GEOMEMBRANE			
	CLIENT/PROJECT	DRAWN EF	DATE APRIL 7 2008	JOB NO. 073-81694
	CHECKED <i>[Signature]</i>	SCALE N.T.S.	FILE NO. Figures-uplift.pptx	DWG. NO.
	REVIEWED <i>[Signature]</i>	TITLE	FIGURE NO. 2	

ATTACHMENT 1



Made by: EF
 Checked by: *JE*
 Approved by: *KTM*

Subject: Piñon Ridge
 Job No. 073-81694
 Date: 4/7/2008
 Sheet No. 1 of 4

Case 1 At the base of the tailings cells

Suction factor for the bottom of the tailings cells:

$$\lambda := 0.40$$

Wind velocity (23.4 mph):

$$V := 37.7 \frac{\text{km}}{\text{hr}} \quad (\text{e.g., } 23.4 \text{ mph})$$

Average altitude of the tailings cells above sea level (5480 ft):

$$z := 1670.3 \text{ m} \quad (\text{e.g., } 5480 \text{ ft})$$

The mass per unit area of geomembrane required to resist uplift by a wind of velocity V at altitude z above the sea level is defined by:

$$\mu_{GM} := 0.005085 \cdot \lambda \cdot V^2 \cdot \exp(-1.252 \cdot 10^{-4} \cdot z) \quad (\text{eq. 21, Giroud et al. 1995})$$

$$\mu_{GM} = 2.35 \frac{\text{kg}}{\text{m}^2} \quad \text{required geomembrane mass}$$

The maximum wind velocity that the geomembrane can be subject to without being uplifted:

$$\mu_{GM} := 1.43 \frac{\text{kg}}{\text{m}^2} \quad \text{geomembrane mass per unit area (60 mil HDPE)}$$

$$V_{up} := 14.023 \cdot \exp(6.259 \cdot 10^{-5} \cdot z) \cdot \sqrt{\frac{\mu_{GM}}{\lambda}} \quad (\text{eq. 26, Giroud et al. 1995})$$

$$V_{up} = 29.44 \frac{\text{km}}{\text{hr}} \quad (\text{e.g., } 18.3 \text{ mph})$$

Therefore, uplift occurs at the design wind velocity ($V_{up} < V$).

The effective suction in the geomembrane is:

$$S_e := 0.050 \cdot \lambda \cdot V^2 \cdot \exp(-1.252 \cdot 10^{-4} \cdot z) - 9.81 \cdot \mu_{GM} \quad (\text{eq. 41, Giroud et al. 1995})$$

$$S_e = 9.03 \text{ Pa} \quad (\text{e.g., } 0.19 \text{ lb/ft}^2)$$

The resultant force of the applied effective suction is equal to:

$$L := 76.96 \text{ m} \quad (\text{e.g., } 252.5 \text{ ft})$$

$$F := S_e \cdot L \quad (\text{eq. 42, Giroud et al. 1995})$$

$$F = 695.21 \frac{\text{N}}{\text{m}} \quad (\text{e.g., } 47.6 \text{ lb/ft})$$

Calculations were performed using the international unit system (SI), since the empirical equations were developed using this unit system.

The normalized allowable tension (T_n) is defined as:

$$T_{all} := 22 \frac{\text{kN}}{\text{m}} \quad \text{Break elongation, \%} = 12$$

$$T_n := \frac{T_{all} \cdot 1000}{F} \quad (\text{eq. 48, Giroud et al. 1995})$$

$$T_n = 31.64$$

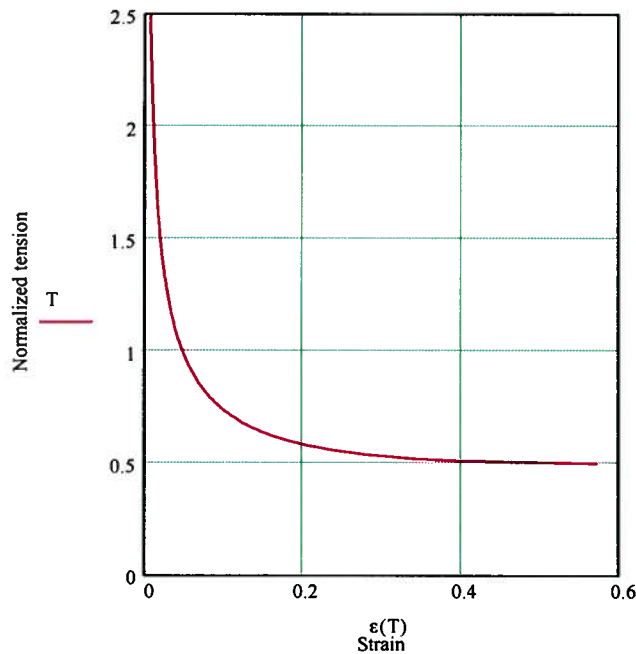

Uplift tension-strain relationship

The determination of tension in the geomembrane is done by trial and error assuming different values for T_{GM} until the calculated strain versus T_{GM} compares with the Geomembrane tension-strain curve.

The strain in the geomembrane is estimated as:

$$T_{GM} := 1350 \frac{\text{N}}{\text{m}} \quad \text{Tension in the geomembrane} \quad (\text{e.g., } 92.5 \text{ lb/ft})$$

$$\epsilon := \left[\left(\frac{T_{GM} \cdot \text{asin}\left(\frac{F}{2 \cdot T_{GM}}\right)}{F} \right) - 1 \right] \cdot 100 \quad (\text{eq. 47, Giroud et al. 1995})$$

$$\epsilon = 1.14 \quad \%$$

$$T_{GM} := \frac{T_{GM}}{1000} \quad T_{GM} = 1.35 \frac{\text{N}}{\text{m}} \quad (\text{i.e., } 92.5 \text{ lb/ft})$$

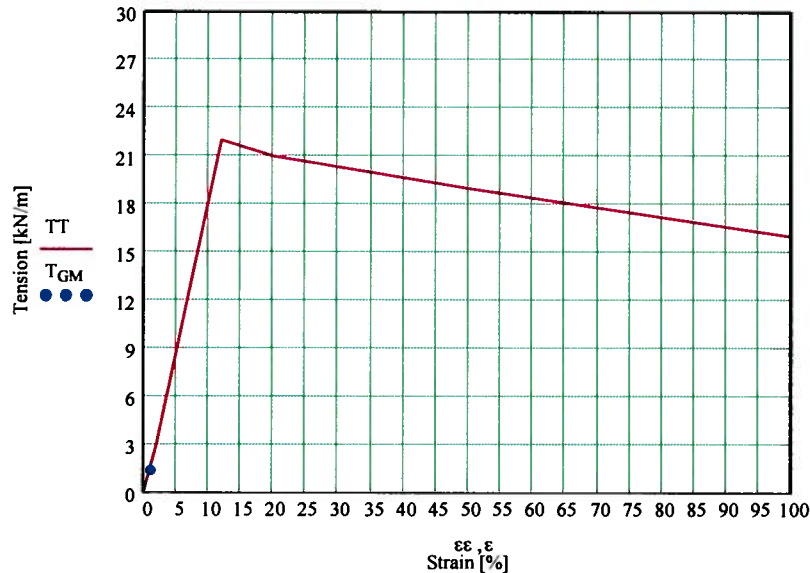

Geomembrane tension-strain curve

The orientation of the geomembrane tension at both extremities of the geomembrane is:

$$T_n := \frac{T_{GM} \cdot 1000}{F}$$

$$T_n = 1.94$$

$$\theta := \text{asin}\left(\frac{1}{2 \cdot T_n}\right) \quad (\text{eq. 56, Giroud et al. 1995})$$

$$\theta = 0.26 \text{ radians} \quad (\text{i.e., } 14.6 \text{ degrees})$$

The geomembrane uplift is :

$$u := 0.5 \cdot \tan\left(\frac{\theta}{2}\right) \cdot L \quad (\text{eq. 54, Giroud et al. 1995})$$

$$u = 5.04 \text{ m} \quad (\text{i.e., } 16.6 \text{ ft})$$



Made by: EF
Checked by: *[Signature]*
Approved by: *[Signature]*

Subject: Piñon Ridge
Job No. 073-81694
Date: 4/7/2008
Sheet No. 4 of 4

Plots data:

$$\varepsilon(T) := 2 \cdot T \cdot \text{asin}\left(\frac{1}{2 \cdot T}\right) - 1$$

$$T := 0.50, 0.51 \dots 2.5$$

$$\varepsilon\varepsilon := \begin{pmatrix} 0 \\ 2 \\ 12 \\ 20 \\ 50 \\ 100 \end{pmatrix} \quad TT := \begin{pmatrix} 0 \\ 3 \\ 22 \\ 21 \\ 19 \\ 16 \end{pmatrix}$$

ATTACHMENT 2



Made by: EF
Checked by: *KE*
Approved by: *KMM*

Subject: Pifon Ridge
Job No. 073-81694
Date: 4/7/2008
Sheet No. 1 of 4

Case 2 On the leeward slope of the tailings cells (cells A1 and A2), lower portion

Suction factor for the leeward slope of the tailings cells:

$$\lambda := 0.51 \quad \text{for the lower portion of the slope}$$

Wind velocity:

$$V := 37.7 \frac{\text{km}}{\text{hr}} \quad (\text{e.g., } 23.4 \text{ mph})$$

Altitude above sea level:

$$z := 1670.3 \text{ m} \quad (\text{e.g., } 5480 \text{ ft})$$

Calculations were performed using the international unit system (SI), since the empirical equations were developed using this unit system.

The mass per unit area of geomembrane required to resist uplift by a wind of velocity V at altitude z above the sea level is defined by:

$$\mu_{GM} := 0.005085 \cdot \lambda \cdot V^2 \cdot \exp(-1.252 \cdot 10^{-4} \cdot z) \quad (\text{eq. 21, Giroud et al. 1995})$$

$$\mu_{GM} = 2.99 \frac{\text{kg}}{\text{m}^2} \quad \text{required geomembrane mass}$$

The maximum wind velocity that the geomembrane can be subject to without being uplifted:

$$\mu_{GM} := 1.431 \frac{\text{kg}}{\text{m}^2} \quad \text{geomembrane mass per unit area (60 mil HDPE)}$$

$$V_{up} := 14.023 \cdot \exp(6.259 \cdot 10^{-5} \cdot z) \cdot \sqrt{\frac{\mu_{GM}}{\lambda}} \quad (\text{eq. 26, Giroud et al. 1995})$$

$$V_{up} = 26.078 \frac{\text{km}}{\text{hr}} \quad (\text{e.g., } 14.9 \text{ mph})$$

The effective suction in the geomembrane is:

$$S_e := 0.050 \cdot \lambda \cdot V^2 \cdot \exp(-1.252 \cdot 10^{-4} \cdot z) - 9.81 \cdot \mu_{GM} \quad (\text{eq. 41, Giroud et al. 1995})$$

$$S_e = 15.366 \text{ Pa} \quad (\text{e.g., } 0.43 \text{ lb/ft}^2)$$

The resultant force of the applied effective suction is equal to:

$$L := 40.0 \text{ m} \quad (\text{e.g., } 131.2 \text{ ft})$$

$$F := S_e \cdot L \quad (\text{eq. 42, Giroud et al. 1995})$$

$$F = 614.625 \frac{\text{N}}{\text{m}} \quad (\text{e.g., } 56.3 \text{ lb/ft})$$

The normalized allowable tension (T_n) is defined as:

$$T_{all} := 22 \frac{\text{kN}}{\text{m}} \quad \text{Break elongation, \%} = 12$$

$$T_n := \frac{T_{all} \cdot 1000}{F}$$

$$T_n = 35.794$$

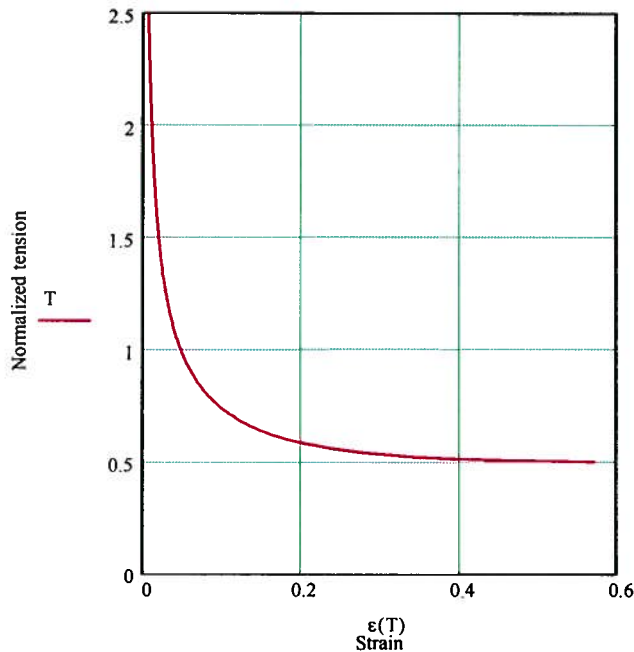

Uplift tension-strain relationship

The determination of tension in the geomembrane is done by trial and error assuming different values for T_{GM} until the calculated strain versus T_{GM} compares with the Geomembrane tension-strain curve.

The strain in the geomembrane is estimated as:

$$T_{GM} := 1200 \frac{\text{N}}{\text{m}} \quad \text{Tension in the geomembrane} \quad (\text{e.g., } 82.2 \text{ lb/ft})$$

$$\epsilon := \left[\left(\frac{T_{GM} \cdot \text{asin}\left(\frac{F}{2 \cdot T_{GM}}\right)}{F} \right) - 1 \right] \cdot 100 \quad (\text{eq. 47, Giroud et al. 1995})$$

$$\epsilon = 1.127 \quad \%$$

$$T_{GM} := \frac{T_{GM}}{1000} \quad T_{GM} = 1.2 \frac{\text{KN}}{\text{m}} \quad (\text{i.e., } 82.2 \text{ lb/ft})$$

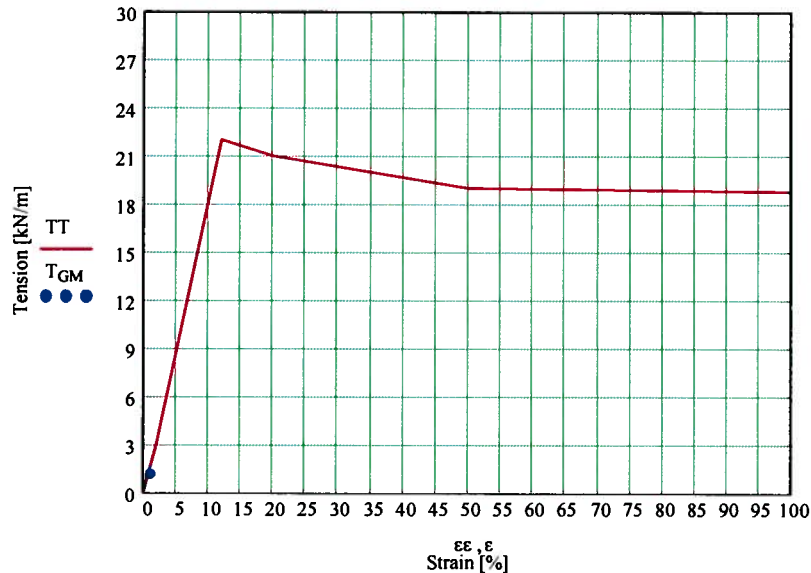

Geomembrane tension-strain curve

The orientation of the geomembrane tension at both extremities of the geomembrane is:

$$T_n := \frac{T_{GM} \cdot 1000}{F}$$

$$T_n = 1.952$$

$$\theta := \text{asin}\left(\frac{1}{2 \cdot T_n}\right) \quad (\text{eq. 56, Giroud et al. 1995})$$

$$\theta = 0.259 \text{ radians} \quad (\text{i.e., } 14.8 \text{ degrees})$$

The geomembrane uplift is :

$$u := 0.5 \cdot \tan\left(\frac{\theta}{2}\right) \cdot L \quad (\text{eq. 54, Giroud et al. 1995})$$

$$u = 2.604 \text{ m} \quad (\text{i.e., } 8.54 \text{ ft})$$



Made by: EF
Checked by: *JE*
Approved by: *KMA*

Subject: Piñon Ridge
Job No. 073-81694
Date: 4/7/2008
Sheet No. 4 of 4

Plots data

$$\varepsilon(T) := 2 \cdot T \cdot \operatorname{asin}\left(\frac{1}{2 \cdot T}\right) - 1$$

$$T := 0.50, 0.51 \dots 2.5$$

$$\varepsilon\varepsilon := \begin{pmatrix} 0 \\ 2 \\ 12 \\ 20 \\ 50 \\ 800 \end{pmatrix} \quad TT := \begin{pmatrix} 0 \\ 3 \\ 22 \\ 21 \\ 19 \\ 16 \end{pmatrix}$$

ATTACHMENT 3



Made by: EF
 Checked by: *[Signature]*
 Approved by: *[Signature]*

Subject: Piñon Ridge
 Job No. 073-81694
 Date: 4/7/2008
 Sheet No. 1 of 4

Case 2 On the leeward slope of the tailings cells (cells A1 and A2), upper portion

Suction factor for the leeward slope of the tailings cells:

$$\lambda := 0.8 \quad \text{for the upper portion of the slope}$$

Wind velocity:

$$V := 37.7 \frac{\text{km}}{\text{hr}} \quad (\text{e.g., } 23.4 \text{ mph})$$

Altitude above sea level:

$$z := 1670.3 \text{ m} \quad (\text{e.g., } 5480 \text{ ft})$$

Calculations were performed using the international unit system (SI), since the empirical equations were developed using this unit system.

The mass per unit area of geomembrane required to resist uplift by a wind of velocity V at altitude z above the sea level is defined by:

$$\mu_{GM} := 0.005085 \cdot \lambda \cdot V^2 \cdot \exp(-1.252 \cdot 10^{-4} \cdot z) \quad (\text{eq. 21, Giroud et al. 1995})$$

$$\mu_{GM} = 4.691 \frac{\text{kg}}{\text{m}^2} \quad \text{required geomembrane mass}$$

The maximum wind velocity that the geomembrane can be subject to without being uplifted:

$$\mu_{GM} := 1.431 \frac{\text{kg}}{\text{m}^2} \quad \text{geomembrane mass per unit area (60 mil HDPE)}$$

$$V_{up} := 14.023 \cdot \exp(6.259 \cdot 10^{-5} \cdot z) \cdot \sqrt{\frac{\mu_{GM}}{\lambda}} \quad (\text{eq. 26, Giroud et al. 1995})$$

$$V_{up} = 20.822 \frac{\text{km}}{\text{hr}} \quad (\text{e.g., } 12.9 \text{ mph})$$

The effective suction in the geomembrane is:

$$S_e := 0.050 \cdot \lambda \cdot V^2 \cdot \exp(-1.252 \cdot 10^{-4} \cdot z) - 9.81 \cdot \mu_{GM} \quad (\text{eq. 41, Giroud et al. 1995})$$

$$S_e = 32.085 \text{ Pa} \quad (\text{e.g., } 0.67 \text{ lb/ft}^2)$$

The resultant force of the applied effective suction is equal to:

$$L := 40.0 \text{ m} \quad (\text{e.g., } 131.2 \text{ ft})$$

$$F := S_e \cdot L \quad (\text{eq. 42, Giroud et al. 1995})$$

$$F = 1.283 \times 10^3 \frac{\text{N}}{\text{m}} \quad (\text{e.g., } 87.9 \text{ lb/ft})$$

The normalized allowable tension (T_n) is defined as:

$$T_{all} := 22 \frac{\text{kN}}{\text{m}} \quad \text{Break elongation, \%} = 12$$

$$T_n := \frac{T_{all} \cdot 1000}{F} \quad (\text{eq. 48, Giroud et al. 1995})$$

$$T_n = 17.142$$

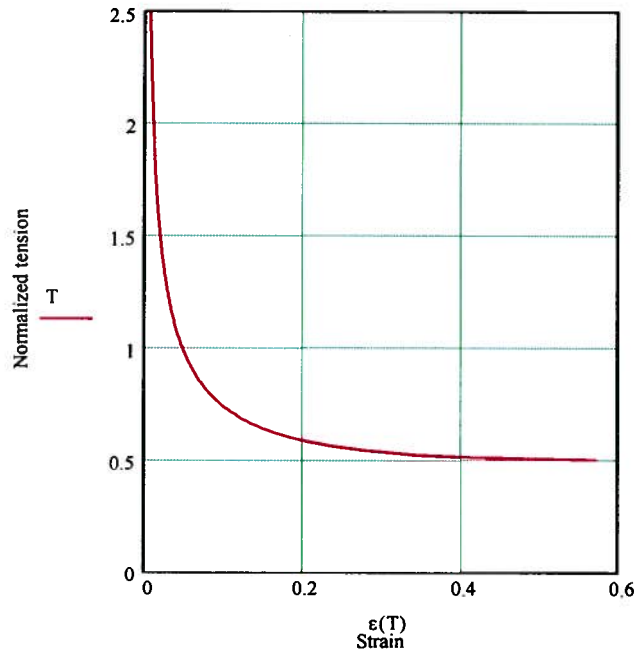

Uplift tension-strain relationship

The determination of tension in the geomembrane is done by trial and error assuming different values for T_{GM} until the calculated strain versus T_{GM} compares with the Geomembrane tension-strain curve.

The strain in the geomembrane is estimated as:

$$T_{GM} := 2200 \frac{\text{N}}{\text{m}} \quad \text{Tension in the geomembrane (e.g., 150.8 lb/ft)}$$

$$\epsilon := \left[\left(\frac{T_{GM} \cdot \text{asin}\left(\frac{F}{2 \cdot T_{GM}}\right)}{F} \right) - 1 \right] \cdot 100 \quad (\text{eq. 47, Giroud et al. 1995})$$

$$\epsilon = 1.475 \quad \%$$

$$T_{GM} := \frac{T_{GM}}{1000} \quad T_{GM} = 2.2 \frac{KN}{m} \quad (\text{i.e., } 150.8 \text{ lb/ft})$$

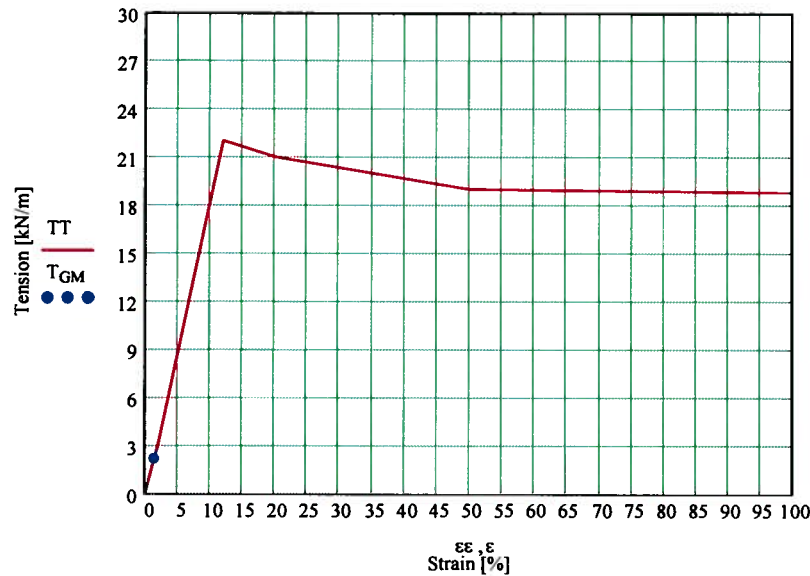

Geomembrane tension-strain curve

The orientation of the geomembrane tension at both extremities of the geomembrane is:

$$T_n := \frac{T_{GM} \cdot 1000}{F}$$

$$T_n = 1.714$$

$$\theta := \text{asin}\left(\frac{1}{2 \cdot T_n}\right) \quad (\text{eq. 56, Giroud et al. 1995})$$

$$\theta = 0.296 \text{ radians} \quad (\text{i.e., } 17 \text{ degrees})$$

The geomembrane uplift is :

$$u := 0.5 \cdot \tan\left(\frac{\theta}{2}\right) \cdot L \quad (\text{eq. 54, Giroud et al. 1995})$$

$$u = 2.982 \text{ m} \quad (\text{i.e., } 9.8 \text{ ft})$$



Made by: EF
Checked by: *JS*
Approved by: *KJM*

Subject: Piñon Ridge
Job No. 073-81694
Date: 4/7/2008
Sheet No. 4 of 4

Plots data

$$\varepsilon(T) := 2 \cdot T \cdot \text{asin}\left(\frac{1}{2 \cdot T}\right) - 1$$

T := 0.50, 0.51 .. 2.5

$$\varepsilon\varepsilon := \begin{pmatrix} 0 \\ 2 \\ 12 \\ 20 \\ 50 \\ 800 \end{pmatrix} \quad TT := \begin{pmatrix} 0 \\ 3 \\ 22 \\ 21 \\ 19 \\ 16 \end{pmatrix}$$

ATTACHMENT 4



Made by: EF
 Checked by:
 Approved by: *[Signature]*

Subject: Pifon Ridge
 Job No. 073-81694
 Date: 4/7/2008
 Sheet No. 1 of 4

Case 3 On the leeward slope of the tailings cells (cells B and C), upper portion

Suction factor for the leeward slope of the reservoir:

$$\lambda := 0.9 \quad \text{for the upper portion of the slope}$$

Wind velocity:

$$V := 37.7 \frac{\text{km}}{\text{hr}} \quad (\text{e.g., 23.4 mph})$$

Altitude above sea level:

$$z := 1670.3 \text{ m} \quad (\text{e.g., 5480 ft})$$

Calculations were performed using the international unit system (SI), since the empirical equations were developed using this unit system.

The mass per unit area of geomembrane required to resist uplift by a wind of velocity V at altitude z above the sea level is defined by:

$$\mu\text{GM} := 0.005085 \cdot \lambda \cdot V^2 \cdot \exp(-1.252 \cdot 10^{-4} \cdot z) \quad (\text{eq. 21, Giroud et al. 1995})$$

$$\mu\text{GM} = 5.28 \frac{\text{kg}}{\text{m}^2} \quad \text{required geomembrane mass}$$

The maximum wind velocity that the geomembrane can be subject to without being uplifted:

$$\mu\text{GM} := 1.431 \frac{\text{kg}}{\text{m}^2} \quad \text{geomembrane mass per unit area (60 mil HDPE)}$$

$$V_{\text{up}} := 14.023 \cdot \exp(6.259 \cdot 10^{-5} \cdot z) \cdot \sqrt{\frac{\mu\text{GM}}{\lambda}} \quad (\text{eq. 26, Giroud et al. 1995})$$

$$V_{\text{up}} = 19.63 \frac{\text{km}}{\text{hr}} \quad (\text{e.g., 12.2 mph})$$

The effective suction in the geomembrane is:

$$S_e := 0.050 \cdot \lambda \cdot V^2 \cdot \exp(-1.252 \cdot 10^{-4} \cdot z) - 9.81 \cdot \mu\text{GM} \quad (\text{eq. 41, Giroud et al. 1995})$$

$$S_e = 37.85 \text{ Pa} \quad (\text{e.g., 0.79 lb/ft}^2)$$

The resultant force of the applied effective suction is equal to:

$$L := 20.0 \text{ m} \quad (\text{e.g., 65.6 ft})$$

$$F := S_e \cdot L \quad (\text{eq. 42, Giroud et al. 1995})$$

$$F = 757.02 \frac{\text{N}}{\text{m}} \quad (\text{e.g., 51.9 lb/ft})$$

The normalized allowable tension (T_n) is defined as:

$$T_{all} := 22 \frac{\text{kN}}{\text{m}} \quad \text{Break elongation, \%} = 12$$

$$T_n := \frac{T_{all} \cdot 1000}{F} \quad (\text{eq. 48, Giroud et al. 1995})$$

$$T_n = 29.06$$

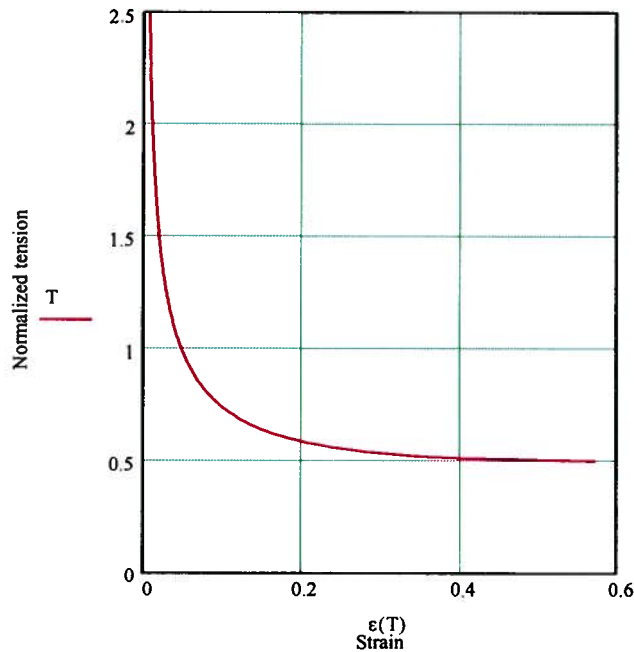

Uplift tension-strain relationship

The determination of tension in the geomembrane is done by trial and error assuming different values for T_{GM} until the calculated strain versus T_{GM} compares with the Geomembrane tension-strain curve.

The strain in the geomembrane is estimated as:

$$T_{GM} := 1500 \frac{\text{N}}{\text{m}} \quad \text{Tension in the geomembrane} \quad (\text{e.g., } 102.8 \text{ lb/ft})$$

$$\epsilon := \left[\left(\frac{T_{GM} \cdot \text{asin}\left(\frac{F}{2 \cdot T_{GM}}\right)}{F} \right) - 1 \right] \cdot 100 \quad (\text{eq. 47, Giroud et al. 1995})$$

$$\epsilon = 1.09 \quad \%$$

$$TGM := \frac{TGM}{1000} \quad TGM = 1.5 \frac{kN}{m} \quad (\text{i.e., } 102.8 \text{ lb/ft})$$

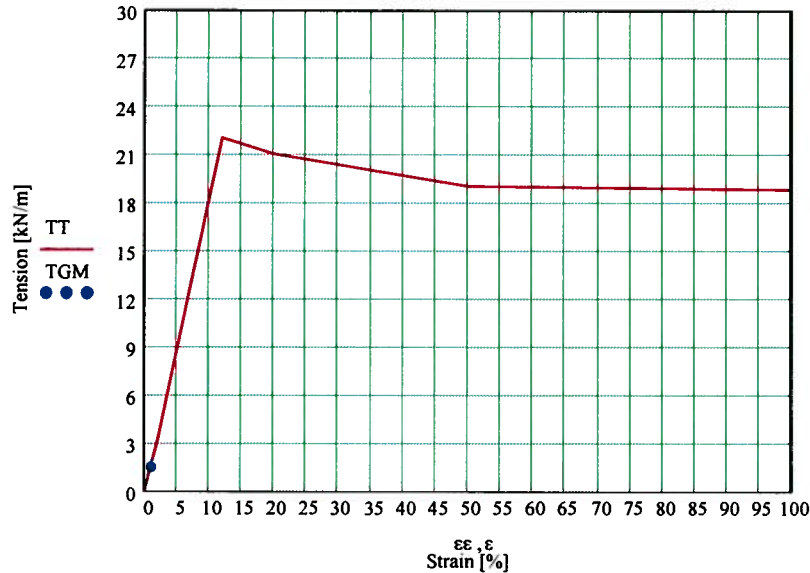

Geomembrane tension-strain curve

The orientation of the geomembrane tension at both extremities of the geomembrane is:

$$T_n := \frac{TGM \cdot 1000}{F}$$

$$T_n = 1.98$$

$$\theta := \text{asin}\left(\frac{1}{2 \cdot T_n}\right) \quad (\text{eq. 56, Giroud et al. 1995})$$

$$\theta = 0.26 \text{ radians} \quad (\text{i.e., } 14.6 \text{ degrees})$$

The geomembrane uplift is :

$$u := 0.5 \cdot \tan\left(\frac{\theta}{2}\right) \cdot L \quad (\text{eq. 54, Giroud et al. 1995})$$

$$u = 1.28 \text{ m} \quad (\text{i.e., } 4.2 \text{ ft})$$



Made by: EF
Checked by: *JL*
Approved by: *KAM*

Subject: Piñon Ridge
Job No. 073-81694
Date: 4/7/2008
Sheet No. 4 of 4

Plots data

$$\varepsilon(T) := 2 \cdot T \cdot \text{asin}\left(\frac{1}{2 \cdot T}\right) - 1$$

$$T := 0.50, 0.51 \dots 2.5$$

$$\varepsilon\varepsilon := \begin{pmatrix} 0 \\ 2 \\ 12 \\ 20 \\ 50 \\ 800 \end{pmatrix} \quad TT := \begin{pmatrix} 0 \\ 3 \\ 22 \\ 21 \\ 19 \\ 16 \end{pmatrix}$$

5)

ATTACHMENT 5



Made by: EF
 Checked by:
 Approved by: *[Signature]*

Subject: Pifon Ridge
 Job No. 073-81694
 Date: 4/7/2008
 Sheet No. 1 of 4

Case 3 On the leeward slope of the tailings cells (cells B and C), middle portion

Suction factor for the leeward slope of the reservoir:

$$\lambda := 0.7 \quad \text{for the middle portion of the slope}$$

Wind velocity:

$$V := 37.7 \frac{\text{km}}{\text{hr}} \quad (\text{e.g., 23.4 mph})$$

Altitude above sea level:

$$z := 1670.3 \text{ m} \quad (\text{e.g., 5480 ft})$$

Calculations were performed using the international unit system (SI), since the empirical equations were developed using this unit system.

The mass per unit area of geomembrane required to resist uplift by a wind of velocity V at altitude z above the see level is defined by:

$$\mu_{GM} := 0.005085 \cdot \lambda \cdot V^2 \cdot \exp(-1.252 \cdot 10^{-4} \cdot z) \quad (\text{eq. 21, Giroud et al. 1995})$$

$$\mu_{GM} = 4.1 \frac{\text{kg}}{\text{m}^2} \quad \text{required geomembrane mass}$$

The maximum wind velocity that the geomembrane can be subject to without being uplifted:

$$\mu_{GM} := 1.431 \frac{\text{kg}}{\text{m}^2} \quad \text{geomembrane mass per unit area (60 mil HDPE)}$$

$$V_{up} := 14.023 \cdot \exp(6.259 \cdot 10^{-5} \cdot z) \cdot \sqrt{\frac{\mu_{GM}}{\lambda}} \quad (\text{eq. 26, Giroud et al. 1995})$$

$$V_{up} = 22.26 \frac{\text{km}}{\text{hr}} \quad (\text{e.g., 12.9 mph})$$

The effective suction in the geomembrane is:

$$S_e := 0.050 \cdot \lambda \cdot V^2 \cdot \exp(-1.252 \cdot 10^{-4} \cdot z) - 9.81 \cdot \mu_{GM} \quad (\text{eq. 41, Giroud et al. 1995})$$

$$S_e = 26.32 \text{ Pa} \quad (\text{e.g., 0.55 lb/ft}^2)$$

The resultant force of the applied effective suction is equal to:

$$L := 26.4 \text{ m} \quad (\text{e.g., 86.6 ft})$$

$$F := S_e \cdot L \quad (\text{eq. 42, Giroud et al. 1995})$$

$$F = 694.85 \frac{\text{N}}{\text{m}} \quad (\text{e.g., 47.6 lb/ft})$$

The normalized allowable tension (T_n) is defined as:

$$T_{all} := 22 \frac{\text{kN}}{\text{m}} \quad \text{Break elongation, \%} = 12$$

$$T_n := \frac{T_{all} \cdot 1000}{F} \quad (\text{eq. 48, Giroud et al. 1995})$$

$$T_n = 31.66$$

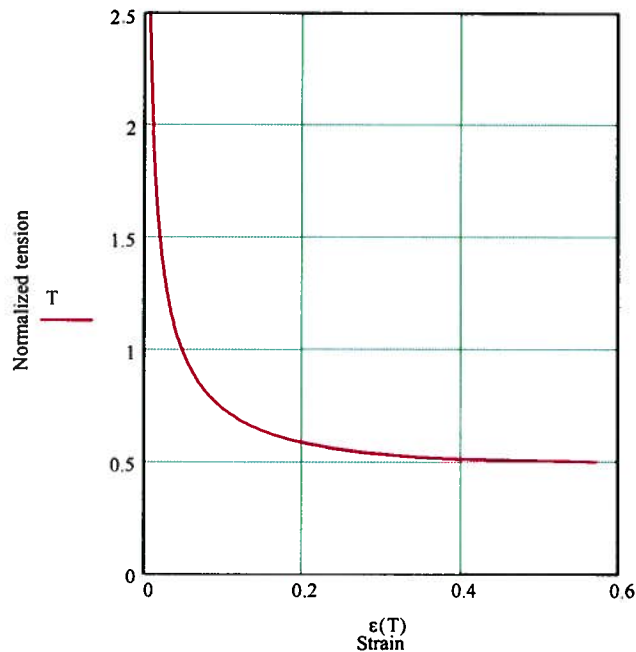

Uplift tension-strain relationship

The determination of tension in the geomembrane is done by trial and error assuming different values for T_{GM} until the calculated strain versus T_{GM} compares with the Geomembrane tension-strain curve.

The strain in the geomembrane is estimated as:

$$T_{GM} := 1300 \frac{\text{N}}{\text{m}} \quad \text{Tension in the geomembrane} \quad (\text{e.g., } 89.1 \text{ lb/ft})$$

$$\epsilon := \left[\left(\frac{T_{GM} \cdot \text{asin}\left(\frac{F}{2 \cdot T_{GM}}\right)}{F} \right) - 1 \right] \cdot 100 \quad (\text{eq. 47, Giroud et al. 1995})$$

$$\epsilon = 1.23 \quad \%$$

$$\text{TGM} := \frac{\text{TGM}}{1000} \quad \text{TGM} = 1.3 \times 10^3 \text{ i.e., } 89.1 \text{ lb/ft}$$

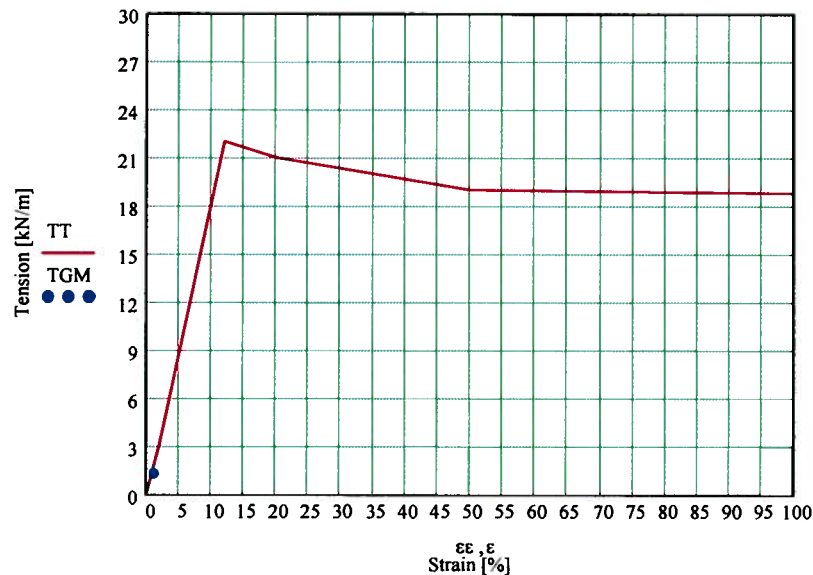

Geomembrane tension-strain curve

The orientation of the geomembrane tension at both extremities of the geomembrane is:

$$T_n := \frac{\text{TGM} \cdot 1000}{F}$$

$$T_n = 1.87$$

$$\theta := \text{asin}\left(\frac{1}{2 \cdot T_n}\right) \quad (\text{eq. 56, Giroud et al. 1995})$$

$$\theta = 0.27 \text{ radians} \quad (\text{i.e., } 15.5 \text{ degrees})$$

The geomembrane uplift is :

$$u := 0.5 \cdot \tan\left(\frac{\theta}{2}\right) \cdot L$$

$$u = 1.8 \text{ m} \quad (\text{i.e., } 5.9 \text{ ft})$$



Made by: EF
Checked by: *JE*
Approved by: *KAM*

Subject: Piñon Ridge
Job No. 073-81694
Date: 4/7/2008
Sheet No. 4 of 4

Plots data

$$\varepsilon(T) := 2 \cdot T \cdot \operatorname{asin}\left(\frac{1}{2 \cdot T}\right) - 1$$

$$T := 0.50, 0.51 \dots 2.5$$

$$\varepsilon\varepsilon := \begin{pmatrix} 0 \\ 2 \\ 12 \\ 20 \\ 50 \\ 800 \end{pmatrix} \quad TT := \begin{pmatrix} 0 \\ 3 \\ 22 \\ 21 \\ 19 \\ 16 \end{pmatrix}$$

ATTACHMENT 6



Made by: EF
 Checked by: *[Signature]*
 Approved by: *[Signature]*

Subject: Piñon Ridge
 Job No. 073-81694
 Date: 4/7/2008
 Sheet No. 1 of 4

Case 3 On the leeward slope of the tailings cells (cells B and C), lower portion

Suction factor for the leeward slope of the reservoir:

$$\lambda := 0.55 \quad \text{for the lower portion of the slope}$$

Wind velocity:

$$V := 37.7 \frac{\text{km}}{\text{hr}} \quad (\text{e.g., } 23.4 \text{ mph})$$

Altitude above sea level:

$$z := 1670.3 \text{ m} \quad (\text{e.g., } 5480 \text{ ft})$$

Calculations were performed using the international unit system (SI), since the empirical equations were developed using this unit system.

The mass per unit area of geomembrane required to resist uplift by a wind of velocity V at altitude z above the sea level is defined by:

$$\mu_{GM} := 0.005085 \cdot \lambda \cdot V^2 \cdot \exp(-1.252 \cdot 10^{-4} \cdot z) \quad (\text{eq. 21, Giroud et al. 1995})$$

$$\mu_{GM} = 3.22 \frac{\text{kg}}{\text{m}^2} \quad \text{required geomembrane mass}$$

The maximum wind velocity that the geomembrane can be subject to without being uplifted:

$$\mu_{GM} := 1.431 \frac{\text{kg}}{\text{m}^2} \quad \text{geomembrane mass per unit area (60 mil HDPE)}$$

$$V_{up} := 14.023 \cdot \exp(6.259 \cdot 10^{-5} \cdot z) \cdot \sqrt{\frac{\mu_{GM}}{\lambda}} \quad (\text{eq. 26, Giroud et al. 1995})$$

$$V_{up} = 25.11 \frac{\text{km}}{\text{hr}} \quad (\text{e.g., } 15.6 \text{ mph})$$

The effective suction in the geomembrane is:

$$S_e := 0.050 \cdot \lambda \cdot V^2 \cdot \exp(-1.252 \cdot 10^{-4} \cdot z) - 9.81 \cdot \mu_{GM} \quad (\text{eq. 41, Giroud et al. 1995})$$

$$S_e = 17.67 \text{ Pa} \quad (\text{e.g., } 0.34 \text{ lb/ft}^2)$$

The resultant force of the applied effective suction is equal to:

$$L := 33.6 \text{ m} \quad (\text{e.g., } 110.2 \text{ ft})$$

$$F := S_e \cdot L \quad (\text{eq. 42, Giroud et al. 1995})$$

$$F = 593.77 \frac{\text{N}}{\text{m}} \quad (\text{e.g., } 40.7 \text{ lb/ft})$$

The normalized allowable tension (T_n) is defined as:

$$T_{all} := 22 \frac{\text{kN}}{\text{m}} \quad \text{Break elongation, \%} = 12$$

$$T_n := \frac{T_{all} \cdot 1000}{F} \quad (\text{eq. 48, Giroud et al. 1995})$$

$$T_n = 37.05$$

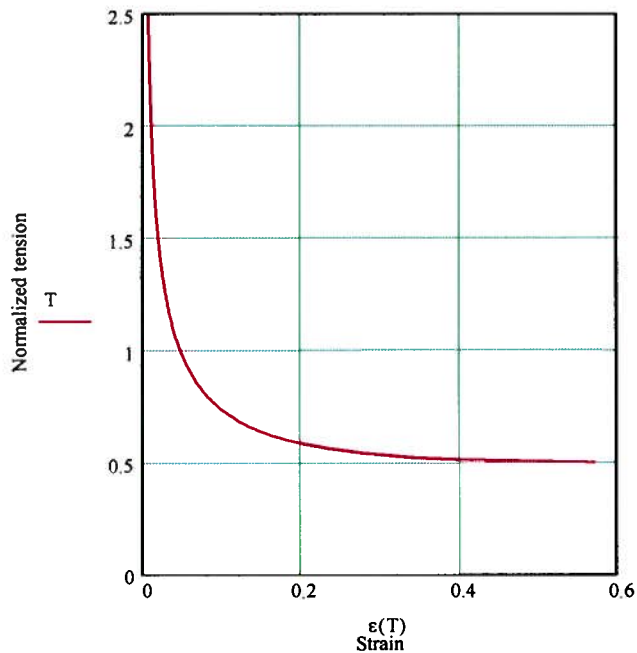

Uplift tension-strain relationship

The determination of tension in the geomembrane is done by trial and error assuming different values for T_{GM} until the calculated strain versus T_{GM} compares with the Geomembrane tension-strain curve.

The strain in the geomembrane is estimated as:

$$T_{GM} := 1200 \frac{\text{N}}{\text{m}} \quad \text{Tension in the geomembrane} \quad (\text{e.g., } 82.2 \text{ lb/ft})$$

$$\varepsilon := \left[\left(\frac{T_{GM} \cdot \text{asin}\left(\frac{F}{2 \cdot T_{GM}}\right)}{F} \right) - 1 \right] \cdot 100 \quad (\text{eq. 47, Giroud et al. 1995})$$

$$\varepsilon = 1.05 \quad \%$$

$$T_{GM} := \frac{T_{GM}}{1000} \quad T_{GM} = 1.2 \quad \frac{KN}{m} \quad (\text{i.e., } 82.2 \text{ ft})$$

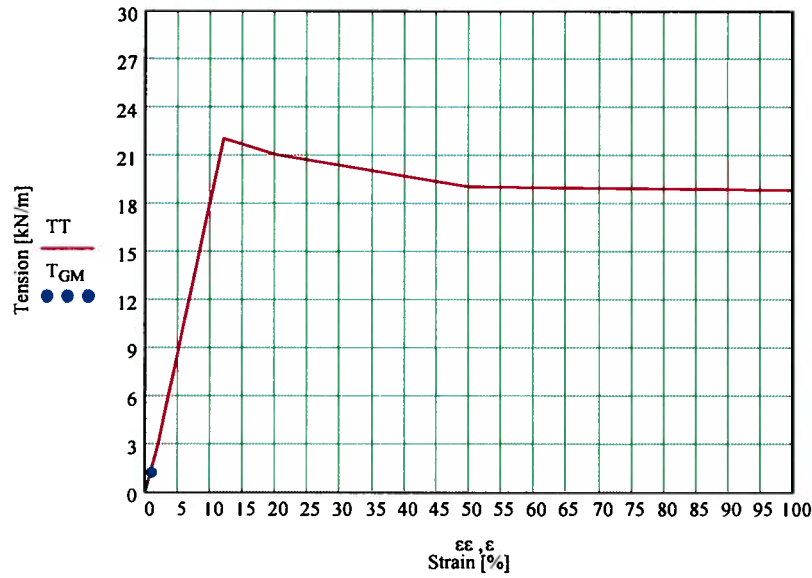

Geomembrane tension-strain curve

The orientation of the geomembrane tension at both extremities of the geomembrane is:

$$T_n := \frac{T_{GM} \cdot 1000}{F}$$

$$T_n = 2.02$$

$$\theta := \text{asin}\left(\frac{1}{2 \cdot T_n}\right) \quad (\text{eq. 56, Giroud et al. 1995})$$

$$\theta = 0.25 \quad \text{radians} \quad (\text{i.e., } 14.3 \text{ degrees})$$

The geomembrane uplift is :

$$u := 0.5 \cdot \tan\left(\frac{\theta}{2}\right) \cdot L \quad (\text{eq. 54, Giroud et al. 1995})$$

$$u = 2.11 \quad \text{m} \quad (\text{i.e., } 6.9 \text{ ft})$$



Made by: EF
Checked by: *JS*
Approved by: *KSM*

Subject: Piñon Ridge
Job No. 073-81694
Date: 4/7/2008
Sheet No. 4 of 4

Plots data

$$\epsilon(T) := 2 \cdot T \cdot \operatorname{asin}\left(\frac{1}{2 \cdot T}\right) - 1$$

$$T := 0.50, 0.51 \dots 2.5$$

$$\epsilon\epsilon := \begin{pmatrix} 0 \\ 2 \\ 12 \\ 20 \\ 50 \\ 800 \end{pmatrix} \quad TT := \begin{pmatrix} 0 \\ 3 \\ 22 \\ 21 \\ 19 \\ 16 \end{pmatrix}$$

ATTACHMENT 7

	Grand Junction Airport	Nucla
year	wind speed (mph)	
1984	16.3	-
1985	18.3	-
1986	22.0	-
1987	14.8	-
1988	18.6	-
1989	17.3	-
1990	17.8	-
1991	18.1	-
1992	17.1	-
1993	17.2	-
1994	19.4	-
1995	16.8	-
1996	17.7	-
1997	18.1	-
1998	18.0	16.4
1999	17.1	18.2
2000	18.8	18.6
2001	19.7	14.6
2002	21.2	17.2
2003	19.8	16.8
2004	19.9	14.3
2005	18.0	14.0
2006	21.9	14.8
2007	23.4	15.1
Maximum W(mph)	23.4	18.6

Wind design 23.4 mph

ATTACHMENT 8

TEXTURED HDPE GEOMEMBRANE

ENGLISH UNITS



Minimum Average Values

Property	Test Method	40 mil	60 mil	80 mil	100 mil
Thickness, mils	ASTM D 5994				
minimum average		38	57	76	95
lowest individual of 8 of 10 readings		36	54	72	90
lowest individual of 10 readings		34	51	68	85
Asperity Height ¹ , mils	GRI GM12	10	10	10	10
Sheet Density, g/cc	ASTM D 1505/D 792	0.940	0.940	0.940	0.940
Tensile Properties²	ASTM D 6693				
1. Yield Strength, lb/in		84	126	168	210
2. Break Strength, lb/in		60	90	120	150
3. Yield Elongation, %		12	12	12	12
4. Break Elongation, %		100	100	100	100
Tear Resistance, lb	ASTM D 1004	28	42	56	70
Puncture Resistance, lb	ASTM D 4833	60	90	120	150
Stress Crack Resistance ³ , hrs	ASTM D 5397 (App.)	300	300	300	300
Carbon Black Content ⁴ , %	ASTM D 1603	2.0 - 3.0	2.0 - 3.0	2.0 - 3.0	2.0 - 3.0
Carbon Black Dispersion	ASTM D 5596	-Note 5-			
Oxidative Induction Time (OIT)					
Standard OIT, minutes	ASTM D 3895	100	100	100	100
Oven Aging at 85°C	ASTM D 5721				
High Pressure OIT - % retained after 90 days	ASTM D 5885	80	80	80	80
UV Resistance ⁶	GRI GM11				
High Pressure OIT ⁷ - % retained after 1600 hrs	ASTM D 5885	50	50	50	50
Seam Properties	ASTM D 6392 (@ 2 in/min)				
1. Shear Strength, lb/in		80	120	160	200
2. Peel Strength, lb/in - Hot Wedge		60	91	121	151
- Extrusion Fillet		52	78	104	130
Roll Dimensions					
1. Width (feet):		23	23	23	23
2. Length (feet)		750	500	375	300
3. Area (square feet):		17,250	11,500	8,625	6,900
4. Gross weight (pounds, approx.)		3,500	3,500	3,470	3,470

1 Of 10 readings; 8 must be \geq 7 mils and lowest individual reading must be \geq 5 mils.

2 Machine direction (MD) and cross machine direction (XMD) average values should be on the basis of 5 test specimens each direction. Yield elongation is calculated using a gauge length of 1.3 inches; Break elongation is calculated using a gauge length of 2.0 inches.

3 The yield stress used to calculate the applied load for the SP-NCTL test should be the mean value via MQC testing.

4 Other methods such as ASTM D 4218 or microwave methods are acceptable if an appropriate correlation can be established.

5 Carbon black dispersion for 10 different views: Nine in Categories 1 and 2 with one allowed in Category 3.

6 The condition of the test should be 20 hr. UV cycle at 75°C followed by 4 hr. condensation at 60°C.

7 UV resistance is based on percent retained value regardless of the original HP-OIT value.

This data is provided for informational purposes only and is not intended as a warranty or guarantee. Poly-Flex, Inc. assumes no responsibility in connection with the use of this data. These values are subject to change without notice. REV.11/06

APPENDIX C-2
ANCHOR TRENCH CAPACITY CALCULATIONS



Subject	Piñon Ridge
Tailings Cell Design	
Geomembrane Anchorage Trench Analysis	

Made by	EF
Checked by	<i>[Signature]</i>
Approved by	<i>[Signature]</i>

Job No	073-81694
Date	02/28/08
Sheet No	1 of 2

OBJECTIVE:

The objective is to evaluate the tensile strength capacity for the anchorage trench of the liner system at the top of the cell side slope with respect to wind uplift forces on the geomembrane.

GIVEN:

- Tailings cell liner anchor trench geometry.
- Geomembrane properties.
- Cell side slope inclination 3H:1V.
- Resultant stress in the geomembrane due to wind uplift (from calculation sheet “Geomembrane wind uplift analysis”):

Maximum tension in the geomembrane = 151 lb/ft

Angle of the force with respect to the side slope surface = 17 degrees

GEOMETRY:

- The proposed geometry for the geomembrane anchor trench is presented in Figure 1.

MATERIAL PROPERTIES:

- Geomembrane (Textured HDPE geomembrane)
 - Density 58.7 lb/ft³ (i.e., 0.94 g/cm³)
 - Thickness 60 mil
 - Yield Strength 126 lb/in
- Soil properties (Trench fill)
 - Density 115 lb/ft³
 - Friction angle 30°
- Peak interface friction angle of 21° for 60 mil textured HDPE geomembrane versus geocomposite (see Attachment 2).

METHOD:

The tensile strength capacity of the anchor trench is evaluated using the methodology presented by Koerner (1998). The methodology is based on a static equilibrium analysis of the problem. Figure 2 shows the free body diagram for the geomembrane considered to develop the analytical equations.

The proposed analytical equation for determination of the allowable geomembrane tension from the anchor trench is:



Subject	Piñon Ridge
	Tailings Cell Design
	Geomembrane Anchorage Trench Analysis

Made by	EF
Checked by	<i>[Signature]</i>
Approved by	<i>[Signature]</i>

Job No	073-81694
Date	02/28/08
Sheet No	2 of 2

$$\sum F_x = 0$$

$$T_{allow} \cos \beta = F_{U\sigma} + F_{L\sigma} + F_{LT} - P_A + P_P$$

Where:

T_{allow} = allowable force in geomembrane = $\sigma_{allow} t$, where σ_{allow} = allowable stress in geomembrane and t = thickness of geomembrane;

β = tension force angle;

$F_{U\sigma}$ = shear force above geomembrane due to cover soil;

$F_{L\sigma}$ = shear force below geomembrane due to cover soil;

F_{LT} = shear force below geomembrane due to vertical component of T_{allow} ;

P_A = active earth pressure against the backfill side of the anchor trench; and

P_P = passive earth pressure against the in-situ side of the anchor trench.

The shear force below the geomembrane due to vertical component of T_{allow} is defined as:

$$F_{LT} = T_{allow} \sin \beta \tan \delta$$

ASSUMPTIONS:

- The problem is assumed to be two dimensional; and
- The tensile characteristics of the geomembrane do not depend on temperature.

CALCULATIONS:

The calculations are presented in Attachment 1. The cross section of the geomembrane runout section with anchor trench and related stress and forces involved in the analysis is presented in Figure 2.

RESULTS:

From the calculation in Attachment 1, the allowable force in the geomembrane that can be resisted with a tension applied at an angle of 17 degrees with respect to the slope is 1302 lb/ft.

CONCLUSIONS:

According to these analyses the anchor trench will provide sufficient resistance to the forces developed in the geomembrane due to wind uplift. The maximum force to be experienced by the geomembrane was calculated to be 151 lb/ft while the anchor trench provides an allowable resistance force equal to 1302 lb/ft, providing a factor of safety of 8.6.

REFERENCES:

Koerner, R. M. (1998). *Designing with geosynthetics*, Prentice Hall, Upper Saddle River, N.J.

FIGURES

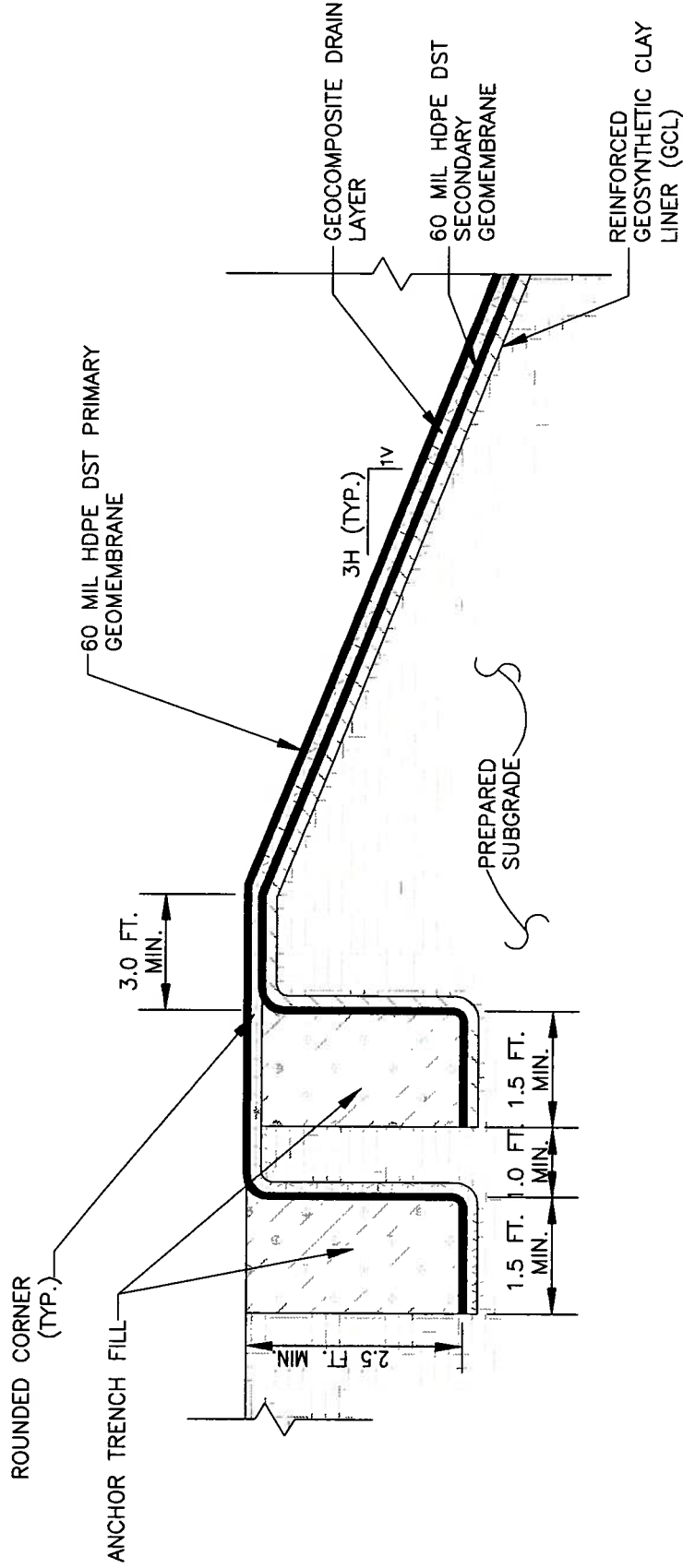

TAILINGS CELL LINER ANCHOR TRENCH DETAIL

TITLE

DRAWN EF
 CHECKED [Signature]
 REVIEWED [Signature]

DATE FEBRUARY 12, 2008
 SCALE N.T.S.
 FILE NO.

JOB NO. 073-81694
 DWG. NO.
 FIGURE NO. 1



CLIENT/PROJECT
 ENERGY FUELS RESOURCES CORPORATION
 PIÑON RIDGE PROJECT - TAILINGS CELLS DESIGN
 MONTROSE COUNTY, COLORADO

Geomembrane

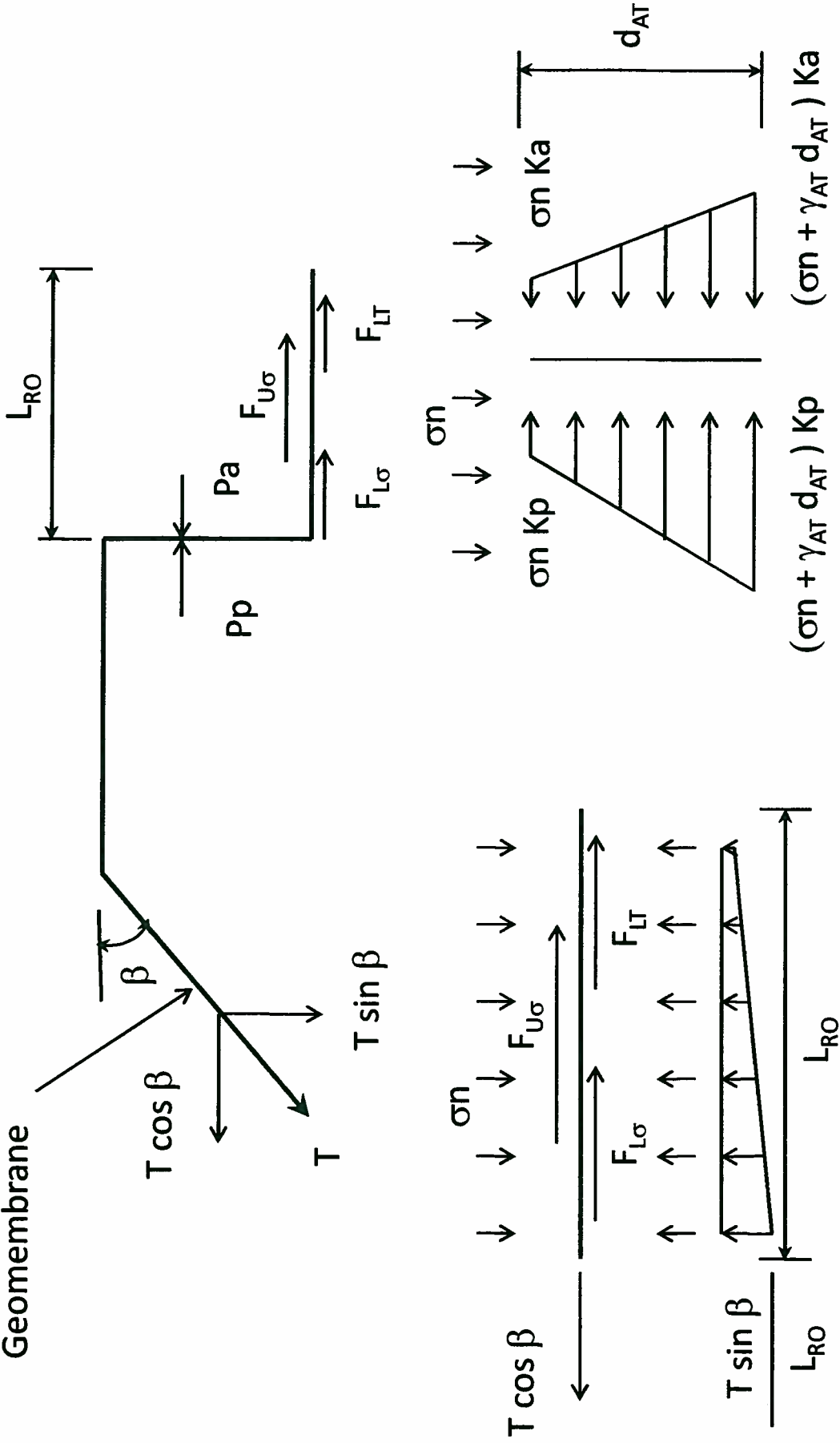

TITLE

GEOMEMBRANE FREE BODY DIAGRAM

Golder Associates
 Denver, Colorado

CLIENT/PROJECT
 ENERGY FUELS RESOURCES CORPORATION
 PIÑON RIDGE PROJECT - TAILINGS CELLS DESIGN
 MONTROSE COUNTY, COLORADO

DRAWN EF
 CHECKED [Signature]
 REVIEWED [Signature]

DATE FEBRUARY 12 2008
 SCALE N.T.S.

JOB NO. 073-81694
 DWG. NO.
 FILE NO.
 FIGURE NO. 2

ATTACHMENT 1



Made by: EF
Checked by: *[Signature]*
Approved by: *[Signature]*

Subject: Piñon Ridge
Job No. 073-81694
Date: 2/28/2008
Sheet No. 1 of 2

Geomembrane Anchor Trench Analysis

Shear force above geomembrane due to trench fill ($F_{U\sigma}$):

$$\gamma_{AT} := 115 \cdot \frac{\text{lb}}{\text{ft}^3} \quad \text{Unit weight of anchor trench fill}$$

$$d_{AT} := 2.5 \cdot \text{ft} \quad \text{Depth of anchor trench}$$

$$\sigma_n := \gamma_{AT} \cdot d_{AT}$$

$$\sigma_n = 287.5 \frac{\text{lb}}{\text{ft}^2}$$

$$\delta := 21 \text{deg} \quad \text{Interface friction angle (weakest interface)}$$

$$L_{RO} := 1.5 \cdot \text{ft} \quad \text{Length of anchor trench}$$

$$F_{U\sigma} := \sigma_n \cdot \tan(\delta) \cdot L_{RO}$$

$$F_{U\sigma} = 165.54 \frac{\text{lb}}{\text{ft}}$$

Shear force below geomembrane due to trench fill ($F_{L\sigma}$):

$$F_{L\sigma} := \sigma_n \cdot \tan(\delta) \cdot L_{RO}$$

$$F_{L\sigma} = 165.54 \frac{\text{lb}}{\text{ft}}$$

Active earth pressure (P_A):

$$\phi := 30 \text{deg} \quad \text{friction angle of soil}$$

$$K_A := \left[\tan \left(\left(45 \text{deg} - \frac{\phi}{2} \right) \right) \right]^2 \quad \text{Active earth pressure coefficient}$$

$$K_A = 0.33$$

$$P_A := 0.5 \cdot \gamma_{AT} \cdot d_{AT}^2 \cdot K_A$$

$$P_A = 119.79 \frac{\text{lb}}{\text{ft}}$$

Passive earth pressure (K_p):

$$K_p := \left(\tan \left(45 \text{deg} + \frac{\phi}{2} \right) \right)^2 \quad \text{Passive earth pressure coefficient}$$

$$K_p = 3$$

$$P_p := 0.5 \cdot \gamma_{AT} \cdot d_{AT}^2 \cdot K_p$$

$$P_p = 1078.13 \frac{\text{lb}}{\text{ft}}$$

Allowable force in geomembrane (T_{allow}):

$$\theta := 17 \text{deg} \quad \text{angle of the resultant tension in the geomembrane}$$

$$\alpha := \text{atan} \left(\frac{1}{3} \right) \quad \alpha = 18.43 \text{deg} \quad \text{angle of slope (i.e., 3H:1V)}$$

$$\beta := \alpha - \theta$$

$$\beta = 1.43 \text{deg} \quad \text{Force angle in the geomembrane - slope angle}$$

$$T_{\text{allow}} := \frac{(F_{U\sigma} + F_{L\sigma} - P_A + P_p)}{\cos(\beta) - \sin(\beta) \cdot \tan(\delta)}$$

$$T_{\text{allow}} = 1302.34 \frac{\text{lb}}{\text{ft}}$$

ATTACHMENT 2

DIRECT SHEAR TEST RESULTS

ASTM D5321

PROJECT NAME: ENERGY FUELS/GEOTECH PINON RIDGE/CO
 SAMPLE NUMBER: 1 (GM vs GC)

INTERFACE TESTED: 60 mil TEXTURED HDPE GEOMEMBRANE vs TEXDRAIN 250 DS 6 GEOCOMPOSITE
 TEST CONDITIONS: INTERFACES WETTED, CONSOLIDATED 15 min AT NORMAL LOAD
 SHEAR RATE: 0.2 in/min
 SUBSTRATE: TEXTURED RIGID PLATES

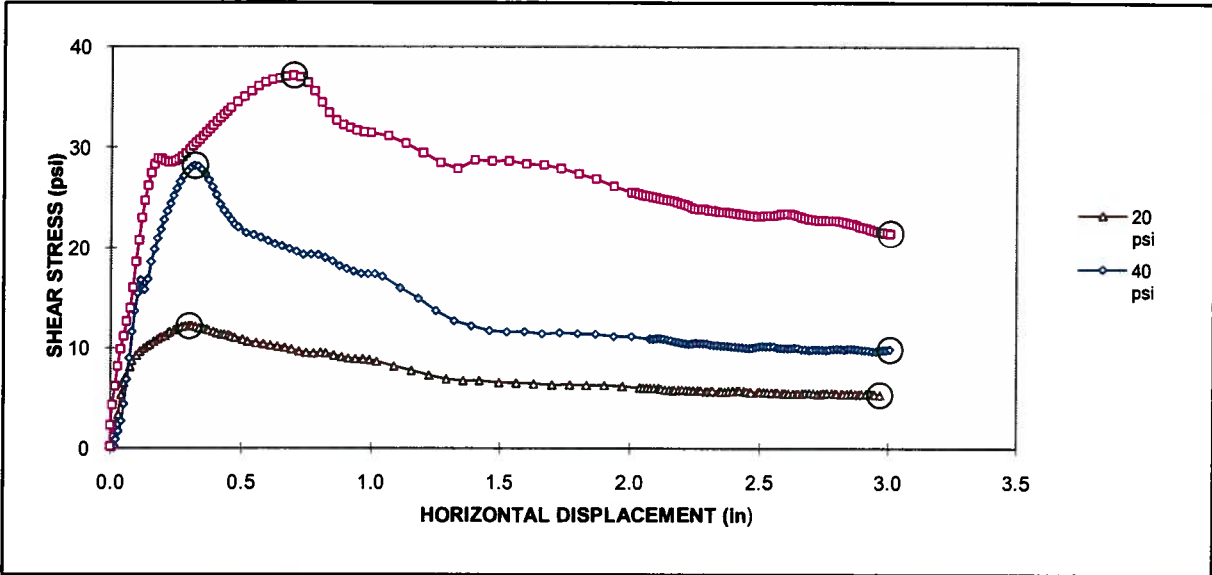

Normal Stress (psi)	Shear Stress		Peak		Residual	
	Peak ¹ (psi)	Residual (psi)	Friction Angle	Adhesion ² (psi)	Friction Angle	Adhesion ² (psi)
20	12.2	5.3	21.2	7.7	14.8	0.0
40	28.2	9.9				
80	37.1	21.5				

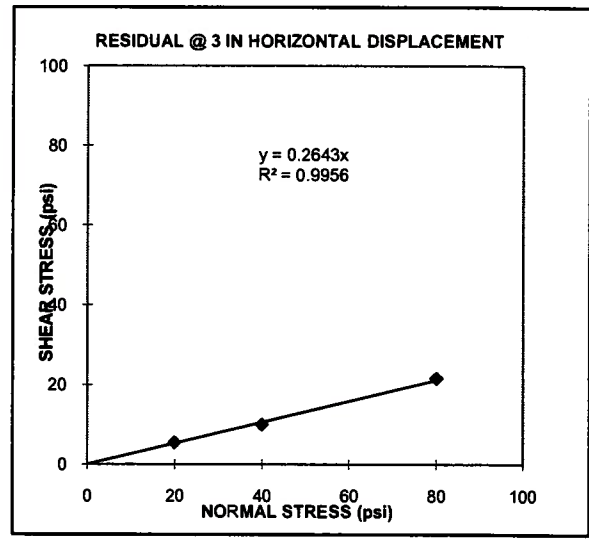
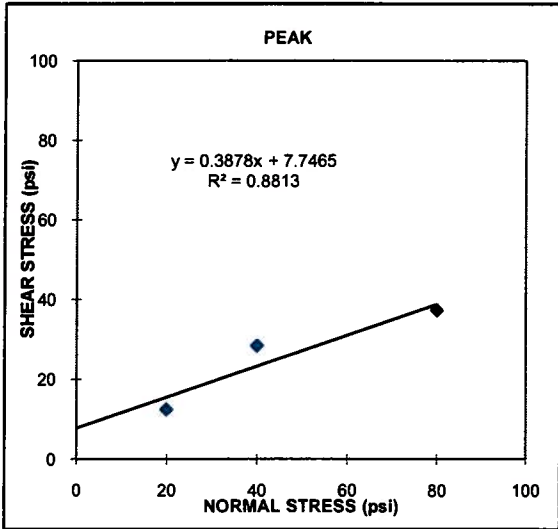

Observations After Test

- 20 psi: Shearing occurred at the interface between the Geomembrane and the Geocomposite
- 40 psi: Shearing occurred at the interface between the Geomembrane and the Geocomposite
- 80 psi: Shearing occurred at the interface between the Geomembrane and the Geocomposite

(1) The peak shear stresses for 20, 40, and 80 psi normal stresses were chosen at 0.300, 0.319, and 0.693 in horizontal displacements, respectively.
 (2) The adhesion value is based on the "best-fit" line which may not show true adhesion.

APPENDIX C-3

DESIGN OF GEOMEMBRANE BUTTRESSING



Subject	Piñon Ridge Project
	Tailings Cell Design
	Design of Geomembrane Anchorage Against Wind Action

Made by	EF
Checked by	<i>[Signature]</i>
Approved by	<i>[Signature]</i>

Job No	073-81694
Date	04/07/08
Sheet No	1 of 3

OBJECTIVE:

Calculate the required cross-sectional dimensions of the soil mass in the anchor bench to provide anchorage to the geomembrane against wind action.

GIVEN:

- Calculated tensions in the geomembrane produced by wind uplift considering a wind equal to 23.4 miles per hour (see Table 1, and Golder calculations titled “Geomembrane Wind Uplift Analysis”).
- Tailings cells side slopes geometry.
- Weakest interface in the design has an interface friction angle of 20° for GCL versus textured HDPE.

GEOMETRY:

- The geometry of the side slopes and benches are shown in Figure 1.

MATERIAL PROPERTIES:

- Buttress fill
 - Density 110 lb/ft³ (Assumed)

METHOD:

The analysis of the required cross-sectional dimensions of the soil mass in the anchor bench is performed according to Giroud et al. (1999). This method is based on a static analysis of the recurring forces acting in the anchor bench. Figure 2 shows a free body diagram of the anchor bench that is used to develop the equation to design the geomembrane anchorage against wind action.

The mechanism of failure considered in the analysis of the anchor bench is selected as a function of the magnitude of the resulting forces;

- Anchor failure by sliding in the downslope direction if $T_{dH} > T_{uH}$;
- Anchor failure by sliding in the upslope direction; and if $T_{dH} < T_{uH}$;
- Anchor failure by uplifting $T_{dH} = T_{uH}$.

Table 1 summarizes the considered resultant forces in the geomembrane due to wind action.

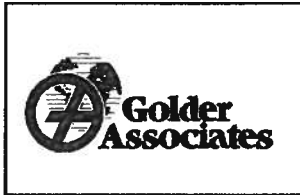

Subject	Piñon Ridge Project
	Tailings Cell Design
	Design of Geomembrane Anchorage Against Wind Action

Made by	EF
Checked by	<i>[Signature]</i>
Approved by	<i>KAM</i>

Job No	073-81694
Date	04/07/08
Sheet No	2 of 3

Table 1. Resultant forces in the geomembrane due to wind action

		length (ft)	Strain (%)	u (ft)	T (lb/ft)	θ (degrees)
Cells A,B and C	Bottom reservoir	253	1.1	16.6	93	14.6
Cells A1 and A2 Slopeside	upper portion (0.5L) ¹	131	1.5	9.8	151	17.0
	lower portion (0.5L) ¹	131	1.1	8.5	82	14.8
Cells B and C Slopeside	upper portion (0.25L) ¹	66	1.1	4.2	103	14.6
	middle portion (0.33L) ¹	87	1.2	5.9	89	15.5
	lower portion (0.42L) ¹	110	1.0	6.9	82	14.3

¹ L = total length of the slope

ASSUMPTIONS:

- The geomembrane is continuous through the anchor bench;
- The bottom of the tailing cells is assumed to have a 0.0% slope; and
- A factor of safety equal to 1.5 is used.

CALCULATIONS:

The calculations are presented in Attachment 1.



RESULTS:

Table 2 summarizes the results of the calculation presented in Attachment 1:

Tailing Cell	Bench location	Required Soil Area (ft ²)
A1 and A2	Midheight bench	2.7
	Toe of slope	1.7
B and D	Upper bench	0.9
	Middle bench	1.1
	Toe of slope	1.7



Subject Piñon Ridge Project
Tailings Cell Design
Design of Geomembrane Anchorage Against Wind Action

Made by EF
Checked by 
Approved by 

Job No 073-81694
Date 04/07/08
Sheet No 3 of 3

CONCLUSIONS:

The maximum cross sectional area of buttress fill required to prevent geomembrane uplift at the anchor benches is 2.7 ft². Therefore, two 18-inch diameter HDPE pipes filled with sand or grout placed at the anchor benches along the sideslope and one 18-inch diameter HDPE pipe filled with sand or grout placed at the anchor toe will provide sufficient anchorage to the geomembrane against wind action.

REFERENCES:

Giroud, J. P., Gleason, M. H., and Zornberg, J. G. (1999). "Design of geomembrane anchorage against wind action." *Geosynthetics International*, 6(6).

FIGURES

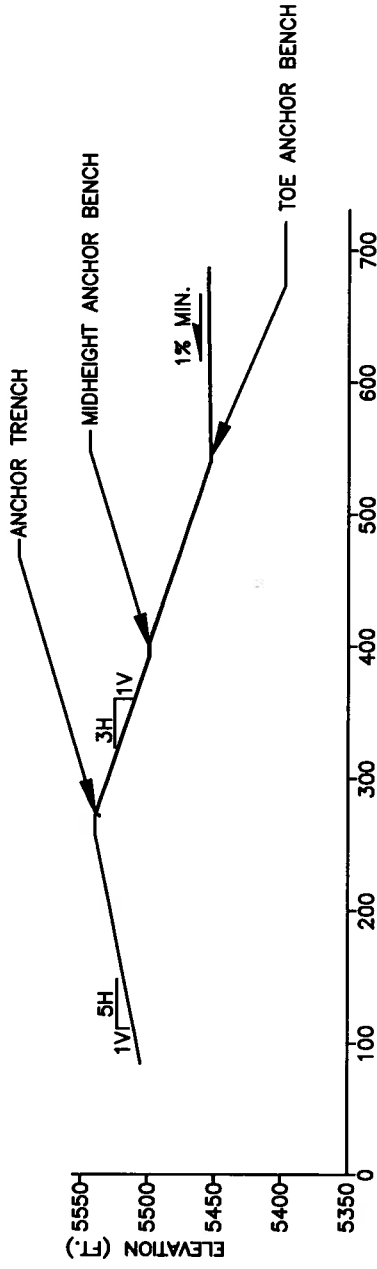

TAILING CELLS A1 AND A2 SLOPE SIDE CROSS SECTION

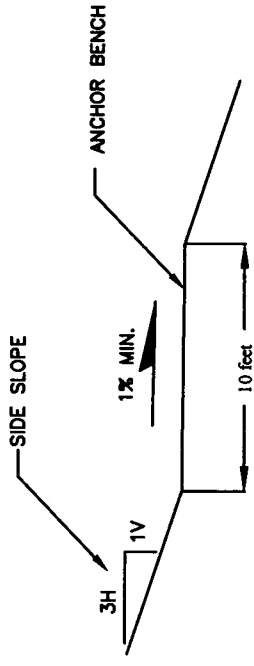

ANCHOR BENCH DETAIL

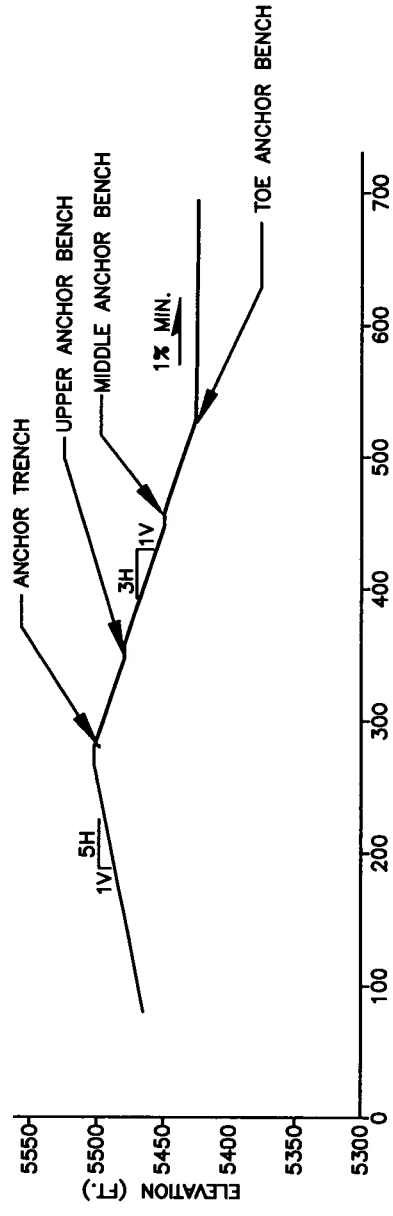

TAILING CELLS B AND C SLOPE SIDE CROSS SECTION



Denver, Colorado

ENERGY FUELS RESOURCES CORPORATION
 PIÑON RIDGE PROJECT - TAILINGS CELLS DESIGN
 MONTROSE COUNTY, COLORADO

TAILINGS CELLS SLOPE DETAILS

CLIENT/PROJECT	DRAWN	EF	DATE	FEBRUARY 22, 2008	JOB NO.	073-81694
	CHECKED	[Signature]	SCALE	N.T.S.	DWG NO.	
	REVIEWED	[Signature]	FILE NO.	Figures-anchorage.dwg	FIGURE NO.	1
	TITLE					

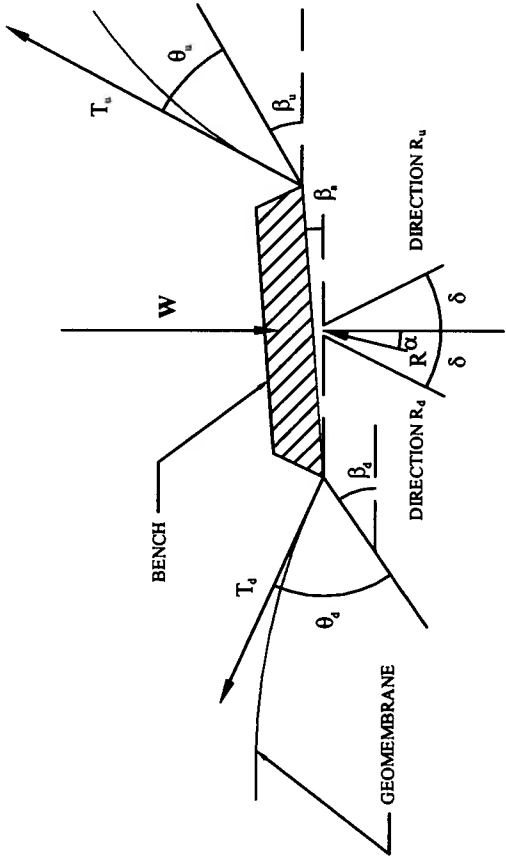

FREE BODY DIAGRAM

Reference
Giroud et al. (1999)

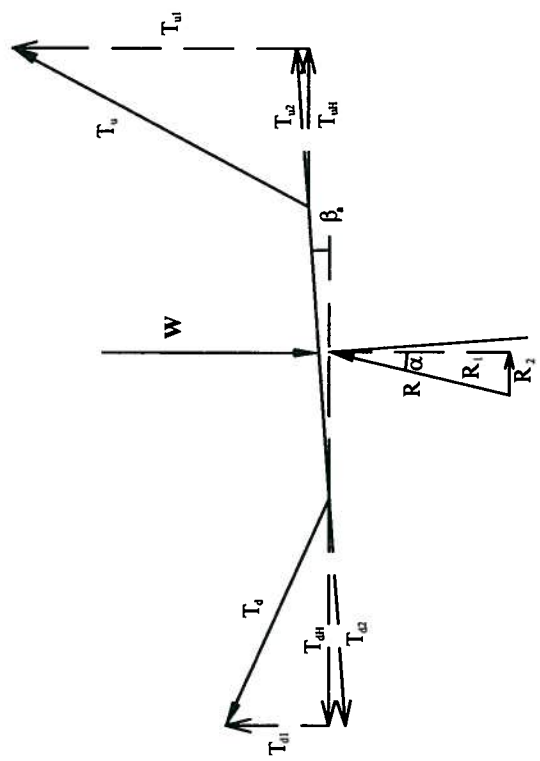

DECOMPOSITION OF THE
FORCES ACTING ON AN
ANCHOR BENCH

 Golder Associates Denver, Colorado		FORCES ACTING ON AN ANCHOR BENCH	
CLIENT/PROJECT	ENERGY FUELS RESOURCES CORPORATION PIÑON RIDGE PROJECT - TAILINGS CELLS DESIGN MONTROSE COUNTY, COLORADO	DRAWN	EF
		DATE	FEBRUARY 22, 2008
		SCALE	N.T.S.
		FILE NO.	Figures-anchorage.dwg
		CHECKED	<i>[Signature]</i>
		REVIEWED	<i>[Signature]</i>
		JOB NO.	073-81694
		DWG. NO.	
		FIGURE NO.	2

ATTACHMENT 1

Design of Geomembrane Anchorage Against Wind Action

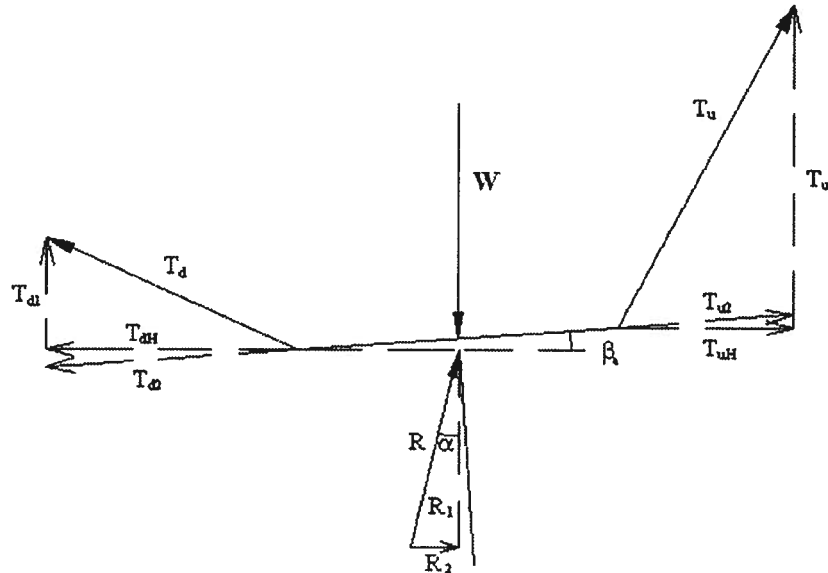

Cells A1 and A2

Midheight bench

$$T_d := 82.2 \frac{\text{lb}}{\text{ft}} \quad \text{downslope tension}$$

$$\theta_d := 14.8 \text{ degrees} \quad \text{angle of downslope tension}$$

$$T_u := 150.8 \frac{\text{lb}}{\text{ft}} \quad \text{upslope tension}$$

$$\theta_u := 17 \text{ degrees} \quad \text{angle of upslope tension}$$

$$\beta_d := 18.435 \text{ degrees} \quad \text{slope inclination 3H:1V}$$

$$\beta_u := \beta_d$$

$$\beta_a := 0.573 \text{ degrees} \quad \text{bench inclination}$$

$$\delta := 20 \text{ degrees} \quad \text{interface friction angle soil/geomembrane}$$



Made by: EF
Checked by: *JZ*
Approved by: *EFM*

Subject: Piñon Ridge Project
Job No.: 073-81694
Date: 4/7/2008
Sheet No. 2 of 10

Sliding direction:

Horizontal projections

$$T_{dH} := T_d \cdot \cos \left[\left(\theta_d - \beta_d \right) \cdot \frac{\pi}{180} \right]$$

$$T_{dH} = 82 \quad \frac{\text{lb}}{\text{ft}}$$

$$T_{uH} := T_u \cdot \cos \left[\left(\theta_u + \beta_u \right) \cdot \frac{\pi}{180} \right]$$

$$T_{uH} = 122.9 \quad \frac{\text{lb}}{\text{ft}}$$

Because $T_{uH} > T_{dH}$, anchor failure by sliding in the upslope direction will be considered.

The required soil weight (W) per foot width is determined by the following equation:

$$W_{\min} := \frac{\left[-T_d \cdot \cos \left[\left(-\theta_d + \beta_d + \delta + \beta_a \right) \cdot \frac{\pi}{180} \right] + T_u \cdot \cos \left[\left(\theta_u + \beta_u - \delta - \beta_a \right) \cdot \frac{\pi}{180} \right] \right]}{\sin \left[\left(\delta + \beta_a \right) \cdot \frac{\pi}{180} \right]}$$

$$W_{\min} = 201.4 \quad \frac{\text{lb}}{\text{ft}}$$

$$W_{\text{factored}} := W_{\min} \cdot 1.5$$

$$W_{\text{factored}} = 302.1 \quad \frac{\text{lb}}{\text{ft}}$$

$$\gamma := 110 \quad \frac{\text{lb}}{\text{ft}^3}$$



Made by: EF
Checked by: *JS*
Approved by: *HM*

Subject: Piñon Ridge Project
Job No.: 073-81694
Date: 4/7/2008
Sheet No. 3 of 10

$$A_{\text{req}} := \frac{W_{\text{factored}}}{\gamma}$$

$$A_{\text{req}} = 2.7 \frac{\text{ft}^2}{\text{ft}}$$

At the toe of the side slope

$$T_d := 92.5 \frac{\text{lb}}{\text{ft}} \quad \text{downslope tension}$$

$$\theta_d := 14.9 \text{ degrees} \quad \text{angle of downslope tension}$$

$$T_u := 82.2 \frac{\text{lb}}{\text{ft}} \quad \text{upslope tension}$$

$$\theta_u := 14.8 \text{ degrees} \quad \text{angle of upslope tension}$$

$$\beta_d := 0 \quad \text{degrees} \quad \text{at the toe of the side slope}$$

$$\beta_u := 18.435$$

$$\beta_a := 0 \quad \text{degrees} \quad \text{at the toe of the side slope}$$

$$\delta := 20 \text{ degrees} \quad \text{interface friction angle soil/geomembrane}$$

Sliding direction:

Horizontal projections

$$T_{dH} := T_d \cdot \cos \left[\left(\theta_d - \beta_d \right) \cdot \frac{\pi}{180} \right]$$

$$T_{dH} = 89.4 \frac{\text{lb}}{\text{ft}}$$



Made by: EF
Checked by: *JF*
Approved by: *EFM*

Subject: Piñon Ridge Project
Job No.: 073-81694
Date: 4/7/2008
Sheet No. 4 of 10

$$T_{uH} := T_u \cdot \cos \left[\left(\theta_u + \beta_u \right) \cdot \frac{\pi}{180} \right]$$

$$T_{uH} = 68.8 \quad \frac{\text{lb}}{\text{ft}}$$

Because $T_{dH} > T_{uH}$, anchor failure by sliding in the downslope direction will be considered.

The required soil weight (W) per foot width is determined by the following equation:

$$W_{\min} := \frac{\left[T_d \cdot \cos \left[\left(\theta_d - \beta_d - \delta + \beta_a \right) \cdot \frac{\pi}{180} \right] - T_u \cdot \cos \left[\left(\theta_u + \beta_u + \delta - \beta_a \right) \cdot \frac{\pi}{180} \right] \right]}{\sin \left[\left(\delta - \beta_a \right) \cdot \frac{\pi}{180} \right]}$$

$$W_{\min} = 125.5 \quad \frac{\text{lb}}{\text{ft}}$$

$$W_{\text{factored}} := W_{\min} \cdot 1.5$$

$$W_{\text{factored}} = 188.3 \quad \frac{\text{lb}}{\text{ft}}$$

$$\gamma := 110 \quad \frac{\text{lb}}{\text{ft}^3}$$

$$A_{\text{req}} := \frac{W_{\text{factored}}}{\gamma}$$

$$A_{\text{req}} = 1.7 \quad \frac{\text{ft}^2}{\text{ft}}$$



Made by: EF
Checked by: *JS*
Approved by: *KSM*

Subject: Piñon Ridge Project
Job No.: 073-81694
Date: 4/7/2008
Sheet No. 5 of 10

Cells B and C

Upper Bench

$$T_d := 89.1 \frac{\text{lb}}{\text{ft}} \quad \text{downslope tension}$$

$$\theta_d := 15.5 \text{ degrees} \quad \text{angle of downslope tension}$$

$$T_u := 102.8 \frac{\text{lb}}{\text{ft}} \quad \text{upslope tension}$$

$$\theta_u := 14.6 \text{ degrees} \quad \text{angle of upslope tension}$$

$$\beta_d := 18.435 \text{ degrees} \quad \text{slope inclination 3H:1V}$$

$$\beta_u := \beta_d$$

$$\beta_a := 0.573 \text{ degrees} \quad \text{bench inclination}$$

$$\delta := 20 \text{ degrees} \quad \text{interface friction angle soil/geomembrane}$$

Sliding direction:

Horizontal projections

$$T_{dH} := T_d \cdot \cos \left[\left(\theta_d - \beta_d \right) \cdot \frac{\pi}{180} \right]$$

$$T_{dH} = 89 \frac{\text{lb}}{\text{ft}}$$

$$T_{uH} := T_u \cdot \cos \left[\left(\theta_u + \beta_u \right) \cdot \frac{\pi}{180} \right]$$

$$T_{uH} = 86.2 \frac{\text{lb}}{\text{ft}}$$



Made by: EF
Checked by: *JE*
Approved by: *RAM*

Subject: Pifion Ridge Project
Job No.: 073-81694
Date: 4/7/2008
Sheet No. 6 of 10

Because $T_{dH} > T_{uH}$, the anchor failure by sliding in the downslope direction will be considered.

The required soil weight (W) per foot width is determined by the following equation:

$$W_{\min} := \frac{\left[T_d \cdot \cos \left[\left(-\theta_d + \beta_d - \delta + \beta_a \right) \cdot \frac{\pi}{180} \right] - T_u \cdot \cos \left[\left(\theta_u + \beta_u + \delta - \beta_a \right) \cdot \frac{\pi}{180} \right] \right]}{\sin \left[\left(\delta - \beta_a \right) \cdot \frac{\pi}{180} \right]}$$

$$W_{\min} = 68.5 \quad \frac{\text{lb}}{\text{ft}}$$

$$W_{\text{factored}} := W_{\min} \cdot 1.5$$

$$W_{\text{factored}} = 102.8 \quad \frac{\text{lb}}{\text{ft}}$$

$$\gamma := 110 \quad \frac{\text{lb}}{\text{ft}^3}$$

$$A_{\text{req}} := \frac{W_{\text{factored}}}{\gamma}$$

$$A_{\text{req}} = 0.9 \quad \frac{\text{ft}^2}{\text{ft}}$$



Made by: EF
Checked by: *JS*
Approved by: *KJM*

Subject: Piñon Ridge Project
Job No.: 073-81694
Date: 4/7/2008
Sheet No. 7 of 10

Middle Bench

$$T_d := 82.2 \frac{\text{lb}}{\text{ft}} \quad \text{downslope tension}$$

$$\theta_d := 14.3 \text{ degrees} \quad \text{angle of downslope tension}$$

$$T_u := 89.1 \frac{\text{lb}}{\text{ft}} \quad \text{upslope tension}$$

$$\theta_u := 15.5 \text{ degrees} \quad \text{angle of upslope tension}$$

$$\beta_d := 18.435 \text{ degrees} \quad \text{slope inclination 3H:1V}$$

$$\beta_u := \beta_d$$

$$\beta_a := 0.573 \text{ degrees} \quad \text{bench inclination}$$

$$\delta := 20 \text{ degrees} \quad \text{interface friction angle soil/geomembrane}$$

Sliding direction:

Horizontal projections

$$T_{dH} := T_d \cdot \cos \left[(\theta_d - \beta_d) \cdot \frac{\pi}{180} \right]$$

$$T_{dH} = 82 \frac{\text{lb}}{\text{ft}}$$

$$T_{uH} := T_u \cdot \cos \left[(\theta_u + \beta_u) \cdot \frac{\pi}{180} \right]$$

$$T_{uH} = 73.9 \frac{\text{lb}}{\text{ft}}$$



Made by: EF
Checked by: *JE*
Approved by: *KAM*

Subject: Pifion Ridge Project
Job No.: 073-81694
Date: 4/7/2008
Sheet No. 8 of 10

Because $T_{dH} > T_{uH}$, anchor failure by sliding in the downslope direction will be considered.

The required soil weight (W) per foot width is determined by the following equation:

$$W_{\min} := \frac{\left[T_d \cdot \cos \left[\left(-\theta_d + \beta_d - \delta + \beta_a \right) \cdot \frac{\pi}{180} \right] - T_u \cdot \cos \left[\left(\theta_u + \beta_u + \delta - \beta_a \right) \cdot \frac{\pi}{180} \right] \right]}{\sin \left[\left(\delta - \beta_a \right) \cdot \frac{\pi}{180} \right]}$$

$$W_{\min} = 78.5 \quad \frac{\text{lb}}{\text{ft}}$$

$$W_{\text{factored}} := W_{\min} \cdot 1.5$$

$$W_{\text{factored}} = 117.8 \quad \frac{\text{lb}}{\text{ft}}$$

$$\gamma := 110 \quad \frac{\text{lb}}{\text{ft}^3}$$

$$A_{\text{req}} := \frac{W_{\text{factored}}}{\gamma}$$

$$A_{\text{req}} = 1.1 \quad \frac{\text{ft}^2}{\text{ft}}$$



Made by: EF
Checked by: *JS*
Approved by: *KAN*

Subject: Piñon Ridge Project
Job No.: 073-81694
Date: 4/7/2008
Sheet No. 9 of 10

At the toe of the side slope

$$T_d := 92.5 \frac{\text{lb}}{\text{ft}} \quad \text{downslope tension}$$

$$\theta_d := 15.5 \text{ degrees} \quad \text{angle of downslope tension}$$

$$T_u := 82.2 \frac{\text{lb}}{\text{ft}} \quad \text{upslope tension}$$

$$\theta_u := 14.3 \text{ degrees} \quad \text{angle of upslope tension}$$

$$\beta_d := 0 \quad \text{degrees} \quad \text{at the toe of the side slope}$$

$$\beta_u := 18.435$$

$$\beta_a := 0 \quad \text{degrees} \quad \text{at the toe of the side slope}$$

$$\delta := 20 \text{ degrees} \quad \text{interface friction angle soil/geomembrane}$$

Sliding direction:

Horizontal projections

$$T_{dH} := T_d \cdot \cos \left[\left(\theta_d - \beta_d \right) \cdot \frac{\pi}{180} \right]$$

$$T_{dH} = 89.1 \frac{\text{lb}}{\text{ft}}$$

$$T_{uH} := T_u \cdot \cos \left[\left(\theta_u + \beta_u \right) \cdot \frac{\pi}{180} \right]$$

$$T_{uH} = 69.1 \frac{\text{lb}}{\text{ft}}$$



Made by: EF
Checked by: JZ
Approved by: JZ

Subject: Piñon Ridge Project
Job No.: 073-81694
Date: 4/7/2008
Sheet No. 10 of 10

Because $T_{dH} > T_{uH}$, the anchor failure by sliding in the downslope direction will be considered.

The required soil weight (W) per foot width is determined by the following equation:

$$W_{\min} := \frac{\left[T_d \cdot \cos \left[\left(\theta_d - \beta_d - \delta + \beta_a \right) \cdot \frac{\pi}{180} \right] - T_u \cdot \cos \left[\left(\theta_u + \beta_u + \delta - \beta_a \right) \cdot \frac{\pi}{180} \right] \right]}{\sin \left[\left(\delta - \beta_a \right) \cdot \frac{\pi}{180} \right]}$$

$$W_{\min} = 124.1 \quad \frac{\text{lb}}{\text{ft}}$$

$$W_{\text{factored}} := W_{\min} \cdot 1.5$$

$$W_{\text{factored}} = 186.1 \quad \frac{\text{lb}}{\text{ft}}$$

$$\gamma := 110 \quad \frac{\text{lb}}{\text{ft}^3}$$

$$A_{\text{req}} := \frac{W_{\text{factored}}}{\gamma}$$

$$A_{\text{req}} = 1.7 \quad \frac{\text{ft}^2}{\text{ft}}$$

APPENDIX D
TAILINGS UNDERDRAIN SYSTEM DESIGN

APPENDIX D

TAILINGS UNDERDRAIN SYSTEM DESIGN

This appendix presents analyses related to design of the tailings underdrain system. Appendix D-1 presents filter compatibility analysis for design of the coarse-grained underdrain fill materials which will be in contact with tailings materials, and Appendix D-2 presents riser pipe and collection pipe stability (i.e., crushing/deformation) calculations.

FILTER COMPATIBILITY ANALYSES

Filter compatibility analyses were conducted for use in design of the soil filter between the tailings material and the perforated underdrain collection pipes. Due to the fine-grained nature of the tailings materials, a two layer filter system is required.

The analyses provide an acceptable gradation range (filter band) for the filter materials, using the method outlined in NRCS (1994). Since no onsite soils meet the filter band criteria, use of ASTM C-33 Fine Aggregate is recommended for the Fine Underdrain Fill layer (between the tailings materials and coarse aggregate filter) and ASTM C-33 Size 8 Coarse Aggregate is recommended for the Coarse Underdrain Fill (between the fine aggregate and the perforated underdrain collection pipes). These materials were chosen based on their standard availability, but other soil gradations falling within the design filter bands would also be acceptable.

PIPE CRUSHING ANALYSES

Two underdrain riser pipes are provided within each underdrain sump to add redundancy to the system. The risers consist of 10-inch diameter, SDR-11 high density polyethylene (HDPE) pipes. The lower ends of the pipes are slotted in the sump area to provide solution access into the risers. Recovered solutions will be returned to the mill circuit. The HDPE underdrain riser pipes are designed according to the modified Burns & Richard (1964) method (Lupo, 2001) to resist crushing and wall buckling due to the anticipated loading associated with the maximum height of overlying tailings. The maximum vertical and horizontal strains calculated for the riser pipes are 1.9 percent and -2.2 percent, respectively.

Similar calculations were performed for the underdrain collection pipes, consisting of 8-inch diameter, ADS N-12 corrugated pipe. The collection pipes are slotted and located in trenches backfilled with a coarse filter material, designed to convey recovered solution to the underdrain sump. The collection pipes are designed according to the Burns & Richard (1964) method to resist crushing and wall buckling due to the anticipated loading associated with the maximum height of overlying tailings. The expected vertical and horizontal strains calculated for the underdrain collection pipes are 3.6 percent and -2.4 percent, respectively.

The design analyses to estimate pipe deformation are presented in Appendix D-2.

REFERENCES

- Burns, J.Q. & Richard, R.M. 1964. Attenuation of Stresses for Buried Cylinders. Proceedings, Symposium on Soil-Structure Interaction, University of Arizona. September. 378 p.
- Lupo, J.F. 2001. Stability of HDPE Pipes Under High Heap Loads, SME, Denver.
- U.S. Department of Agriculture, Natural Resources Conservation Service (NRCS). 1994. *National Engineering Handbook, Chapter 26*, October.

APPENDIX D-1
FILTER COMPATIBILITY ANALYSES



Subject	Piñon Ridge
	Tailings Cell Design
	Filter Design

Made by	EF
Checked by	<i>[Signature]</i>
Approved by	<i>[Signature]</i>

Job No	073-81694
Date	03/04/08
Sheet No	1 of 8

OBJECTIVES:

- 1. Design a soil filter for the tailings underflow material.
- 2. Determine the maximum pipe perforation size based on the coarse filter material.

GIVEN:

- Soil gradation for the tailings underflow at the Piñon Ridge Project

METHOD:

- This filter design follows the procedures outlined in NRCS (1994), Chapter 26 “Gradation Design of Sand and Gravel Filters”.

CONCEPT:

- The general concept for the use for this filter design is diagramed below:

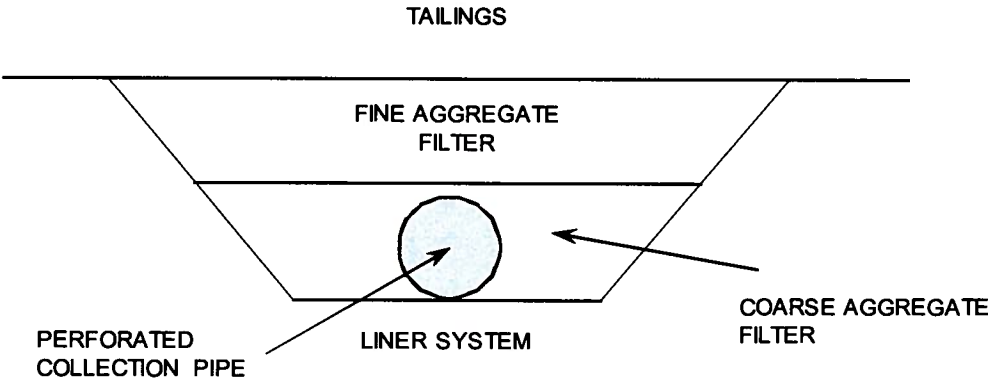

CALCULATIONS:

I. Design of Fine Aggregate Filter

- *Step 1* - Determine Base Soil Material Gradations
 - Gradation of base soil material, shown on Figure 1, is summarized as follows:

Sieve Size	Percent Passing
No. 20 (0.85 mm)	97.5
No. 30 (0.60 mm)	95.9
No. 60 (0.25 mm)	74.4
No. 200 (0.075 mm)	37.9
No. 325 (0.045 mm)	14.6

Note: Gradation supplied by Don Sparling on November 1, 2007



Subject	Piñon Ridge
	Tailings Cell Design
	Filter Design

Made by	EF
Checked by	<i>[Signature]</i>
Approved by	<i>[Signature]</i>

Job No	073-81694
Date	03/04/08
Sheet No	2 of 8

- *Step 2* – Percent Passing the No. 4 Sieve
 - Based on the above supplied gradation, it is assumed that 100 percent of the material passes the No. 4 sieve, so the gradation curves do not need to be adjusted as per Step 3.
- *Step 3* – Adjust Gradation Curves
 - Skip this step.
- *Step 4* – Categorize the Base Material
 - The soil gradation curve shows 37.9 percent passing the No. 200 sieve, which places the base soil into Base Soil Category (BSC) 3 – Silty and clayey sands and gravel as per Table 26-1 (NRCS, 1994).
- *Step 5* – Determine the Maximum Allowable D_{15} for the Filter (D_{15F})
 - As per Table 26-2 (NRCS, 1994), the maximum D_{15} for a BSC 3 soil is:

$$D_{15F} \leq \left(\frac{40 - A}{40 - 15} \right) [(4 \times d_{85B}) - 0.7mm] + 0.7mm$$

Where A = % passing the #200 sieve.

$$D_{15F} \leq \left(\frac{40 - 37.9}{40 - 15} \right) [(4 \times 0.38) - 0.7mm] + 0.7mm = 0.77mm$$

- *Step 6* – Determine the Minimum Allowable D_{15F}
 - To ensure sufficient permeability, set the minimum D_{15F} as:

$$D_{15F} \geq 4 \cdot D_{15B}, \text{ but not less than } 0.1 \text{ mm}$$

where D_{15F} = the particle size which 15 percent of material passes for the filter zone and D_{15B} is the particle size which 15 percent of material passes for the base material based on the original, non-adjusted gradation curve.

- $D_{15B} \times 4 = 0.045 \times 4 = 0.18 \text{ mm}$
- *Step 7* – Adjust Filter Band to Avoid Possibility of Gap Graded Materials
 - Set the ratio of the maximum D_{15F} / minimum D_{15F} to be less than or equal to 5.
 - As the primary purpose is to filter, rather than to drain, fix the minimum D_{15F} as determined above and adjust the maximum D_{15F} .



Subject	Piñon Ridge
Tailings Cell Design	
Filter Design	

Made by	EF
Checked by	<i>[Signature]</i>
Approved by	<i>[Signature]</i>

Job No	073-81694
Date	03/04/08
Sheet No	3 of 8

- Since the ratio between the maximum D_{15F} / minimum D_{15F} (0.77/0.18) is already less than 5, no adjustments are needed:
 - Minimum $D_{15F} = 0.18$ mm
 - Maximum $D_{15F} = 0.77$ mm
- **Step 8 – Prevent the Use of Possibly Gap Graded Filters**
 - The coefficient of uniformity (CU) of both sides of the filter band should be less than or equal to 6 to prevent the use of possibly gap graded filters.

$$CU = \frac{D_{60}}{D_{10}} \leq 6$$

- Calculate a maximum D_{10F} as the maximum D_{15F} value divided by 1.2, and calculate the maximum D_{60F} value by multiplying the maximum D_{10F} value by 6.
 - Maximum $D_{10F} = 0.77/1.2 = 0.64$ mm
 - Maximum $D_{60F} = 0.64 \times 6 = 3.84$ mm
 - Calculate the minimum D_{60F} as one fifth of the maximum D_{60F}
 - Minimum $D_{60F} = 3.84 / 5 = 0.77$ mm
- **Step 9 – Determine the Minimum D_{5F} and Maximum D_{100F} Sizes of the Filter**
 - Use Table 26-5 (NRCS, 1994) to determine these maximum and minimum sizes.
 - Maximum $D_{100F} = 75$ mm
 - Minimum $D_{5F} = 0.075$ mm
- **Step 10 – Determine the Maximum D_{90F} to Minimize Segregation During Construction**
 - Calculate the minimum D_{10F} as the minimum D_{15F} divided by 1.2.
 - Minimum $D_{10F} = 0.18 / 1.2 = 0.15$ mm
 - Determine the maximum D_{90F} using Table 26-6 (NRCS, 1994).
 - Maximum $D_{90F} = 20$ mm



Subject	Piñon Ridge
	Tailings Cell Design
	Filter Design

Made by	EF
Checked by	<i>[Signature]</i>
Approved by	<i>[Signature]</i>

Job No	073-81694
Date	03/04/08
Sheet No	4 of 8

- *Step 11* – Plot the Filter Gradation Boundaries
 - Using the maximum and minimum control points underlined above as guidelines, a design filter band was developed as illustrated in Figure 2.
 - The gradation of the sand filter, shown on Figure 2, is summarized as follows:

Acceptable Fine Aggregate Filter Band	
Sieve Size	% Passing
75 mm (3")	100
No. 4 (4.75 mm)	60-100
No. 10 (2.0 mm)	40-90
No. 20 (0.85 mm)	20-65
No. 40 (0.425 mm)	0-40
No. 100 (0.15 mm)	0-10

- The gradation for ASTM C-33 fine aggregate, also plotted on Figure 2, lies primarily within the acceptable sand filter gradation. Since this is a standard and readily available gradation, ASTM C-33 fine aggregate will be used as the filter material adjacent to the base soil. This gradation is summarized below:

Filter (ASTM C-33 Fine Aggregate)	
Sieve Size	% Passing
9.5 mm (3/8")	100
No. 4 (4.75 mm)	95-100
No. 8 (2.36 mm)	80-100
No. 16 (1.18 mm)	50-85
No. 30 (0.6 mm)	25-60
No. 50 (0.355 mm)	10-30
No. 100 (0.15 mm)	2-10

II. Design of Coarse Aggregate Filter

A coarser material than the ASTM C-33 fine aggregate, specified above, is desired for drainage purposes. The method used above is repeated below, using the average grain size distribution of the ASTM C-33 fine aggregate as the base soil.

- *Step 1* - Determine Base Soil Material Gradations
 - Gradation of base soil material, shown on Figure 3, is summarized as follows:



Subject	Piñon Ridge
	Tailings Cell Design
	Filter Design

Made by	EF
Checked by	<i>[Signature]</i>
Approved by	<i>[Signature]</i>

Job No	073-81694
Date	03/04/08
Sheet No	5 of 8

Sieve Size	Percent Passing
9.5 mm (3/8")	100
No. 4 (4.8 mm)	97.5
No. 16 (1.18 mm)	67.5
No. 30 (0.6 mm)	42.5
No. 50 (.0355 mm)	20
No. 100 (0.15 mm)	6

- **Step 2 – Percent Passing the No. 4 Sieve**
 - Based on the above supplied gradation, 2.5% of the above soil is retained on the No. 4 sieve, so the gradation curves are adjusted in Step 3.
- **Step 3 – Adjust Gradation Curves**
 - The base soil gradation curve was adjusted by multiplying the percent passing each sieve size by 100/97.5, or 1.026. The result is plotted in Figure 3.
- **Step 4 – Categorize the Base Material**
 - The soil gradation curve shows less than 15 percent passing the No. 200 sieve, which places the base soil into Base Soil Category (BSC) 4 – Sands and gravel as per Table 26-1 (NRCS, 1994).
- **Step 5 – Determine the Maximum Allowable D_{15} for the Filter (D_{15F})**
 - As per Table 26-2 (NRCS, 1994), the maximum D_{15} for a BSC 4 soil is:

$$D_{15F} \leq 4 \times D_{85} \text{ of the base soil after regrading}$$

- $D_{15F} \leq 4 \times 1.85 = 7.4 \text{ mm}$
- **Step 6 – Determine the Minimum Allowable D_{15F}**
 - To ensure sufficient permeability, set the minimum D_{15F} as:

$$D_{15F} \geq 4 \cdot D_{15B}, \text{ but not less than } 0.1 \text{ mm}$$

where D_{15F} = the particle size which 15 percent of material passes for the coarse filter zone and D_{15B} is the particle size which 15 percent of material passes for the base material (i.e., fine filter zone) based on the original, non-adjusted gradation curve.

- $D_{15B} \times 4 = 0.22 \times 4 = 0.88 \text{ mm}$



Subject Piñon Ridge
Tailings Cell Design
Filter Design

Made by EF
Checked by <i>JZ</i>
Approved by <i>KFM</i>

Job No 073-81694
Date 03/04/08
Sheet No 6 of 8

- **Step 7 – Adjust Filter Band to Avoid Possibility of Gap Graded Materials**
 - Set the ratio of the maximum D_{15F} / minimum D_{15F} to be less than or equal to 5.
 - Since the ratio between the maximum D_{15F} / minimum D_{15F} (7.4 / 0.88) is greater than 5, the minimum D_{15F} is adjusted as follows:
 - Maximum $D_{15F} = 6$ mm
 - Minimum $D_{15F} = 6 / 5 = 1.2$ mm
- **Step 8 – Prevent the Use of Possibly Gap Graded Filters**
 - The coefficient of uniformity (CU) of both sides of the filter band should be less than or equal to 6 to prevent the use of possibly gap graded filters.

$$CU = \frac{D_{60}}{D_{10}} \leq 6$$

- Calculate a maximum D_{10F} as the maximum D_{15F} value divided by 1.2, and calculate the maximum D_{60F} value by multiplying the maximum D_{10F} value by 6.
- Maximum $D_{10F} = 6 / 1.2 = 5$ mm
- Maximum $D_{60F} = 5 \times 6 = 30$ mm
- Calculate the minimum D_{60F} as one fifth of the maximum D_{60F}
- Minimum $D_{60F} = 30 / 5 = 6$ mm
- **Step 9 – Determine the Minimum D_{5F} and Maximum D_{100F} Sizes of the Filter**
 - Use Table 26-5 (NRCS, 1994) to determine these maximum and minimum sizes.
 - Maximum $D_{100F} = 75$ mm
 - Minimum $D_{5F} = 0.075$ mm
- **Step 10 – Determine the Maximum D_{90F} to Minimize Segregation During Construction**
 - Calculate the minimum D_{10F} as the minimum D_{15F} divided by 1.2.
 - Minimum $D_{10F} = 1.2 / 1.2 = 1.0$ mm



Subject	Piñon Ridge
	Tailings Cell Design
	Filter Design

Made by	EF
Checked by	<i>[Signature]</i>
Approved by	<i>[Signature]</i>

Job No	073-81694
Date	03/04/08
Sheet No	7 of 8

- Determine the maximum D_{90F} using Table 26-6 (NRCS, 1994).
- Maximum $D_{90F} = 30$ mm
- *Step 11* – Plot the Filter Gradation Boundaries
 - Using the maximum and minimum control points underlined above as guidelines, a design filter band was developed as illustrated in Figure 3.
 - The acceptable design gradation range of the coarse sand filter, shown on Figure 3, is summarized as follows:

Acceptable Coarse Aggregate Filter Band	
Sieve Size	% Passing
75 mm (3")	100
19 mm (3/4")	55-100
9.5 mm (3/8")	30-100
No. 4 (4.75 mm)	10-45
No. 20 (0.85 mm)	0-10
No. 200 (0.075 mm)	0-5

- The gradation for ASTM C-33 Size 8 coarse aggregate, also plotted on Figure 3, lies within the acceptable coarse sand filter gradation. Since this is a standard and readily available gradation, ASTM C-33 Size 8 coarse aggregate could be used as the filter material adjacent to the ASTM C-33 fine aggregate. This coarse aggregate gradation is summarized below:

Filter (ASTM C-33 Size 8 Coarse Aggregate)	
Sieve Size	% Passing
12.7 mm (1/2")	100
9.5 mm (3/8")	85-100
No. 4 (4.75 mm)	10-30
No. 8 (2.38 mm)	0-10
No. 16 (1.19 mm)	0-5

- Although this is a standard gradation, it is also acceptable to use any custom gradation, so long as it falls within the Acceptable Coarse Aggregate Filter Band specified in this section.

III. Design of Perforated Pipe

Perforated pipe will be located within the coarse aggregate filter material for drainage purposes. According to Step 12 (NRCS, 1994), the most stringent requirement for the perforation size is that the perforation width be less than or equal to D_{15} . The average D_{15} for the coarse aggregate is about 4 mm, so the perforation size must be 4 mm or less.



Subject Piñon Ridge
Tailings Cell Design
Filter Design

Made by EF
Checked by <i>[Signature]</i>
Approved by <i>[Signature]</i>

Job No 073-81694
Date 03/04/08
Sheet No 8 of 8

SUMMARY:

A two-layer filter will be used under the tailings cells. Adjacent to the base soil will be ASTM C-33 fine aggregate. Adjacent to the fine aggregate will be ASTM C-33 Size 8 coarse aggregate, or other gradation meeting the coarse aggregate filter band requirements. Perforated pipe used within the coarse aggregate will have a maximum perforation width of 4 mm.

REFERENCES:

U.S. Department of Agriculture, Natural Resources Conservation Service (NRCS) (1994) *National Engineering Handbook, Chapter 26*, October.

U.S. Department of the Interior, Bureau of Reclamation (USBR) (1987) *Design of Small Dams*, Third Edition, 860 pp.

FIGURES

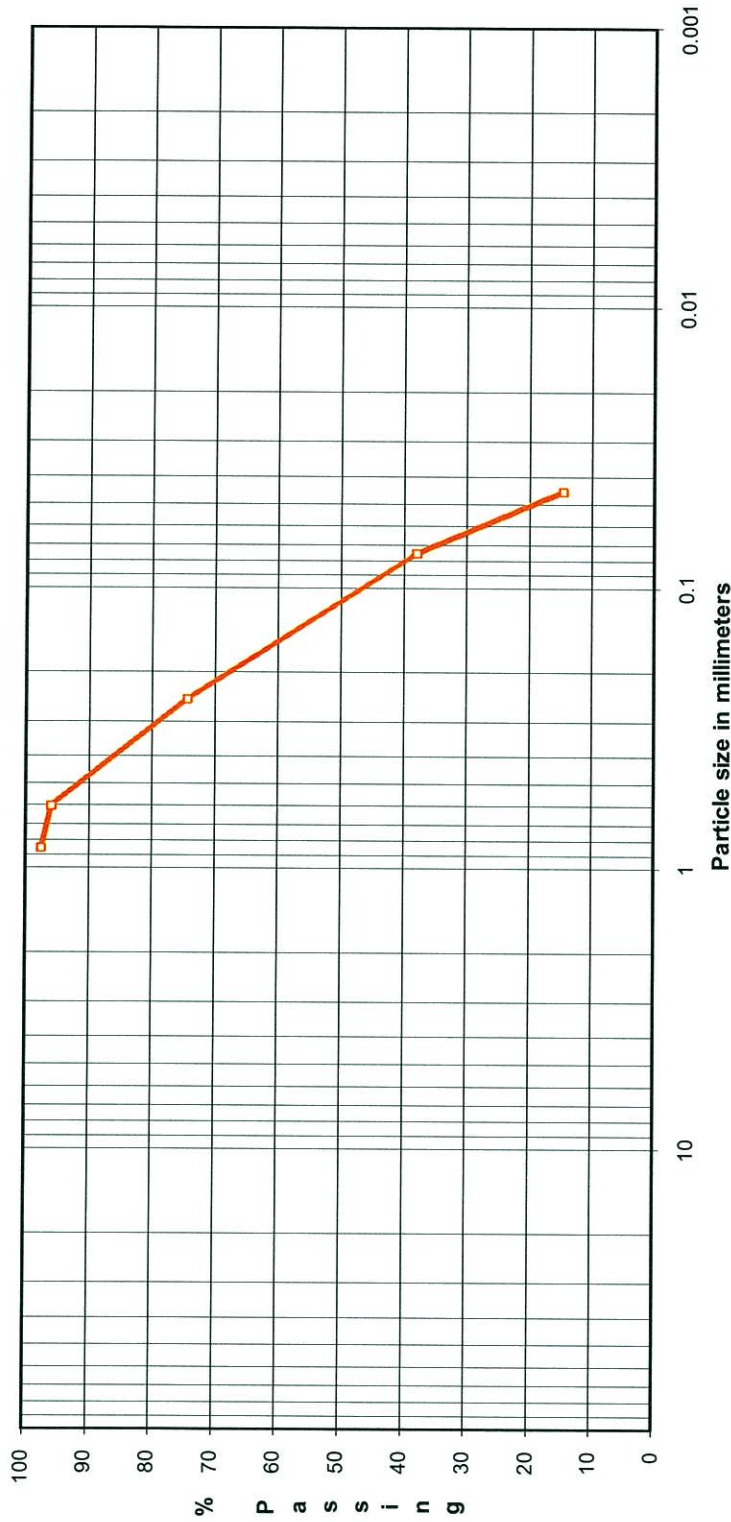

—○— Tailings Underflow



Golder Associates
 Denver, Colorado
ENERGY FUELS RESOURCES CORPORATION
PIÑON RIDGE PROJECT - TAILINGS CELL DESIGN
MONTRORSE COUNTY, COLORADO

Tailings Underflow Gradation (From Don Sparling, November 1, 2007)

TITLE	Tailings Underflow Gradation (From Don Sparling, November 1, 2007)		
CLIENT/PROJECT	ENERGY FUELS RESOURCES CORPORATION PIÑON RIDGE PROJECT - TAILINGS CELL DESIGN MONTRORSE COUNTY, COLORADO		
DRAWN	EF	DATE	1/10/2008
CHECKED	<i>[Signature]</i>	SCALE	N.T.S.
REVIEWED	<i>[Signature]</i>	FILE NO.	FilterDesign.xls
		JOB NO.	073-81694
		DWG. NO.	N/A
		FIGURE NO.	1

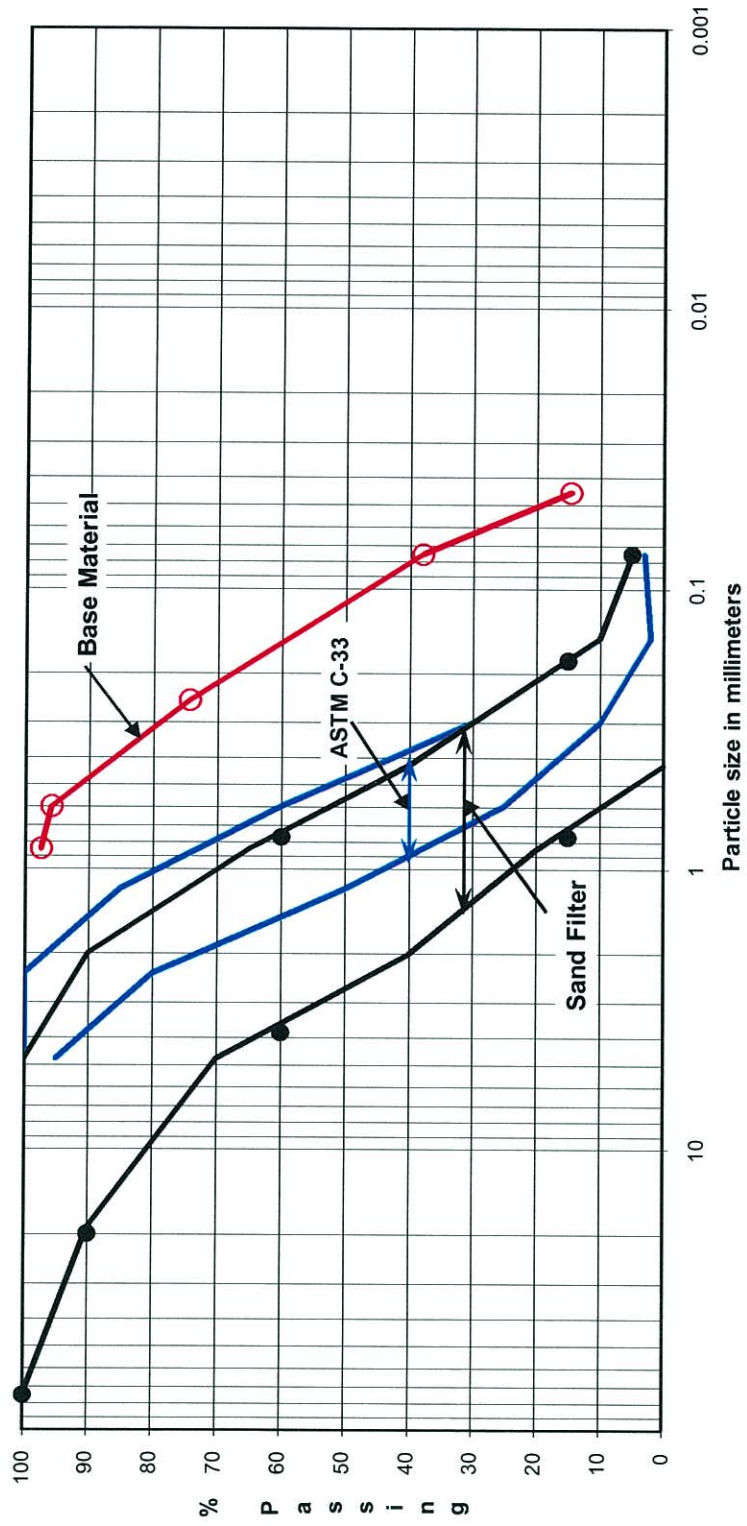

Denver, Colorado
ENERGY FUELS RESOURCES CORPORATION
PIÑON RIDGE PROJECT - TAILINGS CELL DESIGN
MONTROSE COUNTY, COLORADO

TITLE

Fine Aggregate Filter Design

CLIENT/PROJECT	DATE	JOB NO.
ENERGY FUELS RESOURCES CORPORATION	11/10/2008	073-81694
PIÑON RIDGE PROJECT - TAILINGS CELL DESIGN	SCALE	DWG NO.
MONTROSE COUNTY, COLORADO	N.T.S.	N/A
	FILE NO.	FIGURE NO.
	FilterDesign.xls	2
DRAWN	EF	
CHECKED	<i>[Signature]</i>	
REVIEWED	<i>[Signature]</i>	

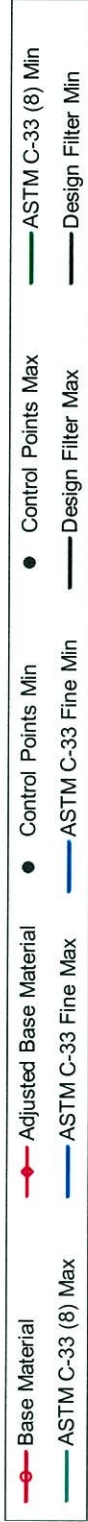
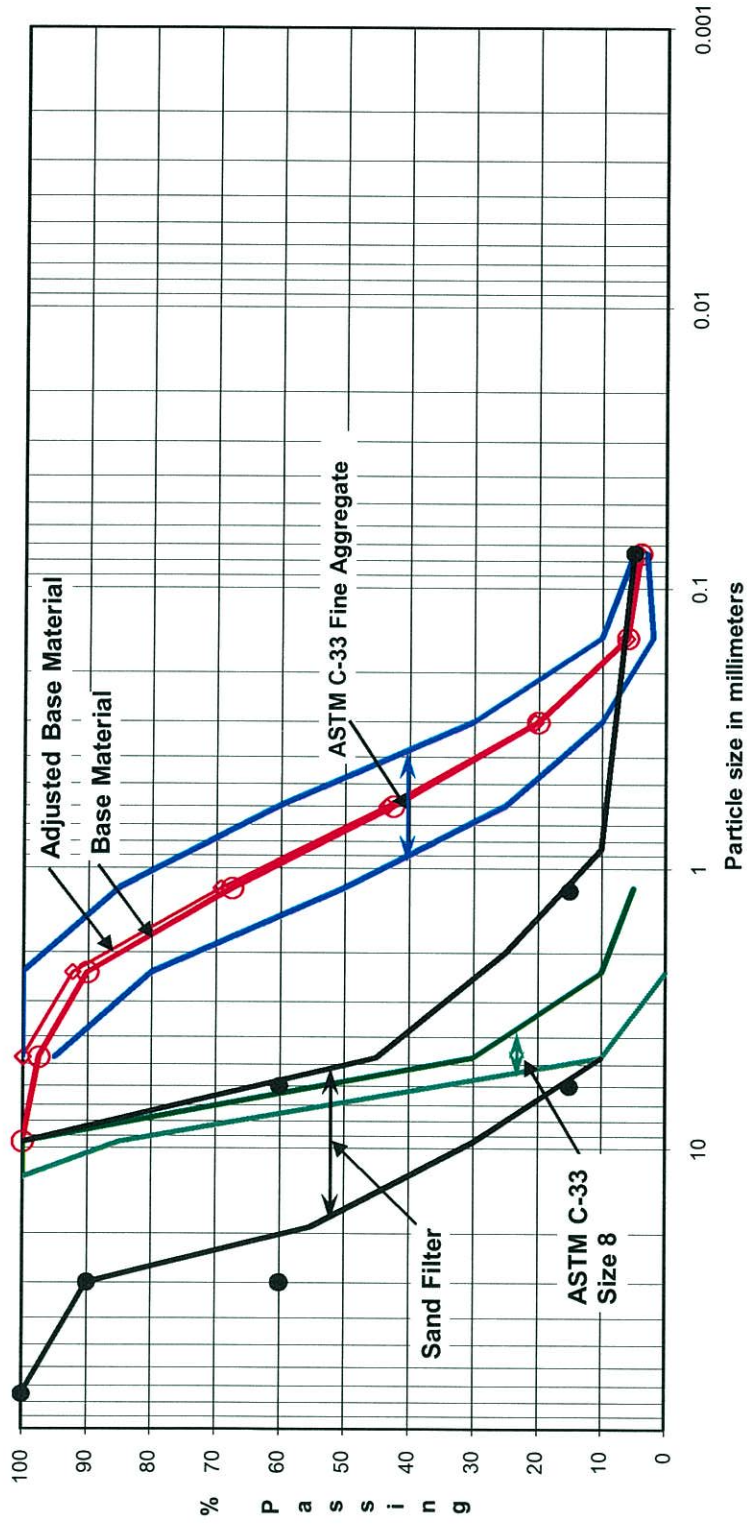

Denver, Colorado

ENERGY FUELS RESOURCES CORPORATION
PIÑON RIDGE PROJECT - TAILINGS CELL DESIGN
MONTROSE COUNTY, COLORADO

TITLE

Coarse Aggregate Filter Design

CLIENT/PROJECT	DATE	JOB NO.
ENERGY FUELS RESOURCES CORPORATION	1/10/2008	073-81694
PIÑON RIDGE PROJECT - TAILINGS CELL DESIGN	SCALE	DWG. NO.
MONTROSE COUNTY, COLORADO	N.T.S.	N/A
	FILE NO.	FIGURE NO.
	FilterDesign.xls	3
DRAWN	CHECKED	REVIEWED
EF	<i>[Signature]</i>	<i>[Signature]</i>

APPENDIX D-2
PIPING CRUSHING CALCULATIONS



Subject	Piñon Ridge Project
	Tailings Cell Design
	Underdrain Pipe Crushing Calculation

Made by	KFM
Checked by	<i>JZ</i>
Approved by	<i>KFM</i>

Job No	073-81694
Date	5/06/08
Sheet No	1 of 2

OBJECTIVE:

Evaluate the tailings cell underdrain piping system (i.e., underdrain collection pipes and underdrain riser pipes) under loading.

GIVEN:

- Underdrain riser piping consists of two 10-inch SDR11 HDPE pipes (eg., DriscoPlex™), non-corrugated, Series 1500 IPS. Pipe data included in Attachment 1, and summarized below:
 - Pipe outside diameter = 10.75 inches;
 - Pipe inside diameter = 8.679 inches;
 - Pipe wall thickness = 0.977 inches; and
 - Weight of pipe = 13.09 lb/ft.
- Underdrain collection pipe consists of 8-inch diameter ADS N-12 corrugated pipes. Pipe data included in Attachment 1, summarized below:
 - Pipe outside diameter = 9.11 inches;
 - Pipe inside diameter = 7.90 inches; and
 - Weight of pipe = 1.54 lb/ft.

ASSUMPTIONS:

- Underdrain Collection Pipe envelope (coarse underdrain fill and pipe bedding fill) properties assumed as follows:
 - Coarse-grained soils with little or no fines, at about 90 percent relative compaction;
 - Modulus of soil reaction assumed as 1,000 pounds per square inch (psi);
 - Poisson's ratio = 0.30;
 - Soil friction angle = 35 degrees; and
 - Constrained modulus = 3,000 psi.
- Underdrain Riser Pipe envelope (tailings) properties assumed as follows:
 - Fine-grained soils with less than 25 percent sand, at about 85 percent relative compaction;
 - Modulus of soil reaction assumed as 500 pounds per square inch (psi);
 - Poisson's ratio = 0.30;
 - Soil friction angle = 20 degrees; and
 - Constrained modulus = 1,540 psi.
- Modulus of elasticity of pipe = 172 MPa (25,000 psi) (long term value for HDPE);
- Unit weight of tailings assumed as 100 pounds per cubic foot (pcf); and
- Pipe calculations conducted assuming depth of burial of 80 feet.
- Others, as stated



Subject	Piñon Ridge Project
	Tailings Cell Design
	Underdrain Pipe Crushing Calculation

Made by	KFM
Checked by	<i>[Signature]</i>
Approved by	<i>[Signature]</i>

Job No	073-81694
Date	5/06/08
Sheet No	2 of 2

CALCULATIONS:

Underdrain Collection Piping:

- Deformation characteristics calculated using Burns & Richard (1964) method, supplied by ADS manufacturer (see Attachment 3), as follows:
 - Expected vertical deflection is 3.6 percent (positive strain denotes flattening).
 - Expected horizontal deflection is -2.4 percent (negative strain denotes outward deformation).

Underdrain Riser Piping:

- Deformation characteristics calculated using modified Burns & Richard (1964) method (see Attachment 2), as follows:
 - Expected vertical deflections range from 1.8 percent (no slippage, positive strain denotes flattening) to 1.9 percent (full slippage).
 - Expected horizontal deflections range from -2.0 percent (no slippage, negative denotes outward deformation) to -2.2 percent (full slippage).

CONCLUSIONS:

The maximum underdrain riser pipe and underdrain collection pipe vertical strains were estimated as 1.9 and 3.6 percent, respectively. The acceptable maximum deflection for HDPE pipe is on the order of 20 percent, and the estimated deflections are considerably less than 20 percent. Therefore, pipe crushing of the underdrain piping system is not considered a concern.

REFERENCES:

Advanced Drainage Systems, Inc. website, <http://www.ads-pipe.com/en/index.asp>

Burns, J.Q. & Richard, R.M. (1964). Attenuation of Stresses for Buried Cylinders. Proceedings, Symposium on Soil-Structure Interaction, University of Arizona. September. 378 p.

Lupo, J.F. (2001). Stability of HDPE Pipes Under High Heap Loads, SME, Denver.

Performance Pipe website, http://www.cpchem.com/enu/performance_pipe.asp

ATTACHMENT 1
MANUFACTURER PIPE DATA



PERFORMANCE PIPE Municipal & Industrial Series/IPS Pipe Data

Pipe weights are calculated in accordance with PPI TR-7. Average inside diameter calculated using nominal OD and minimum wall plus 6% for use in estimating fluid flows. Actual ID will vary. When designing components to fit the pipe ID, refer to pipe dimensions and tolerances in applicable pipe specifications.

Pressure Ratings are for water at 73.4 °F. For other fluid and service temperature, ratings may differ. Refer to Engineering Manual for Chemical and Environmental Considerations.

IPS Pipe Size	255 psi DR 7.3			200 psi DR 9.0			160 psi DR 11.0			130 psi DR 13.5			IPS Pipe Size	
	Nominal OD (in)	Minimum Wall (in)	Average ID (in)	Weight (lbs/ft)	Minimum Wall (in)	Average ID (in)	Weight (lbs/ft)	Minimum Wall (in)	Average ID (in)	Weight (lbs/ft)	Minimum Wall (in)	Average ID (in)		Weight (lbs/ft)
1 1/4"	1.660	0.227	1.179	0.44	0.184	1.270	0.37	0.151	1.340	0.31	0.123	1.399	0.26	1 1/4"
1 1/2"	1.900	0.260	1.349	0.58	0.211	1.453	0.49	0.173	1.533	0.41	0.141	1.601	0.34	1 1/2"
2"	2.375	0.325	1.686	0.91	0.264	1.815	0.76	0.216	1.917	0.64	0.176	2.002	0.53	2"
3"	3.500	0.479	2.485	1.98	0.389	2.675	1.66	0.318	2.826	1.39	0.259	2.951	1.15	3"
4"	4.500	0.616	3.194	3.27	0.500	3.440	2.74	0.409	3.633	2.29	0.333	3.794	1.90	4"
5 3/8"	5.375	0.736	3.815	4.66	0.597	4.109	3.90	0.489	4.338	3.27	0.398	4.531	2.72	5 3/8"
5"	5.563	0.762	3.948	5.00	0.618	4.253	4.18	0.506	4.490	3.51	0.412	4.690	2.91	5"
6"	6.625	0.908	4.700	7.09	0.736	5.065	5.93	0.602	5.349	4.97	0.491	5.584	4.13	6"
7 1/8"	7.125	0.976	5.056	8.20	0.792	5.446	6.86	0.648	5.751	5.75	0.528	6.006	4.78	7 1/8"
8"	8.625	1.182	6.119	12.01	0.958	6.594	10.05	0.784	6.963	8.42	0.639	7.270	7.00	8"
10"	10.750	1.473	7.627	18.66	1.194	8.219	15.61	0.977	8.679	13.09	0.796	9.062	10.87	10"
12"	12.750	1.747	9.046	26.25	1.417	9.746	21.97	1.159	10.293	18.41	0.944	10.749	15.29	12"
13 3/8"	13.375	1.832	9.491	28.88	1.486	10.225	24.18	1.216	10.797	20.26	0.991	11.274	16.84	13 3/8"
14"	14.000	1.918	9.934	31.64	1.556	10.701	26.50	1.273	11.301	22.20	1.037	11.802	18.44	14"
16"	16.000	2.192	11.353	41.33	1.778	12.231	34.60	1.455	12.915	29.00	1.185	13.488	24.09	16"
18"	18.000	2.466	12.772	52.31	2.000	13.760	43.79	1.636	14.532	36.69	1.333	15.174	30.48	18"
20"	20.000	2.740	14.191	64.58	2.222	15.289	54.05	1.818	16.146	45.30	1.481	16.860	37.63	20"
22"	22.000	3.014	15.610	78.14	2.444	16.819	65.40	2.000	17.760	54.82	1.630	18.544	45.56	22"
24"	24.000	3.288	17.029	93.00	2.667	18.346	77.85	2.182	19.374	65.24	1.778	20.231	54.21	24"
26"	26.000				2.889	19.875	91.36	2.364	20.988	76.57	1.926	21.917	63.62	26"
28"	28.000				3.111	21.405	105.95	2.545	22.605	88.78	2.074	23.603	73.78	28"
30"	30.000				3.333	22.934	121.62	2.727	24.219	101.92	2.222	25.289	84.69	30"
32"	32.000							2.909	25.833	115.97	2.370	26.976	96.35	32"
34"	34.000							3.091	27.447	130.93	2.519	28.660	108.81	34"
36"	36.000							3.273	29.061	146.80	2.667	30.346	121.98	36"
42"	42.000													42"
48"	48.000													48"
54"	54.000													54"

Performance Pipe can produce to specialized pipe dimensions. Check with your Performance Pipe contact for availability of dimensions not listed.

Performance Pipe and PERFORMANCE PIPE™ are trademarks of Chevron Phillips Chemical Company LP



Product Notes

Product Note 3.107

Re: Specification for Smooth Interior Corrugated Polyethylene Pipe

Date: January 2005

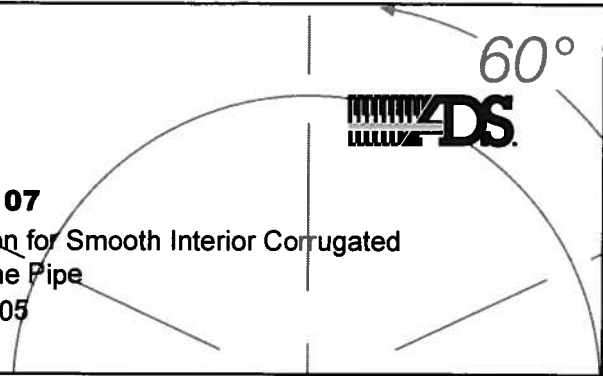

This specification applies to high density polyethylene corrugated pipe with an integrally formed smooth waterway. Nominal sizes for which this specification is acceptable are 100 – 1500 mm (4 - 60 inch) diameters. Sizes 100 – 1500 mm (4 - 60 inch) shall be either AASHTO Type 'S' or Type 'D' as follows. Sizes 100 – 1500 mm (4 - 60 inch) designated as AASHTO Type 'S' (N-12) shall have a full circular cross-section, with an outer corrugated pipe wall and an essentially smooth inner wall (waterway). Corrugations for Type 'S' sizes 100 – 1500 mm (4 - 60 inch) shall be annular (N-12). Sizes 1050 – 1500 mm (42 thru 60 inch) designated as AASHTO Type 'D' (N-12HC) shall consist of an essentially smooth waterway braced circumferentially with circular ribs which are formed simultaneously with an essentially smooth outer wall. The 1050 – 1500 mm (42 thru 60 inch) (N-12HC) sizes shall conform to AASHTO Type 'D' (which describes dual wall pipe with a smooth waterway).

Pipe manufactured for this specification shall comply with the requirements for test methods, dimensions and markings found in AASHTO Designations M252, and M294. Pipe and fittings shall be made from virgin PE compounds which conform with the applicable current edition of the AASHTO Material Specifications for cell classification as defined and described in ASTM D3350.

The minimum parallel plate stiffness values when tested in accordance with ASTM D2412 shall be as follows:

Diameter (nominal)	Pipe Stiffness (minimum)	Diameter (nominal)	Pipe Stiffness (minimum)
100 mm (4")	340 kN/m ² (50 pii)	600 mm (24")	235 kN/m ² (34 pii)
150 mm (6")	340 kN/m ² (50 pii)	750 mm (30")	195 kN/m ² (28 pii)
200 mm (8")	340 kN/m ² (50 pii)	900 mm (36")	150 kN/m ² (22 pii)
250 mm (10")	340 kN/m ² (50 pii)	1050 mm (42")	140 kN/m ² (20 pii)
300 mm (12")	345 kN/m ² (50 pii)	1200 mm (48")	125 kN/m ² (18 pii)
375 mm (15")	290 kN/m ² (42 pii)	1500 mm (60")	95 kN/m ² (14 pii)
450 mm (18")	275 kN/m ² (40 pii)		

The fittings shall not reduce or impair the overall integrity or function of the pipeline. Fittings may be either molded or fabricated. Common corrugated fittings include in-line joint fittings, such as couplers and reducers, and branch or complimentary assembly fittings such as tees, wyes and end caps. These fittings may be installed by various methods such as snap-on, bell and spigot, bell – bell and wrap around couplers. Couplers shall provide sufficient longitudinal strength to preserve pipe alignment and prevent separation at the joints. Only fittings supplied or recommended by the manufacturer shall be used. Where designated on the plans or project specifications, an elastomeric gasket meeting the requirements of ASTM F477 shall be supplied.

Installation of the pipe specified above shall be in accordance with either AASHTO Section 30 or ASTM Recommended Practice D2321 as described elsewhere in these specifications and as recommended by the manufacturer.

ADS N-12 PRODUCT INFORMATION SHEET

Nominal Diameter	Inside Diameter, Average	Outside Diameter, Average	Inner Liner Thickness, Minimum	Minimum Pipe Stiffness @ 5% Deflection	Weight kg./6m (lbs./20 ft.)	Area mm ² /mm	"I" cm ⁴ /cm	"C" mm
100 mm (4")	104 mm (4.10")	120 mm (4.78")	0.5 mm (0.020")	340 kN/m ² 50 psi	4.08 kg (9.00 lbs)	1.59 (0.063 in ² /in)	0.010 (0.0006 in ⁴ /in)	3.06 (0.12 in)
150 mm (6")	152 mm (6.00")	176 mm (6.92")	0.5 mm (0.020")	340 kN/m ² 50 psi	7.71 kg (17.00 lbs)	2.15 (0.085 in ² /in)	0.035 (0.0021 in ⁴ /in)	4.94 (0.19 in)
200 mm (8")	200 mm (7.90")	233 mm (9.11")	0.6 mm (0.024")	340 kN/m ² 50 psi	13.97 kg (30.80 lbs)	2.75 (0.108 in ² /in)	0.078 (0.005 in ⁴ /in)	6.36 (0.25 in)
250 mm (10")	251 mm (9.90")	287 mm (11.36")	0.6 mm (0.024")	340 kN/m ² 50 psi	20.96 kg (46.20 lbs)	3.48 (0.137 in ² /in)	0.134 (0.008 in ⁴ /in)	7.58 (0.30 in)
300 mm (12")	308 mm (12.15")	367 mm (14.45")	0.9 mm (0.035")	345 kN/m ² 50 psi	29.60 kg (65.20 lbs)	5.50 (0.217 in ² /in)	0.574 (0.035 in ⁴ /in)	10.92 (0.43 in)
375 mm (15")	380 mm (14.98")	448 mm (17.57")	1.0 mm (0.039")	290 kN/m ² 42 psi	42.00 kg (92.50 lbs)	6.91 (0.272 in ² /in)	0.901 (0.055 in ⁴ /in)	13.21 (0.52 in)
450 mm (18")	459 mm (18.07")	536 mm (21.20")	1.3 mm (0.051")	275 kN/m ² 40 psi	58.38 kg (128.60 lbs)	6.93 (0.273 in ² /in)	1.327 (0.081 in ⁴ /in)	14.48 (0.57 in)
600 mm (24")	612 mm (24.08")	719 mm (27.80")	1.5 mm (0.059")	235 kN/m ² 34 psi	99.93 kg (220.30 lbs)	8.23 (0.324 in ² /in)	2.245 (0.137 in ⁴ /in)	18.80 (0.74 in)
750 mm (30")	762 mm (30.00")	892 mm (35.10")	1.5 mm (0.059")	195 kN/m ² 28 psi	140.00 kg (308.6 lbs)	9.60 (0.378 in ² /in)	4.539 (0.277 in ⁴ /in)	21.84 (0.86 in)
900 mm (36")	914 mm (36.00")	1059 mm (41.70")	1.7 mm (0.067")	150 kN/m ² 22 psi	180.00 kg (396.8 lbs)	10.19 (0.401 in ² /in)	6.555 (0.400 in ⁴ /in)	25.40 (1.00 in)
1050 mm (42")	1054 mm (41.40")	1212 mm (47.70")	1.8 mm (0.070")	140 kN/m ² 20 psi	230.00 kg (570.10 lbs)	11.64 (0.458 in ² /in)	9.373 (0.572 in ⁴ /in)	30.73 (1.21 in)
Type S								
1050 mm (42")	1054 mm (41.50")	1187 mm (46.75")	1.8 mm (0.070")	140 kN/m ² 20 psi	269.76 kg (594.70 lbs)	14.86 (0.585 in ² /in)	9.685 (0.591 in ⁴ /in)	35.31 (1.39 in)
Type D								
1200 mm (48")	1209 mm (47.60")	1361 mm (53.60")	1.8 mm (0.070")	125 kN/m ² 18 psi	283.50 kg (625.00 lbs)	12.58 (0.495 in ² /in)	9.341 (0.570 in ⁴ /in)	29.72 (1.17 in)
Type S								
1200 mm (48")	1208 mm (47.55")	1339 mm (52.70")	1.8 mm (0.070")	125 kN/m ² 18 psi	309.72 kg (682.80 lbs)	14.76 (0.581 in ² /in)	10.090 (0.616 in ⁴ /in)	33.02 (1.30 in)
Type D								
1500 mm (60")	1512 mm (59.5")	1684 mm (66.3")	1.8 mm (0.070")	95 kN/m ² 14 psi	410.00 kg (903.90 lbs)	14.68 (0.578 in ² /in)	14.09 (0.860 in ⁴ /in)	33.66 (1.32 in)
Type S								
1500 mm (60")	1514 mm (59.6")	1664 mm (65.5")	1.8 mm (0.070")	95 kN/m ² 14 psi	509.53 kg (1123.30 lbs)	17.15 (0.675 in ² /in)	13.305 (0.812 in ⁴ /in)	36.32 (1.43 in)
Type D								

ATTACHMENT 2

**UNDERDRAIN RISER PIPE
DEFORMATION CALCULATIONS**

BURIED PLASTIC PIPE LOADING WORKSHEET V2.0

[With Incremental Stress Analysis (non-linear)]

Project: Pinon Ridge Project - Tailings Cell Design

By: KFM

Date: 3/28/08

Note: Compression is positive, tension is negative.

SOIL and PIPE Input Data

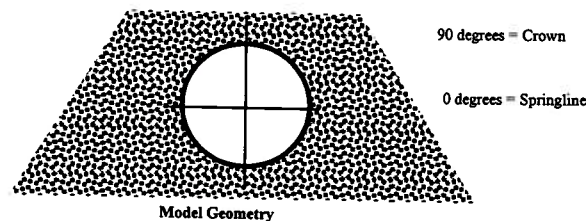

Lateral Pressure Parameters

Material	Cohesion	Friction Angle	Constrained Modulus (psi)	Lateral Stress Ratio	B	C
Pipe	n/a	n/a				
Soil (Tailings)	0	20	1540.0	0.70	0.849	0.15

Pipe Diameter (in):	10.75
Pipe ID (in):	8.68
Weight of Pipe (lb/ft):	13.09
Pipe Corrugated (y/n):	n
Prescribed Constrained Modulus (y/n):	y
Prescribed Constrained Modulus (psi):	1540
Pipe Wall Thickness (in):	1.0355
Pipe Area (in ² /in):	31.602
Flexural Modulus (psi), E _f =	25,000
Ring Compression Modulus (psi), E _{rc} =	25,000
C value (in)	0.518
Moment of Inertia (in ⁴ /in) non-corrugated:	0.0925
Moment of Inertia (in ⁴ /in) corrugated (input from manufacturer data):	0.0000
Stiffness Coefficients	
Flexural Stiffness	121.1
Ring Compression Stiffness	162656.0

DR= 10.38
55.00
0.49

selected I: 0.0925

Ring Stiffness Factor: 20.2 Pipe Stiffness Less Than Soil

Shell-Medium Parameters

UF	0.02	Extensional Flexibility ratio = Compressibility ratio = relative flexibility of pipe and soil under uniform loading.
VF	3.8	Bending Flexibility ratio = Flexibility ratio = relative flexibility of pipe and soil under varying radial and tangential loads.
If both UF and VF are zero then a perfectly rigid embedded pipe.		

Pipe Mean Radius (in):	4.86
Depth of Burial (ft):	80
Applied Surface Stress (psf):	0
Soil Density (pcf):	100
Total Vertical Stress Component (psf):	8000
Total Vertical Stress Component (psi):	55.6

Free Field Stress Values



NO INTERFACE SLIPPAGE

Angle	Soil Stresses (psi)			Pipe Displacements (in)		Circumferential Thrust	Moment Thrust	Ring Compression Stress (psi)	Ring Compression Strain (in/in)	Ring Shortening (in)	Inner Bending Stress (psi)	Outer Bending Stress (psi)	Total Inner Stress (psi)	Total Outer Stress (psi)
	Radial	Hoop	Shear	Radial	Hoop									
0	54.0	46.7	0.0	-0.097	0.00E+00	297.0	46.8	285.8	0.0114	0.0097	262	-262	548	24
10	53.8	46.5	5.6	-0.089	3.78E-02	294.1	44.3	283.0	0.0113	0.0096	248	-248	531	35
20	53.3	45.9	10.6	-0.064	7.11E-02	285.6	36.9	274.9	0.0110	0.0093	207	-207	482	68
30	52.5	44.9	14.3	-0.025	9.58E-02	272.6	25.7	262.4	0.0105	0.0089	144	-144	406	119
40	51.6	43.8	16.2	0.021	1.09E-01	256.7	11.9	247.0	0.0099	0.0084	67	-67	314	180
50	50.6	42.6	16.2	0.071	1.09E-01	239.8	-2.8	230.7	0.0092	0.0078	-16	16	215	246
60	49.7	41.5	14.3	0.118	9.58E-02	223.8	-16.6	215.4	0.0086	0.0073	-93	93	123	308
70	48.9	40.5	10.6	0.157	7.11E-02	210.9	-27.8	202.9	0.0081	0.0069	-156	156	47	359
80	48.4	39.9	5.6	0.182	3.78E-02	202.4	-35.2	194.8	0.0078	0.0066	-197	197	-2	392
90	48.2	39.7	0.0	0.190	1.36E-17	199.4	-37.7	192.0	0.0077	0.0065	-211	211	-19	403

Vertical Deflection (%):	1.77
Horizontal Deflection (%):	-2.00
Radial Soil Pressure at Crown (psi):	48.2
Circumferential Shortening (in):	0.32
Arc length of each sector (in) =	0.85

6945 Max. Compressive Stress (psi): 548
Max. Tensile Stress (psi): -19

FULL SLIPPAGE

Angle	Soil Stresses (psi)			Pipe Displacements (in)		Circumferential Thrust	Moment Thrust	Ring Compression Stress (psi)	Ring Compression Strain (in/in)	Ring Shortening (in)	Inner Bending Stress (psi)	Outer Bending Stress (psi)	Total Inner Stress (psi)	Total Outer Stress (psi)
	Radial	Hoop	Shear	Radial	Hoop									
0	45.3	32.2	0.0	-0.109	0.00E+00	257.6	50.2	247.9	0.0099	0.0084	281	-281	529	-33
10	45.6	32.9	13.3	-0.100	6.00E-02	257.1	47.5	247.4	0.0099	0.0084	266	-266	513	-18
20	46.7	34.8	24.9	-0.073	1.13E-01	255.4	39.5	245.8	0.0098	0.0083	221	-221	467	25
30	48.2	37.7	33.6	-0.031	1.52E-01	252.9	27.4	243.4	0.0097	0.0083	153	-153	397	90
40	50.1	41.3	38.2	0.019	1.73E-01	249.9	12.5	240.5	0.0096	0.0082	70	-70	310	171
50	52.1	45.1	38.2	0.073	1.73E-01	246.6	-3.4	237.3	0.0095	0.0080	-19	19	218	256
60	54.0	48.7	33.6	0.124	1.52E-01	243.5	-18.3	234.4	0.0094	0.0079	-102	102	132	337
70	55.6	51.6	24.9	0.165	1.13E-01	241.0	-30.4	232.0	0.0093	0.0079	-170	170	62	402
80	56.6	53.5	13.3	0.192	6.00E-02	239.4	-38.4	230.4	0.0092	0.0078	-215	215	16	445
90	56.9	54.2	0.0	0.202	2.15E-17	238.8	-41.1	229.8	0.0092	0.0078	-230	230	0	460

Vertical Deflection (%):	1.88
Horizontal Deflection (%):	-2.24
Radial Soil Pressure at Crown (psi):	56.9
Circumferential Shortening (in):	0.32
Arc length of each sector (in) =	0.85

8195 Max. Compressive Stress (psi): 529
Max. Tensile Stress (psi): -33

Free Field Stress: 55.6 psi

Free Field Stress Times Pipe Radius: 214 psi

Radius (in)	CROWN				SPRINGLINE			
	Circumferential Thrust (full slip)	Circumferential Thrust (no slip)	Hoop Stress, psi (full slip)	Hoop Stress, psi (no slip)	Circumferential Thrust (full slip)	Circumferential Thrust (no slip)	Hoop Stress, psi (full slip)	Hoop Stress, psi (no slip)
4.86	238.8	199.4	54.2	39.7	257.6	297.0	32.2	46.7
5.36	263.4	220.0	48.6	38.8	284.1	327.6	39.2	49.0
5.86	288.0	240.5	45.2	38.4	310.7	358.1	43.7	50.5
6.36	312.6	261.0	43.1	38.1	337.2	388.7	46.6	51.6
6.86	337.2	281.6	41.6	38.0	363.7	419.3	48.7	52.3
7.36	361.7	302.1	40.7	38.0	390.2	449.9	50.1	52.9
7.86	386.3	322.6	40.1	38.0	416.7	480.4	51.2	53.3
8.36	410.9	343.2	39.6	38.0	443.3	511.0	52.0	53.7
8.86	435.5	363.7	39.3	38.0	469.8	541.6	52.6	53.9
9.36	460.1	384.2	39.1	38.0	496.3	572.2	53.1	54.1
9.86	484.7	404.7	38.9	38.1	522.8	602.7	53.5	54.3
10.36	509.2	425.3	38.8	38.1	549.3	633.3	53.7	54.4
10.86	533.8	445.8	38.7	38.2	575.9	663.9	54.0	54.6
11.36	558.4	466.3	38.7	38.2	602.4	694.4	54.2	54.7
11.86	583.0	486.9	38.6	38.2	628.9	725.0	54.3	54.8
12.36	607.6	507.4	38.6	38.3	655.4	755.6	54.5	54.8
12.86	632.2	527.9	38.6	38.3	681.9	786.2	54.6	54.9
13.36	656.7	548.5	38.6	38.3	708.5	816.7	54.7	54.9
13.86	681.3	569.0	38.6	38.3	735.0	847.3	54.8	55.0
14.36	705.9	589.5	38.5	38.4	761.5	877.9	54.8	55.0
14.86	730.5	610.1	38.5	38.4	788.0	908.5	54.9	55.1
15.36	755.1	630.6	38.5	38.4	814.5	939.0	55.0	55.1
15.86	779.7	651.1	38.5	38.4	841.1	969.6	55.0	55.1
16.36	804.2	671.6	38.6	38.4	867.6	1000.2	55.1	55.2
16.86	828.8	692.2	38.6	38.5	894.1	1030.7	55.1	55.2
Check Values:	533.8	445.8	44.8	38.4	575.9	663.9	44.5	50.9
Soil Arching:	Negative Arch	Negative Arch	Negative Arch	Negative Arch	Negative Arch	Negative Arch	Positive Arch	Positive Arch

ATTACHMENT 3

**UNDERDRAIN COLLECTION PIPE
DEFORMATION CALCULATIONS**

PIPE PARAMETERS - AASHTO M294, Type S	RESPONSE OF PIPE WALL													CALCULATION OF RING SHORTENING				
	deg c.c.w. from horiz	radial soil press P_r (psi)	radial defl w (in)	tang defl v (in)	circum thrust N(#/in)	wall bend mom(M) (#lb/in)	ring comp stress (psi)	inner bend stress (psi)	outer bend stress (psi)	total stress inner (psi)	total stress outer (psi)	deg c.c.w. from horiz	ring comp stress (psi)	ring comp strain (in/in)	ring shortening (in)			
	0	32.6	-0.051	0.000	146	11	-1351	-556	801	-1907	-551	0	-1351	-0.012285	-0.0090			
effective radius (in), $R = 4.20$	10	32.7	-0.045	0.018	146	11	-1350	-527	759	-1877	-591	10	-1350	-0.0123	-0.0090			
outside diameter (in), $D = 9.11$	20	33.0	-0.027	0.033	145	9	-1346	-444	640	-1791	-706	20	-1346	-0.01224	-0.0090			
thickness (in), $t = 0.610$	30	33.4	0.000	0.044	145	6	-1341	-318	457	-1658	-883	30	-1341	-0.012189	-0.0089			
unit area of wall (in ² /in), $A = 0.108$	40	34.0	0.033	0.050	144	3	-1334	-162	233	-1496	-1101	40	-1334	-0.012127	-0.0089			
unit moment of inertia (in ⁴ /in), $I = 0.0050$	50	34.5	0.068	0.050	143	0	-1327	4	-5	-1323	-1332	50	-1327	-0.012061	-0.0088			
flexural modulus (psi), $E_f = 110,000$	60	35.1	0.102	0.044	143	-3	-1320	159	-229	-1161	-1549	60	-1320	-0.011998	-0.0088			
ring compression modulus (psi), $E_{rc} = 110,000$	70	35.5	0.129	0.033	142	-6	-1314	286	-412	-1028	-1726	70	-1314	-0.011947	-0.0087			
flexural stiffness (psi), $K_f = 6E_f I / R^3 = 45$	80	35.8	0.146	0.018	142	-7	-1311	369	-531	-942	-1842	80	-1311	-0.011914	-0.0087			
ring compression stiffness (psi), $K_{cc} = E_{rc} A / R = 2,832$	90	35.9	0.152	0.000	141	-8	-1309	397	-572	-912	-1882	90	-1309	-0.011902	-0.0087			
distance from inner wall to n.a. (in), $c = 0.25$	100	35.8	0.146	-0.018	142	-7	-1311	369	-531	-942	-1842	100	-1311	-0.011914	-0.0087			
SOIL PARAMETERS - good granular soil	110	35.5	0.129	-0.033	142	-6	-1314	286	-412	-1028	-1726	110	-1314	-0.011947	-0.0087			
mod of soil reaction at 5' of cover (psi), $E'_s = 1000$	120	35.1	0.102	-0.044	143	-3	-1320	159	-229	-1161	-1549	120	-1320	-0.011998	-0.0088			
modulus of soil reaction (psi), $E'_r = 2,290$	130	34.5	0.068	-0.050	143	0	-1327	4	-5	-1323	-1332	130	-1327	-0.012061	-0.0088			
const mod (psi), $M^* = E'((1-u)/((1+u)(1-2u))) = 3083.16$	140	34.0	0.033	-0.050	144	3	-1334	-162	233	-1496	-1101	140	-1334	-0.012127	-0.0089			
lateral stress ratio = $K = u/(1-u) = 0.429$	150	33.4	0.000	-0.044	145	6	-1341	-318	457	-1658	-883	150	-1341	-0.012189	-0.0089			
sym lateral stress ratio = $B = (1/2)(1+K) = 0.714$	160	33.0	-0.027	-0.033	145	9	-1346	-444	640	-1791	-706	160	-1346	-0.01224	-0.0090			
antisym lat stress ratio = $C = (1/2)(1-K) = 0.286$	170	32.7	-0.045	-0.018	146	11	-1350	-527	759	-1877	-591	170	-1350	-0.0123	-0.0090			
SOIL/STRUCTURE PARAMETERS (full slippage)	180	32.6	-0.051	0.000	146	11	-1351	-556	801	-1907	-551	180	-1351	-0.012285	-0.0090			
ring flexibility ratio, $UF = (1+K)M^*/K_c = 1.56$	COMMENTS 1. This is 8" diameter ADS N-12 2. Flexural and compressive modulus are taken as 110,000 psi. 3. Typical E'_s values (in psi) for various soils are listed in the table below: Type of soil Standard AASHTO Relative Compaction 85% 90% 95% Fine-grained soils with less than 25% sand (CL, ML, DL-ML) 500 700 1000 Coarse-grained soils with fines (SM, SC) 600 1000 1200 Coarse-grained soils with little or no fines (SP, SW, GP, GW) 700 1000 1600																	
bending flexibility ratio, $VF = (1-K)M^*/K_c = 39.4$																		
STRESS FUNCTION COEFFICIENTS	constant term, $a_1^* = 0.137$ $\cos(2^*\theta)$, $a_2^* = 0.966$ $\sin(2^*\theta)$, $b_2^* = 0.949$																	
LOAD PARAMETERS	unit weight of soil (lb/ft ³) = 100 height of fill above crown (ft) = 80.0 surcharge pressure (psi), $P = 55.6$																	
MISC.CALCS Vertical deflection (%) = 3.63 Horizontal deflection (%) = -2.43 Critical Buckling Pressure (psi), $P_{cr} = 122.5$ Radial Soil Pressure at Crown (psi), $P_{act} = 35.9$ Arc length of each sector (in) = 0.7322 SUM (1/2 circle) = -0.1684 CIRCUMFERENCE SHORTENS = -0.34 inches Circumference Shortening % (2% Max) OK Max. Compressive Stress -1907 OK (< -3000) Max. Tensile Stress -550.7 OK (< 1000)																		

Calculations by: _____

Engineer

APPENDIX E

LEAK COLLECTION AND RECOVERY SYSTEM DESIGN

APPENDIX E

LEAK COLLECTION AND RECOVERY SYSTEM DESIGN

An important feature of the tailings cell liner system is the Leak Collection and Recovery System (LCRS). The purpose of the LCRS is to provide a method to collect potential seepage should leakage develop within the tailings cell through the primary geomembrane liner. The LCRS layer has been designed as a high density polyethylene (HDPE) geonet on the base of the tailings cells, and a drainage geocomposite on the side slopes. The drainage geocomposite is comprised of a geonet laminated on both sides to a nonwoven geotextile filtration media to increase frictional resistance with the overlying and underlying textured geomembrane layers. Per the requirements of 40 CFR 264.221, the transmissivity of the selected drainage layers exceeds the minimum transmissivity requirement of 3×10^{-4} square meters per second (m^2/sec), and is designed with a minimum grade of one percent.

LCRS SUMP DESIGN

In the event that leakage were to occur through the upper geomembrane liner, it will be collected in the LCRS layer and routed (via gravity flow) to a LCRS sump located in each tailings cell (or sub-cell in the case of Tailings Cell A). The LCRS sumps were sized for eight (8) hours of maximum flow in the LCRS layer (i.e., geonet or drainage geocomposite) assuming one liner defect per acre for good installation (Giroud & Bonaparte, 1989), an effective porosity of 30 percent in the sump (i.e., available pore space within the gravel backfill materials), and applying a factor of safety of 1.5. The LCRS sump sizing calculations are provided in Appendix E-1. Based on these calculations, a sump with base dimensions of 10 feet by 10 feet with 3H:1V (horizontal:vertical) side slopes and 5-foot depth provides sufficient containment for leak solutions.

PIPE CRUSHING ANALYSES

Two LCRS risers are provided within each sump to add redundancy to the system. The risers consist of two 10-inch diameter, SDR-17 HDPE pipes. The lower ends of the pipes are slotted in the sump area to provide solution access into the risers. Solution is recovered via an automated submersible pump (designed by others) installed in the riser. The LCRS risers will be instrumented and fully-automated to report to the mill control system with an alarm in the mill. Recovered solutions will be

returned to the tailings cells, and then to the mill circuit via tailings return pumps. The HDPE LCRS riser pipes are designed according to the modified Burns & Richard (1964) method (Lupo, 2001) to resist crushing and wall buckling due to the anticipated loading associated with the maximum height of overlying tailings. The maximum vertical and horizontal strains calculated for the LCRS riser pipes are 2.5 percent and -2.5 percent, respectively. The design analyses to estimate pipe deformation are presented in Appendix E-2.

REFERENCES

- 40 CFR Part 264 – “*Standards for Owners and Operators of Hazardous Waste Treatment, Storage, and Disposal Facilities*”, Subpart K (Surface Impoundments).
- Burns, J.Q. and Richard, R.M. 1964. Attenuation of Stresses for Buried Cylinders. Proceedings, Symposium on Soil-Structure Interaction, University of Arizona. September. 378 p.
- Giroud, J.P., and Bonaparte, R. 1989. “Leakage through liners constructed with geomembranes – Part I. Geomembrane Liners.” *Geotextiles and Geomembranes*, No. 8, 27-67.
- Lupo, J.F. 2001. Stability of HDPE Pipes Under High Heap Loads, SME, Denver.

APPENDIX E-1

LEAK COLLECTION AND RECOVERY SYSTEM SUMP SIZING



Subject Piñon Ridge Project
Tailings Cell Design
LCRS Sump Sizing Calculation

Made by EF/KFM
Checked by <i>KFM</i>
Approved by <i>KFM</i>

Job No 073-81694
Date 09/26/08
Sheet No 1 of 3

OBJECTIVE:

Evaluate the required capacity and dimensions of the Leak Collection and Recovery System (LCRS) sumps for the tailings facilities based on the maximum flow in the LCRS layer for the tailings cells.

GIVEN:

- Tailings cells and sump configuration (Figure 1)
 - Cells A1 and A2: base cell tailings area = 2.6 acres; slope sides cell tailings area = 12.7 acres
 - Cells B and C: base cell tailings area = 6.3 acres; slope sides cell tailings area = 24.2 acres

ASSUMPTIONS:

- The LCRS sump should be sized to accommodate 8 hours of the maximum leakage flow in the LCRS layer (assuming power loss or pump failure of 8 hours);
- The sump will have 3:1(H:V) side slopes;
- Minimum sump dimensions, lower side 10 feet by 10 feet and 5 feet depth;
- Apply a factor of safety (FS) of 1.5;
- Porosity of the gravel within the LCRS sump is assumed as 0.3; and
- Assume 1 liner defect per acre.

CALCULATIONS:

Maximum flow in the LCRS layer for the tailings cells (Attachment 1)

- Geonet (base of tailings cells): 1.49×10^{-3} ft³/sec per defect
- Geocomposite drainage material (slope sides of tailings cells): 6.21×10^{-4} ft³/sec per defect

Required Size of the LCRS Sump

Tailings A1 and A2

Maximum flow in the LCRS layer:

Base of tailings cells - $Q_{full-base} = 1.49 \times 10^{-3}$ ft³/sec = 963.0 gallons per defect per day
 Slope of tailings cells - $Q_{full-slope} = 6.21 \times 10^{-4}$ ft³/sec = 401.3 gallons per defect per day

Total flow:

$$Q_T = Q_{full-base}(A_{base}) * \left(\frac{1 \text{ defect}}{\text{Acre}}\right) + Q_{full-slope}(A_{slope}) * \left(\frac{1 \text{ defect}}{\text{Acre}}\right)$$

$$Q_T = 963 \text{ gpd/acres (2.6 acres)} + 401.3 \text{ gpd/acres * (12.7 acres)} = 7,600 \text{ gallons per day}$$

t = 8 hr (time)

n = 0.3 (porosity)

FS = 1.5 (factor of safety)



Subject Piñon Ridge Project
Tailings Cell Design
LCRS Sump Sizing Calculation

Made by EF/KFM
Checked by <i>KFM</i>
Approved by <i>KFM</i>

Job No 073-81694
Date 09/26/08
Sheet No 2 of 3

$$\text{Required volume} = Q_T * t * \frac{FS}{n}$$

$$\text{Required volume} = 7,600 \frac{\text{gal}}{\text{day}} * \frac{1 \text{ day}}{24 \text{ hr}} * 8 \text{ hr} * \frac{1 \text{ ft}^3}{7.48 \text{ gal}} * \frac{1.5}{0.3} = 1,693 \text{ ft}^3$$

Tailings Cells B and C:

Maximum flow in the LCRS layer:

Base of tailings cells - $Q_{\text{full-base}} = 1.49 \times 10^{-3} \text{ ft}^3/\text{sec} = 963.0 \text{ gallons per defect per day}$

Slope of tailings cells - $Q_{\text{full-slope}} = 6.21 \times 10^{-4} \text{ ft}^3/\text{sec} = 401.3 \text{ gallons per defect per day}$

Total flow:

$$Q_T = Q_{\text{full-base}}(A_{\text{base}}) * \left(\frac{1 \text{ defect}}{\text{Acre}}\right) + Q_{\text{full-slope}}(A_{\text{slope}}) * \left(\frac{1 \text{ defect}}{\text{Acre}}\right)$$

$$Q_T = 963 \text{ gpd/acre} (6.3 \text{ acres}) + 401.3 \text{ gpd/acre} * (24.2 \text{ acres}) = 15,771 \text{ gallons per day}$$

t = 8 hr (time)

n = 0.3 (porosity)

FS = 1.5 (factor of safety)

$$\text{Required volume} = Q_T * t * \frac{FS}{n}$$

$$\text{Required volume} = 15,771 \frac{\text{gal}}{\text{day}} * \frac{1 \text{ day}}{24 \text{ hr}} * 8 \text{ hr} * \frac{1 \text{ ft}^3}{7.48 \text{ gal}} * \frac{1.5}{0.3} = 3,514 \text{ ft}^3$$

Sump Capacity

The minimum size assumed for construction of the LCRS sump is:

Sump base dimensions: 10 feet x 10 feet

Sump top dimensions: 40 feet x 40 feet

Sump depth: 5 feet

Side slopes: 3H:1V

Calculations of the sump capacity are provided in Attachment 2. A sump with these minimum dimensions has a volume capacity of 4,250 ft³, which is sufficient for construction in all of the cells. The corresponding available solution volume, based on 30 percent porosity, is 1,275 ft³ (9,537 gal).



Subject	Piñon Ridge Project
	Tailings Cell Design
	LCRS Sump Sizing Calculation

Made by	EF/KFM
Checked by	<i>KFM</i>
Approved by	<i>KFM</i>

Job No	073-81694
Date	09/26/08
Sheet No	3 of 3

RESULTS:

The maximum required LCRS sump volume based on a gravel porosity of 0.3 is 3,514 ft³ (i.e., for cells B and C). Using the assumed minimum dimensions for constructability, the minimum volume of the LCRS sump is 4,250 ft³, which meets this requirement.

CONCLUSIONS:

The sump with the minimum assumed dimensions (10 feet by 10 feet at the base, with 3H:1V side slopes and a 5 foot depth) provides sufficient capacity to accommodate 8 hours of a maximum flow in the LCRS layer.

REFERENCES:

Golder (2008). "Comparison of flow through CCL liner and GCL liner for Piñon Ridge Project". Golder project 073-81694

FIGURES

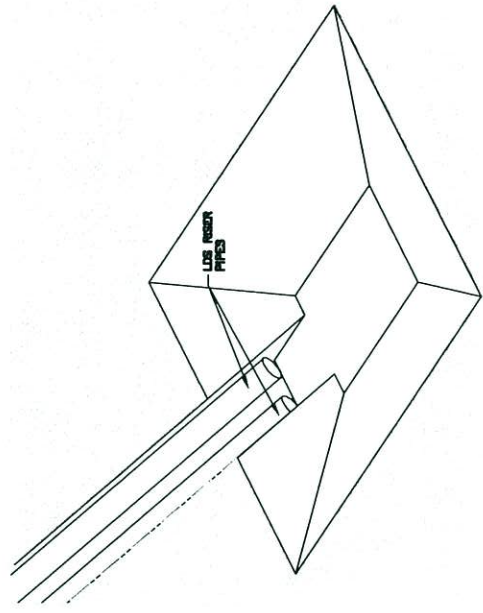
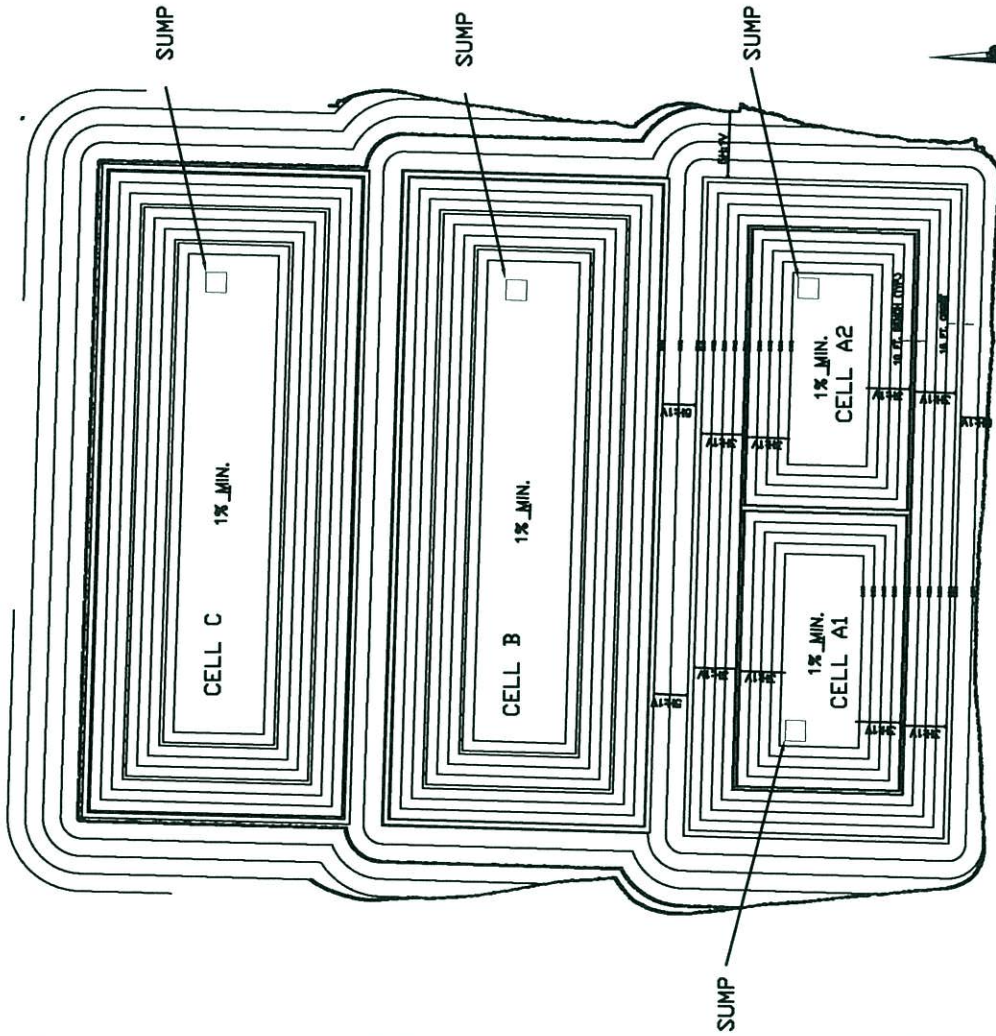

LCRS SUMP ISOMETRIC VIEW

 Golder Associates Denver, Colorado		SUMP LOCATIONS AND TYPICAL SUMP DETAIL	
CLIENT/PROJECT	ENERGY FUELS RESOURCES CORPORATION PIÑON RIDGE PROJECT - TAILINGS CELL DESIGN MONTROSE COUNTY, COLORADO	DRAWN	EF
		DATE	FEBRUARY 21, 2008
		CHECKED	<i>KPM</i>
		SCALE	N.T.S.
		REVIEWED	<i>KPM</i>
		JOB NO.	073-81694
		DWG. NO.	
		FILE NO.	
		FIGURE NO.	1

ATTACHMENT 1
MAXIMUM FLOW IN THE LCRS LAYER



Made by: EF
Checked by: KFM
Approved by: KFM

Subject: Piñon Ridge
Job No.: 073-81694
Date: 9/26/2008
Sheet No. 1 of 1

Maximum Flow in the Leak Collection Layer

Geonet

The permeability of the geonet can be defined by:

$$t_{LCL} := 0.023 \text{ ft} \quad \text{thickness of the geonet}$$

$$\theta := 0.0646 \text{ ft}^2 / \text{sec} \quad \text{geonet transmissivity}$$

$$k := \frac{\theta}{t_{LCL}} \quad \text{geonet hydraulic conductivity}$$

$$k = 2.81 \text{ ft} / \text{sec}$$

The maximum steady-state rate of leachate migration through a defect in the primary liner that the leakage collection layer can accommodate without being filled with leachate (Giroud et al. 1997):

$$Q_{full} := k \cdot t_{LCL}^2$$

$$Q_{full} = 1.49 \times 10^{-3} \text{ ft}^3 / \text{sec}$$

Geocomposite

The permeability of the geonet can be defined by:

$$t_{LCL} := 0.023 \text{ ft} \quad \text{thickness of the geocomposite}$$

$$\theta := 0.027 \text{ ft}^2 / \text{sec} \quad \text{geocomposite transmissivity}$$

$$k := \frac{\theta}{t_{LCL}} \quad \text{geocomposite hydraulic conductivity}$$

$$k = 1.17 \text{ ft} / \text{sec}$$

The maximum steady-state rate of leachate migration through a defect in the primary liner that the leakage collection layer can accommodate without being filled with leachate (Giroud et al. 1997):

$$Q_{full} := k \cdot t_{LCL}^2$$

$$Q_{full} = 6.21 \times 10^{-4} \text{ ft}^3 / \text{sec}$$

References

Giroud, J. P., Gross, B. A., Bonaparte, R., and McKelvey, J. A. (1997). "Leachate flow in leakage collection layers due to defects in geomembrane liners." *Geosynthetics International*, 4(3-4), 215-292.

**ATTACHMENT 2
POND SIZING CALCULATION**

Attachment 1 - Pond Sizing Worksheet

Project Name: Pinon Mill - Leak Detection Sump

Project Number: 073-81694

Client: Energy Fuels Resources Corp. (EFRC)

By: DLG *DLG*

Date: 2/8/2008

Pond Depth:	5 ft	1.5 m
Pond Side 1(upper):	40 ft	12.2 m
Pond Side 2 (upper):	40 ft	12.2 m
Pond Side 1(lower):	10 ft	3.0 m
Pond Side 2 (lower):	10 ft	3.0 m
Side Slope:	3 H	1 V
Liner Overlap per Side	0 ft	0.0 m
Dry Freeboard	0 ft	0.0 m
Pond Volume w/o freeboard:	4,250 ft ³ 31,790 gal.	120 m ³ 120,441 liters
Liner Area:	1,681 ft ²	156 m ²
Pond Volume w/ freeboard:	4,250 ft ³ 31,790 gal.	120 m ³ 120,441 liters

APPENDIX E-2
PIPING CRUSHING CALCULATIONS



Subject Piñon Ridge Project
Tailings Cell Design
LCRS Pipe Crushing Calculation

Made by JDE
Checked by <i>KJM</i>
Approved by <i>KJM</i>

Job No 073-81694
Date 5/06/08
Sheet No 1 of 2

OBJECTIVE:

Evaluate the tailings cell Leak Collection and Recovery System (LCRS) (i.e., LCRS riser pipes) under loading.

GIVEN:

- LCRS riser piping consists of two 10-inch SDR17 HDPE pipes (eg., DriscoPlex™), non-corrugated, Series 1500 IPS. Pipe data included in Attachment 1, and summarized below:
 - Pipe outside diameter = 10.75 inches;
 - Pipe inside diameter = 9.41 inches;
 - Pipe wall thickness = 0.632 inches; and
 - Weight of pipe = 8.78 lb/ft.

ASSUMPTIONS:

- LCRS Riser Pipe envelope (tailings) properties assumed as follows:
 - Fine-grained soils with less than 25 percent sand, at about 85 percent relative compaction;
 - Modulus of soil reaction assumed as 500 pounds per square inch (psi);
 - Poisson's ratio = 0.30;
 - Soil friction angle = 20 degrees; and
 - Constrained modulus = 1,540 psi.
- Modulus of elasticity of pipe = 172 MPa (25,000 psi) (long term value for HDPE);
- Unit weight of tailings assumed as 100 pounds per cubic foot (pcf); and
- Pipe calculations conducted assuming depth of burial of 80 feet.
- Others, as stated

CALCULATIONS:

LCRS Riser Piping:

- Deformation characteristics calculated using modified Burns & Richard (1964) method (see Attachment 2), as follows:
 - Expected vertical deflections range from 2.4 percent (no slippage, positive strain denotes flattening) to 2.5 percent (full slippage).
 - Expected horizontal deflections range from -2.2 percent (no slippage, negative denotes outward deformation) to -2.5 percent (full slippage).



Subject Piñon Ridge Project
Tailings Cell Design
LCRS Pipe Crushing Calculation

Made by JDE
Checked by <i>KFM</i>
Approved by <i>KFM</i>

Job No 073-81694
Date 5/06/08
Sheet No 2 of 2

CONCLUSIONS:

The maximum LCRS riser pipe vertical strain was estimated at 2.5 percent. The acceptable maximum deflection for HDPE pipe is on the order of 20 percent, and the estimated deflections are considerably less than 20 percent. Therefore, pipe crushing of the LCRS riser piping is not considered a concern.

REFERENCES:

Performance Pipe website, http://www.cpchem.com/enu/performance_pipe.asp

Burns, J.Q. & Richard, R.M. (1964). Attenuation of Stresses for Buried Cylinders. Proceedings, Symposium on Soil-Structure Interaction, University of Arizona. September. 378 p.

Lupo, J.F. (2001). Stability of HDPE Pipes Under High Heap Loads, SME, Denver.

ATTACHMENT 1
MANUFACTURER PIPE DATA



PERFORMANCE PIPE Municipal & Industrial Series/IPS Pipe Data

Pipe weights are calculated in accordance with PPI TR-7. Average inside diameter calculated using nominal OD and minimum wall plus 6% for use in estimating fluid flows. Actual ID will vary. When designing components to fit the pipe ID, refer to pipe dimensions and tolerances in applicable pipe specifications.

Pressure Ratings are for water at 73.4 °F. For other fluid and service temperature, ratings may differ. Refer to Engineering Manual for Chemical and Environmental Considerations.

IPS Pipe Size	100 psi DR 17.0			80 psi DR 21.0			65 psi DR 26.0			50 psi DR 32.5			IPS Pipe Size	
	Nominal OD (in)	Minimum Wall (in)	Average ID (in)	Weight (lbs/ft)	Minimum Wall (in)	Average ID (in)	Weight (lbs/ft)	Minimum Wall (in)	Average ID (in)	Weight (lbs/ft)	Minimum Wall (in)	Average ID (in)		Weight (lbs/ft)
1 1/4"	1.660													1 1/4"
1 1/2"	1.900													1 1/2"
2"	2.375	0.140	2.078	0.43										2"
3"	3.500	0.206	3.063	0.93										3"
4"	4.500	0.265	3.938	1.54										4"
5 3/8"	5.375	0.316	4.705	2.20	0.214	4.046	1.26	0.207	4.936	1.47				5 3/8"
5"	5.563	0.327	4.870	2.35	0.256	5.001	1.80	0.214	5.109	1.57				5"
6"	6.625	0.390	5.798	3.34	0.315	5.957	2.73	0.255	6.084	2.23	0.204	6.193	1.80	6"
7 1/8"	7.125	0.419	6.237	3.86	0.339	6.406	3.16	0.274	6.544	2.58	0.219	6.661	2.08	7 1/8"
8"	8.625	0.507	7.550	5.65	0.411	7.754	4.64	0.332	7.921	3.79	0.265	8.063	3.05	8"
10"	10.750	0.632	9.410	8.78	0.512	9.665	7.21	0.413	9.874	5.87	0.331	10.048	4.75	10"
12"	12.750	0.750	11.160	12.36	0.607	11.463	10.13	0.490	11.711	8.26	0.392	11.919	6.67	12"
13 3/8"	13.375	0.787	11.707	13.61	0.637	12.025	11.15	0.514	12.285	9.09	0.412	12.502	7.35	13 3/8"
14"	14.000	0.824	12.253	14.91	0.667	12.586	12.22	0.538	12.859	9.96	0.431	13.086	8.05	14"
16"	16.000	0.941	14.005	19.46	0.762	14.385	15.96	0.615	14.696	13.01	0.492	14.957	10.50	16"
18"	18.000	1.059	15.755	24.64	0.857	16.183	20.19	0.692	16.533	16.47	0.554	16.826	13.30	18"
20"	20.000	1.176	17.507	30.41	0.952	17.982	24.93	0.769	18.370	20.34	0.615	18.696	16.41	20"
22"	22.000	1.294	19.257	36.80	1.048	19.778	30.18	0.846	20.206	24.61	0.677	20.565	19.86	22"
24"	24.000	1.412	21.007	43.81	1.143	21.577	35.91	0.923	22.043	29.30	0.738	22.435	23.62	24"
26"	26.000	1.529	22.759	51.39	1.238	23.375	42.14	1.000	23.880	34.39	0.800	24.304	27.74	26"
28"	28.000	1.647	24.508	59.62	1.333	25.174	48.86	1.077	25.717	39.88	0.862	26.173	32.19	28"
30"	30.000	1.765	26.258	68.45	1.429	26.971	56.12	1.154	27.554	45.78	0.923	28.043	36.93	30"
32"	32.000	1.882	28.010	77.86	1.524	28.769	63.84	1.231	29.390	52.10	0.985	29.912	42.04	32"
34"	34.000	2.000	29.760	87.91	1.619	30.568	72.06	1.308	31.227	58.81	1.046	31.782	47.43	34"
36"	36.000	2.118	31.510	98.57	1.714	32.366	80.78	1.385	33.064	65.94	1.108	33.651	53.20	36"
42"	42.000	2.471	36.761	134.16	2.000	37.760	109.97	1.615	38.576	89.71	1.292	39.261	72.37	42"
48"	48.000	2.824	42.013	175.23	2.286	43.154	143.65	1.846	44.086	117.18	1.477	44.869	94.56	48"
54"	54.000				2.571	48.549	181.75	2.077	49.597	148.33	1.662	50.477	119.70	54"

Performance Pipe can produce to specialized pipe dimensions. Check with your Performance Pipe contact for availability of dimensions not listed.

DRISCOPLEX and PERFORMANCE PIPE™ are trademarks of Chevron Phillips Chemical Company LP

ATTACHMENT 2

**LCRS RISER PIPE
DEFORMATION CALCULATIONS**

BURIED PLASTIC PIPE LOADING WORKSHEET V2.0

[With Incremental Stress Analysis (non-linear)]

Project: Pinon Ridge Project - Tailings Cell Design

By: JDE

Date: 5/06/08

Note: Compression is positive, tension is negative.

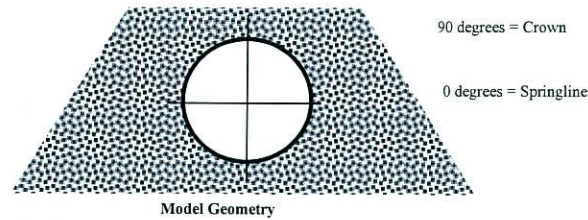

SOIL and PIPE Input Data

Material	Cohesion	Friction Angle	Lateral Pressure Parameters			
			Constrained Modulus (psi)	Lateral Stress Ratio	B	C
Pipe	n/a	n/a				
Soil (Tailings)	0	20	1540.0	0.70	0.849	0.15

Pipe Diameter (in):	10.75	DR= 16.04 55.00 0.49
Pipe ID (in):	9.41	
Weight of Pipe (lb/ft):	8.78	
Pipe Corrugated (y/n):	n	
Prescribed Constrained Modulus (y/n):	y	
Prescribed Constrained Modulus (psi):	1540	
Pipe Wall Thickness (in):	0.67	
Pipe Area (in ² /in):	21.220	
Flexural Modulus (psi), E _f =	25,000	
Ring Compression Modulus (psi), E _{rc} =	25,000	
C value (in)	0.335	selected I: 0.0251
Moment of Inertia (in ⁴ /in) non-corrugated:	0.0251	
Moment of Inertia (in ⁴ /in) corrugated (input from manufacturer data):	0.0000	
Stiffness Coefficients		
Flexural Stiffness	29.4	
Ring Compression Stiffness	105257.9	Ring Stiffness Factor: <u>4.9</u> Pipe Stiffness Less Than Soil

Shell-Medium Parameters		
UF	0.02	Extensional Flexibility ratio = Compressibility ratio = relative flexibility of pipe and soil under uniform loading.
VF	15.9	Bending Flexibility ratio = Flexibility ratio = relative flexibility of pipe and soil under varying radial and tangential loads.
If both UF and VF are zero then a perfectly rigid embedded pipe.		

Pipe Mean Radius (in):	5.04	Free Field Stress Values
Depth of Burial (ft):	80	
Applied Surface Stress (psf):	0	
Soil Density (pcf):	100	
Total Vertical Stress Component (psf):	8000	
Total Vertical Stress Component (psi):	55.6	

NO INTERFACE SLIPPAGE

Angle	Soil Stresses (psi)			Pipe Displacements (in)		Circumferential Thrust	Moment Thrust	Ring Compression Stress (psi)	Ring Compression Strain (in/in)	Ring Shortening (in)	Inner Bending Stress (psi)	Outer Bending Stress (psi)	Total Inner Stress (psi)	Total Outer Stress (psi)
	Radial	Hoop	Shear	Radial	Hoop									
0	55.5	52.4	0.0	-0.110	0.00E+00	290.6	15.4	432.7	0.0173	0.0152	206	-206	638	227
10	55.1	52.0	5.7	-0.099	3.75E-02	287.9	14.6	428.6	0.0171	0.0151	195	-195	623	234
20	53.9	50.8	10.8	-0.067	7.05E-02	280.1	12.2	417.0	0.0167	0.0147	163	-163	580	254
30	52.1	49.0	14.5	-0.018	9.50E-02	268.1	8.6	399.2	0.0160	0.0140	115	-115	514	284
40	49.9	46.8	16.5	0.042	1.08E-01	253.5	4.2	377.4	0.0151	0.0133	56	-56	433	322
50	47.6	44.4	16.5	0.106	1.08E-01	237.8	-0.5	354.1	0.0142	0.0125	-7	7	347	361
60	45.3	42.1	14.5	0.165	9.50E-02	223.2	-5.0	332.3	0.0133	0.0117	-66	66	266	399
70	43.5	40.3	10.8	0.214	7.05E-02	211.2	-8.6	314.4	0.0126	0.0111	-115	115	200	429
80	42.4	39.1	5.7	0.246	3.75E-02	203.4	-10.9	302.8	0.0121	0.0107	-146	146	157	449
90	42.0	38.7	0.0	0.257	1.34E-17	200.7	-11.8	298.8	0.0120	0.0105	-157	157	142	456

Vertical Deflection (%):	2.39
Horizontal Deflection (%):	-2.18
Radial Soil Pressure at Crown (psi):	42.0
Circumferential Shortening (in):	0.51
Arc length of each sector (in) =	0.88

6041

Max. Compressive Stress (psi): 638

Max. Tensile Stress (psi): No Tensile Stress

FULL SLIPPAGE

Angle	Soil Stresses (psi)			Pipe Displacements (in)		Circumferential Thrust	Moment Thrust	Ring Compression Stress (psi)	Ring Compression Strain (in/in)	Ring Shortening (in)	Inner Bending Stress (psi)	Outer Bending Stress (psi)	Total Inner Stress (psi)	Total Outer Stress (psi)
	Radial	Hoop	Shear	Radial	Hoop									
0	47.0	30.5	0.0	-0.125	0.00E+00	248.6	16.5	370.1	0.0148	0.0130	221	-221	591	150
10	47.1	31.4	16.1	-0.113	7.00E-02	248.4	15.6	369.8	0.0148	0.0130	209	-209	579	161
20	47.4	34.0	30.2	-0.078	1.32E-01	247.9	13.1	369.1	0.0148	0.0130	175	-175	544	194
30	47.9	38.0	40.7	-0.025	1.77E-01	247.1	9.2	367.9	0.0147	0.0129	122	-122	490	245
40	48.4	42.9	46.2	0.039	2.02E-01	246.2	4.4	366.5	0.0147	0.0129	58	-58	425	308
50	49.0	48.2	46.2	0.108	2.02E-01	245.1	-0.7	365.0	0.0146	0.0128	-10	10	355	375
60	49.6	53.1	40.7	0.173	1.77E-01	244.2	-5.5	363.6	0.0145	0.0128	-74	74	290	437
70	50.1	57.1	30.2	0.226	1.32E-01	243.4	-9.4	362.4	0.0145	0.0128	-126	126	236	488
80	50.4	59.7	16.1	0.260	7.00E-02	242.9	-12.0	361.7	0.0145	0.0127	-160	160	202	522
90	50.5	60.6	0.0	0.272	2.51E-17	242.7	-12.9	361.4	0.0145	0.0127	-172	172	189	533

Vertical Deflection (%):	2.53
Horizontal Deflection (%):	-2.47
Radial Soil Pressure at Crown (psi):	50.5
Circumferential Shortening (in):	0.51
Arc length of each sector (in) =	0.88

7268

Max. Compressive Stress (psi): 591

Max. Tensile Stress (psi): No Tensile Stress

Free Field Stress: 55.6 psi

Free Field Stress Times Pipe Radius: 881 psi

Radius (in)	CROWN				SPRINGLINE			
	Circumferential Thrust (full slip)	Circumferential Thrust (no slip)	Hoop Stress, psi (full slip)	Hoop Stress, psi (no slip)	Circumferential Thrust (full slip)	Circumferential Thrust (no slip)	Hoop Stress, psi (full slip)	Hoop Stress, psi (no slip)
5.04	242.7	200.7	60.6	38.7	248.6	290.6	30.5	52.4
5.54	266.8	220.6	53.5	38.5	273.2	319.4	38.2	53.2
6.04	290.9	240.5	49.0	38.4	297.9	348.3	43.1	53.7
6.54	315.0	260.4	46.1	38.4	322.5	377.1	46.3	54.1
7.04	339.1	280.3	44.1	38.3	347.2	405.9	48.6	54.3
7.54	363.1	300.2	42.7	38.3	371.9	434.8	50.2	54.5
8.04	387.2	320.1	41.7	38.4	396.5	463.6	51.3	54.7
8.54	411.3	340.0	41.0	38.4	421.2	492.4	52.2	54.8
9.04	435.4	360.0	40.5	38.4	445.8	521.3	52.8	54.9
9.54	459.5	379.9	40.1	38.4	470.5	550.1	53.3	55.0
10.04	483.5	399.8	39.8	38.4	495.1	578.9	53.7	55.1
10.54	507.6	419.7	39.6	38.5	519.8	607.8	54.0	55.1
11.04	531.7	439.6	39.4	38.5	544.5	636.6	54.2	55.2
11.54	555.8	459.5	39.3	38.5	569.1	665.4	54.4	55.2
12.04	579.9	479.4	39.2	38.5	593.8	694.2	54.6	55.2
12.54	603.9	499.3	39.1	38.5	618.4	723.1	54.7	55.3
13.04	628.0	519.2	39.0	38.5	643.1	751.9	54.8	55.3
13.54	652.1	539.1	39.0	38.6	667.8	780.7	54.9	55.3
14.04	676.2	559.0	38.9	38.6	692.4	809.6	55.0	55.3
14.54	700.3	578.9	38.9	38.6	717.1	838.4	55.0	55.3
15.04	724.4	598.9	38.9	38.6	741.7	867.2	55.1	55.4
15.54	748.4	618.8	38.8	38.6	766.4	896.1	55.1	55.4
16.04	772.5	638.7	38.8	38.6	791.1	924.9	55.2	55.4
16.54	796.6	658.6	38.8	38.6	815.7	953.7	55.2	55.4
17.04	820.7	678.5	38.8	38.6	840.4	982.6	55.2	55.4
Check Values:	531.7	439.6	48.3	38.4	544.5	636.6	44.0	53.8
Soil Arching:	Positive Arch	Positive Arch	Negative Arch	Negative Arch	Positive Arch	Negative Arch	Positive Arch	Positive Arch

APPENDIX F
ACTION LEAKAGE RATES

APPENDIX F

ACTION LEAKAGE RATE CALCULATION

This appendix (Appendix F-1) presents a calculation of the Action Leakage Rates (ALR) for the tailings cells proposed for construction at the Piñon Ridge Project. As per the U.S. EPA, the ALR is defined as “*the maximum design flow rate that the leak detection system (LDS) can remove without the fluid head on the bottom liner exceeding 1 foot.*”

The ALR was calculated for Tailings Cells A1 and A2, both with lined areas of 15.4 acres, and for Tailings Cells B and C, both with lined areas of 30.5 acres. The ALR was calculated to be 4,705 gallons per acre per day (gpad) for the Leak Collection and Recovery System (LCRS) sumps contained within Tailings Cells A1 and A2, and 2,376 gpad for the LCRS sumps contained within Tailings Cells B and C. If leakage rates in exceedance of these values are measured, action must be taken as per Title 40 CFR, Section 264.223.

REFERENCES

40 CFR Part 264 – “*Standards for Owners and Operators of Hazardous Waste Treatment, Storage, and Disposal Facilities*”, Subpart K (Surface Impoundments).

U.S. Environmental Protection Agency (U.S. EPA). 1992. “Action leakage rates for detection systems (supplemental background document for the final double liners and leak detection systems rule for hazardous waste landfills, waste piles, and surface impoundments).”

APPENDIX F-1
ALR CALCULATIONS

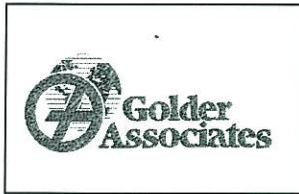

Subject	Piñon Ridge Project
	Tailings Cell Design
	Action Leakage Rate Calculation

Made by	EF
Checked by	<i>[Signature]</i>
Approved by	<i>[Signature]</i>

Job No	073-81694
Date	04/07/08
Sheet No	1 of 5

OBJECTIVE:

The objective is to determine the Action Leakage Rate (ALR) for the Piñon Ridge tailings cells. The ALR is defined as “the maximum design flow rate that the leak detection system (LDS) can remove without the fluid head on the bottom liner exceeding 1 foot” (U.S. EPA 1992; United States Government Printing Office 2002) .

GIVEN:

- Leak detection system (LDS) configuration.
- Tailings cells configuration.
- Drainage material properties.

GEOMETRY:

- The tailings cells configuration diagram is shown in Figure 1.
- A typical liner system detail is shown in Figure 2.
- Sump top dimensions of 40 feet by 40 feet for all tailings cells.

MATERIAL PROPERTIES:

Table 1 summarizes the material properties considered in the analysis for the drainage geocomposite in the slopes of the cells and drainage geonet on the floor of the cells.

Table 1. Geonet properties

<i>Manufacturer</i>	<i>Model</i>	<i>Transmissivity gal/min/ ft (m²/sec)</i>	<i>Thickness mil</i>
GSE	HyperNet HS Geonet	28.98 (6 x 10 ⁻³) ¹	275
GSE	FabriNet TRx Drainage geocomposite	12.1 (2.5 x 10 ⁻³) ¹	275

¹ see Attachment 1

METHOD:

- The ALR calculation is based on the U.S. EPA guidelines published in U.S. EPA (1992).

ASSUMPTIONS:

- Darcy’s law is valid;
- The gradient of the floor of the tailings cells is approximately 1 percent. The gradient of the side slopes for the cells is approximately 33.3%;
- One foot of water head is developed on the bottom liner.



Subject Piñon Ridge Project
Tailings Cell Design
Action Leakage Rate Calculation

Made by EF
Checked by <i>[Signature]</i>
Approved by <i>[Signature]</i>

Job No 073-81694
Date 04/07/08
Sheet No 2 of 5

CALCULATIONS:

The maximum flow rate within the LDS geonet and geocomposite are calculated using Darcy's equation :

$$Q = K i A$$

where :

- Q = flow through unit width of the LDS drainage layer [ft³/sec];
- K= hydraulic conductivity of the LDS drainage layer [ft/sec];
- i = hydraulic gradient; and
- A= area of the flow per unit width [ft²/ft].

For a geonet or drainage geocomposite, the flow through the layer is calculated by using the following equation:

$$q = i \theta W$$

where:

- q = flow through the geosynthetic layer [ft³/sec/ft];
- i = hydraulic gradient;
- θ = transmissivity [ft/sec]; and
- W= width of the drain [ft].

A factor of safety should be applied to consider the reduction in flow capacity of the geonet due to deformations, intrusions, clogging, or precipitation of chemicals (Koerner 1998) :

$$q_{allow} = q_{ult} \left[\frac{1}{RF_{IN} + RF_{CR} + RF_{CC} + RF_{BC}} \right]$$

where:

- q_{ult} = flow rate of the geosynthetic drain;
- q_{allow} = allowable flow rate;
- RF_{IN} = reduction factor for elastic deformation or intrusion;
- RF_{CR} = reduction factor for creep deformation;
- RF_{CC} = reduction factor for chemical clogging; and
- RF_{BC} = reduction factor for biological clogging.

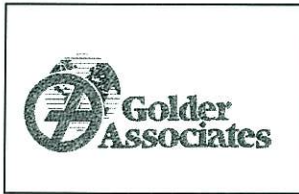

Subject	Piñon Ridge Project
Tailings Cell Design	
Action	Leakage Rate Calculation

Made by	EF
Checked by	<i>[Signature]</i>
Approved by	<i>[Signature]</i>

Job No	073-81694
Date	04/07/08
Sheet No	3 of 5

Table 2 shows the adopted reduction factors for a secondary leachate collection system according to Table 4.2 in Koerner (1998) :

Table 2. Reduction factors for determining allowable flow rate of geonets

Factor	Recommend value range	Use value for geonet	Use value for geocomposite
RF _{IN}	1.5 – 2.0	1.5 (possible elastic deformation)	2.0 (possible elastic deformation and geotextile intrusion)
RF _{CR}	1.4 – 2.0	1.4 (low normal stress)	1.4 (low normal stress)
RF _{CC}	1.5 – 2.0	2.0 (low pH liquids)	2.0 (low pH liquids)
RF _{BC}	1.5 -2.0	1.5 (low pH should preclude biological activity)	1.5 (low pH should preclude biological activity)

A water head equal to 1 foot is assumed to be acting over the bottom liner so the hydraulic gradient can be assumed to be equal to the slope of the geonet or geocomposite . For the bottom of the tailing cells:

$$i = 1\%$$

For the slopes of the tailings cells (3H:1V):

$$i = 33.3\%$$

The flow in the geonet per unit width for the bottom of the tailing cells is:

$$\frac{q_{ult}}{W} = 0.01 * 28.98 \text{ gal/ min ft} = 0.29 \text{ gal/ min ft}$$

And for the sideslopes the flow per unit width of the drainage geocomposite is:

$$\frac{q_{ult}}{W} = 0.3333 * 12.1 \text{ gal/ min ft} = 4.03 \text{ gal/ min ft}$$

The allowable flow rates per unit width for the bottom of the cell and the sideslopes are:

$$\frac{q_{allow}}{W} = \frac{q_{ult}}{W} * \frac{1}{\prod RF}$$

$$\prod RF = 1.5 + 1.4 + 2.0 + 1.5 = 6.4 \text{ for geonet}$$

$$\prod RF = 2.0 + 1.4 + 2.0 + 1.5 = 6.9 \text{ for drainage geocomposite}$$



Subject Piñon Ridge Project
Tailings Cell Design
Action Leakage Rate Calculation

Made by EF
Checked by <i>PL</i>
Approved by <i>KM</i>

Job No 073-81694
Date 04/07/08
Sheet No 4 of 5

Flow rate per unit length from cell bottom:

$$q_{1\%} = \frac{0.29 \text{ gal/min ft}}{6.4} = 0.045 \text{ gal/min ft}$$

Flow rate per unit length from cell sides slopes:

$$q_{33.3\%} = \frac{4.03 \text{ gal/min ft}}{6.9} = 0.584 \text{ gal/min ft}$$

Flow access to the sump is a function of the perimeter length of the crest of the sump. The sump is located at the low point of each cell and adjacent to two sideslopes. As shown in Figure 1, the sump will receive leachate from the cell bottom on two sides and from the sideslope on two sides. The flow rate to a sump is:

$$q_{1\%} * \text{perimeter length of sump in that flow direction (2 sides)} + q_{33.3\%} * \text{perimeter length of Sump in that flow direction (2 sides)}$$

The ALR expressed in gallons per acre per day (gpad) for each cell is summarized in Table 3:

Table 3. Action leakage rates for different cells expressed in gpad

Sump	Perimeter Length of Sumps		Cell Area (Acres)	ALR (gpd)	ALR (gpad)
	1% slope (ft)	33.3% slope (ft)			
Cell A1	80	80	15.4	72,461	4,705
Cell A2	80	80	15.4	72,461	4,705
Cell B	80	80	30.5	72,461	2,376
Cell C	80	80	30.5	72,461	2,376

CONCLUSIONS:

Per EPA guidance, the Action Leakage Rate (ALR) was calculated assuming one foot of water head on the bottom geomembrane liner of the tailings cells double composite liner system. The ALR was calculated to be 4,705 gpad for cells A1 and A2 and 2,376 gpad for cells B and C.



Subject	Piñon Ridge Project
Tailings Cell Design	
Action Leakage Rate Calculation	

Made by	EF
Checked by	<i>[Signature]</i>
Approved by	<i>[Signature]</i>

Job No	073-81694
Date	04/07/08
Sheet No	5 of 5

REFERENCES:

Colorado Department of Public Health and the Environment (CDPHE), Hazardous Waste Regulations 6 CCR 1007-1, Parts 3 and 18.

Koerner, R. M. (1998). *Designing with geosynthetics*, Prentice Hall, Upper Saddle River, N.J.

U.S. EPA. (1992). "Action leakage rates for detection systems (supplemental background document for the final double liners and leak detection systems rule for hazardous waste landfills, waste piles, and surface impoundments)." U.S. Environmental Protection Agency.

United States Government Printing Office. (2002). *Title 40, CFR*, U.S. G.P.O., Washington, D.C.

FIGURES

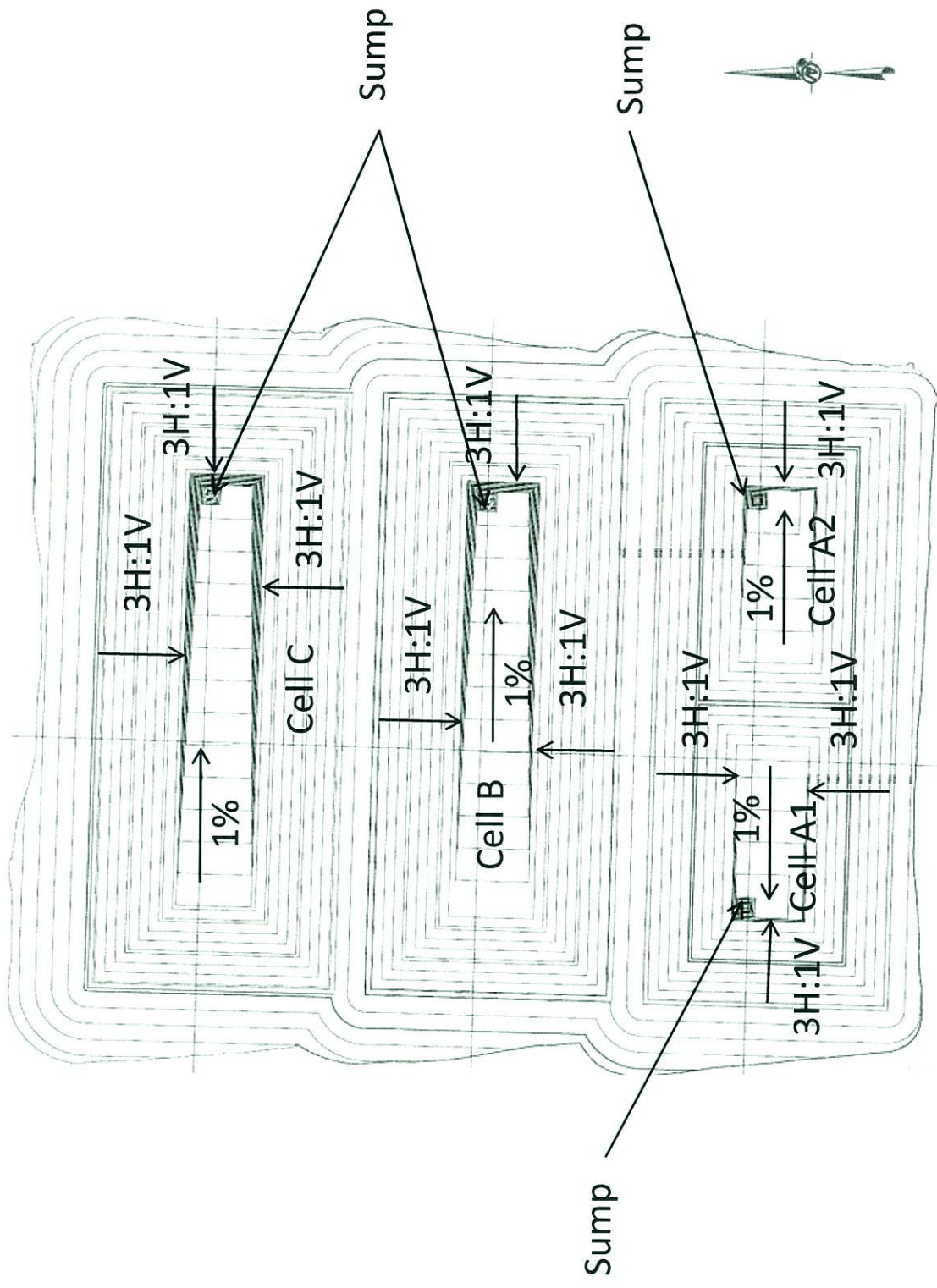

TAILINGS CELLS CONFIGURATION

TITLE

CLIENT/PROJECT

Golder Associates
 DENVER, COLORADO
 ENERGY FUELS RESOURCES CORPORATION
 PIÑON RIDGE PROJECT - TAILINGS CELLS DESIGN
 MONTROSE COUNTY, COLORADO

DRAWN EF

CHECKED *EFM*
 REVIEWED *EFM*

DATE FEBRUARY 5 2008

SCALE N.T.S.

JOB NO. 073-81694

DWG. NO.

FIGURE NO. 1

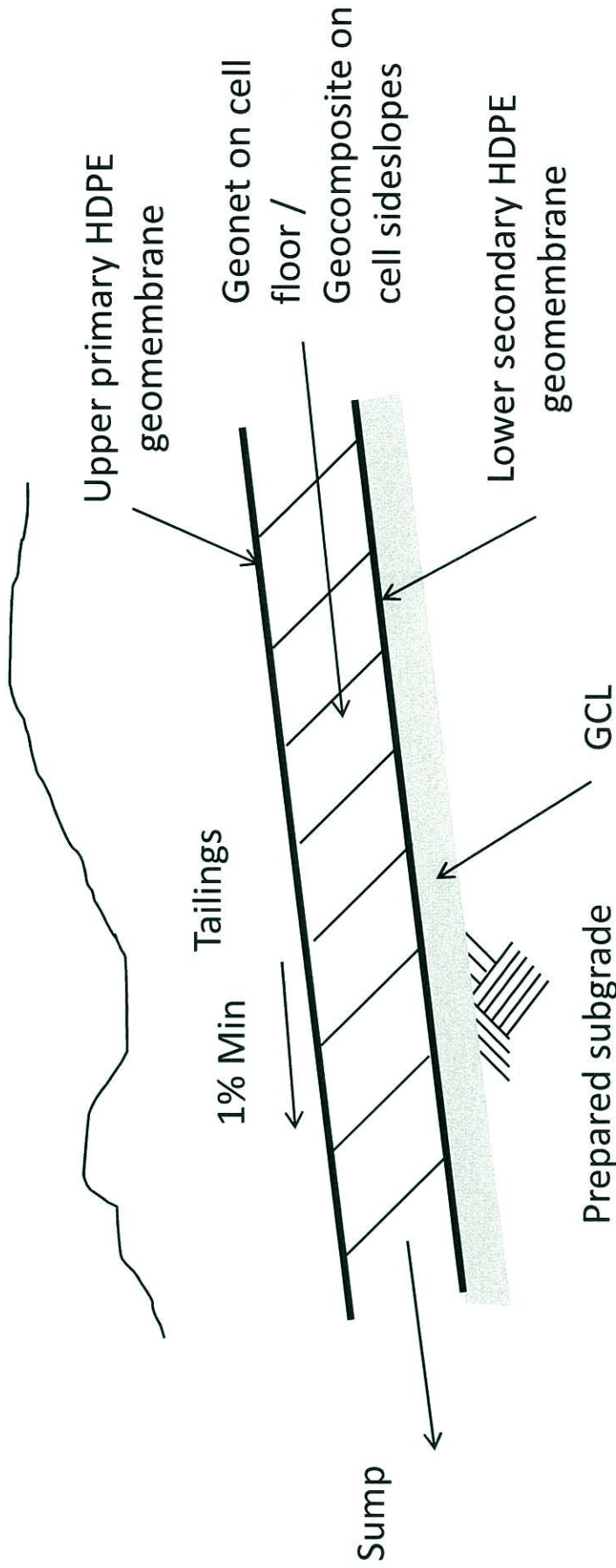

LINER SYSTEM TYPICAL DETAIL

TITLE

CLIENT/PROJECT	Denver, Colorado	DATE	FEBRUARY 5 2008	JOB NO.	073-81694
		CHECKED	N.T.S.	DWG. NO.	
		REVIEWED		FILE NO.	FIGURE NO. 2



ENERGY FUELS RESOURCES CORPORATION
 PIÑON RIDGE PROJECT – TAILINGS CELLS DESIGN
 MONTROSE COUNTY, COLORADO

DRAWN EF
 CHECKED *KFM*
 REVIEWED *KFM*

ATTACHMENT 1



GSE Drainage Performance Series

Product Data Sheet **GSE FabriNet TRx Geocomposites (Double-Sided)**

GSE FabriNet TRx high flow geocomposites are produced with a unique one step process that coextrudes creep resistant columns to an intrusion resistant roof. The resulting tri-axial geonet is then laminated to a nonwoven geotextile filtration media. GSE FabriNet TRx achieves high in-situ transmissivity from optimally oriented flow channels that maintain porosity because of the intrusion and creep resistant nature of the tri-axial structure. GSE FabriNet TRx provides continuous performance over a broad range of conditions. It is also well suited for use in surface water collection and removal systems, gas venting, and landfill liner system drainage applications.

Product Specifications

TESTED PROPERTY	TEST METHOD	FREQUENCY	MINIMUM AVERAGE ROLL VALUE		
Geocomposite - GSE FabriNet TRx			4 oz/yd ²	6 oz/yd ²	8 oz/yd ²
Product Code			FS82040040T	FS82060060T	FS82080080T
Transmissivity ^(b) , gal/min/ft (m ² /sec)	ASTM D 4716	1/540,000 ft ²	12.1 (2.5x10 ⁻³)	12.1 (2.5x10 ⁻³)	10.1 (2.2x10 ⁻³)
Ply Adhesion, lb/in (g/cm)	ASTM D 7005	1/50,000 ft ²	1.0 (178)	1.0 (178)	1.0 (178)
Roll Width ^(a) , ft (m)			15 (4.5)	15 (4.5)	15 (4.5)
Roll Length ^(a) , ft (m)			140 (42)	130 (39)	130 (39)
Roll Area, ft ² (m ²)			2,100 (195)	1,950 (181)	1,950 (181)
Geonet Core - GSE HyperNet TRx					
Transmissivity ^(c) , gal/min/ft (m ² /sec)	ASTM D 4716	1/540,000 ft ²	43.5 (9.0 x10 ⁻³)		
Density, g/cm ³	ASTM D 1505	1/50,000 ft ²	> 0.94		
Tensile Strength ^(e) , lb/in (N/mm)	ASTM D 5035	1/50,000 ft ²	75 (13.3)		
Carbon Black Content (%)	ASTM D 1603*/4218	1/50,000 ft ²	> 2.0		
Geotextile - (Prior to lamination)					
Mass per Unit Area	ASTM D 5261	1/90,000 ft ²	4	6	8
Grab Tensile, lb (N)	ASTM D 4632	1/90,000 ft ²	120 (530)	170 (755)	220 (975)
Puncture Strength, lb (N)	ASTM D 4833	1/90,000 ft ²	60 (265)	90 (395)	120 (525)
AOS, US Sieve (mm)	ASTM D 4751	1/540,000 ft ²	70	70	80
Permittivity, sec ⁻¹	ASTM D 4491	1/540,000 ft ²	1.5	1.5	1.5
Flow Rate, gpm/ft ² (lpm/m ²)	ASTM D 4491	1/540,000 ft ²	120 (4,885)	110 (4,480)	110 (4,480)
UV Resistance, % retained	ASTM D 4355 (after 500 hours)	once per formulation	70	70	70

NOTES:

- ^(a) Roll widths and lengths have a tolerance of ±1%.
- ^(b) This is an index transmissivity value measured at stress = 1,000 psf; gradient = 0.1; time = 15 minutes; boundary conditions = plate/geocomposite/plate. Contact GSE for performance transmissivity value for use in design.
- ^(c) This is an index transmissivity value measured at stress = 1,000 psf; gradient = 0.1; time = 15 minutes; boundary conditions = plate/geonet/plate. Contact GSE for performance transmissivity value for use in design.
- ^(d) All properties are minimum average roll values based on the cumulative results of specimens tested and determined by GSE except AOS (mm) which is a maximum average roll value (MaxARV); and UV resistance which is a typical value.
- ^(e) Tested in machine direction (MD).
- *Modified.

DS026 Fabrinet TRX R01/07/08

This information is provided for reference purposes only and is not intended as a warranty or guarantee. GSE assumes no liability in connection with the use of this information. Please check with GSE for current, standard minimum quality assurance procedures and specifications.

GSE and other trademarks in this document are registered trademarks of GSE Lining Technology, Inc. in the United States and certain foreign countries.



North America	GSE Lining Technology, Inc.	Houston, Texas	800.435.2008	281.443.8564	Fax: 281.230.6739
South America	GSE Lining Technology Chile S.A.	Santiago, Chile		56.2.595.4200	Fax: 56.2.595.4290
Asia Pacific	GSE Lining Technology Company Limited	Bangkok, Thailand		66.2.937.0091	Fax: 66.2.937.0097
Europe & Africa	GSE Lining Technology GmbH	Hamburg, Germany		49.40.767420	Fax: 49.40.7674234
Middle East	GSE Lining Technology-Egypt	The 6th of October City, Egypt		20.2.828.8888	Fax: 20.2.828.8889



GSE STANDARD PRODUCTS

Product Data Sheet

GSE HyperNet Geonets

GSE HyperNet geonets are synthetic drainage materials manufactured from a premium grade high density polyethylene (HDPE) resin. The structure of the HyperNet geonet is formed specifically to transmit fluids uniformly under a variety of field conditions. HDPE resins are inert to chemicals encountered in most of the civil and environmental applications where these materials are used. GSE geonets are formulated to be resistant to ultraviolet light for time periods necessary to complete installation. GSE HyperNet geonets are available in standard, HF, HS, and UF varieties.

The table below provides index physical, mechanical and hydraulic characteristics of GSE geonets. Contact GSE for information regarding performance of these products under site-specific load, gradient, and boundary conditions.

Product Specifications

TESTED PROPERTY	TEST METHOD	FREQUENCY	MINIMUM AVERAGE ROLL VALUE ^(c)			
			HyperNet	HyperNet HF	HyperNet HS	HyperNet UF
Product Code			XL4000N004	XL5000N004	XL7000N004	XL8000N004
Transmissivity ^(a) , gal/min/ft (m ² /sec)	ASTM D 4716-00	1/540,000 ft ²	9.66 (2 x 10 ⁻³)	14.49 (3 x 10 ⁻³)	28.98 (6 x 10 ⁻³)	38.64 (8 x 10 ⁻³)
Thickness, mil (mm)	ASTM D 5199	1/50,000 ft ²	200 (5)	250 (6.3)	275 (7)	300 (7.6)
Density, g/cm ³	ASTM D 1505	1/50,000 ft ²	0.94	0.94	0.94	0.94
Tensile Strength (MD), lb/in (N/mm)	ASTM D 5035	1/50,000 ft ²	45 (7.9)	55 (9.6)	65 (11.5)	75 (13.3)
Carbon Black Content, %	ASTM D 1603, modified	1/50,000 ft ²	2.0	2.0	2.0	2.0
Roll Width, ft (m)			15 (4.6)	15 (4.6)	15 (4.6)	15 (4.6)
Roll Length, ft (m) ^(b)			300 (91)	250 (76)	220 (67)	200 (60)
Roll Area, ft ² (m ²)			4,500 (418)	3,750 (348)	3,300 (305)	3,000 (278)

NOTES:

- ^(a)Gradient of 0.1, normal load of 10,000 psf, water at 70° F (20° C), between steel plates for 15 minutes.
- ^(b)Please check with GSE for other available roll lengths.
- ^(c)These are MARV values that are based on the cumulative results of specimens tested by GSE.

DS017 R07/07/03

This information is provided for reference purposes only and is not intended as a warranty or guarantee. GSE assumes no liability in connection with the use of this information. Please check with GSE for current, standard minimum quality assurance procedures and specifications.

GSE and other marks used in this document are trademarks and service marks of GSE Lining Technology, Inc; certain of which are registered in the U.S.A. and other countries.

Americas	GSE Lining Technology, Inc.	Houston, Texas	800-435-2008	281-443-8564	Fax: 281-230-8650
Europe/Middle East/Africa	GSE Lining Technology GmbH	Hamburg, Germany		49-40-767420	Fax: 49-40-7674233
Asia/Pacific	GSE Lining Technology Company Ltd.	Bangkok, Thailand		66-2-937-0091	Fax: 66-2-937-0097

This product data sheet is also available on our website at:

www.gseworld.com

APPENDIX G
CHEMICAL RESISTANCE INFORMATION

APPENDIX G

CHEMICAL RESISTANCE INFORMATION

Appendix G-1 presents a Chemical Resistance Chart listing the resistance of high density polyethylene (HDPE) to various chemicals at various concentrations and temperatures (GSE, 2006). An 'S' in the resistance column stands for satisfactory, specifically "*Liner material is resistant to the given reagent at the given concentration and temperature. No mechanical or chemical degradation is observed.*" Other qualitative descriptions include 'L' – limited application possible, and 'U' – unsatisfactory.

When the anticipated tailings stream chemical concentrations (CH2M Hill, 2008) are compared with some relevant reagents presented in the Chemical Resistance Chart, the following results are found:

- Sulfuric Acid (H_2SO_4)
 - Concentration in tailings stream – 0.084 g/l, or 0.0084 percent (CH2M Hill, 2008).
 - Highest satisfactory concentration at 68 degrees Fahrenheit ($^{\circ}\text{F}$) – 98 percent (GSE, 2006).
 - *Therefore, HDPE exhibits satisfactory resistance to the expected sulfuric acid concentration.*
- Ferric Sulfate ($\text{Fe}_2(\text{SO}_4)_3$)
 - Concentration in tailings stream – 35.989 g/l, or 3.6 percent (CH2M Hill, 2008).
 - Highest satisfactory concentration at 68 $^{\circ}\text{F}$ – fully saturated solution (GSE, 2006).
 - *Therefore, HDPE exhibits satisfactory resistance to the expected ferric sulfate concentration.*
- Ammonium Sulfate ($(\text{NH}_4)_2\text{SO}_4$)
 - Concentration in tailings stream – 34.9 g/l, or 3.5 percent (CH2M Hill, 2008).
 - Highest satisfactory concentration at 68 $^{\circ}\text{F}$ – fully saturated solution (GSE, 2006).
 - *Therefore, HDPE exhibits satisfactory resistance to the expected ammonium sulfate concentration.*
- Sodium Sulfate (Na_2SO_4)
 - Concentration in tailings stream – 3.917 g/l, or 0.39 percent (CH2M Hill, 2008).
 - Highest satisfactory concentration at 68 $^{\circ}\text{F}$ – fully saturated solution (GSE, 2006).

- *Therefore, HDPE exhibits satisfactory resistance to the expected sodium sulfate concentration.*
- Sodium Chloride (NaCl)
 - Concentration in tailings stream – 5.8 g/l, or 0.58 percent (CH2M Hill, 2008).
 - Highest satisfactory concentration at 68 °F – fully saturated solution (GSE, 2006).
 - *Therefore, HDPE exhibits satisfactory resistance to the expected sodium chloride concentration.*

Note that only the most toxic and most highly concentrated reagents are presented here. Ratings are based on single reagent concentrations and do not account for the presence of multiple reagents in the same solution.

REFERENCES

Gundle/SLT Environmental, Inc. (GSE). 2006. Chemical Resistance Chart. Technical Note TN032. <http://www.gseworld.com/Literature/TechnicalNotes/PDF/TN032ResistChart.pdf>.

CH2M Hill. 2008. Piñon Ridge Project – Tailings Stream Analysis (Rev. 2). 12 March 2008.

APPENDIX G-1
CHEMICAL RESISTANCE CHART



Chemical Resistance Chart

GSE is the world's leading supplier of high quality, polyethylene geomembranes. GSE polyethylene geomembranes are resistant to a great number and combinations of chemicals. Note that the effect of chemicals on any material is influenced by a number of variable factors such as temperature, concentration, exposed area and duration. Many tests have been performed that use geomembranes and certain specific chemical mixtures. Naturally, however, every mixture of chemicals cannot be tested for, and various criteria may be used to judge performance. Reported performance ratings may not apply to all applications of a given material in the same chemical. Therefore, these ratings are offered as a guide only. This information is provided for reference purposes only and is not intended as a warranty or guarantee. GSE assumes no liability in connection with the use of this information.

Medium	Concentration	Resistance at:	
		20 °C (68 °F)	60 °C (140 °F)
A			
Acetic acid	100%	S	L
Acetic acid	10%	S	S
Acetic acid anhydride	100%	S	L
Acetone	100%	L	L
Adipic acid	sat. sol.	S	S
Allyl alcohol	96%	S	S
Aluminum chloride	sat. sol.	S	S
Aluminum fluoride	sat. sol.	S	S
Aluminum sulfate	sat. sol.	S	S
Alum	sol.	S	S
Ammonia, aqueous	dil. sol.	S	S
Ammonia, gaseous dry	100%	S	S
Ammonia, liquid	100%	S	S
Ammonium chloride	sat. sol.	S	S
Ammonium fluoride	sol.	S	S
Ammonium nitrate	sat. sol.	S	S
Ammonium sulfate	sat. sol.	S	S
Ammonium sulfide	sol.	S	S
Amyl acetate	100%	S	L
Amyl alcohol	100%	S	L
Aniline	100%	S	L
Antimony trichloride	90%	S	S
Arsenic acid	sat. sol.	S	S
Aqua regia	HCl-HNO ₃	U	U
B			
Barium carbonate	sat. sol.	S	S
Barium chloride	sat. sol.	S	S
Barium hydroxide	sat. sol.	S	S
Barium sulfate	sat. sol.	S	S
Barium sulfide	sol.	S	S
Benzaldehyde	100%	S	L
Benzene	—	L	L
Benzoic acid	sat. sol.	S	S
Beer	—	S	S
Borax (sodium tetraborate)	sat. sol.	S	S
Boric acid	sat. sol.	S	S
Bromine, gaseous dry	100%	U	U
Bromine, liquid	100%	U	U
Butane, gaseous	100%	S	S
1-Butanol	100%	S	S
Butyric acid	100%	S	L
C			
Calcium carbonate	sat. sol.	S	S
Calcium chlorate	sat. sol.	S	S
Calcium chloride	sat. sol.	S	S
Calcium nitrate	sat. sol.	S	S
Calcium sulfate	sat. sol.	S	S
Calcium sulfide	dil. sol.	L	L
Carbon dioxide, gaseous dry	100%	S	S
Carbon disulfide	100%	L	U
Carbon monoxide	100%	S	S
Chloroacetic acid	sol.	S	S
Carbon tetrachloride	100%	L	U
Chlorine, aqueous solution	sat. sol.	L	U
Chlorine, gaseous dry	100%	L	U
Chloroform	100%	U	U
Chromic acid	20%	S	L
Chromic acid	50%	S	L
Citric acid	sat. sol.	S	S

Medium	Concentration	Resistance at:	
		20 °C (68 °F)	60 °C (140 °F)
Copper chloride	sat. sol.	S	S
Copper nitrate	sat. sol.	S	S
Copper sulfate	sat. sol.	S	S
Cresylic acid	sat. sol.	L	—
Cyclohexanol	100%	S	S
Cyclohexanone	100%	S	L
D			
Decahydronaphthalene	100%	S	L
Dextrine	sol.	S	S
Diethyl ether	100%	L	—
Diethylphthalate	100%	S	L
Dioxane	100%	S	S
E			
Ethandiol	100%	S	S
Ethanol	40%	S	L
Ethyl acetate	100%	S	U
Ethylene trichloride	100%	U	U
F			
Ferric chloride	sat. sol.	S	S
Ferric nitrate	sol.	S	S
Ferric sulfate	sat. sol.	S	S
Ferrous chloride	sat. sol.	S	S
Ferrous sulfate	sat. sol.	S	S
Fluorine, gaseous	100%	U	U
Fluorosilicic acid	40%	S	S
Formaldehyde	40%	S	S
Formic acid	50%	S	S
Formic acid	98-100%	S	S
Furfuryl alcohol	100%	S	L
G			
Gasoline	—	S	L
Glacial acetic acid	96%	S	L
Glucose	sat. sol.	S	S
Glycerine	100%	S	S
Glycol	sol.	S	S
H			
Heptane	100%	S	U
Hydrobromic acid	50%	S	S
Hydrobromic acid	100%	S	S
Hydrochloric acid	10%	S	S
Hydrochloric acid	35%	S	S
Hydrocyanic acid	10%	S	S
Hydrofluoric acid	4%	S	S
Hydrofluoric acid	60%	S	L
Hydrogen	100%	S	S
Hydrogen peroxide	30%	S	L
Hydrogen peroxide	90%	S	U
Hydrogen sulfide, gaseous	100%	S	S
L			
Lactic acid	100%	S	S
Lead acetate	sat. sol.	S	—
M			
Magnesium carbonate	sat. sol.	S	S
Magnesium chloride	sat. sol.	S	S
Magnesium hydroxide	sat. sol.	S	S
Magnesium nitrate	sat. sol.	S	S
Maleic acid	sat. sol.	S	S
Mercuric chloride	sat. sol.	S	S

Medium	Concentration	Resistance at:	
		20 °C (68 °F)	60 °C (140 °F)
Mercuric cyanide	sat. sol.	S	S
Mercuric nitrate	sol.	S	S
Mercury	100%	S	S
Methanol	100%	S	S
Methylene chloride	100%	L	—
Milk	—	S	S
Molasses	—	S	S
N			
Nickel chloride	sat. sol.	S	S
Nickel nitrate	sat. sol.	S	S
Nickel sulfate	sat. sol.	S	S
Nicotinic acid	dil. sol.	S	—
Nitric acid	25%	S	S
Nitric acid	50%	S	U
Nitric acid	75%	U	U
Nitric acid	100%	U	U
O			
Oils and Grease	—	S	L
Oleic acid	100%	S	L
Orthophosphoric acid	50%	S	S
Orthophosphoric acid	95%	S	L
Oxalic acid	sat. sol.	S	S
Oxygen	100%	S	L
Ozone	100%	L	U
P			
Petroleum (kerosene)	—	S	L
Phenol	sol.	S	S
Phosphorus trichloride	100%	S	L
Photographic developer	cust. conc.	S	S
Picric acid	sat. sol.	S	—
Potassium bicarbonate	sat. sol.	S	S
Potassium bisulfide	sol.	S	S
Potassium bromate	sat. sol.	S	S
Potassium bromide	sat. sol.	S	S
Potassium carbonate	sat. sol.	S	S
Potassium chlorate	sat. sol.	S	S
Potassium chloride	sat. sol.	S	S
Potassium chromate	sat. sol.	S	S
Potassium cyanide	sol.	S	S
Potassium dichromate	sat. sol.	S	S
Potassium ferricyanide	sat. sol.	S	S
Potassium ferrocyanide	sat. sol.	S	S
Potassium fluoride	sat. sol.	S	S
Potassium hydroxide	10%	S	S
Potassium hydroxide	sol.	S	S
Potassium hypochlorite	sol.	S	L
Potassium nitrate	sat. sol.	S	S
Potassium orthophosphate	sat. sol.	S	S
Potassium perchlorate	sat. sol.	S	S
Potassium permanganate	20%	S	S
Potassium persulfate	sat. sol.	S	S
Potassium sulfate	sat. sol.	S	S
Potassium sulfite	sol.	S	S
Propionic acid	50%	S	S
Propionic acid	100%	S	L
Pyridine	100%	S	L
Q			
Quinol (Hydroquinone)	sat. sol.	S	S
S			
Salicylic acid	sat. sol.	S	S

Medium	Concentration	Resistance at:	
		20 °C (68 °F)	60 °C (140 °F)
Silver acetate	sat. sol.	S	S
Silver cyanide	sat. sol.	S	S
Silver nitrate	sat. sol.	S	S
Sodium benzoate	sat. sol.	S	S
Sodium bicarbonate	sat. sol.	S	S
Sodium biphosphate	sat. sol.	S	S
Sodium bisulfite	sol.	S	S
Sodium bromide	sat. sol.	S	S
Sodium carbonate	sat. sol.	S	S
Sodium chlorate	sat. sol.	S	S
Sodium chloride	sat. sol.	S	S
Sodium cyanide	sat. sol.	S	S
Sodium ferricyanide	sat. sol.	S	S
Sodium ferrocyanide	sat. sol.	S	S
Sodium fluoride	sat. sol.	S	S
Sodium hydroxide	40%	S	S
Sodium hydroxide	sat. sol.	S	S
Sodium hypochlorite	15% active chlorine	S	S
Sodium nitrate	sat. sol.	S	S
Sodium nitrite	sat. sol.	S	S
Sodium orthophosphate	sat. sol.	S	S
Sodium sulfate	sat. sol.	S	S
Sodium sulfide	sat. sol.	S	S
Sulfur dioxide, dry	100%	S	S
Sulfur trioxide	100%	U	U
Sulfuric acid	10%	S	S
Sulfuric acid	50%	S	S
Sulfuric acid	98%	S	U
Sulfuric acid	fuming	U	U
Sulfurous acid	30%	S	S
T			
Tannic acid	sol.	S	S
Tartaric acid	sol.	S	S
Thionyl chloride	100%	L	U
Toluene	100%	L	U
Triethylamine	sol.	S	L
U			
Urea	sol.	S	S
Urine	—	S	S
W			
Water	—	S	S
Wine vinegar	—	S	S
Wines and liquors	—	S	S
X			
Xylenes	100%	L	U
Y			
Yeast	sol.	S	S
Z			
Zinc carbonate	sat. sol.	S	S
Zinc chloride	sat. sol.	S	S
Zinc (II) chloride	sat. sol.	S	S
Zinc (IV) chloride	sat. sol.	S	S
Zinc oxide	sat. sol.	S	S
Zinc sulfate	sat. sol.	S	S

Specific immersion testing should be undertaken to ascertain the suitability of chemicals not listed above with reference to special requirements.

NOTES:

(S) **Satisfactory:** Liner material is resistant to the given reagent at the given concentration and temperature. No mechanical or chemical degradation is observed.

(L) **Limited Application Possible:** Liner material may reflect some attack. Factors such as concentration, pressure and temperature directly affect liner performance against the given media. Application, however, is possible under less severe conditions, e.g. lower concentration, secondary containment, additional liner protections, etc.

(U) **Unsatisfactory:** Liner material is not resistant to the given reagent at the given concentration and temperature. Mechanical and/or chemical degradation is observed.

(-) **Not tested**

sat. sol. = Saturated aqueous solution, prepared at 20°C (68°F)

sol. = aqueous solution with concentration above 10% but below saturation level

dil. sol. = diluted aqueous solution with concentration below 10%

cust. conc. = customary service concentration

TN032 ResistChart R03/17/06

This information is provided for reference purposes only and is not intended as a warranty or guarantee. GSE assumes no liability in connection with the use of this information. Please check with GSE for current, standard minimum quality assurance procedures and specifications.

GSE and other trademarks in this document are registered trademarks of GSE Lining Technology, Inc. in the United States and certain foreign countries.

North America	GSE Lining Technology, Inc.	Houston, Texas	800 435 2008	281 443 8564	Fax: 281 230 8650
South America	GSE Lining Technology Chile S.A.	Santiago, Chile		56 2 595 4200	Fax: 56 2 595 4290
Asia Pacific	GSE Lining Technology Company Limited	Bangkok, Thailand		66 2 937 0091	Fax: 66 2 937 0097
Europe & Africa	GSE Lining Technology GmbH	Hamburg, Germany		49 40 767420	Fax: 49 40 7674234
Middle East	GSE Lining Technology-Egypt	The 6th of October City, Egypt		202 2 828 8888	Fax: 202 2 828 8889

APPENDIX H
STABILITY EVALUATION

APPENDIX H

STABILITY EVALUATION

Golder conducted local and global stability analyses to evaluate the stability of the proposed tailings facility for the Piñon Ridge Project. This appendix presents the stability evaluations in detail.

DESIGN SECTIONS

For the global stability analyses, three cross-sections (see Figures 2 through 4 in Appendix H-1) were developed to represent a typical section through a tailings cell at three critical points in time:

- *End of Construction* – This phase represents the geometry after cell construction, but prior to any filling of the cells. The exposed 3H:1V interior cell slopes results in this being the critical phase in terms of stability. External embankment slopes are 5H:1V.
- *Post Tailings Deposition* – This phase represents the geometry after full tailings deposition, but prior to any cover placement. The cell geometry is the same except for the presence of the tailings. The tailings act to buttress the exposed slopes in the previous phase, increasing the overall stability.
- *Post Closure* – This phase represents the geometry after a cover has been placed over the tailings cells at closure. External embankment slopes are 10H:1V per closure requirements, and the mound geometry is assumed to extend this slope over the deposited tailings. Eight feet of loosely compacted cover fill was assumed to cap the mound.

For each case, the cell foundation was conservatively assumed to consist entirely of overburden soils even though bedrock is expected in some locations based on the geotechnical investigations.

MATERIAL PROPERTIES

The material properties used in the analyses were selected based on the results of laboratory testing. The properties of the various materials used in the stability model are discussed below:

- *Overburden Soil* - The overburden soil was modeled with a total unit weight of 107 pounds per cubic foot (pcf) based on average measurements of several in-situ soil samples. The friction angle (33.7 degrees) and cohesion (0 psf) were modeled as the lowest measured effective strength properties from two consolidated-undrained (CU) triaxial tests conducted on undisturbed samples of foundation soil.
- *Structural Fill* - Structural fill was modeled with a total unit weight of 120 pcf based on average measurements of native soil samples remolded to 95 percent of the standard Proctor maximum dry density (ASTM D698). The friction angle (30.3 degrees) and cohesion (0 psf) were modeled as the lowest measured effective strength properties from two consolidated-undrained (CU) triaxial tests conducted on remolded samples of native soil.
- *Tailings (slurry)* - Based on Golder's past experience with freshly deposited tailings, a friction angle of 20 degrees and a cohesion of 0 psf were assumed for the tailings in slurry form. These properties were used for the post deposition scenario as the tailings would have had insufficient time for complete consolidation. The total unit weight is assumed to be 120 pcf.
- *Tailings (consolidated)* - Based on Golder's past experience with consolidated tailings, a friction angle of 28 degrees and a cohesion of 0 psf were assumed for the tailings in consolidated (i.e., dewatered) form. These properties were used for the post closure scenario as the tailings would likely have had sufficient time to consolidate. The total unit weight is assumed to be 120 pcf.
- *Miscellaneous Fill* - Miscellaneous fill refers to the fill resulting from the excavation and disposal of the evaporation ponds, ore pad, and other contaminated soils requiring disposal and encapsulation at closure. The stability analyses assume the strength properties of the miscellaneous fill to be the same as those for the consolidated tailings, with a slightly lower total unit weight (110 pcf).
- *Cover Fill* - Compaction effort applied to the cover fill is expected to be light in order to enhance vegetative growth, so a reduced total unit weight of 100 pcf was used assuming approximately 80 to 85 percent of the standard Proctor maximum dry density. A friction angle of 23 degrees with zero cohesion was assumed.

- *Liner Interface* - Interface friction testing revealed the weakest interface to be that between the proposed textured geomembrane and the drainage geocomposite material (specifically, 60 mil textured HDPE geomembrane versus CETCO Texdrain 250 DS 6 Geocomposite) with a peak friction angle of 21.2 degrees and associated residual friction angle of 14.8 degrees. The global stability analyses were conducted using the peak friction angle, and checked to ensure a safety factor in excess of one using the residual friction angle, per the recommendations of Gilbert (2001). The minimum residual friction angle does not necessarily correspond to the minimum tested residual friction angle (i.e., textured geomembrane versus GCL), but instead that which corresponds to the minimum peak friction angle (Gilbert, 2001). The small amounts of apparent adhesion were conservatively ignored, using a value of zero in the stability analyses.

PHREATIC LEVELS

As the water table below the site is substantially below the zone of interest in the stability analysis (i.e., greater than 450 ft below the ground surface), the only relevant phreatic surface will be that contained within the tailings cell by the cell liner as a result of tailings deposition (during operations). At the end of construction, the cell is empty, so no phreatic surface was modeled for the first phase. Post-deposition, the phreatic surface was assumed to be at the surface of the tailings, affecting the tailings slurry material and the liner interface. Post-closure, the tailings are assumed to consolidate with the phreatic surface remaining at the tailings surface.

METHOD OF ANALYSES

For all failure mechanisms considered in the analyses, slope stability was evaluated using limit equilibrium methods based on Spencer's method of analysis (Spencer's method) (Spencer, 1967). Spencer's method is a method of slices (referencing the analysis' consideration of potential failure masses as rigid bodies divided into adjacent regions or "slices," separated by vertical boundary planes). It is based on the principle of limiting equilibrium, i.e., the method calculates the shear strengths that would be required to just maintain equilibrium along the selected failure plane, and then determines a "safety factor" by dividing the available shear strength by the required shear strength. Consequently, safety factors calculated by Spencer's, or by any other limiting equilibrium method, indicate the percentage by which the available shear strength exceeds, or falls short of, that required to maintain equilibrium. Therefore, safety factors in excess of 1.0 indicate stability and those less than 1.0 indicate instability, while the greater the mathematical difference between a safety factor and

1.0, the larger the "margin of safety" (for safety factors in excess of 1.0), or the more extreme the likelihood of failure (for safety factors less than 1.0). While there are other more rigorous methods that can be used to evaluate slope stability, Spencer's method was selected to be consistent with the current level of knowledge of the material shear strength parameters.

The seepage and stability analyses were conducted using *SLIDE 5.0*, a commercially available computer program (Rocscience, 2000), and the input parameters presented herein. For accurate modes of failure, Spencer's method was used to determine the least stable failure surface via the critical surface search routine, i.e., for each failure mode, the program iterates through a variety of failure surfaces to determine the surface with the minimum safety factor, otherwise referred to as the critical surface.

LOADING CONDITIONS

The stability analyses considered both static and earthquake-induced (i.e., pseudo-static) stress conditions. Static loading considers only the stress of the soil and tailings deposited at the designed slopes. For the tailings impoundment design, the design criteria provides for a minimum factor of safety of 1.5 under static loading conditions, per the industry standard of practice.

Earthquake (seismic) loading conditions were simulated using a pseudo-static approach. Pseudo-static-based analyses are commonly used to apply equivalent seismic loading on earthfill structures. In an actual seismic event, the peak acceleration would be sustained for only a fraction of a second. Actual seismic time histories are characterized by multiple-frequency attenuating motions. The accelerations produced by seismic events rapidly reverse motion and generally tend to build to a peak acceleration that quickly decays to lesser accelerations. Consequently, the duration that a mass is actually subjected to a unidirectional, peak seismic acceleration is finite, rather than infinite. The pseudo-static analyses conservatively model seismic events as constant acceleration and direction, i.e., an infinitely long pulse. Therefore, it is customary for geotechnical engineers to take only a fraction of the predicted peak maximum acceleration when modeling seismic events using pseudo-static analyses. Typically a factor of safety of 1.0 is considered appropriate for water retention embankments (i.e., critical structures) when the structures are modeled using one-half the peak ground acceleration generated from the maximum credible earthquake (Hynes & Franklin, 1984). A twenty (20) percent strength reduction factor is often applied to any fine-grained materials that are susceptible to strain softening resulting from a build-up in pore water pressures (Hynes &

Franklin, 1984). For these analyses, no materials were assumed to exhibit strain softening characteristics.

The pseudo-static coefficient for the stability analyses was developed by Kleinfelder (2008) for this evaluation based on the 2006 International Building Code (IBC). This seismicity analysis concluded that the peak ground acceleration (PGA) for the maximum considered earthquake (MCE) is 0.161g. The peak ground acceleration for the design earthquake is 0.107g. Hence, the pseudo-static acceleration used in the stability analyses for the pre- and post-deposition cases was 0.05g, or approximately one-half of the design earthquake PGA. For the post-closure case, a pseudo-static acceleration of 0.08g was used, or approximately one-half of the MCE PGA. For the tailings impoundment design, the design provides for a minimum factor of safety of 1.1 under pseudo-static loading conditions, per industry standard of practice.

RESULTS OF ANALYSES

The limit equilibrium stability analyses yielded the estimated minimum safety factors summarized in Table H-1 for static stability analyses and pseudo-static stability analyses for all three scenarios. As indicated, the stability analyses show that the static and pseudo-static critical failure surfaces have factors of safety greater than the minimum values set forth in the design criteria.

LINER STABILITY ANALYSIS

In addition to the stability analyses discussed above, a separate simplified analysis was conducted to estimate the factor of safety of the liner system under its own weight. Interface shear testing of the liner system, presented in Appendix H-1, indicates that the textured HDPE versus the drainage geocomposite exhibits the lowest peak shear strength. Analyses of the liner system stability, presented in Appendix H-2, conservatively assumes that the liner slope is infinitely long (i.e., effects of the anchor trench, benches and buttressing were ignored) per the approach proposed by Das (1998), as well as ignores the effects of apparent adhesion along the interface. This simplified analysis results in a factor of safety against sliding of the liner system of 1.2.

REFERENCES

- Das, Braja M. 1998. *Principles of Geotechnical Engineering, 4th Edition*. PWS Publishing Company, Boston.
- Gilbert, R.B. 2001. "Peak Versus Residual Strength for Waste Containment Systems." In *Proceedings of GRI-15: Hot Topics in Geosynthetics II*. Geosynthetics Research Institute, Folsom, PA, 29-39.
- Hynes, M.E. and Franklin, A.G., 1984. "Rationalizing the Seismic Coefficient Method." U.S. Department of the Army. Waterways Experiment Station. U.S. Army Corps of Engineers (USACE). Miscellaneous Paper GL-84-13.
- Kleinfelder. 2008. "*Design Ground Motions at Piñon Uranium Mill, Colorado.*" Draft Memo to K. Morrison, Golder Associates, Inc. 14 January 2008.
- Rocscience, 2000. *Users Manual Slide Version 5.0*, Rocscience.
- Spencer, E., 1967. "A Method of Analysis of the Stability of Embankments Assuming Parallel Inter-Slice Forces." *Geotechnique*, Vol. XVII, No. 1, pp. 11-26.

TABLE H-1

RESULTS OF STABILITY EVALUATION

Scenario	Minimum Static Factor of Safety [Peak (Residual)]	Minimum Pseudo-Static Factor of Safety [Peak (Residual)]
Pre-Deposition	2.0 (1.9)	1.7 (1.7)
Post-Deposition	3.0 (3.0)	2.4 (2.4)
Post-Closure	4.9 (4.4)	2.7 (2.3)

APPENDIX H-1
GLOBAL STABILITY EVALUATION



Subject Piñon Ridge Project
Tailings Cells
Global Stability Analyses

Made by JDE
Checked by <i>DLG</i>
Approved by <i>KFW</i>

Job No 073-81694
Date 5/07/08
Sheet No 1 of 3

OBJECTIVES:

- Evaluate the global stability of the proposed Tailings Cells at the most critical cross section for the following three scenarios:
 - After construction of the cells, but prior to tailings deposition (pre deposition);
 - After tailings deposition to the design fill height within the cell (post deposition); and
 - After placement of closure cover and 10H:1V grading (post closure).

GIVEN:

- Topography for the original ground surface and proposed tailings cells grading plan (Figure 1).
- Underlying stratigraphy from nearby boreholes.
- Laboratory strength test results for recompacted native soils (GA-TP-07, GA-TP-09) and in-situ native soils (GA-BH-42, GA-BH-47) (Attachment 1).
- Liner interface friction properties from laboratory tests for the following interfaces, which represent the tailings cell liner configuration: (1) textured geomembrane vs. geocomposite; (2) textured geomembrane vs. GCL; (3) GCL vs. subgrade (Attachment 2).
- Peak ground acceleration (A_{peak}) for the design earthquake is 0.107g (Kleinfelder, 2008).
- Peak ground acceleration (A_{peak}) for the maximum considered earthquake (MCE) is 0.161g (Kleinfelder, 2008).

ASSUMPTIONS:

- The critical cross sections identified for the stability evaluation are shown in Figures 2 through 4 for the pre deposition, post deposition, and post closure scenarios, respectively.
- Water is assumed to be absent for the pre deposition case. For the post deposition and post closure scenarios, the water surface is assumed to be at the tailings surface and affect only the tailings and liner interface layers.
- Shallow (< 15 feet) veneer failure surfaces are ignored.
- Use pseudo-static model to evaluate the seismic stability. Check stability using a horizontal load coefficient of $\frac{1}{2}A_{peak}$, where the design earthquake applies to the pre deposition and post deposition scenarios ($\frac{1}{2}A_{peak} = 0.05g$), and the MCE applies to the post closure scenario ($\frac{1}{2}A_{peak} = 0.08g$) (Hynes & Franklin, 1984).
- Minimum acceptable factor of safety (FS) for static conditions is 1.5 per the design criteria.
- Minimum acceptable FS for seismic conditions is 1.1 per the design criteria.
- Minimum acceptable FS for residual strength analysis is 1.0 per Gilbert, 2001.
- The liner is assumed to be a 1-foot thick material layer with the peak and residual strength properties associated with the liner interface with the lowest peak shear strength (geomembrane-geocomposite) as per Gilbert (2001).
- The internal shear strength of the individual material components is assumed to be greater than the geomembrane-geocomposite interface strength.
- The overburden soil is sufficiently deep not to warrant the inclusion of bedrock materials in these analyses.
- Minimum thickness of closure cover soils is 8 feet.

MATERIAL PROPERTIES:

- The material parameters used in the stability analyses are summarized in Table 1.



Subject Piñon Ridge Project
Tailings Cells
Global Stability Analyses

Made by JDE
Checked by <i>DCG</i>
Approved by <i>KAM</i>

Job No 073-81694
Date 5/07/08
Sheet No 2 of 3

Table 1 – Material Properties

Material	Unit Weight (pcf)	Friction Angle (deg)	Cohesion (psf)	Source
Overburden Soil	107	33.7	0	Lowest undisturbed triaxial test results (GA-BH-47)
Structural Fill	120	30.3	0	Lowest of remolded triaxial test results (GA-TP-07)
Tailings (slurry) ⁽¹⁾	120	20	0	Assumed based on past tailings experience
Tailings (consol) ⁽²⁾	120	28	0	Assumed based on past tailings experience
Misc. Fill	110	28	0	Assumed same as consolidated tailings
Cover Fill	100	23	0	Assumed – light compaction on native soils
Liner Interface (peak) ⁽³⁾	110	21.2	0	Lowest peak strength from interface shear testing (geomembrane-geocomposite)
Liner Interface (residual) ⁽³⁾	110	14.8	0	Residual strength associated with geomembrane-geocomposite interface

- (1) Tailings (slurry) properties used for post deposition scenario.
- (2) Tailings (consol) properties used for post closure scenario.
- (3) Two sets of analyses were conducted: one using the peak interface shear strength and one using the residual interface shear strength.

METHOD:

- Stability analyses were performed with RocScience’s limit equilibrium program SLIDE. Minimum factors of safety were evaluated using the program’s search algorithm and calculations based on the Spencer method.
- Both circular and non-circular (block) failure surfaces were analyzed for the critical cross sections.
- The three aforementioned scenarios (pre deposition, post deposition, and post closure) were evaluated for stability. Loading stages intermediate to these scenarios were not evaluated.
- Both the peak and residual strengths of the liner system are governed by the liner interface with the weakest peak strength (Gilbert, 2001). Consequently, the liner was modeled using the interface strength properties associated with the geomembrane-geocomposite interface.
- While determining the stability of the tailings cell, the critical failure surfaces were typically block failure surfaces located primarily along the liner. However, circular potential failure surfaces and other block potential failure surfaces through all materials were checked.
- Shallow veneer potential failure surfaces less than 15 feet deep were not considered critical to the stability of the structure.

CALCULATIONS:

- The SLIDE stability results are presented in Attachment 3. The global minimum factors of safety are summarized in Table 2. The stability results for each individual analysis are summarized in Tables A3-1 and A3-2 in Attachment 3.

RESULTS:

- The static and seismic analyses for all three cross sections analyzed yield factors of safety which exceed the minimum requirements as shown in Table 2.



Subject Piñon Ridge Project
Tailings Cells
Global Stability Analyses

Made by JDE
Checked by <i>DLG</i>
Approved by <i>KAm</i>

Job No 073-81694
Date 5/07/08
Sheet No 3 of 3

Table 2 – Stability Analysis Summary

Scenario	Minimum Static Factor of Safety [peak (residual)]	Minimum Pseudo-Static Factor of Safety [peak (residual)]
Pre Deposition	2.0 (1.9)	1.7 (1.7)
Post Deposition	3.0 (3.0)	2.4 (2.4)
Post Closure	4.9 (4.4)	2.7 (2.3)

- The critical failure mechanism for the pre-deposition scenario (both static and pseudo-static) was found to be a circular failure surface through the upper portion of the tailings cell interior.
- The critical failure mechanism for the post-deposition scenario (both static and pseudo-static) was found to be a circular failure surface through the structural fill on the tailings cell exterior.
- The critical failure mechanism for the post-closure scenario (both static and pseudo-static) was found to be a block (wedge) failure surface with the toe of the failure surface sliding up the liner interface.

CONCLUSIONS

- Based on stability modeling, the factor of safety for the theoretical, worst-case-scenario cross section was found to meet design criteria factors of safety for all scenarios analyzed.
- The lowest factors of safety occur prior to tailings deposition.
- These analyses are considered conservative based on the strength parameters used and assumptions made.

REFERENCES:

Gilbert, R.B. (2001). “Peak Versus Residual Strength for Waste Containment Systems.” In *Proceedings of GRI-15: Hot Topics in Geosynthetics II*. Geosynthetics Research Institute, Folsom, PA, 29-39.

Hynes, M.E. and Franklin, A.G. (1984). “Rationalizing the Seismic Coefficient Method.” US Army Final Report, July 1984.

Kleinfelder, Inc. (Kleinfelder) (2008). “Design Ground Motions at Piñon Uranium Mill, Colorado.” Memorandum to Golder, January 14, 2008.

RocScience (2000). Users Manual – SLIDE version 5.0.

FIGURES

EVAPORATION POND AREA
(APPROXIMATELY 80 ACRES)

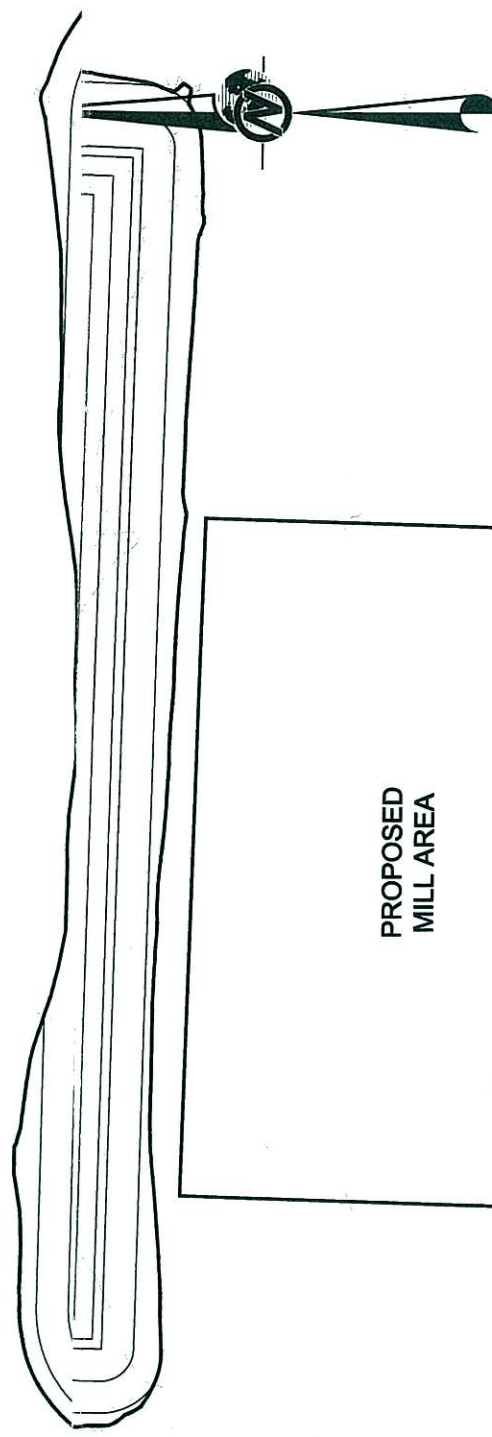

TAILINGS CELL TOPOGRAPHY

FIGURE 1

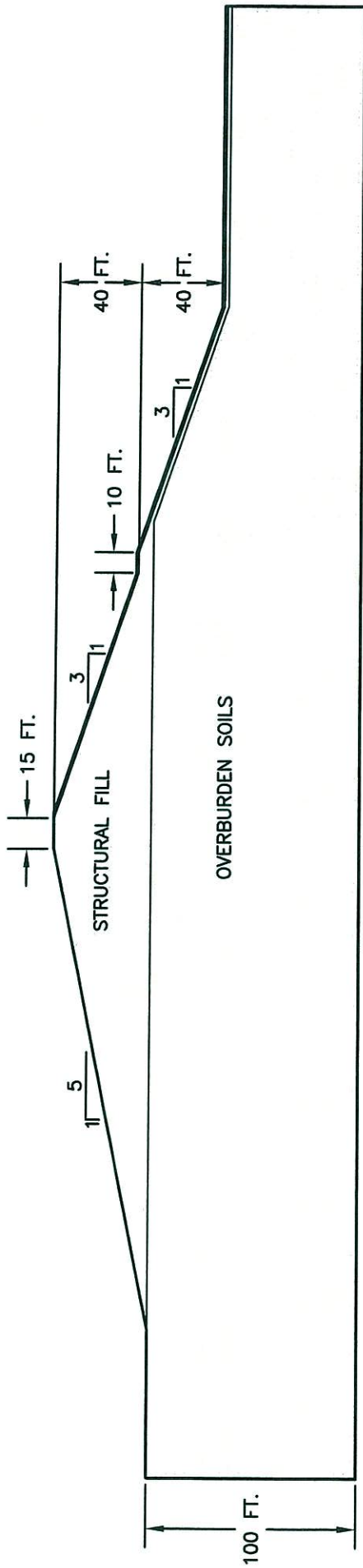

REV	DATE	JDE	DES	STABILITY CALCULATION	JDE	KFM	JMJ
Δ	02/08	JDE	DES	REVISION DESCRIPTION	CADD	CHK	RWW

PROJECT ENERGY FUELS RESOURCES CORPORATION
 PIÑON RIDGE PROJECT - TAILINGS CELL DESIGN
 MONTROSE COUNTY, COLORADO

TITLE

PROJECT No.	073-81694	FILE No.	MAX SECTION
DESIGN	JDE	02/08	SCALE
CADD	JDE	02/08	FIGURE
CHECK	KFM	02/08	
REVIEW	JMJ	02/08	

THEORETICAL TAILINGS CELL MAXIMUM CROSS SECTION - PRE DEPOSITION

2

Golder Associates
DENVER, COLORADO

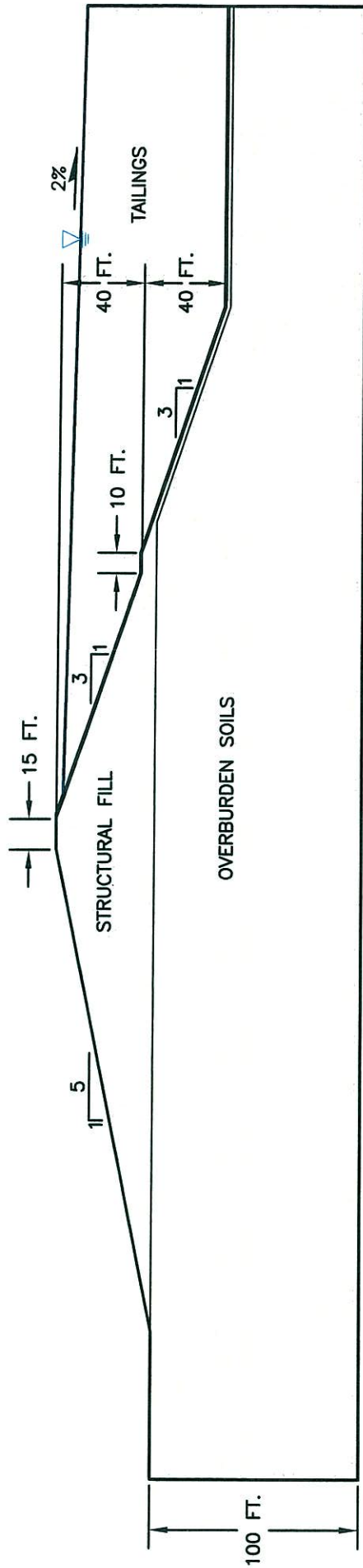

REV	DATE	JDE	DES	STABILITY CALCULATION	JDE	KFM	JMU
REV	DATE	JDE	DES	REVISION DESCRIPTION	CADD	CHK	R/W
				PROJECT	ENERGY FUELS RESOURCES CORPORATION		
				PIÑON RIDGE PROJECT - TAILINGS CELL DESIGN			
				MONTROSE COUNTY, COLORADO			
				TITLE	THEORETICAL TAILINGS CELL MAXIMUM CROSS SECTION - POST DEPOSITION		
		PROJECT No.	073-81694	FILE No.			
DESIGN	JDE	02/08	SCALE	NTS	REV.	A	
CADD	JDE	02/08	FIGURE	3			
CHECK	KFM	02/08					
REVIEW	JMU	02/08					



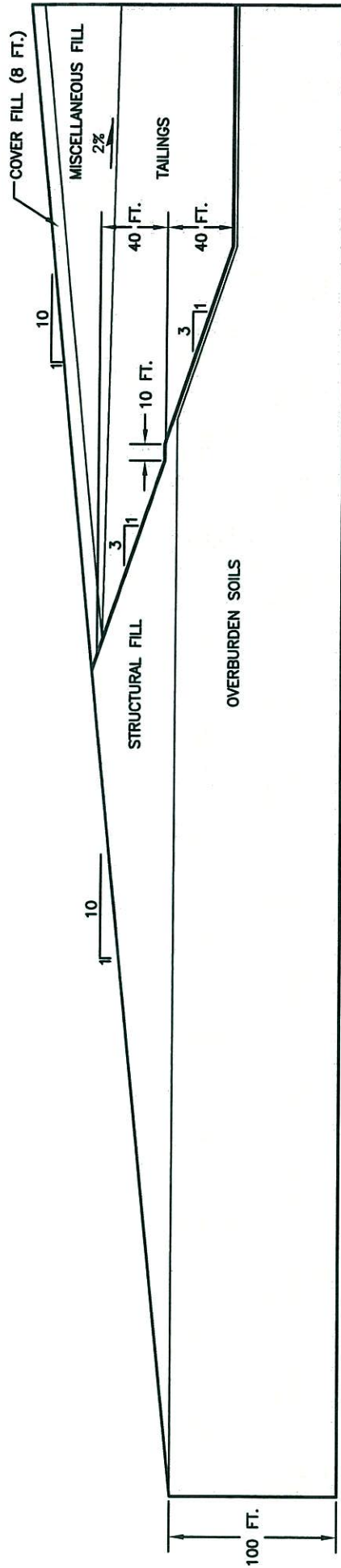

REV	DATE	JDE	DES	STABILITY CALCULATION	JDE	KFM	JMU
REV	DATE	JDE	DES	REVISION DESCRIPTION	CADD	CHK	ROW
PROJECT ENERGY FUELS RESOURCES CORPORATION							
PIÑON RIDGE PROJECT - TAILINGS CELL DESIGN							
MONTROSE COUNTY, COLORADO							
TITLE THEORETICAL TAILINGS CELL MAXIMUM CROSS SECTION - POST CLOSURE							
PROJECT No. 073-81684		FILE No.		MAX SECTION			
DESIGN	JDE	02/08	SCALE	NTS	REV.	A	
CADD	JDE	02/08	FIGURE	4			
CHECK	KFM	02/08					
REVIEW	JMU	02/08					



**ATTACHMENT 1
LABORATORY TRIAXIAL TEST RESULTS**

**Mohr's Circle Diagram
Effective Stress Parameters**

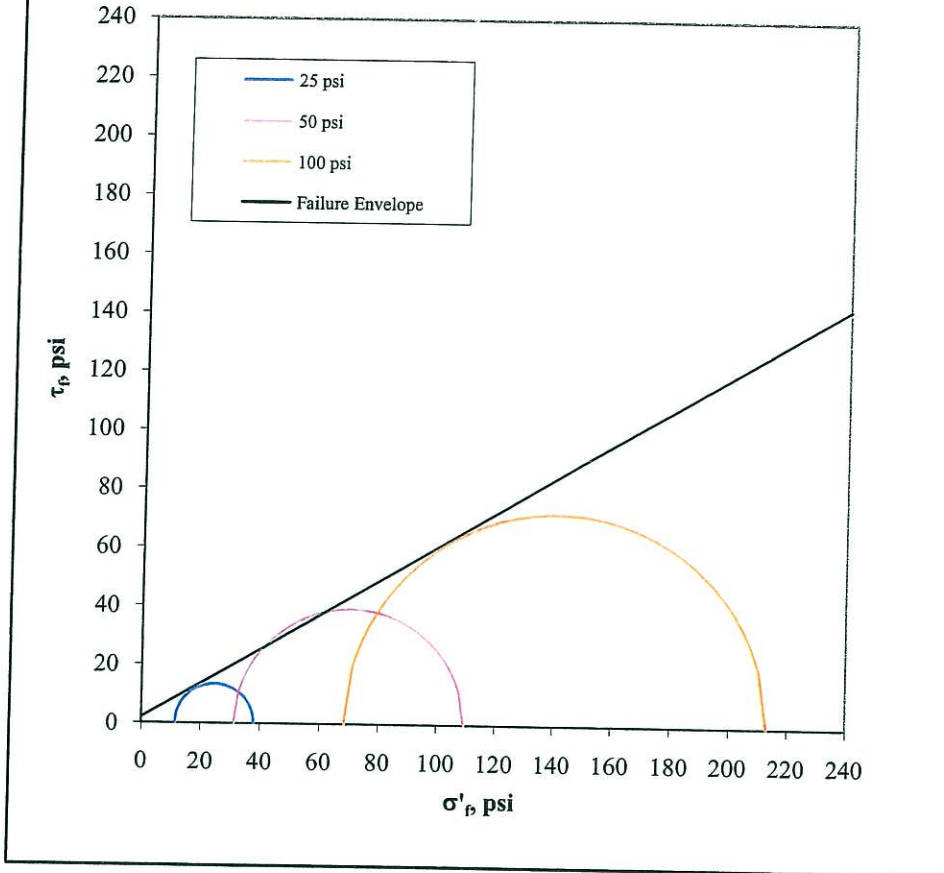

Effective Stress Shear Strength Parameters

$\phi' = 30.3 \text{ degrees}$
 $c' = 2.0 \text{ psi}$

Golder Associates, Inc. Denver, Colorado		Title: C-U TRIAXIAL SHEAR DATA MOHR'S CIRCLE DIAGRAM		
Job Short Title: EFR/Pinon Ridge				
Sample Number: GATP 7 @ 1.5-9	Reviewed: JEO	Date: 1/28/08	Job Number: 073-81694.001	Figure: 1-1

**Mohr's Circle Diagram
Effective Stress Parameters**

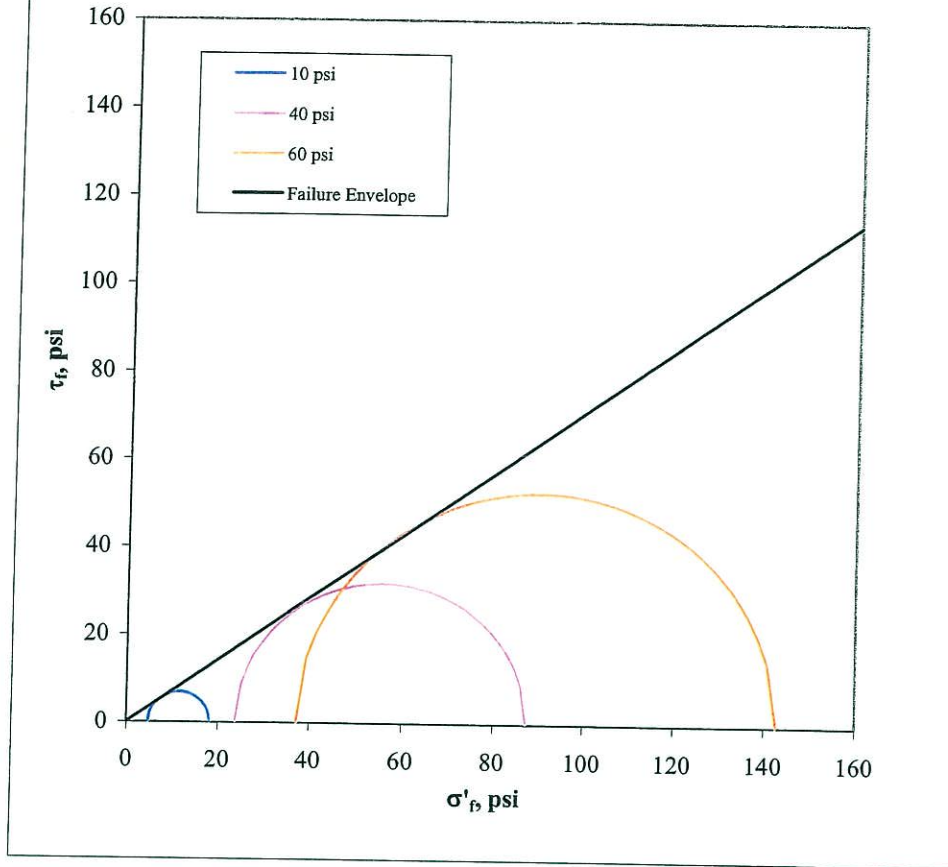

Effective Stress Shear Strength Parameters

$\phi' = 35.5$ degrees

$c' = 0.0$ psi

Golder Associates, Inc. Denver, Colorado		Title: C-U TRIAXIAL SHEAR DATA MOHR'S CIRCLE DIAGRAM		
Job Short Title: EFR/Pinion Ridge				
Sample Number: GATP 9 @ 1-11	Reviewed: JEO	Date: 1/18/08	Job Number: 073-81694.001	Figure: 1-2

**Mohr's Circle Diagram
Effective Stress Parameters**

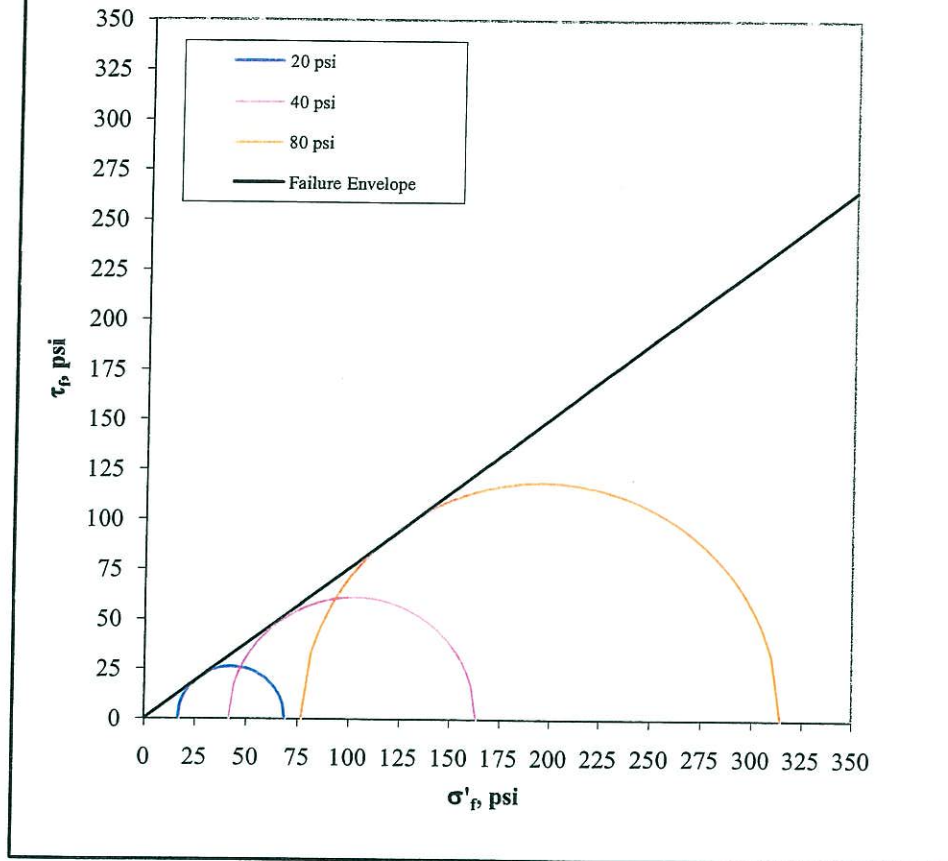

Effective Stress Shear Strength Parameters

$\phi' = 37.1$ degrees
 $c' = 0.0$ psi

Golder Associates, Inc. Denver, Colorado		Title:	
Job Short Title: Energy Fuels/Geotech Piñon Ridge		C-U TRIAXIAL SHEAR DATA MOHR'S CIRCLE DIAGRAM	
Sample Number: GABH 42 @ 10-11'	Reviewed: JEO	Date: 2/14/08	Job Number: 073-81694
			Figure: 1-3

**Mohr's Circle Diagram
Effective Stress Parameters**

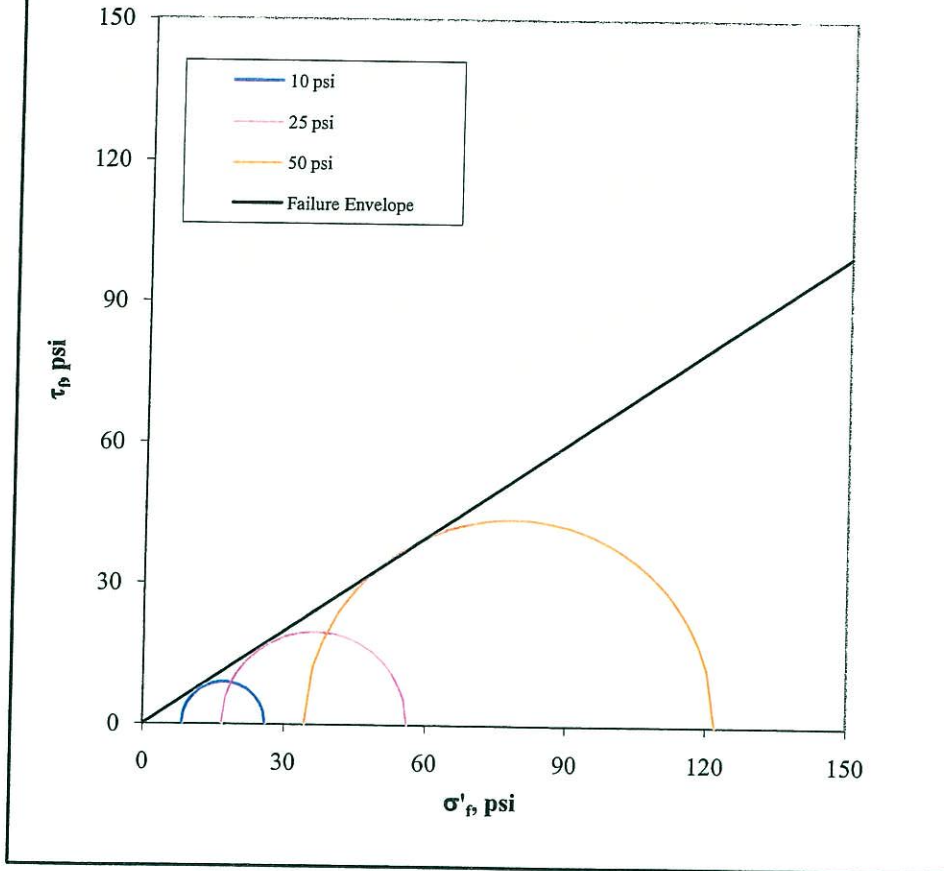

Effective Stress Shear Strength Parameters

$\phi' = 33.7$ degrees

$c' = 0.0$ psi

Golder Associates, Inc. Denver, Colorado		Title:		
Job Short Title: Energy Fuels/Geotech Pinon Ridge		C-U TRIAXIAL SHEAR DATA MOHR'S CIRCLE DIAGRAM		
Sample Number: GABH 47 @ 2-3.5'	Reviewed: JEO	Date: 2/11/08	Job Number: 073-81694	Figure: 1-4

ATTACHMENT 2
LINER INTERFACE SHEAR STRENGTH TESTING

DIRECT SHEAR TEST RESULTS

ASTM D5321

PROJECT NAME: ENERGY FUELS/GEOTECH PINON RIDGE/CO
 SAMPLE NUMBER: 1 (GM vs GC)

INTERFACE TESTED: 60 mil TEXTURED HDPE GEOMEMBRANE vs TEXDRAIN 250 DS 6 GEOCOMPOSITE
 TEST CONDITIONS: INTERFACES WETTED, CONSOLIDATED 15 min AT NORMAL LOAD
 SHEAR RATE: 0.2 in/min
 SUBSTRATE: TEXTURED RIGID PLATES

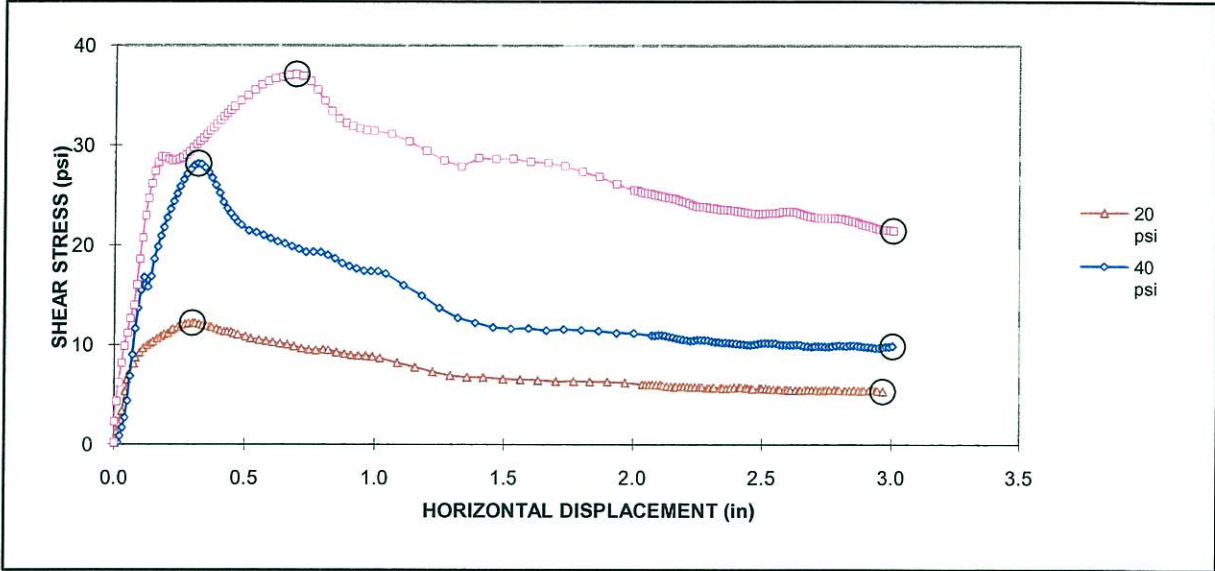

Normal Stress (psi)	Shear Stress		Peak		Residual	
	Peak ¹ (psi)	Residual (psi)	Friction Angle	Adhesion ² (psi)	Friction Angle	Adhesion ² (psi)
20	12.2	5.3				
40	28.2	9.9	21.2	7.7	14.8	0.0
80	37.1	21.5				

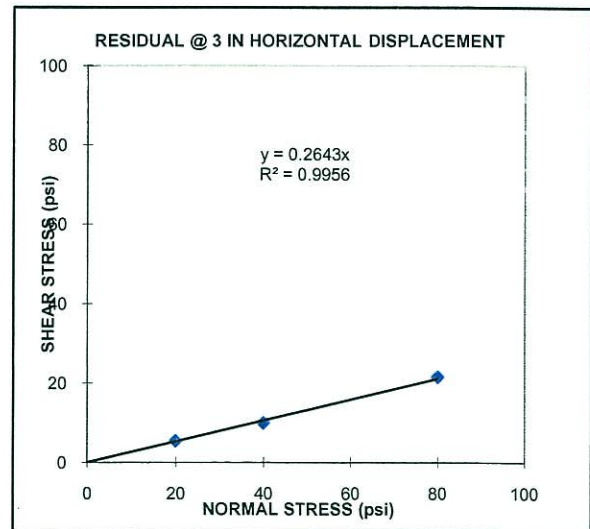
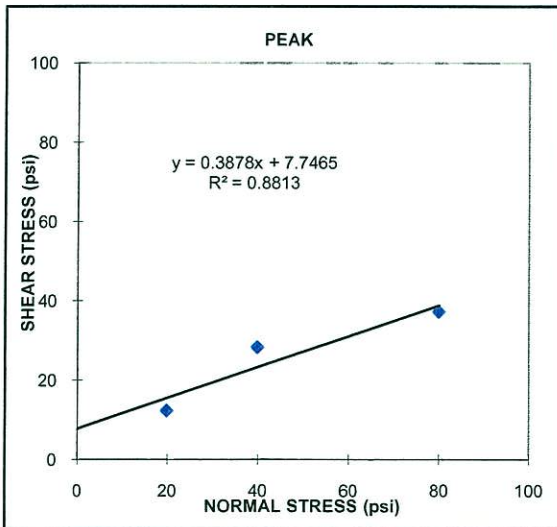

Observations After Test

- 20 psi: Shearing occurred at the interface between the Geomembrane and the Geocomposite
- 40 psi: Shearing occurred at the interface between the Geomembrane and the Geocomposite
- 80 psi: Shearing occurred at the interface between the Geomembrane and the Geocomposite

(1) The peak shear stresses for 20, 40, and 80 psi normal stresses were chosen at 0.300, 0.319, and 0.693 in horizontal displacements, respectively.
 (2) The adhesion value is based on the "best-fit" line which may not show true adhesion.

DIRECT SHEAR TEST RESULTS

ASTM D6243

PROJECT NAME: ENERGY FUELS/GEOTECH PINON RIDGE/CO
 SAMPLE NUMBER: 5 (GM vs GCL)

INTERFACE TESTED: 60 mil TEXTURED HDPE GEOMEMBRANE vs CETCO BENTOMAT ST GCL (woven side against Geomembrane)
 TEST CONDITIONS: INTERFACES WETTED, CONSOLIDATED 15 min AT NORMAL LOAD
 SHEAR RATE: 0.2 in/min
 SUBSTRATE: TEXTURED RIGID PLATES

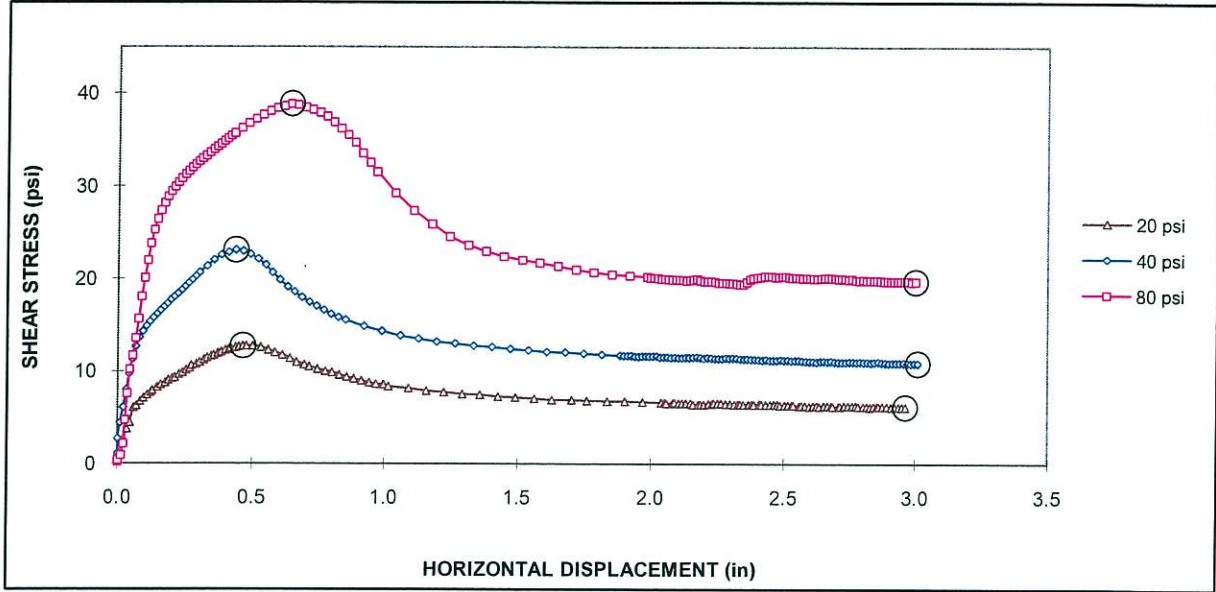

Normal Stress (psi)	Shear Stress		Peak		Residual	
	Peak ¹ (psi)	Residual (psi)	Friction Angle	Adhesion ² (psi)	Friction Angle	Adhesion ² (psi)
20	12.7	6.1	23.2	4.9	12.7	1.7
40	23.1	10.9				
80	38.8	19.7				

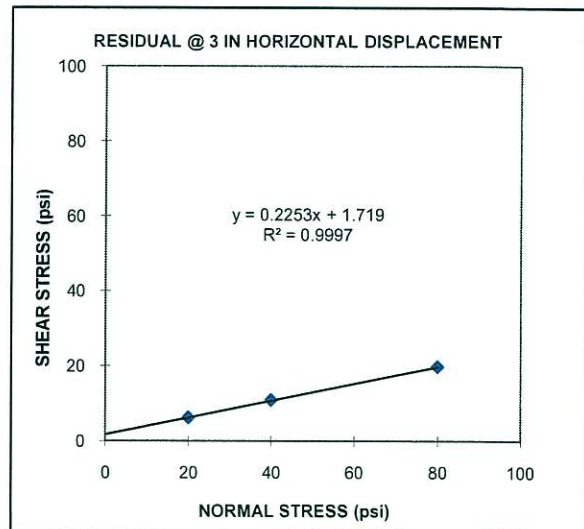
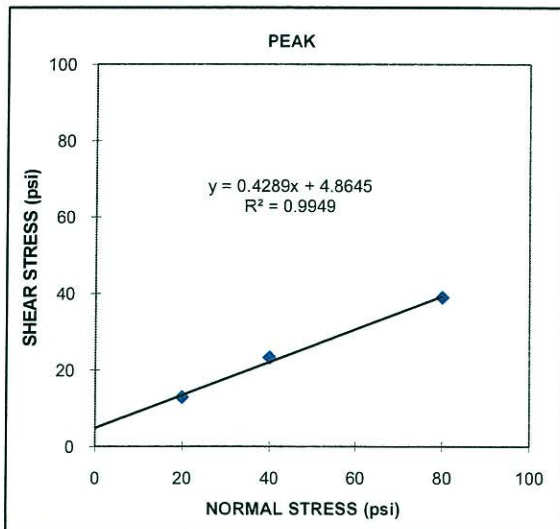

Observations After Test

- 20 psi: Shearing occurred at the interface between the Geomembrane and the GCL
- 40 psi: Shearing occurred at the interface between the Geomembrane and the GCL
- 80 psi: Shearing occurred at the interface between the Geomembrane and the GCL

(1) The peak shear stresses for 20, 40, and 80 psi normal stresses were chosen at 0.464, 0.436, and 0.641 in horizontal displacements, respectively.
 (2) The adhesion value is based on the "best-fit" line which may not show true adhesion.

DIRECT SHEAR TEST RESULTS

ASTM D6243

PROJECT NAME: ENERGY FUELS/GEOTECH PINON RIDGE/CO
 SAMPLE NUMBER: 4 (DN GCL vs SOIL)

INTERFACE TESTED: CETCO BENTOMAT DN GCL (white nonwoven side against Soil) vs SOIL (GA-TP-7 (1.5'-9'))
 SOIL CONDITIONS: REMOVED TO 95% OF THE MAX DRY DENSITY OF 116.9 pcf AT A MOISTURE OF 12.1 +/- 0.5%
 TEST CONDITIONS: INTERFACES WETTED, CONSOLIDATED 12 hours AT NORMAL LOAD
 SHEAR RATE: 0.04 in/min
 SUBSTRATE: TEXTURED RIGID PLATES

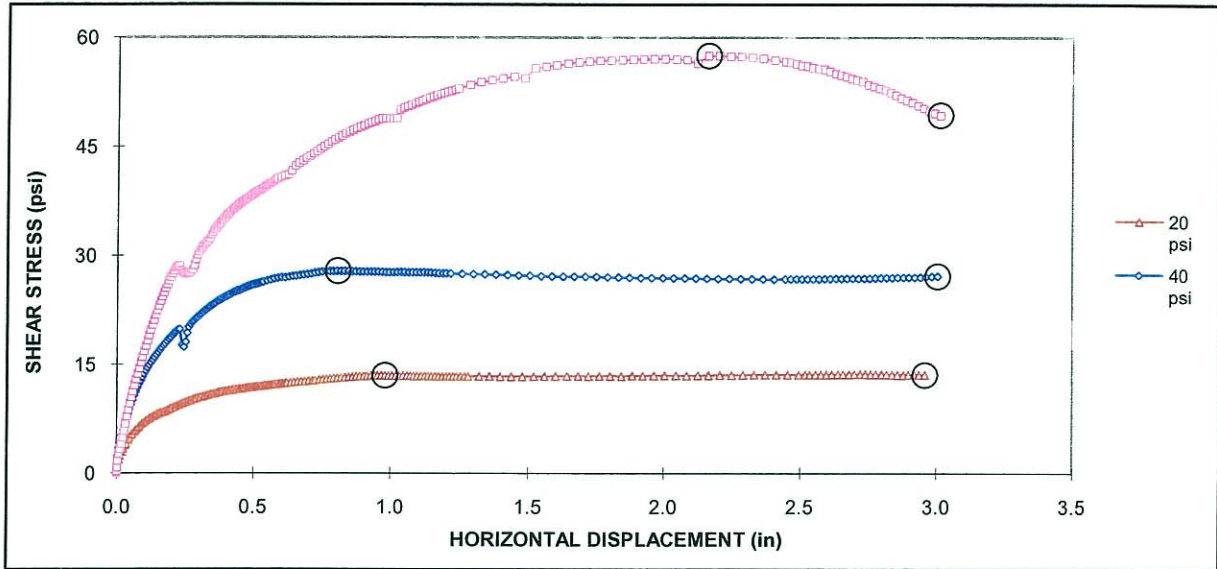

Normal Stress (psi)	Shear Stress		Peak		Residual	
	Peak ¹ (psi)	Residual (psi)	Friction Angle	Adhesion ² (psi)	Friction Angle	Adhesion ² (psi)
20	13.5	13.6	35.5	0.0	30.5	2.6
40	27.9	27.2				
80	57.5	49.3				

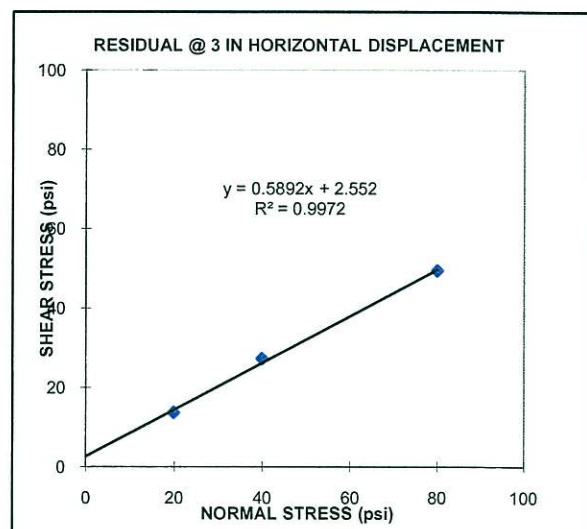
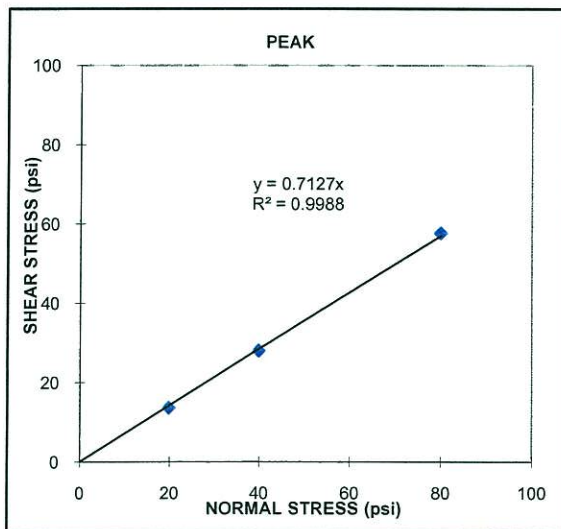

Observations After Test

- 20 psi: Shearing occurred at the interface between the GCL and the Soil
- 40 psi: Shearing occurred at the interface between the GCL and the Soil
- 80 psi: Shearing occurred within the Soil

(1) The peak shear stresses for 20, 40, and 80 psi normal stresses were chosen at 0.980, 0.806, and 2.164 in horizontal displacements, respectively, which may not represent the maximum shear stresses.
 (2) The adhesion value is based on the "best-fit" line which may not show true adhesion.

**ATTACHMENT 3
SLIDE RESULTS**

**TABLE A3-1
SUMMARY OF PEAK STABILITY ANALYSES**

Analyses Using Peak Liner Interface Shear Strength

Scenario	File Name	Static or Seismic	Pseudo-Static Seismic Coefficient	Surface Type	Factor of Safety
Pre Deposition	PreDepSC.sli	Static	n/a	Circular	2.08
Pre Deposition	PreDepSNC2.sli	Static	n/a	Block	2.05
Pre Deposition	PreDepSC-H.sli	Static	n/a	Circular	1.95
Pre Deposition	PreDepSNC-H.sli	Static	n/a	Block	1.97
Pre Deposition	PreDepEC.sli	Seismic	0.05	Circular	1.77
Pre Deposition	PreDepENC2.sli	Seismic	0.05	Block	1.74
Pre Deposition	PreDepEC-H.sli	Seismic	0.05	Circular	1.67
Pre Deposition	PreDepENC-H.sli	Seismic	0.05	Block	1.68
Post Deposition	PostDepSC.sli	Static	n/a	Circular	8.68
Post Deposition	PostDepSNC.sli	Static	n/a	Block	8.87
Post Deposition	PostDepEC.sli	Seismic	0.05	Circular	2.52
Post Deposition	PostDepENC.sli	Seismic	0.05	Block	2.61
Post Deposition	PostDepSC-B.sli	Static	n/a	Circular	3.00
Post Deposition	PostDepSNC-B.sli	Static	n/a	Block	3.08
Post Deposition	PostDepEC-B.sli	Seismic	0.05	Circular	2.38
Post Deposition	PostDepENC-B.sli	Seismic	0.05	Block	2.44
Post Closure	PostCloSC.sli	Static	n/a	Circular	5.23
Post Closure	PostCloSNC.sli	Static	n/a	Block	4.89
Post Closure	PostCloEC.sli	Seismic	0.08	Circular	2.88
Post Closure	PostCloENC.sli	Seismic	0.08	Block	2.65

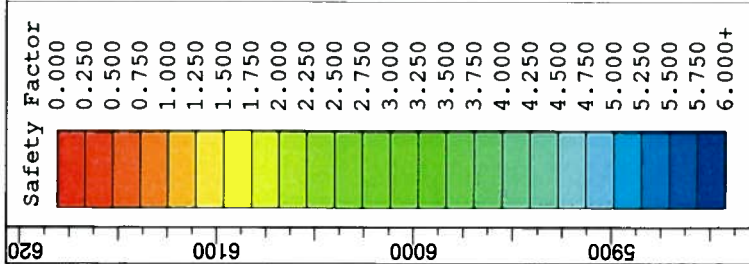

Liner Interface Strength: Peak
 File: PreDepSC.sli
 Analysis Method: spencer
 Minimum FS = 2.084

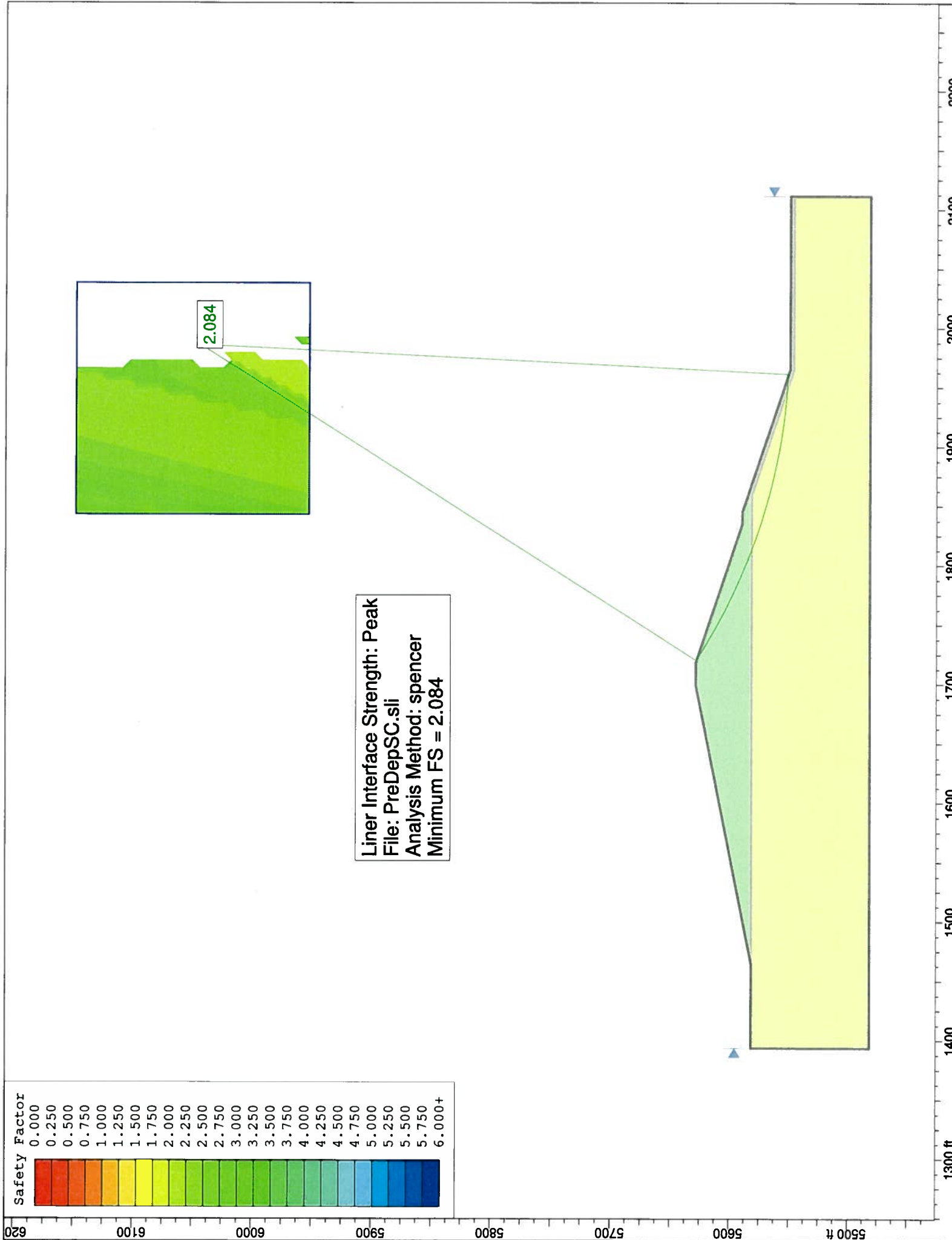
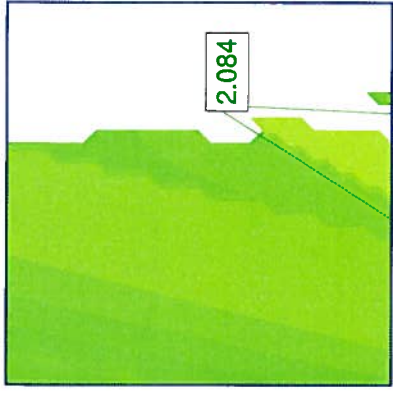

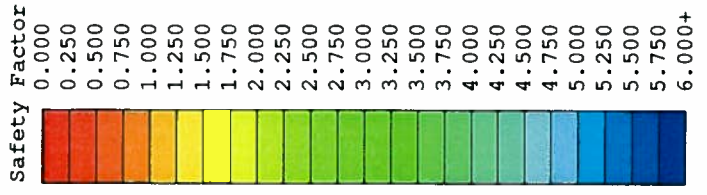

Liner Interface Strength: Peak
 File: PreDepSNC2.sil
 Analysis Method: spencer
 Minimum FS = 2.046

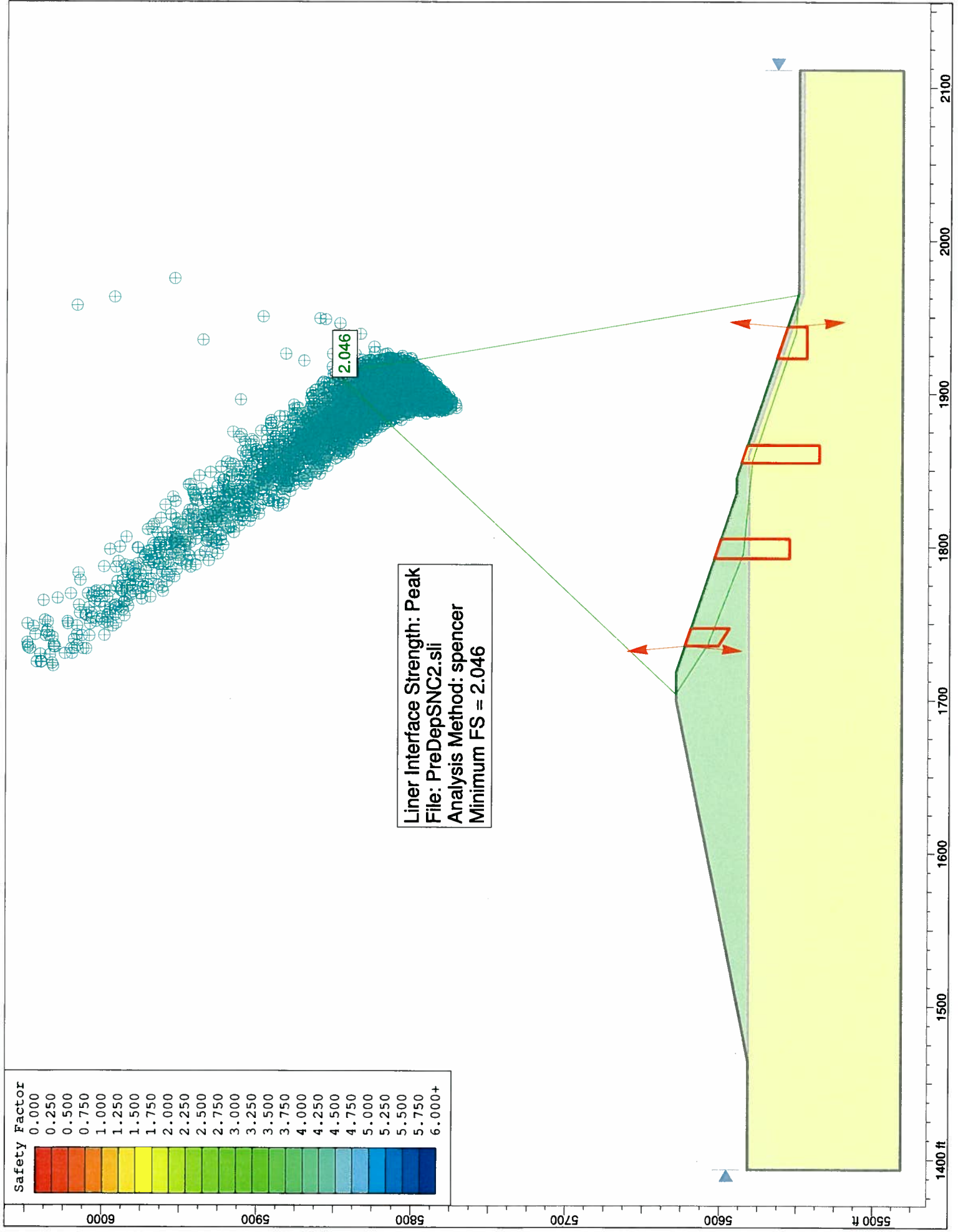
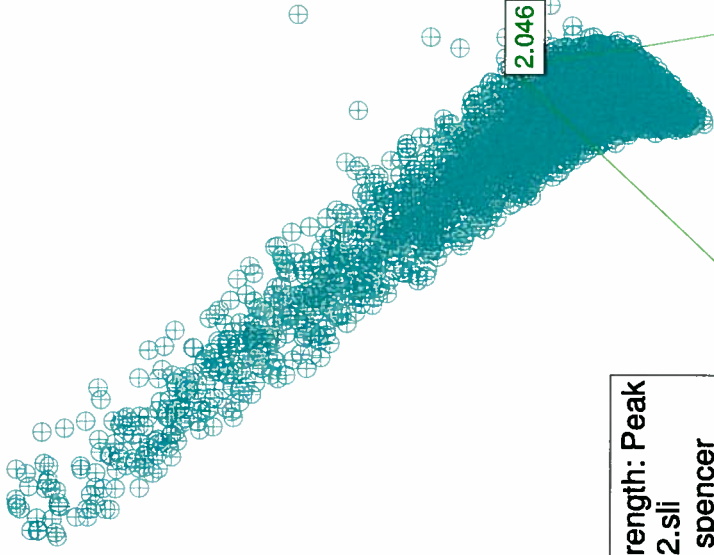

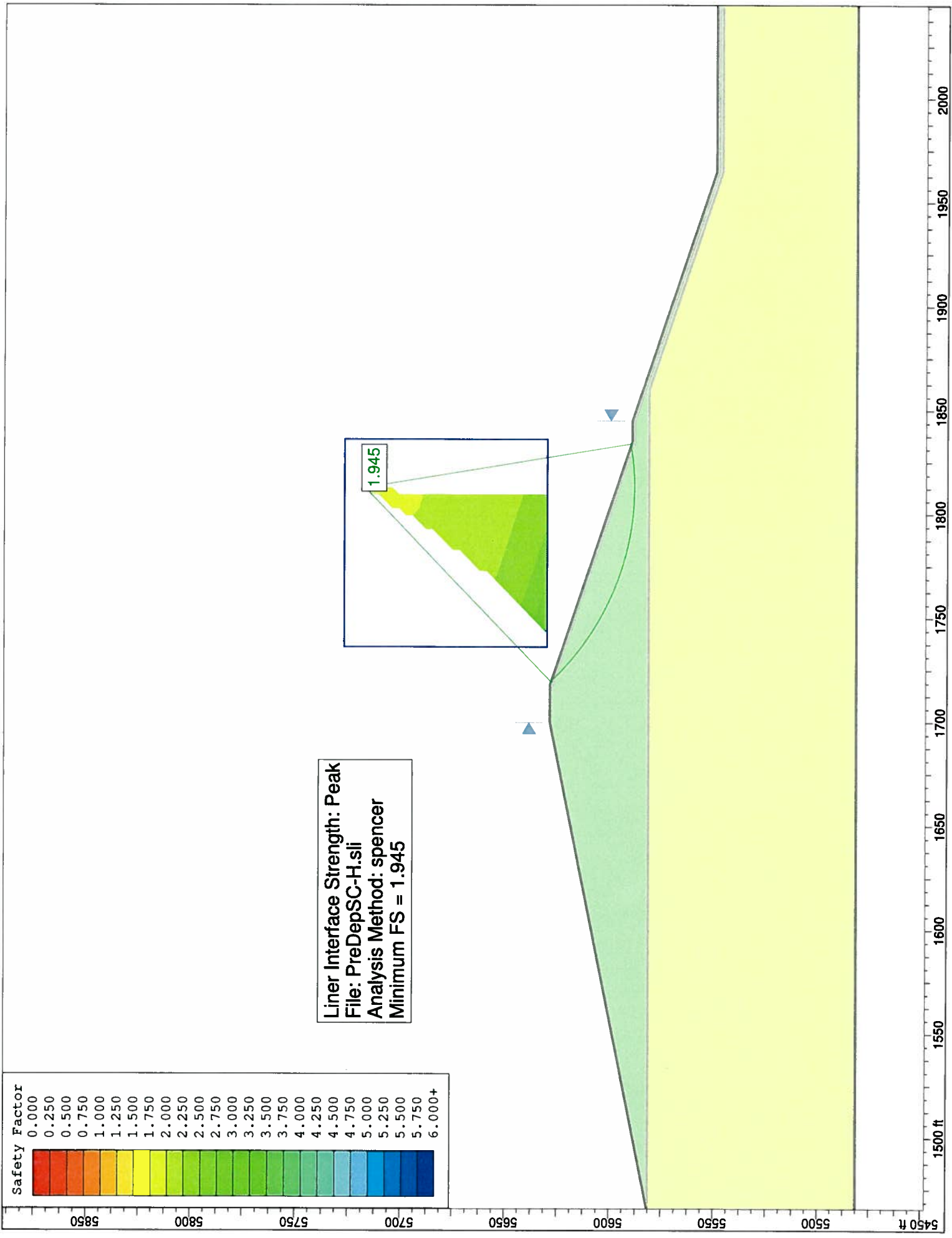

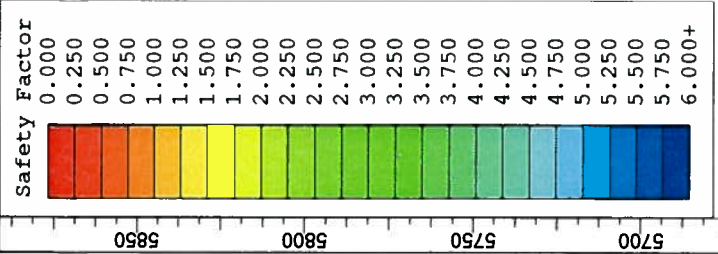

Liner Interface Strength: Peak
 File: PreDepSNC-H.sli
 Analysis Method: spencer
 Minimum FS = 1.967

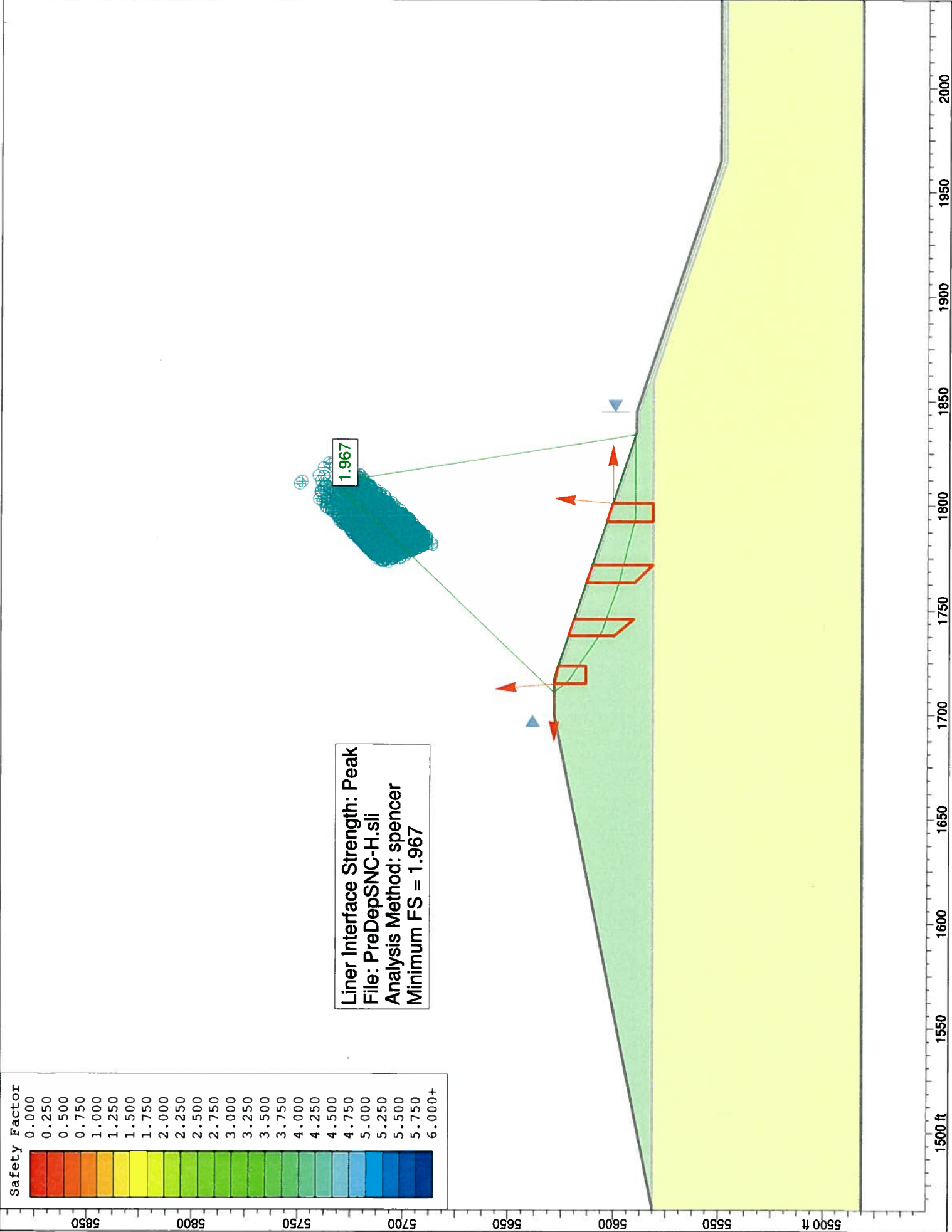

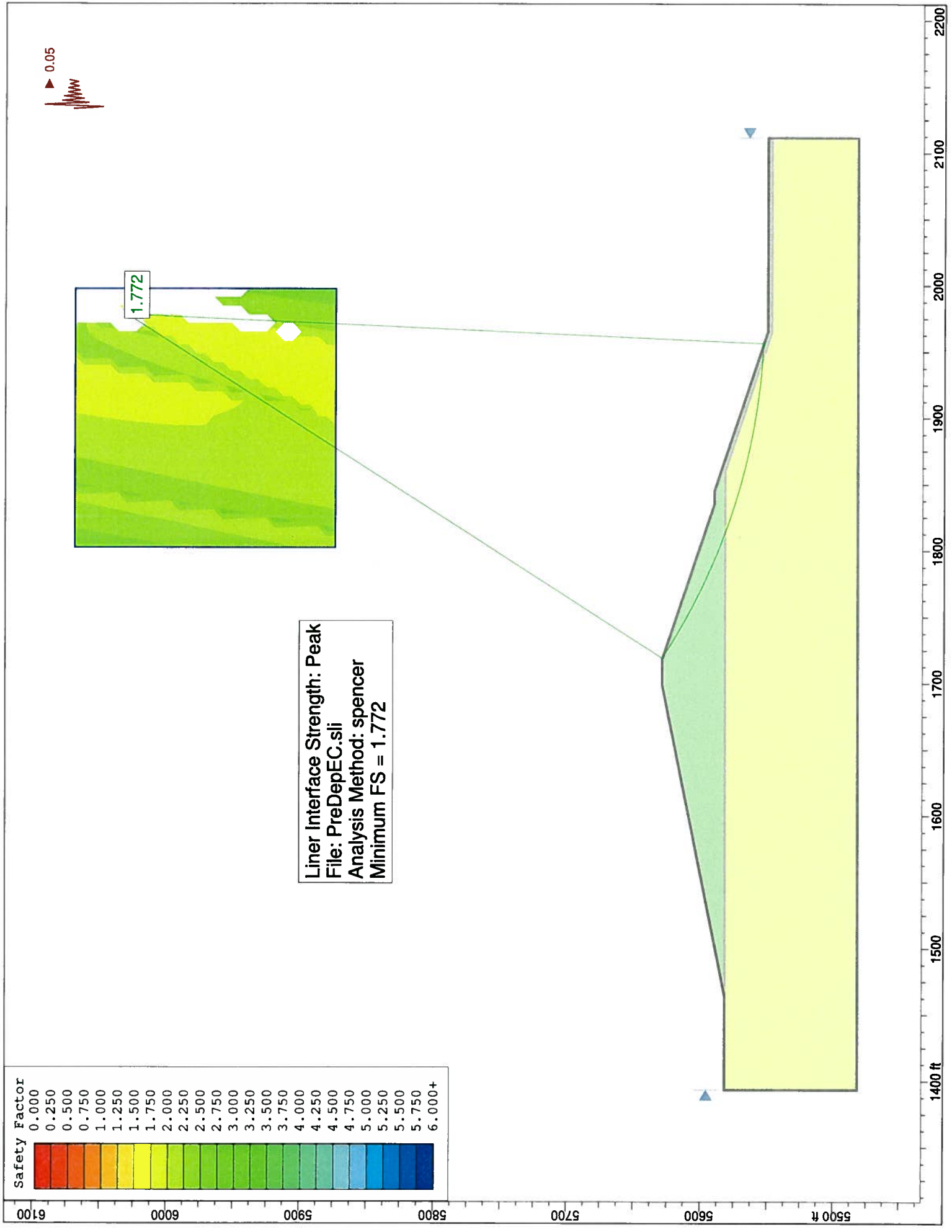

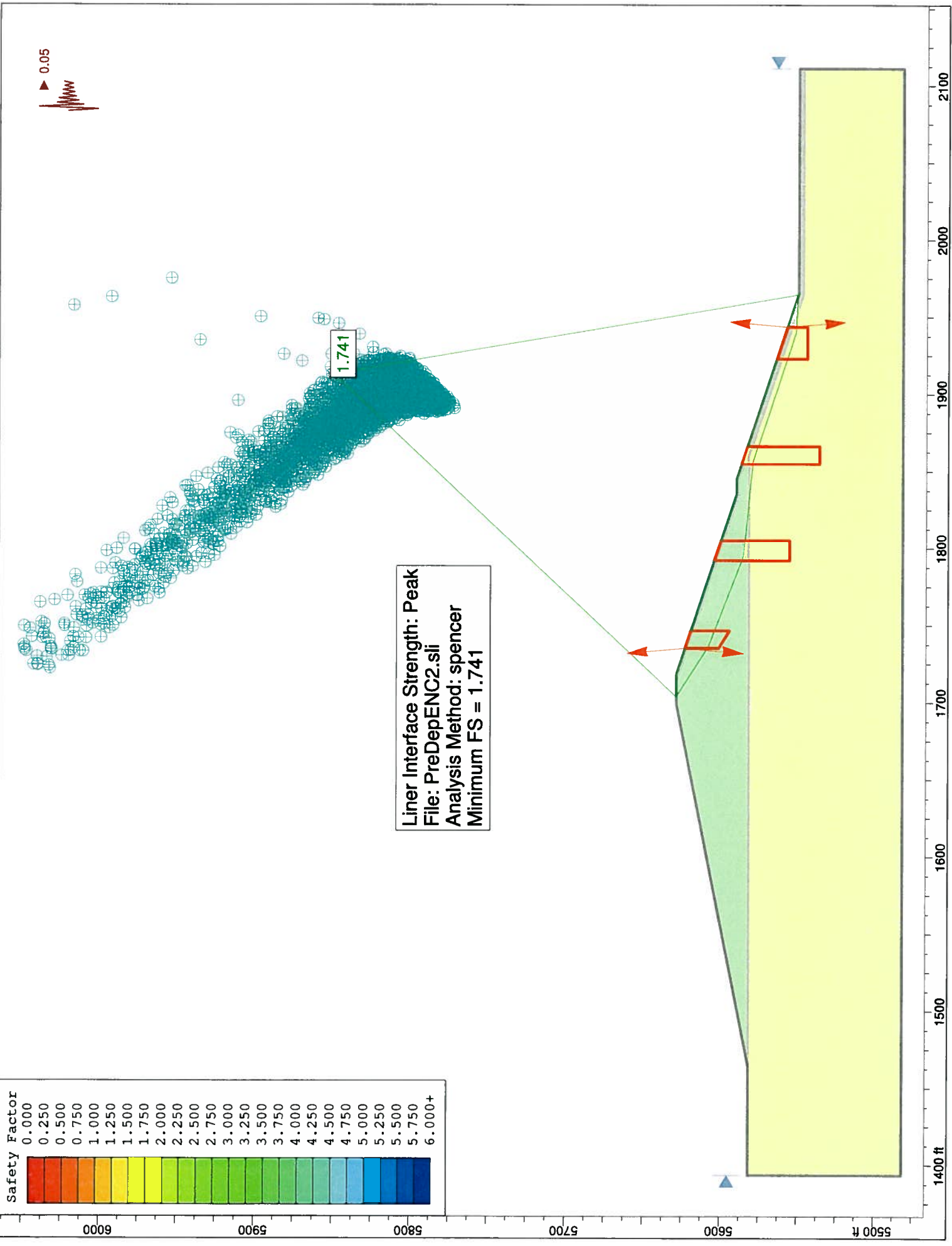
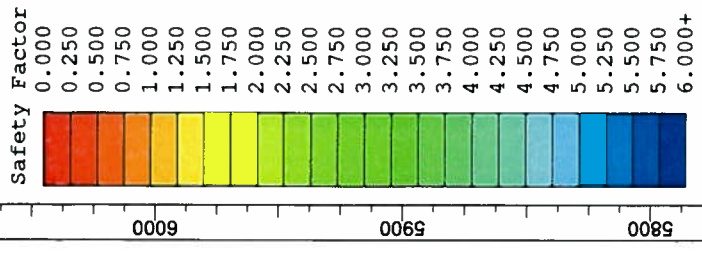

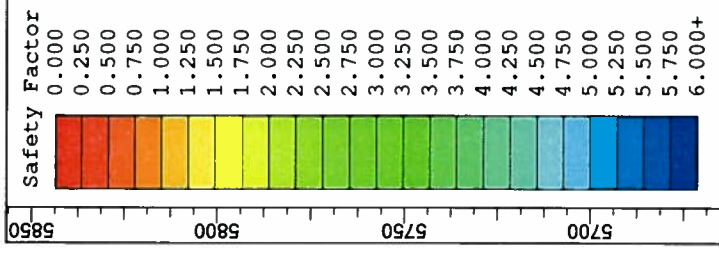

Liner Interface Strength: Peak
File: PreDepEC-H.sli
Analysis Method: spencer
Minimum FS = 1.669

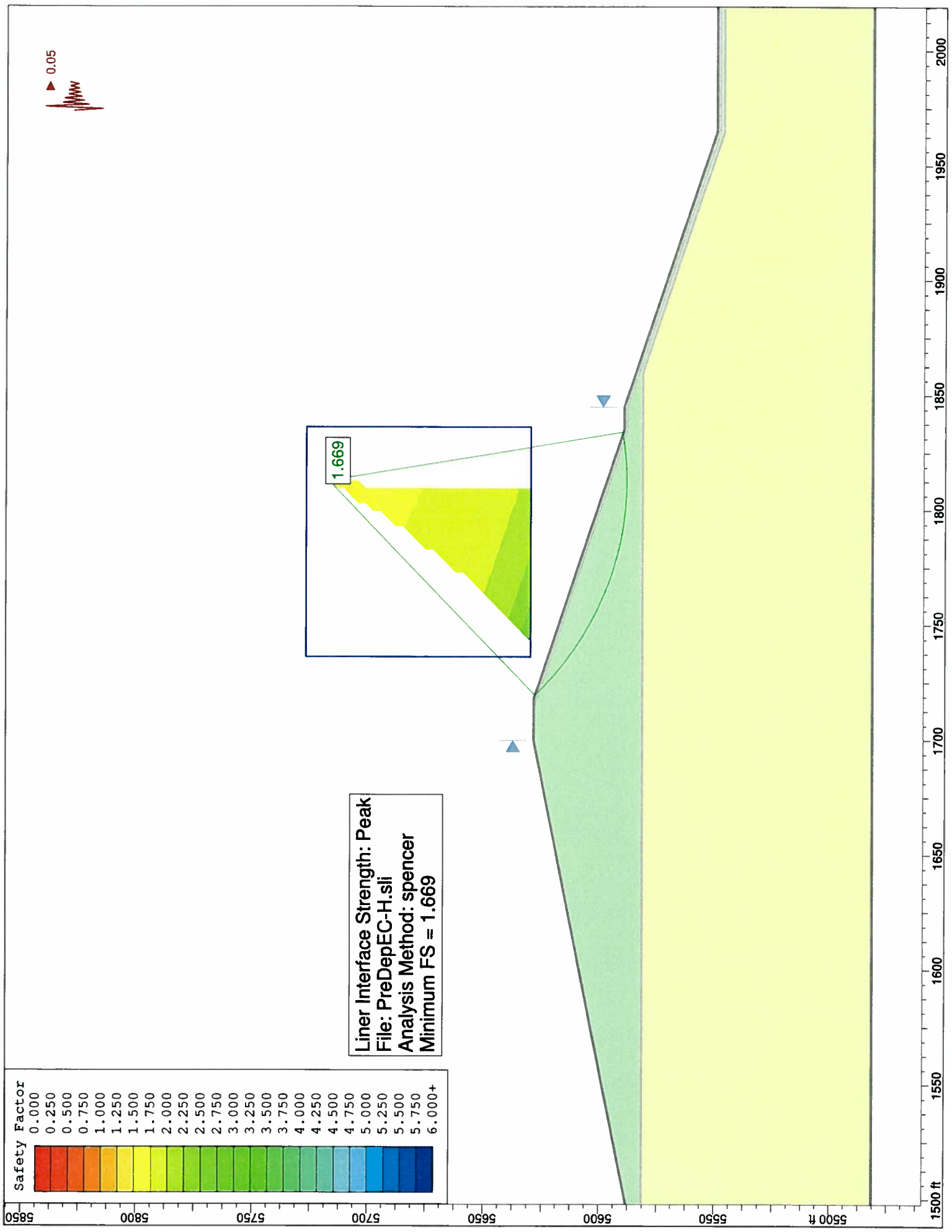
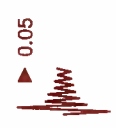
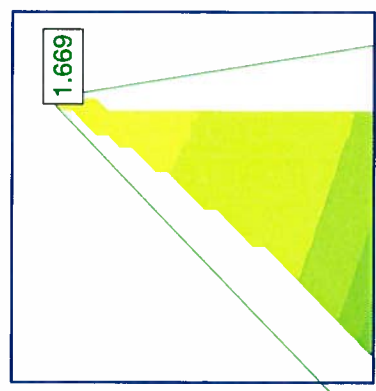

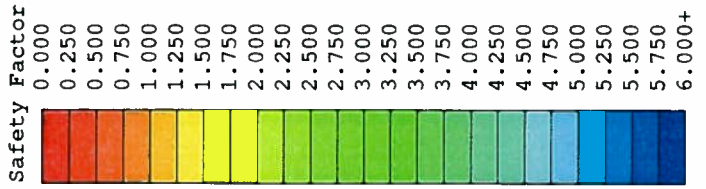

Liner Interface Strength: Peak
 File: PreDepENC-H.sii
 Analysis Method: spencer
 Minimum FS = 1.683

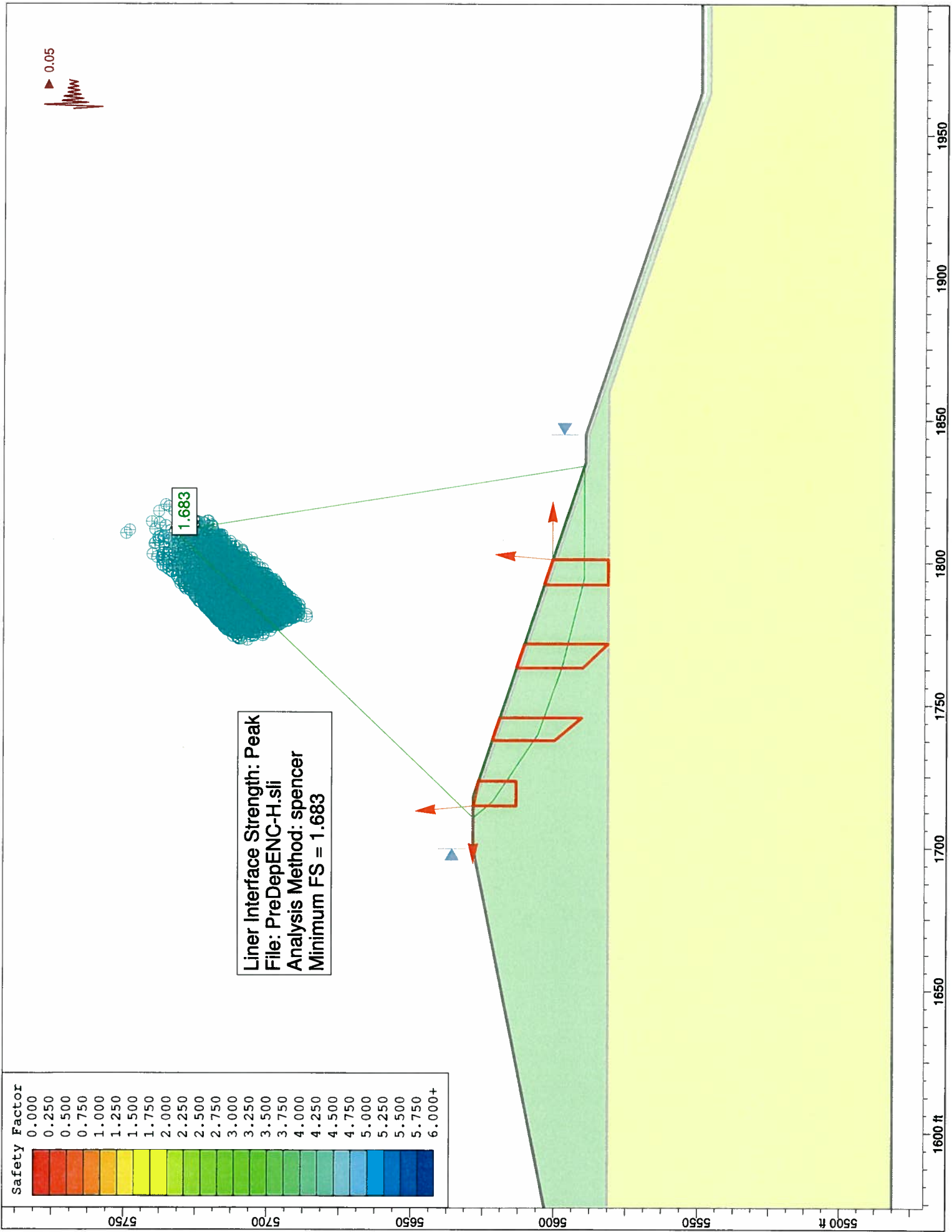
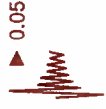
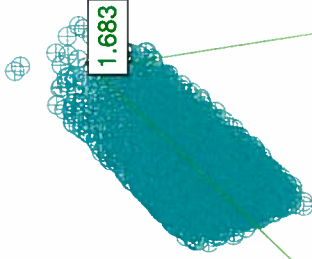

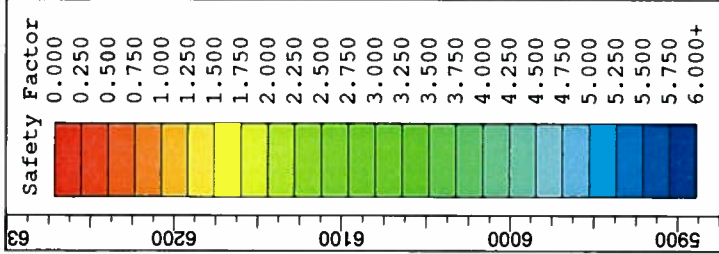

Liner Interface Strength: Peak
 File: PostDepSC.sli
 Analysis Method: spencer
 Minimum FS = 8.683

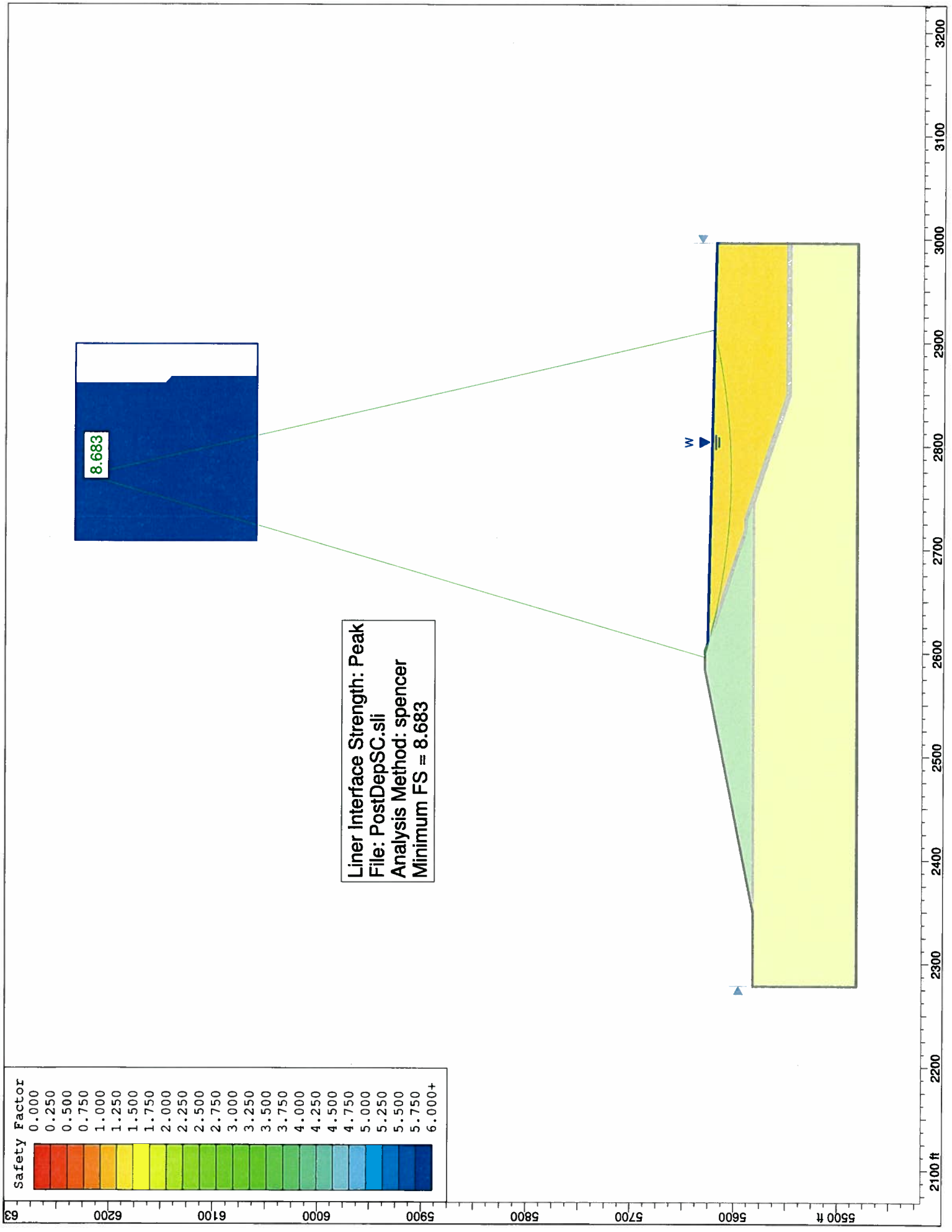
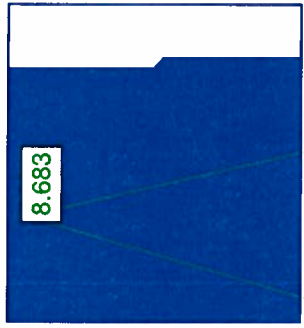

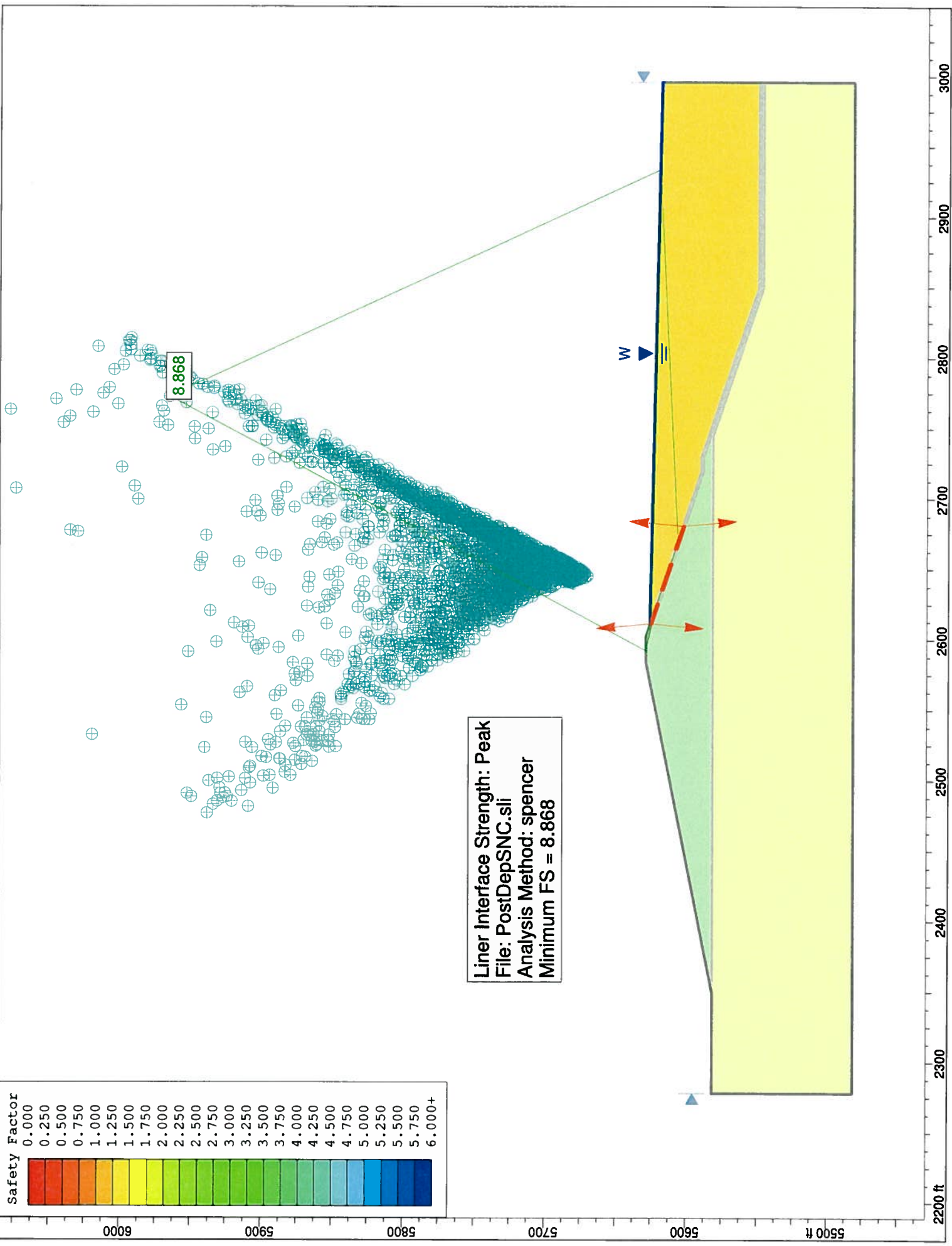
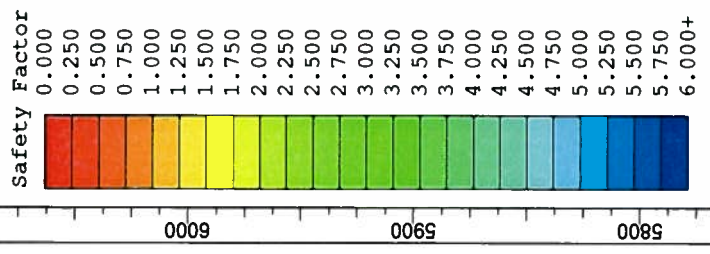

Liner Interface Strength: Peak
 File: PostDepSNC.sli
 Analysis Method: spencer
 Minimum FS = 8.868

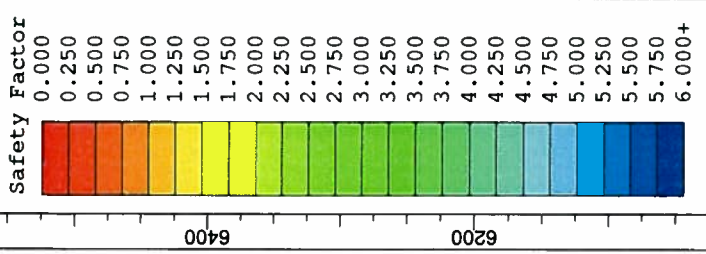

Liner Interface Strength: Peak
 File: PostDepEC.sli
 Analysis Method: spencer
 Minimum FS = 2.523

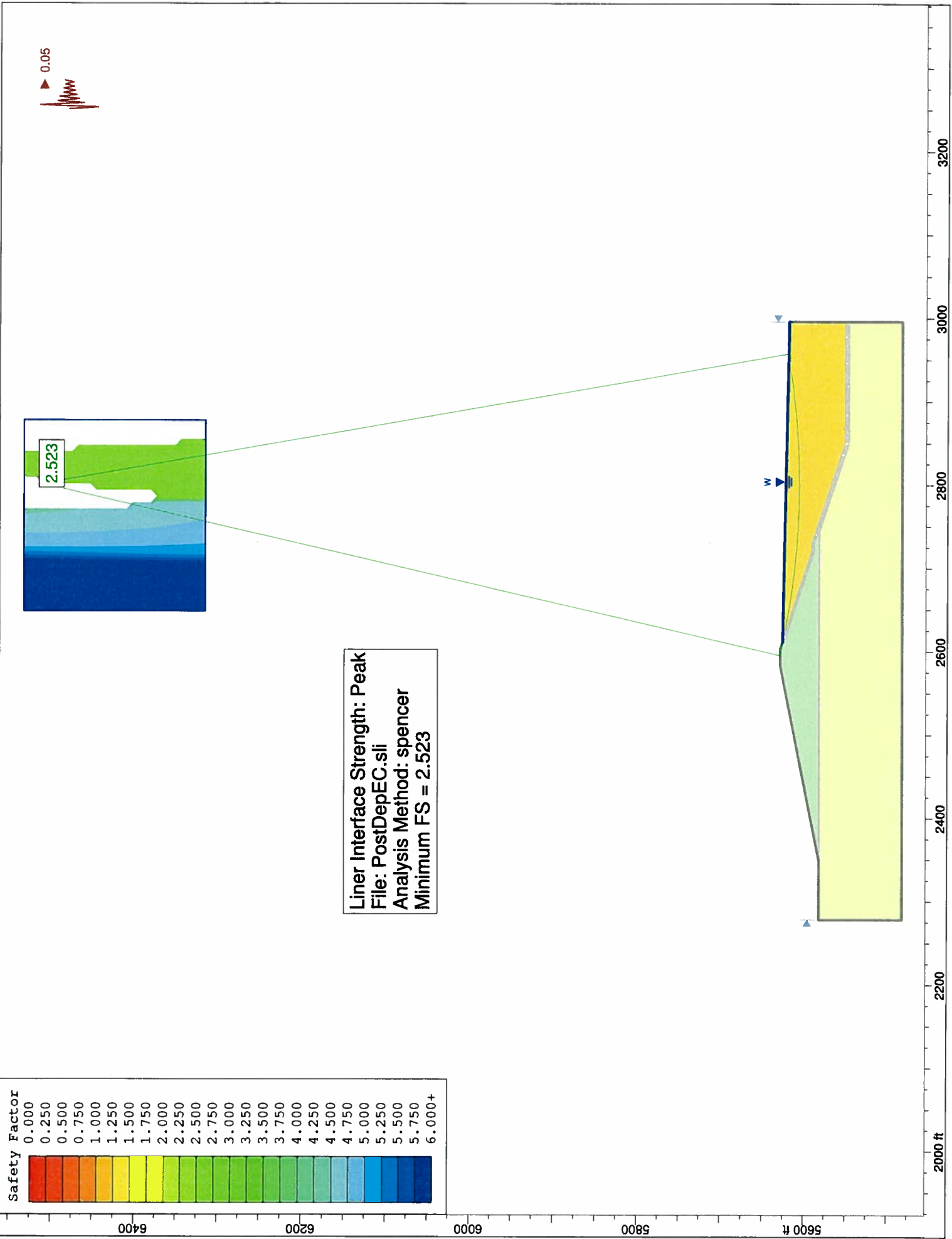
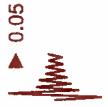
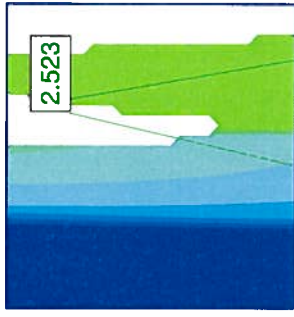

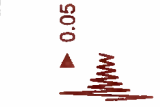
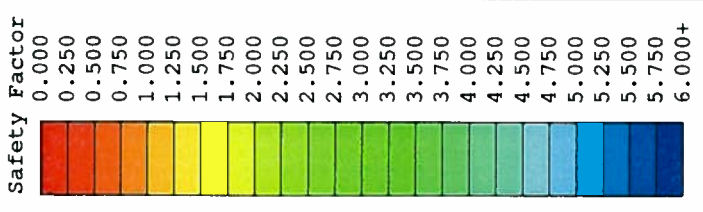

Liner Interface Strength: Peak
 File: PostDepENC.sli
 Analysis Method: spencer
 Minimum FS = 2.612

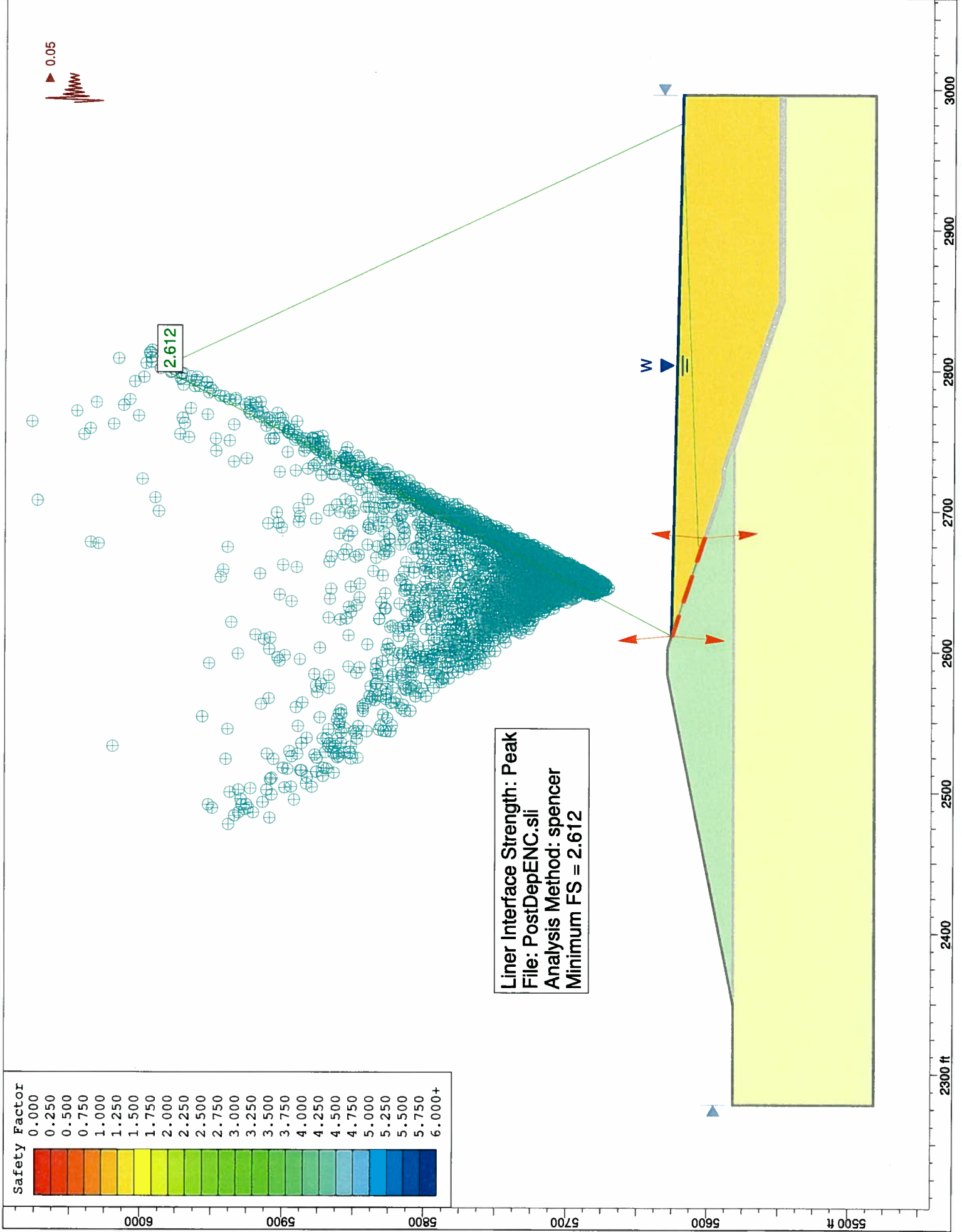

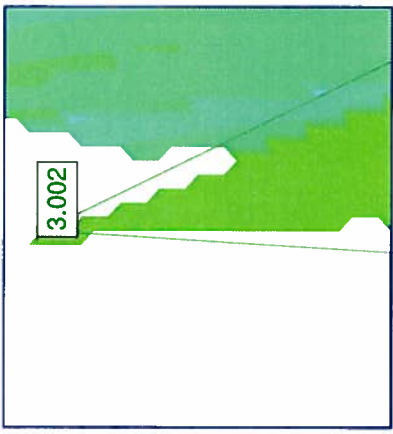
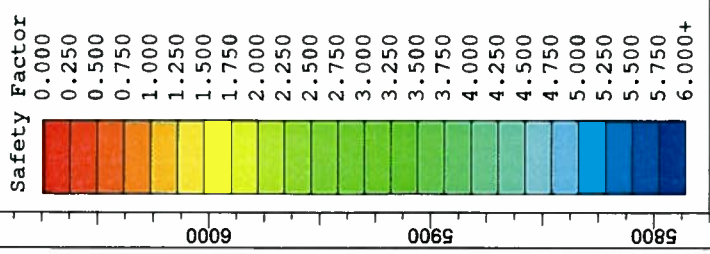

Liner Interface Strength: Peak
 File: PostDepSC-B.sli
 Analysis Method: spencer
 Minimum FS = 3.002

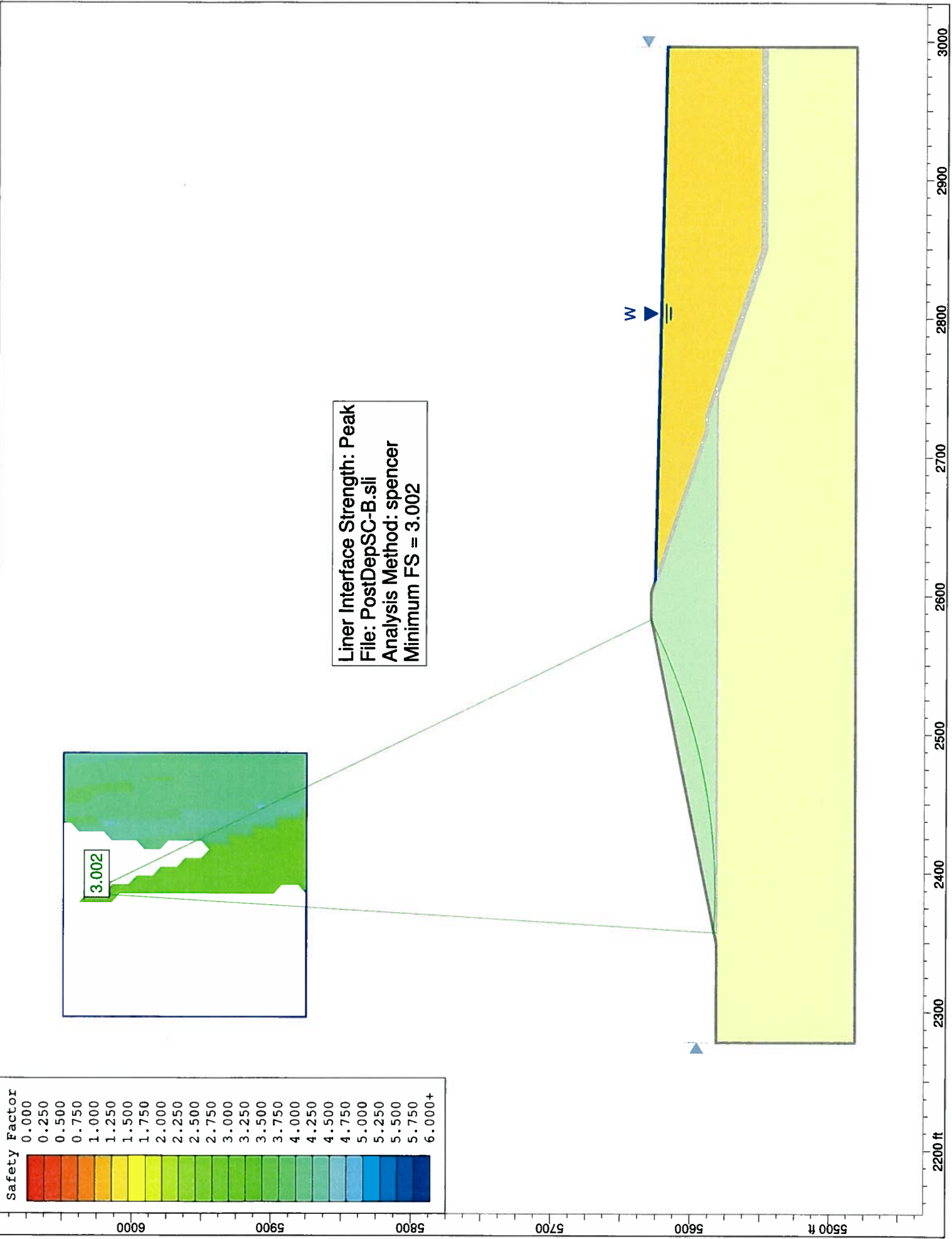

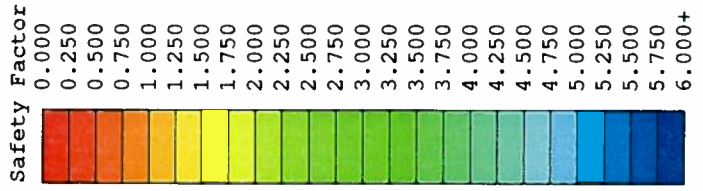

Liner Interface Strength: Peak
 File: PostDepSNC-B.sli
 Analysis Method: spencer
 Minimum FS = 3.079

3.079

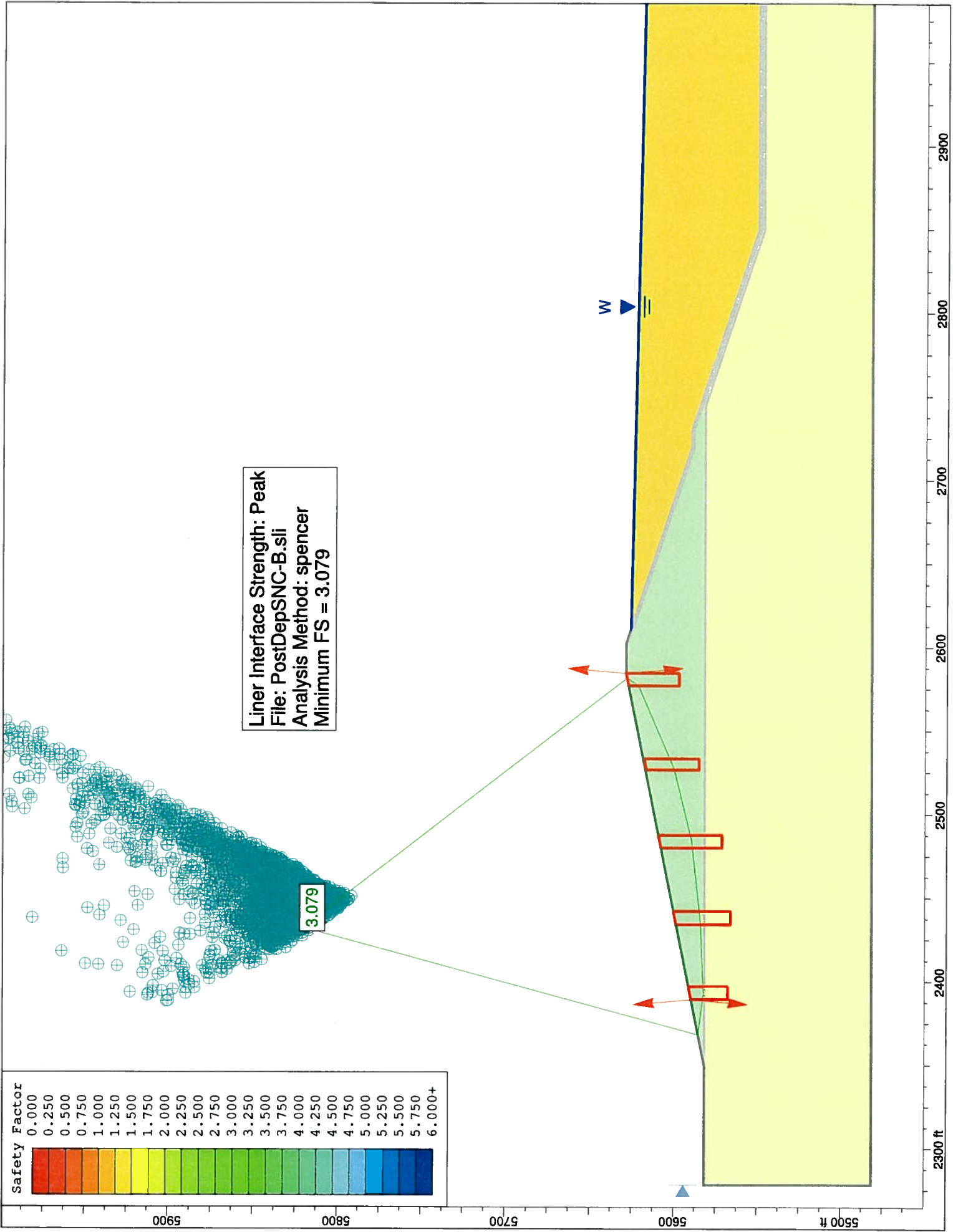

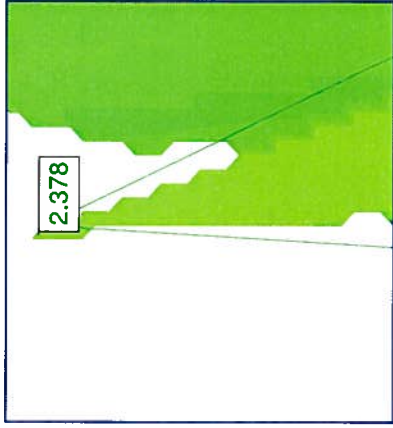
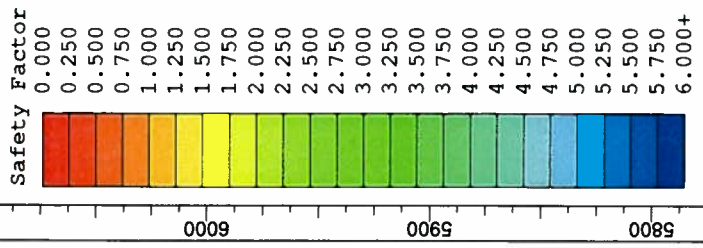

Liner Interface Strength: Peak
 File: PostDepEC-B.sli
 Analysis Method: spencer
 Minimum FS = 2.378

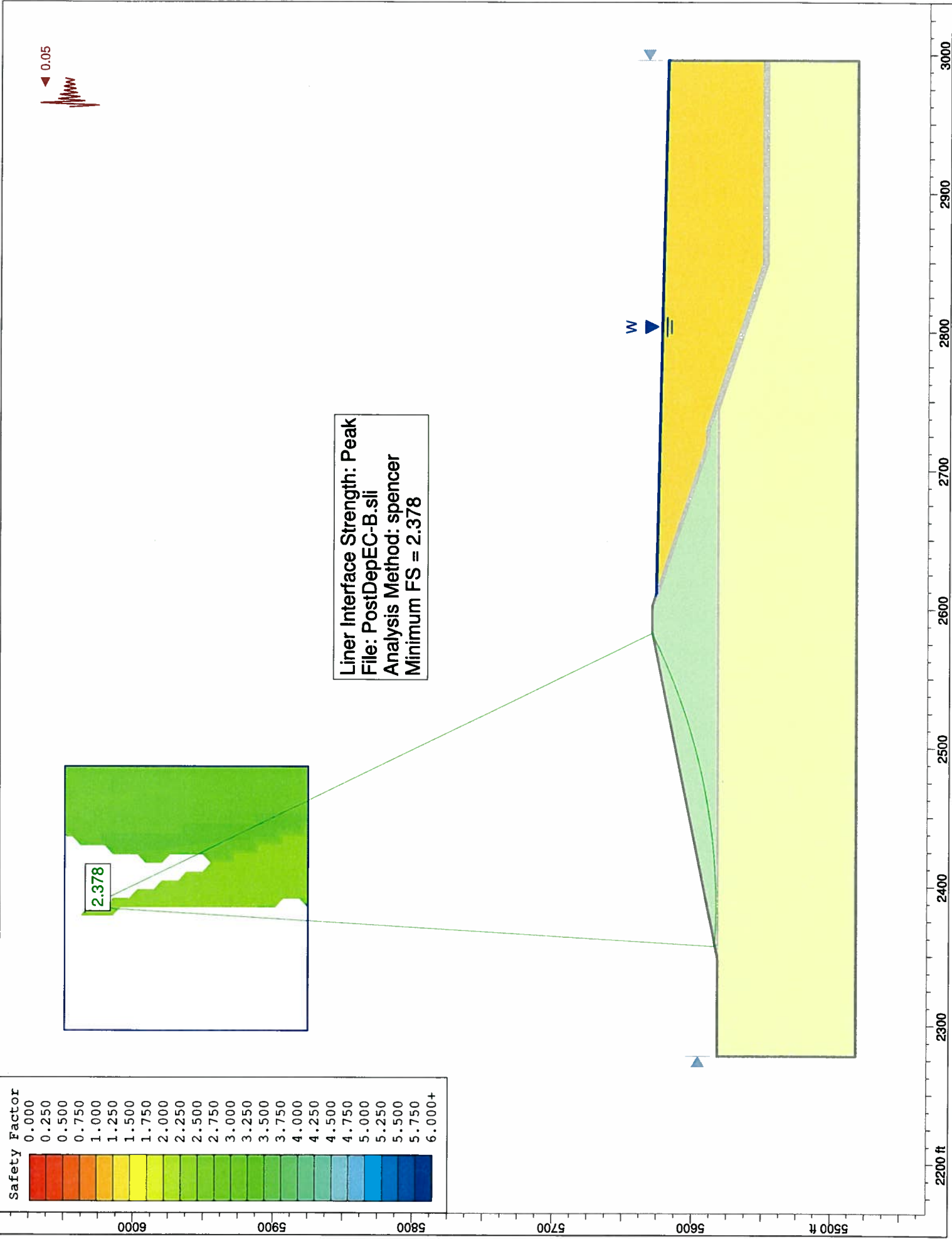

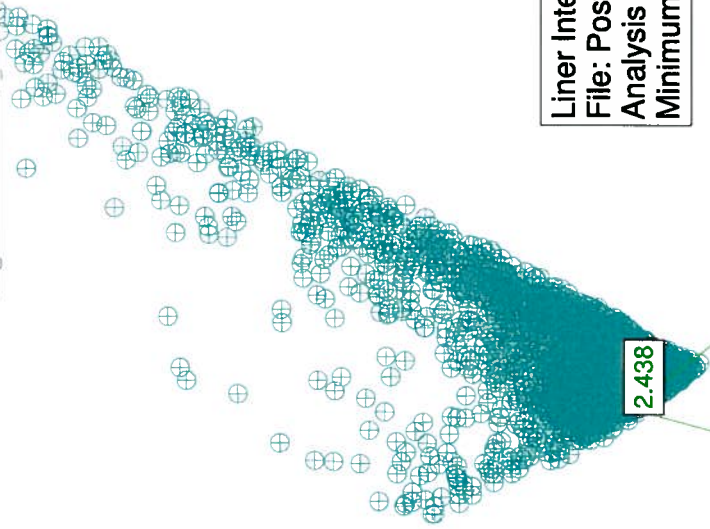
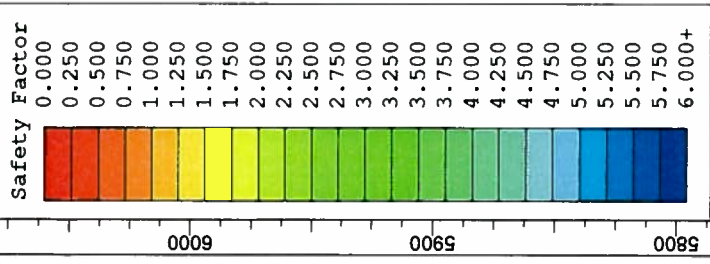

Liner Interface Strength: Peak
 File: PostDepENC-B.sli
 Analysis Method: spencer
 Minimum FS = 2.438

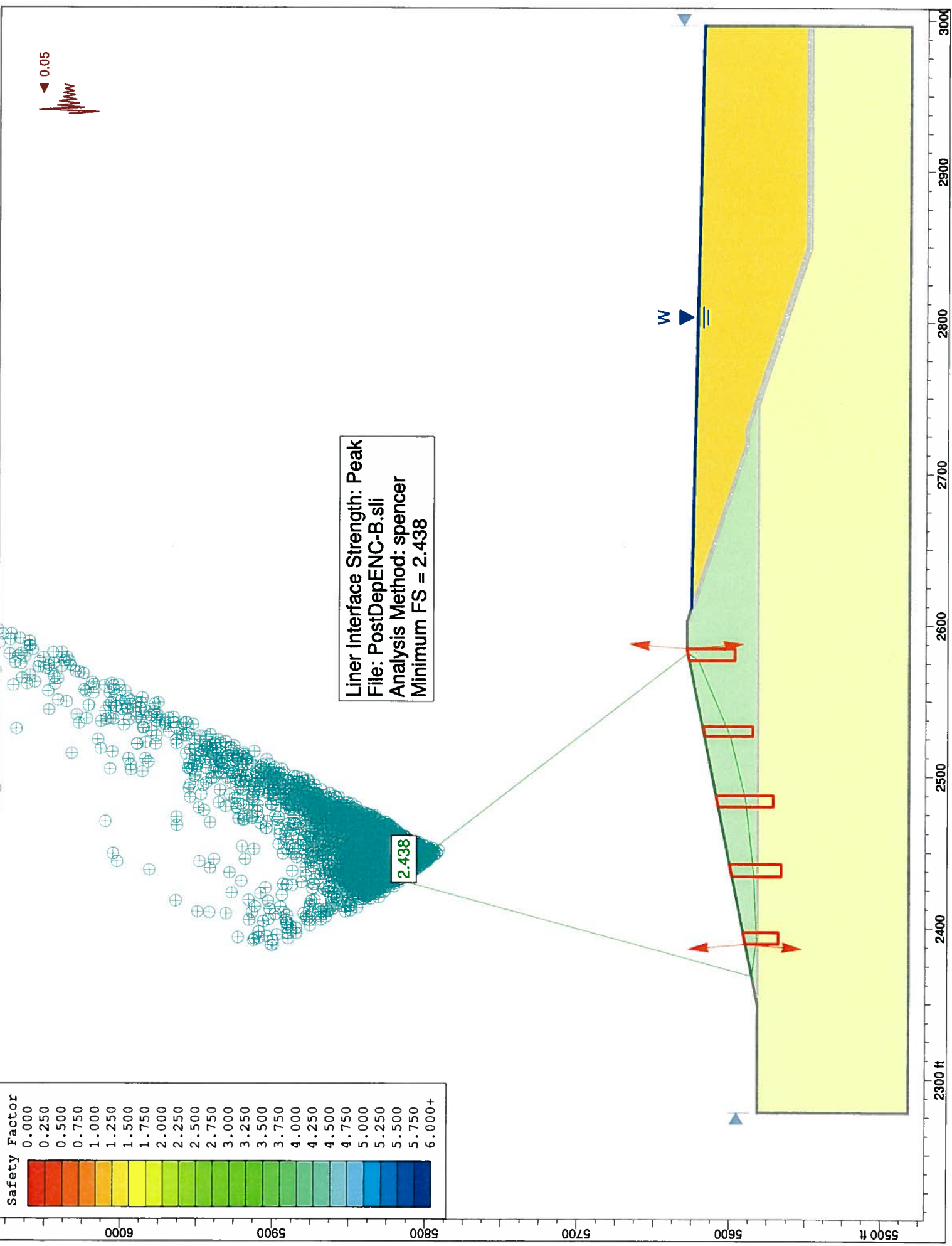

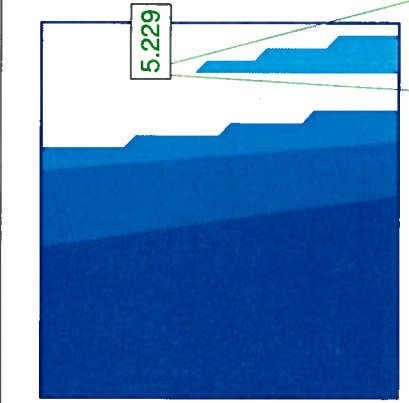
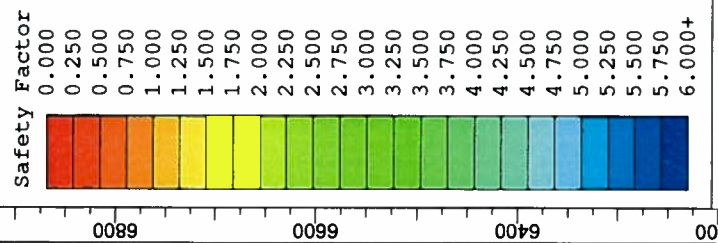

Liner Interface Strength: Peak
 File: PostCloSC.sli
 Analysis Method: spencer
 Minimum FS = 5.229

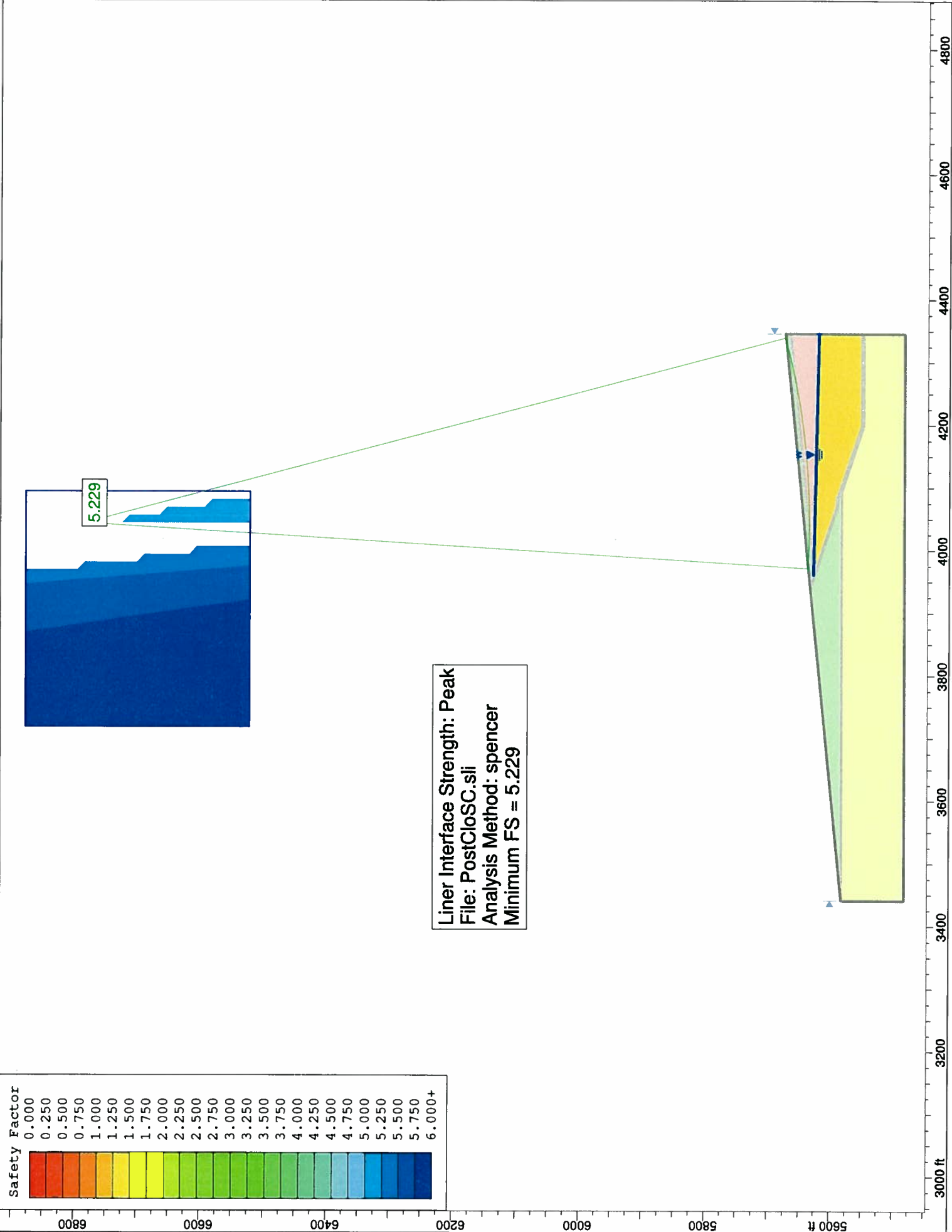

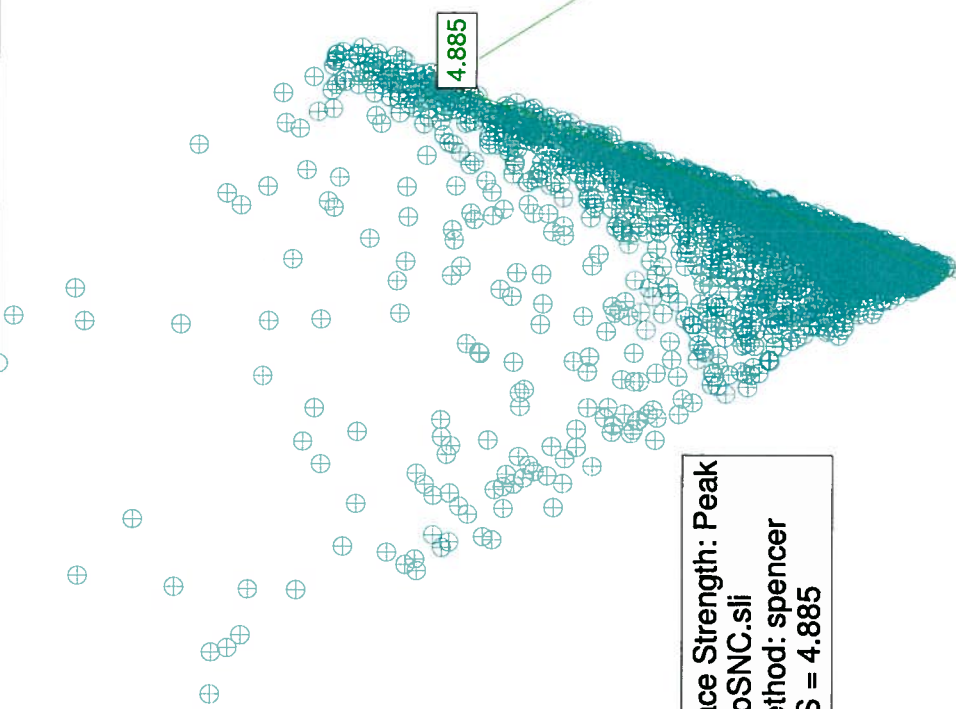
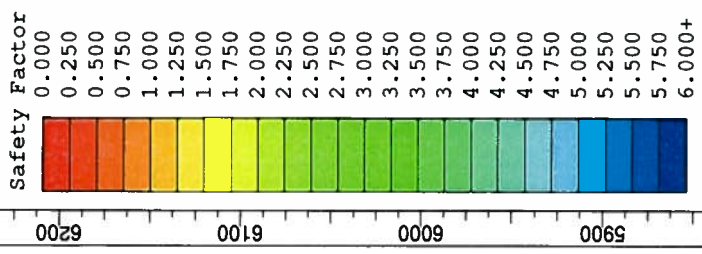

Liner Interface Strength: Peak
 File: PostCloSNC.sli
 Analysis Method: spencer
 Minimum FS = 4.885

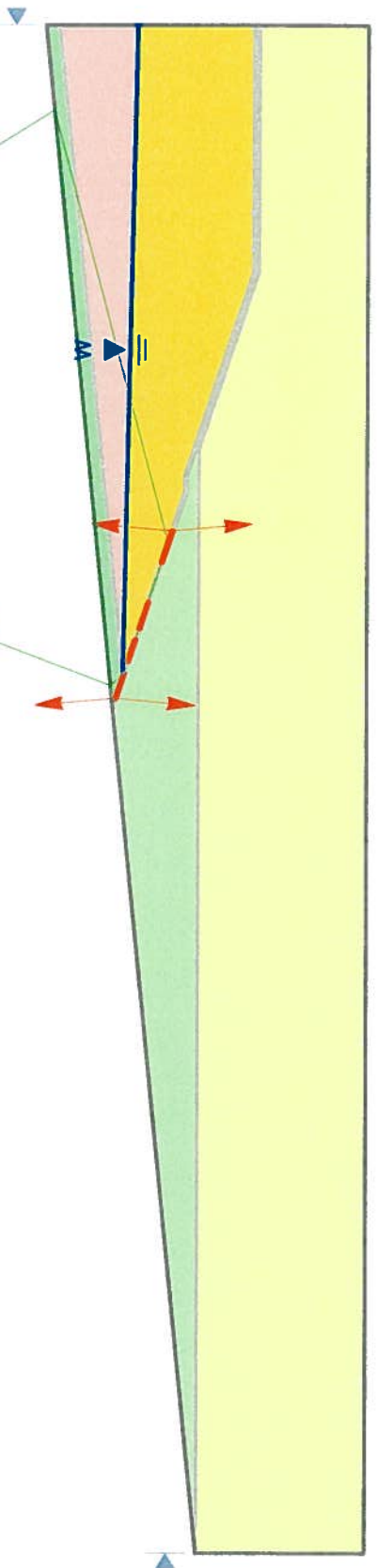

3400 ft 3500 3600 3700 3800 3900 4000 4100 4200 4300 4400

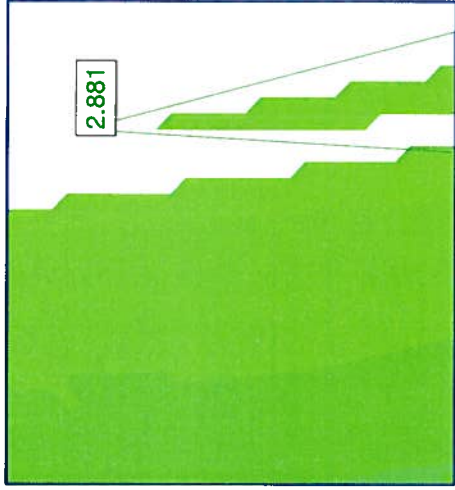
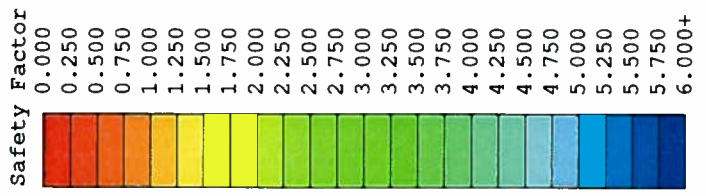

Liner Interface Strength: Peak
 File: PostCloEC.sii
 Analysis Method: spencer
 Minimum FS = 2.881

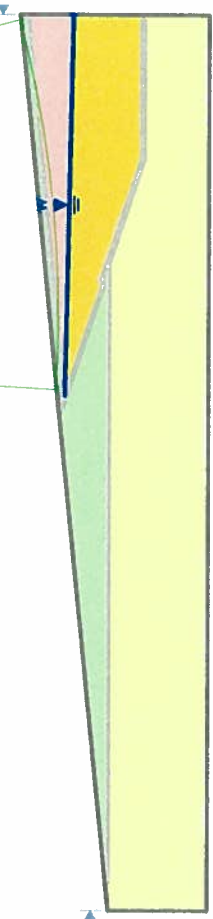
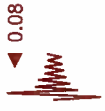

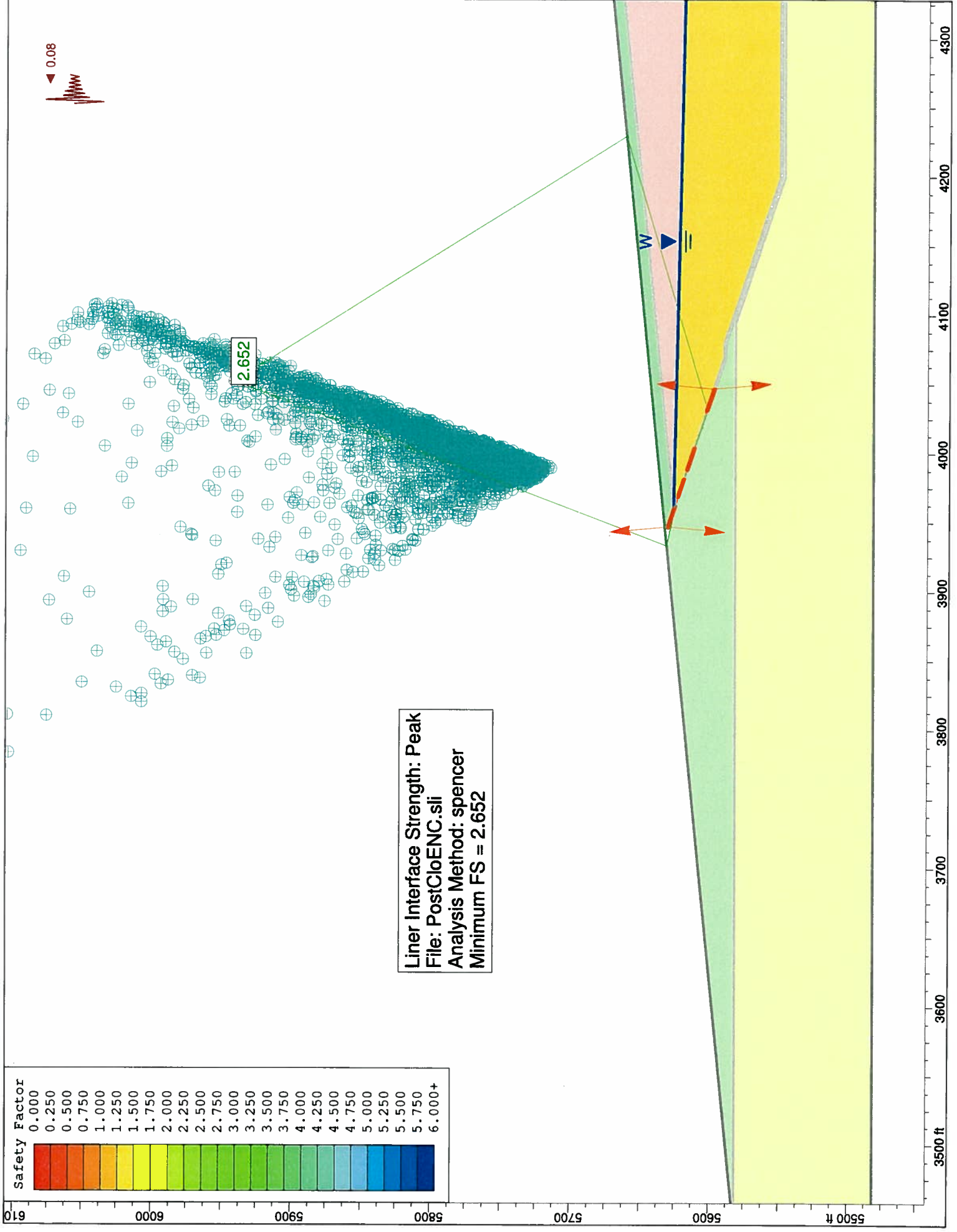

Liner Interface Strength: Peak
 File: PostCloENC.sli
 Analysis Method: spencer
 Minimum FS = 2.652

2.652



Safety Factor
0.000
0.250
0.500
0.750
1.000
1.250
1.500
1.750
2.000
2.250
2.500
2.750
3.000
3.250
3.500
3.750
4.000
4.250
4.500
4.750
5.000
5.250
5.500
5.750
6.000+

3500 ft 3600 3700 3800 3900 4000 4100 4200 4300

5800 5900 6000 6100

**TABLE A3-2
SUMMARY OF RESIDUAL STABILITY ANALYSES**

Analyses Using Residual Liner Interface Shear Strength

Scenario	File Name	Static or Seismic	Pseudo-Static Seismic Coefficient	Surface Type	Factor of Safety
Pre Deposition	PreDepSC.sli	Static	n/a	Circular	2.08
Pre Deposition	PreDepSNC2.sli	Static	n/a	Block	2.05
Pre Deposition	PreDepSC-H.sli	Static	n/a	Circular	1.94
Pre Deposition	PreDepSNC-H.sli	Static	n/a	Block	1.97
Pre Deposition	PreDepEC.sli	Seismic	0.05	Circular	1.77
Pre Deposition	PreDepENC2.sli	Seismic	0.05	Block	1.74
Pre Deposition	PreDepEC-H.sli	Seismic	0.05	Circular	1.67
Pre Deposition	PreDepENC-H.sli	Seismic	0.05	Block	1.68
Post Deposition	PostDepSC.sli	Static	n/a	Circular	8.61
Post Deposition	PostDepSNC.sli	Static	n/a	Block	8.05
Post Deposition	PostDepEC.sli	Seismic	0.05	Circular	2.52
Post Deposition	PostDepENC.sli	Seismic	0.05	Block	2.46
Post Deposition*	PostDepSC-B.sli	Static	n/a	Circular	3.00
Post Deposition*	PostDepSNC-B.sli	Static	n/a	Block	3.08
Post Deposition*	PostDepEC-B.sli	Seismic	0.05	Circular	2.38
Post Deposition*	PostDepENC-B.sli	Seismic	0.05	Block	2.44
Post Closure	PostCloSC.sli	Static	n/a	Circular	4.81
Post Closure	PostCloSNC.sli	Static	n/a	Block	4.40
Post Closure	PostCloEC.sli	Seismic	0.08	Circular	2.64
Post Closure	PostCloENC.sli	Seismic	0.08	Block	2.34

* Analysis identical to peak liner strength analysis - results not shown in Attachment 3.

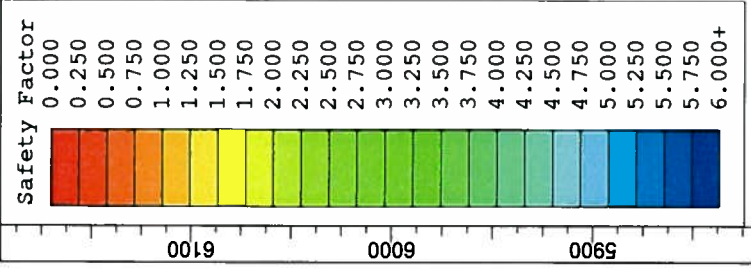

Liner Interface Strength: Residual
 File: PreDepSC.sli
 Analysis Method: spencer
 Minimum FS = 2.079

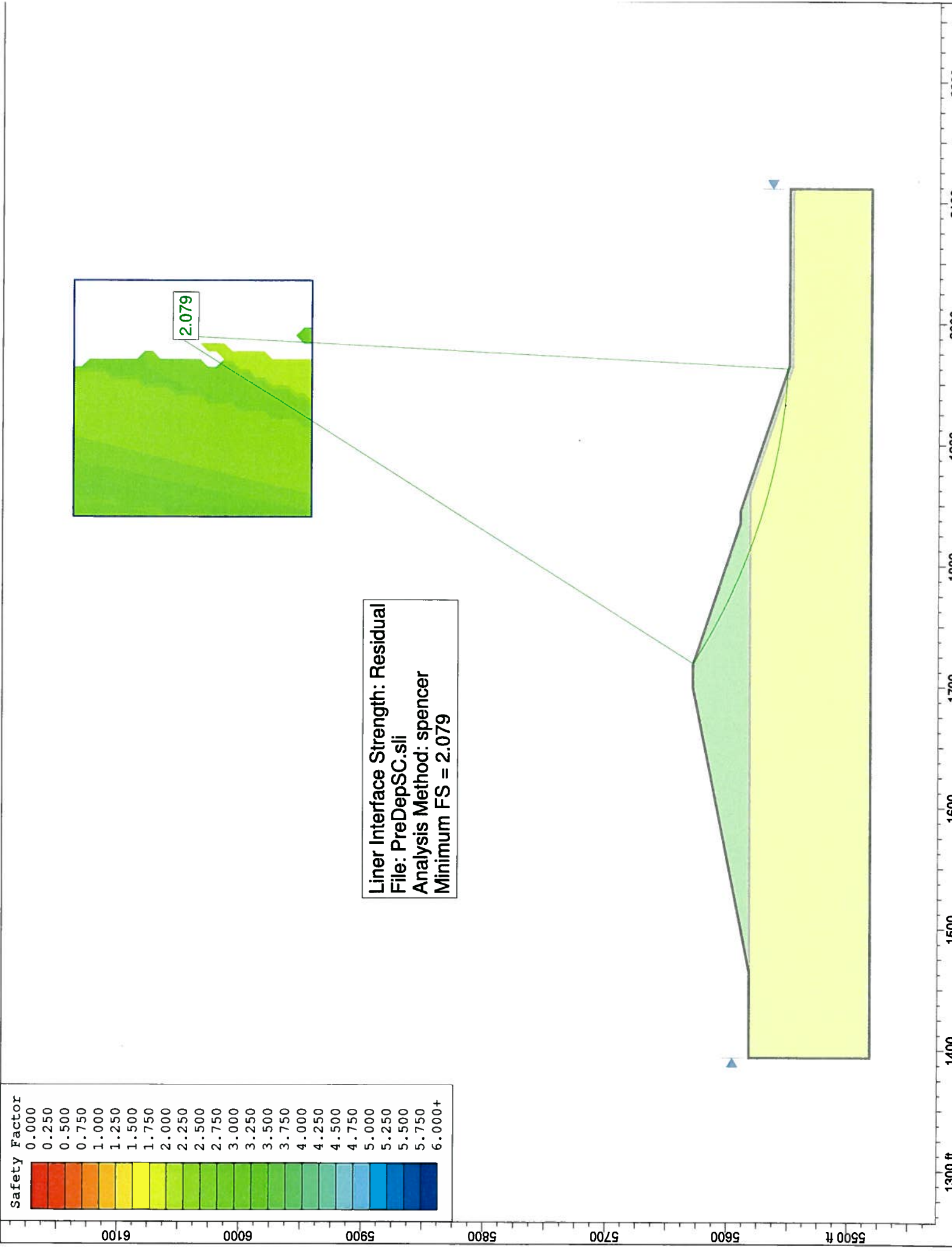
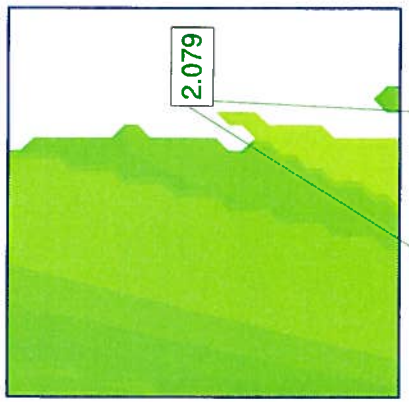

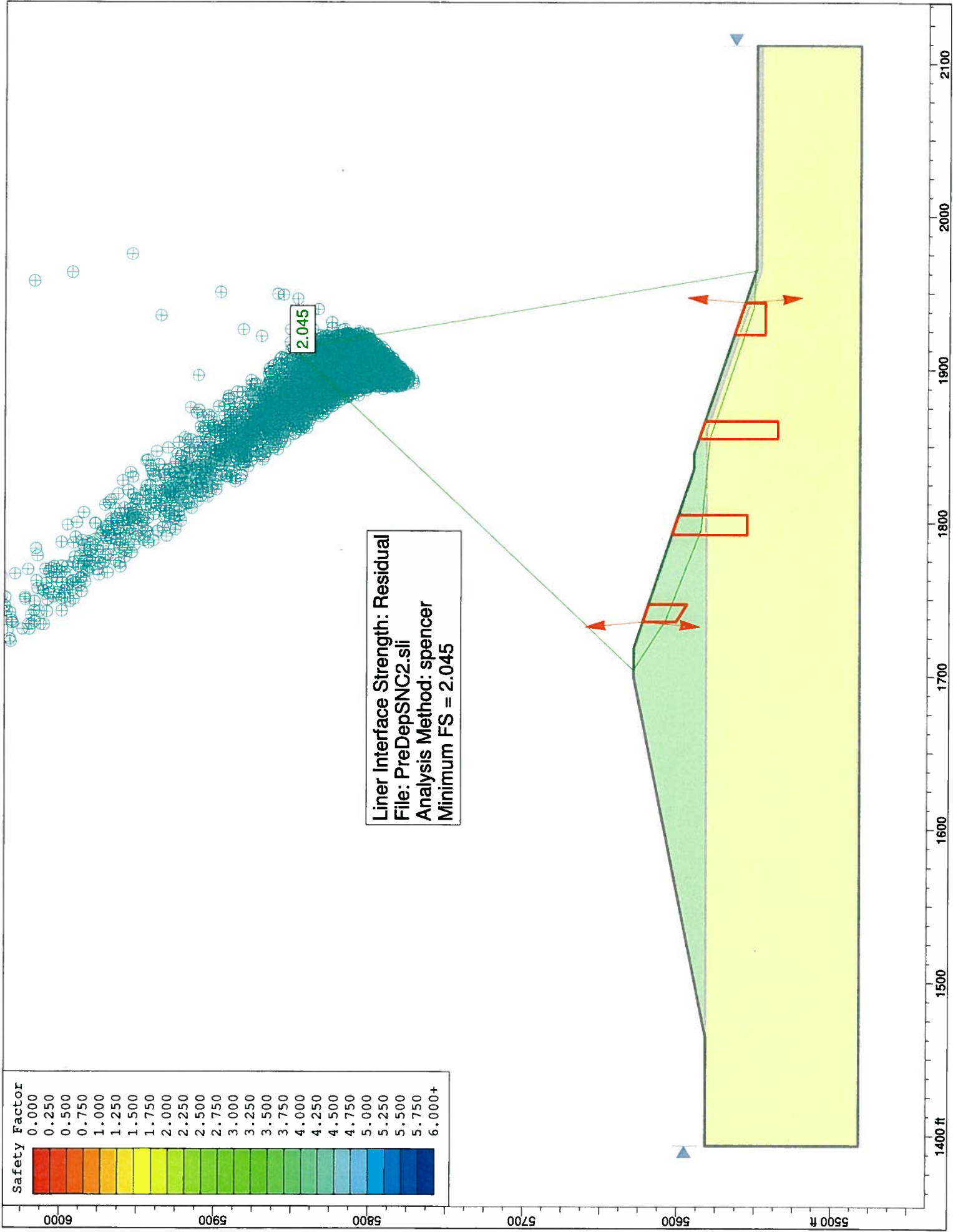

Safety Factor

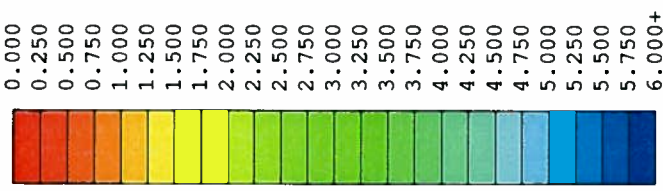

Liner Interface Strength: Residual
File: PreDepSC-H.sli
Analysis Method: spencer
Minimum FS = 1.944

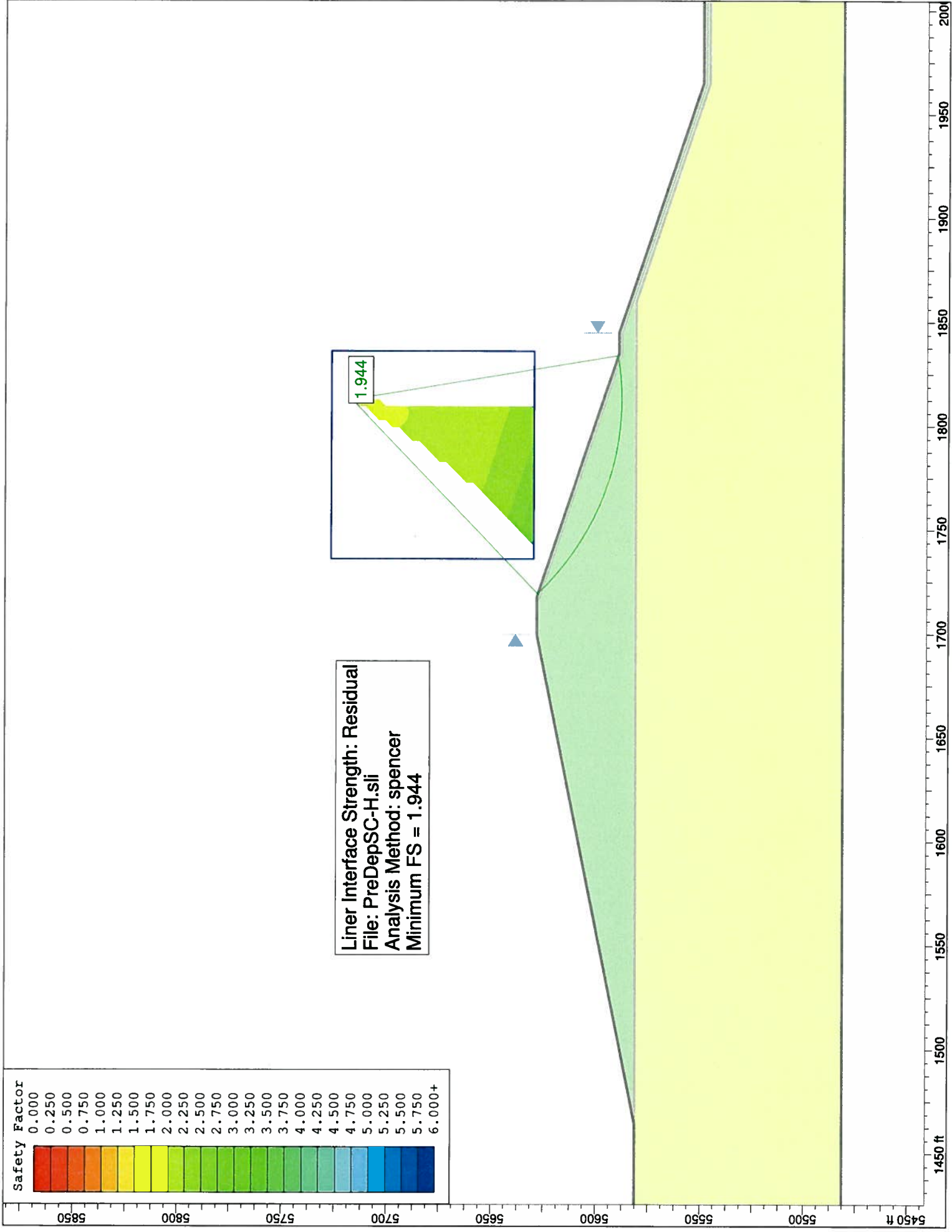
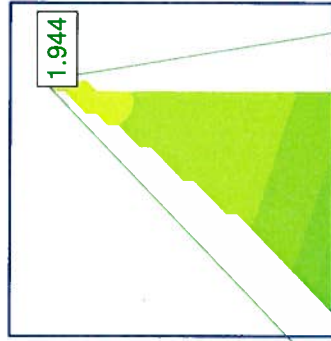

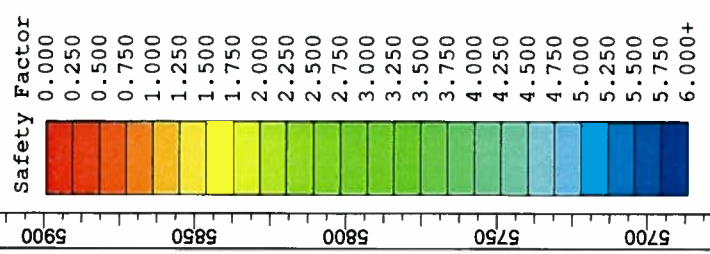
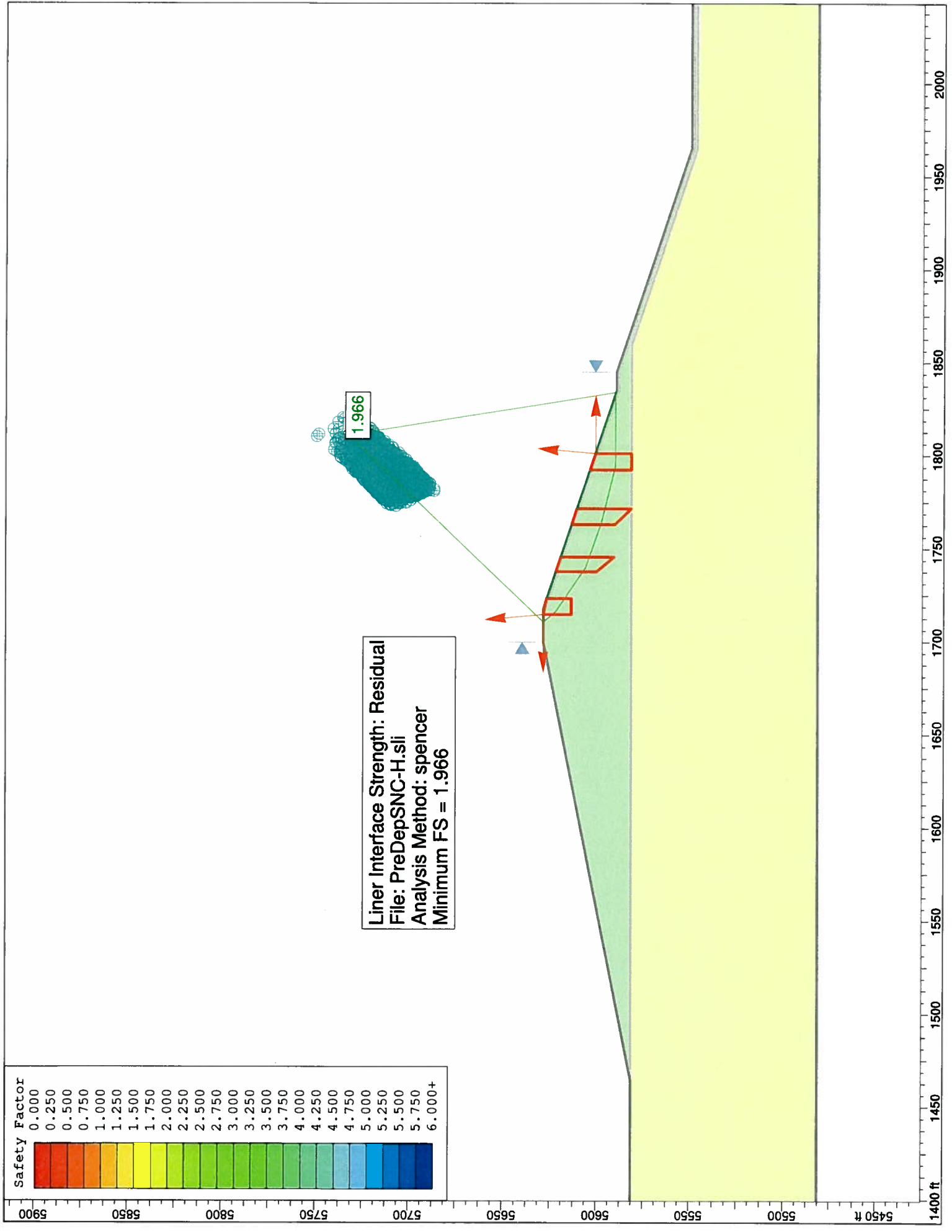

Liner Interface Strength: Residual
 File: PreDepSNC-H.sli
 Analysis Method: spencer
 Minimum FS = 1.966

1.966

1400 ft 1450 1500 1550 1600 1650 1700 1750 1800 1850 1900 1950 2000

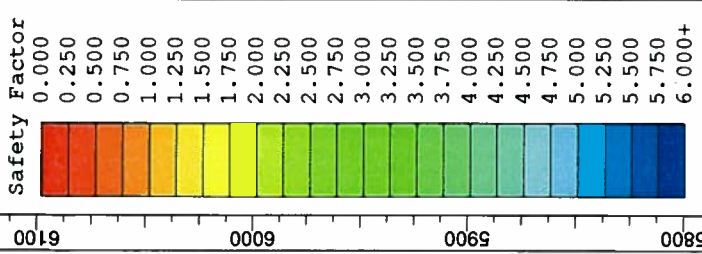

Liner Interface Strength: Residual
 File: PreDepEC.sli
 Analysis Method: spencer
 Minimum FS = 1.772

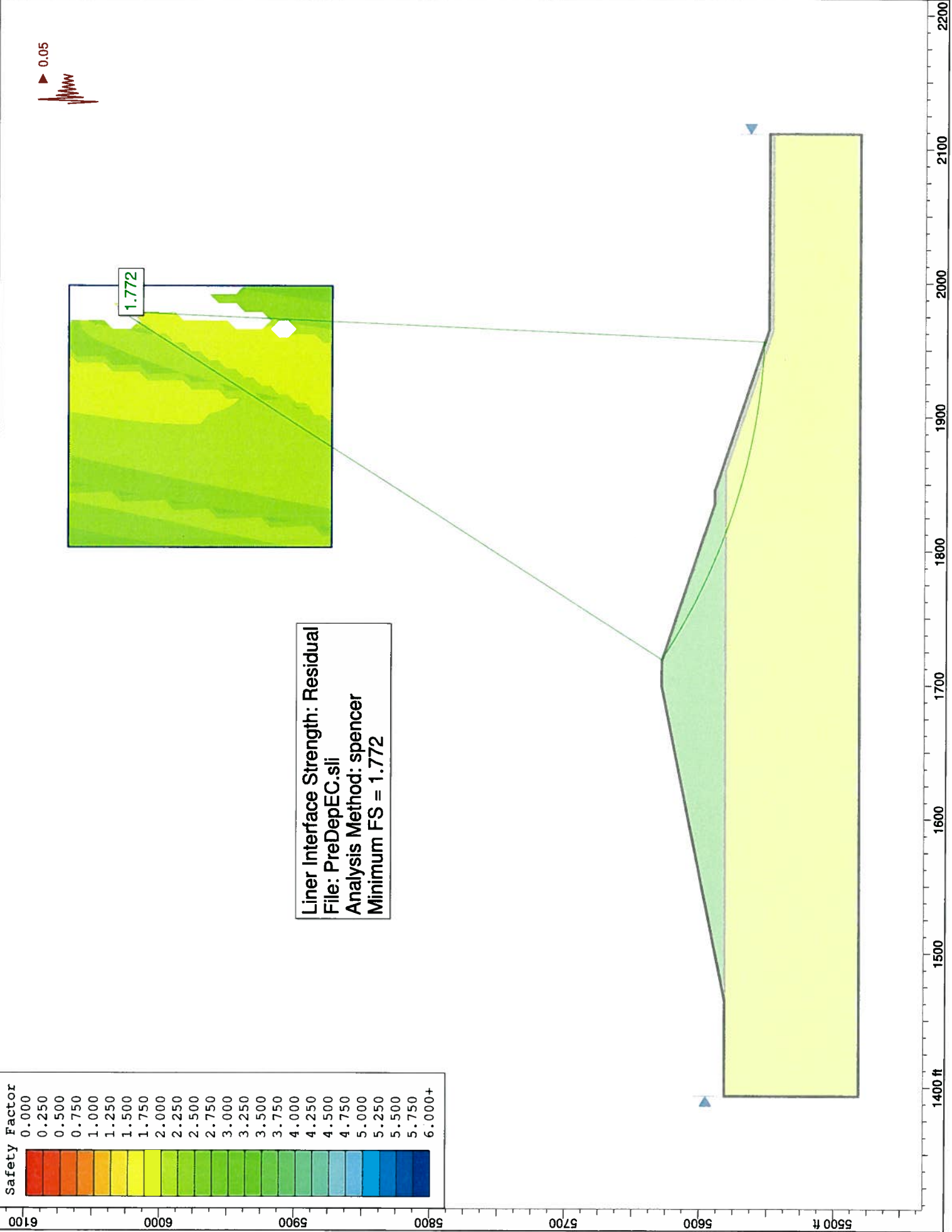
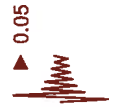
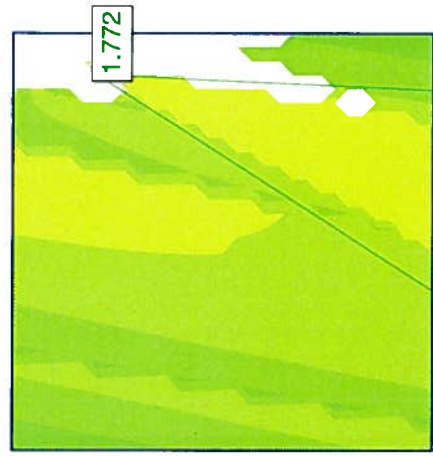

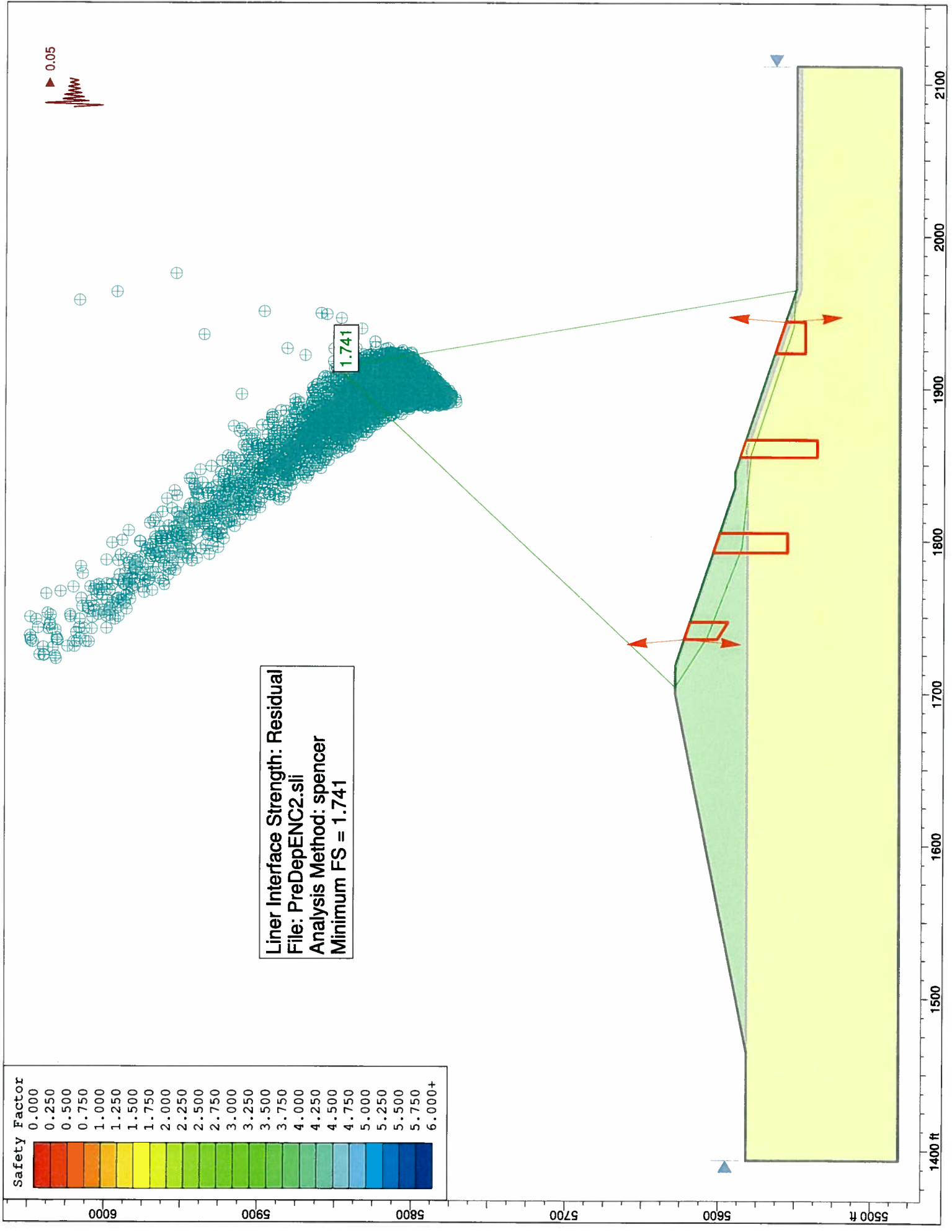

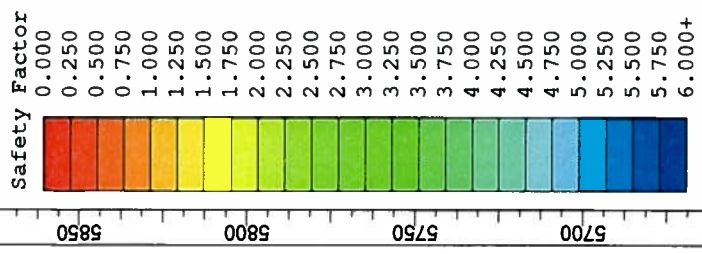

Liner Interface Strength: Residual
 File: PreDepEC-H.sli
 Analysis Method: spencer
 Minimum FS = 1.668

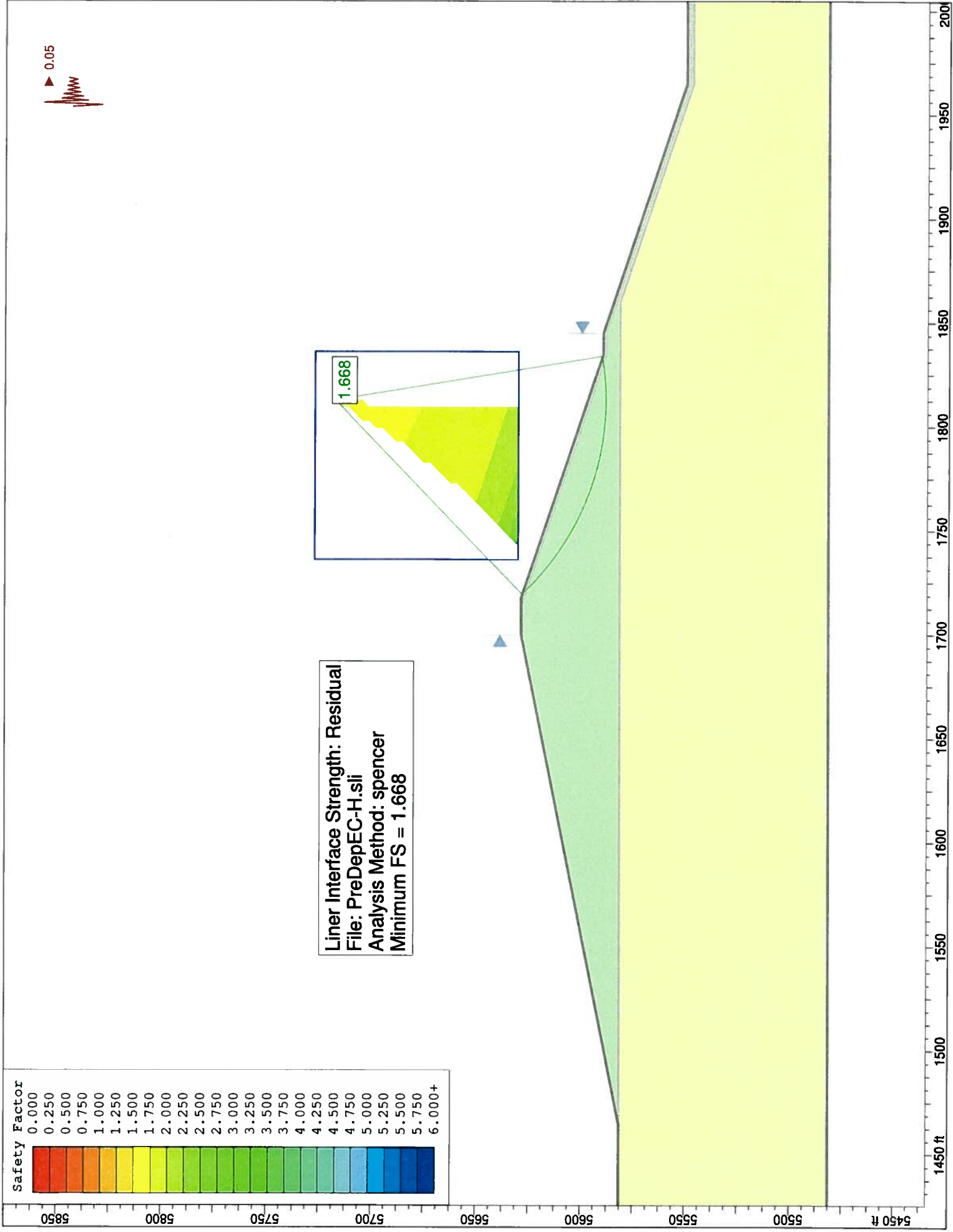
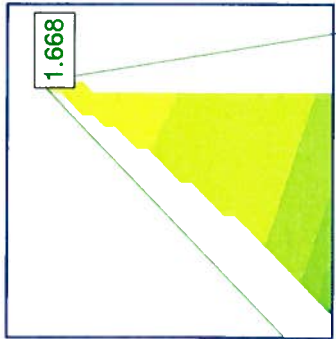
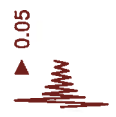

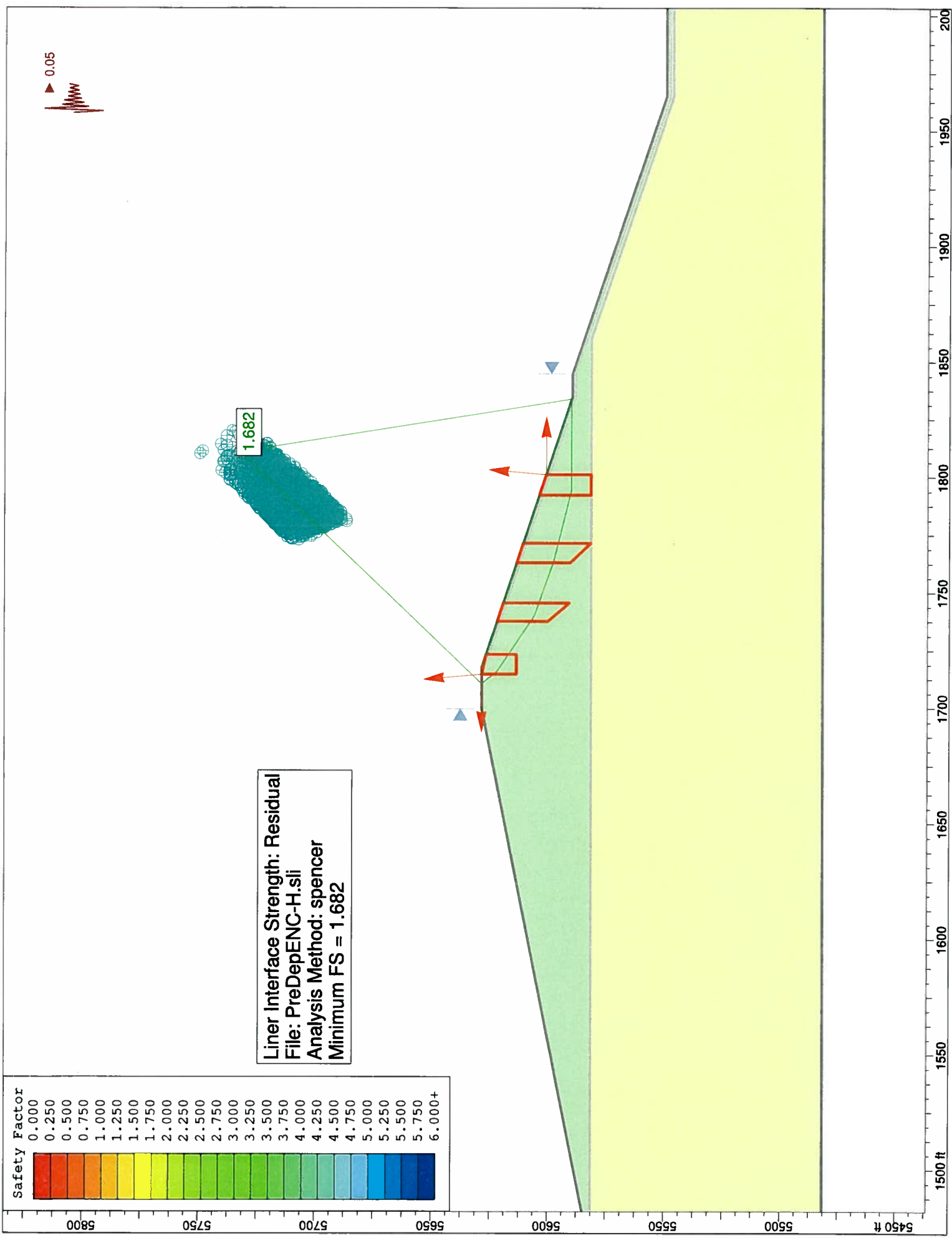

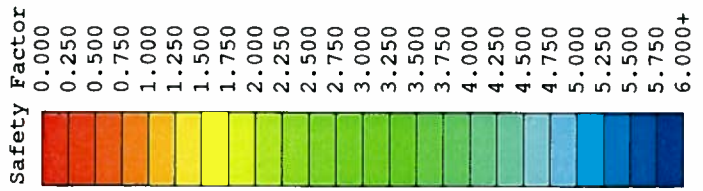
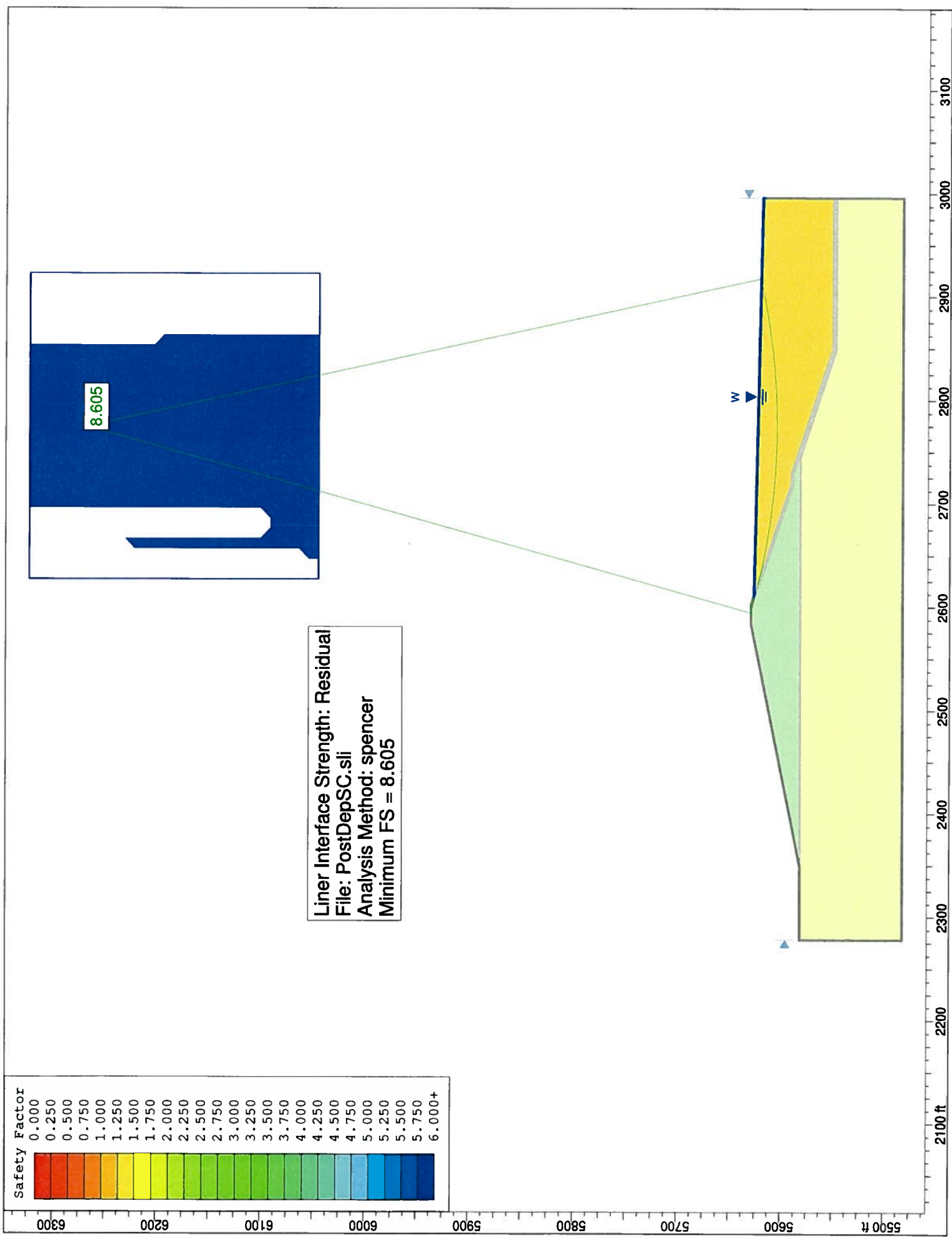

Liner Interface Strength: Residual
 File: PostDepSC.sli
 Analysis Method: spencer
 Minimum FS = 8.605

8.605

W

5500 ft 5600 5700 5800 5900

2100 ft 2200 2300 2400 2500 2600 2700 2800 2900 3000 3100

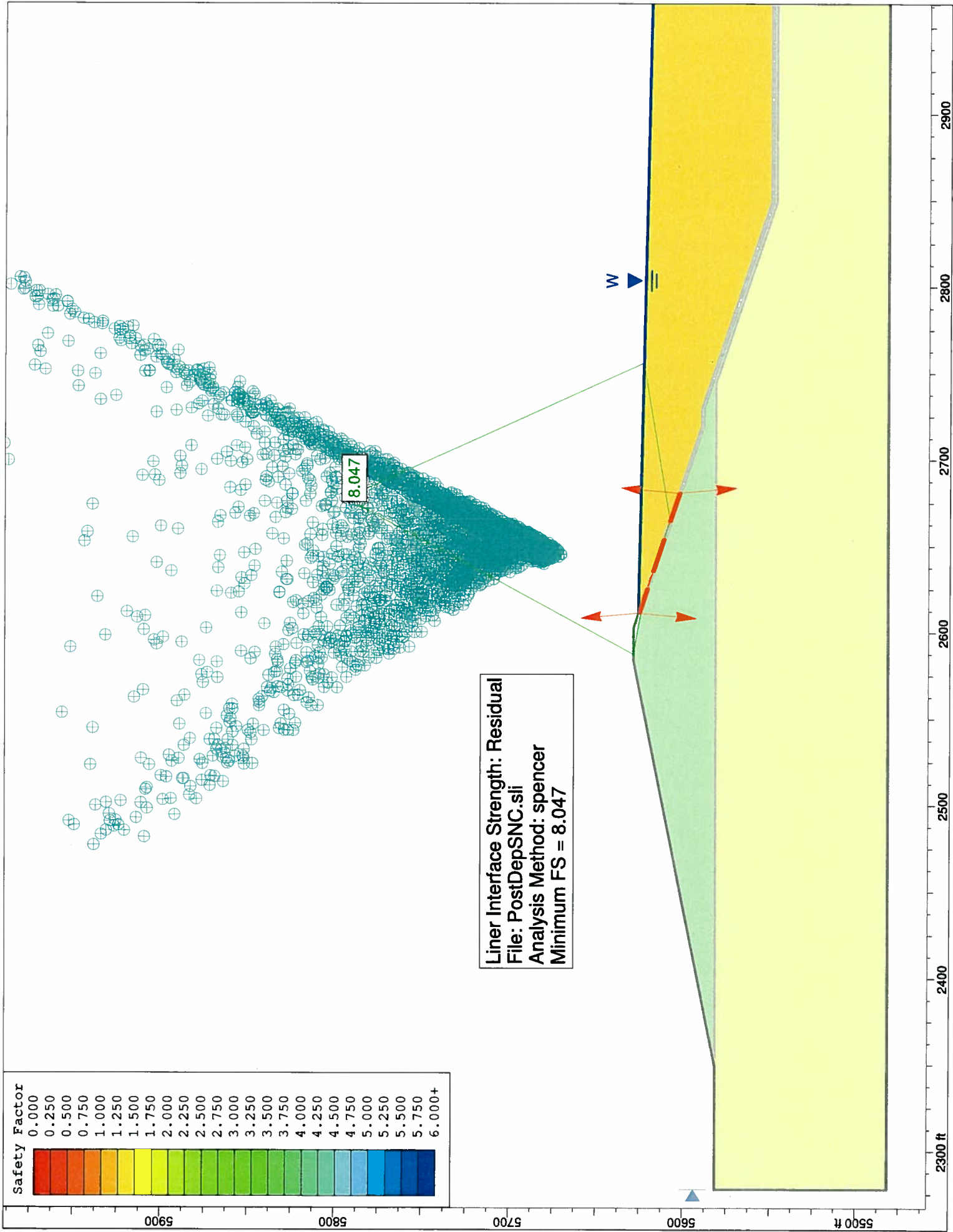

Safety Factor
0.000
0.250
0.500
0.750
1.000
1.250
1.500
1.750
2.000
2.250
2.500
2.750
3.000
3.250
3.500
3.750
4.000
4.250
4.500
4.750
5.000
5.250
5.500
5.750
6.000+

Liner Interface Strength: Residual
 File: PostDepSNC.sli
 Analysis Method: spencer
 Minimum FS = 8.047

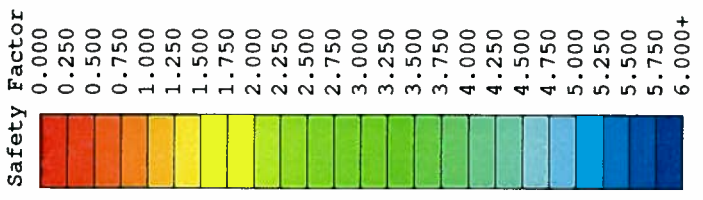

Liner Interface Strength: Residual
 File: PostDepEC.sli
 Analysis Method: spencer
 Minimum FS = 2.521

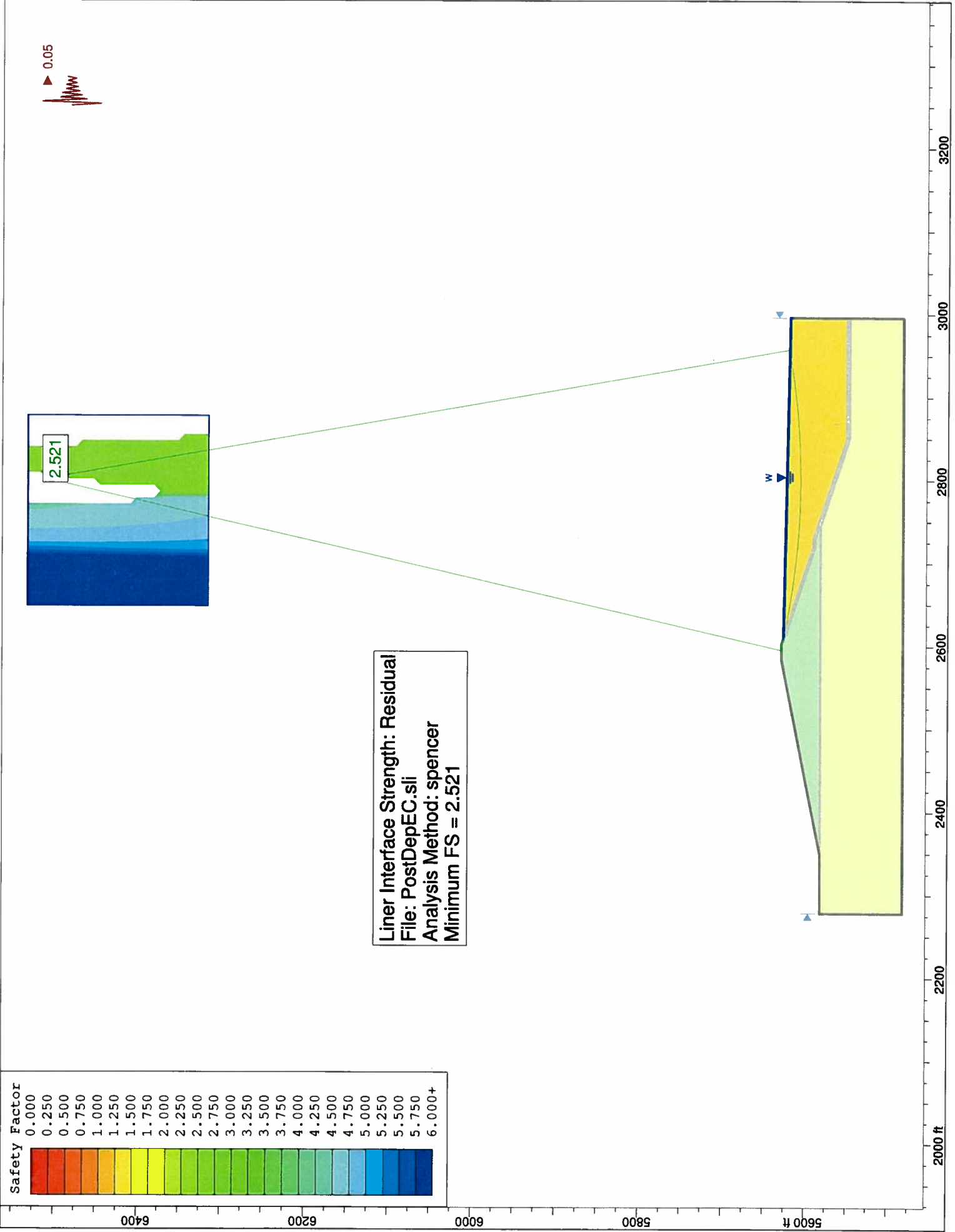
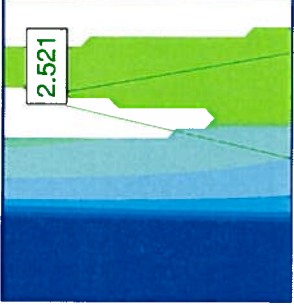

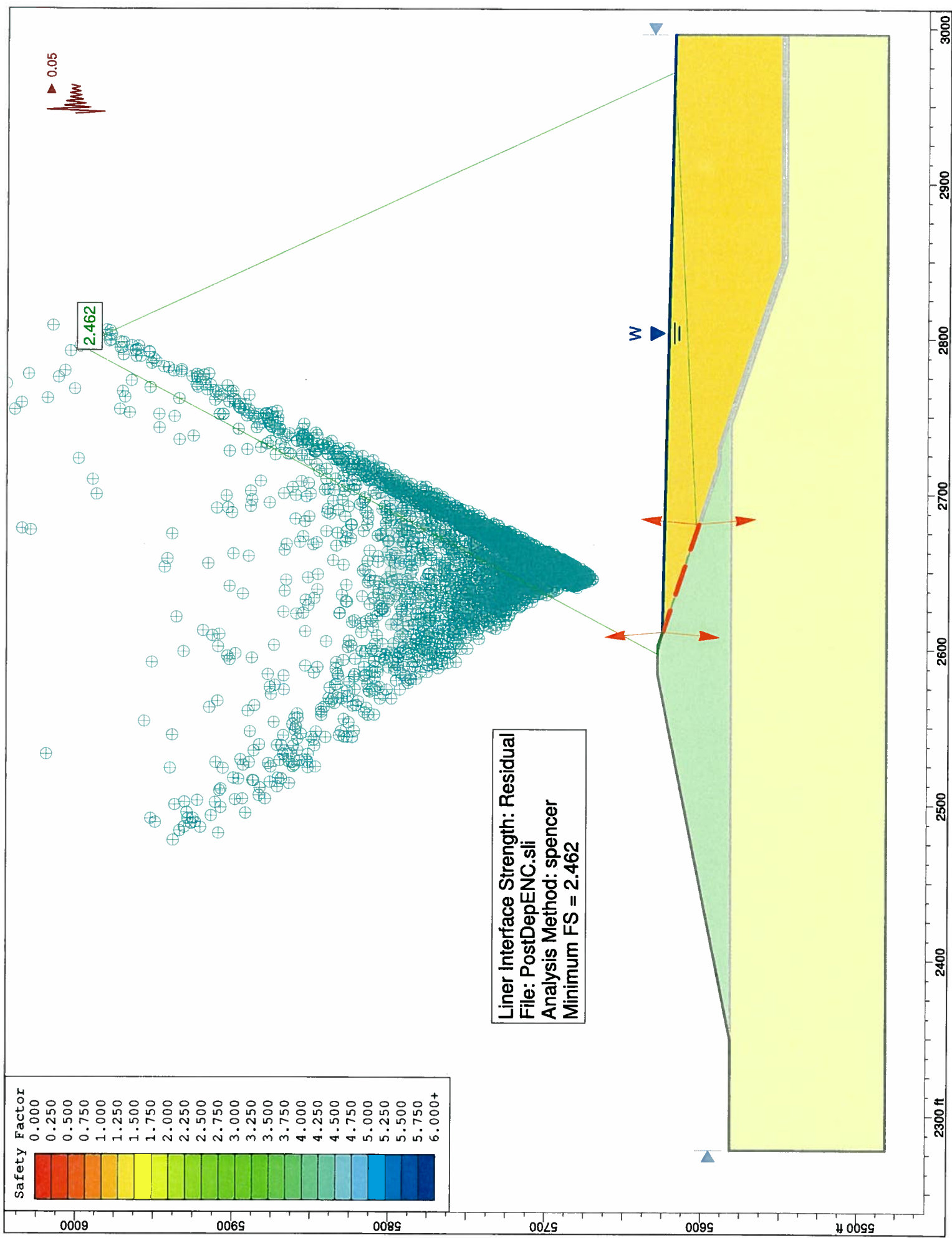

Liner Interface Strength: Residual
 File: PostDepENC.sli
 Analysis Method: spencer
 Minimum FS = 2.462

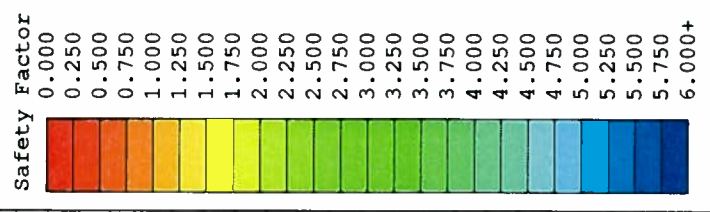

2.462

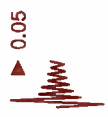

5500 ft
 5600
 5700
 5800
 5900
 6000
 2300 ft
 2400
 2500
 2600
 2700
 2800
 2900
 3000

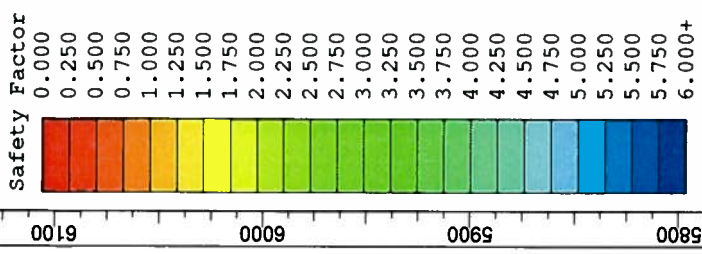

Liner Interface Strength: Residual
 File: PostCloSC.sli
 Analysis Method: spencer
 Minimum FS = 4.812

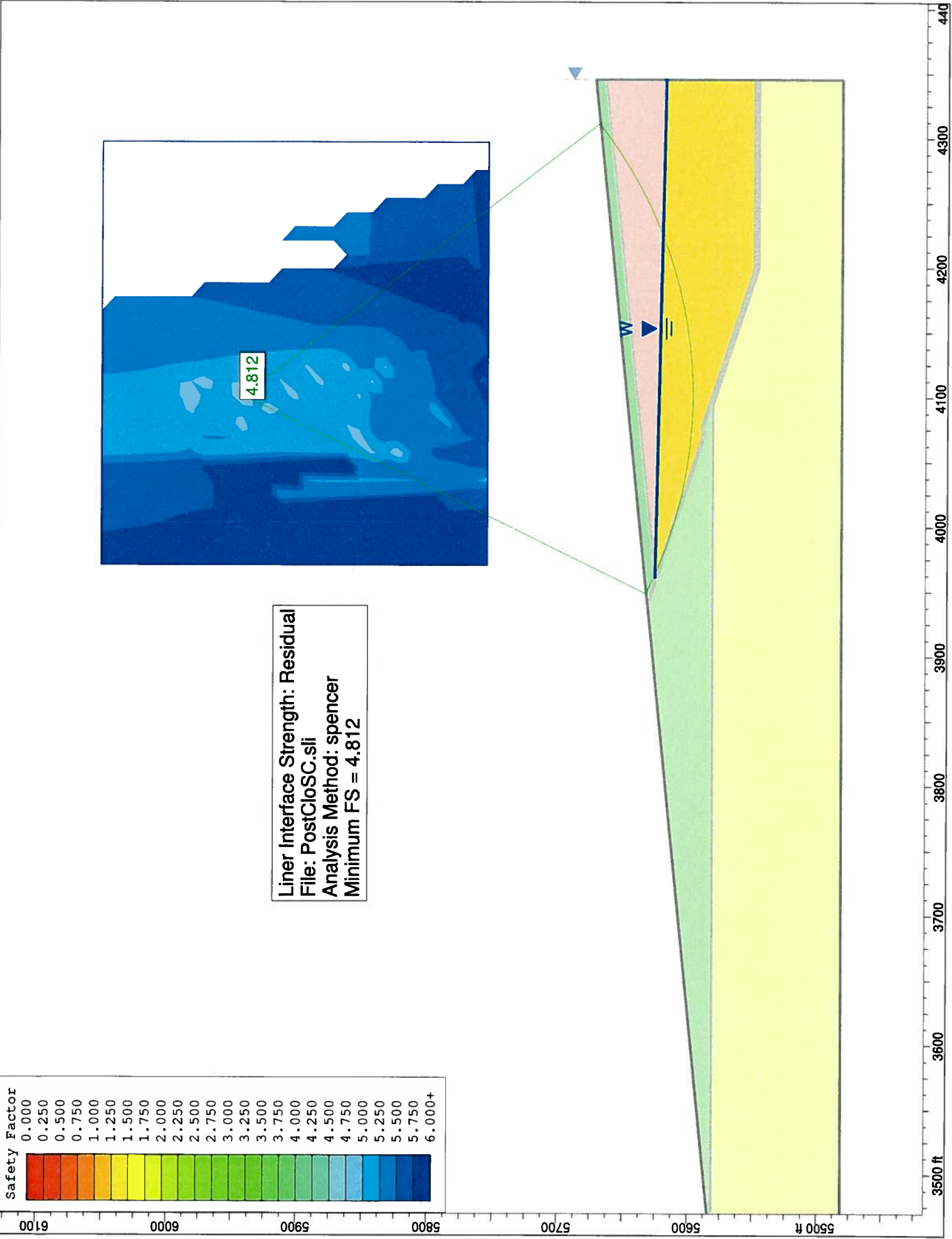
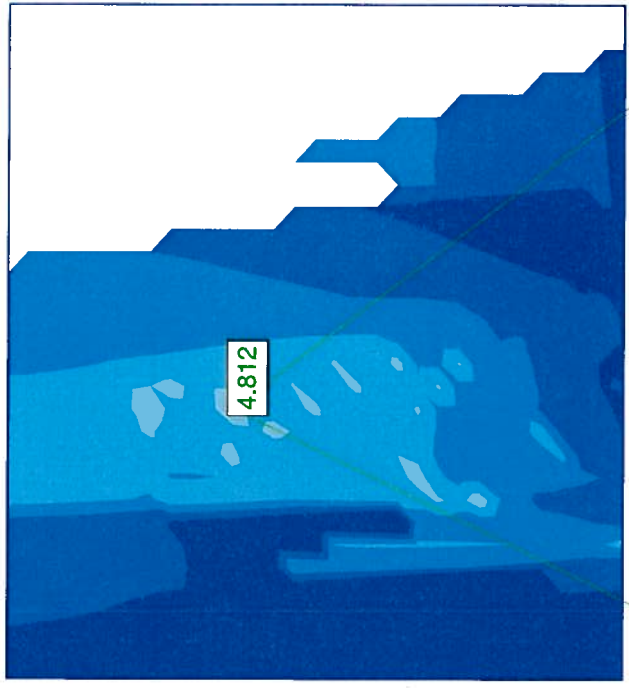

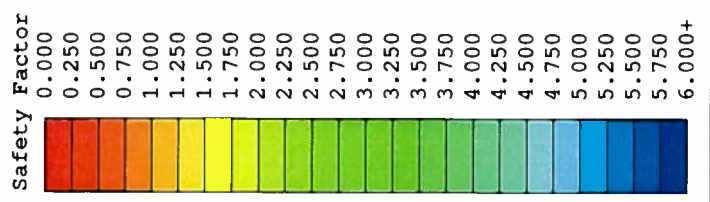
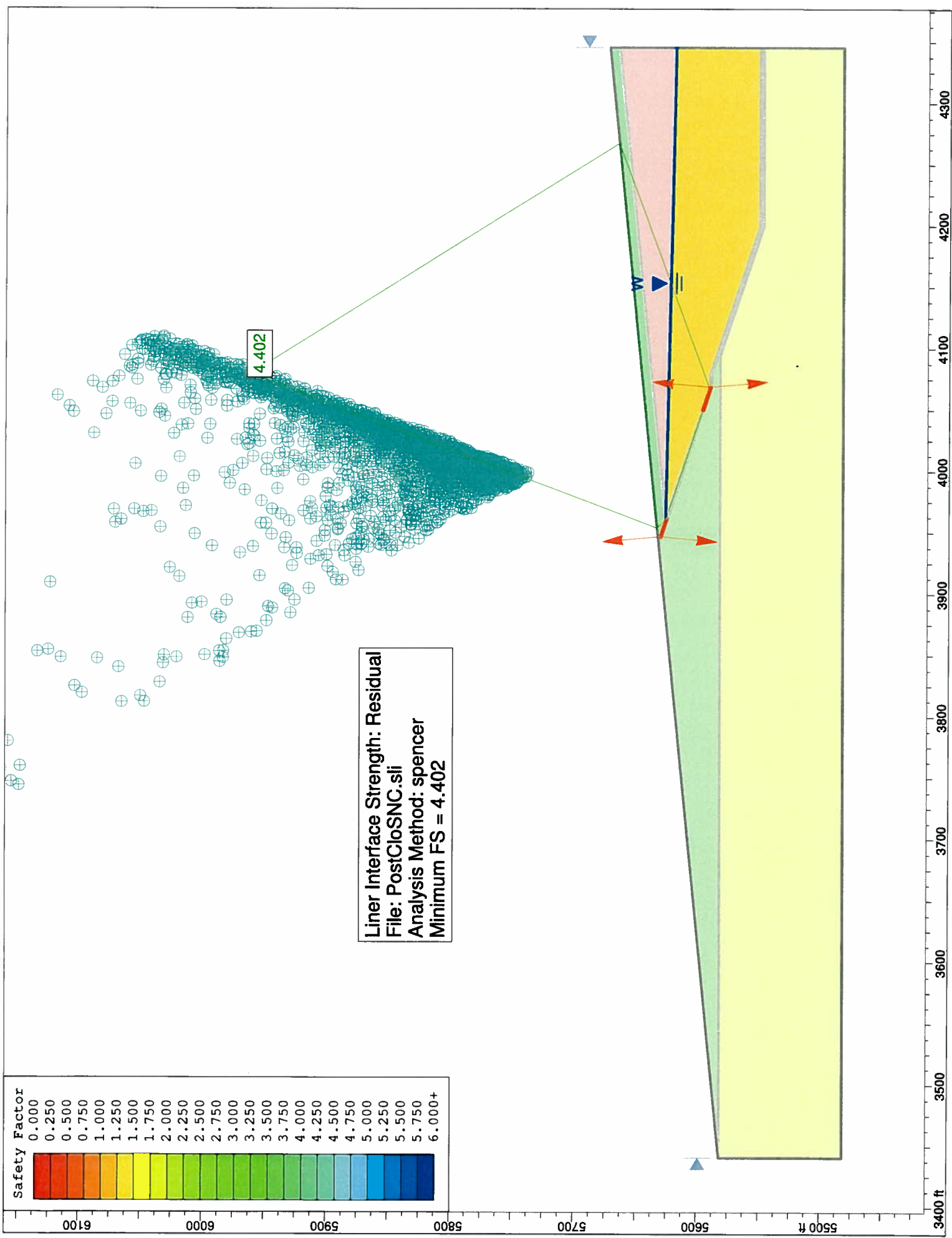

Liner Interface Strength: Residual
 File: PostCloSNC.sli
 Analysis Method: spencer
 Minimum FS = 4.402

4.402

3400 ft 3500 3600 3700 3800 3900 4000 4100 4200 4300

5800 5900 6000 6100

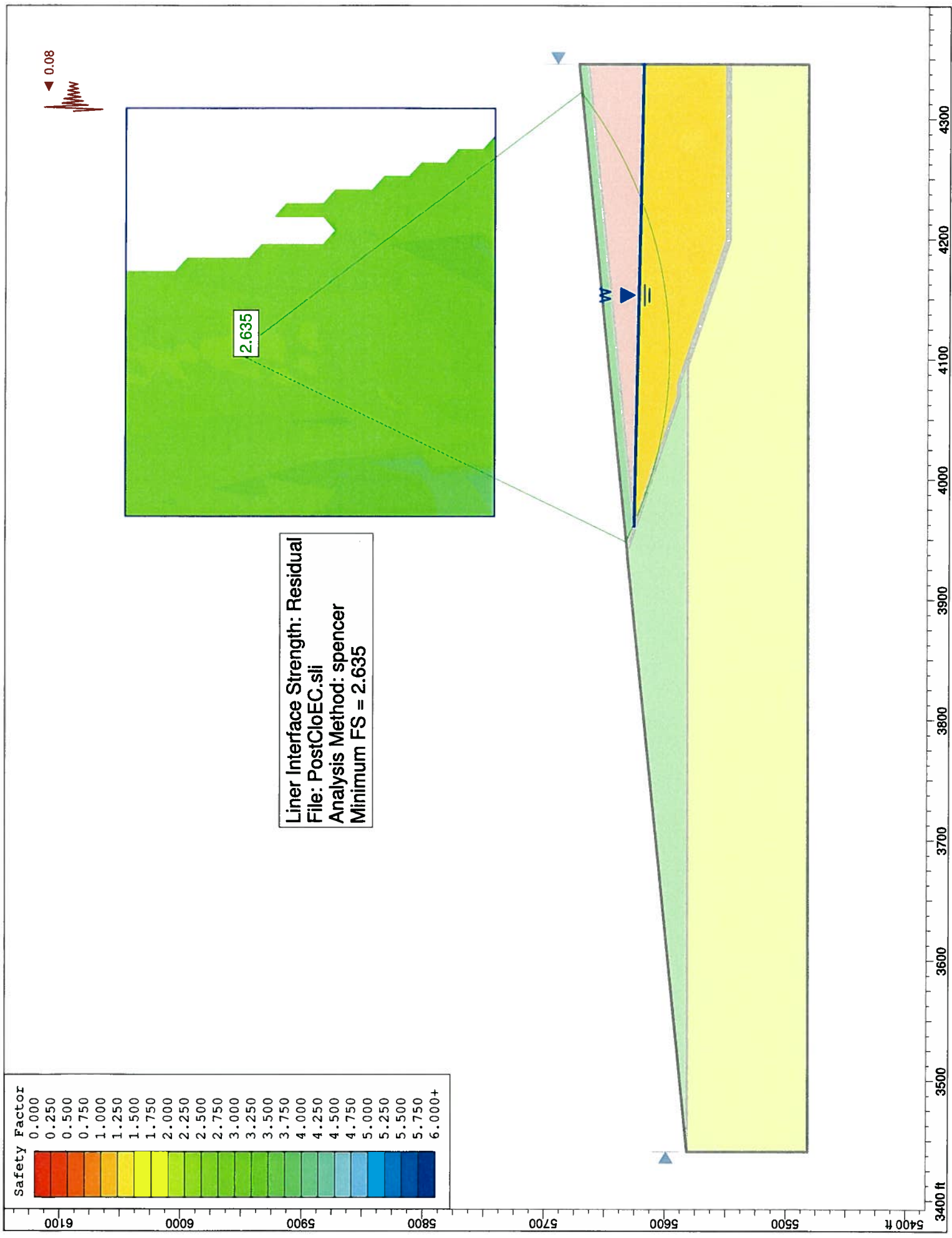

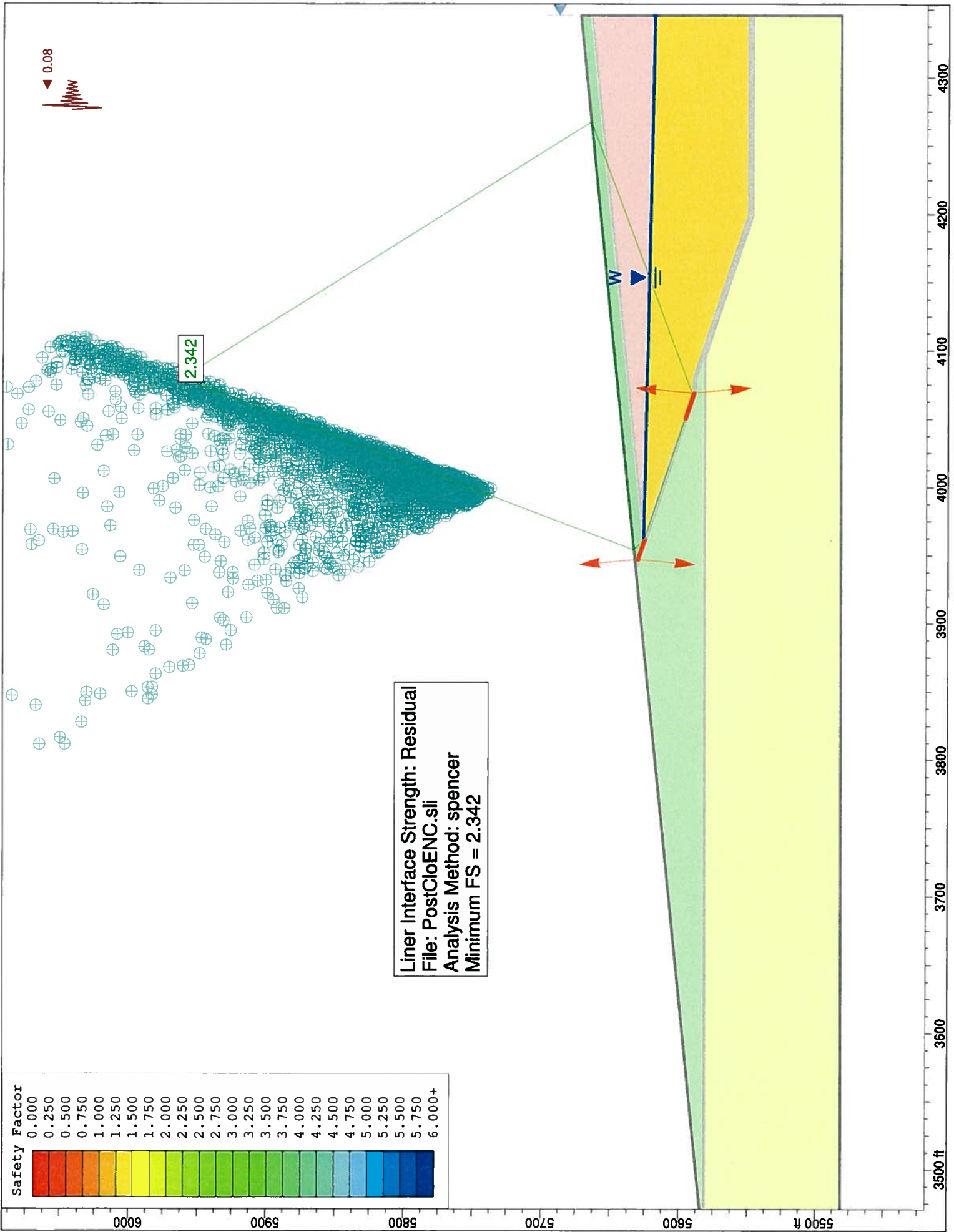

APPENDIX H-2
LINER SYSTEM STABILITY EVALUATION



Subject Piñon Ridge Project
Tailings Cell Design
Liner Stability Calculation

Made by JDE
Checked by <i>KJM</i>
Approved by <i>KJM</i>

Job No 073-81694
Date 5/1/08
Sheet No 1 of 2

OBJECTIVE:

Calculate the factor of safety against sliding of the tailings cell liner system assuming the interior cell slopes approximate an infinite slope situation.

ASSUMPTIONS:

- Adhesion / cohesion between liner interfaces is conservatively neglected;
- Effects of stabilizing agents (i.e. anchor trenches, buttressing pipes, etc.) are ignored; and
- Others as stated.

CALCULATIONS:

The relevant liner interfaces for the tailings cell liner system are:

- Textured Geomembrane vs. Drainage Geocomposite;
- Textured Geomembrane vs. Geosynthetic Clay Liner (GCL); and
- GCL vs. compacted native soil.

Interface shear strength testing was performed on all the above interfaces by Golder's Atlanta soils laboratory, the results of which are presented in Appendix H-1. Based on these results, the weakest interface that governs design is between the textured high density polyethylene (HDPE) geomembrane and the drainage geocomposite. Laboratory tests on this interface indicate that the peak friction angle is 21.2 degrees with apparent adhesion of 7.7 pounds per square inch (psi). This calculation conservatively ignores the adhesion component.

The factor of safety, FS, for an infinite slope problem can be expressed as follows (Das, 1998):

$$FS = \frac{c}{\gamma H \cos^2 \beta \tan \beta} + \frac{\tan \phi}{\tan \beta}$$

Where c is the cohesion/adhesion, γ is the unit weight of the soil above the interface, H is the height of soil above the interface, β is the slope of the interface (in this case, 3H:1V, or 18.4 degrees), and ϕ is the friction angle of the interface. Since adhesion is conservatively being ignored, the left side of the equation goes to zero, and we are left with:

$$FS = \frac{\tan \phi}{\tan \beta} = \frac{\tan 21.2}{\tan 18.4} = 1.2$$



Subject Piñon Ridge Project
Tailings Cell Design
Liner Stability Calculation

Made by JDE
Checked by <i>KFM</i>
Approved by <i>KFM</i>

Job No 073-81694
Date 5/1/08
Sheet 2 of 2 No

CONCLUSIONS:

The factor of safety of 1.2 calculated above indicates that the proposed liner system is stable under its own weight at the proposed tailings cell slopes. It should be noted, however, that this factor of safety excludes the additional retaining capacity provided by the apparent adhesion, as well as the resisting forces supplied via the anchor trenches and liner buttressing.

REFERENCES:

Das, Braja M. (1998). *Principles of Geotechnical Engineering, 4th Edition*. PWS Publishing Company, Boston.

APPENDIX I
TAILINGS CELL WATER BALANCE

APPENDIX I

TAILINGS CELL WATER BALANCE

A probabilistic water balance has been developed for the proposed tailings cells. Since three tailings cells (A,B,C) of approximately equal tailings storage volume and dimensions have been designed for the Piñon Ridge Project to meet a total capacity of approximately 7.3 million tons, the probabilistic water balance has been performed for Tailings Cell A only. The water balance for Tailings Cells B and C will be similar to that of Tailings Cell A. Each of the tailings cells is designed for 13.4 years based on a milling capacity of 500 tons per day (tpd) (with potential expansion capacity of 1,000 tpd) and a total mine life of 40 years.

MODEL DEVELOPMENT

For the purpose of developing the water balance for Tailings Cell A, the following water balance components were considered: (1) the amount of water entering Tailings Cell A from the mill (CH2M Hill, 2008); (2) water entering the system through meteoric precipitation; (3) the amount of water released to the atmosphere through evaporation; (4) the amount of water returning to the mill from Tailings Cell A (CH2M Hill, 2008); and (5) the excess water available to be pumped from the tailings cell. Precipitation values are likely to exhibit largest variations, and were therefore treated as stochastic inputs (i.e., probabilistic), while the other parameters were treated as deterministic variables. Water balance calculations were performed using the computer program *Goldsim*TM. The water balance model was run for a time of operation of 7 years for a 1,000-tpd milling rate and 14 years for a 500-tpd milling rate.

The water balance model was based on the following equation:

$$\Delta S = (Q + P) - (E + RW + EW)$$

where:

ΔS	=	change in stored solution volume
Q	=	inflow from the mill
P	=	precipitation collected within the lined footprint of the tailings cell
E	=	evaporation from the tailings cell surface
RW	=	reclaimed water from the tailings cell pumped back to the mill
EW	=	excess water not required by the mill but available to be pumped from the tailings cell

AVAILABLE DATA

Water balance assumptions and sources of input data are summarized in Table I-1. The evaluation of climate data conducted by Golder for nearby weather stations indicates that the Uravan weather station is likely to provide reasonable precipitation estimates (See Appendix I-1). The average monthly precipitation values for the Uravan weather station are summarized in Table I-2.

The Hargreaves (1985) method was used to estimate monthly evaporation values at the Piñon Ridge site, using the available climate data from the Uravan weather station (i.e., precipitation, air temperature, etc.). The calculated evaporation values were scaled by a factor of 0.7 to represent tailings cell evaporation. Monthly evaporation values used for the water balance calculations are summarized in Table I-2.

Based on design-level process water balance information provided by CH2M Hill (2008) and summarized in Table I-1, the design mass of solids discharging from the mill to the tailings cell was estimated to range from approximately 46,976 lb/hr for a 500-tpd start-up milling rate to 93,952 lb/hr for a 1,000-tpd milling rate. As described in Table I-1, Tailing Cell A has been designed as essentially two ponds (Cells A1 and A2) within a pond (Figure I-1). For simplicity in modeling, the tailings cell water balance was developed assuming that Cell A2 will be filled first to its maximum storage capacity prior to initiating tailings slurry discharge flow to Cell A1. Once both sub-cells are filled to the mid-height bench level, tailings slurry will then be discharged into the entire tailings cell. Tailings slurry will be discharged from several positions around the perimeter of the tailings cells.

Per the design criteria, it was assumed that 3 ft of dry freeboard will be maintained at all times to avoid overflow of the tailings cell solution. Solution will only be reclaimed from the tailings cell pool and returned to the mill when water pool depth is 5 ft or greater.

DEVELOPMENT OF STOCHASTIC PRECIPITATION PARAMETERS

In order to develop stochastic precipitation input for the *Goldsim* model, continuous probability distributions were calibrated against the available monthly precipitation data from the Uravan weather station. The Weibull distribution was selected due to its flexibility to represent a wide range of values. The distribution is truncated at its lower end and has a long tail to the upper end, making it well-suited to modeling extreme positive values, such as precipitation events with longer return

periods. Separate Weibull distributions were fitted to non-zero precipitation records collected for each month. A moment estimation method was used to determine distribution parameters resulting in fitting coefficients summarized in Table I-3.

To verify the adopted probability distributions, a precipitation model was constructed in *Goldsim*TM and allowed to run for a 1-year period using Monte-Carlo sampling with 1,000 realizations. *Goldsim* results are compared against recorded values for the Uravan weather station in Figures I-2 to I-13 for the months of January through December, respectively, with annual totals in Figure I-14. *Goldsim* results show favorable agreement between the measured and calculated extreme values on both monthly and annual basis.

WATER BALANCE RESULTS

The adequate pool volume and additional volume of water available for reclaim were evaluated at different stages of the facility development assuming a maximum time of operation of 7 years for a 1,000-tpd milling rate and 14 years for a 500-tpd milling rate. *Goldsim* calculations were based on the stochastic monthly precipitation records generated by using Weibull's distribution parameters presented in Table I-3, and illustrated in Figures I-2 through I-13.

The 1 in 1,000 year reoccurrence storm event was modeled to estimate the pool volume and additional volume of water available for reclaim as follows:

$$\text{Cumulative probability} = 1 - (1 - p)^n,$$

Where:

p = annual probability of occurrence

n = number of years to evaluate

Thus, the probability that the 1,000-year storm event will occur during the 7-year tailings disposal period for a 1,000-tpd milling rate is approximately 0.7%. The probability that the 1,000-year storm event will occur during the 14-year tailings disposal period for a 500-tpd milling rate is approximately 1.4%. The estimated pool volume capacity for Tailings Cell A was estimated for the 99.3rd percentile (100% minus 0.7%) for a 1,000-tpd milling rate and for the 98.6th percentile (100% minus 1.4%) for a 500-tpd milling rate. A Monte-Carlo simulation with 5,000 realizations (due to relatively high target

probabilities in Monte Carlo simulations) was used to evaluate the 99.3rd and the 98.6th percentile quantities after 1, 2, 5, 7 and 14 years of operation.

Results from the probabilistic analyses are summarized in Tables I-4 through I-6 and Figures I-15 through I-20.

SUMMARY

The stochastic water balance model for the 1,000-tpd milling rate indicates that a maximum tailings cell pool volume of approximately 8.38 million ft³ (Mft³) is obtained for the 99.3rd percentile (i.e., 1,000-year storm occurs during deposition), with a median pool volume of 7.31 Mft³. For a 500-tpd milling rate, the required tailings cell pool volume reduces to 4.75 Mft³ (98.6th percentile). At all times during operations, a minimum excess volume capacity of 3.94 Mft³ of freeboard volume (corresponding to 3 ft of dry freeboard) will be available to prevent overtopping during tailings deposition.

As demonstrated on Figures I-18 and I-22, the volume of excess water available as make-up (in excess of the design return volume flow to the mill) is essentially negligible after approximately 3.5 years for the 500-tpd milling scenario and very small after 2 years for the 1,000-tpd milling scenario. The average excess pumping rates available to pump excess water from the tailings cell at different time intervals of the operation are summarized in Table I-6. Results were estimated assuming that the mill will have a pumping rate of 405 gpm for a 1,000-tpd milling rate and 203 gpm for a 500-tpd milling rate to pump back reclaimed water from the tailings cell to the mill (CH2M Hill, 2008), and that the available excess water can be: 1) pumped back to the mill where the water could be used as make-up water; or 2) discharged into the evaporation pond system. It should be noted that the design raffinate flow rate to the evaporation ponds (CH2M Hill, 2008), is an average value which already accounts for this potential excess flow from the tailings cells during discrete time intervals (per personal communication with Mike Blois of CH2M Hill).

As shown on Figures I-16 and I-20, a design return volume flow of 203 and 405 gpm (corresponding to a 500- and 1,000-tpd milling rate, respectively) will not be achievable at some time intervals over the design life of the tailings cell. The excess water available from the tailings cell during wet times, therefore, can be used to accommodate this need during the dry times.

REFERENCES

CH2M Hill. 2008. "Piñon Ridge Project, Tailings Stream Analysis (Rev. 2)." Memo issued by Brett Berg. 12 March 2008.

Hargreaves, G.L., Hargreaves, G.H., and Riley, J.P., 1985, "Agricultural benefits for Senegal River Basin", *Journal of Irrigation and Drainage Engineering*, ASCE 111:113-124.

TABLE I-1
WATER BALANCE MODEL ASSUMPTIONS

Property	Value	Source	Comment/Assumptions
Dimensions for Tailings Cell A	725 feet (ft) x 1,847 ft (maximum dimensions)	See Figure I-1	Designed as two cells within Tailings Cell A with a divider berm constructed at elevation 5,500 ft and with two independent leak detection systems (LDS) and tailings underdrain systems. Internal side slopes of 3H:1V with minimum base grade of one percent (%) and 3 ft of dry freeboard.
Watershed Area for Tailings Cell A	32.5 acres	Golder design	Golder design assumptions. The watershed area includes the lined area and the area for the access road.
Tailings Disposal Rate	1,000 tpd – ultimate; 500 tpd – start-up	CH2M Hill (2008)	Ultimate disposal rate of 1,000 tpd (design mass of solids of 93,952 pounds/hour (lb/hr)) and start-up disposal rate of 500 tpd (design mass of solids of 46,976 lb/hr)
Specific Gravity of Solids	2.69	CH2M Hill (2008)	
Solids Content	27.3%	CH2M Hill (2008)	
Average In-Place Tailings Dry Density	95 pounds per cubic foot (pcf)	Assumed	
Beach Slope	2 and 0.5 %	Assumed	Compound slope with 2 % for approximately 500 ft in the perimeter sand zone and 0.5% in the slimes zone.
Pumping Rate (from Tailings Cell A to mill)	405 gallons per minute (gpm) – ultimate; 203 gpm – start-up	CH2M Hill (2008)	Design return volume flow from Tailings Cell A to the mill
Percentage of Tailings Beach that is wet	20%	Assumed	
Climate Data	Varies	See Appendix I-1	Use climate data for Uravan (NCDC No. 058560)
Annual Pan Evaporation	55 to 60 inches	See Figure I-1-10 of Appendix I-1	Use pan factor of 0.7 to estimate Tailings Cell A evaporation

Notes:

1. Tailings stream analysis for project design provided by CH2M Hill (2008).

TABLE I-2
MONTHLY PRECIPITATION AND EVAPORATION VALUES

Month	Average* Precipitation (inches)	Minimum* Precipitation (inches)	Maximum* Precipitation (inches)	Tailings Cell A Evaporation (inches)
January	0.88	0	3.19	0.8
February	0.76	0	2.05	1.2
March	1.03	0	3.43	2.2
April	1.01	0.03	2.68	3.3
May	0.94	0	2.85	4.8
June	0.48	0	1.65	5.8
July	1.19	0.09	3.54	6.3
August	1.36	0.18	3.32	5.4
September	1.5	0.06	4.78	3.8
October	1.51	0	5.89	2.5
November	1.05	0	2.39	1.2
December	0.88	0.03	3.55	0.7

* Precipitation values obtained for Uravan weather station from 1961 to 2007

TABLE I-3
WEIBULL DISTRIBUTION PARAMETERS

Month	Slope Parameter (-)	Mean Minus Minimum* (inch/month)
January	1.49	0.78
February	1.35	0.71
March	1.27	0.97
April	1.32	0.93
May	1.13	0.89
June	0.98	0.44
July	1.57	1.09
August	1.51	1.28
September	1.28	1.39
October	1.25	1.46
November	1.75	0.98
December	1.48	0.76

*Minimum monthly precipitation was set to 0.1 inches per month for all *Goldsim* simulations.

**TABLE I-4
PROBABILISTIC TAILINGS CELL POOL VOLUMES**

Probability	Milling Rate (tpd)	Tailings Cell Pool Volume at Different Times of Operation (ft ³)				
		Year 1	Year 2	Year 5	Year 7	Year 14
98.6 th percentile	500	1,310,480	2,169,730	4,634,550	5,324,510	4,746,010
99.3 rd Percentile	1,000	2,362,260	3,089,570	7,022,990	8,375,190	*
Median	500	1,310,480	1,990,430	2,931,960	2,906,630	1,532,810
	1,000	2,270,090	2,676,730	6,654,030	7,314,080	*

* The model was run for a time of operation of 7 years for a 1,000-tpd milling rate and 14 years for a 500-tpd milling rate.

**TABLE I-5
PROBABILISTIC CUMULATIVE EXCESS WATER VOLUMES
AVAILABLE FROM THE TAILINGS CELL**

Probability	Milling Rate (tpd)	Probabilistic Cumulative Excess Water Volumes Available from the Tailings Cell at Different Times of Operation (ft ³)				
		Year 1	Year 2	Year 5	Year 7	Year 14
98.6 th percentile	500	996,502	1,769,230	6,119,570	6,285,710	6,484,390
99.3 rd Percentile	1,000	1,402,530	4,844,340	7,356,380	8,630,730	*
Median	500	517,423	878,480	3,980,010	3,980,010	3,980,010
	1,000	996,089	3,755,860	3,823,780	3,833,560	*

* The model was run for a time of operation of 7 years for a 1,000-tpd milling rate and 14 years for a 500-tpd milling rate.

**TABLE I-6
PROBABILISTIC AVERAGE EXCESS PUMPING RATES**

Probability	Milling Rate (tpd)	Probabilistic Average Excess Pumping Rates at Different Time Intervals of Operation (gpm)				
		Years 0-1	Years 0-2	Years 3-5	Years 6-7	Years 8-14
98.6 th percentile	500	14.2	12.6	20.6	1.2	0.4
99.3 rd Percentile	1,000	19.9	34.4	11.9	9.1	*
Median	500	7.4	6.3	14.7	0.0	0.0
	1,000	14.2	26.7	0.3	0.1	*

* The model was run for a time of operation of 7 years for a 1,000-tpd milling rate and 14 years for a 500-tpd milling rate.

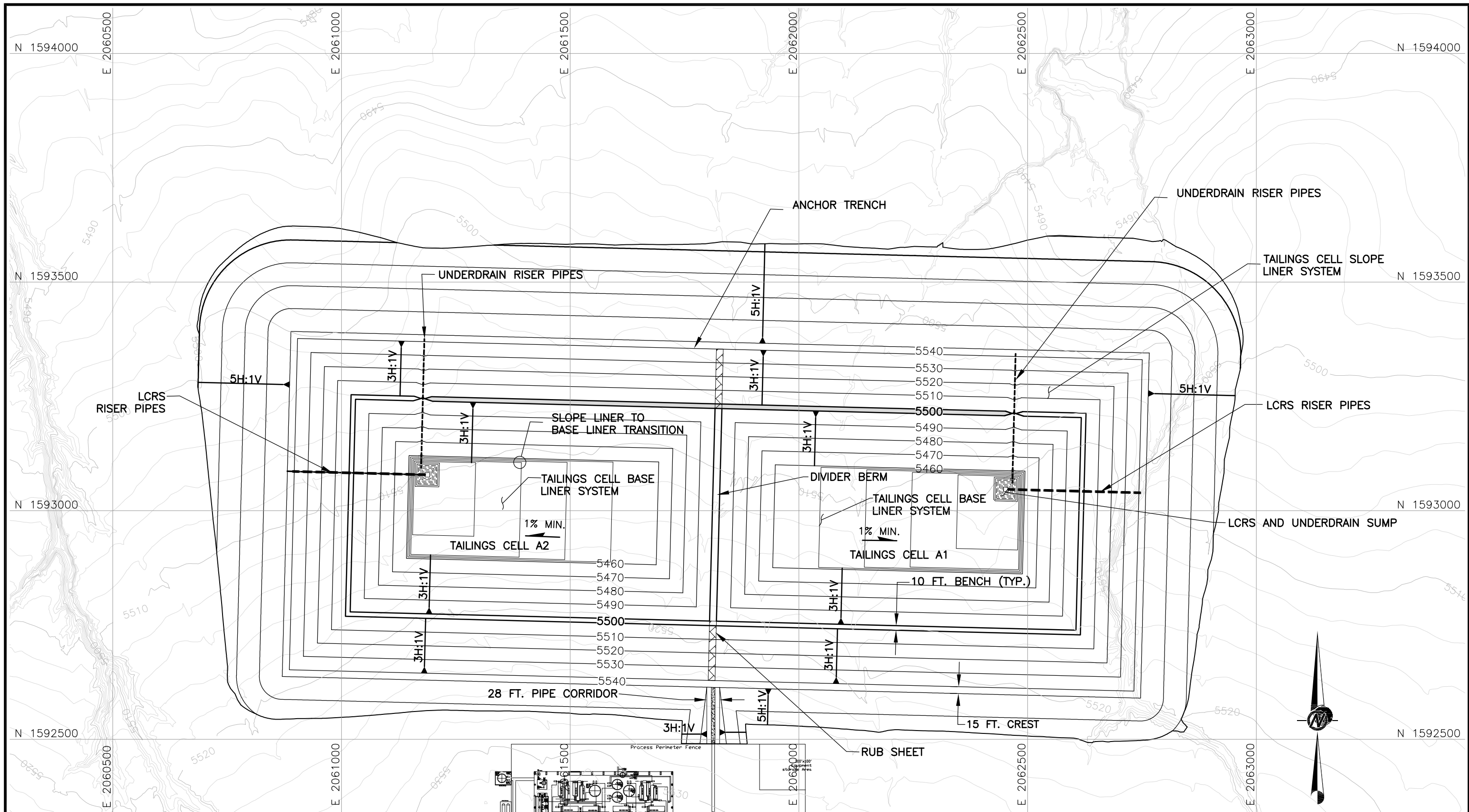

LEGEND

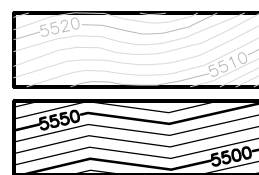

EXISTING GROUND TOPOGRAPHY

PROPOSED FINISHED GRADE TOPOGRAPHY

TOE ——— CREST ——— SLOPE DIRECTION

----- UNDERDRAIN RISER PIPES

----- LCRS RISER PIPES

TYPICAL TAILINGS CELL LAYOUT
FIGURE I-1



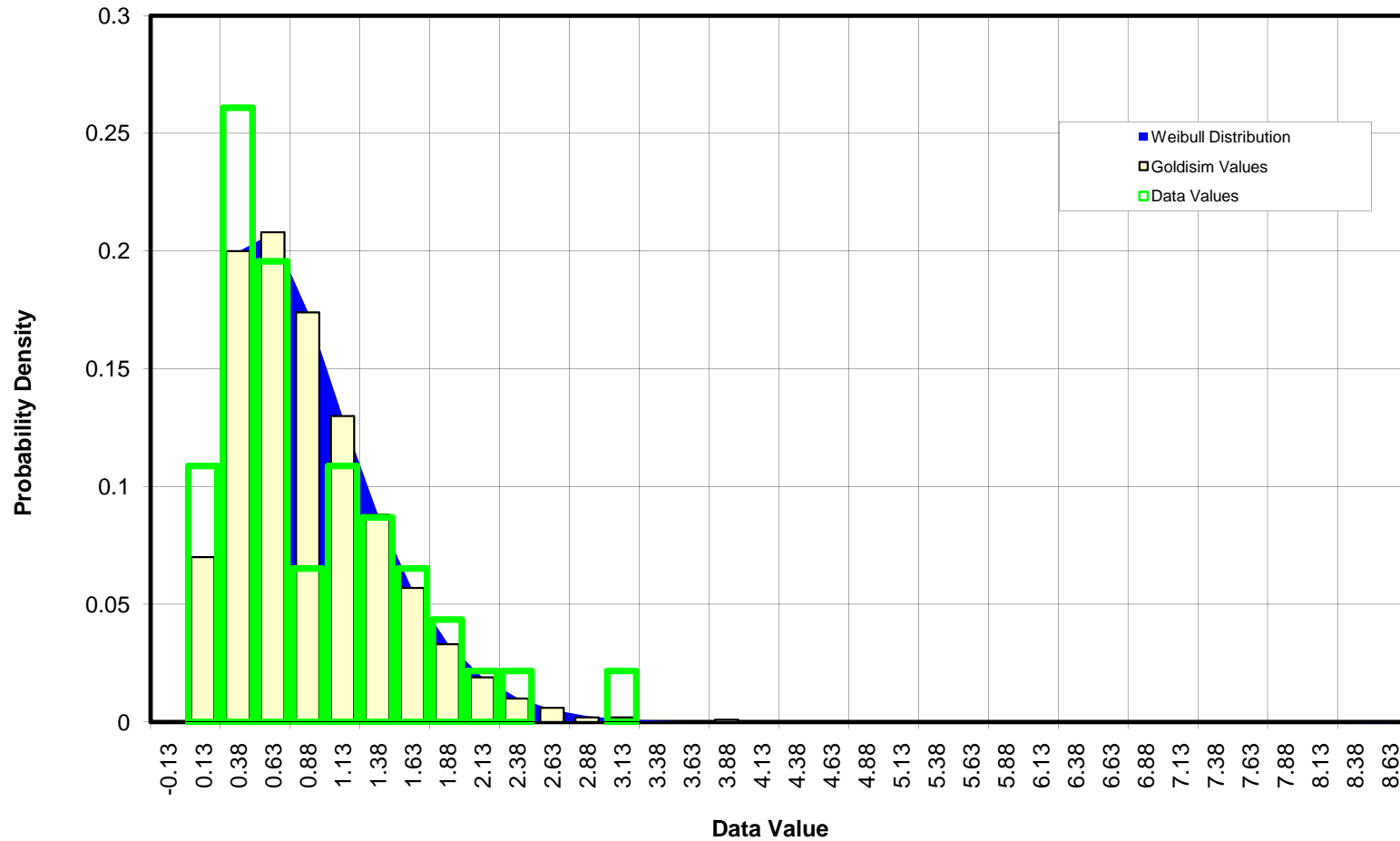

Denver, Colorado

TITLE

URAVAN DATA, GOLDSIM RESULTS AND WEIBULL DISTRIBUTION FOR JANUARY

CLIENT/PROJECT

**ENERGY FUELS RESOURCES CORPORATION
PIÑON RIDGE PROJECT**

DRAWN

GG

DATE

Oct-08

JOB NO.

073-81694

CHECKED

DPH

SCALE

AS SHOWN

DWG. NO.

N/A

REVIEWED

KFM

FILE NO.

Figures2-22_05May08.xls

FIGURE NO.

FIGURE I-2

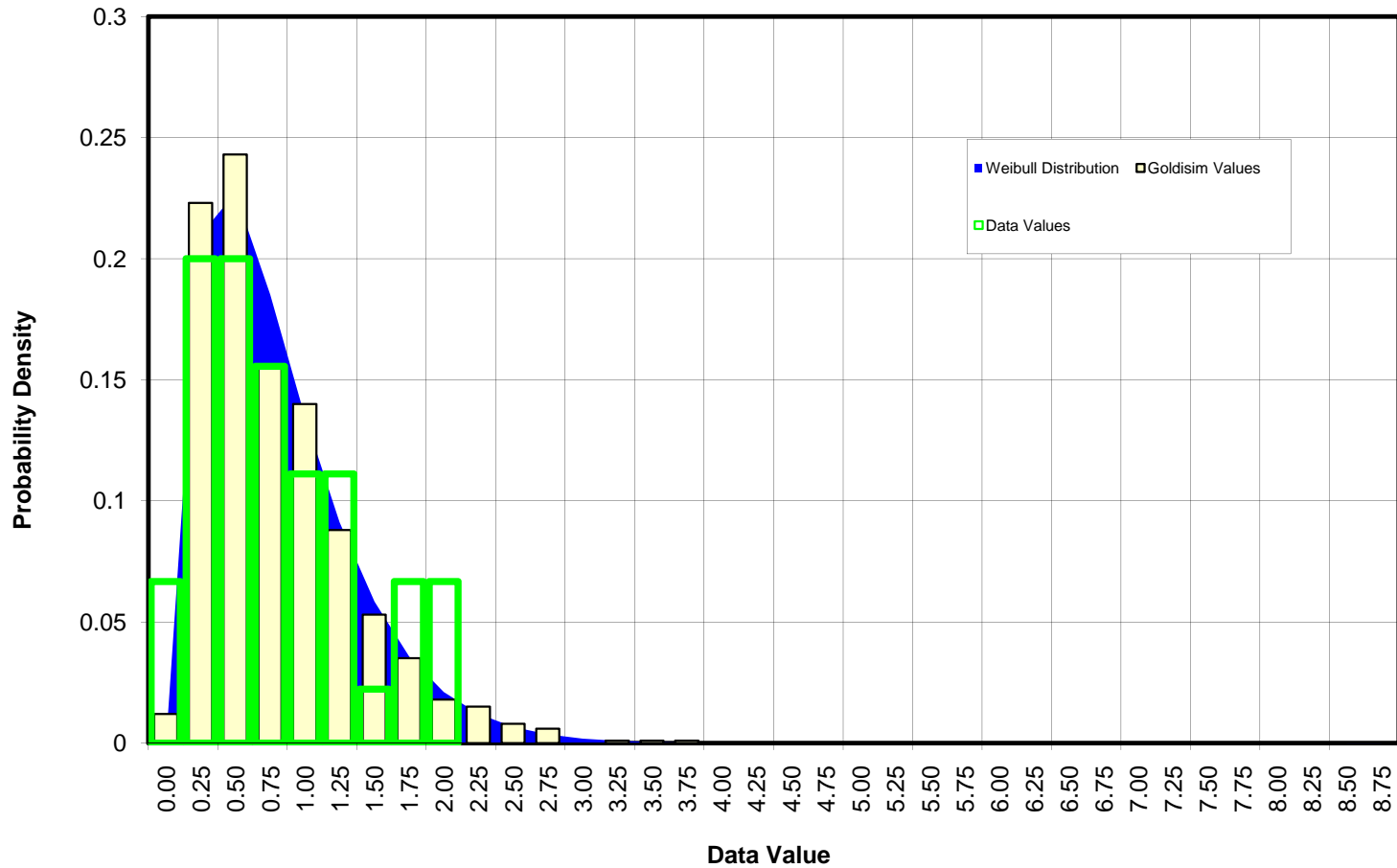

Denver, Colorado

TITLE
URAVAN DATA, GOLDSIM RESULTS AND WEIBULL DISTRIBUTION FOR FEBRUARY

CLIENT/PROJECT
**ENERGY FUELS RESOURCES CORPORATION
 PIÑON RIDGE PROJECT**

DRAWN **GG**
 CHECKED **DPH**
 REVIEWED **KFM**

DATE **Oct-08**
 SCALE **AS SHOWN**
 FILE NO. **Figures2-22_05May08.xls**

JOB NO. **073-81694**
 DWG. NO. **N/A**
 FIGURE NO. **FIGURE I-3**

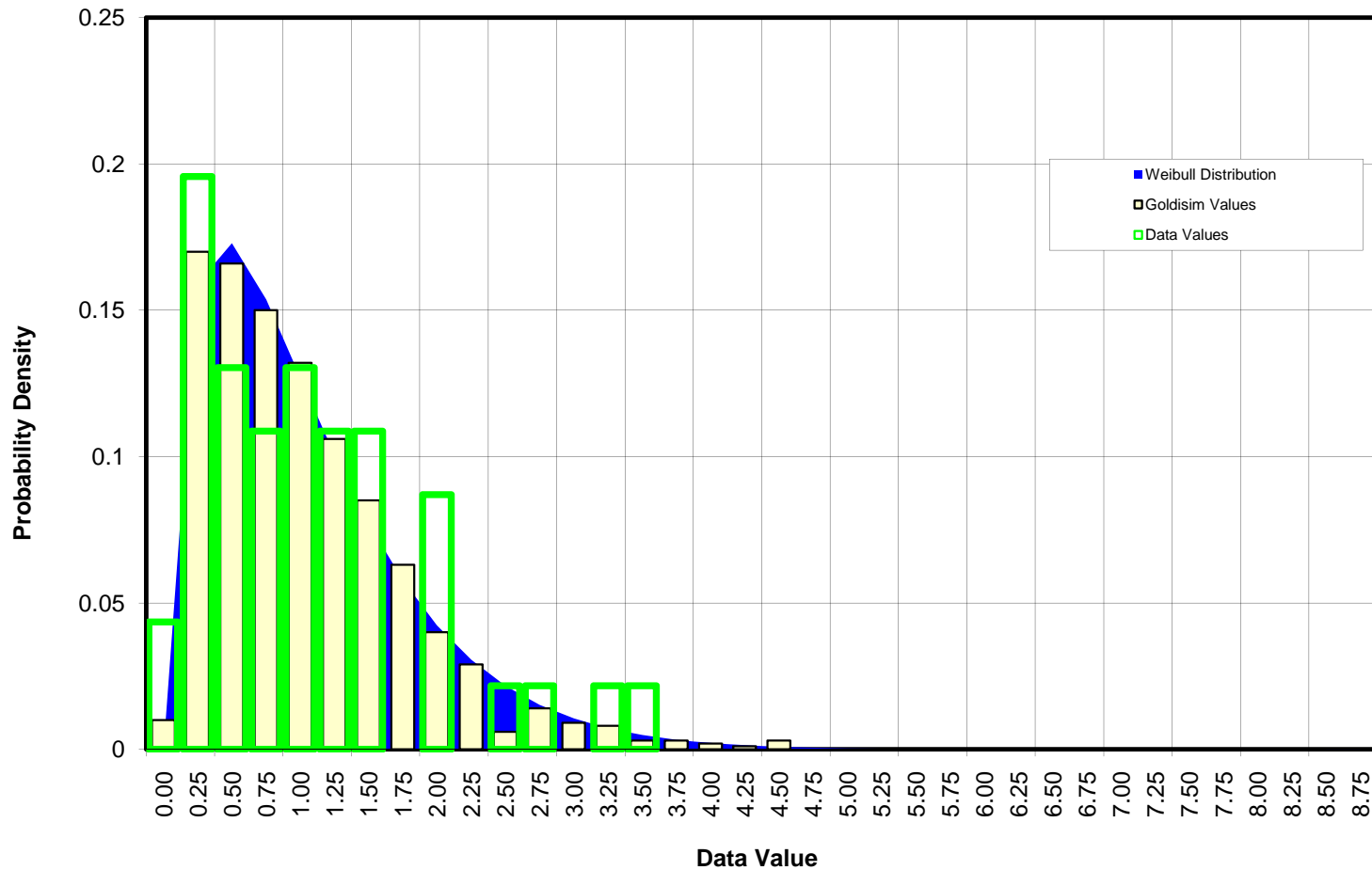

Denver, Colorado

TITLE
URAVAN DATA, GOLDSIM RESULTS AND WEIBULL DISTRIBUTION FOR MARCH

CLIENT/PROJECT
**ENERGY FUELS RESOURCES CORPORATION
 PIÑON RIDGE PROJECT**

DRAWN **GG**
 CHECKED **DPH**
 REVIEWED **KFM**

DATE **Oct-08**
 SCALE **AS SHOWN**
 FILE NO. **Figures2-22_05May08.xls**

JOB NO. **073-81694**
 DWG. NO. **N/A**
 FIGURE NO. **FIGURE I-4**

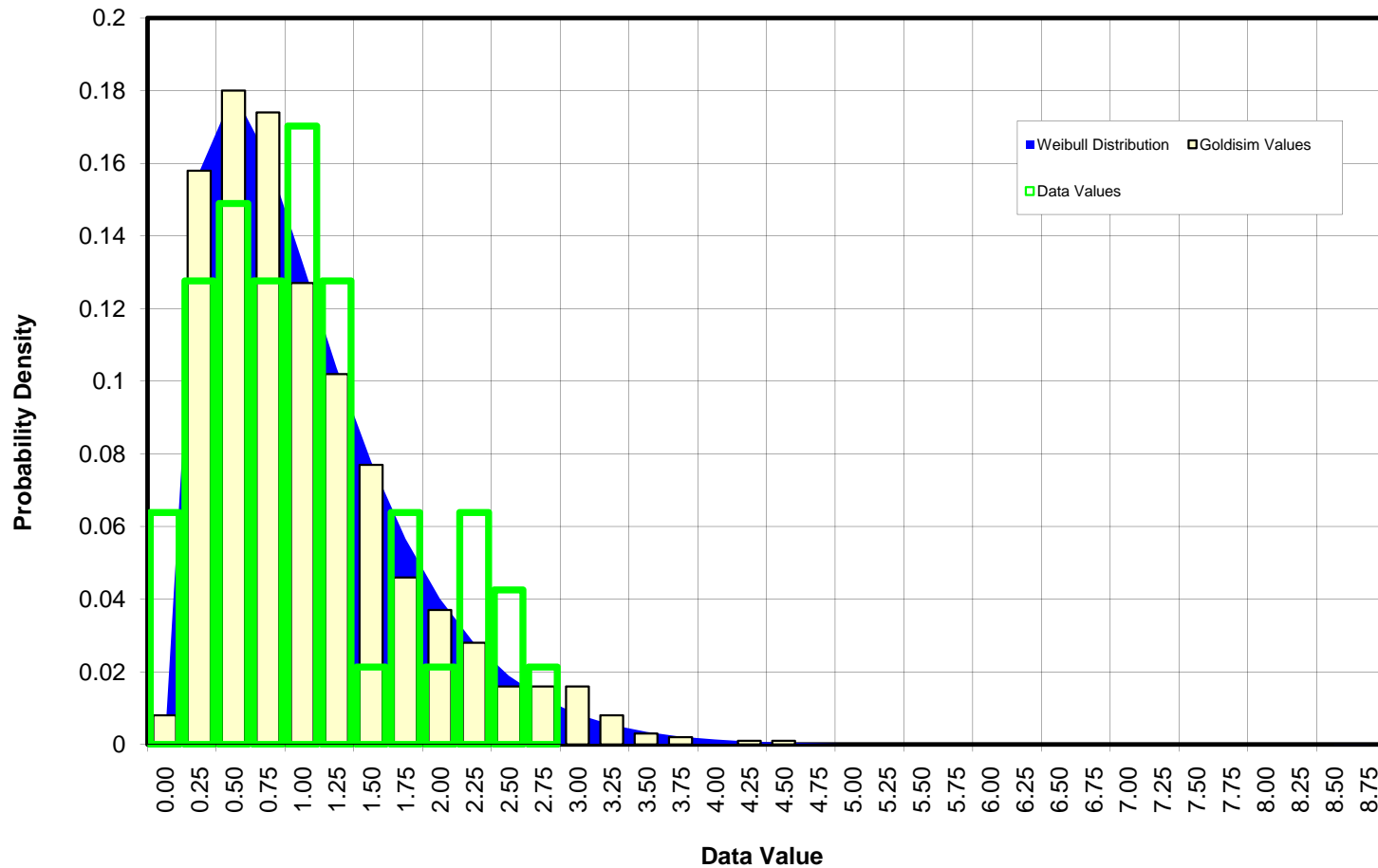

Denver, Colorado



TITLE
URAVAN DATA, GOLDSIM RESULTS AND WEIBULL DISTRIBUTION FOR APRIL

CLIENT/PROJECT
**ENERGY FUELS RESOURCES CORPORATION
 PIÑON RIDGE PROJECT**

DRAWN **GG**
 CHECKED **DPH**
 REVIEWED **KFM**

DATE **Oct-08**
 SCALE **AS SHOWN**
 FILE NO. **Figures2-22_05May08.xls**

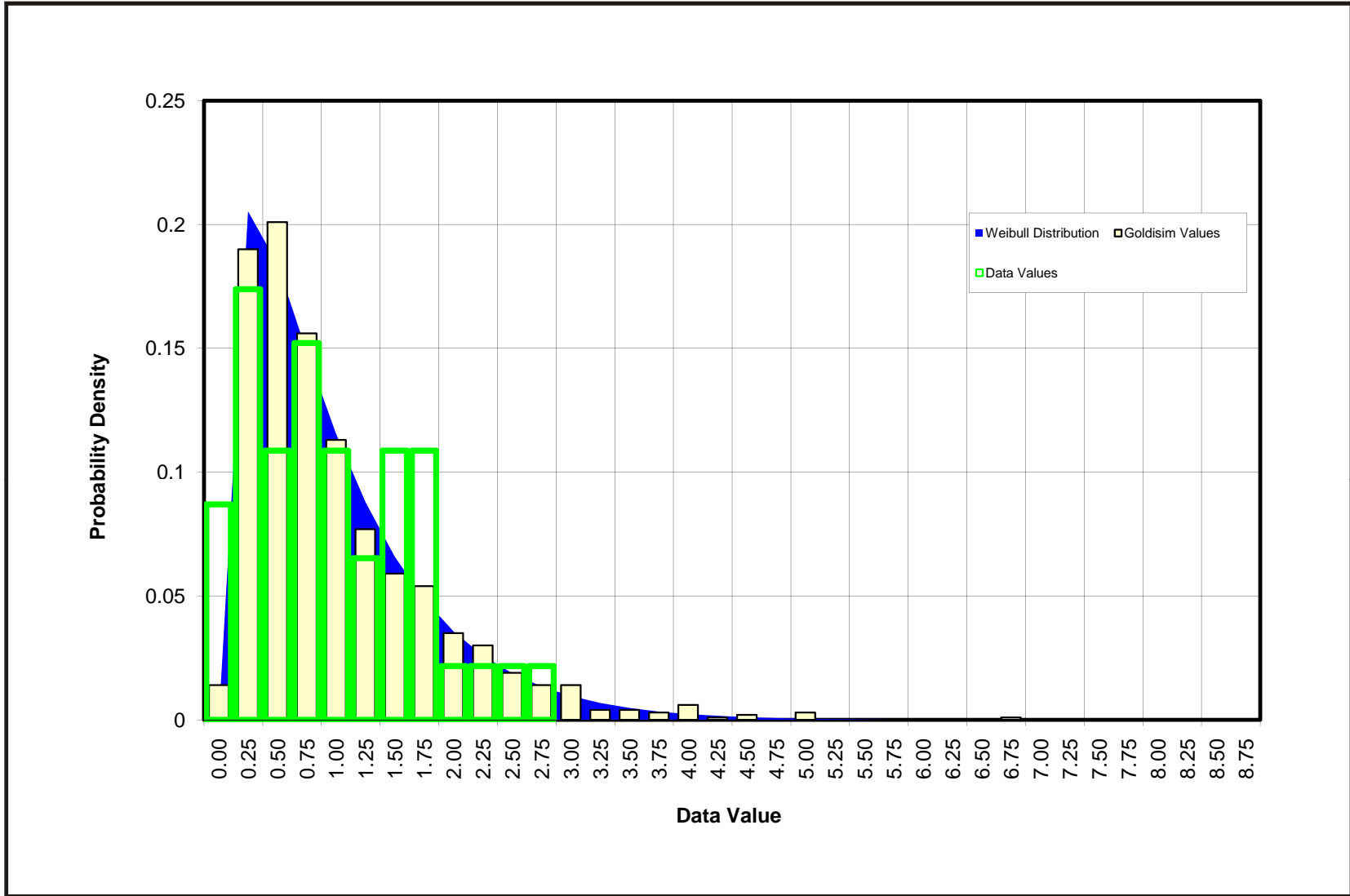
JOB NO. **073-81694**
 DWG. NO. **N/A**
 FIGURE NO. **FIGURE I-5**

Golder Associates
Denver, Colorado

CLIENT/PROJECT
**ENERGY FUELS RESOURCES CORPORATION
PIÑON RIDGE PROJECT**

TITLE URAVAN DATA, GOLDSIM RESULTS AND WEIBULL DISTRIBUTION FOR MAY			
DRAWN	GG	DATE	Oct-08
CHECKED	DPH	SCALE	AS SHOWN
REVIEWED	KFM	FILE NO.	Figures2-22_05May08.xls
		JOB NO.	073-81694
		DWG. NO.	N/A
		FIGURE NO.	FIGURE I-6

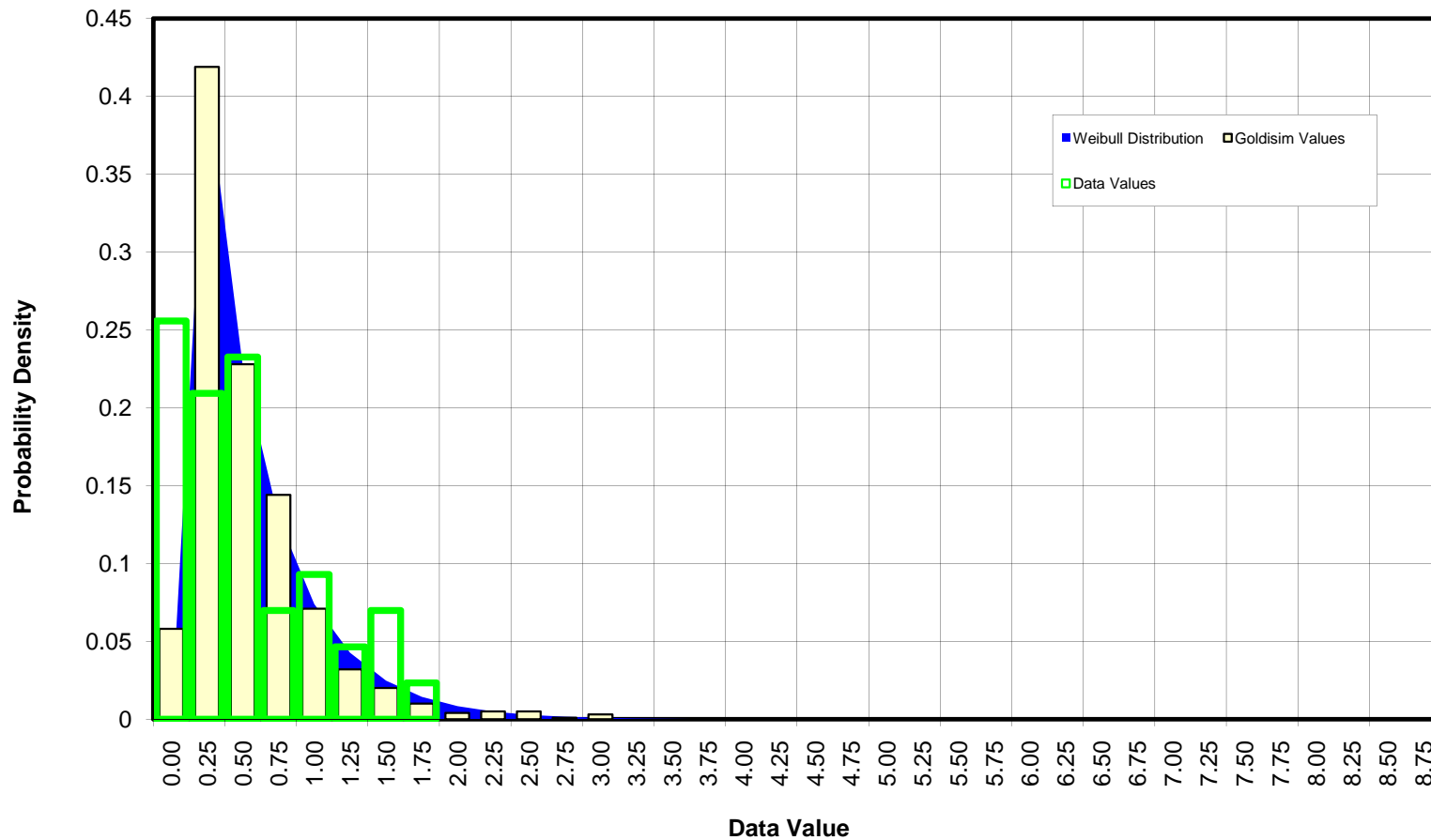

Denver, Colorado

TITLE

URAVAN DATA, GOLDSIM RESULTS AND WEIBULL DISTRIBUTION FOR JUNE

CLIENT/PROJECT

**ENERGY FUELS RESOURCES CORPORATION
PIÑON RIDGE PROJECT**

DRAWN

GG

DATE

Oct-08

JOB NO.

073-81694

CHECKED

DPH

SCALE

AS SHOWN

DWG. NO.

N/A

REVIEWED

KFM

FILE NO.

Figures2-22_05May08.xls

FIGURE NO.

FIGURE I-7

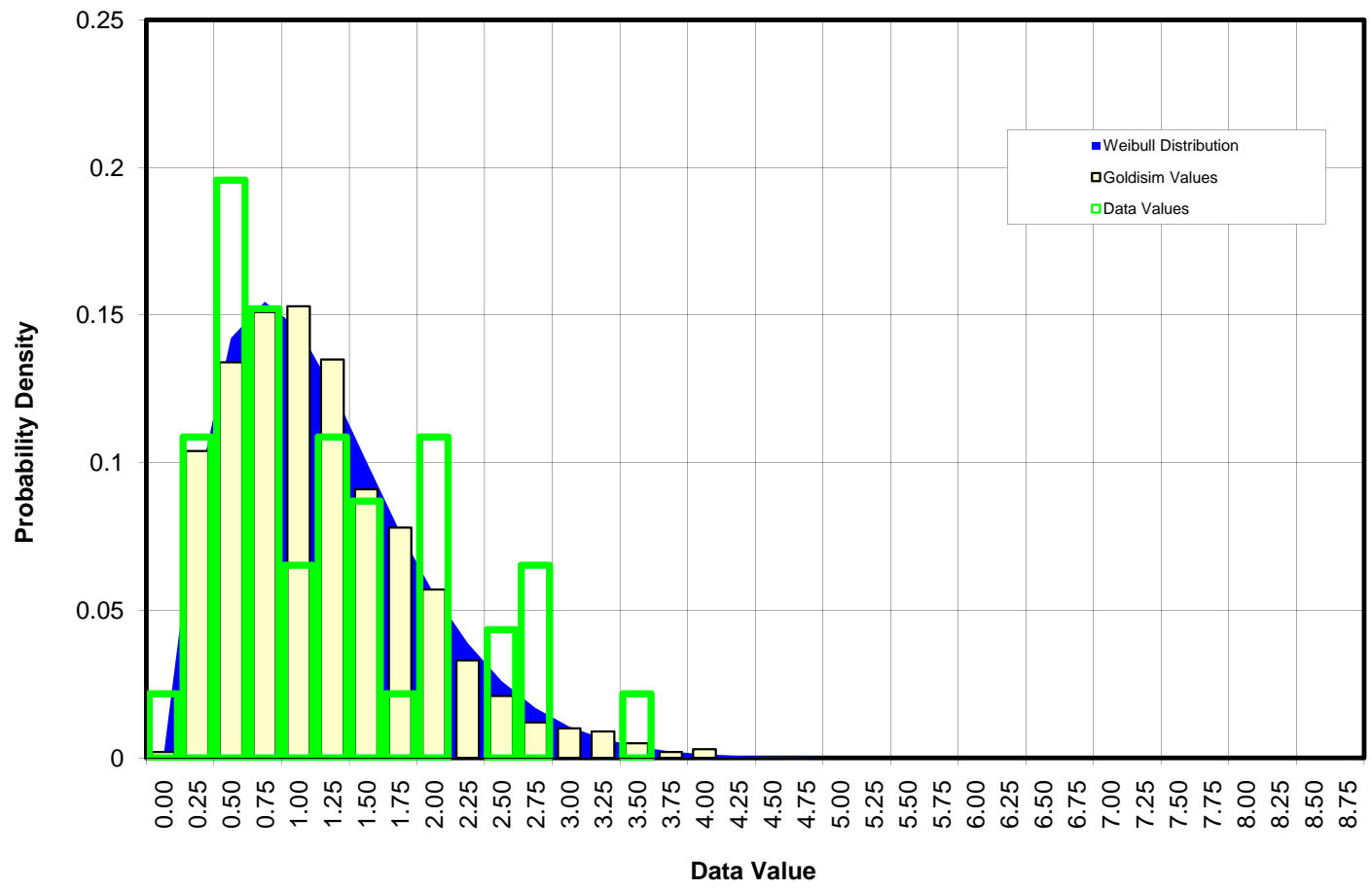

Denver, Colorado

TITLE
URAVAN DATA, GOLDSIM RESULTS AND WEIBULL DISTRIBUTION FOR JULY

CLIENT/PROJECT
**ENERGY FUELS RESOURCES CORPORATION
 PIÑON RIDGE PROJECT**

DRAWN **GG**
 CHECKED **DPH**
 REVIEWED **KFM**

DATE **Oct-08**
 SCALE **AS SHOWN**
 FILE NO. **Figures2-22_05May08.xls**

JOB NO. **073-81694**
 DWG. NO. **N/A**
 FIGURE NO. **FIGURE I-8**

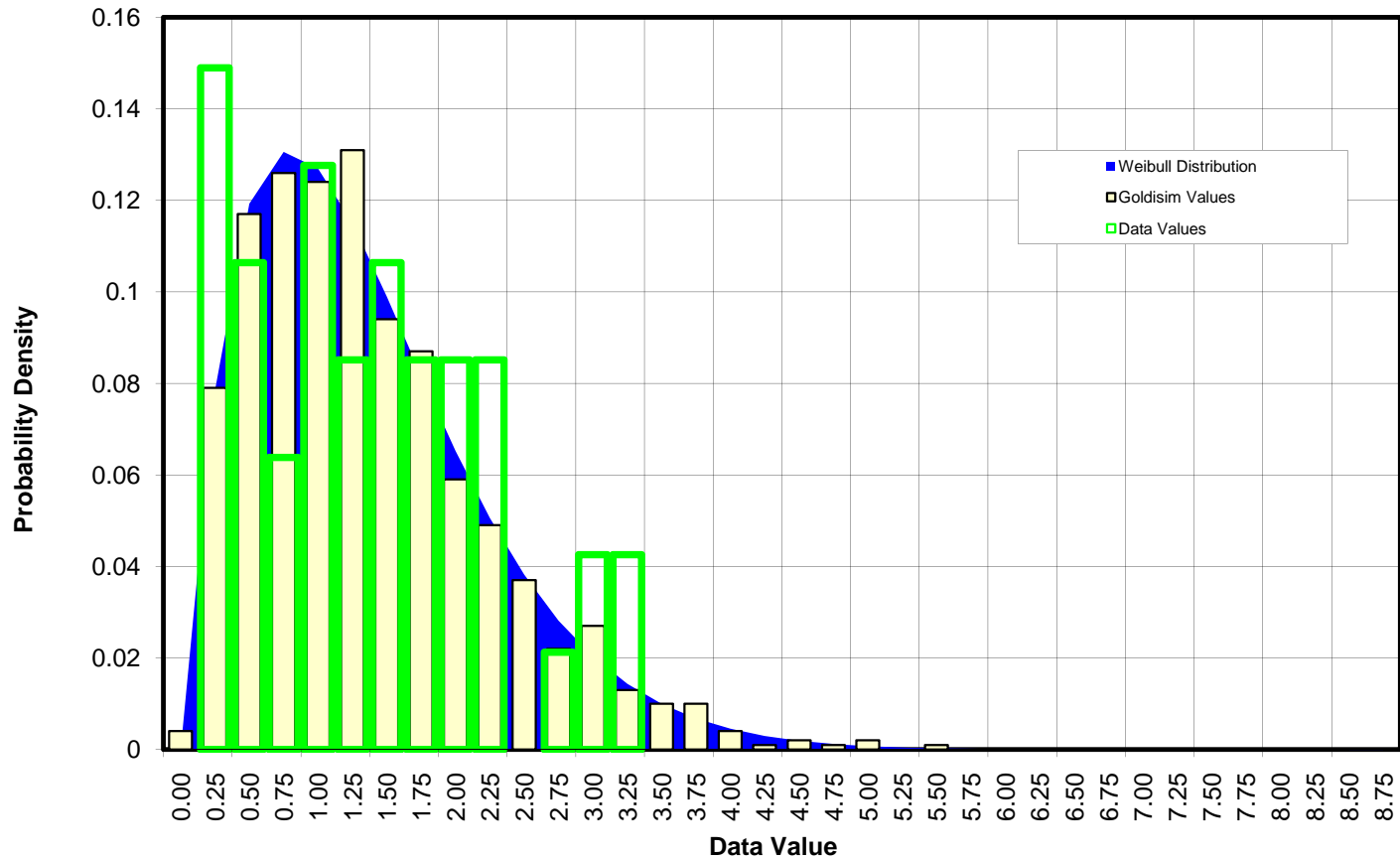

Denver, Colorado

TITLE
URAVAN DATA, GOLDSIM RESULTS AND WEIBULL DISTRIBUTION FOR AUGUST

CLIENT/PROJECT
**ENERGY FUELS RESOURCES CORPORATION
 PIÑON RIDGE PROJECT**

DRAWN **GG**
 CHECKED **DPH**
 REVIEWED **KFM**

DATE **Oct-08**
 SCALE **AS SHOWN**
 FILE NO. **Figures2-22_05May08.xls**

JOB NO. **073-81694**
 DWG. NO. **N/A**
 FIGURE NO. **FIGURE I-9**

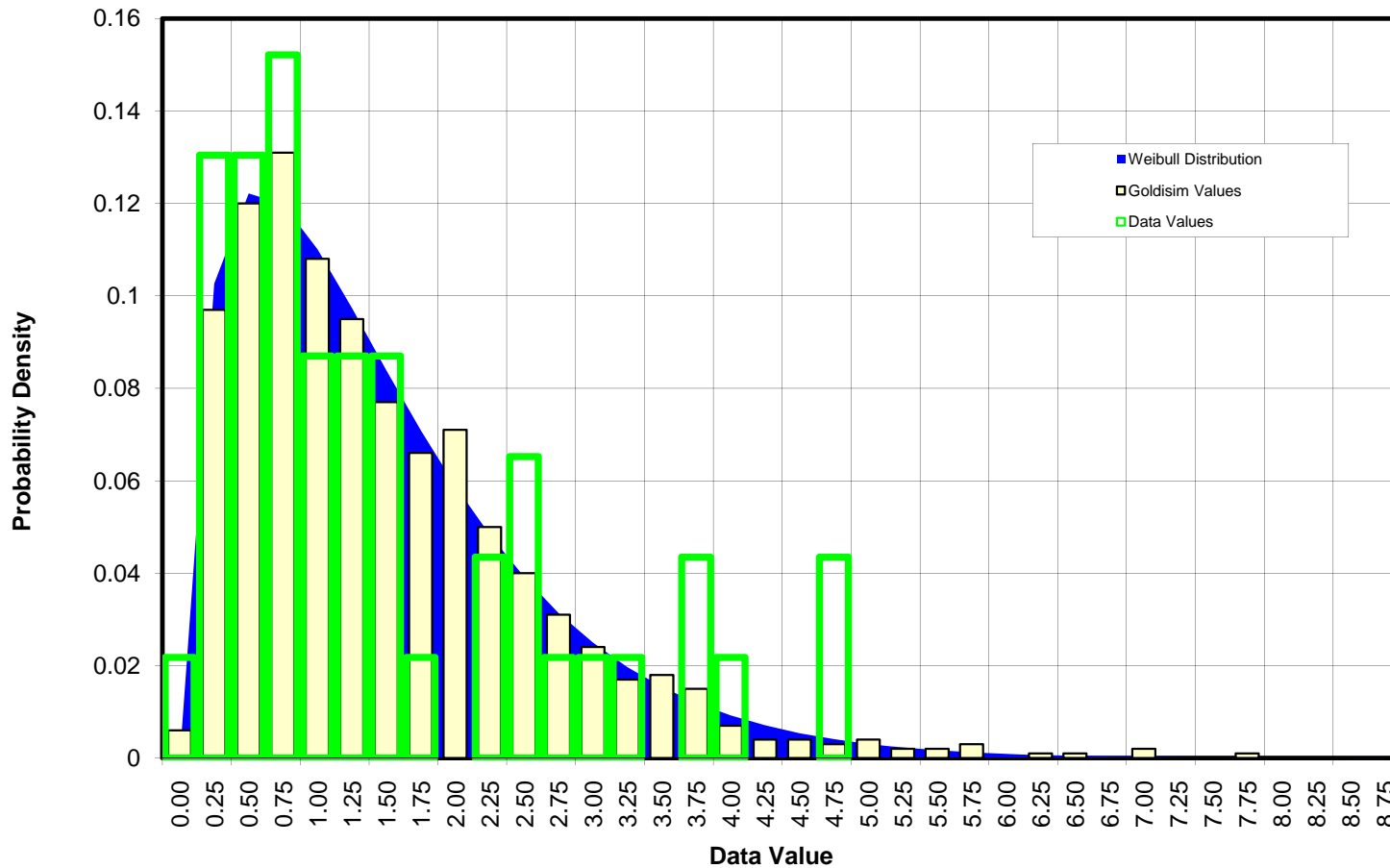

Denver, Colorado

TITLE
URAVAN DATA, GOLDSIM RESULTS AND WEIBULL DISTRIBUTION FOR SEPTEMBER

CLIENT/PROJECT
**ENERGY FUELS RESOURCES CORPORATION
 PIÑON RIDGE PROJECT**

DRAWN **GG**
 CHECKED **DPH**
 REVIEWED **KFM**

DATE **Oct-08**
 SCALE **AS SHOWN**
 FILE NO. **Figures2-22_05May08.xls**

JOB NO. **073-81694**
 DWG. NO. **N/A**
 FIGURE NO. **FIGURE I-10**

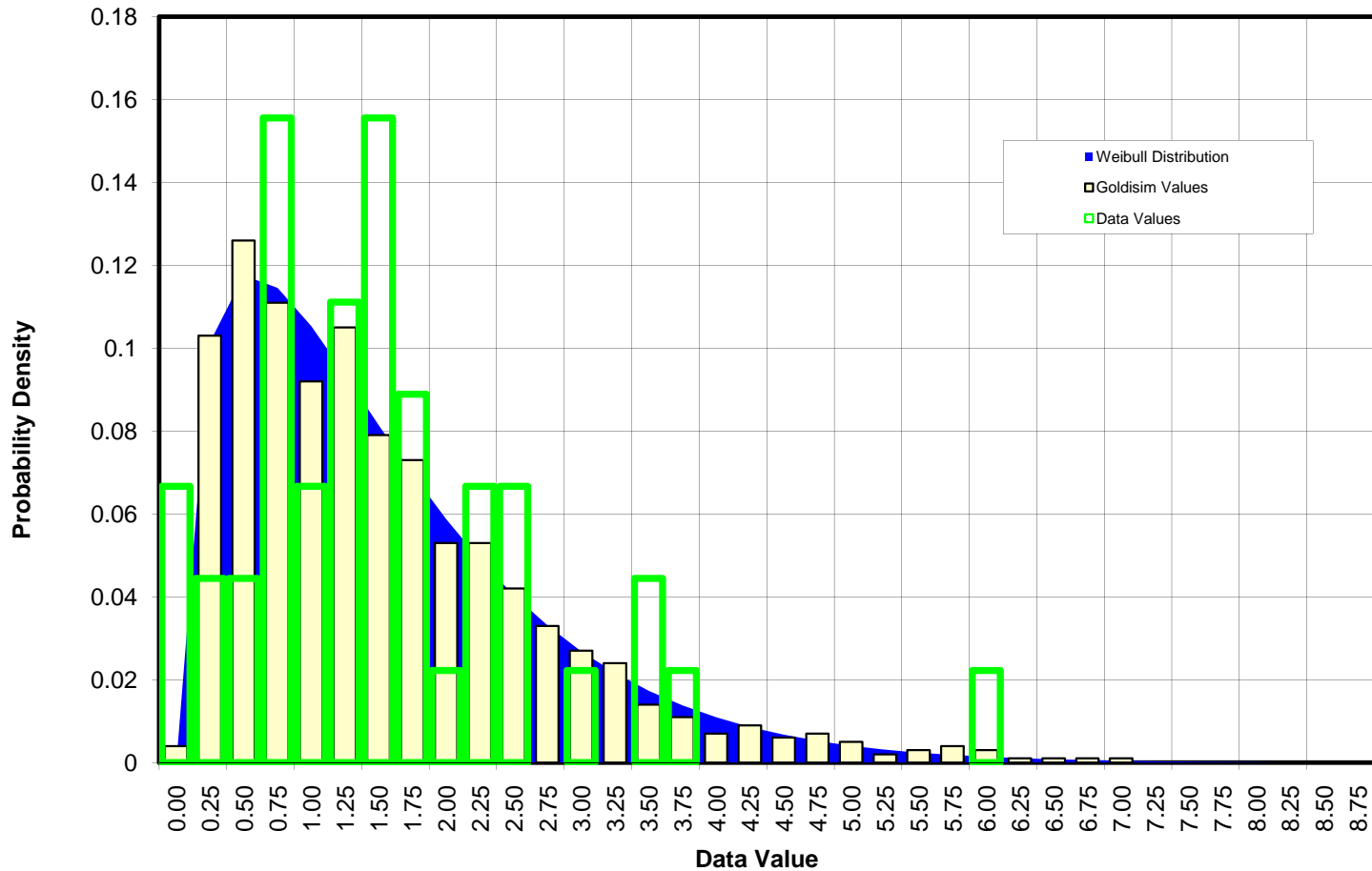

Denver, Colorado

TITLE
URAVAN DATA, GOLDSIM RESULTS AND WEIBULL DISTRIBUTION FOR OCTOBER

CLIENT/PROJECT
**ENERGY FUELS RESOURCES CORPORATION
 PIÑON RIDGE PROJECT**

DRAWN **GG**
 CHECKED **DPH**
 REVIEWED **KFM**

DATE **Oct-08**
 SCALE **AS SHOWN**
 FILE NO. **Figures2-22_05May08.xls**

JOB NO. **073-81694**
 DWG. NO. **N/A**
 FIGURE NO. **FIGURE I-11**

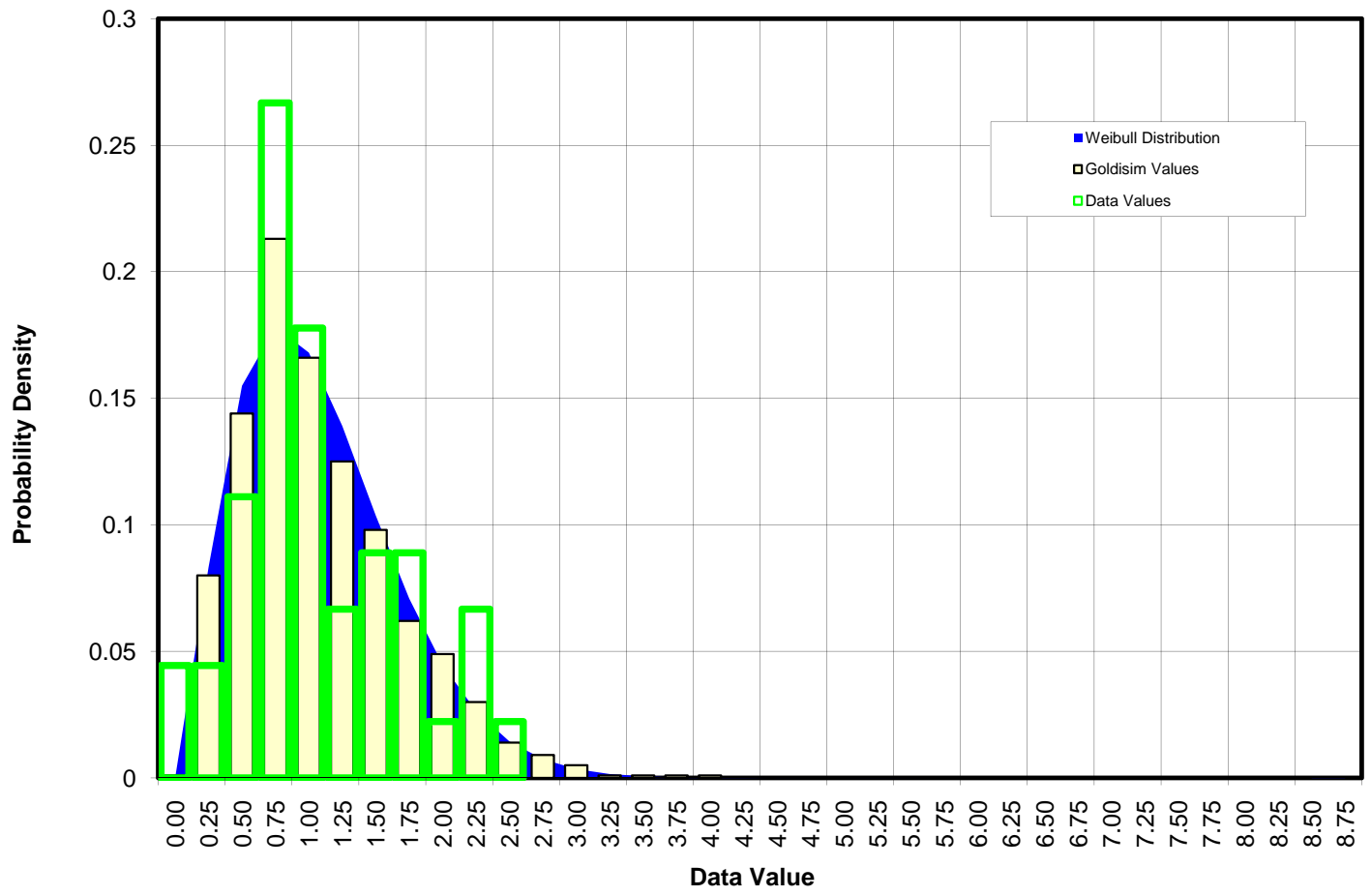

Denver, Colorado

TITLE
URAVAN DATA, GOLDSIM RESULTS AND WEIBULL DISTRIBUTION FOR NOVEMBER

CLIENT/PROJECT
**ENERGY FUELS RESOURCES CORPORATION
 PIÑON RIDGE PROJECT**

DRAWN **GG**
 CHECKED **DPH**
 REVIEWED **KFM**

DATE **Oct-08**
 SCALE **AS SHOWN**
 FILE NO. **Figures2-22_05May08.xls**

JOB NO. **073-81694**
 DWG. NO. **N/A**
 FIGURE NO. **FIGURE I-12**

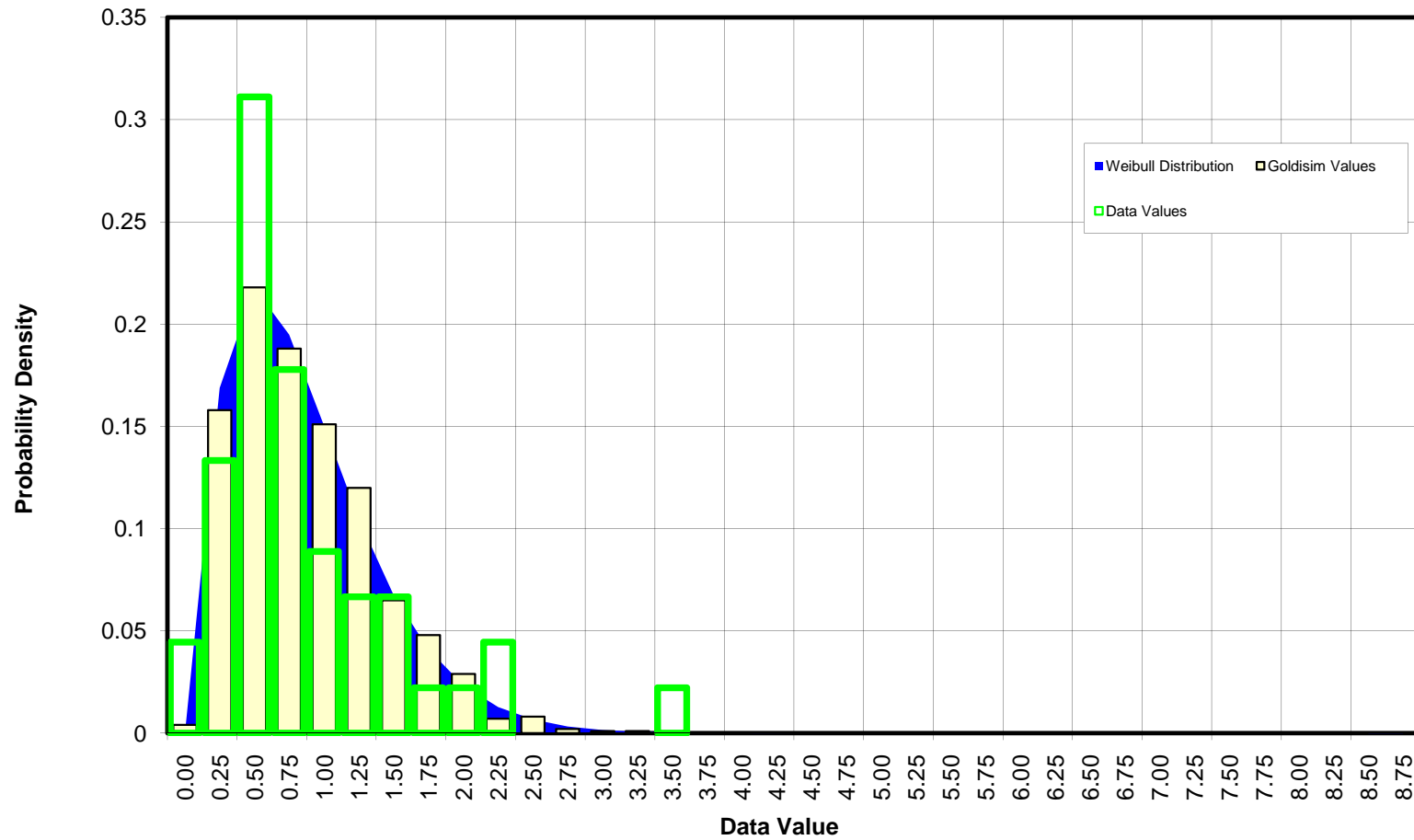

Denver, Colorado

TITLE

URAVAN DATA, GOLDSIM RESULTS AND WEIBULL DISTRIBUTION FOR DECEMBER

CLIENT/PROJECT

**ENERGY FUELS RESOURCES CORPORATION
PIÑON RIDGE PROJECT**

DRAWN

GG

DATE

Oct-08

JOB NO.

073-81694

CHECKED

DPH

SCALE

AS SHOWN

DWG. NO.

N/A

REVIEWED

KFM

FILE NO.

Figures2-22_05May08.xls

FIGURE NO.

FIGURE I-13

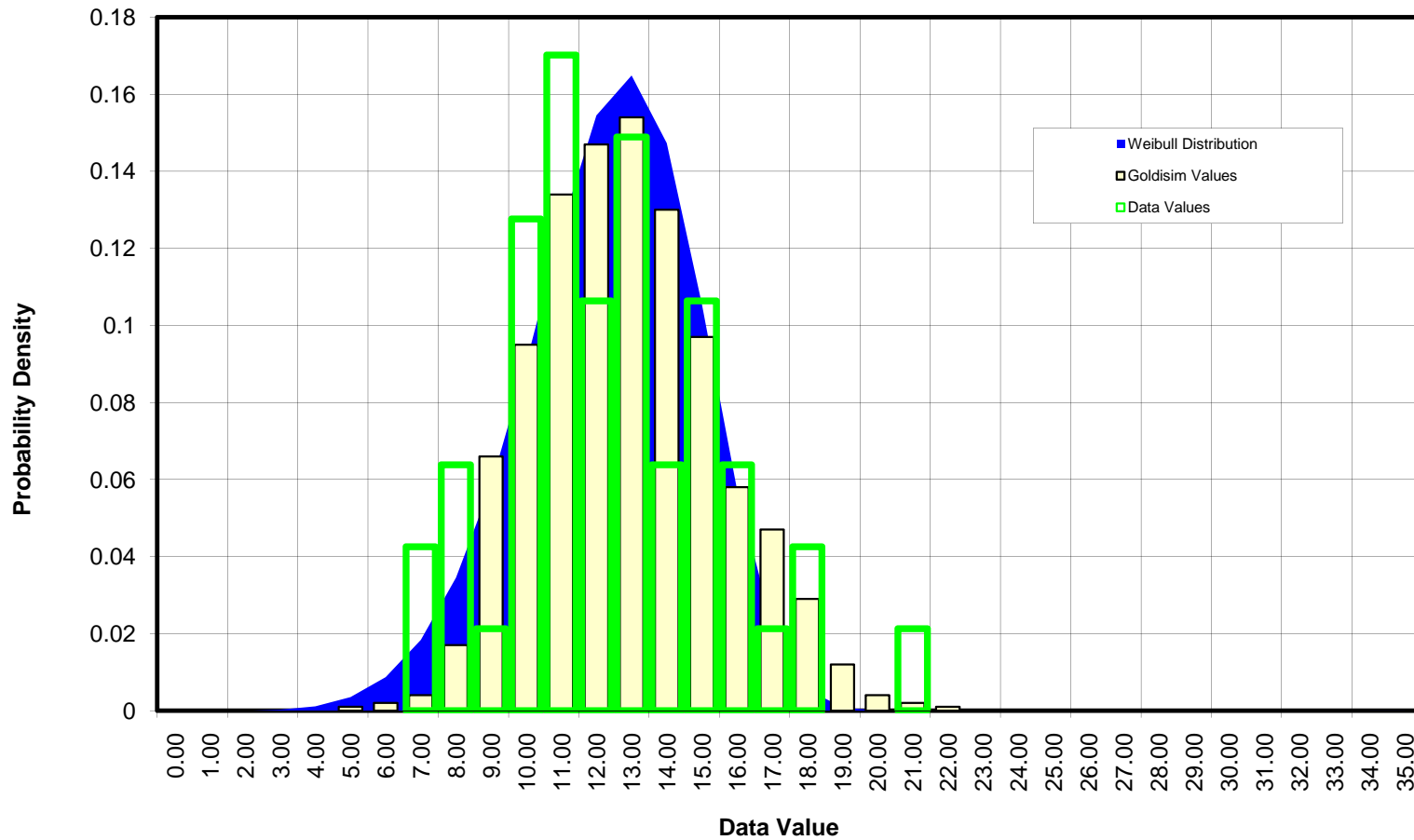

Denver, Colorado

TITLE
URAVAN DATA, GOLDSIM RESULTS AND WEIBULL DISTRIBUTION FOR ANNUAL PRECIPITATION

CLIENT/PROJECT
**ENERGY FUELS RESOURCES CORPORATION
 PIÑON RIDGE PROJECT**

DRAWN **GG**
 CHECKED **DPH**
 REVIEWED **KFM**

DATE **Oct-08**
 SCALE **AS SHOWN**
 FILE NO. **Figures2-22_05May08.xls**

JOB NO. **073-81694**
 DWG. NO. **N/A**
 FIGURE NO. **FIGURE I-14**

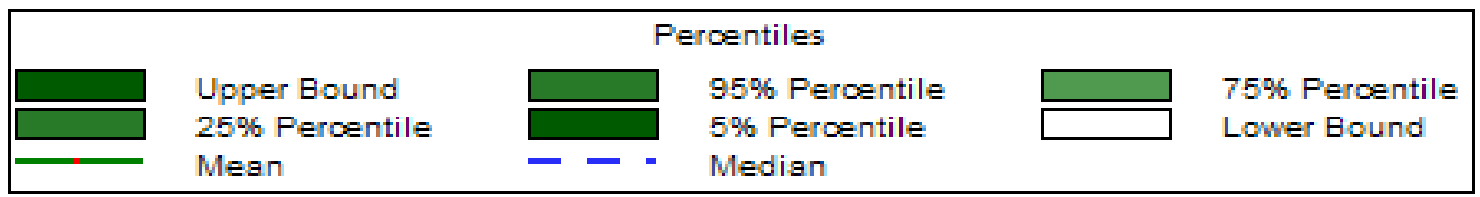
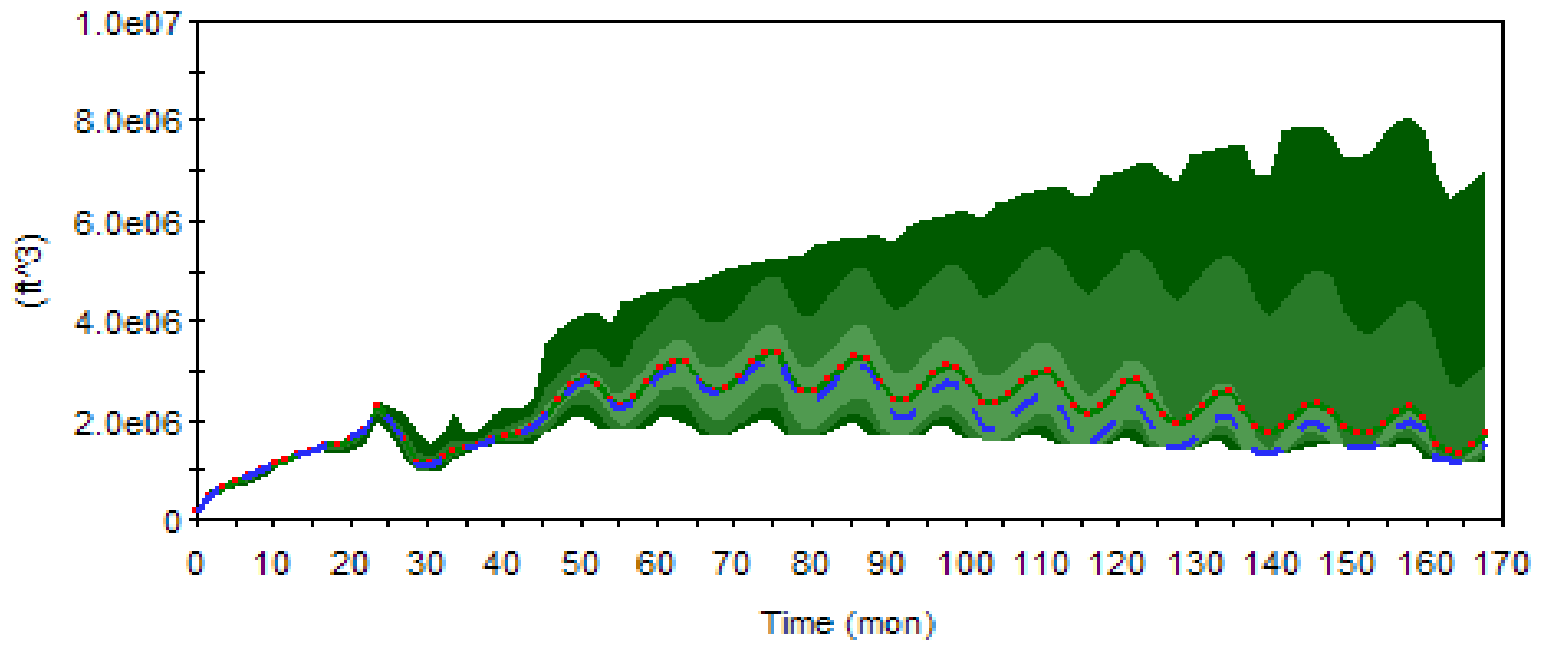

Denver, Colorado

TITLE

TAILINGS CELL POOL VOLUME FOR 500-TPD MILLING RATE

CLIENT/PROJECT
**ENERGY FUELS RESOURCES CORPORATION
 PIÑON RIDGE PROJECT**

DRAWN **GIA**
 CHECKED **GG**
 REVIEWED **DPH**

DATE **Oct-08**
 SCALE **AS SHOWN**
 FILE NO. **Figures2-22_05May08.xls**

JOB NO. **073-81694**
 DWG. NO. **N/A**
 FIGURE NO. **FIGURE I-15**

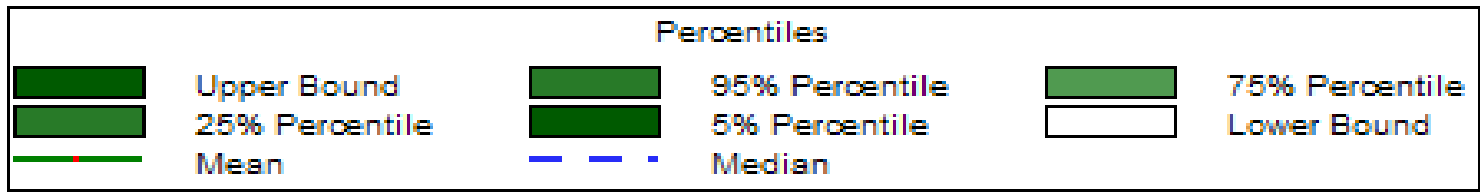
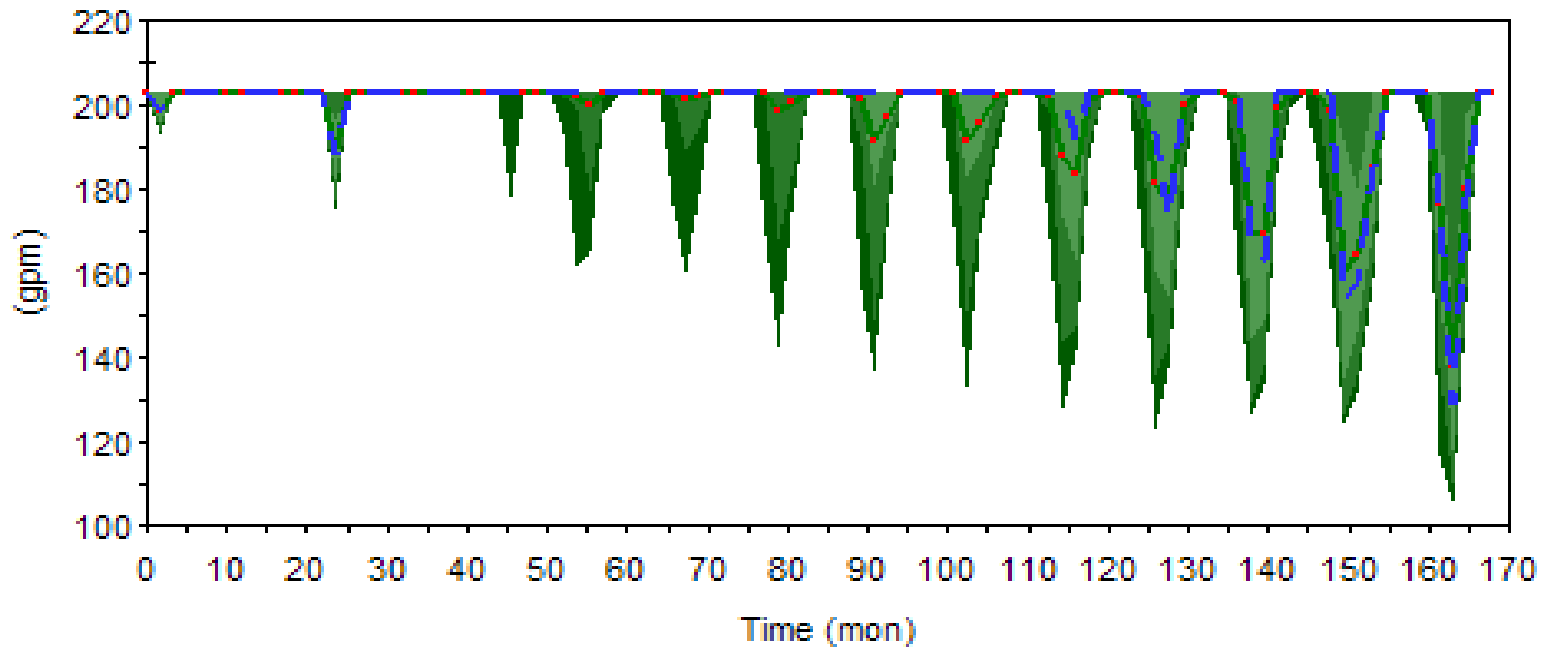

Denver, Colorado

TITLE

PUMPING RATE AVAILABLE TO RETURN RECLAIMED WATER TO MILL FOR 500-TPD MILLING RATE

CLIENT/PROJECT
**ENERGY FUELS RESOURCES CORPORATION
 PIÑON RIDGE PROJECT**

DRAWN **GIA**
 CHECKED **GG**
 REVIEWED **DPH**

DATE **Oct-08**
 SCALE **AS SHOWN**
 FILE NO. **Figures2-22_05May08.xls**

JOB NO. **073-81694**
 DWG. NO. **N/A**
 FIGURE NO. **FIGURE I-16**

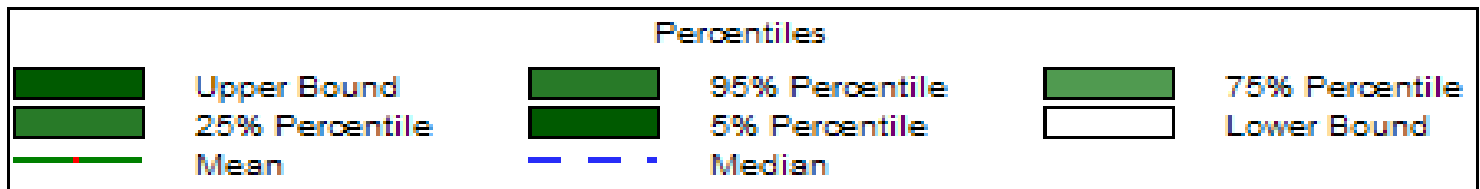
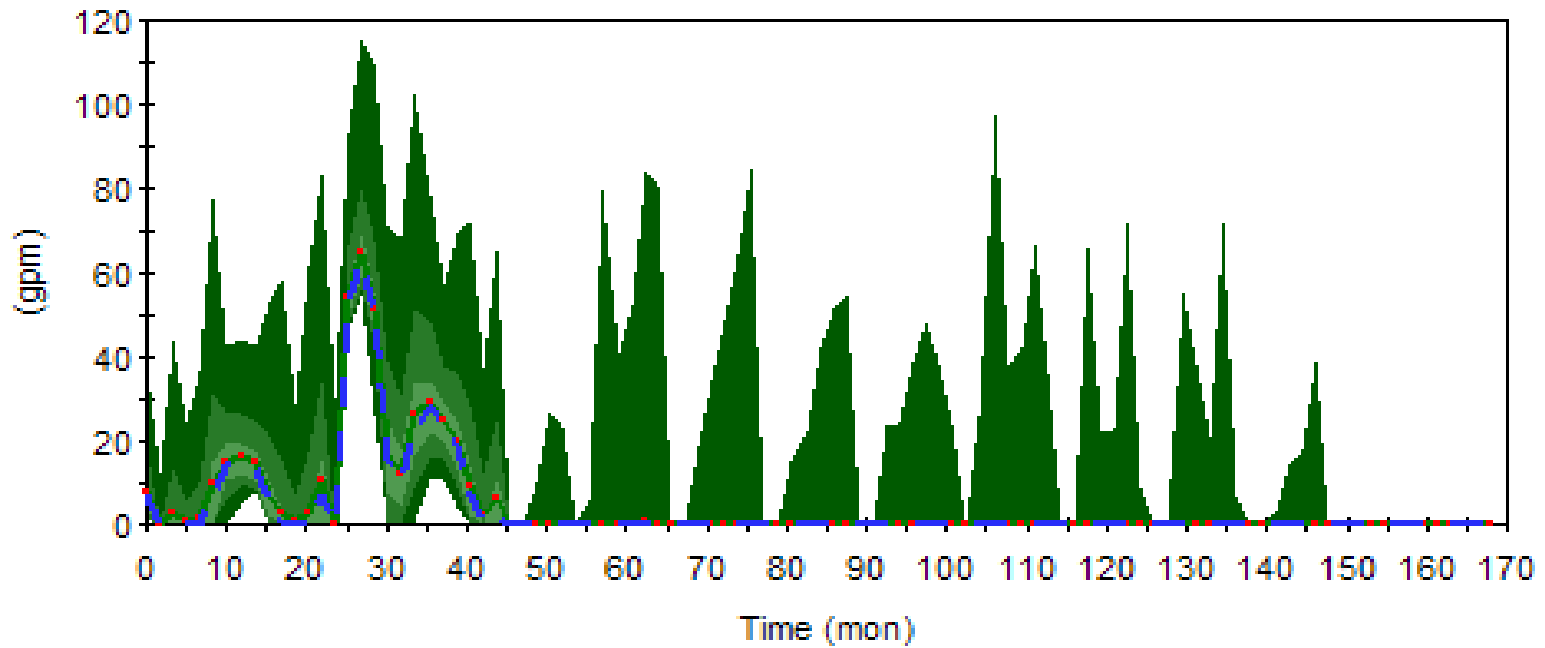

Denver, Colorado

TITLE

AVAILABLE EXCESS PUMPING RATE FOR 500-TPD MILLING RATE

CLIENT/PROJECT
**ENERGY FUELS RESOURCES CORPORATION
 PIÑON RIDGE PROJECT**

DRAWN **GIA**
 CHECKED **GG**
 REVIEWED **DPH**

DATE **Oct-08**
 SCALE **AS SHOWN**
 FILE NO. **Figures2-22_05May08.xls**

JOB NO. **073-81694**
 DWG. NO. **N/A**
 FIGURE NO. **FIGURE I-17**

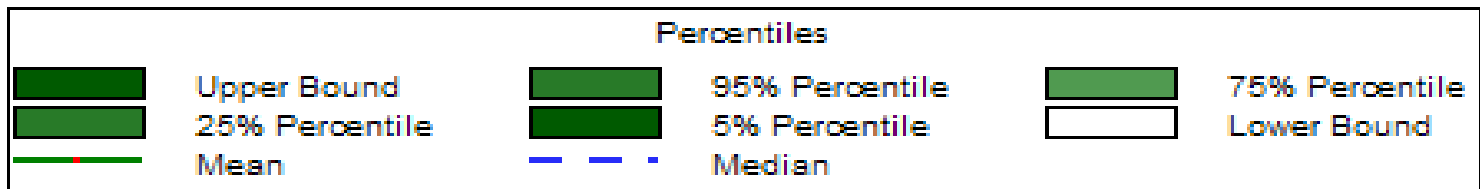
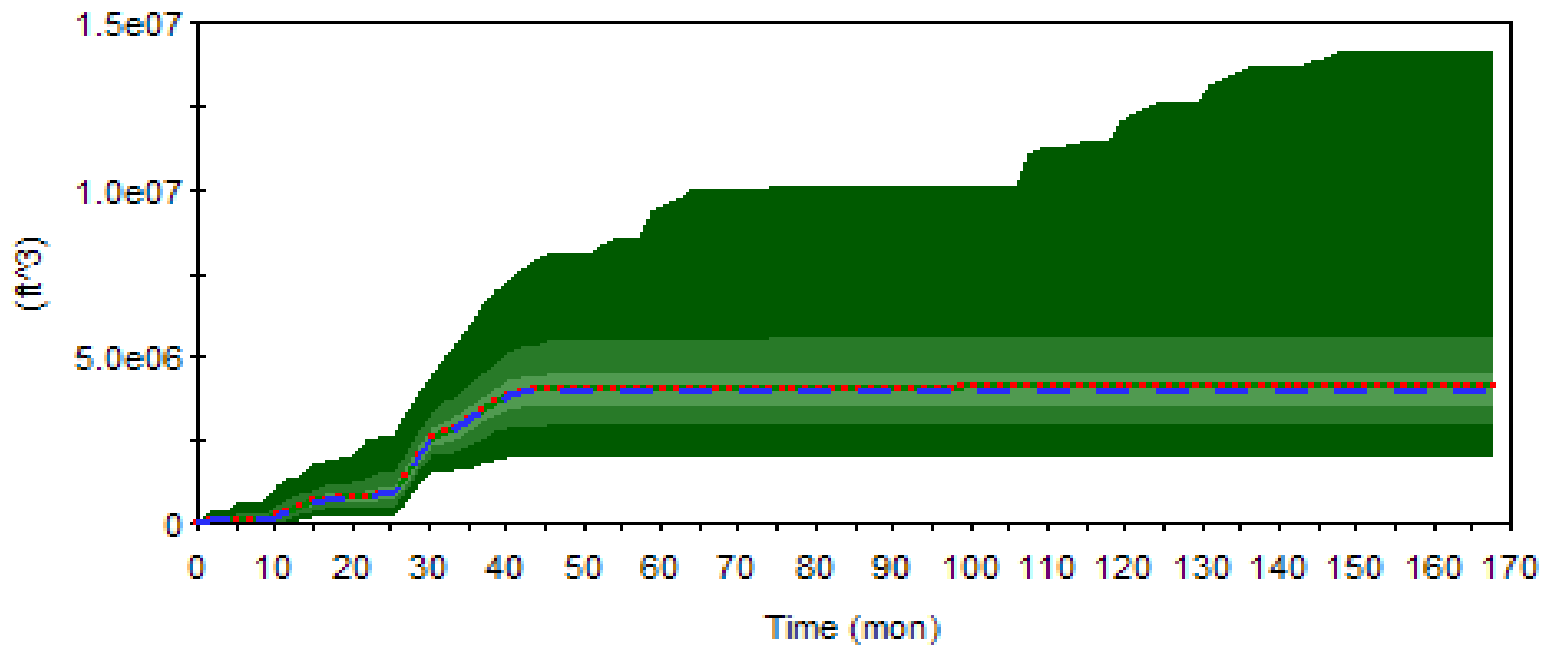

Denver, Colorado

TITLE

**AVAILABLE EXCESS MAKE-UP WATER VOLUME
FOR 500-TPD MILLING RATE**

CLIENT/PROJECT
**ENERGY FUELS RESOURCES CORPORATION
PIÑON RIDGE PROJECT**

DRAWN **GIA**
CHECKED **GG**
REVIEWED **DPH**

DATE **Oct-08**
SCALE **AS SHOWN**
FILE NO. **Figures2-22_05May08.xls**

JOB NO. **073-81694**
DWG. NO. **N/A**
FIGURE NO. **FIGURE I-18**

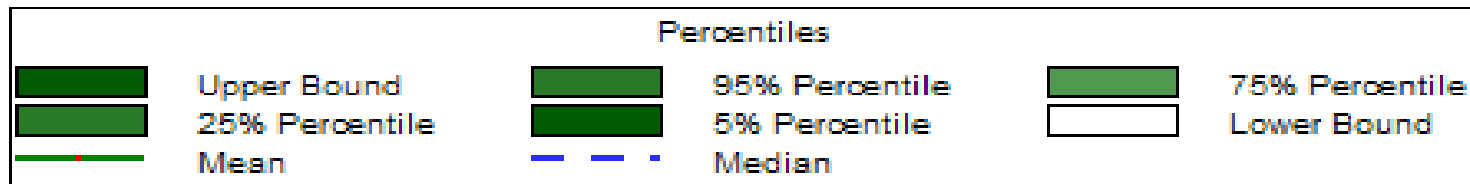
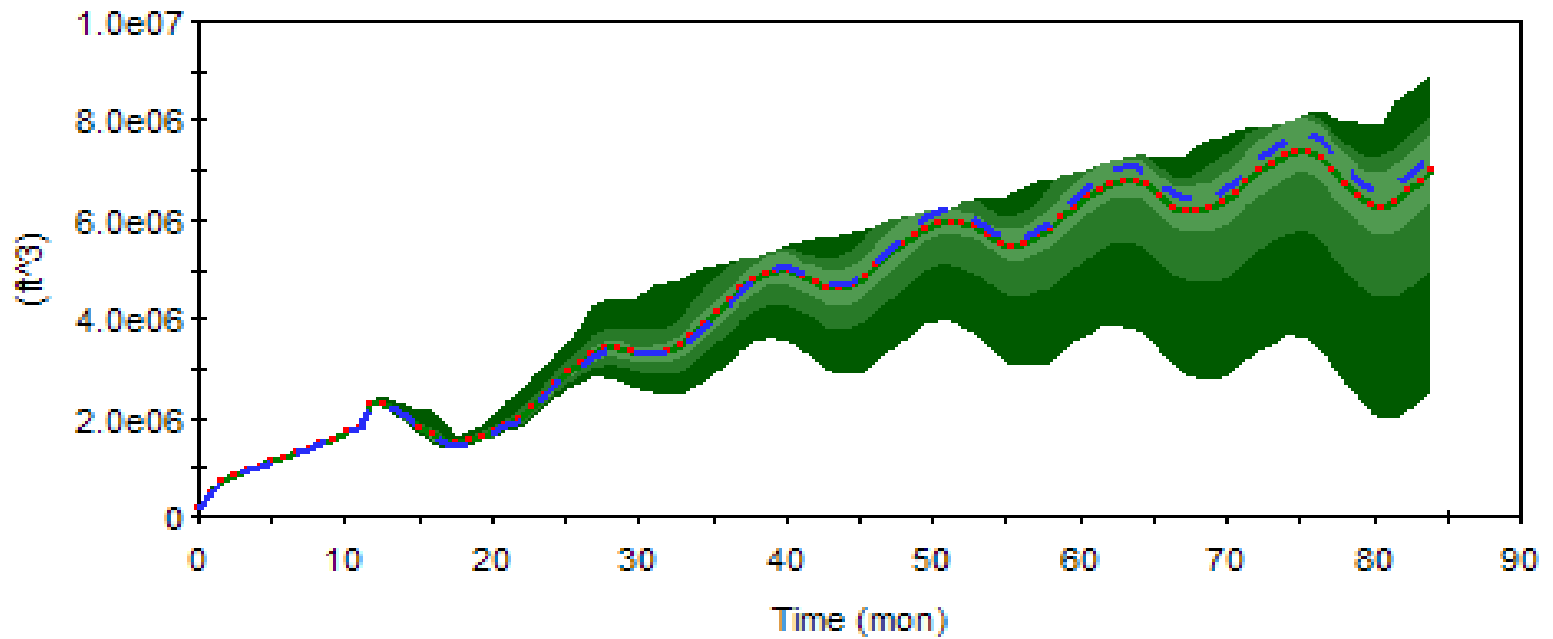

Denver, Colorado

TITLE

TAILINGS CELL POOL VOLUME FOR 1,000-TPD MILLING RATE

CLIENT/PROJECT
**ENERGY FUELS RESOURCES CORPORATION
 PIÑON RIDGE PROJECT**

DRAWN **GIA**
 CHECKED **GG**
 REVIEWED **DPH**

DATE **Oct-08**
 SCALE **AS SHOWN**
 FILE NO. **Figures2-22_05May08.xls**

JOB NO. **073-81694**
 DWG. NO. **N/A**
 FIGURE NO. **FIGURE I-19**

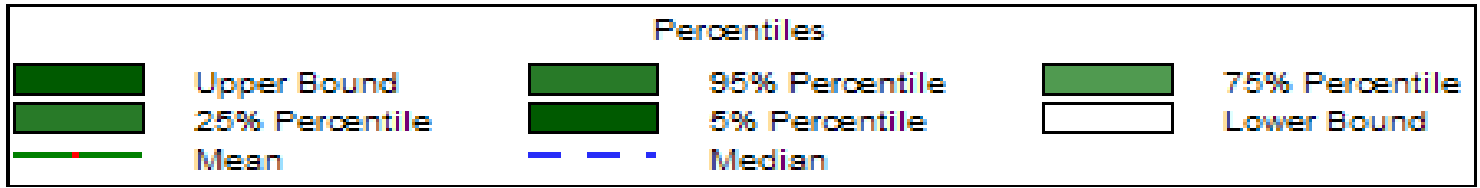
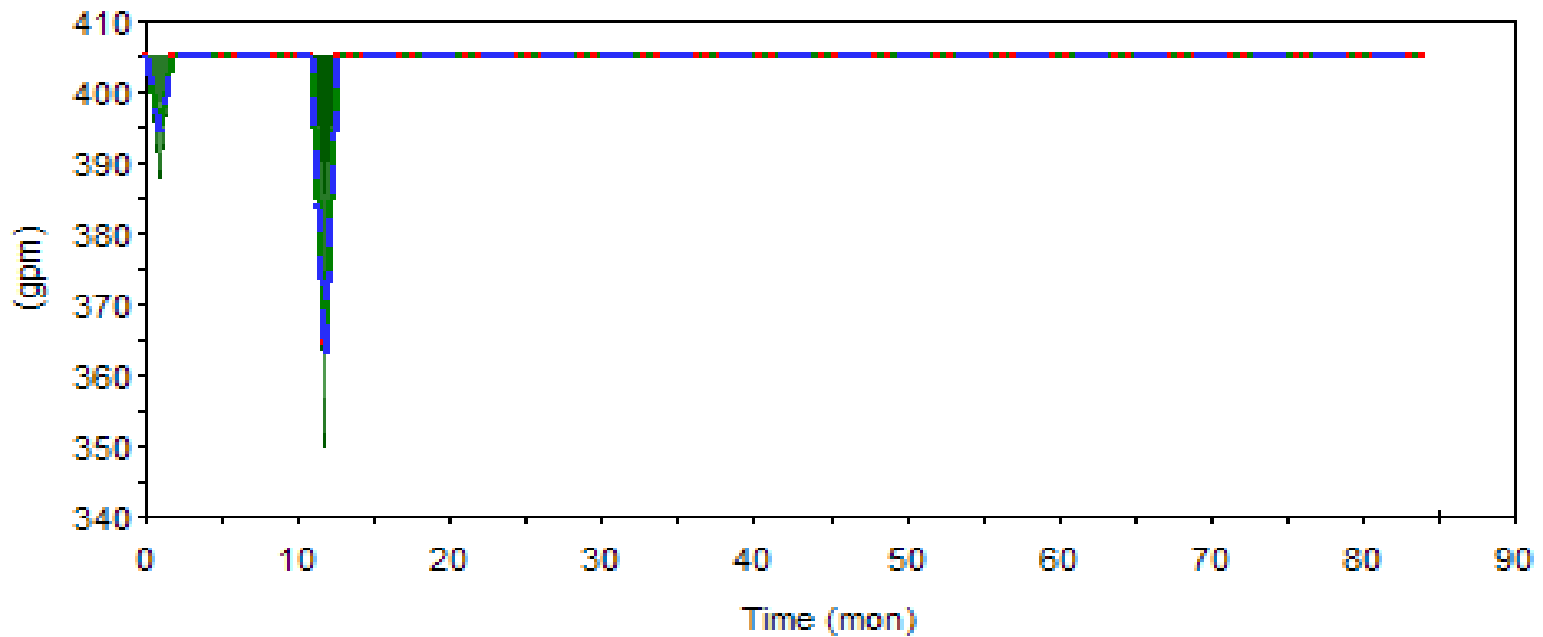

Denver, Colorado

TITLE
**PUMPING RATE AVAILABLE TO RETURN RECLAIMED WATER
 TO MILL FOR 1,000-TPD MILLING RATE**

CLIENT/PROJECT
**ENERGY FUELS RESOURCES CORPORATION
 PIÑON RIDGE PROJECT**

DRAWN **GIA**
 CHECKED **GG**
 REVIEWED **DPH**

DATE **Oct-08**
 SCALE **AS SHOWN**
 FILE NO. **Figures2-22_05May08.xls**

JOB NO. **073-81694**
 DWG. NO. **N/A**
 FIGURE NO. **FIGURE I-20**

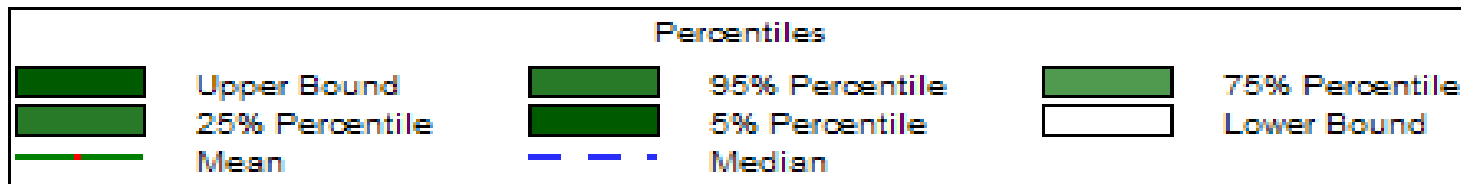
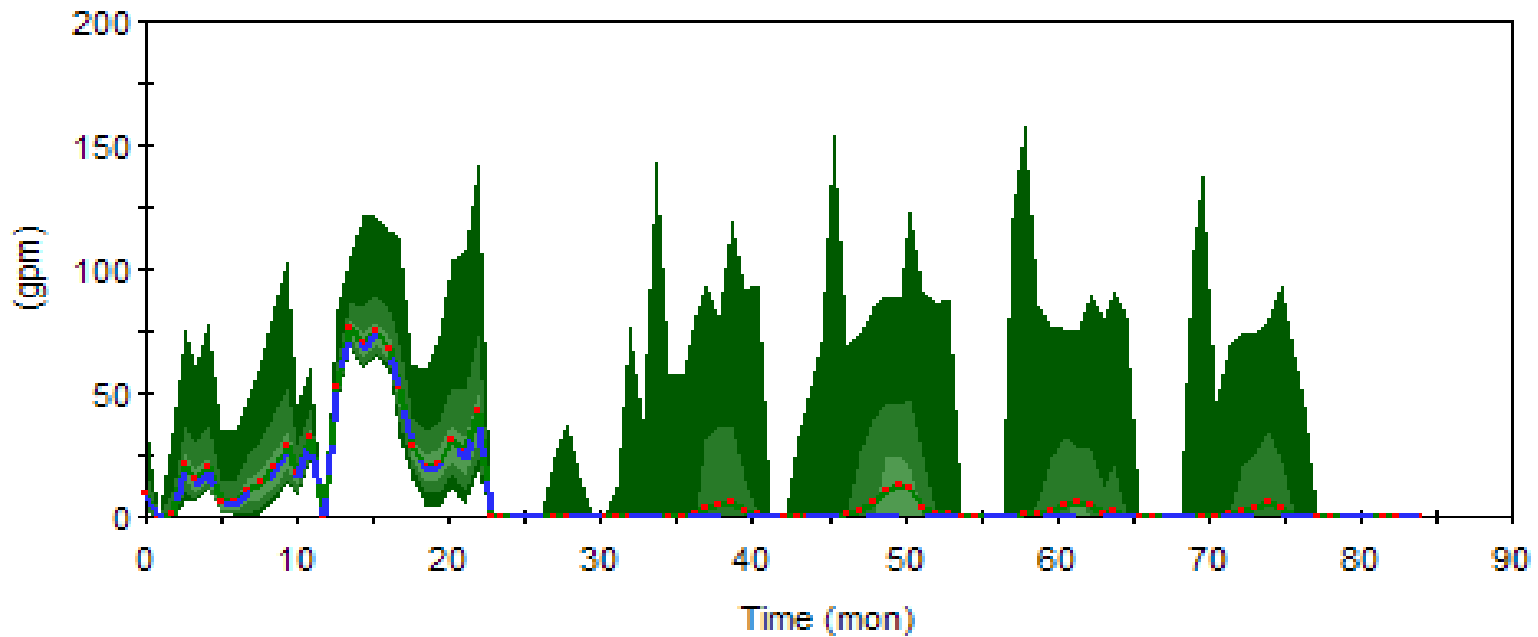

Denver, Colorado

TITLE

AVAILABLE EXCESS PUMPING RATE FOR 1,000-TPD MILLING RATE

CLIENT/PROJECT
**ENERGY FUELS RESOURCES CORPORATION
 PIÑON RIDGE PROJECT**

DRAWN **GIA**
 CHECKED **GG**
 REVIEWED **DPH**

DATE **Oct-08**
 SCALE **AS SHOWN**
 FILE NO. **Figures2-22_05May08.xls**

JOB NO. **073-81694**
 DWG. NO. **N/A**
 FIGURE NO. **FIGURE I-21**

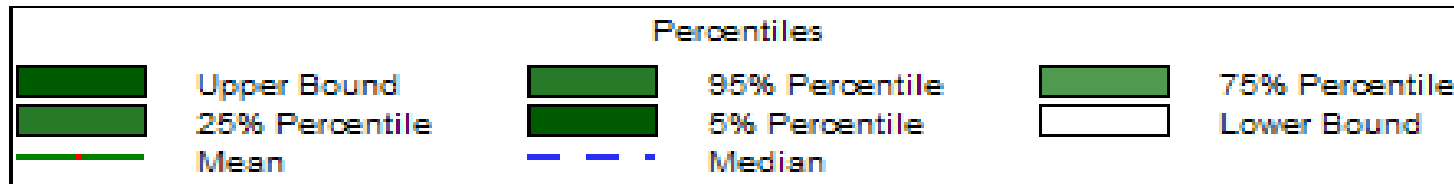
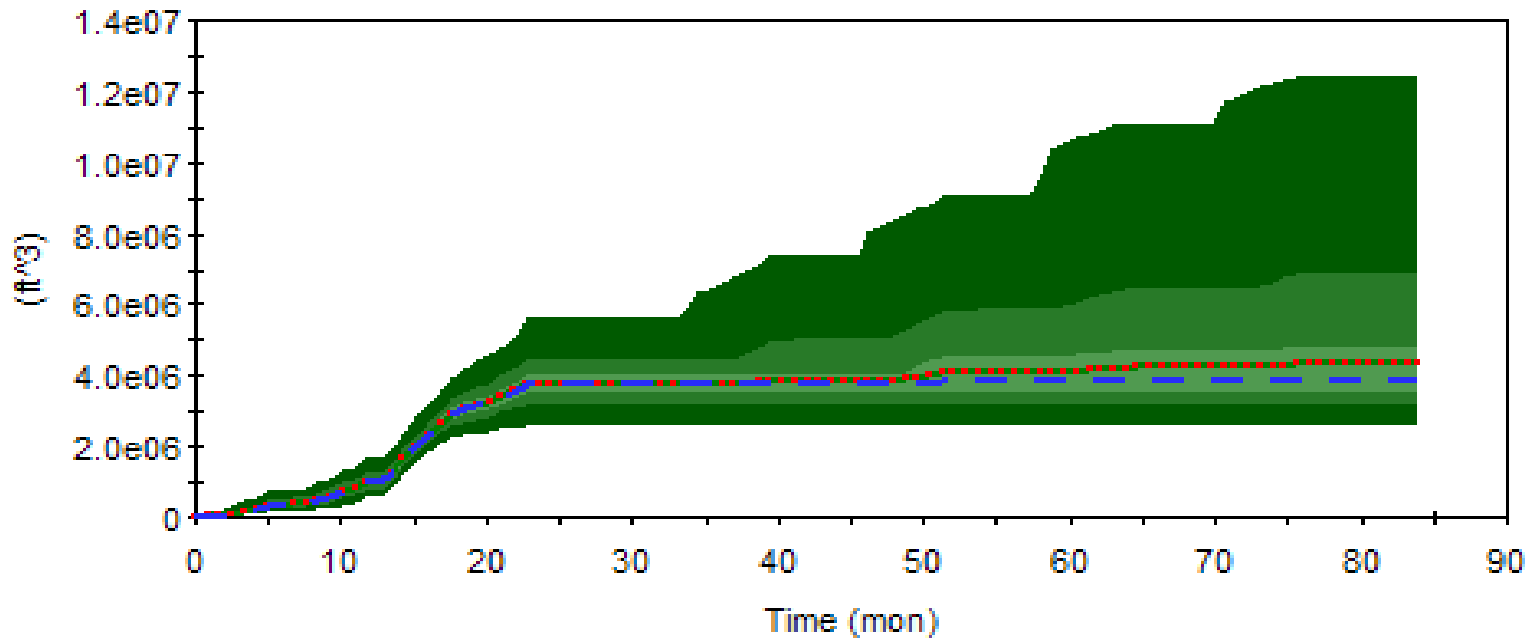

Denver, Colorado

TITLE

**AVAILABLE EXCESS MAKE-UP WATER VOLUME
FOR 1,000-TPD MILLING RATE**

CLIENT/PROJECT
**ENERGY FUELS RESOURCES CORPORATION
PIÑON RIDGE PROJECT**

DRAWN **GIA**
CHECKED **GG**
REVIEWED **DPH**

DATE **Oct-08**
SCALE **AS SHOWN**
FILE NO. **Figures2-22_05May08.xls**

JOB NO. **073-81694**
DWG. NO. **N/A**
FIGURE NO. **FIGURE I-22**

APPENDIX I-1
CLIMATIC DATA ANALYSIS



Subject Piñon Ridge Project
Facility Design
Weather Data Analysis

Made by EF
Checked by <i>KFM</i>
Approved by <i>KFM</i>

Job No 073-81694
Date 1/8/08
Sheet No 1 of 5

OBJECTIVE:

Evaluate the available weather data for the Piñon Ridge site and select a data set to be used in the design of facilities for the project.

GIVEN:

- Daily weather data obtained from the Western Regional Climate Center from the following locations:
 - Uravan
 - Nucla
 - Grand Junction
 - Montrose

ANALYSIS:

Site-Specific Data

Piñon Ridge site is located at 38°15' latitude, 108°45' longitude, elevation 5,480 feet. The site rests in the middle of a narrow valley near Monogram Mesa (see Figure I-1-1). Due to the limitations of obtaining site specific weather data, nearby weather stations are used to estimate or approximate the climatic conditions for the Piñon Ridge site.

Regional Data

The weather data from the following weather stations are considered due to proximity to the investigated site, and the available data inventory:

- *Uravan* (NCDC No. 058560)
- *Nucla* (NCDC No. 053807)
- *Grand Junction* (NCDC No. 053488)
- *Grand Junction 6 ESE* (NCDC No. 053489)
- *Montrose 1* (NCDC No. 055717)
- *Montrose 2* (NCDC No. 055722)

Data for above sites were obtained from the Western Regional Climate Center. The locations of the nearby weather stations and the Piñon Ridge site are illustrated in Figure I-1-2. In the following section, a brief description is presented for each weather station.

Uravan

Uravan is located at 38°22' latitude 108°45' longitude, elevation 5,010 feet, about 8.5 miles North of the Piñon Ridge site. The difference in elevation between the sites is 470 feet. This weather station provides the following daily weather data between the years of 1960 to 2007:



Subject Piñon Ridge Project
Facility Design
Weather Data Analysis

Made by EF
Checked by <i>KFM</i>
Approved by <i>KFM</i>

Job No 073-81694
Date 1/8/08
Sheet No 2 of 5

- Precipitation
- Air temperature
- Snow cover

The average total annual precipitation is equal to 12.6 inches. The months of September and October are generally the wettest months of the year. The maximum total annual precipitation of 21.4 in was recorded in 1965. The driest year was 1989 with a total annual rainfall equal to 7.3 inches. The average annual temperature is equal to 53.1 °F, and the average total annual snowfall is equal to 9.4 inches. The maximum snowfall was recorded during 1978-1979 with a total 40.4 in. Table I-1-1 shows the average monthly and annual data for this weather station.

Nucla

Nucla is located at 38°13' latitude 108°33' longitude, elevation 5,860 feet, about 11 miles East of the Piñon Ridge site. The difference in elevation between the sites is 380 feet. This weather station provides the following daily weather data for the years 1999 to 2007:

- Air temperature
- Solar radiation
- Wind velocity
- Relative humidity
- Precipitation

The average annual temperature at the Nucla site is 53 °F. The solar radiation has been increasing during the period of record (i.e., 1999 to 2007) from 746 langley (ly) in 1999 to 827 ly in 2007. The maximum solar radiation was collected during June 2007 at 828 ly. The average relative humidity (RH) for this site is equal to 42%, where the driest season corresponds to summer time (RH =31 %) . The average total annual precipitation for this location is 9.3 inches. The wettest month is September with an average accumulated precipitation of 1.8 inches. The driest month corresponds to January with 0.3 inches of precipitation. The wettest year correspond to 2006 with a total accumulated precipitation equal to 10.4 inches. Table I-1-2 shows the average monthly and annual data for this weather station.

Grand Junction Airport

Grand Junction Airport is located at 39° 8' latitude 108°32' longitude, elevation 4,840 feet, about 62 miles North of the Piñon Ridge site. The difference in elevation between the sites is 640 feet. This weather station provides the following daily weather data for the years 1900 to 2007:

- Air temperature
- Precipitation
- Snow cover
- PAN evaporation
- Relative humidity
- Cloud cover
- Wind velocity



Subject	Piñon Ridge Project
Facility Design	
Weather Data Analysis	

Made by	EF
Checked by	<i>KAM</i>
Approved by	<i>KAM</i>

Job No	073-81694
Date	1/8/08
Sheet No	3 of 5

PAN evaporation data is available only for years 1948 to 1960 for this location, with an average total annual PAN evaporation equal to 82.4 inches. The annual average relative humidity is equal to 53.1%. An annual average of 22 inches of snowfall was recorded at Grand Junction airport, with a maximum snowfall of 6.3 inches recorded in December of 1998. The wettest year was in 1957 with 15.7 in of total precipitation. Grand Junction airport average annual precipitation is 8.8 in. The average cloud cover is 6%. The average annual data for Grand Junction are summarized in Table I-1-3.

Grand Junction 6ESE

Grand Junction 6ESE weather station is located at 39° 2' latitude 108°27' longitude, and elevation of 4,760 feet. The weather station is located 7.8 miles south of the Grand Junction Airport weather station. This weather station complements the data provided by the Grand Junction airport weather station. The Grand Junction 6ESE weather station provides the following daily weather data for the years 1962 to 2007:

- Air temperature
- Precipitation
- PAN evaporation
- Snow cover

The total average annual PAN evaporation is equal to 57.9 inches. The average annual precipitation is equal to 8.9 inches. The wettest year was in 1957 with 16 inches of total precipitation. The average annual snowfall for this station is 12.3 inches with a maximum snow fall recorded in December of 1978. Table I-1-4 shows the average annual data for this weather station.

Montrose

Two weather stations are used to obtain climate data for this location: one located at 38°28' latitude 107°52' longitude, elevation 5,786 feet and the second located at 38°29' latitude 107°52' longitude, elevation 5,785 feet. The first weather station provides data from 1905 to 1982; the second weather station provides data from 1895 to 2007. Montrose is located 50 miles southeast from the Piñon Ridge site. These weather stations provide the following daily weather data:

- Air temperature
- Precipitation
- Snow cover
- Average monthly PAN evaporation

The average total annual snowfall recorded at this location is 25.9 inches. With a maximum snowfall of 72 inches recorded in 1918. Montrose records show that the average annual precipitation is 9.6 in. The maximum precipitation was in 1941 with 17 inches of rainfall. The annual average PAN evaporation is 55.8 inches. Table I-1-5 shows the average monthly annual data for this weather station.



Subject Piñon Ridge Project
Facility Design
Weather Data Analysis

Made by EF
Checked by <i>KAM</i>
Approved by <i>KAM</i>

Job No 073-81694
Date 1/8/08
Sheet No 4 of 5

Data Analysis

Precipitation Data

Figure I-1-3 shows a comparison in total annual precipitation for years 1999 through 2007. Note that the Uravan weather station exhibits higher average annual precipitation than the rest of the sites. Table 1 compares the accumulated precipitation from 1999 to 2007 for all sites. Uravan weather station, which is the closest station to the Piñon Ridge site, provides the maximum precipitation. Also, historical data shows that the Uravan weather station provides the most critical rainfall event (year 1965). For reference purposes, Figure I-1-4 presents the annual precipitation as a function of station elevation for all regional stations considered in this report. Note that there is no clear correlation between elevation and precipitation for the considered weather stations. Figure I-1-5 shows the monthly precipitation for the driest and wettest years for the Uravan weather station. A comparison of monthly precipitation between Uravan and Grand Junction airport weather stations for the years 1965 (wettest year) and 1989 (driest year), show that these sites present different precipitation events (Figure I-1-6 and Figure I-1-7).

Table 1. General statistics for selected weather stations.

	Elevation (ft)	Difference in Elevation (ft) ¹	Distance to Piñon Ridge (miles)	Accumulated Precipitation (in) from 1999-2007	Average Max. Temp (°F)	Average Min. Temp (°F)
Uravan	5010	-470	8.5	100	69	37
Nucla	5860	380	11	74	68	39
Grand Junction	4840	-640	62	81	67	41
Montrose	5786	306	49.5	87	63	35

¹Compared to Piñon Ridge site, EL. 5,480 ft

Temperature Data

A comparison between different weather stations is shown in Figure I-1-8. Correlation between elevation and temperature is shown in Figure I-1-9. A summary of temperature data is presented in Table 1.

Evaporation/Evapotranspiration data

Due to the limitation of weather data, the potential evapotranspiration (PET) for the Uravan weather station was calculated using the Hargreaves (1985) method as discussed by Allen et al. (1998). The estimated PET was then scaled by a factor of 0.7, to meet the average annual evaporation from shallow lakes for the Piñon Ridge site (Figure I-1-10). Figure I-1-11 shows a comparison between PAN evaporation and analytical PET estimates for different sites. Table 2 summarizes the scaled monthly PET for the Uravan weather station.



Subject	Piñon Ridge Project
Facility Design	
Weather Data Analysis	

Made by	EF
Checked by	KAM
Approved by	KAM

Job No	073-81694
Date	1/8/08
Sheet No	5 of 5

Table 2. Scaled Average monthly PET evaporation for the Uravan weather station

	Avg. PET (in)
January	0.8
February	1.2
March	2.2
April	3.2
May	4.6
June	5.5
July	5.9
August	5.0
September	3.7
October	2.5
November	1.2
December	0.7
Total Annual	35.8

Wind data

Table I-1-6 shows the maximum annual wind speed for various years for the Grand Junction airport and Nucla weather stations. The maximum wind speed was recorded in Grand Junction weather station at 23.4 miles per hour (mph) in the year 2007. The average wind speed for this weather station is 7.8 mph. The prevalent wind direction is ESE for Grand Junction, SE for Montrose and E for the Nucla station.

CONCLUSIONS:

A review of available climate records for nearby weather stations indicates that Uravan weather station is likely to represent conservative precipitation estimates for the Piñon Ridge site.

REFERENCES:

Western Regional Climate Center online data source: <http://www.raws.dri.edu/cgi-bin/rawMAIN.pl?coCNUC>

Kleinfelder (2007). "Climatological Report, Piñon Ridge Mill Site Montrose County, Colorado." Kleinfelder project no. 83088

Allen, R. G., Pereira, L. S., Raes, D., and Smith, M. (1998). "Crop evapotranspiration - Guidelines for computing crop water requirements." Irrigation and drainage paper 56, FAO, Rome.

TABLES

TABLE I-1-1. Uravan weather station data

Period of record : 11/17/1960 to 6/30/2007

	Jan	Feb	Mar	Apr	May	Jun	Jul	Aug	Sep	Oct	Nov	Dec	Annual
Average Max. Temperature (F)	42.7	49.9	58.7	67.6	78.6	89.4	95.4	92.2	83.5	71.4	54.7	43.4	69
Average Min. Temperature (F)	15.6	22.4	29.2	35.7	44.5	52.4	59.3	58.1	48.3	36.9	26.5	17.8	37.2
Average Total Precipitation (in.)	0.88	0.76	1.03	1.01	0.94	0.48	1.2	1.35	1.5	1.51	1.05	0.88	12.6
Average Total SnowFall (in.)	3.8	0.8	0.5	0.2	0	0	0	0	0	0.1	0.6	3.5	9.4

TABLE I-1-2. Nucla weather station data

Period of Record : 1/ 1/1999 to 12/31/2007

	Jan	Feb	Mar	Apr	May	Jun	Jul	Aug	Sep	Oct	Nov	Dec	Annual
Average Max. Temperature (F)	44.8	48.5	57.4	65.3	76.5	87.3	93.5	88.4	79.8	67.7	54.2	43.3	67.4
Average Min. Temperature (F)	19.7	23.2	29.6	37.1	45.3	53.7	60.6	58.0	18.6	38.3	26.9	18.6	38.4
Average Total Precipitation (in.)	0.3	0.5	0.6	0.8	0.5	0.4	0.8	1.1	1.8	1.5	0.4	0.5	9.3

TABLE I-1-3. Grand Junction weather station data

Period of Record : 1/ 1/1900 to 12/31/2007

	Jan	Feb	Mar	Apr	May	Jun	Jul	Aug	Sep	Oct	Nov	Dec	Annual
Average Max. Temperature (F)	36.7	44.7	55.1	65.2	75.6	86.9	92.8	89.4	80.5	67.3	51.2	38.9	65.5
Average Min. Temperature (F)	16.0	23.3	31.2	39.3	48.26.0	54.2	64.1	62.0	53.0	41.1	28.3	18.7	40.4
Average Total Precipitation (in.)	0.6	0.6	0.8	0.8	0.8	0.4	0.6	1.0	1.0	0.9	0.7	0.6	8.8
Average Total SnowFall (in.)	6.1	4.0	3.2	0.9	0.1	0.0	0.0	0.0	0.0	0.4	2.5	4.9	22.0

TABLE I-1-4. Grand Junction 6ESE weather station data

Period of Record : 3/26/1962 to 6/30/2007

	Jan	Feb	Mar	Apr	May	Jun	Jul	Aug	Sep	Oct	Nov	Dec	Annual
Average Max. Temperature (F)	38.6	46.3	56.6	65.6	75.9	86.8	92.7	89.7	80.7	67.8	51.9	40.4	66.1
Average Min. Temperature (F)	17.5	23.9	32.3	39.5	48.4	57.2	63.5	61.3	52.4	40.8	29.2	19.7	40.5
Average Total Precipitation (in.)	0.48	0.45	0.87	0.84	0.94	0.5	0.75	0.83	0.97	0.98	0.76	0.55	8.93
Average Total SnowFall (in.)	3.4	1.8	1.6	0.3	0.1	0	0	0	0	0.3	1.4	3.5	12.3

TABLE I-1-5. Montrose weather station data

Period of Record : 1/ 1/1895 to 6/30/2007

	Jan	Feb	Mar	Apr	May	Jun	Jul	Aug	Sep	Oct	Nov	Dec	Annual
Average Max. Temperature (F)	38	43.9	52.9	62.4	72.4	83.1	88.6	85.7	77.9	65.7	50.3	39.3	63.3
Average Min. Temperature (F)	13.7	19.7	26.6	34	42.1	49.7	55.6	53.9	45.6	35	23.9	15.3	34.6
Average Total Precipitation (in.)	0.57	0.48	0.7	0.86	0.88	0.53	0.86	1.26	1.1	1.04	0.66	0.62	9.56
Average Total SnowFall (in.)	6.5	4.3	3.5	1.8	0.1	0	0	0	0	0.6	2.7	6.4	25.9

TABLE I-1-6. Maximum annual wind speed

Year	Grand Junction Airport	Nucla
	wind speed (mph)	wind speed (mph)
1984	16.3	-
1985	18.3	-
1986	22.0	-
1987	14.8	-
1988	18.6	-
1989	17.3	-
1990	17.8	-
1991	18.1	-
1992	17.1	-
1993	17.2	-
1994	19.4	-
1995	16.8	-
1996	17.7	-
1997	18.1	-
1998	18.0	16.4
1999	17.1	18.2
2000	18.8	18.6
2001	19.7	14.6
2002	21.2	17.2
2003	19.8	16.8
2004	19.9	14.3
2005	18.0	14.0
2006	21.9	14.8
2007	23.4	15.1
Maximum W(mph)		23.4
		18.6

FIGURES

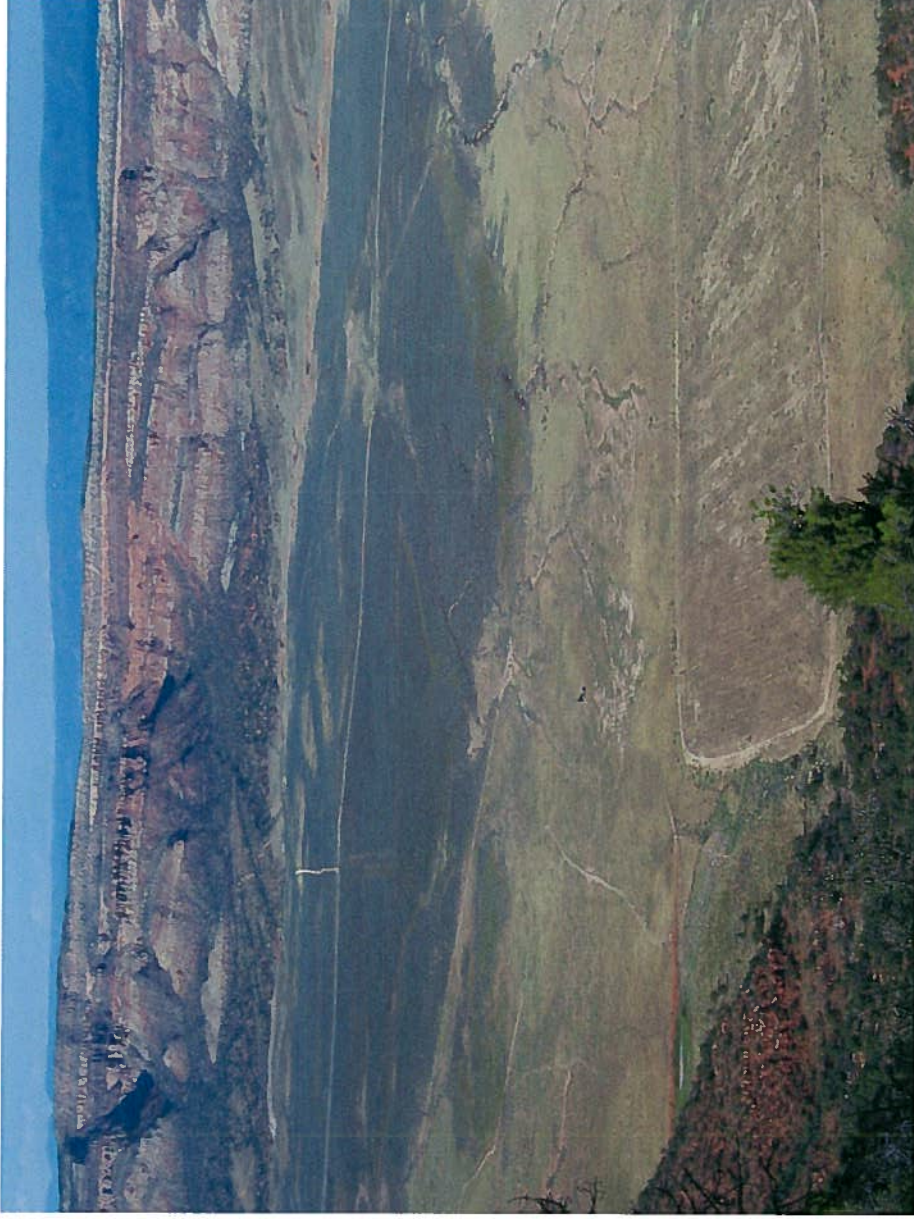

TITLE

SITE VIEW PIÑON RIDGE

DRAWN EF
 CHECKED GG
 REVIEWED KFM

DATE 1/16/2008
 SCALE N.T.S
 FILE NO. FIGURE.PPT

JOB NO. 073-81694
 DWG. NO. N/A
 FIGURE NO. I-1-1



Denver, Colorado

**ENERGY FUELS RESOURCES
 CORPORATION PIÑON RIDGE PROJECT**

CLIENT/PROJECT

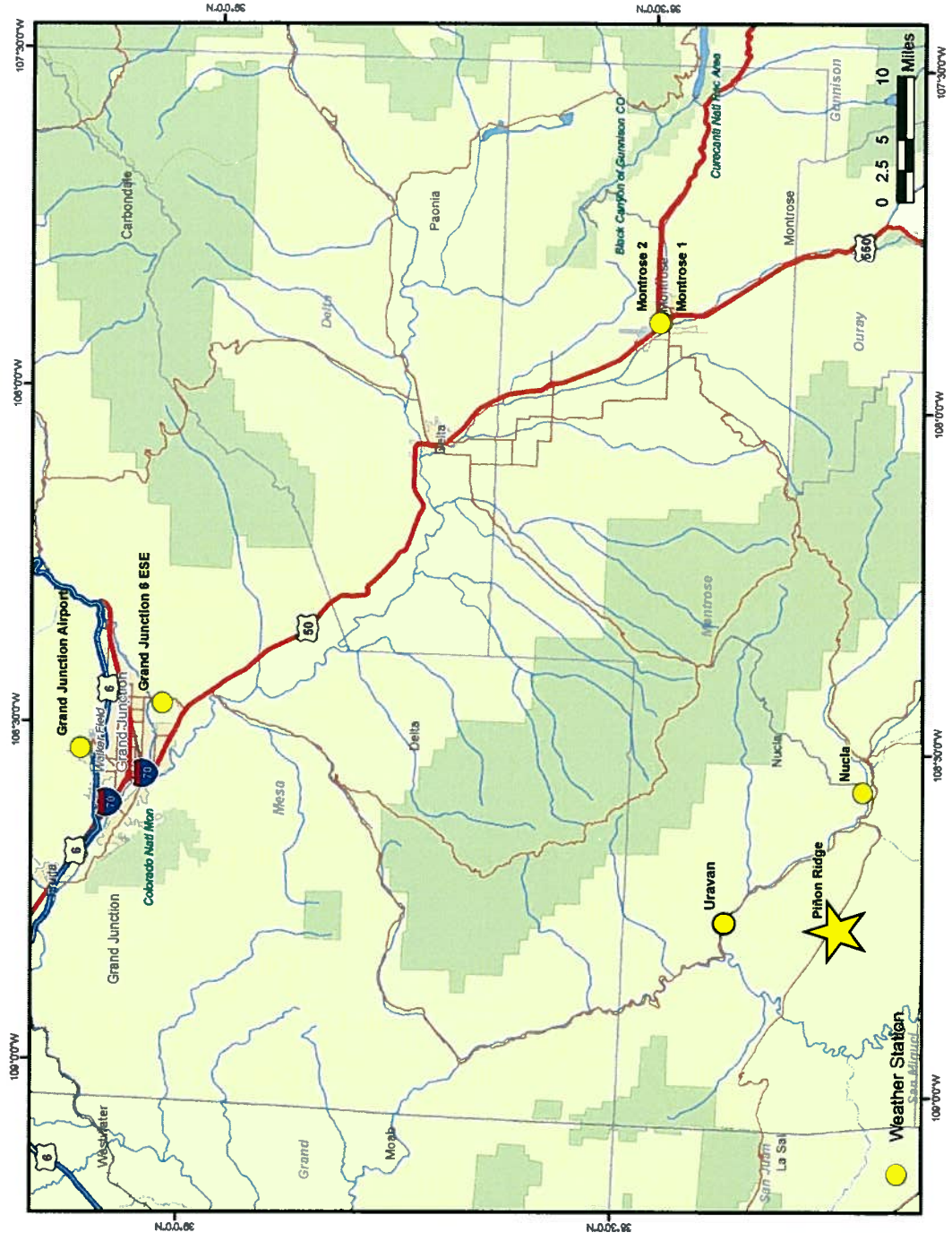

WEATHER STATION LOCATIONS



Denver, Colorado

CLIENT/PROJECT
ENERGY FUELS RESOURCES CORPORATION
PIÑON RIDGE PROJECT

TITLE

DRAWN **EF**
 CHECKED **GG**
 REVIEWED **KFM**

DATE **1/16/2008**
 SCALE **N.T.S**
 FILE NO. **FIGURE.PPT**

JOB NO. **073-81694**
 DWG. NO. **N/A**
 FIGURE NO. **I-12**

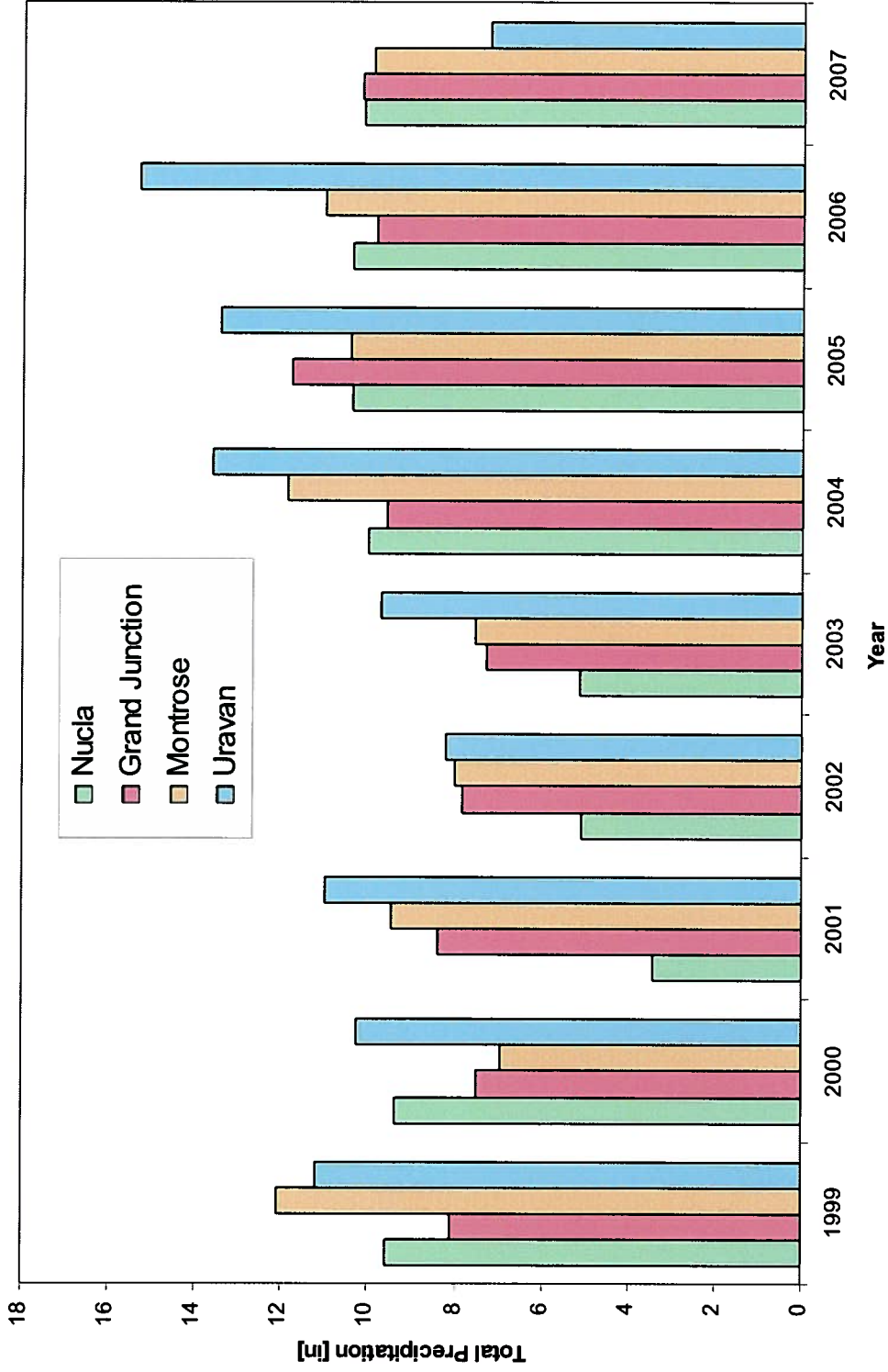

Denver, Colorado

ENERGY FUELS RESOURCES CORPORATION
PIÑON RIDGE PROJECT

TOTAL ANNUAL PRECIPITATION

TITLE

DRAWN EF
 CHECKED GG
 REVIEWED KFM

DATE 1/16/2008
 SCALE N.T.S
 FILE NO. FIGURE.PPT

JOB NO. 073-81694
 DWG. NO. N/A
 FIGURE NO. I-1-3

CLIENT/PROJECT

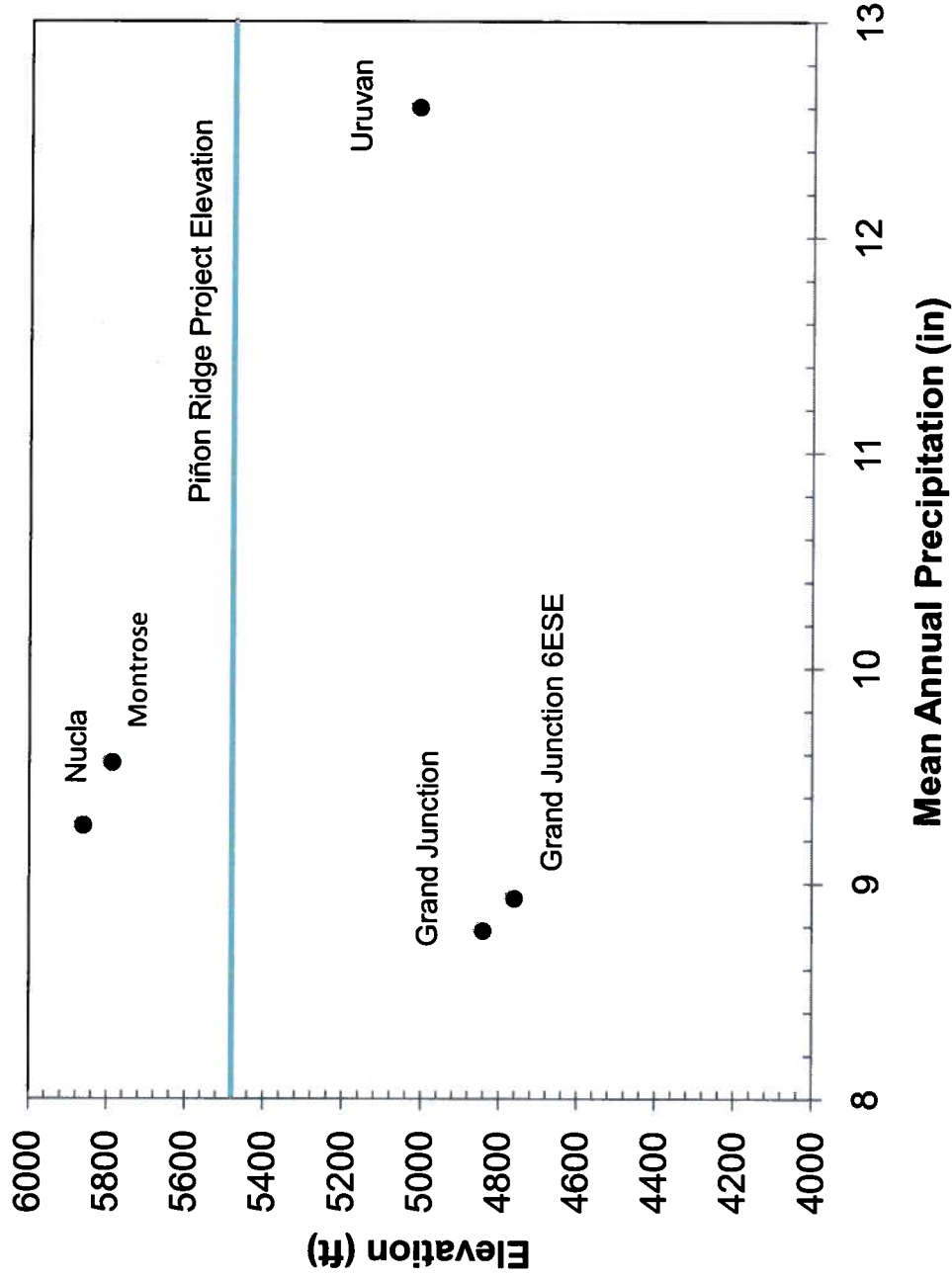

Denver, Colorado

ENERGY FUELS RESOURCES CORPORATION
PIÑON RIDGE PROJECT

TITLE

VARIATION IN ANNUAL PRECIPITATION vs. ELEVATION FOR REGIONAL METEOROLOGICAL STATIONS

DRAWN EF
 CHECKED GG
 REVIEWED KFM

DATE 1/16/2008
 SCALE N.T.S
 FILE NO. FIGURE.PPT

JOB NO. 073-81694
 DWG. NO. N/A
 FIGURE NO. I-1-4

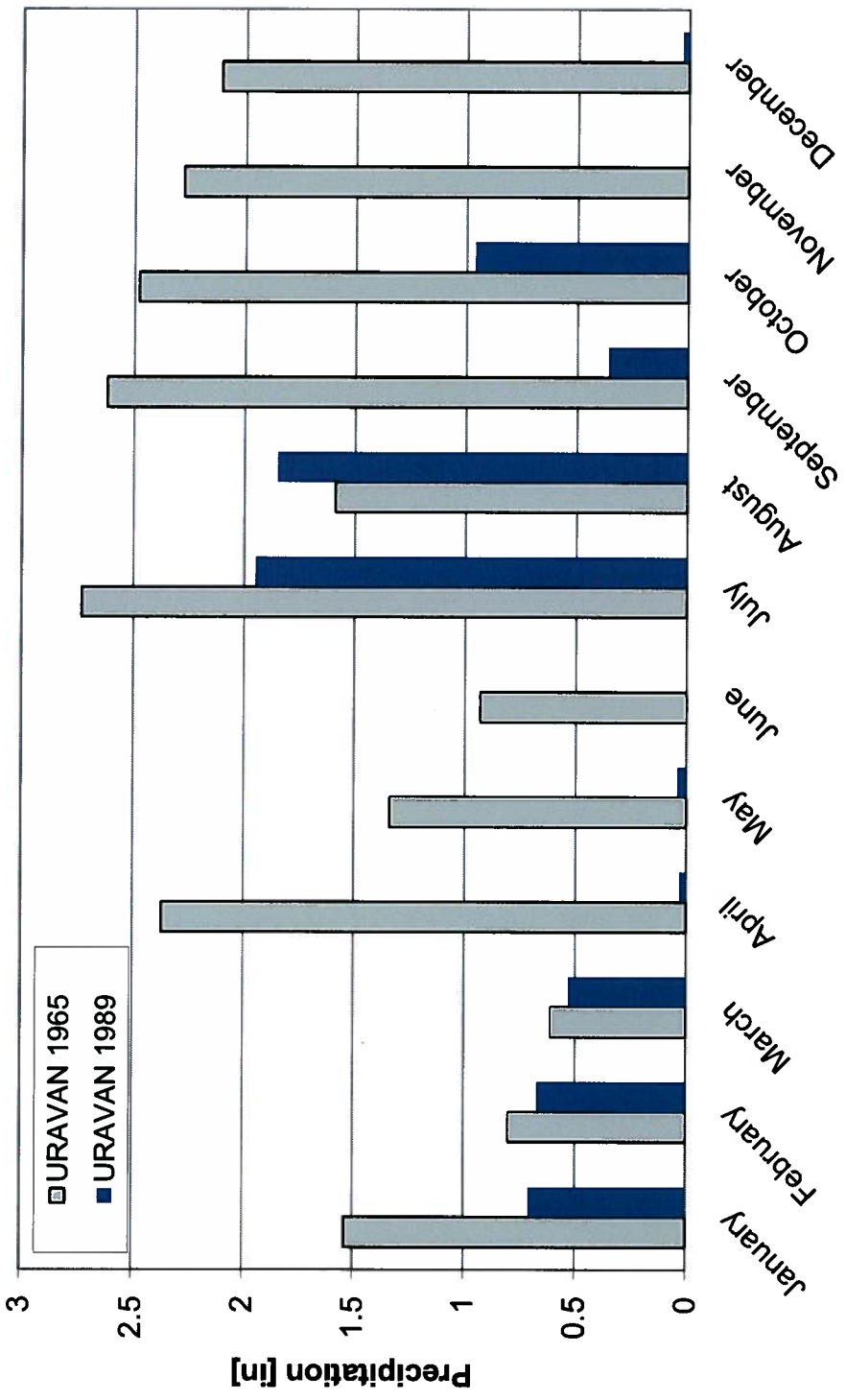

MONTHLY PRECIPITATION FOR DRIEST AND WETTEST YEAR FOR URAVAN SITE

 ENERGY FUELS RESOURCES CORPORATION PIÑON RIDGE PROJECT	CLIENT/PROJECT Denver, Colorado	TITLE MONTHLY PRECIPITATION FOR DRIEST AND WETTEST YEAR FOR URAVAN SITE	
	DRAWN EF CHECKED GG REVIEWED KFM	DATE 1/16/2008 SCALE N.T.S FILE NO. FIGURE.PPT	JOB NO. 073-81694 DWG. NO. N/A FIGURE NO. I-1-5

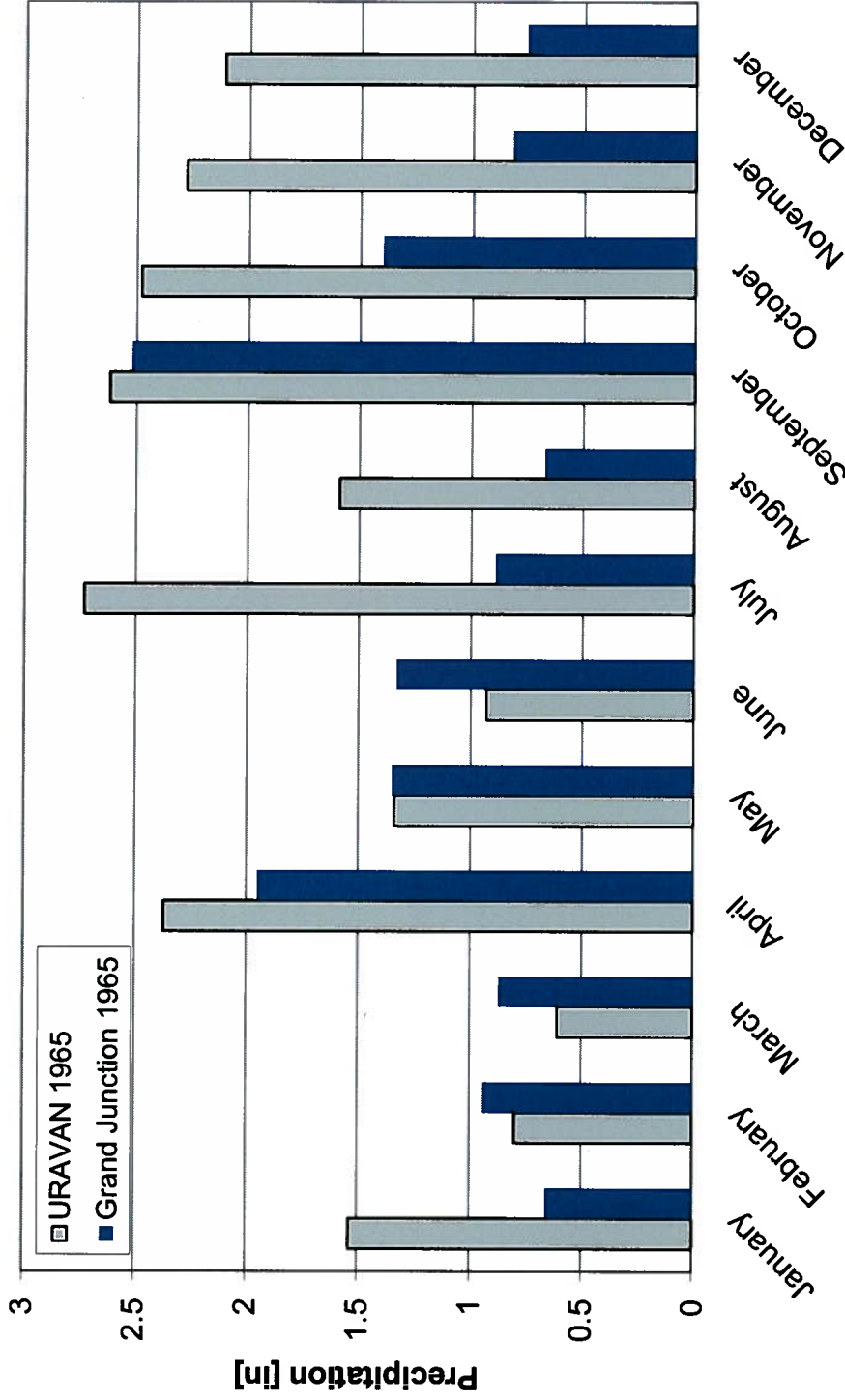

Month

ANNUAL PRECIPITATION URAVAN AND GRAND JUNCTION FOR YEAR 1965

 <p>Golder Associates Denver, Colorado</p>	<p>TITLE</p>	
	<p>DRAWN EF</p>	<p>DATE 1/16/2008</p>
	<p>CHECKED GG</p>	<p>SCALE N.T.S</p>
<p>CLIENT/PROJECT</p> <p>ENERGY FUELS RESOURCES CORPORATION PIÑON RIDGE PROJECT</p>	<p>REVIEWED KFM</p>	<p>JOB NO. 073-81694</p> <p>DWG. NO. N/A</p> <p>FIGURE NO. I-1-6</p>

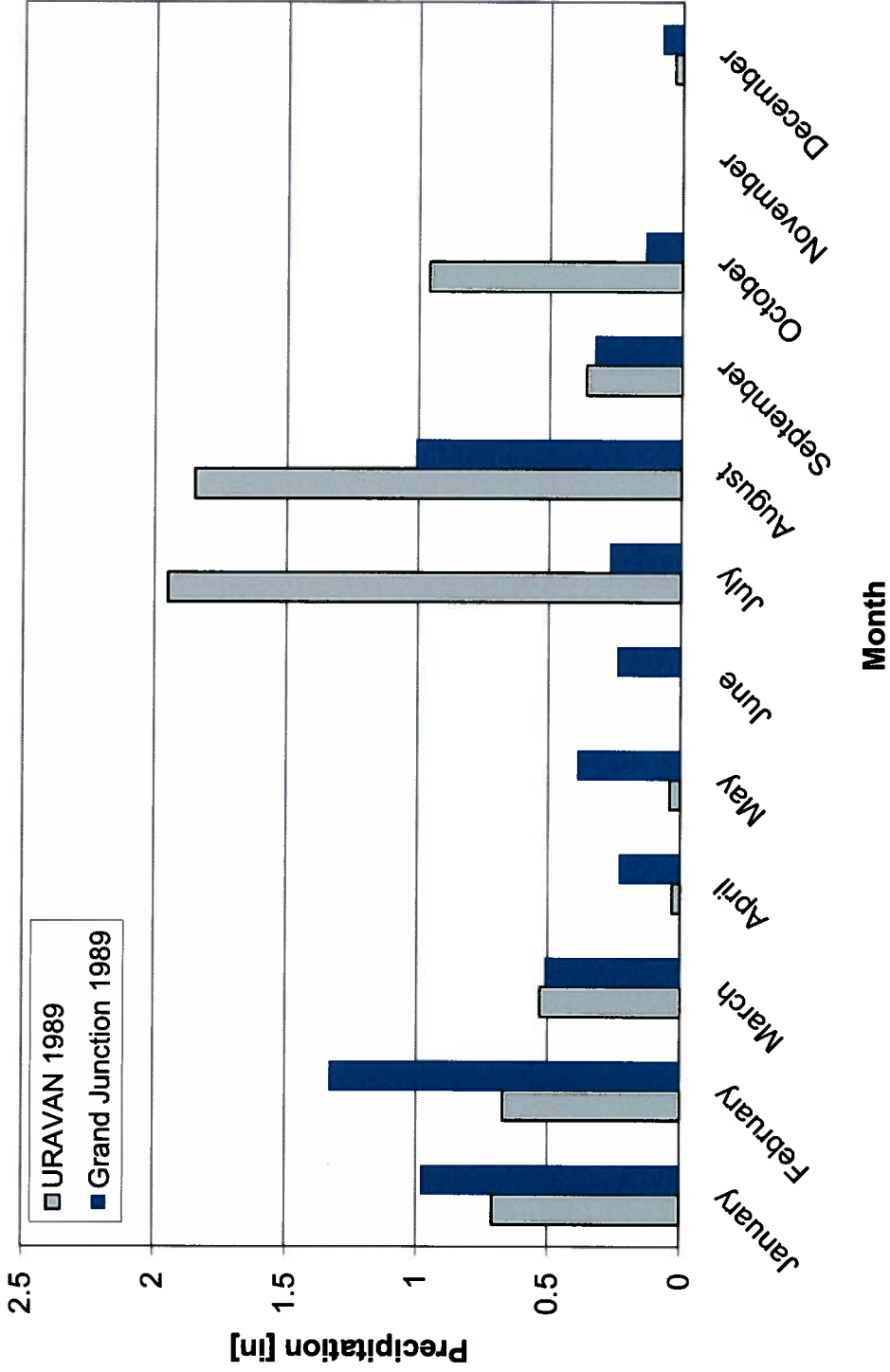

 ENERGY FUELS RESOURCES CORPORATION PIÑON RIDGE PROJECT	MONTHLY MAXIMUM TEMPERATURE FOR URAVAN AND GRAND JUNCTION	
	CLIENT/PROJECT Denver, Colorado	TITLE
	DRAWN EF CHECKED GG REVIEWED KFM	DATE 1/16/2008 SCALE N.T.S FILE NO. FIGURE.PPT
JOB NO. 073-81694 DWG. NO. N/A FIGURE NO. I-1-7		

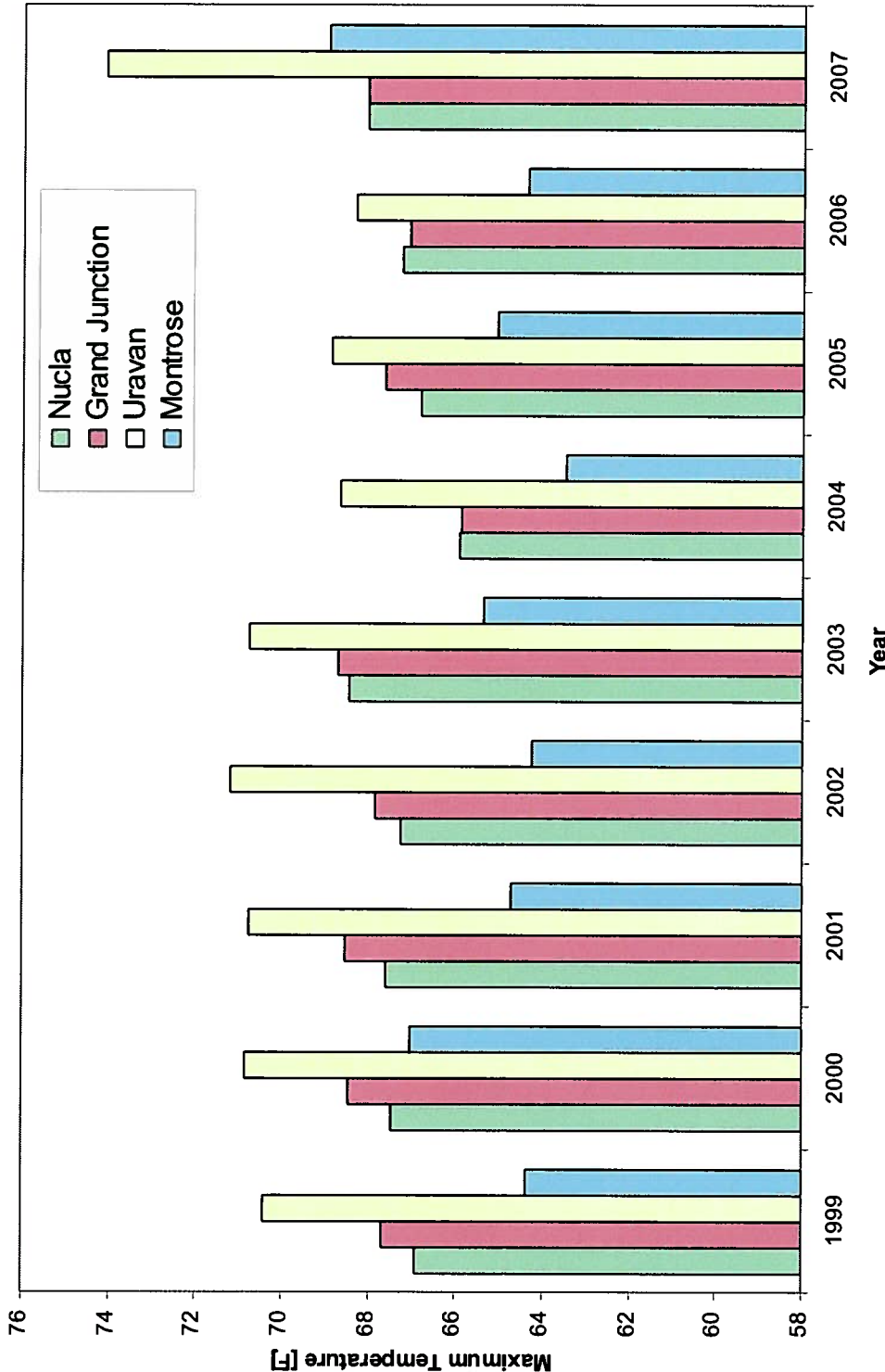

Denver, Colorado

ENERGY FUELS RESOURCES CORPORATION
PIÑON RIDGE PROJECT

ANNUAL MAXIMUM TEMPERATURE

CLIENT/PROJECT	DATE	JOB NO.
ENERGY FUELS RESOURCES CORPORATION PIÑON RIDGE PROJECT	1/16/2008	073-81694
DRAWN	SCALE	DWG. NO.
EF	N.T.S	N/A
CHECKED	FILE NO.	FIGURE NO.
GG	FIGURE.PPT	I-1-8
REVIEWED		
KFM		

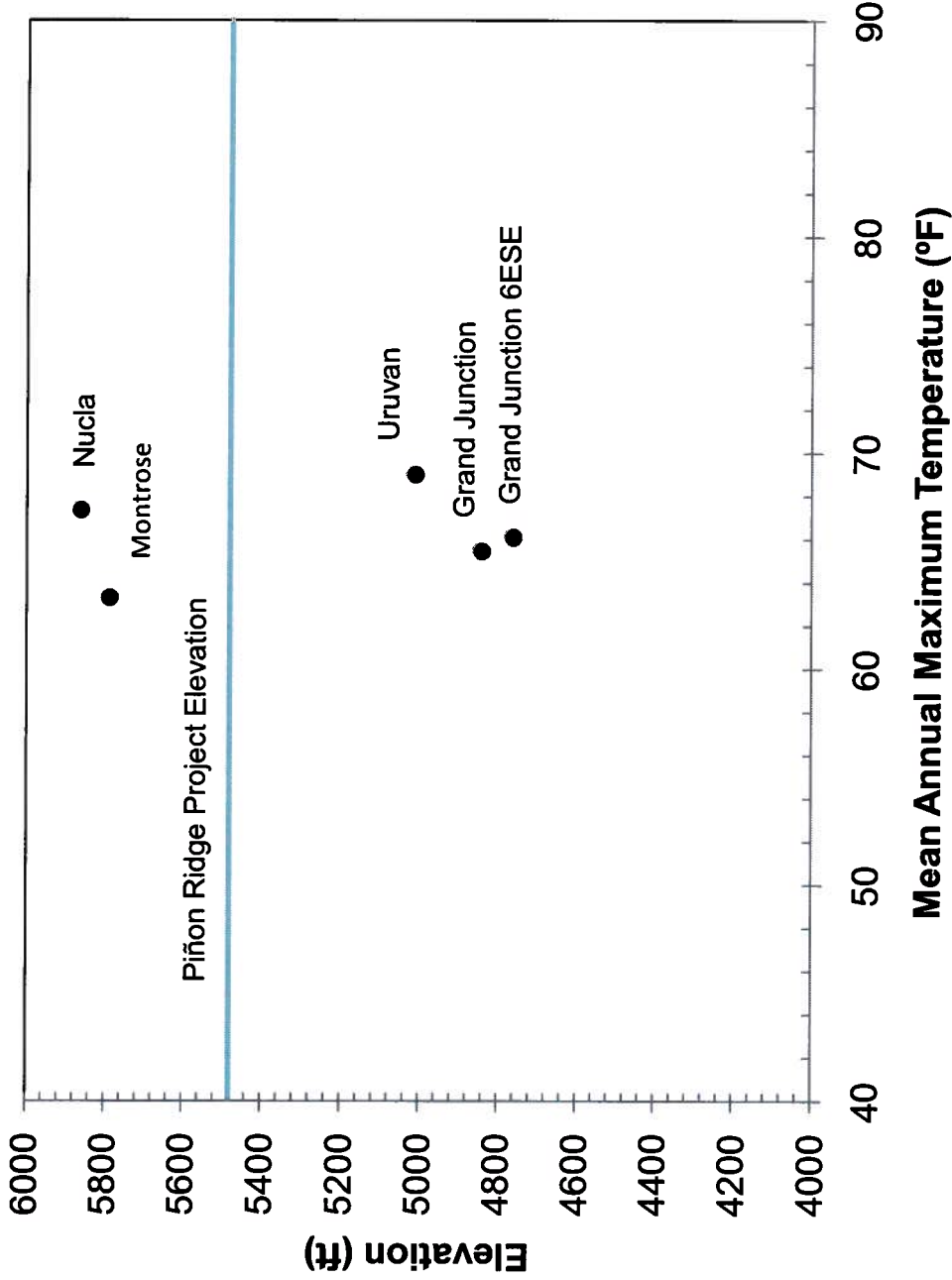

Denver, Colorado

ENERGY FUELS RESOURCES CORPORATION
PIÑON RIDGE PROJECT

TITLE

VARIATION IN ANNUAL MAX. TEMPERATURE vs. ELEVATION FOR REGIONAL METEOROLOGICAL STATIONS

DRAWN EF
 CHECKED GG
 REVIEWED KFM

DATE 1/16/2008
 SCALE N.T.S
 FILE NO. FIGURE.PPT

JOB NO. 073-81694
 DWG. NO. N/A
 FIGURE NO. I-1-9

CLIENT/PROJECT

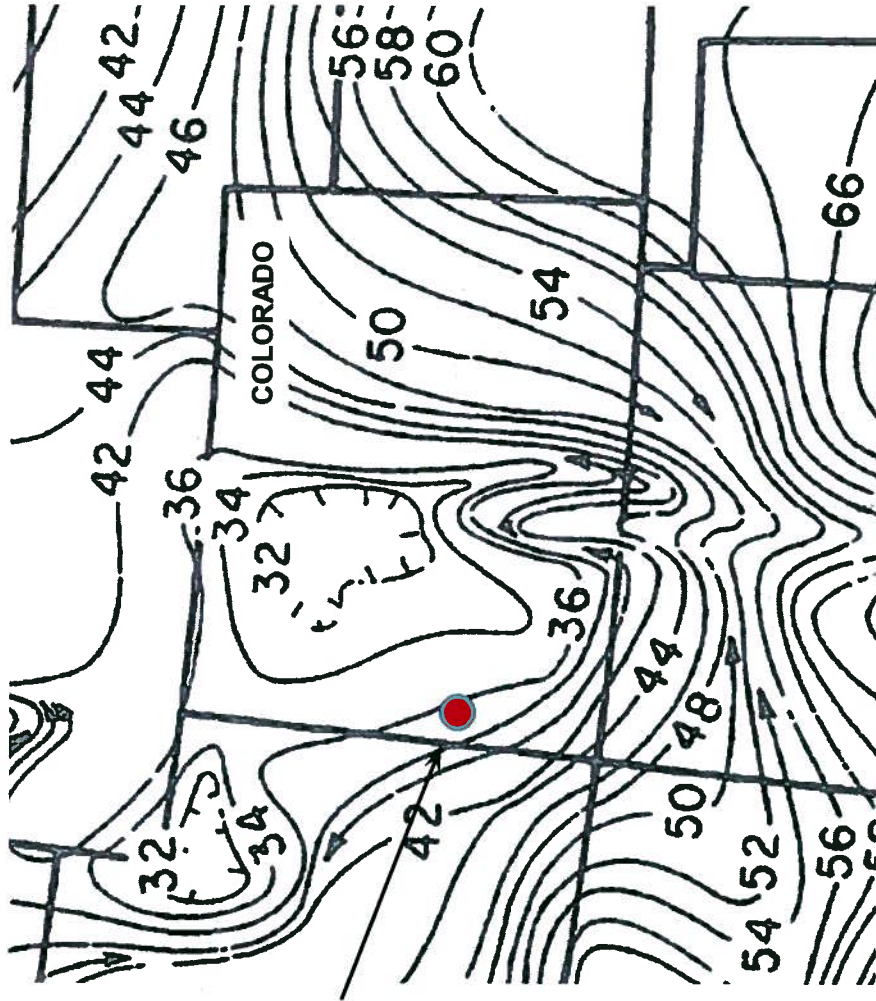

Piñon Ridge site



Denver, Colorado

**ENERGY FUELS RESOURCES
CORPORATION PIÑON RIDGE PROJECT**

TITLE

**AVERAGE ANNUAL EVAPORATION (INCHES) FROM SHALLOW
LAKES**

DRAWN EF
CHECKED GG
REVIEWED KFM

DATE 1/16/2008
SCALE N.T.S
FILE NO FIGURE.PPT

JOB NO. 073-81694
DWG. NO. N/A
FIGURE NO. I-1-10

CLIENT/PROJECT

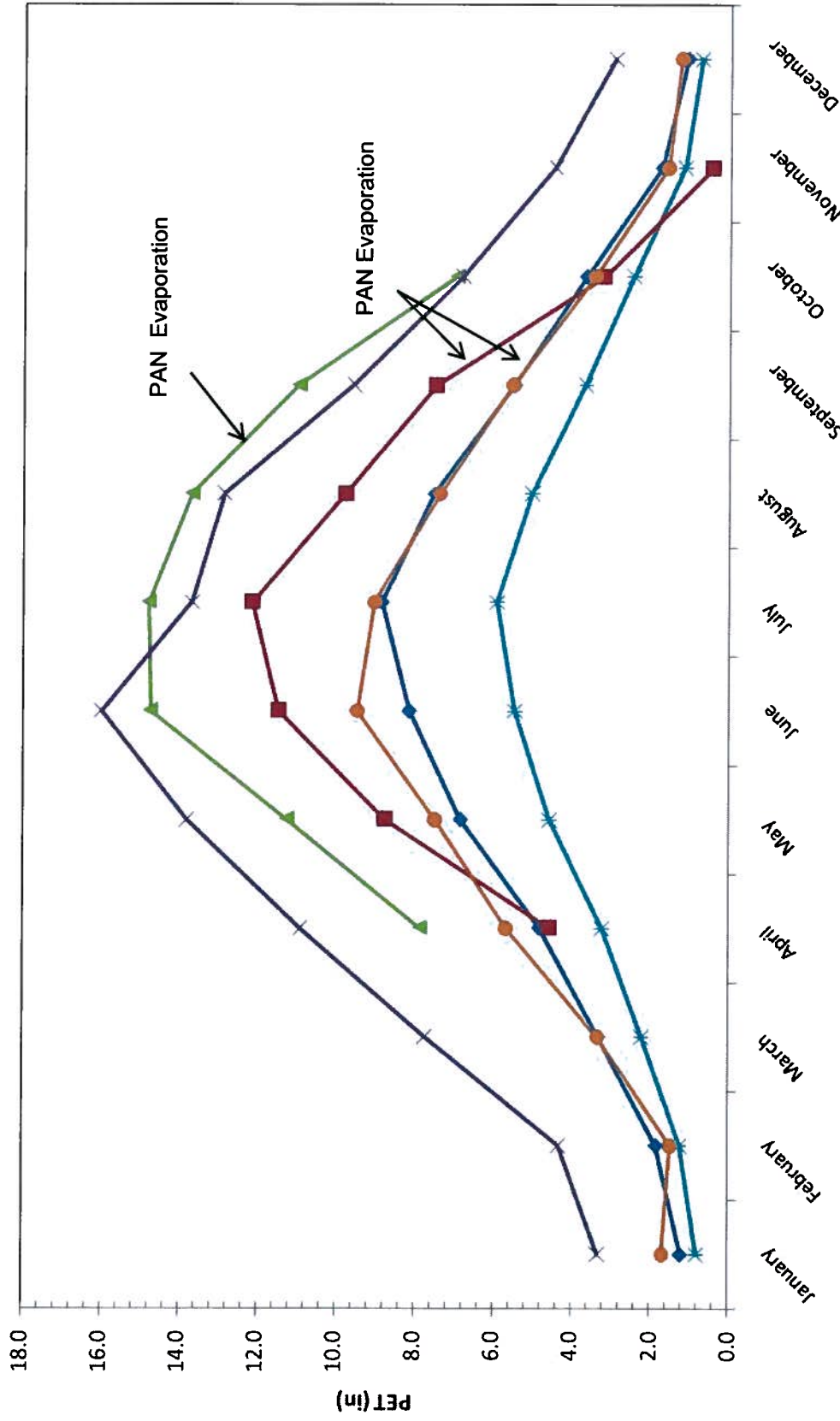

MONTHLY EVAPOTRANSPIRATION



Denver, Colorado

ENERGY FUELS RESOURCES CORPORATION
PIÑON RIDGE PROJECT

TITLE

CLIENT/PROJECT

DRAWN EF
 CHECKED GG
 REVIEWED KFM

DATE 1/16/2008
 SCALE N.T.S
 FILE NO. FIGURE.PPT

JOB NO. 073-81694
 DWG. NO. N/A
 FIGURE NO. I-1-11

APPENDIX J
TAILINGS DEPOSITION MODELING

APPENDIX J

TAILINGS DEPOSITION MODELING

Tailings deposition within Tailings Cell A was modeled using Golder's proprietary software *GoldTail*. This software performs geometrical calculations inside of the tailings cells to determine the final configuration of the cell surface affected by the tailings discharge. The purpose of the tailings deposition modeling is to provide mill operations personnel with a method for tailings discharge which enhances design of the tailings cells by providing protection to the constructed underdrain system from potential slimes clogging, as well as provides initial buttressing to the geomembrane liner system.

DEPOSITIONAL PHASES

Tailings deposition was modeled within Tailings Cell A in the following five simplified phases:

- *Phase 1* – Deposition commences within sub-cell A1 (or A2) in the vicinity of the underdrain sump to provide approximately 10 feet of tailings deposition over the sump area. This phase of deposition provides coarse-grained underflow tailings over the underdrain sump to enhance effectiveness of the tailings underdrain system;
- *Phase 2* – Continued deposition within the remainder of the first sub-cell to push the pond toward the sump area;
- *Phase 3* – This phase was modeled with deposition commencing within the other sub-cell in the vicinity of the underdrain sump, again providing approximately 10 feet of coarse-grained underflow tailings over the underdrain sump area. (Note: During actual operations, Golder recommends reversing the order of the modeled Phases 2 and 3 in order to buttress the geomembrane liner system within both sub-cells at the on-set of operations, prior to completely filling the first sub-cell);
- *Phase 4* – Continued deposition within the remainder of the second sub-cell to push the pond toward the sump area; and

- *Phase 5* – Once both sub-cells are filled, tailings deposition will proceed along the perimeter of the entire tailings cell in stages (as dictated by tailings operations), until the tailings cell is full (with 3 feet of freeboard provided at the perimeter of the cell).

The perimeter discharge of Phase 5 will leave a depression in the center of the cell resulting from the tailings beach slopes and perimeter discharge arrangement. Although not modeled, a sixth and final phase of deposition would involve extending the tailings discharge pipes to the center of the cell to more efficiently use the available tailings storage space, and develop grades which support closure cover construction.

DEPOSITIONAL GEOMETRY

Three basic elements are considered in the tailings deposition simulation: (1) base surface (topography) which corresponds to the topographic base of the tailings cell; (2) limiting planes, which define the surroundings in which the tailings are deposited; and (3) the discharge cone, which represents the behavior of deposited tailings from a single discharge (Barrientos & Barrera, 2008; Golder Associates S.A., 2008).

GoldTail assumes that the deposited tailings can be represented by a cone, where the cone's vertex represents the discharge location, and the adopted tailings depositional slopes are used to develop the cone's geometry. The primary variables governing the behavior of the tailings deposition are: tailings depositional slopes; volume and location of the decant pond; tailings solids concentration (by weight); tailings gradation or particle size; mass distribution of tailings by discharge point; solids specific gravity; tailings production; and tailings depositional dry density (Barrientos et al. 2008). Figure J-1 shows the basic representative variables governing the behavior of the tailings deposition used by the computer code *GoldTail*.

Considering the tailings physical characteristics the following angles for the tailings slopes were adopted:

i_d = Slope at the discharge point = 5 %

i_1 = Slope of the tailings beach = 2%

i_2 = Pool side slope, below water = 10%

i_3 = Slope at base of pool = 0.5%

h = Depth of pool = 10 feet

Note that these variables should be considered only as first estimates. Actual discharge tailings slopes and pond volume data will provide more accurate simulation results.

Figure J-2 illustrates the geometry of Tailings Cell A prior to deposition. As discussed previously, five phases which represent the end of each general tailings deposition stage were considered:

- Phase 1 - Four (4) discharge points in cell A1 were considered (discharge points 1, 2, 3, and 4; see Figure J-3). ; The location of the discharge points were specified in order to produce an approximate tailings deposition cover of 10 feet over the underdrain sump;
- Phase 2 - Eight (8) discharge points (discharge points 5 through 12; see Figure J-4) located at the mid-height bench of cell A1 with two feet freeboard were considered for this phase;
- Phase 3 - Similar to Phase 1, four (4) discharge points and two feet freeboard were considered in cell A2 (discharge points 13 through 16; see Figure J-5), where the location of the points were specified in order to produce an approximate tailings deposition cover of 10 feet over the underdrain sump;
- Phase 4 - Like Phase 2, eight (8) discharge points and two feet freeboard were considered in cell A2 (discharge points 17 through 24; see Figure J-6);
- Phase 5 - Twenty-four (24) discharge points located along the perimeter of the tailings cell (discharge points 25 through 48; see Figure J-7) and three feet of freeboard were considered for this ultimate depositional phase.

For Phases 1 through 4 above, a pool volume equal to 847,655 ft³ was assumed in order to provide a minimum water head of 10 feet for pump operations.

Results of the *GoldTail* depositional modeling simulation, where the sequence of the tailings deposition can be appreciated, are illustrated in Figures J-2 through J-7. A perspective view of Tailing Cell A at the end of each phase is shown in Figure J-8. Table J-1 summarizes the discharge volumes at each discharge point for the various phases.

REFERENCES

- Barrientos, M., and Barrera, S. 2008. "*Modeling of a tailings impoundment raising.*" Golder Associates S.A., Santiago.
- Barrientos, M., Mussé, M., Eldridge, T., and Pinto, M. 2008. "*Management tools for tailing impoundment modeling.*" Golder Associates S.A., Santiago.
- Golder Associates S.A. 2008. "*Herramienta Para El Modelamiento De Depósitos De Relaves, Manual Del Usuario.*" (Spanish). *GoldTail*, Version 1.17, Rev. A. March.

**TABLE J-1
CALCULATED TAILINGS VOLUMES**

Phase	Discharge Point	Volume (ft ³)	Cumulative Volume (ft ³)
1	1	225,378	448,535
	2	6,169	
	3	77,711	
	4	139,278	
2	5	1,395,337	6,953,708
	6	1,246,304	
	7	844,947	
	8	400,631	
	9	433,419	
	10	584,222	
	11	291,940	
	12	1,756,908	
3	13	225,378	448,535
	14	6,169	
	15	77,711	
	16	139,278	
4	17	1,395,337	6,953,708
	18	1,246,304	
	19	844,947	
	20	400,631	
	21	433,419	
	22	584,222	
	23	291,940	
	24	1,756,908	
5	25	452,474	36,555,237
	26	1,419,190	
	27	1,390,370	
	28	474,317	
	29	1,131,104	
	30	2,219,771	
	31	1,725,130	
	32	1,764,596	
	33	2,034,371	
	34	1,882,605	
	35	2,379,151	
	36	1,058,410	
	37	491,054	
	38	1,496,713	
	39	1,309,687	
	40	516,716	
41	1,204,710		
42	1,991,989		
43	2,032,452		
44	1,978,008		
45	1,150,919		
46	4,009,009		
47	1,219,823		
48	1,222,667		
Total (ft ³)			51,359,724

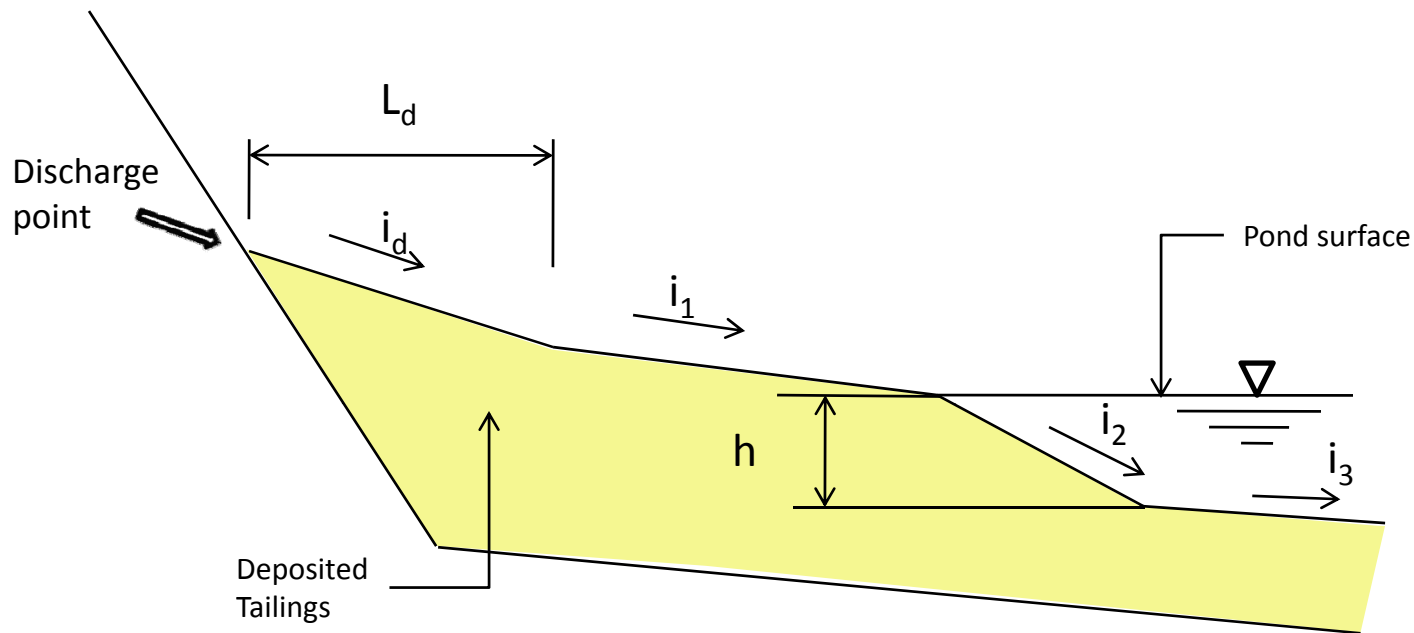

Tailings Beach Slopes

- i_d : At discharge point
- i_1 : On beach
- i_2 : Pool slope
- i_3 : Pool base
- h : Depth of pool



Denver, Colorado

TITLE

VARIABLES DEFINING TAILINGS DEPOSITION

CLIENT/PROJECT

ENERGY FUELS RESOURCES CORPORATION
 PIÑON RIDGE PROJECT - TAILINGS CELLS DESIGN
 MONTROSE COUNTY, COLORADO

DRAWN

EF

DATE

MAY 2008

JOB NO.

073-81694

CHECKED

KFM

SCALE

N.T.S.

DWG. NO.

REVIEWED

JMJ

FILE NO.

Figures-tailings.pptx

FIGURE NO.

J-1

Underdrain sump

Underdrain sump

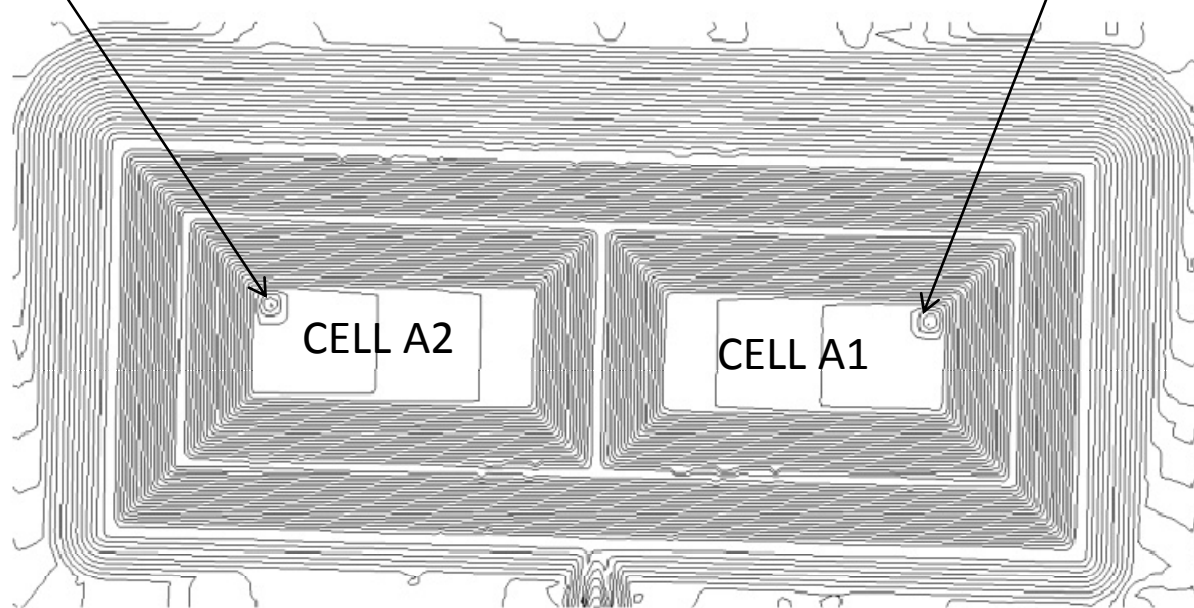

Denver, Colorado

TITLE

TAILINGS CELL A PRE-DEPOSITION GRADING PLAN

CLIENT/PROJECT

ENERGY FUELS RESOURCES CORPORATION
 PIÑON RIDGE PROJECT - TAILINGS CELLS DESIGN
 MONTROSE COUNTY, COLORADO

DRAWN EF

CHECKED KFM

REVIEWED JMJ

DATE MAY 2008

SCALE N.T.S.

FILE NO. Figures-tailings.pptx



JOB NO. 073-81694

DWG. NO.

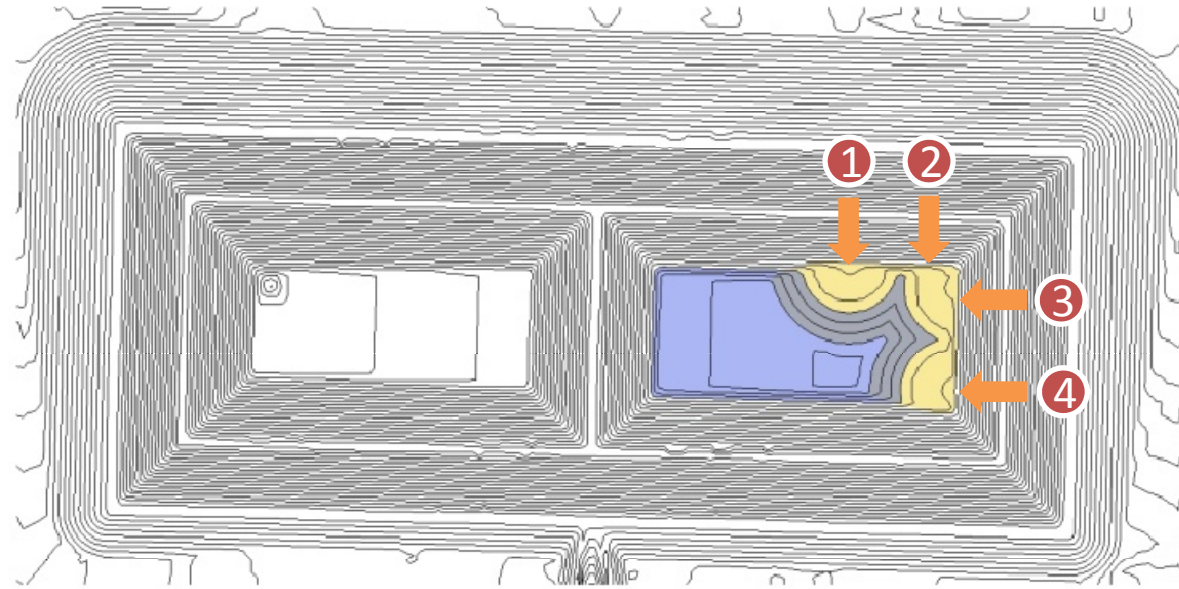
FIGURE NO. J-2



LEGEND

-  PHASE 1 DEPOSITION POINT
-  POND
-  TAILINGS



Denver, Colorado

TITLE

TAILINGS DEPOSITION PHASE 1

CLIENT/PROJECT

ENERGY FUELS RESOURCES CORPORATION
PIÑON RIDGE PROJECT - TAILINGS CELLS DESIGN
MONTROSE COUNTY, COLORADO

DRAWN

EF

DATE

MAY 2008

JOB NO.

073-81694

CHECKED

KFM

SCALE

N.T.S.

DWG. NO.

REVIEWED

JMJ

FILE NO.



Figures-tailings.pptx

FIGURE NO.

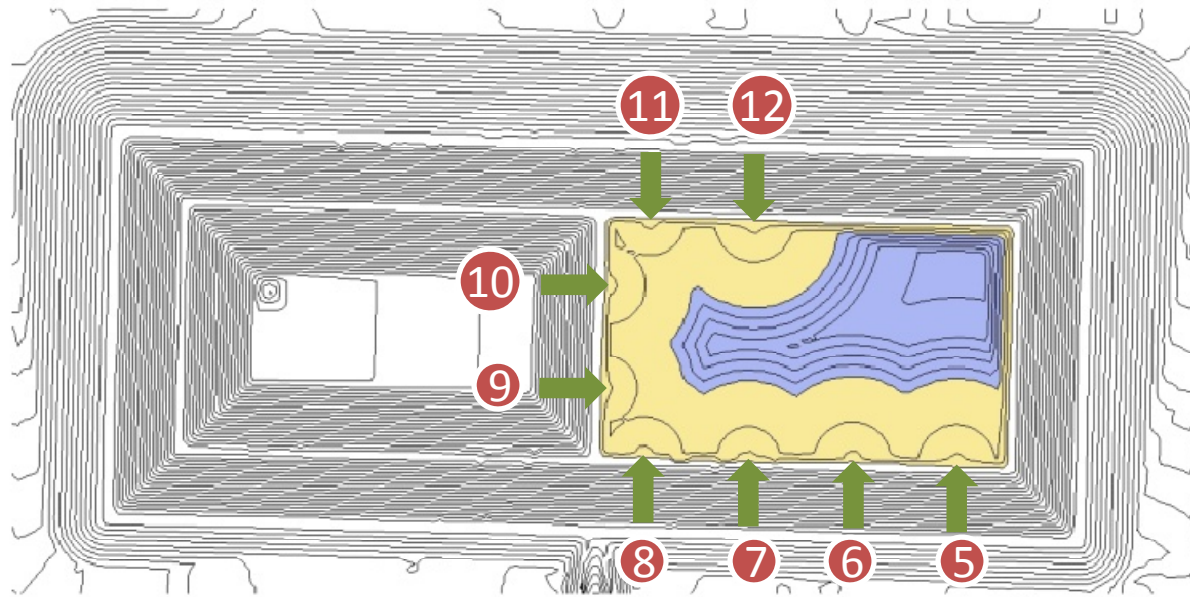
J-3



LEGEND

-  PHASE 2 DEPOSITION POINT
-  POND
-  TAILINGS



Denver, Colorado

TITLE

TAILINGS DEPOSITION PHASE 2

CLIENT/PROJECT
 ENERGY FUELS RESOURCES CORPORATION
 PIÑON RIDGE PROJECT - TAILINGS CELLS DESIGN
 MONTROSE COUNTY, COLORADO



DRAWN EF
 CHECKED KFM
 REVIEWED JMJ

DATE MAY 2008
 SCALE N.T.S.
 FILE NO. Figures-tailings.pptx

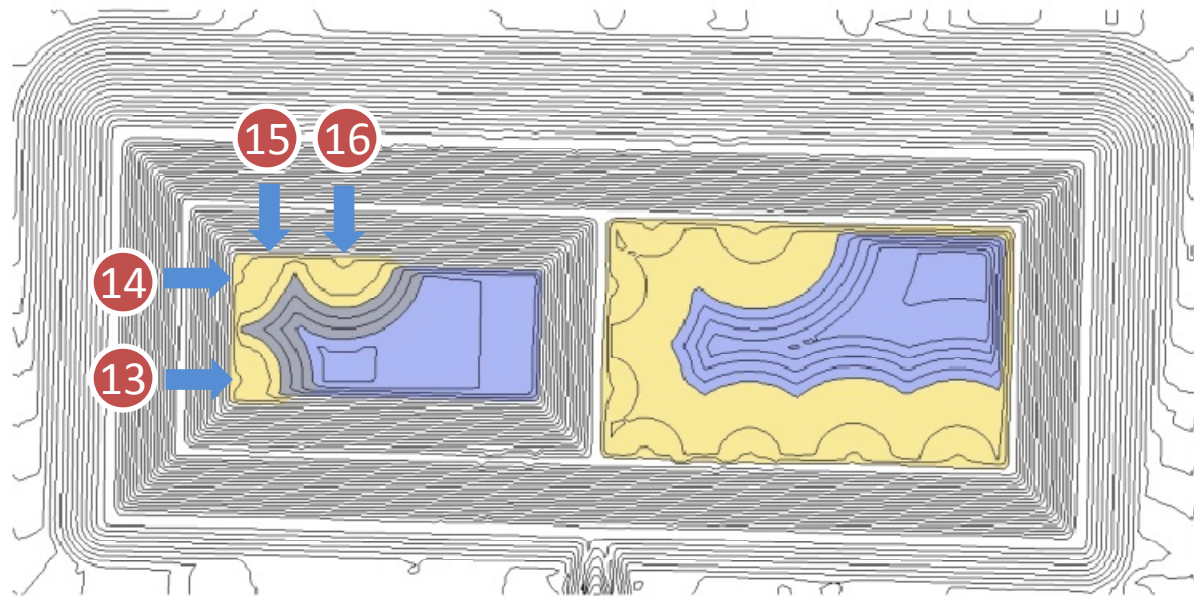
JOB NO. 073-81694
 DWG. NO.
 FIGURE NO. J-4



LEGEND

-  PHASE 3 DEPOSITION POINT
-  POND
-  TAILINGS



Denver, Colorado

TITLE

TAILINGS DEPOSITION PHASE 3

CLIENT/PROJECT

ENERGY FUELS RESOURCES CORPORATION
 PIÑON RIDGE PROJECT - TAILINGS CELLS DESIGN
 MONTROSE COUNTY, COLORADO

DRAWN

EF

CHECKED KFM

REVIEWED JMJ

DATE

MAY 2008

SCALE

N.T.S.

FILE NO.

Figures-tailings.pptx

JOB NO.

073-81694



DWG. NO.

FIGURE NO.

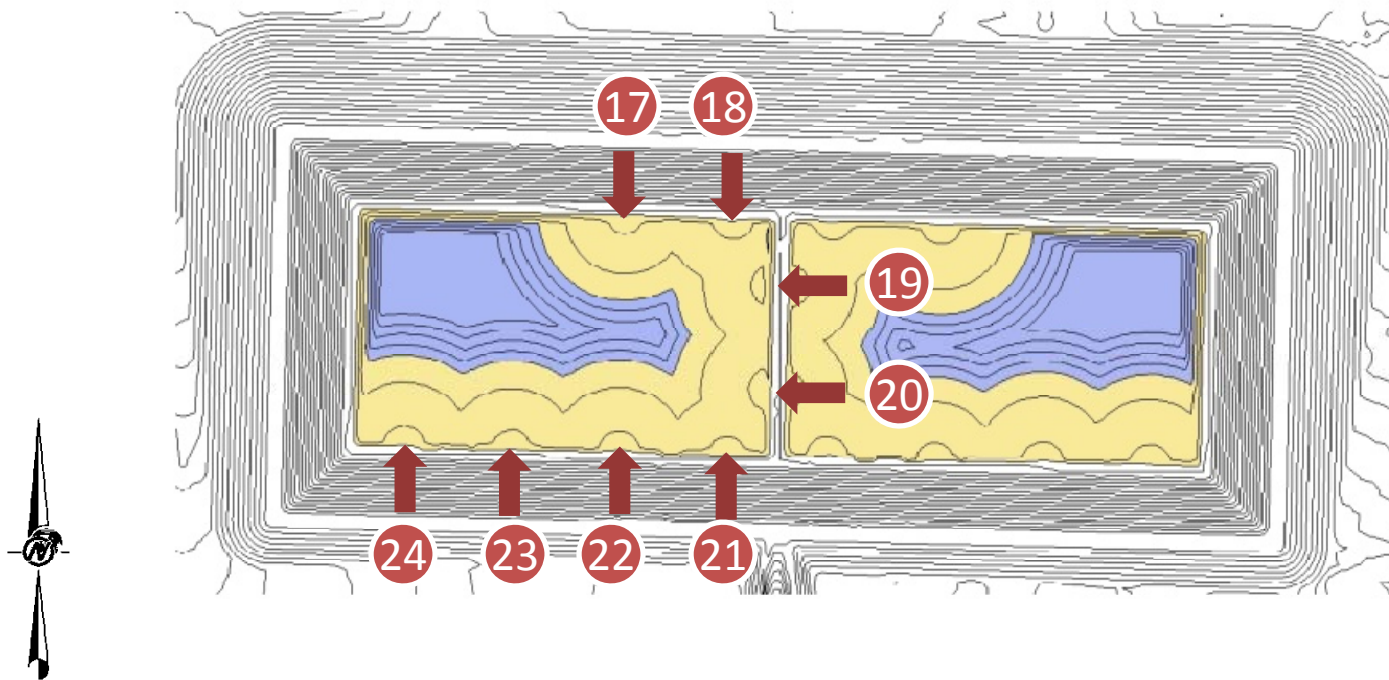
J-5



LEGEND

-  PHASE 4 DEPOSITION POINT
-  POND
-  TAILINGS



Denver, Colorado

TITLE

TAILINGS DEPOSITION PHASE 4

CLIENT/PROJECT
 ENERGY FUELS RESOURCES CORPORATION
 PIÑON RIDGE PROJECT - TAILINGS CELLS DESIGN
 MONTROSE COUNTY, COLORADO



DRAWN EF
 CHECKED KFM
 REVIEWED JMJ

DATE MAY 2008
 SCALE N.T.S.
 FILE NO. Figures-tailings.pptx

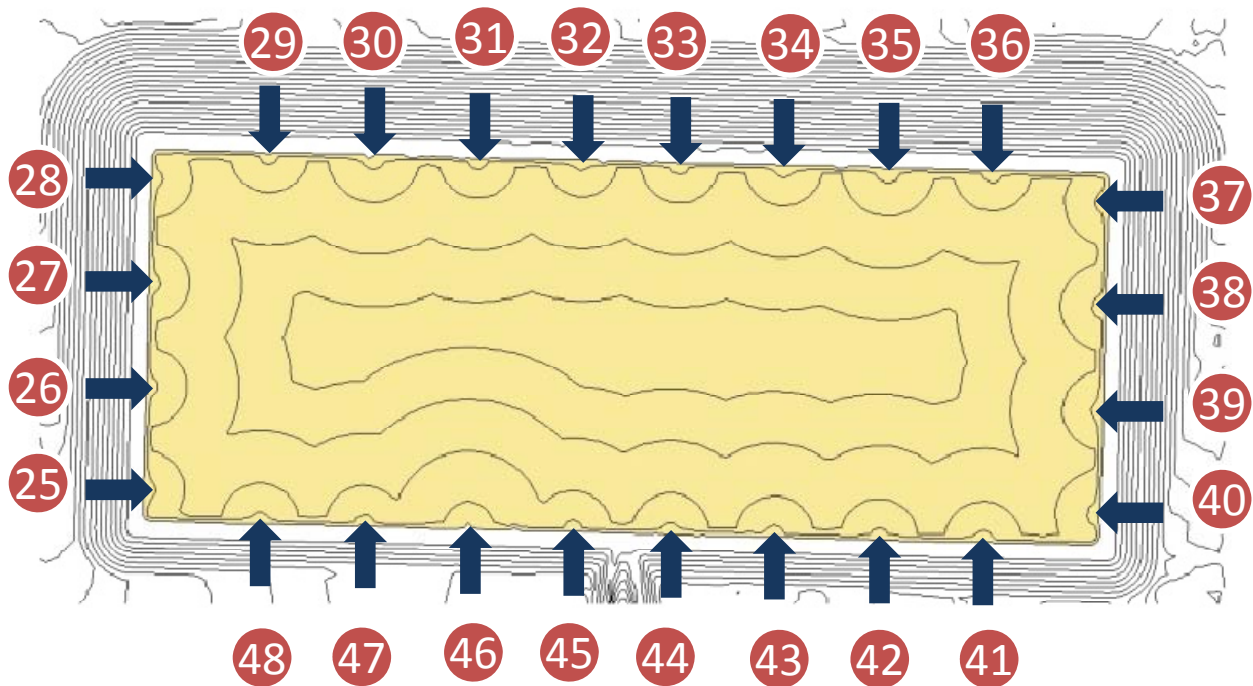
JOB NO. 073-81694
 DWG. NO.
 FIGURE NO. J-6



LEGEND

-  PHASE 5 DEPOSITION POINT
-  POND
-  TAILINGS



Denver, Colorado

TAILINGS DEPOSITION PHASE 5

CLIENT/PROJECT ENERGY FUELS RESOURCES CORPORATION
 PIÑON RIDGE PROJECT - TAILINGS CELLS DESIGN
 MONTROSE COUNTY, COLORADO

TITLE
 DRAWN EF
 CHECKED KFM
 REVIEWED JMJ

DATE MAY 2008
 SCALE N.T.S.
 FILE NO. Figures-tailings.pptx

JOB NO. 073-81694
 DWG. NO.
 FIGURE NO. J-7

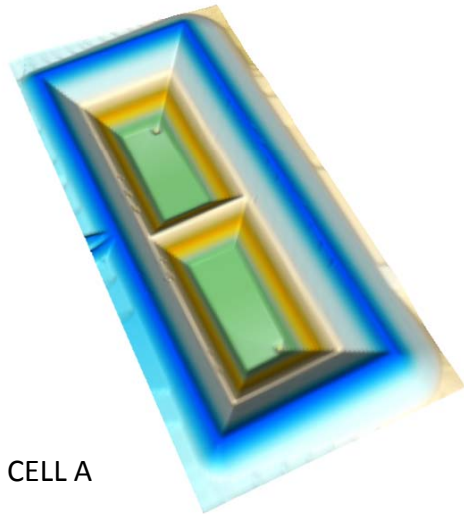

CELL A

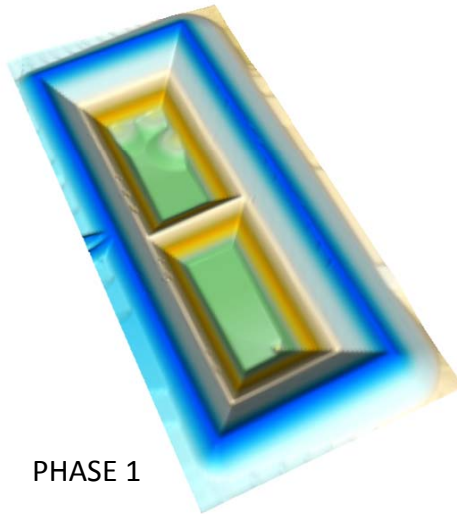

PHASE 1

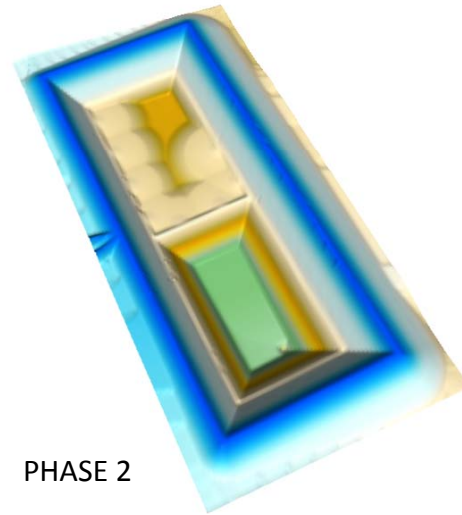

PHASE 2

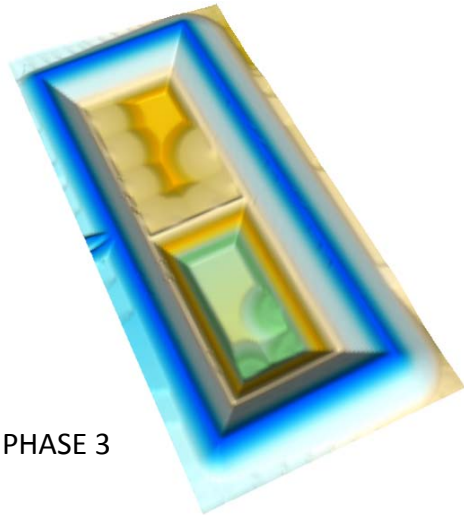

PHASE 3

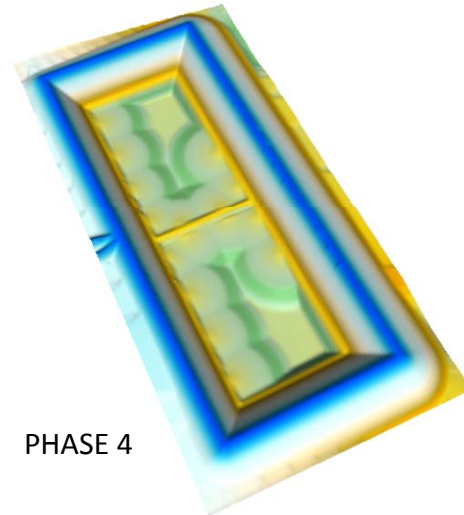

PHASE 4

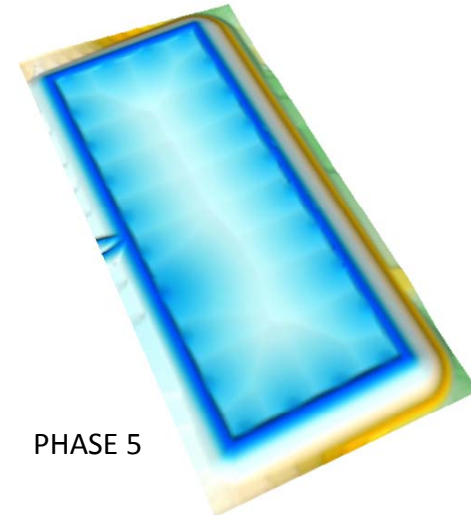

PHASE 5



Denver, Colorado

TITLE

TAILINGS DEPOSITION PERSPECTIVE VIEW

CLIENT/PROJECT

ENERGY FUELS RESOURCES CORPORATION
 PIÑON RIDGE PROJECT - TAILINGS CELLS DESIGN
 MONTROSE COUNTY, COLORADO

DRAWN

EF

DATE

MAY 2008

JOB NO.

073-81694

CHECKED KFM

SCALE

N.T.S.

DWG. NO.

REVIEWED JMJ

FILE NO.

Figures-tailings.pptx

FIGURE NO.

J-8

APPENDIX K
SITE-WIDE MASS BALANCE

APPENDIX K

SITE-WIDE MASS BALANCE

This appendix presents the results of a site-wide mass balance evaluation conducted for construction of the proposed Piñon Ridge Project facilities. The mass balance considered construction for operations, as well as eventual closure of the project, which includes construction of the tailings cell closure covers.

INTRODUCTION

The site-wide material balance considered grading (i.e., cut and fill) materials for construction of all major facilities for the Piñon Ridge Project. These facilities included:

- Mill area construction;
- Construction of Tailings Cells A through C (constructed in three phases);
- Construction of the evaporation ponds (constructed in two phases);
- Construction of the ore pads and associated dumping platform;
- Site drainage construction, including the east and west stormwater ponds;
- Roadway construction; and
- Tailings cell closure cover construction.

Only native soil materials were considered in the mass balance, i.e., roadbase, rockfill, and other imported materials were not considered.

ASSUMPTIONS

The top three inches of all cut areas were considered to be topsoil. Topsoil material may be used for ET cover material (at the discretion of Kleinfelder), but this material volume was not considered as usable fill in the material balance. The total volume of topsoil materials requiring stockpiling is 103,440 cubic yards based on 95 percent compaction during stockpile construction.

Based on laboratory test results, the in-situ soil density was assumed to be 100 pounds per cubic foot (pcf). Likewise, the compacted fill density for all materials except the interim closure cover was

assumed to be 112 pcf based on compaction to 95 percent of the standard Proctor maximum dry density (ASTM D 698). Interim closure cover was assumed to be compacted to 85 percent of the standard Proctor maximum dry density, corresponding to 100 pcf.

METHOD

In general, calculations involved adjusting all cut/fill volumes to their equivalent volumes at a density of 112 pcf. With only a few exceptions, this reduced all cut volumes and did not affect fill volumes. Once all volume quantities had a common basis, the resulting cut or fill surplus for each major structure was included in the site-wide mass balance.

An iterative approach was used to balance the cuts and fills associated with major structures and grading across the site. For instance, a previous iteration of the site-wide mass balance indicated a soil deficiency when considering construction for operations through closure of the project. As a result of this material deficiency, the tailings cell grading plan was modified, which included lowering of the tailings cells to generate additional cut materials for future use in the closure cover.

The bedrock generally slopes up to the north, so Tailings Cell A is the deepest (designed almost entirely in cut), followed by Tailings Cells B and C.

RESULTS

The final tailings cell configurations effectively balance the cut and fill quantities required for construction of the major facilities for the Piñon Ridge Project through closure of the tailings cells. The calculation presented in Appendix K-1 estimates that 50,000 cubic yards of excess material will remain available (i.e., requiring stockpiling) after closure. It should be noted, however, that an additional approximately 200,000 cubic yards of material will be available if the mill area (including ore pads) is regraded to the original topography. A flow diagram for site construction is provided as Figure K-1. The size of the soil stockpile (excluding waste materials) reaches a maximum volume of approximately 1.6 million cubic yards (based on a density of 112 pcf) after construction of Tailings Cell B. The topsoil stockpile reaches a maximum size of 100,000 cubic yards after construction of Tailings Cell C.

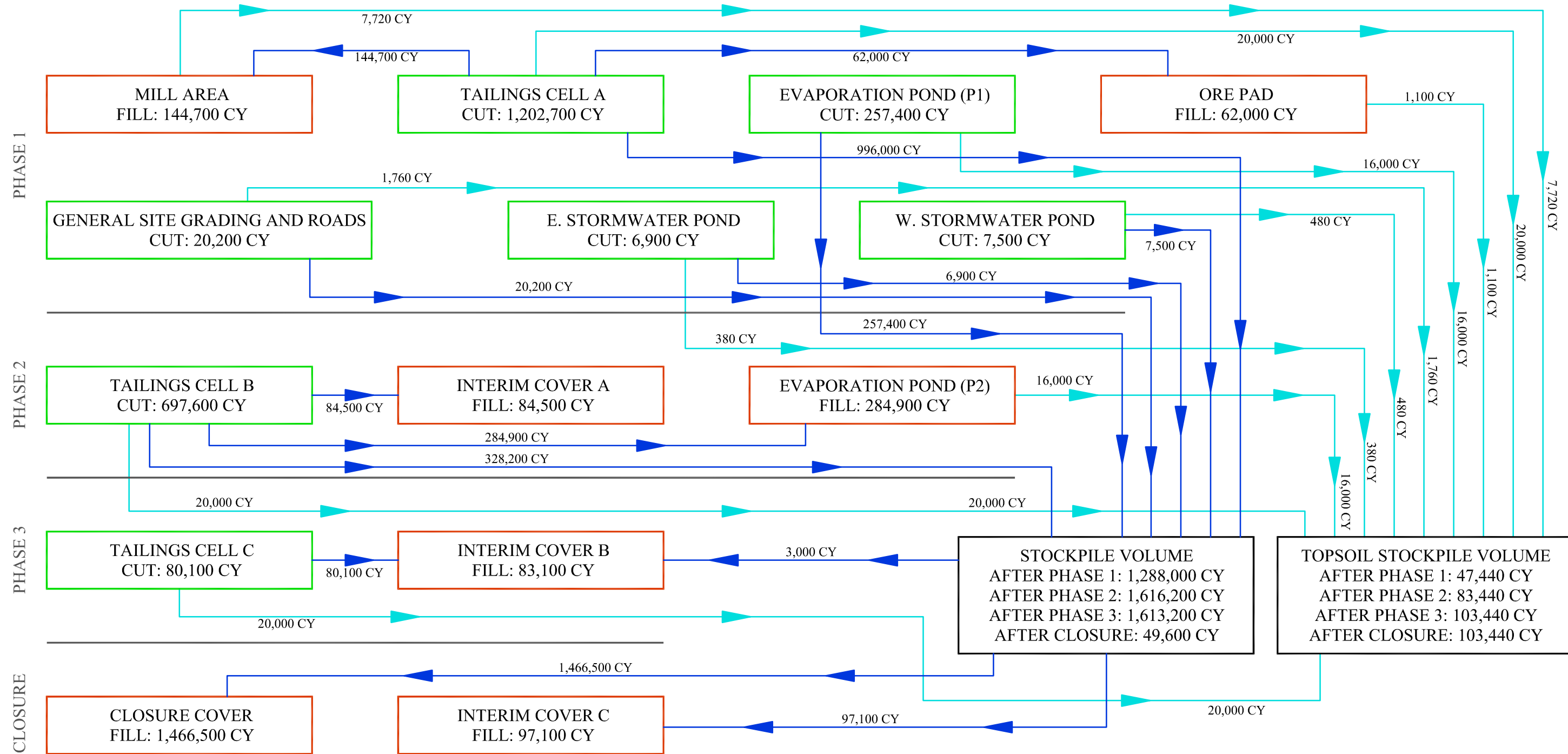

LEGEND

- EXCESS CUT AVAILABLE
- FILL REQUIRED
- ▶ FLOW LINE (CUT TO FILL)
- ▶ FLOW LINE (TOPSOIL)
- PHASE DIVISION

NOTES

1. ALL QUANTITIES SHOWN HAVE BEEN ADJUSTED TO THE EQUIVALENT COMPACTED VOLUMES, ASSUMING NATIVE MATERIAL WITH A DENSITY OF 100 PCF AND COMPACTED MATERIAL WITH A DENSITY OF 112 PCF. INTERIM COVER FILL IS ASSUMED TO BE PLACED AT 100 PCF.
2. MASS BALANCE DEVELOPED ONLY FOR USE OF ON-SITE SOIL SOURCE MATERIALS. IMPORTED MATERIALS ARE EXCLUDED.
3. MATERIAL PROVIDED THROUGH REGRADING OF MILL AND ORE PAD AREAS AT CLOSURE HAS NOT BEEN ACCOUNTED FOR.
4. TOPSOIL MATERIAL FLOWS HAVE BEEN INCLUDED AND ASSUME IN-SITU (100 PCF) DENSITY. TOPSOIL MATERIAL VOLUMES ARE NOT INCLUDED IN THE CUT/FILL VOLUMES LISTED FOR EACH FACILITY.

REV	DATE	DES	ISSUED FOR CLIENT REVIEW	JDE	KFM	JMJ
ENERGY FUELS RESOURCES CORPORATION PIÑON RIDGE PROJECT MONTROSE COUNTY, COLORADO						
SITE-WIDE MASS BALANCE DIAGRAM						
Golder Associates <small>DENVER, COLORADO</small>		PROJECT No. 073-81694 DESIGN JDE 7/08 CADD JDE 8/08 CHECK KFM 8/08 REVIEW JMJ 8/08	FILE No. FLOW DIAGRAM SCALE NTS REV. A	FIGURE K-1		

APPENDIX K-1
SITE-WIDE MASS BALANCE CALCULATIONS

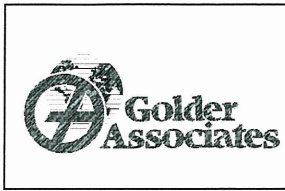

Subject	Piñon Ridge Project
Site-Wide Mass Balance	
Post Tailings Cell Regrading	

Made by	JDE
Checked by	SAU
Approved by	Kfm

Job No	073-81694
Date	08/12/08
Sheet No	1 of 2

OBJECTIVE:

Evaluate the cut and fill materials balance associated with all major proposed structures at the Piñon Ridge site for operations through closure. Materials balance conducted for general site earthworks only, and excludes materials which are anticipated to be imported.

GIVEN:

- Golder grading plans for the tailings cells, evaporation ponds, ore pads, and east stormwater pond with raw cut and fill quantities (all quantities are cubic yards)
 - Tailings Cell A¹: Cut – 1,712,000, Fill – 308,000
 - Tailings Cell B¹: Cut – 1,386,000, Fill – 522,000
 - Tailings Cell C¹: Cut – 1,270,000, Fill – 1,036,000
 - Evaporation Pond (Phase 1): Cut – 460,000, Fill – 139,000
 - Evaporation Pond (Phase 2): Cut – 174,000, Fill – 426,000
 - One-Acre Ore Pad: Fill – 8,300
 - Five-Acre Ore Pad: Cut – 1,100, Fill – 16,700
 - Ore Dumping Platform and Ramps: Fill – 18,400
 - Cushion Material (Five-Acre Ore Pad): Fill – 18,600
 - East Stormwater Pond: Cut – 8,400, Fill – 300
- Email from Dave Adams of Kleinfelder on 23 July 2008 (cut quantities omit top 3 inches of material which is considered waste)
 - West Stormwater Pond: Cut – 9,333, Fill – 842, Waste – 481
 - Mill Area: Cut – 33,371, Fill – 174,519, Waste – 7,749
 - Roadways: Cut – 35,197, Fill – 9,684
- Memorandum from Alan Kuhn of Kleinfelder on 9 July 2008
 - Interim Closure Cover (Tailings Cell A): Fill – 94,560
 - Interim Closure Cover (Tailings Cell B): Fill – 93,110
 - Interim Closure Cover (Tailings Cell C): Fill – 108,800
 - Closure Cover: 1,466,530
 - Radon Barrier (Cell A): Fill – 362,640
 - Radon Barrier (Cell B): Fill – 356,520
 - Radon Barrier (Cell C): Fill – 428,650
 - ET Cover (All Cells): Fill – 318,720

ASSUMPTIONS:

- The upper 3 inches of all cut areas is considered waste and is unsuitable for use as fill material
- Average in-situ soil density is 100 pounds per cubic foot (pcf)
- Average compacted dry density for all materials except the interim closure cover is 112 pcf (assumes 95% compaction based on Standard Proctor maximum dry density)
- Interim closure cover dry density is 100 pcf (assumes 85% compaction based on Standard Proctor maximum dry density)

¹ Quantities include rock excavation

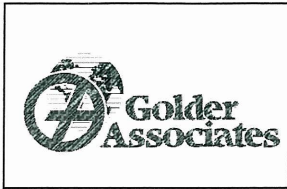

Subject	Piñon Ridge Project
Site-Wide Mass Balance	
Post Tailings Cell Regrading	

Made by	JDE
Checked by	<i>SAO</i>
Approved by	<i>AKM</i>

Job No	073-81694
Date	08/12/08
Sheet No	2 of 2

METHOD:

All cut and fill volumes were adjusted to account for waste and density differences (i.e., when 100 pcf in-situ material is compacted to 112 pcf, the volume is reduced). This was done by adjusting all quantities to an equivalent volume at 112 pcf. The adjusted cut and fill volumes were then compared for each structure and the differences were summed.

RESULTS:

This analysis indicates that there will be an excess of 50,000 cubic yards of fill material. Excess cut generated during Tailings Cell construction will be slightly more than enough for construction of the cover material at closure. Figure 1 shows a flow diagram of the cuts and fills throughout the construction process.

REFERENCES:

Golder Associates Inc. (Golder). 2008. Design drawings current as of July 2008.

Kleinfelder, Inc. (Kleinfelder). 2008a. Email from Dave Adams, *RE: Piñon Cut/Fill Quantities*. 23 July 2008.

Kleinfelder, Inc. (Kleinfelder). 2008b. Memorandum from Alan Kuhn, *Piñon Ridge Mill Volume Estimate for Earthwork, Rock and Vegetation for Closure*. 9 July 2008.

ATTACHMENT 1

CUT/FILL BALANCE CALCULATIONS

Average in-situ dry density	100 pcf
Average compacted dry density ⁽¹⁾	112 pcf
Interim cover dry density ⁽²⁾	100 pcf

Notes:

-
- (1) Assumes 95 percent of standard Proctor maximum dry density
(2) Assumes 85 percent of standard Proctor maximum dry density
(3) The above densities are based on averages of the laboratory data presented below

Standard Proctor Results

ID	Maximum Dry Density (pcf)	95% MDD (pcf)	85% MDD (pcf)
GA-TP-01 @ 5-10'	116.5	110.7	99.0
GA-TP-02 @ 2-6'	119.0	113.1	101.2
GA-TP-03 @ 4-9'	118.8	112.9	101.0
GA-TP-04 @ 2-5'	117.0	111.2	99.5
GA-TP-04 @ 5-10'	120.4	114.4	102.3
GA-TP-05 @ 0-9.5'	118.1	112.2	100.4
GA-TP-07 @ 1.5-9'	116.9	111.1	99.4
GA-TP-09 @ 1-11'	116.9	111.1	99.4

In-Situ Dry Density from Initial State of Undisturbed Triaxial Tests

ID	Initial Dry Density (pcf)
GA-BH-42 @ 10-11'	83.8
GA-BH-47 @ 2-3.5'	89.9

In-Situ Dry Density from Natural Moisture Content Testing

ID	Initial Dry Density (pcf)
GA-BH-01	100.4
GA-BH-03	95.5
GA-BH-03	98.6
GA-BH-06	100.9
GA-BH-06	116.4
GA-BH-08	107.3
GA-BH-08	98.6
GA-BH-08	81.1
GA-BH-12	135.6
GA-BH-14	84.6
GA-BH-16	99.6
GA-BH-23	98.6
GA-BH-35	92.5
GA-BH-40	96.5
GA-BH-40	99.5
GA-BH-48	89.3
GA-BH-48	94.0
GA-BH-27	99.2
GA-BH-33	116.6
GA-BH-42	114.0
GA-BH-42	83.8
GA-BH-42	109.6
GA-BH-42	99.0
GA-BH-41	106.8
GA-BH-41	113.0
GA-BH-41	98.8
GA-BH-47	89.9

Raw Quantities

Structure	Total Cut (CY)	CUT less waste(CY) ⁽¹⁾	FILL (CY)
Tailings Cell A	1,712,000	1,692,000	308,000
Tailings Cell B	1,386,000	1,366,000	522,000
Tailings Cell C	1,270,000	1,250,000	1,036,000
Evaporation Pond (P1)	460,000	444,000	139,000
Evaporation Pond (P2)	174,000	158,000	426,000
Ore Pad ⁽²⁾	1,100	0	62,000
Mill Area	41,120	33,400	174,500
East Stormwater Pond	8,400	8,020	300
West Stormwater Pond	9,810	9,330	840
General Site Grading and Roads	35,200	33,440	9,700
Interim Cover (Cell A)	0	0	94,600
Interim Cover (Cell B)	0	0	93,100
Interim Cover (Cell C)	0	0	108,800
Closure Cover	0	0	1,466,530

NOTES

(1) Topsoil is considered waste and is assumed to be the upper 3 inches of cut. Tailings cells assume 3 inches of waste over 50 acres each, and evaporation ponds assume 3 inches of waste over 40 acres for each phase. Waste generated from general site grading and roads is assumed to be 5 percent of the total cut.

(2) Includes 1-acre ore pad, 5-acre ore pad, ore dumping platform, and cushion fill

(3) Quantities are not adjusted for shrinkage/swelling

Adjusted Quantities

Area	Adj. Cut (CY)	Adj. Fill (CY)	Adj. Excess Cut (CY) ⁽¹⁾	Stockpile (CY)	Waste ⁽⁵⁾ (CY)
Tailings Cell A	1,510,714	308,000	1,202,714	1,202,714	20,000
Tailings Cell B	1,219,643	522,000	697,643	1,900,357	20,000
Tailings Cell C	1,116,071	1,036,000	80,071	1,980,429	20,000
Evaporation Pond (P1)	396,429	139,000	257,429	2,237,857	16,000
Evaporation Pond (P2)	141,071	426,000	-284,929	1,952,929	16,000
Ore Pad ⁽²⁾	0	62,000	-62,000	1,890,929	1,100
Mill Area	29,821	174,500	-144,679	1,746,250	7,720
East Stormwater Pond	7,161	300	6,861	1,753,111	380
West Stormwater Pond	8,330	840	7,490	1,760,601	480
General Site Grading and Roads	29,857	9,700	20,157	1,780,758	1,760
Interim Cover (Cell A)	0	84,464	-84,464	1,696,294	0
Interim Cover (Cell B)	0	83,125	-83,125	1,613,169	0
Interim Cover (Cell C)	0	97,143	-97,143	1,516,026	0
Closure Cover	0	1,466,530	-1,466,530	49,496	0
			Excess Fill Available	49,496	103,440
			Additional Cut Required	0	

NOTES

- (1) Topsoil is considered waste and is assumed to be the upper 3 inches of cut
- (2) Includes 1-acre ore pad, 5-acre ore pad, ore dumping platform, and cushion fill
- (3) Cut quantities have been adjusted to equivalent in-place (compacted) volumes based on an average density of 112 pcf
- (4) Interim cover fill quantities (compacted at 100 pcf) have been adjusted to an equivalent volume of 112 pcf material
- (5) Waste can be used for ET cover