



# UNITED STATES ENVIRONMENTAL PROTECTION AGENCY

REGION 6  
1445 ROSS AVENUE, SUITE 1200  
DALLAS, TX 75202-2733

3/18/2015

## MEMORANDUM

**SUBJECT:** Request for Approval of an Amended Time-Critical Removal for M6 and CBI Propellant at the Explo Systems, Inc. Site, Minden, Webster Parish, Louisiana

**FROM:** Ronnie Crossland, Associate Director *Ronald D Crossland*  
Prevention and Response Branch, Superfund Division (6SF)

**TO:** Carl E. Edlund, P.E., Director  
Superfund Division (6SF)

### 1. PURPOSE

This memorandum requests approval for an amended Time-Critical Removal Action pursuant to the Comprehensive Environmental Response, Compensation and Liability Act (CERCLA), as amended, 42 U.S.C. §§9601 *et seq.*, at the Explo Systems Inc. Site located near Minden, LA. The action includes the removal of all explosives and other hazardous materials stored on the Camp Minden Louisiana Military Department base. The conditions are rapidly deteriorating and the Time-Critical Removal Action, insofar as the M6 propellant and Clean Burning Igniter is concerned, needs to be initiated and completed as soon as possible.

On October 28, 2014, a Time Critical Removal Action Memorandum was signed that provided the basis for action by private companies (General Dynamics, Hercules, and ATK) to conduct removal actions for material that they owned and for the Louisiana Military Department to conduct Removal Actions on the M6 and CBI that they owned. Also on October 28, 2014, the United States Army (Army), the Louisiana Military Department (LMD), the Louisiana Department of Environmental Quality (LDEQ) and EPA Region 6 signed an Administrative Order on Consent (AOC) that includes payment for, and the conduct of removal response actions needed to dispose of 15-16 million pounds of M6 propellant and 320,000 pounds of Clean Burning Igniter (CBI).

This amendment documents new information regarding alternative methods to destroy the M6 and CBI onsite. This information was identified through a process that strongly involved members of the community, and the State of Louisiana. This amendment makes it possible to use technologies in addition to what was previously proposed for onsite destruction. This amended action memorandum does not modify the removal action selections governing the clean-up of explosives and materials by General Dynamics-OTS, Alliant Techsystems, Inc. and Hercules.

This action meets the criteria for initiating a removal action under the National Contingency Plan (NCP), 40 CFR §300.415.

## II. SITE CONDITIONS AND BACKGROUND

CERCLIS NO: LAR000072223  
Category of Removal: Time - Critical  
Site ID: #A6GH  
Latitude: 32.549683° N,  
Longitude: - 93.411066° W

### A. Site Description

#### 1. Removal Site Evaluation

The Site is located on Camp Minden, formerly known as the Louisiana Army Ammunition Plant (LAAP). The LAAP was established in 1942 and its' primary function was to load, assemble, and pack munitions, and manufacture ammunition metal parts. Burning and demolition activities were also performed to destroy explosives and explosive wastes generated by manufacturing of munitions. The Camp Minden Property is now under the control of the Louisiana Military Department (LMD) and serves as a training base of the Louisiana Military Department and Louisiana National Guard. Explo Systems, Inc. leased a portion of Camp Minden from the State of Louisiana designated as "S-line." S-line occupies approximately 110 acres of the 14,995 acres of Camp Minden. The Site includes the areas of Camp Minden where Explo conducted operations and stored explosives; specifically, S-Line and the magazine storage areas designated as L-1, L-2, L-3, and L-4, which encompass approximately 216, 218, 276, and 57 acres, respectively.

LAAP was placed on the National Priorities List (NPL) on March 13, 1989, based on soil, surface water, and ground water contaminated with trinitrotoluene (TNT) and other explosives. Construction of all NPL remedies was completed September 30, 2010. The operation at Explo Systems is unrelated to the contamination that led to the NPL listing. The NPL designation occurred in 1989, prior to Explo's demilitarization contracts that generated the explosive materials currently located at Camp Minden.

On or about January 1, 2005, the United States Army (Army) transferred ownership of the LAAP to the State of Louisiana. The LMD was designated to accept the property on behalf of the State of Louisiana. The property was re-named Camp Minden, Louisiana. The LMD is authorized by the State of Louisiana to lease the State's real property at Camp Minden. The LMD entered into leasing agreements with Explo Systems, Inc. (Explo), which allowed Explo to use a portion of the property, certain magazines, and buildings to perform activities required under various demilitarization contracts between Explo and the Army and other private corporations.

Explo operated under several contracts with the Army (i.e., November 16, 2006 and March 24, 2010) or subcontract agreements with parties such as General Dynamics-OTS (i.e., August 28, 2008 and March 4, 2012) for the demilitarization or dismantling of munitions. One

process included the dismantling of 750 lb. and 2,000 lb. bombs and recovering the enclosed explosives, the metals found in the bombs, and other materials used for packing and transport of the weapons or charges. Explo also demilitarized 155mm Propelling Charges (D533 Charge, Propelling 155 M119A2/ammunition used in howitzers) under a direct contract with the Department of Defense. Demilitarization of the 155mm Propelling Charges is the origin of the M6 propellant improperly stored by Explo Systems. The improper storage of the M6 propellant and other explosive materials resulted in an explosion at the Site.

On 15 October 2012, a magazine containing approximately 124,190 lbs. of black powder and a tractor trailer containing 42,240 lbs of M6 propellant exploded. A magazine is an earth covered structure built to store ammunition and explosives. The explosion shattered windows in Minden, LA, 4 miles away and generated a 7,000-foot mushroom cloud. The explosion completely destroyed the magazine and trailer containing the material, damaged 11 railcars, and released unburned M6 propellant over ¼ mile from the site of the explosion requiring remediation. Explo contracted an explosives contractor to remediate the area and LMD and LSP provided oversight.

On 27 November 2012, the Louisiana State Police (LSP) executed a search warrant at the Explo Systems site and identified approximately 10 million lbs. of improperly and illegally stored M6 propellant and other explosives. M6 propellant was stored in 60 lb. paper boxes, 100-140 lb. paper drums/barrels, and 880 lb. super sacks throughout the buildings, hallways, and outside the facility where it was exposed to the elements (i.e. heat, wind, and rain). From November 2012 to May 2013, Explo Systems employees, under the direction of LSP, relocated approximately 10 million lbs. unsecured M6 propellant and other explosives into storage magazines at Camp Minden. (Approximately 5 million lbs. of M6 propellant was already stored within the storage magazines.)

Total estimated hazardous and/or explosive materials stored within the storage magazines and at the Explo Site at Camp Minden:

- 15-16 million lbs. of M6 propellant
- 320,000 lbs. of Clean Burning Igniter (CBI)
- 1.817 million lbs. of an aluminum/TNT mixture, from processed Tritonal
- 661,000 lbs. of Nitrocellulose
- 128 lbs. of black powder
- 200 lbs. of Composition H6
- Four 50-gallon drums of ammonium perchlorate
- Two 50-gallon drums and 3-50 lb. boxes of Explosive D (ammonium picrate)
- 109,000 lbs. of M30 propellant
- Small volume of Red Water (water contaminated with TNT)
- Effluent associated with the Super Critical Water Oxidation Unit (SCWO)

The inventory listed above was initially provided to the LMD by Explo Systems, Inc.,

and later modified by a representative from the U.S. Army Technical Center for Explosives Safety (USATCES) during Technical Assistance Visits (TAV) performed at the Explo Site, and documented by April 18, 2013, and June 20, 2013, Reports. Overall, approximately 18,000,000 pounds of M6 propellant and other explosives were stored within 97 magazines (currently 92) at Camp Minden that required removal and disposal. While magazines are the safest place to store the explosives, the magazines are not in good condition. The magazines are deteriorating which increases the risk of an explosion. Currently, extensive and intrusive vegetation on the tops and sides of the magazines is impacting the structural integrity of the magazines allowing the intrusion of moisture into the magazines.

## 2. Physical Location

The Site encompasses S-Line, located at 1600 Java Road, Minden, LA 71055-7924, and the magazine storage areas L-1, L-2, L-3, and L-4 within the boundaries of Camp Minden. The site encompasses approximately 877 acres. On Camp Minden, there are two other companies with operations similar to Explo Systems. Java Road is the northern boundary of the Explo Systems lease. The remaining areas that border the Explo facility consist of undeveloped forested land. The town of Doyline, with an estimated population of 800 people, is located less than 4,000 feet south of the Explo facility. A railroad switching and storage yard is approximately 500 feet to the northwest of the Site. Paved roads and tank trails traverse Camp Minden. While Camp Minden is fenced and patrolled by on-duty National Guardsmen, deer hunting is allowed by permit on the base. The Louisiana Military Department Youth Challenge Program (school) and the Webster Parish Prison are also located on Camp Minden. Should a magazine of explosives detonate, the level of potential risk to the facilities, activities, and personnel at Camp Minden is dependent upon the location of the specific magazine and the exact proximity of the population or facility at the time of the explosion.



Data use subject to license  
© DeLorme, XMap® 6  
www.delorme.com

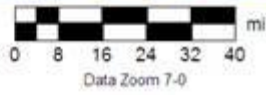



### 3. Site Characteristics

The facility at Camp Minden that Explo leased from LMD is called S-Line and like most of the buildings at Camp Minden, it was built in the 1940s. The various buildings within S-line were designed for various manufacturing processes, labs, and loading areas. The buildings were separated with the intent of separating explosives process areas from each other and ultimately controlling the propagation of an explosion. Long enclosed hallways connect the individual buildings allowing the movement of the hazardous and/or explosive materials to remain indoors. Several of the buildings are protected by engineered berms designed to mitigate and stop the propagation of a potential explosion. S-Line was designed for explosives manufacturing and utilized by Explo for demilitarization and processing of explosive materials. Storage of explosives at S-Line, other than material currently in process, violated State and Federal Statute.

The processing equipment at S-Line consists of an aluminum crushing line, two sets of bomb demilitarization equipment (for 750 lb. and 2,000 lb. bombs), a melt-pour to extract the TNT from the demilitarized bombs, and a heating process for extracting TNT from Red Water.

During the action overseen by the Louisiana State Police, Explo moved the unsecured explosives (discovered on November 27, 2012) to explosive storage magazines. Explosives from Explo occupied 97 magazines at Camp Minden, currently 92 magazines. The magazines storing the explosives are located in explosive storage areas known as L-1, L-2, L-3, and L-4. Three configurations of explosives magazines exist at Camp Minden. Each magazine holds a maximum of 125,000 lbs. or 300,000 lbs. of explosives, depending on the configuration of the magazine, the type of packaging, and type of explosives stored within each magazine. The magazines are deteriorating which increases the risk of an explosion. Currently, extensive and intrusive vegetation on the tops and sides of the magazines is impacting the structural integrity of the magazines allowing the intrusion of moisture into the magazines.



Explo Systems, Inc.,  
S-Line, Camp Minden



Magazine Area

4. Releases or Threatened Release into the Environment of a Hazardous Substance, Pollutant or Contaminant

Approximately 18,000,000 pounds of explosives were abandoned by Explo at the Site. The types of explosive materials include: M6 propellant, clean burning igniter (CBI), Tritonal, M30 propellant, H6, nitrocellulose, ammonium picrate, and black powder. Each of the explosive materials stored at the Site are classified as toxic through dermal absorption, ingestion, and inhalation.

The M6 propellant is a mixture of nitrocellulose, dinitrotoluene, dibutylphthalate, and diphenylamine. This mixture, primarily due to the nitrocellulose is extremely reactive and is characteristic hazardous waste, D003, as defined by 40 CFR §261.23. Dinitrotoluene and dibutylphthalate are listed hazardous substances under 40 CFR §302.4. Dinitrotoluene is also a characteristic hazardous waste, D030, under 40 CFR §261.24. According to 40 CFR §261.21, the characteristic of ignitability is defined as, “Ignitable wastes can create fires under certain conditions, are spontaneously combustible, or have a flash point less than 60 °C (140 °F)” Nitrocellulose has a flash point of 12 °C (53 °F). Nitrocellulose alone or in the mixture of M6 propellant can auto-ignite or spontaneously combust, also defined under the characteristic of ignitability. The diphenylamine is a stabilizer. Characteristic hazardous waste are hazardous substances under CERCLA Section 101(14), 42 U.S.C. § 9601(14).



The CBI is a mixture of nitrocellulose and diphenylamine. CBI does not contain dinitrotoluene. This mixture, primarily due to the nitrocellulose is extremely reactive and is characteristic hazardous waste, D003, as defined by 40 CFR §261.23. Dibutylphthalate is a listed hazardous substances under 40 CFR §302.4. According to 40 CFR §261.21, the characteristic of ignitability is defined as, “Ignitable wastes can create fires under certain conditions, are spontaneously combustible, or have a flash point less than 60 °C (140 °F)” Nitrocellulose has a flash point of 12 °C (53 °F). Nitrocellulose alone or in the mixture of CBI propellant can auto-ignite or spontaneously combust, also defined under the characteristic of ignitability. The diphenylamine is a stabilizer. Characteristic hazardous waste are hazardous substances under CERCLA Section 101(14), 42 U.S.C. § 9601(14).

Reactivity or exhibiting reactive characteristics is defined in 40 CFR §261.23 as “unstable under "normal" conditions. Reactive materials can cause explosions, toxic fumes, gases, or vapors when heated, compressed, or mixed with water.” M6 propellant and CBI are “unstable under ‘normal conditions.’” Specifically, M6 propellant and CBI can auto-ignite or combust spontaneously due to their inherent chemical properties.

Hazardous substances are designated in Section 101(14) of CERCLA, 42 U.S.C. §9601(14) and 40 CFR §302.4.

#### 5. NPL Status

LAAP was placed on the National Priorities List (NPL) on March 13, 1989, based on soil, surface water, and ground water contaminated with trinitrotoluene (TNT) and other explosives. Construction of all NPL remedies was completed September 30, 2010. The operation at Explo Systems is unrelated to the contamination that led to the NPL listing.

An Assessment to determine if the Explo Systems Inc. Site qualifies for the NPL or if the Site poses a threat to ongoing NPL site remediation activities is still underway.

#### 6. Maps, Pictures and Other Graphic Representations

Attachment 1 Enforcement Attachment

Attachment 2 Material Safety Data Sheet for M6 Propellant.

Attachment 3 Material Safety Data Sheet for Clean Burning Igniter (CBI)

Attachment 4 Military Explosives, Department of the Army Technical Manual.

Attachment 5 Handbook on the Management of Munitions Response Actions, EPA OSWER, Interim Final.

Attachment 6 Ammunition Handbook: Tactics, Techniques, and Procedures for Munitions Handlers, Department of the Army.

Attachment 7 Prediction of Safe Life of Propellants, Picatinny Arsenal.

Attachment 8 Propellant Management Guide, U.S. Army Defense Ammunition Center.

Attachment 9 LMD Request for Assistance from DOD and Response to Request.

Attachment 10 Explosive Safety Board reports to LMD – April & June 2013

Attachment 11 Explosive Safety Board report to LMD December 2015  
Attachment 12 Explosive Safety Board report to EPA March, 2015  
Attachment 13 LSP and LMD Incident Report – October 2012 Explosion  
Attachment 14 Site Photographs  
Attachment 15 Inventory of Camp Minden Explosive Storage Magazines – Explo Explosives

B. Other Actions to Date

1. Previous Actions

On 15 October 2012, a magazine containing approximately 124,190 lbs. of black powder and a tractor trailer containing 42,240 lbs of M6 propellant exploded. The explosion shattered windows in Minden, LA, 4 miles away and generated a 7,000-foot mushroom cloud. The explosion completely destroyed the magazine and trailer containing the material, damaged 11 railcars, and released unburned M6 propellant over ¼ mile from the site of the explosion requiring remediation. Explo contracted an explosives contractor to remediate the area and LMD and LSP provided oversight.

On 27 November 2012, LSP executed a search warrant at the Explo Systems site. LSP identified approximately 10 million lbs. of improperly and illegally stored M6 Propellant and other explosives throughout the buildings, hallways, and outside the Explo facility that were exposed to the elements (i.e. heat, wind, and rain).

From 28 November – 20 May 2013, LSP and Explo employees relocated the previously unsecured M6 Propellant (approximately 10 million lbs.) and other explosive materials within the magazines at Camp Minden. From 30 November – 7 December 2012, the town of Doyline, LA (approximately 400 homes) was evacuated during operational hours. Also, the Youth Challenge Program (school) at Camp Minden was evacuated as well as all non-essential personnel and operations at Camp Minden while the volume of unsecured M6 propellant required a minimum of a 4,000-foot safe distance, due to risk of explosion. The Webster Parish Prison at Camp Minden conducted shelter-in-place while operations to secure the explosives occurred.

While materials were being moved into the magazines, on February 5, 2013, the LMD Adjutant General formally requested assistance with the transportation and storage of the explosives associated with Explo Systems from the Secretary of Defense. That request was denied by the Secretary of the Army on May 12, 2013, citing the prohibitions for the storage, treatment, or disposal of any hazardous materials not owned by DoD in 10 USC§ 2692.

On April 2-3, 2013, at the request of the LMD, a team from the USATCES, led by the Army's Military Representative to the DoD Explosives Safety Board (DDESB) conducted a safety assessment of the hazards associated with the M6 propellant at EXPLO Systems, Incorporated at Camp Minden, LA. During May 7 to 9, 2013, the team from the USATCES and the DDESB conducted another Technical Assistance Visit (TAV), at the request of the LMD and LSP, to evaluate the explosive hazards associated with Explo Systems, including the Explo facility at "S-Line" and the storage magazines at Camp Minden. The reports generated by the

team from USATCES/DDESB included concerns about the stability of the M6 propellant due to loss of lot integrity, improper storage conditions, and lack of a stability monitoring program. The USATCES/DDESB team recommended the disposal of the propellant and other explosives by open burn/open detonation (OBOD) at Camp Minden. During a meeting on August 1, 2013, the TAV, DoD representative indicated the likelihood of a magazine explosion increases within the next 2-10 years due to instability concerns (e.g., the stability of the explosives cannot be guaranteed due to the loss of lot integrity and identity, improper storage exposing propellant to heat and moisture) associated with the explosives at the Site. Conditions in the magazines are deteriorating faster than expected which increases the risk of explosion.

On 5 August, 2013 the Bureau of Alcohol, Tobacco, Firearms, and Explosives (ATF) revoked Explo Systems, Inc. explosives licenses as a result of the indictments of Explo's management and employees by the State of Louisiana. Without a valid explosives license, Explo Systems was restricted from the control of explosives, thus impeding the handling, shipping, possessing or otherwise dealing with explosives 18 U.S.C. § 842(i).

On August 12, 2013, Explo filed for Chapter 11 Bankruptcy and the proceedings for the reorganization of the company, and reconciliation of debts is proceeding. However, on September 30, 2013, ownership of the estimated 18 million lbs. of explosives was transferred to the LMD in Bankruptcy court proceedings.

On January 30, 2014, an Administrative Settlement Agreement and Order on Consent for Removal Action (AOC) between EPA Region 6 and General Dynamics/Alliant Techsystems (ATK) went into effect. The AOC included an agreement for General Dynamics/ATK to remove and dispose of the following hazardous/explosive substances at Camp Minden:

- 200 lbs. of Composition H6
- 109, 000 lbs of M30 propellant
- All nitrocellulose in containers identified as being shipped by ATK or at ATK's direction from any ATK facility to the Site
- All Pit Powder in containers identified as being shipped by St. Mark's Powder or at St. Mark's Powder's direction from any St. Mark's Powder facility to the Site
- 1.817-2.2 million lbs. of tritonal mixed with tar/aluminum and TNT mixture and 133,836 pounds of "tritonal and tar mixture."

On March 18, 2014, EPA issued a Unilateral Administrative Order (UAO) under RCRA 7003 to the Department of the Army/DoD requiring the Army to perform a removal action on the 15-16 million lbs. of M6 propellant stored at Camp Minden.

On June 3, 2014, LDEQ issued a RCRA Order to the Army to compel them to take the necessary action at the Site.

EPA re-commenced negotiations with the Army, LMD and LDEQ on July 9, 2014. Previous attempts to negotiate an AOC with the parties were not successful. On October, 28,

2014, an AOC was agreed to and finalized by EPA, the Army, LMD and LDEQ.

On November 13, 2014, a public meeting was held in Minden. Residents and local elected officials voiced their concern about the manner in which onsite destruction was described. On December 3, the ESB conducted another Technical Assistance Visit and participated in a bench scale burn of the M6. The ESB TAV report from that visit contains recommendations for the priority of treatment or disposal of the various containers. The ESB recommended addressing the 880-pound supersacks first. The ESB stressed that the lack of a stability monitoring program could not predict the amount of time remaining for the safe handling of the M6 and CBI. They also cautioned about the aggressive proposed schedule. The ESB previously stated that the stability of the propellants could not be known after August 2015. That date of August 2015 was the initial target date to have all the M6 and CBI destroyed.

Louisiana Military Department (LMD) solicited bids from contractors to conduct onsite destruction at the Site. That solicitation began on December 8, 2014. The decision to conduct onsite destruction was included in the negotiated AOC from October 28, 2014.

On December 16, 2014, another public meeting was held in Minden. Local Residents and other interested parties opposed the manner in which onsite destruction was described. Specifically, there was concern about the amount of dinitrotoluene remaining in the emissions. Although the air dispersion model, OBODM, predicted a result of 0.000014% of the Louisiana ambient air quality standards, the discussion focused on the threat from the dinitrotoluene.

On January 14, 2015, the State of Louisiana sent a letter to EPA regarding the procedure that led to the selection of onsite destruction (controlled open burning). On January 15, 2015, EPA responded to the State of Louisiana letter and stated the AOC would be suspended 90 days to allow the State additional time to assess alternative technologies for onsite destruction. On January 29, 2015, Louisiana Military Department and LDEQ agreed that additional public input should be sought. Therefore, additional public participation (Dialogue Committee) was initiated. From February through March 2015, this public participation process identified and considered a wide range of alternative clean-up technologies. The public participation involved discussing operational information, availability, applicability, and other factors regarding destruction methods.

## 2. Current Actions

Approximately 15.6 million pounds of M6 and 320,000 pounds of CBI are currently secured within 92 explosive storage magazines at Camp Minden and are currently owned by the LMD. A stability monitoring program is not in place for the explosives stored at Camp Minden due to the safety risk of handling the potentially unstable explosives. The deterioration of the stability of the explosives continually increases the risk of auto-detonation of the explosives and a magazine explosion similar to that of October 2012.

The Dialogue Committee Facilitators submitted a report to EPA on March 12, 2015. The State is expected to consider the information as they complete the procurement of the contractor

to handle the onsite destruction of the M6 and CBI.

LMD continues to monitor the magazines to look for abnormalities that could cause concern. An additional TAV visit by the DDESB was conducted on March 9 – 11, 2015, to assess certain containers that have been damaged by moisture in the magazines.

### C. State and Local Authorities' Roles

#### 1. State and Local Actions to Date

From November 27, 2012 – May 20, 2013, LSP was the lead for directing and overseeing the relocation of unsecured explosives to the magazines by Explo employees. Based on the recommendation of the USATCES/DDESB team, the LSP disposed of approximately 16,000 lbs. of M6 propellant by open burning. The recommendation for emergency disposal was based on stability concerns of that Lot of propellant. On June 18, 2013, LSP arrested Explo Systems' managers/employees who were indicted by the Webster Parish Grand Jury for reckless handling of explosives, failure to properly mark explosives, unlawful storage of explosives, failure to obtain magazine license, failure to keep a proper inventory of explosives, and conspiracy on all counts. After the arrest and indictment of Explo Systems' employees, their explosive handling licenses with the State of Louisiana were revoked. LSP continues to support site activities in a safety and regulatory oversight role, when requested.

On February 5, 2013, the LMD Adjutant General formally requested assistance with the transportation and storage of the explosives associated with Explo Systems from the Secretary of Defense. That request was denied by the Secretary of the Army on May 12, 2013, citing the prohibitions for the storage, treatment, or disposal of any hazardous materials not owned by DoD in 10 USC§ 2692. The Army did offer the continued technical assistance of the DoD Explosives Safety Board and the U.S. Army Technical Center for Explosives Safety. On September 6, 2013, the State of Louisiana declared a State of Emergency at Camp Minden. Subsequent emergency declarations have been issued by the Louisiana State Governor's Office, maintaining the emergency declaration through March 2014. The LMD obtained ownership of the 18 million lbs. of explosives through Bankruptcy proceedings and requested funding from the National Guard Bureau to dispose of the explosives on September 12, 2013. The request for funding was denied. On October 29, 2013, the LMD submitted a Defense Support to Civilian Authorities (DSCA) Request to the DOD/U.S. Army for assistance with the removal and disposal of the explosives at Camp Minden from the Secretary of Defense. On December 10, 2013, the Secretary of the Army responded by denying the DSCA request made by LMD.

On June 3, 2014, The Louisiana Department of Environmental Quality (LDEQ) issued an Administrative Order to the Department of the Army requiring the Army to comply with the RCRA 7003 UAO issued by the EPA on March 18, 2014. The LDEQ continues to coordinate with EPA's RCRA and Superfund program.

On June 5, 2014, the LSP, in coordination with the LMD, conducted a training exercise which consumed the 128 lbs. of black powder previously owned by Explo Systems and listed on the inventory provided by the ESB.

On August 18 – 22, 2014, a contractor for LMD disposed of three 50 lb. boxes of ammonium picrate, 56 – 50 lb. buckets of TNT contaminated sludge (2,800 lbs.), and 35- 30 gallon drums of Red Water (1,050 gallons). The 2,800 lbs. of TNT contaminated sludge and the 1,050 gallons of Red Water completed the removal of the Red Water listed on the inventory provided by the ESB. LMD's contractor disposed of the materials onsite through open burning. All residue and packaging from the burning was analyzed and will be disposed of at an appropriately permitted facility. All operations were conducted in coordination with LDEQ, LSP, and EPA. A final report of the operations is pending.

General Atomics, the prime contractor to DoD, who subcontracted Explo for the testing and operation of the SCWO at Camp Minden continues to negotiate with LMD and LDEQ for the removal of the SCWO equipment and associated effluent and chemicals. The remaining four 50-gallon drums of ammonium perchlorate (solution) and two 50-gallon drums of ammonium picrate (solution) were utilized in the SCWO process by Explo and are included in the negotiations for decontamination and removal of SCWO equipment and associated chemicals. LMD and LDEQ received a draft Work Plan from General Atomics on September 5, 2014, and will coordinate with EPA as negotiations proceed.

## 2. Potential for Continued State/Local Response

On July 9, 2014, negotiations among the parties re-commenced with the goal of entering into an AOC for the disposal of the M6 and CBI. The October 28, 2014, AOC was signed by the Army, LMD, LDEQ, and EPA. The United States, on behalf of the Army, will pay for 100% of the costs to destroy the M6 propellant and CBI. The LMD agreed to perform the removal work needed to destroy the M6 propellant and CBI and dispose of the small quantities of other explosives and chemical wastes not addressed by the other two AOCs.

On June 3, 2014, The Louisiana Department of Environmental Quality (LDEQ) issued an Administrative Order to the Department of the Army requiring the Army to comply with the RCRA 7003 UAO issued by the EPA on March 18, 2014. The LDEQ continues to coordinate with EPA's RCRA and Superfund program. EPA withdrew its RCRA 7003 Order against the Army, and LDEQ also agreed to withdraw its State Order against the Army, in accordance with the terms of the October 28, 2014, AOC signed by the parties.

### **III. THREATS TO PUBLIC HEALTH OR WELFARE OR THE ENVIRONMENT, AND STATUTORY AND REGULATORY AUTHORITIES**

#### **A. Threats to Public Health or Welfare**

The current conditions at the Site meet the following factors which indicate that the Site is a threat to the public health, welfare and the environment and a removal action is appropriate under Section 300.415(b)(2) of the National Contingency Plan. Any or all of these factors may be present at the Site yet any one of these factors may determine the appropriateness of a removal action.

1. Weather Conditions that May Cause Hazardous Substances or Pollutants or Contaminants to Migrate or be Released. NCP Section 300.415(b)(2)(v)

Camp Minden consists of 14,995 acres of pine forest, including extensive overgrowth around and on the earthen covering of the magazines. The area is suffering from severe drought conditions, yet recent rains have encouraged grass growth. Thirty-two grass fires occurred on Camp Minden during 2012 that required the base's fire brigade to respond. Large pine trees and/or heavy vegetation are growing on the tops and sides of the bunkers. A lightning strike has the potential to ignite the dense vegetation and threaten one or more of the magazines. A burning cinder or spark from a nearby fire could be sufficient to ignite the explosives if it were introduced into the magazine. Also, any explosives in transport from any magazine have the potential to ignite if exposed to a lightning strike or fire in the vicinity. The impacts of the explosion of one magazine in October 2012 extended up to 4-miles from Camp Minden. Although the magazines are designed to limit the propagation of explosions, an explosion of one magazine will be felt at least 4-miles away, and the explosion of multiple magazines could affect populations beyond a 4-mile radius.

Large pine trees and/or heavy vegetation are growing on the tops and sides of the magazines. The roots from the trees and/or vegetation may have breached the concrete ceiling and walls of the magazine, and thereby compromised the structural integrity of the magazines. Compromised magazines may not function and perform as originally designed and intended. Recent observations during Site visits show that some of the magazines are exposing the explosives to excess moisture, and humidity. Compromised magazines could introduce not only excess moisture and humidity, but also heat if a fire burned the vegetation on-top or surrounding the magazines. This introduction of heat could ignite the explosives stored within the magazines. Site observations also show that these conditions are accelerating the degradation of the storage containers within the magazines.

A magazine explosion due to auto-ignition of the M6 propellant, and other explosives or ignition sources is predicted to result in damage similar to or more catastrophic than the October 2012 explosion. On October 15, 2012, the explosion of one storage magazine and a tractor trailer containing black powder and M6 propellant at the Site shattered windows in Minden, LA (approximately 4 miles northeast), and generated a 7,000-foot mushroom cloud. The explosion resulted in the complete destruction of the storage magazine containing the material, the tractor trailer parked outside the magazine, damage to 11 railcars, and the release of unconsumed M6 propellant over ¼ mile from the site of the explosion. Based upon the recommendation provided in the DoD ESB April 18, 2013, Report, a specific lot of approximately 16,000 lbs. of M6 propellant identified as unstable, was destroyed (i.e., via open burning) by the LSP.

2. Threat of Fire or Explosion. NCP Section 300.415(b)(2)(vi)

The primary threat from the M6 and CBI stored in the magazines at Camp Minden is the explosion potential. Blast/explosion models created by the USATCES/DDESB Team showed that the town of Doyline, Youth Challenge Program School, Webster Parish Prison, and Command Center for LANG at Camp Minden were within the danger zone where property damage, injury, and potential casualties were expected from the unsecured explosives at the Explo Site. The relocation of the M6 propellant into magazines mitigated the impact from a large chain-reaction explosion, but did not eliminate the threat as the explosion of a storage magazine has impacted the surrounding population, property, and environment.

The M6 and CBI processed by Explo Systems is comprised of mostly of nitrocellulose, which is subject to degradation with aging, the end result being spontaneous combustion. Chemical ingredients known as stabilizers are added to the M6 and CBI to prevent self-ignition. The stabilizers degrade or deteriorate over time and exposure to heat accelerates the degradation or deterioration of the stabilizers. For these reasons, the Army mandates a propellant stability monitoring program for propellants it owns or stores to periodically test this and similar types of propellant stability.

The USATCES/DDESB report dated April 18, 2013, stated that “the preponderance of evidence indicates that the probability of an explosives event directly related to the long-term storage of M6 propellant at Minden is likely... These factors, combined with nitro-cellulose's (sic) ability to auto-ignite, increase the probability of a detonation within a storage structure at Camp Minden.” Based on these concerns, the USATCES/DDESB Report recommended that the M6 propellant stored in the magazines undergo disposal or consumption rather than long-term storage due to stability concerns.

The second USATCES/DDESB report (dated June 13, 2013) stated that, “Low stability content can result in auto-ignition of propellant in storage, causing a detonation. At Camp Minden, Explo's operations appear to have resulted in the loss of lot identity for the M6 propellant that Explo has in storage. Explo's packaging configurations (e.g., incorrect lot markings on containers and outer-packs, multiple markings); storage procedures, which exposed some of the packaged propellant to the environment; and packaging process, which may have mixed lots led the technical assistance visit team to conclude that lot identity was, at a minimum, questionable. Explo did not have an adequate propellant stability monitoring program in place. Although the transfer of M6 propellant to earth covered storage has reduced the risk to public safety, an explosive event (i.e., a detonation) from auto-ignition is very possible without a propellant stability monitoring program in place to track the propellant's stabilizer content and address potentially unstable propellant.”

As stated in the U.S. Army publication titled *Prediction of Safe Life of Propellants*, “...artillery propellants are subject to degradation with aging, the end result being spontaneous ignition.” As propellant ages, the stabilizers in the propellants decrease. According to The U.S. Army Defense Ammunition Center's *Propellant Management Guide*, “Stabilizers are chemical



ingredients added to propellant to prevent auto-ignition during the propellant's expected useful life." Exposure to heat accelerates the decrease of stabilizer. The improper storage practices of the M6 propellant at the Explo Site exposed the propellant to heat and weathering that increased the reduction of stabilizer in the material. According to the *Propellant Management Guide*, "nitrate ester-based propellants (principally nitrocellulose-based ones) have the propensity to self-ignite (auto-ignite) without warning while in static storage; catastrophic losses can result," with low percentage of stabilizer.

The stability monitoring program employed by Explo was inadequate according to the USATCES/DDESB Reports. Due to the mixing of the "Lots" assigned to the M6 propellant by Explo Systems, Inc., per the U.S Army's Propellant Monitoring Program detailed in the *Propellant Management Guide*, Explo cannot adequately predict the degradation of the propellant by Lot Number. The *Prediction of Safe Life of Propellants* states that, "the measurement of residual stabilizer content offers the best means of establishing the stability potential of these materials." The USATCES/DDESB team recommended reinstatement of a Propellant Stability Program of the M6 Propellant to predict stability issues within the 15 million lbs. of M6 propellant stored at Camp Minden. The stability cannot be guaranteed unless the explosives are tested.

Due to the need to secure the explosives within magazines in order to reduce the explosive potential and risk to the public, the LSP and Explo Systems stored the maximum capacity of M6 propellant and other explosives within the magazines at Camp Minden. Magazine space was limited, thus requiring the co-location of different explosives, stacking of pallets of explosives on top of each other, and allowing for little to no aisle or space to access the explosives within the magazines. The majority of the magazines contain multiple types of explosives co-located within each magazine. Although the explosives are stored in separate containers, they are not segregated in separate magazines. This increases the amount of handling and risk of detonation due to the movement of explosives to gain access to other explosive types.

In addition to the concerns associated with the stability of the M6 propellant, the storage conditions of the explosives also contribute to the potential for another explosion. Within the magazines, the M6 propellant and other explosives are stored in cardboard boxes and drums on pallets that are stacked 3-5 pallets high in many cases. The added weight of stacked pallets increases the pressure or compression on the explosives increasing the risk of auto-ignition or detonation. Also, some of the packaging which is bearing the weight of pallets of explosives stacked on top of each other is in poor condition and is prone to releasing the explosives contained inside.

Large pine trees and/or heavy vegetation are growing on the tops and sides of the bunkers. The pine trees' roots could breach the concrete ceiling and walls of the magazine, thus compromising the structural integrity of the magazine, and preventing the magazine from performing as intended. Compromised magazine integrity due to tree roots could introduce moisture as well as heat if a fire burned the vegetation on-top or surrounding the magazine. This introduction of heat could ignite the explosives stored within the magazine. A magazine explosion due to auto-ignition of the M6 propellant or other ignition source is predicted to result

in similar damage to the October 2012 explosion. However, if the magazine is structurally damaged, propagation of explosions to other magazines and/or greater damage due to uncontrolled explosive force could occur.

#### **IV. ENDANGERMENT DETERMINATION**

Actual or threatened releases of hazardous substances, pollutants or contaminants from this Site, if not addressed by implementing the response action selected in this Action Memorandum, will present an imminent and substantial endangerment to the public health, welfare, or the environment. The magazine that exploded in October 2012 caused shattered windows in Minden, LA, 4 miles away. The explosion completely destroyed the magazine, damaged 11 rail cars, and released unburned M6 propellant over ¼ mile from the site of the explosion.

The likelihood of an explosion within one or more of the magazines increases each day. The response action needed to address the explosives is estimated to take a minimum of 12 months. As such, the M6 propellant and other explosives disposition process must commence immediately. The damage may be catastrophic should these materials auto-ignite. The DoD Explosives Safety Board stated the likelihood of an explosion increases greatly within a time-frame as short as two years from August 1, 2013.

The primary threat from the explosive materials stored in the magazines at Camp Minden is the explosion potential. Blast/explosion models created by the DoD ESB Team showed that the town of Doyline, the Youth Challenge Program School, the Webster Parish Prison, and Command Center for LANG at Camp Minden were within the danger zone where property damage, injury, and potential casualties were expected from the unsecured explosives at the Explo Site. The relocation of the M6 propellant into magazines mitigated the impact from a large chain-reaction explosion, but did not eliminate the threat to surrounding the population, property, and environment.

## V. PROPOSED ACTIONS

### A. Proposed actions

#### 1. Proposed Action Description

The February 23, 2015, Army TAV report cautioned against unnecessary handling and recommended only handling the propellant once. Therefore, the selected response action for this site is onsite destruction of the M6 and CBI. The October 28, 2014, Action Memorandum proposed onsite destruction as the response action for the disposal of the M6 and CBI. Onsite destruction was identified as an appropriate method of disposal for the unstable M6 and CBI because: it was a technology that could be implemented in a short time frame to address the urgent situation at Camp Minden, an evaluation of other technologies did not identify sufficient capacity to address the material in a short time frame, and onsite destruction could be implemented and meet environmental requirements.

When the concept of onsite destruction by controlled open burning was announced, it was strongly opposed by many residents, interest groups and elected officials. On January 14, 2015 the Louisiana National Guard and the Louisiana Department of Environmental Quality wrote to EPA that they had not been provided the opportunity to select alternative disposal technologies or review the selection process. On January 15, 2015, EPA announced a 90 day period for the examination of alternative remedies. EPA initiated additional public participation (Dialogue Committee). EPA and the U.S. Army participated as ex-officio. The work of this group was to bring individual views to EPA but not to function as a FACA. Between February 10, 2015, and March 11, 2015, the participants reviewed a wide range of alternative clean-up technologies. The group evaluated some two dozen potential onsite destruction technologies. At the end of the dialogue, discussions by the community members centered on a half dozen potential technologies; however, none of the possible technologies were rejected by the participants and the participants agreed that each had benefits as well as drawbacks.

On February 23, 2015, the Army issued its report from a Technical Assistance Visit (TAV) to Camp Minden. In this report, the Army stated that the “TAV team cautioned against the aggressive nature of the proposed schedule for the destruction of M6 propellant.”

Based the identification of new technologies, vendors of different technologies providing updated information on availability and timing, along with the TAV Team’s concern with the aggressiveness of the proposed schedule, EPA recognizes the possibility that one or more alternative disposal methods might be utilized to safely and rapidly dispose of the M6 and CBI stored at Camp Minden. Due to the impending risk of explosion, any unnecessary handling, repackaging, shipping, or processing is not recommended. When evaluating a potential contractor, the Louisiana National Guard should consider the attributes for a successful approach identified in the March 13, 2013 “Dialogue Committee Facilitators’ Report” to the extent it is consistent with state procurement requirements. The destruction of propellant must be started and completed as soon as possible. Upon submission of the removal work plan by the Louisiana

National Guard, EPA will evaluate and approve the plan to achieve onsite destruction of the M6 and CBI.

This Removal Action also includes development of Contingency Plans, Health and Safety Plans, Community Involvement Plans and environmental oversight of the disposition method that includes air monitoring and sampling in proximity to the operations, at the perimeter, and within the surrounding communities. Samples of soil and groundwater will be taken before and after the operations. Any contamination will be removed. The treatment area will be restored.

## 2. Contribution to Remedial Performance

A remedial action is not planned for the Site at this time; however any remedial action that occurs will be consistent with the ongoing NPL clean-up at the Site. If any remedial action should occur the proposed removal action is consistent with the remedial action as it removes the source of the contamination.

## 3. Description of Alternative Technologies

The following onsite destruction technologies were highlighted based upon the discussions of the Dialogue Committee and may be evaluated as an alternative to onsite destruction by controlled open burning and any other applicable technologies to achieve the onsite destruction of the M6 and CBI. All of these approaches are also amenable to the installation of emission and/or effluent controls:

- Contained Burning with Pollution Controls
- Hydrolysis with treatment/disposal of effluent and solid wastes
- Microwave Reactor
- Rotary Kiln
- Supercritical Water Oxidation Units and
- Tunnel Furnaces

## 4. Applicable or Relevant and Appropriate Requirements (ARAR)

This removal action will be conducted to eliminate the actual or potential release of hazardous substances, pollutants, or contaminants to the environment, pursuant to CERCLA, 42 U.S.C. §9601 *et seq.*, and in a manner consistent with the National Contingency Plan (NCP), 40 CFR Part 300, as required at 33 U.S.C. §1321(c)(2) and 42 U.S.C. §9605. Pursuant to 40 CFR Part 300.415(j), fund-financed removal actions under CERCLA §104 and removal actions pursuant to CERCLA §106 shall, to the extent practicable considering the exigencies of the situation, attain the applicable or relevant and appropriate requirements under Federal and State environmental laws. The substantive provisions in site-specific ARARs for this site include: 40 C.F.R. Part 264, Subpart X operations, maintenance, monitoring, performance, closure and post-closure requirements; 40 C.F.R. Part 264 Subpart EE storage, and 40 C.F.R. § 265.382 Open Burn procedures and location requirements. To-be-considered (TBC) guidance includes:

explosives storage handling, and disposal procedures listed in *Military Explosives*, Department of the Army Technical Manual, *Handbook on the Management of Munitions Response Actions*; EPA OSWER, *Interim Final*; *Ammunition Handbook: Tactics, Techniques, and Procedures for Munitions Handlers*; Department of the Army, *Prediction of Safe Life of Propellants*, Picatinny Arsenal; *Reports of Explosives Safety Assistance Visits (March and April 2013)*, Department of the Army Explosives Safety Board; and the Louisiana Administrative Code, Title 55, Part I, Chapter 15 – Explosives Code.

Should the response action generate hazardous waste residues requiring off-site disposal, the RCRA waste analysis requirements found at 40 C.F.R. §§ 261.20 and 261.30; the RCRA manifesting requirements found at 40 C.F.R. §§ 262.20; and the RCRA packaging and labeling requirements found at 40 C.F.R. §§ 262.30, may be appropriate for this action. All off-site transportation of hazardous waste will be performed in conformity with RCRA and U.S. Department of Transportation requirements. See generally 40 C.F.R. Part 263. All hazardous substances removed for off-site disposal shall be disposed at a facility in compliance with environmental laws and regulations, as determined by EPA, under 40 C.F.R. §§ 300.440.

Depending on the technology chosen, substantive provisions found in the following regulations may apply:

- a) Standards for Incinerators at 40 CFR 264, Subpart O;
- b) Land Disposal Restrictions under 40 CFR Part 268; and
- c) National Pollutant Discharge Elimination System (NPDES) standards under 40 CFR Section 122.

## 5. Project Schedule

The action includes the removal of M6 and CBI stored on the Camp Minden. The placement of the contract should be finalized quickly and information sent to the EPA OSC for consent.

It is estimated that it will take several months for the contractor to mobilize and set up before operations are underway. After the concern for public safety, the time needed to complete the disposal of the M6 and CBI is a critical factor. Care should be taken for materials handling and worker safety. It is anticipated that the duration of action will be one year with the possibility of two years.

## **VII. EXPECTED CHANGE IN THE SITUATION SHOULD ACTION BE DELAYED OR NOT TAKEN**

The stabilizers in the explosives will continue to degrade. The explosives will become more and more unstable and the likelihood of auto-ignition will increase. In addition, the instability will also increase the chances of chain reactions. It will be more likely that explosives stored in adjacent magazines will explode. The October 15, 2012 explosion completely destroyed the magazine and impacted populations within a 4-mile radius. Multiple magazines

involved will increase the radius of destruction and injury.

## **VIII. OUTSTANDING POLICY ISSUES**

There are no outstanding policy issues associated with this site.

## **IX. ENFORCEMENT**

The Army and the LMD signed an AOC that includes the payment for, and the conduct of removal response actions needed to address approximately 15 -16 million pounds of explosives and other hazardous materials.

**X. RECOMMENDATION**

This decision document represents the selected removal action for the Explo Systems, Inc. Site in Minden, Webster Parish, LA, developed in accordance with CERCLA as amended, and not inconsistent with the NCP. This decision is based on the administrative record for the Site.

Conditions at the Site meet the criteria as defined by 40 CFR Section 300.415(b) of the NCP for a removal, and I recommend your approval of the proposed removal action.

APPROVED

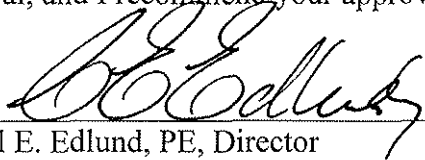

DATE

*March 18, 2015*

Carl E. Edlund, PE, Director  
Superfund Division (6SF)  
U.S. Environmental Protection Agency, Region 6

# TARGET SHEET

**SITE NAME:** CAMP MINDENEXPLO SYSTEMS INC

**CERCLIS I.D.:** LAR000072223

**TITLE OF DOC.:** ATTACHMENT 1 - ENFORCEMENT  
ATTACHMENT

**DATE OF DOC.:** 03/18/2015

**NO. OF PGS. THIS TARGET SHEET REPLACES:** 12

**SDMS #:** 1175422 **KEYWORD:** 93.04

**SENSITIVE ?**  **MISSING PAGES ?**

**ALTERN. MEDIA ?**  **CROSS REFERENCE ?**

**LAB DOCUMENT ?**  **LAB NAME:** \_\_\_\_\_

**ASC./BOX #:**

**CASE #:** \_\_\_\_\_ **SDG #:** \_\_\_\_\_

**COMMENTS :** THIS TARGET SHEET REPLACES ATTACHMENT 1 -  
ENFORCEMENT ATTACHMENT THIS DOCUMENT HAS  
BEEN REDACTED DUE TO FOIA EXEMPTION (b) (5) -  
PRIVILEGED INTER / INTRA- AGENCY MEMORANDA -  
THIS DOCUMENT IS LOCATED IN THE U.S. EPA  
REGION 6 SUPERFUND RECORDS CENTER.



HERCULES INCORPORATED -- PROPELLANT,EXPLOSIVE,SOLID,M6+2F/76MM --  
1376-00N010938

=====  
Product Identification  
=====

Product ID:PROPELLANT,EXPLOSIVE,SOLID,M6+2F/76MM  
MSDS Date:01/09/1986  
FSC:1376  
NIIN:00N010938  
MSDS Number: BHVKT  
=== Responsible Party ===  
Company Name:HERCULES INCORPORATED  
Address:RADFORD ARMY AMMUNITION PLANT  
City:RADFORD  
State:VA  
ZIP:24141  
Info Phone Num:703-639-7294  
Emergency Phone Num:703-639-7294  
CAGE:2D295

=== Contractor Identification ===  
Company Name:HERCULES INC  
Address:RADFORD ARMY AMMUNITION PLANT  
Box:City:RADFORD  
State:VA  
ZIP:24141  
Country:US  
Phone:703-639-7294  
CAGE:2D881  
Company Name:HERCULES INCORPORATED  
Address:84 5TH AVE  
City:NEW YORK  
State:NY  
ZIP:10011-7603  
Country:US  
CAGE:2D295

=====  
Composition/Information on Ingredients  
=====

Ingred Name:DIBUTYL PHTHALATE (SARA III)  
CAS:84-74-2  
RTECS #:TI0875000  
Fraction by Wt: 3.00%  
Other REC Limits:N/K  
OSHA PEL:5 MG/M3  
ACGIH TLV:5 MG/M3; 9192  
EPA Rpt Qty:10 LBS  
DOT Rpt Qty:10 LBS

Ingred Name:DIPHENYLAMINE  
CAS:122-39-4  
RTECS #:JJ7800000  
Fraction by Wt: 1.00%  
Other REC Limits:N/K  
OSHA PEL:10 MG/M3  
ACGIH TLV:10 MG/M3; 9192

Ingred Name:POTASSIUM SULFATE

CAS:7778-80-5  
RTECS #:TT5900000  
Fraction by Wt: 2.00%  
Other REC Limits:N/K  
OSHA PEL:N/K  
ACGIH TLV:N/K

Ingred Name:NITROCELLULOSE (FLAMMABLE SOLID)  
Fraction by Wt: 87.00%  
Other REC Limits:N/K  
OSHA PEL:N/K  
ACGIH TLV:N/K

Ingred Name:DINITROTOLUENE (SARA III)  
CAS:25321-14-6  
RTECS #:XT1300000  
Fraction by Wt: 10.00%  
Other REC Limits:N/K  
OSHA PEL:S;A2;0.15 MG/M3;9293  
ACGIH TLV:S, 1.5 MG/M3  
EPA Rpt Qty:10 LBS  
DOT Rpt Qty:10 LBS

=====  
===== Hazards Identification =====

LD50 LC50 Mixture:N/K  
Routes of Entry: Inhalation:YES Skin:YES Ingestion:YES  
Reports of Carcinogenicity:NTP:NO IARC:NO OSHA:NO  
Health Hazards Acute and Chronic:SEE SIGNS AND SYMPTOMS OF  
OVEREXPOSURE.  
Explanation of Carcinogenicity:NONE  
Effects of Overexposure:EYES:N/K .SKIN:TOXIC,AVOID SKIN  
CONTACT.INGESTION:TOXIC,AVOID INGESTION.INHALATION:TOXIC,AVOID  
INHALATION.  
Medical Cond Aggravated by Exposure:N/K

=====  
===== First Aid Measures =====

First Aid:EYES:IN CASE OF CONTACT,IMMEDIATELY FLUSH WITH PLENTY OF LOW  
PRESSURE WATER FOR AT LEAST 15 MINUTES.REMOVE ANY CONTACT LENSES TO  
ASSURE THOROUGH FLUSHING.CALL A PHYSICIAN.SKIN:WASH WITH SOAP AND  
RUNNING WATER.INGESTION:CONTACT MD IMMEDIATELY .INHALATION:REMOVE  
TO FRESH AIR.TREAT ANY IRRITATION SYMPTOMATICALLY.CALL A PHYSICIAN.

=====  
===== Fire Fighting Measures =====

Extinguishing Media:SELF-OXIDIZING,DELUGE W/ H\*20.MAY NOT BE ABLE TO  
EXTING MATL BEFORE IT IS CONSUMED UNLESS LRG QTY USED IN SHORT  
TIME.  
Fire Fighting Procedures:USE NIOSH/MSHA APPROVED SCBA AND FULL  
PROTECTIVE EQUIPMENT .EVACUATE THE AREA.  
Unusual Fire/Explosion Hazard:EASILY IGNITED,HIGHLY COMBUSTIBLE;PROTECT  
FROM FIRE,SPARKS & EXTREME HEAT.AUTOIGNITION  
TEMP:383F,195C.HAZARDOUS DECOMPOSITION PRODUCTS:OXIDES OF CARBON.

=====  
===== Accidental Release Measures =====

Spill Release Procedures:CLEAN UP SPILLS IMMEDIATELY USING A SOFT BRISTLE BRUSH AND A CONDUCTIVE RUBBER OR PLASTIC SHOVEL.USE CAUTION,MATERIAL SENSITIVE TO IMPACT,FRICTION AND ELECTROSTATIC DISCHARGE.

Neutralizing Agent:N/K

=====  
===== Handling and Storage =====

Handling and Storage Precautions:AVOID PRLNG TEMP ABOVE 50C,125F.REC:21C,75F;50% HUMIDITY.STOR MUST CONFORM TO LOCAL,STATE,FEDERAL REGS (OSHA 29CFR1910.109;BATF 27CFR55 SUBPART K).

Other Precautions:WARNING,FLAMMABLE SOLID.KEEP AWAY FROM HEAT,SPARKS AND OPEN FLAME.KEEP CONTAINERS CLOSED.USE WITH ADEQUATE VENTILATION.

=====  
===== Exposure Controls/Personal Protection =====

Respiratory Protection:NIOSH/MSHA APPROVED RESPIRATOR APPROPRIATE FOR EXPOSURE OF CONCERN .

Ventilation:LOCAL AND GENERAL VENTILATION NECESSARY TO KEEP AIR CONCENTRATION BELOW TLV .

Protective Gloves:COTTON OR LEATHER.

Eye Protection:SAFETY GLASSES

Other Protective Equipment:FLAMEPROOF COVERALLS AND CONDUCTIVE SHOES.

Work Hygienic Practices:N/K

Supplemental Safety and Health

ROUTES OF ENTRY:INGEST/SKIN/INHAL .

=====  
===== Physical/Chemical Properties =====

Melt/Freeze Pt:M.P/F.P Text:N/K

Decomp Temp:Decomp Text:N/K

Vapor Pres:NEGLIGIBLE

Spec Gravity:1.4955,WATER=1

Evaporation Rate & Reference:<1 (BUTYL ACETATE=1)

Solubility in Water:NEGLIGIBLE

Appearance and Odor:HARD CYLINDER,PERFORATED,SMOOTH,GREENISH YELLOW COLOR.ODORLESS.

=====  
===== Stability and Reactivity Data =====

Stability Indicator/Materials to Avoid:YES

OXIDES OF NITROGEN AND CARBON.

Stability Condition to Avoid:AVOID OPEN FLAME,SPARKS AND HEAT.

Hazardous Decomposition Products:OXIDES OF CARBON.

=====  
===== Disposal Considerations =====

Waste Disposal Methods:DISPOSAL MUST BE IN ACCORDANCE WITH FEDERAL,STATE AND LOCAL REGULATIONS .BURN IN OPEN BURNING GROUND IN ACCORDANCE WITH REGULATIONS.MAY ALSO BE BURNED IN AN INCINERATOR APPROVED FOR EXPLOSIVES.

Disclaimer (provided with this information by the compiling agencies):  
This information is formulated for use by elements of the Department of Defense. The United States of America in no manner whatsoever,

expressly or implied, warrants this information to be accurate and disclaims all liability for its use. Any person utilizing this document should seek competent professional advice to verify and assume responsibility for the suitability of this information to their particular situation.

# CBI

## CLEAN BURNING IGNITOR (CBI)

### FORMULATION:

---

Nitrocellulose 98.0 min.  
Diphenylamine 1.50 +/- 1.0  
Potassium Nitrate 0.1max.  
Graphite glaze 0.2 added

### SHAPE

---

Single perforated flake

### COLOR

---

Yellow, green, blue

### DIMENSIONS

---

Usage	Length (in)	Diameter (in)	Perf Diameter (in)	Inner (in)	Web Outer (in)	Average (in)	# of Perfs	Shape
155MM	0.0040	0.0800	0.0180	n/a	n/a	n/a	1	flake
Igniter Charge	0.0040	0.0550	0.0100	n/a	n/a	n/a	1	flake

*CBI Flake:*

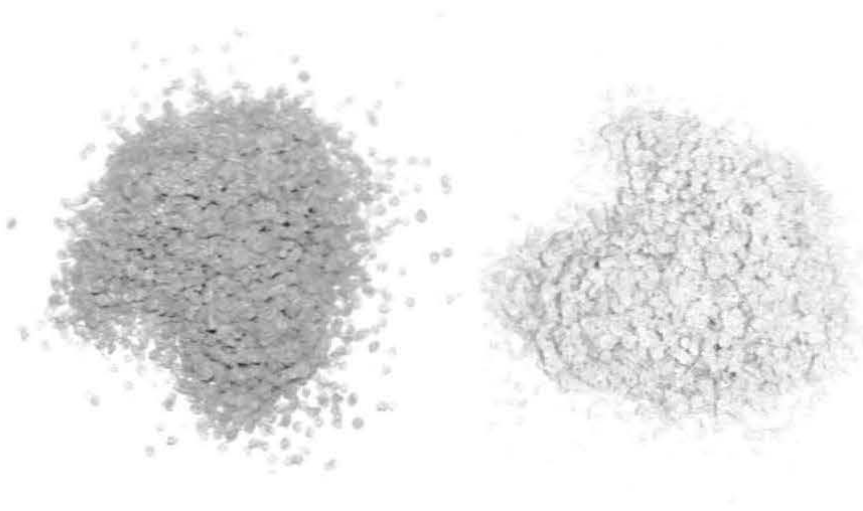

*Photos depict the color variation normally seen with CBI Flake Propellant*

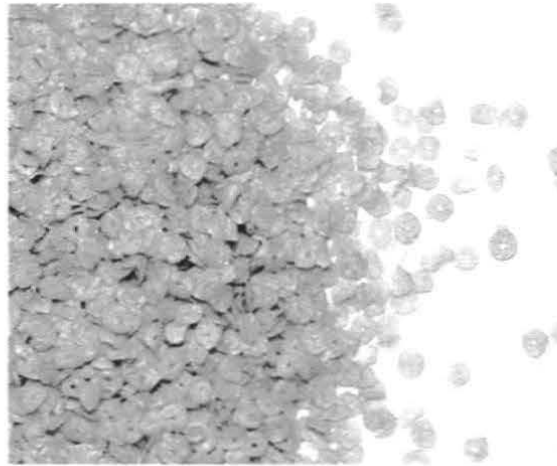

**CLOSE-UP OF CBI FLAKE**

*Blue Colored CBI Flake: A blue color change has been observed in the CBI igniter propellant in the M119A2 propelling charges stored in Southwest Asia. This phenomenon has only been seen in the M119A2 propelling charge "Y" lots. The color change has no correlation to diminished stability.*

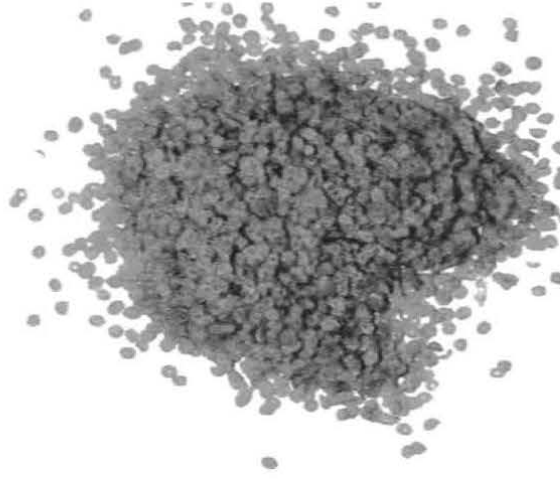

*Actual size*

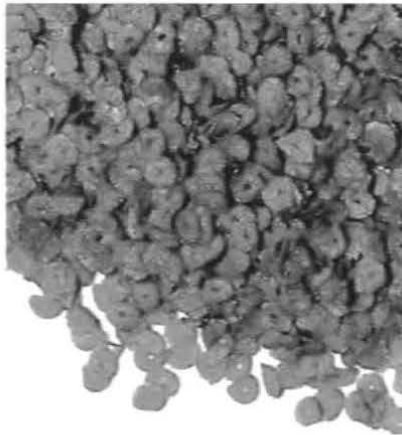

*Close-up of Blue CBI*



## MATERIAL SAFETY DATA SHEET

### PRODUCT NAME

POTASSIUM NITRATE

Product Code:

001/05-US

Date of issue:

March 2012

Supersedes: October 2008

### 1. PRODUCT AND COMPANY IDENTIFICATION

**Product identifier** Potassium nitrate / Krista K / Ultrasol K / Champion

#### Identified uses

Industrial use of potassium nitrate for formulation of preparations, intermediate use and end-use in industrial settings

Industrial end-use as energy storage salt

Professional use in formulation of fertilizer preparations and end-use as fertilizer

#### Non Recommended Uses

Food additive; Reagent in waste water treatment

#### Supplier

SQM North America  
2727 Paces Ferry Rd, Building Two, Suite 1425  
Atlanta, GA 30339

#### Company Telephone/Fax

(770) 916 9400 / (770) 916 9404

#### Emergency Telephone Number

(800) 424 9300 (CHEMTREC)

### 2. HAZARDS IDENTIFICATION

#### Emergency Overview

Crystals/Prills, white, odorless

#### WARNING

Oxidizer. Contact with combustible materials will not cause spontaneous ignition, however, sodium nitrate will enhance an existing fire.

May cause skin and eye irritation.

NFPA 704: National Fire Protection Association

Health 1  
Fire 0  
Reactivity 1  
Special Oxidizer

HMIS® III

Health 1  
Flammability 0  
Physical hazards 1

#### OSHA Regulatory Status

This material is considered hazardous by the OSHA Hazard Communication Standard (29 CFR 1910.1200)

#### Potential Health Effects

**Likely routes of exposure:** Eye contact, skin contact, inhalation.

In case of inhalation Irritation to respiratory tract

In case of skin contact May cause redness or irritation

In case of eye contact May cause redness or irritation

In case of ingestion Ingestion of large amounts may cause: Gastrointestinal disturbances

### 3. COMPOSITION/INFORMATION ON INGREDIENTS

Substance name	CAS No	EC No	Concentration
Potassium nitrate	7757-79-1	231-818-8	> 94 %
Sodium nitrate	7631-99-4	231-554-3	0.01 - 5 %
Sulphate (SO <sub>4</sub> <sup>+2</sup> )			< 1 %
Chloride (Cl <sup>-</sup> )			< 0.6 %
Magnesium (Mg <sup>+2</sup> )			< 0.5 %
Nitrite (NO <sub>2</sub> <sup>-</sup> )			< 0.02 %
Calcium (Ca <sup>+2</sup> )			< 0.2 %
Perchlorate (ClO <sub>4</sub> <sup>-</sup> )			< 0.01%
Iodate (IO <sub>3</sub> <sup>-</sup> )			0.005 - 0.01 %

For specific details on composition according to the product grade, see product data sheet

### 4. FIRST AID MEASURES

#### Description of first aid measures

##### General information

In case of persisting adverse effects consult a physician. Never give anything by mouth to an unconscious person or a person with cramps.

##### In case of inhalation

Remove to fresh air and keep at rest in a position comfortable for breathing. Get medical attention for any breathing difficulty.

##### In case of skin contact

Wash with plenty of soap and water. Remove contaminated clothing. If skin irritation occurs: Get medical advice/attention.

##### In case of eye contact

Rinse cautiously with water for several minutes. Remove contact lenses, if present and easy to do. Continue rinsing.

If eye irritation persists: Get medical advice/attention.

##### In case of ingestion

Induce vomiting. Rinse mouth immediately and drink plenty of water.





## MATERIAL SAFETY DATA SHEET

### PRODUCT NAME

POTASSIUM NITRATE

Product Code:

001/05-US

Date of issue:

March 2012

Supersedes: October 2008

#### Most important symptoms and effects, both acute and delayed

The following symptoms may occur:

In case of inhalation           Irritation to respiratory tract  
  Delayed lung effects after short term exposure to thermal degradation products

In case of skin contact        May cause redness or irritation

In case of eye contact         May cause redness or irritation

In case of ingestion         Ingestion of large amounts may cause:        Gastrointestinal disturbances

#### Indication of any immediate medical attention and special treatment needed

Treat symptomatically.

### 5. FIRE FIGHTING MEASURES

#### Flammable properties

Not flammable.

#### Extinguishing media

Suitable extinguishing media:                    Use any suitable mean for extinguishing surrounding fire. Spray water for small fires. For large fires flood with abundant water.

Unsuitable material:                               None, but attention should be paid to compatibility with chemicals surrounding.

#### Protection for firefighters

##### Specific hazards arising from the chemical

Thermal decomposition can lead to the escape of toxic/corrosive gases and vapours.

##### Products of combustion

Thermal decomposition products: refer to section 10.

##### Protective equipment and precautions for firefighters

Keep upwind of fire. Wear full fire fighting turn-out gear (full Bunker gear) and respiratory protection (SCBA).

### 6. ACCIDENTAL RELEASE MEASURES

#### Personal precautions

Provide adequate ventilation. Wear personal protection equipment (Section 8).

#### Environmental precautions

Do not allow to enter into surface water or drains. Ensure waste is collected and contained.

#### Methods for containment and cleaning up

Take up mechanically, placing in appropriate containers for disposal or recovery.

Unsuitable material for containment/taking up:        Do not absorb in saw-dust or other combustible absorbents.

#### Other information

None

### 7. HANDLING AND STORAGE

#### Handling

Avoid generation of dust. Provide adequate ventilation. Wear personal protective equipment. Wash hands thoroughly after handling. Do not eat, drink or smoke when using this product. Keep away from flammable, combustible and reducing substances.

#### Storage

Keep/store only in original container. Store in a well-ventilated place. Keep container tightly closed.

Do not store together with:                        Combustible substance, reducing agents

Perchlorate containing product - Special handling may apply. See [www.dtsc.ca.gov/hazardouswaste/perchlorate](http://www.dtsc.ca.gov/hazardouswaste/perchlorate) and Section 15 for more information regarding California State regulations.

### 8. EXPOSURE CONTROLS/PERSONAL PROTECTION

#### Exposure Guidelines

##### Occupational exposure limits

Sodium nitrate:

No specific occupational exposure limit.

Particulates Not Otherwise Regulated (PNOR):

Inert or Nuisance Dust:

	mppcf*	mg/m <sup>3</sup>
Respirable fraction	15	5
Total dust	50	15

\*Millions of particles per cubic foot of air

##### Engineering controls

Use exhaust ventilation to keep airborne concentrations below exposure limits.

##### Personal Protective Equipment

Eye/face protection                                Chemical goggles required all the time.

Skin Protection                                     Nitrile rubber gloves, over 0.11 mm thickness, > 480 min breakthrough time, recommended.

Respiratory Protection                            Wear respiratory protection, where airborne concentrations are expected to exceed exposure limits

##### General Hygiene Considerations

Avoid contact with eyes and skin. Wash hands thoroughly after handling. Have eye-wash facilities immediately available.



## MATERIAL SAFETY DATA SHEET

### PRODUCT NAME

POTASSIUM NITRATE

Product Code:

001/05-US

Date of issue:

March 2012

Supersedes: October 2008

## 9. PHYSICAL AND CHEMICAL PROPERTIES

### Information on basic physical and chemical properties

Appearance	Solid, prilled or crystalline
Colour	White
Odour	Odourless
Odour Threshold	No applicable
pH value	8-10 (5% aqueous solution)
Melting point / melting range	335 °C / 635 F at 1013 hPa
Boiling temperature / boiling range	Not applicable
Flash point	Not applicable
Vapourisation rate / Evaporation rate	No data available
Flammable solids	Not flammable
Explosion limits (LEL, UEL)	Not applicable
Vapour pressure	Not applicable
Relative vapour density (air = 1)	No data available
Density	2.1 at 20°C / 68 F
Solubility	> 100 g/L at 25 °C / 77 F (water)
Partition coefficient n-octanol /water	Not applicable
Auto Ignition temperature (AIT)	Not applicable
Decomposition temperature	> 600 °C / 1112 F
Viscosity	Not applicable
Explosive properties	Not explosive
Oxidising properties	Oxidizer

### Other information

None

## 10. STABILITY AND REACTIVITY

### Stability/Reactivity

Stable under normal storage and temperature conditions.

### Conditions to avoid

Keep away from flammable, combustible and reducing substances.

### Incompatible materials

Flammable, combustible and reducing substances under specific conditions. For storage and handling incompatibilities, refer to Section 7.

### Hazardous decomposition products

Thermal decomposition products (> 1112 F / 600 °C): Nitrous oxides (NO<sub>x</sub>), potassium nitrite and potassium oxide.

### Possibility of hazardous reactions

None identified

## 11. TOXICOLOGICAL INFORMATION

The following information mostly refers to the major component of the product.

### Information on toxicological effects

#### Acute toxicity

Acute oral toxicity	LD50:	> 2000 mg/kg bw	Species:	Method:
		Data obtained by analogy conclusion	Rat.	OECD Guideline 425
Acute dermal toxicity	LD50:	> 5000 mg/kg bw	Rat.	OECD Guideline 402
Acute inhalation toxicity	LC50:	> 0.527 mg/L (4-h)	Rat.	OECD Guideline 403
		(maximum achievable concentration)		

#### Irritant and corrosive effects

Irritation to the skin	Result:	Species:	
Equivalent/similar to OECD guideline 404	non-irritant.	Rabbit.	Data obtained by analogy conclusion
Primary dermal irritation index (PDII): 0 of max. 5 (mean) (Time point: 1, 24, 48, 72h)			
Irritation to eyes	Result	Species:	
OECD Guideline 437	non-irritant.	In vitro study	
OECD Guideline 405/EU B.5	non-irritant.	Rabbit.	
<b>Respiratory or skin sensitisation</b>	Result:	Species:	
OECD Guideline 429/EU B.42	not sensitising.	Mouse.	Data obtained by analogy conclusion
Respiratory sensitisation	No information available.		

#### Germ cell mutagenicity / Genotoxicity

In-vitro genotoxicity	Method:	Result:	
Gene-mutations microorganisms	bacterial reverse mutation assay	negative	(literature information)
Gene-mutations mammalian cells	OECD Guideline 476/EU B.17	negative	
Chromosome aberr. mammalian cells	According to Ishidate & Odashima (1977)	negative	(literature information)
Sister Chromatid Exchange (SCE)	Equivalent or similar to OECD 479	negative	(literature information)

#### Carcinogenicity

International Agency for Research on Cancer (IARC)	Inadequate animals and humans evidence
National Toxicology Program (NTP)	Not listed
29 CFR part 1910, subpart Z	Not listed
California Proposition 65	Not listed
WHO (2003) Nitrate in drinking water	No association between nitrate exposure in humans and the risk of cancer



## MATERIAL SAFETY DATA SHEET

### PRODUCT NAME

POTASSIUM NITRATE

Product Code:

001/05-US

Date of issue:

March 2012

Supersedes: October 2008

#### Reproductive toxicity

Adverse effects on sexual function and fertility/developmental toxicity

OECD guideline 422. NOAEL(C): 1500 mg/kg/d Rat.

At the highest dose tested, no effects on fertility or development were observed in this repeated dose toxicity study.

#### Specific target organ toxicity (single exposure)

Practical experience / human evidence

No relevant effect have been observed after single exposure to potassium nitrate.

#### Specific target organ toxicity (repeated exposure)

OECD guideline 422.

Effect dose: Organs affected:

NOAEL(C): 1500 mg/kg bw/day

None

#### Aspiration hazard

Physicochemical data and toxicological information does not indicate an aspiration hazard.

#### Other Toxicological Information

This product contains trace amounts of naturally-occurring perchlorate and iodate. Like other goitrogenic substances, perchlorate may affect iodine uptake by thyroid under specific conditions.

### 12. ECOLOGICAL INFORMATION

The following information mostly refers to the major component of the product.

#### Toxicity

Aquatic toxicity

96-h LC50 1378 mg/L

*Poecilia reticulata* (freshwater fish) (literature information)

48-h EC50 490 mg/L

*Daphnia magna* (fresh water flea). (literature information)

10 d EC50 > 1700 mg/L

Several algae species (literature information)

#### Persistence and degradability

In aqueous compartments, the substance will dissociate into sodium and nitrate ions. Other minor compounds are also expected to be dissociated in their corresponding ions. Sodium ions are not subject to further degradation. Under anoxic conditions, nitrate is subjected to denitrification and is ultimately converted into molecular nitrogen as part of the nitrogen cycle. Nitrate and other oxyanions impurities are likely to be found in oxic compartments.

#### Bioaccumulative potential

Potassium nitrate has a low potential for bioaccumulation based on physicochemical properties (high water solubility).

#### Mobility in soil

Nitrate has a low potential for adsorption. Portion not taken up by plants, can leach to groundwater. Potassium may be absorbed by plants and it can also participate in ion exchange processes.

#### Other adverse effects

Excess nitrate leaching may enrich waters leading to eutrophication.

### 13. DISPOSAL CONSIDERATIONS

Disposal should be in accordance with applicable regional, national and local laws and regulations.

It is the responsibility of the waste generator to determine the toxicity and physical properties of the material generated to determine the proper waste identification and disposal method in compliance with applicable regulations (eg. Resource Conservation and Recovery Act (RCRA) 40 CFR 261).

Perchlorate containing product - Special handling may apply. See [www.dtsc.ca.gov/hazardouswaste/perchlorate](http://www.dtsc.ca.gov/hazardouswaste/perchlorate) and Section 15 for more information regarding California State regulations.

### 14. TRANSPORT INFORMATION

#### US DOT (ground)

UN-No. 1486  
Proper Shipping Name POTASSIUM NITRATE  
Class(es) 5.1  
Packing group III  
Hazard label(s) 5.1 (oxidizer)  
Special marking No

#### Sea transport (IMDG)

UN-No. 1486  
Proper Shipping Name POTASSIUM NITRATE  
Class(es) 5.1  
Packing group III  
Marine pollutant No  
Hazard label(s) 5.1 (oxidizer)  
Special marking No  
Special Provision 964

#### Air transport (ICAO-TI / IATA-DGR)

UN-No. 1486  
Proper Shipping Name POTASSIUM NITRATE



## MATERIAL SAFETY DATA SHEET

### PRODUCT NAME

**POTASSIUM NITRATE**

Product Code:

001/05-US

Date of issue:

March 2012

Supersedes: October 2008

Class(es) 5.1  
Packing group III  
Hazard label(s) 5.1 (oxidizer)  
Special marking No

#### Special precautions for user

None

Transport in bulk according to Annex II of MARPOL 73/78 and the IBC Code

Not applicable

#### Remark

None

### 15. REGULATORY INFORMATION

#### US Federal

SARA Title III Rules

Section 311/312 Hazard Classes

Acute Health Hazard	No
Chronic Health Hazard	No
Fire Hazard	Yes (Oxidizer)
Release of Pressure	No
Reactive Hazard	No

Section 313 Toxic Chemicals

N511 Nitrate compounds (water dissociable; reportable only when in aqueous solution)

Section 302 Extremely Hazardous Substances (EHS)/CERCLA Hazardous Substances

Potassium nitrate is not listed

#### US State Regulations

California Proposition 65

Potassium nitrate is not listed

California Code of Regulations Title 22  
(Health & Safety Code), Chapter 33

See <http://www.dtsc.ca.gov/hazardouswaste/perchlorate/>

#### Canada

WHMIS Classification:

Class C

This product has been classified according to the hazard criteria of the 2010 Controlled Products Regulations (CPR) and the MSDS contains all the information required by the CPR.

#### European Union

Classification according to Regulation (EC) No 1272/2008 [EU-GHS/CLP]

Hazard classes and Hazard categories	Hazard statements
Ox. Sol. 3*	H272

\*Applicable only to the crystalline form. Granular form that passes UN Test 0.1 is not classified under GHS/CLP.

### 16. OTHER INFORMATION

This MSDS complies with 29 CFR part 1910 subpart Z, 2010 Canada Controlled Products Regulations (CPR) and ANSI Standard Z400.1-2004

#### Prepared by

Regulatory Affairs Department, SQM

#### E-mail

product\_safety@sqm.com

spn-northamerica@sqm.com ; ind-northamerica@sqm.com

The information above is believed to be accurate and represents the best information currently available to us. However, we make no warranty of merchantability or any other warranty, express or implied, with respect to such information, and we assume no liability resulting from its use. Users should make their own investigations to determine the suitability of the information for their particular purposes. In no event shall SQM be liable for any claims, losses, or damages of any third party or for lost profits or any special, indirect, incidental, consequential or exemplary damages, howsoever arising, even if SQM has been advised of the possibility of such damages.

#### Indication of changes

All sections were reviewed, contents were updated and format was changed.



This is a digital copy of a book that was preserved for generations on library shelves before it was carefully scanned by Google as part of a project to make the world's books discoverable online.

It has survived long enough for the copyright to expire and the book to enter the public domain. A public domain book is one that was never subject to copyright or whose legal copyright term has expired. Whether a book is in the public domain may vary country to country. Public domain books are our gateways to the past, representing a wealth of history, culture and knowledge that's often difficult to discover.

Marks, notations and other marginalia present in the original volume will appear in this file - a reminder of this book's long journey from the publisher to a library and finally to you.

### **Usage guidelines**

Google is proud to partner with libraries to digitize public domain materials and make them widely accessible. Public domain books belong to the public and we are merely their custodians. Nevertheless, this work is expensive, so in order to keep providing this resource, we have taken steps to prevent abuse by commercial parties, including placing technical restrictions on automated querying.

We also ask that you:

- + *Make non-commercial use of the files* We designed Google Book Search for use by individuals, and we request that you use these files for personal, non-commercial purposes.
- + *Refrain from automated querying* Do not send automated queries of any sort to Google's system: If you are conducting research on machine translation, optical character recognition or other areas where access to a large amount of text is helpful, please contact us. We encourage the use of public domain materials for these purposes and may be able to help.
- + *Maintain attribution* The Google "watermark" you see on each file is essential for informing people about this project and helping them find additional materials through Google Book Search. Please do not remove it.
- + *Keep it legal* Whatever your use, remember that you are responsible for ensuring that what you are doing is legal. Do not assume that just because we believe a book is in the public domain for users in the United States, that the work is also in the public domain for users in other countries. Whether a book is still in copyright varies from country to country, and we can't offer guidance on whether any specific use of any specific book is allowed. Please do not assume that a book's appearance in Google Book Search means it can be used in any manner anywhere in the world. Copyright infringement liability can be quite severe.

### **About Google Book Search**

Google's mission is to organize the world's information and to make it universally accessible and useful. Google Book Search helps readers discover the world's books while helping authors and publishers reach new audiences. You can search through the full text of this book on the web at <http://books.google.com/>

101.11:  
-1300-214/987

DEPARTMENT OF THE ARMY TECHNICAL MANUAL **TM 9-1300-214**

---

# MILITARY EXPLOSIVES

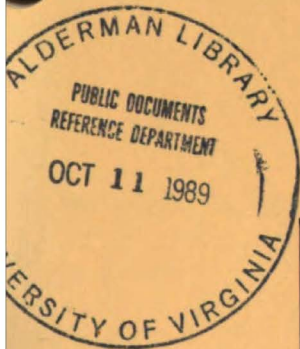

This copy is a reprint which includes current pages from Changes 1 and 2.



---

**HEADQUARTERS, DEPARTMENT OF THE ARMY  
SEPTEMBER 1984**

Change )  
          )  
No. 2    )

HEADQUARTERS  
DEPARTMENT OF THE ARMY  
Washington, D.C., 30 January 1987

## MILITARY EXPLOSIVES

TM 9-1300-214, 20 Sep 84, is changed as follows:

1. Remove old pages and insert new pages as indicated below. New or changed material is indicated by a vertical bar in the margin of the page. Revised chapters are indicated by a vertical bar adjacent to the title.

Remove pages

A page  
i(ii blank)  
12-1 thru 12-49(12-50 blank)  
15-3 and 15-4  
Index 11 and Index 12  
Index 21 and Index 22

Insert pages

A page  
i(ii blank)  
12-1 thru 12-30  
15-3 and 15-4  
Index 11 and Index 12  
Index 21 and Index 22

2. File this change sheet in front of the publication for reference purposes.

By Order of the Secretary of the Army:

JOHN A. WICKHAM, JR.  
*General, United States Army*  
*Chief of Staff*

*Official:*  
R.L. DILWORTH  
*Brigadier General, United States Army*  
*The Adjutant General*

Distribution:  
To be distributed in accordance with DA Form 12-40A-R, General Information Applicable to all Organizations which have a Conventional Munitions Mission.

Change )  
          )  
No. 1   )

HEADQUARTERS  
DEPARTMENT OF THE ARMY  
Washington, D.C., 30 November 1985

## MILITARY EXPLOSIVES

TM 9-1300-214, 20 Sep 84, is changed as follows:

1. Remove old pages and insert new pages as indicated below. New or changed material is indicated by a vertical bar in the margin of the page.

Remove pages

None  
6-1 and 6-2  
9-3 and 9-4  
9-7 and 9-8  
15-3 thru 15-6

Insert pages

A page  
6-1 and 6-2  
9-3 and 9-4  
9-7 and 9-8  
15-3 thru 15-6

2. File this change sheet in front of the publication for reference purposes.

By Order of the Secretary of the Army:

Official:  
MILDREDE E. HEDBERG  
Brigadier General, United States Army  
The Adjutant General

JOHN A. WICKHAM, JR.  
General, United States Army  
Chief of Staff

Distribution:  
To be distributed in accordance with DA Form 12-40A-R, General Information Applicable to all Organizations which have a Conventional Munitions Mission.



**LIST OF EFFECTIVE PAGES**

When applicable, insert latest change pages and dispose of superseded pages in accordance with applicable regulations.

Total number of pages in this publication is 385 consisting of the following:

PAGE NO.	*CHANGE NO.	PAGE NO.	*CHANGE NO.
Cover	0	10-1 thru 10-13	0
A Page	2	10-14 blank	0
i	2	11-1 thru 11-17	0
ii blank	0	11-18 blank	0
1-1	0	12-1 thru 12-29	2
1-2 blank	0	12-30 blank	0
2-1 thru 2-23	0	13-1 thru 13-11	0
2-24 blank	0	13-12 blank	0
3-1 thru 3-5	0	14-1 thru 14-15	0
3-6 blank	0	14-16 blank	0
4-1 thru 4-17	0	15-1 and 15-2	0
4-18 blank	0	15-3 and 15-4	2
5-1 thru 5-10	0	15-5	0
6-1	1	15-6	1
6-2 thru 6-4	0	15-7 thru 15-15	0
7-1 thru 7-20	0	15-16 blank	0
8-1 thru 8-135	0	A-1 thru A-13	0
8-136 blank	0	A-14 blank	0
9-1 thru 9-3	0	B-1 and B-2	0
9-4	1	Index 1 thru Index 11	0
9-5 thru 9-7	0	Index 12	2
9-8	1	Index 13 thru 20	0
9-9 thru 9-12	0	Index 21 and Index 22	2
		Index 23 thru Index 26	0
		Authentication Page	0

\*Zero indicates an original page.

Change 2 A

**MILITARY EXPLOSIVES**

**REPORTING OF ERRORS**

You can help improve this manual. If you find any mistakes or if you know of a way to improve the procedures, please let us know. Mail DA Form 2028 (Recommended Changes to Publications and Blank Forms) or DA Form 2028-2 located in the back of this manual direct to: Commander, US Army Armament, Munitions and Chemical Command, ATTN: AMSMC-MAY-TA(D), Dover, NJ 07801-5001. A reply will be furnished to you.

	Paragraph	Page
CHAPTER 1. INTRODUCTION .....	1-1	1-1
2. HISTORICAL DEVELOPMENT OF ENERGETIC MATERIAL .....	2-1	2-1
3. GENERAL CHARACTERISTICS AND CLASSIFICATION OF ENERGETIC MATERIALS .....	3-1	3-1
4. CHEMISTRY AND PHYSICS OF ENERGETIC MATERIALS .....	4-1	4-1
5. PROPERTIES AND TESTS OF EXPLOSIVES .....	5-1	5-1
6. PROPERTIES AND TESTS OF PROPELLANTS .....	6-1	6-1
7. UNITED STATES PRIMARY EXPLOSIVES .....	7-1	7-1
8. UNITED STATES BOOSTER AND SECONDARY EXPLOSIVES .....	8-1	8-1
9. UNITED STATES PROPELLANTS .....	9-1	9-1
10. UNITED STATES PYROTECHNICS .....	10-1	10-1
11. FOREIGN ENERGETIC MATERIALS .....	11-1	11-1
12. SAFE HANDLING, HAZARD CLASSIFICATION, AND TOXICITY OF ENERGETIC MATERIALS .....	12-1	12-1
13. DETECTION AND IDENTIFICATION OF ENERGETIC MATERIALS .....	13-1	13-1
14. PACKING, MARKING, STORAGE, AND SHIPMENT OF ENERGETIC MATERIALS .....	14-1	14-1
15. DISPOSAL, DESTRUCTION, DECONTAMINATION, AND DEMILITARIZATION OF ENERGETIC MATERIALS .....	15-1	15-1
APPENDIX A .....		A-1
APPENDIX B .....		B-1
INDEX .....		Index 1

\*This manual supersedes TM 9-1300-214, 28 November 1967, including all changes.

## CHAPTER 1 INTRODUCTION

---

**1-1. Purpose.** This manual is intended for use as a text for instruction or as a reference source in the field of energetic materials. Only the materials of interest in conventional armaments are covered; nuclear armaments are not.

**1-2. Scope.** Chapter 2 is a history of the field of energetic materials. Chapter 3 divides the energetic materials field into three categories: explosives, propellants, and pyrotechnics. Chapter 4 discusses the principles of chemistry and physics pertinent to the energetic materials field. Chapter 5 is a description of the tests used to evaluate explosives. Both mandatory safety tests and tests used in the selection of particular compounds among the many explosive compounds are covered. Chapter 6 contains a description of the tests used to evaluate propellants. Chapter 7 presents detailed information about the compounds that are used by the United States as initiating explosives. A discussion of priming compositions is also included. Chapter 8

presents detailed information about the compounds that are used by the United States as booster and secondary explosives. Chapter 9 provides a discussion of those mixtures of materials that are used as propellants. Chapter 10 discusses the field of pyrotechnics. Foreign energetic materials are covered in Chapter 11. Safety and toxicity considerations are discussed in Chapter 12. Basic methods used to identify and detect energetic materials are presented in Chapter 13. Chapter 14 presents information pertinent to the packing, marking, storing, and shipping of energetic materials. Chapter 15 discusses disposal, destruction, decontamination, and demilitarization of energetic materials. Pertinent data on explosives and propellants are tabulated in Appendix A. Tables A-1 through A-8 allow rapid comparison of the important characteristics of the material. The bibliography is contained in Appendix B. An index for all material covered, referencing both paragraph and page numbers, concludes the contents of this manual.

## CHAPTER 2

### HISTORICAL DEVELOPMENT OF ENERGETIC MATERIAL

#### 2-1. Introduction.

a. *Purpose.* This chapter describes the development of energetic material in chronological order.

b. *Scope.* This history is mainly concerned with military applications of energetic material, however some important nonmilitary uses are also discussed.

c. *Relationship of Development to Science and Technology.* Developments in the energetic material field are generally the result of a close relationship between basic research and technology. Advances in basic research provide new materials and new applications. The use of the new materials and new methods of application, as well as ideas from other fields, advance technology or even create new technology. The advancement of technology gives an impetus to further research. For example, the shaped charge effect was discovered in 1888. Little use of the principle was made until World War II, when technological advances made the tank a major battle weapon. At the present time, significant progress is being made in lessening the effect of a shaped charge on armor. This will require further development in energetic materials and their applications to defeat the newer types of armor.

d. *Interrelationship Among Explosives, Ammunition, and Weapons.*

(1) Explosives are the materials that detonate. They may be used independent of, or form a part of, ammunition. For military management purposes, the two are controlled as one category of weapons or armaments.

(2) Weapons are instruments of any kind used in fighting. We may consider weapons as the tools used in warfare. The development of these tools is the art or science of weaponry. Weaponry includes use of clubs, stones, slings, axes, spears, darts, javelins, bows and arrows, shields, body armor, etc. for hunting and fighting. Later, siege weapons such as catapults and ballista (the forerunners of cannon) were developed to hurl large stones and other missiles at fortifications. Better weapons created the need for a special group of artisans called metalworkers and metallurgists. The metalworkers began shaping the weapons from metals. The metallurgists practiced the art or science of extracting metals from their ores, refining them, and preparing them for use.

e. *Discoveries, Inventions, Developments.* Historians often disagree as to who was the first to discover, invent, develop, or use a new theory, characteristic, device, or material. Authenticating this information is a difficult task, for the records and terminology used to record these facts may be misleading. What has been published and used as an official source in subsequent documents may have been taken from an unreliable source. The history of energetic materials is particularly full of such examples. For example, who invented black powder or gunpowder? And, when was gunpowder first used? Sometimes the answer is that several or many people or nations were all involved at the same time.

#### 2-2. Early Use of Flame, Incendiaries, and Smoke.

a. *Flame and Incendiaries.* Flame and incendiaries are the oldest chemical weapons dating back to the caveman's use of flames and burning coals to drive off animals and enemies. In Biblical times, armies attacking and defending fortified cities threw upon each other burning oils and flaming fireballs consisting of resin and straw. In 424 BC, the Spartans successfully employed a prototype of the flamethrower against a Greek fort in Delium. Attaching a pot filled with burning pitch, coals, and sulfur to a hollow log, they used bellows to blow a hot jet of flame which set fire to the city walls and routed the defenders. Incendiary compositions of pitch, sulfur, hemp or flax, and resinous wood were used in the Trojan Wars about 360 BC. Centuries later, the Romans used similar materials in fire bombs or fire pots, which they catapulted over the walls of besieged towns. To set fire to wooden forts they used hollow, perforated arrows filled with incendiary materials, which were ignited just before being shot. The most famous of the incendiary mixes was "Greek Fire," which was prepared by Kallinikos of Heliopolis in Syria to enable the Byzantine fleet to defeat the Caliphate Navy in 668 AD. The exact formula for Greek Fire is unknown. However, the formula is believed to be a mixture of sulfur, naphtha, pitch, resin, and quicklime, which ignited and burned fiercely upon contact with water. The Greek Fire was apparently forced by water, under high pressure, through tubes or siphons. The violent reactions and high pressure ejected the burning incendiary mixture toward the enemy ships. For the next six centuries, the Byzantines used Greek Fire to thwart the Moslem and subsequent Russian sieges of Constantinople. Chinese

manuscripts as early as 969 AD mention fire arrows, fire lances, and incendiary "rockets." But with the exception of Greek Fire, such weapons had little impact on warfare until World War I.

b. *Smoke.* While history tells us that screening smoke was employed in early conflicts, the results of these isolated incidents were always too uncertain to justify the adoption of smoke as a recognized agent of warfare. In fact, prior to World War I dense clouds of smoke generated by the black powder used in battle had become a definite nuisance. These clouds obscured the field of vision, interfered with aiming and firing, and hampered the movement of troops. More recently, these very same characteristics have been exploited tactically by the planned employment of screening smoke munitions.

### 2-3. Invention of Fireworks and Black Powder.

a. *Fireworks.* Fireworks are devices that produce displays of lights, noise, or smoke by the combustion of explosive compositions. Fireworks are managed under that group of ammunition designated as "pyrotechnics." Those who ply this art are called "artificers." Some historians credit the Chinese with being the first true artificers. In the reign of Haiao Tsung of Nan Subng (1169-1189 AD), true fireworks made their debut. They were similar to those used today. The first fireworks were made of incendiary materials with various powdered minerals added to color, or to increase the light or smoke effect. Not until the invention of black powder were the artificers able to generate the displays with which we have become familiar today, such as Roman candles, rockets, fire crackers, serpentes, whistles, and stars. The French, in particular, became very adept at civil pyrotechnics by the 17th and 18th centuries. Civil pyrotechnics are generally limited to fireworks used for public display, signalling, or rescuing.

b. *Black Powder.* Authorities differ upon the origin of black powder accrediting in turn the Chinese, Hindus, and Arabs. In 1249 AD Roger Bacon, an English monk, recorded a formula for black powder - saltpeter (7 parts), charcoal (4 parts), and sulfur (4 parts). Although Bacon was not the inventor, his were probably the first truly scientific experiments with this explosive. Sulfur and charcoal had been used in incendiary compositions for many centuries. Saltpeter (potassium nitrate) appears in nature but requires refining to supply the proper amount of oxygen to ignite the black powder mixture. Bacon's knowledge of purified saltpeter probably came from the Arabs who obtained this

information from the Chinese about 1225 AD. Bacon mentioned in his writings that the ingredients of black powder were used in firecrackers made in various countries of the world.

### 2-4. Introduction of Gunpowder in Europe.

a. *Invention of Guns and Gunpowder.* The age of gunpowder began early in the 14th century with the invention of the gun, which consisted of a metal tube from which a projectile was discharged by the explosive force of black powder. Guns and gunpowder provided a new means of propelling stone, iron, or lead balls with greater force than catapults or slings. The discovery of the usefulness of black powder for accomplishing mechanical work may be considered the real beginning of the history of explosives. When ignited by a torch, a loose charge of black powder above the borehole of a gun served as a priming composition. A train of black powder in the borehole advanced the ignition to set off the propellant charge of black powder in the gun tube. The Chinese and Europeans evidently became aware of this application of black powder about the same time. Because Chinese developments did not keep pace with those in Europe, the Europeans have been credited with inventing and developing guns and gunpowder. The earliest mention of black powder on military supply lists was in 1326 AD. Also at that time, a Latin manuscript called "On the Duties of Kings," written by Walter de Milemete, King Edward III's chaplain, included the first known illustration of a cannon.

b. *Manufacture of Gunpowder.* Roger Bacon's black powder recipe was not for gunpowder. Different proportions of saltpeter, charcoal, and sulfur were required to propel missiles from the early cannon and firearms. In the mid 12th century, John Arderne, an Englishman, gave the proportions of saltpeter, charcoal, and sulfur as 6:2:1, the same as recommended by Marcus Graecus around 1275 and by Albertus Magnus in 1300. The Germans, who some scholars claim invented gunpowder and guns around 1313 (i.e., the legendary Berchtold Schwarz), were using a mixture of 4:1:1 in 1350. The ingredients were ground, mixed, and used in a fine powder or meal. At first, the materials were mixed in a mortar using a pestle operated by hand and were later mixed by horse power. Later, improvements in machinery mixed gunpowder with rollers on a marble slab and with wooden stamps. Mixing black powder was considered a highly technical art and a dangerous one too. Sometimes the final mixing was done at the gun site to reduce the hazard of stores exploding. Nevertheless,

the records of towns and armies during the early days of gunpowder contain many references to accidental explosions. Other mostly useless ingredients, such as amber, alcohol, camphor, wine, urine, arsenic, and sal armoniac, were added to the recipe to improve stability, reduce absorption of moisture, and to prevent crumbling. Depending on the weapon or the use, some countries varied the proportions of saltpeter, charcoal, and sulfur. For example, the French at one time made six different mixes - one strong and one weak each for pistols, muskets, and cannons. Different mixes have been used for blasting, mining, and sporting weapons. In 1895, most countries, including the USA, adopted the English standard 75:15:10 (saltpeter: charcoal: sulfur), which had been in effect since 1781. This standard is generally used for all arms, the only difference being in the size of the grains.

**2-5. Developments Between the 15th and 18th Century.** The development of energetic materials from 1400 to 1800 were restricted mainly to improvements in the manufacture of black powder and related applications. By 1400, iron cannons, bound by iron hoops to keep them from bursting, and iron cannon balls were coming into use. At the end of the 14th century, a hand gun was invented that weighed 4.5 kilograms (10 lbs) and fired lead shot. One man carried the gun, which was mounted on a stand and aimed at the enemy. This weapon evolved into the arquebus or harquebus, a hand gun with a bent stock and a forked staff to support the barrel while firing. A lit match or fuse of serpentine black powder was used to ignite the propellant powder charge through a touch hole in the breech (closed end) of the gun barrel. Other important events or developments during this period are as follows:

a. 1425. Corning, a new process for making black powder into grains instead of the finer serpentine gunpowder, was invented. Corning consisted of wetting black powder to form a paste, which was then pounded into a cake. The cake was broken into small lumps by hand and sifted. The resulting pieces, which were called corned powder, absorbed less moisture and were more suitable for use in cannons than the serpentine powder. Flame from the priming powder was distributed more efficiently by the larger grains. This resulted in a more complete explosion and reduced fouling.

b. 1540. Standard gunpowder grain sizes for pistols, muskets, and cannons were adopted by the French. They discovered that less powder was needed to propel a projectile if the grain size was controlled. By using uniform, slow-burning grains they were able to control the pressure of the explosion in the gun, and thereby reduce the hazard of blowing up the gun. This discovery also led to improvements in gun design.

c. 1560. Linen or paper bags containing gunpowder were used for charging cannons.

d. 1578. An instrument for testing gunpowder was devised by Bourne of England. Until then, the only test was to burn a small quantity to see how much residue would be left. The testing device consisted of a small metal cylinder with a heavy metal lid on a hinge. The lid was prevented from falling by a ratchet, and the angle to which the lid rose when powder was fired inside the cylinder measured the strength.

e. 1588. Explosive shells were used at the siege of Bergen op-Zoom and Wachtendonck, Holland by the Dutch. The shells were made from hollow iron balls filled with gunpowder. The gunpowder was ignited by a fuze consisting of a hollow tube filled with slow burning serpentine powder, and timed to burn 14 to 20 seconds, corresponding to ranges of 914 to 1830 meters (1000 to 2000 yards) for mortar fire. The knowledge for making this fuze was brought to the Dutch by an Italian deserter from Parma.

f. 1590. Cartridges with ball and powder combined were introduced for small arms.

g. 1602-1604. Fulminating gold, later used as a priming explosive, was invented by Johann Tholden, a Dutch chemist in the employ of the British Navy.

h. 1611-1632. An improved paper cartridge was developed during the rule of Swedish King Gustavus Adolphus, thus increasing the rate of fire for firearms used in the Thirty Years' War.

i. 1613. Blasting powder is reported to have been used in German mines to blast rocks. Less saltpeter and more charcoal and sulfur were used in blasting powder than in gunpowder.

j. 1627. An improved instrument for testing black powder was devised by Curtenbach. This consisted of a heavy conical shot, which rested on the mouth of a small mortar and could travel vertically upwards along a stretched wire provided with a series of catches to stop the shot from falling.

k. 1627. Black powder was used to blast ore in the royal mines at Schemnitz, Hungary following experiments by a Hungarian engineer, Kaspar Weindl. Using black powder for this purpose was slow to be accepted because saltpeter was expensive, boring instruments were not available, and safety hazards from mine gases and cave-ins were increased.

l. 1628. Gold fulminate priming explosives for torpedos were invented by J. Thollen for the British Navy.

m. 1647. Testing the strength of gunpowder, by firing a ball from a mortar and measuring the distance the ball travelled, was proposed by Master-Gunner Nye in his "Art of Gunnery." This mortar test was adopted by France and other countries soon afterward.

n. 1654. Ammonium nitrate was first prepared by J. R. Glauber, a German chemist.

o. 1679. Blasting powder was used on a large scale in the construction of the Mal pas Tunnel, Canal de Midi, France.

p. 1684. Glazing process for gunpowder was introduced. Rough gunpowder corns were glazed by tumbling them in large wooden drums until the grain surfaces were smooth. Graphite was added to coat the grains. Glazed gunpowder was less hygroscopic and flowed more easily than the unglazed gunpowder.

q. 1735. Antimony sulfide and arsenic sulfide were used by Ruggieri of Italy in pyrotechnic mixtures for brilliant fireworks displays at Versailles.

r. 1738. The closed bomb for measuring the pressure generated by gunpowder fired in a closed vessel was designed by d'Antony of Italy.

s. 1742. The ballistic pendulum, which determined the velocity of a projectile's impact by measuring the recoil of a struck pendulum, was invented by Benjamin Robins, an English mathematician. Robins showed that air resistance on a moving projectile at high velocities is greater than the resistance at low velocities. Robins also developed the first practical chronograph, an instrument for measuring and recording short durations of time, and improved on a closed bomb for testing the power of an explosion.

t. 1771. Picric acid was first prepared by Pierre Woulfe, a French chemist, by treating silk with nitric acid. Picric acid is an aromatic nitro compound which was used as a yellow dye until its explosive properties were discovered in 1871.

u. 1784-1788. Potassium chlorate was prepared in its pure state by Claude L. Berthollet, a French chemist who discovered its detonating properties. His idea of using potassium chlorate instead of potassium nitrate in black powder was abandoned after a disastrous explosion during manufacture in 1788. Berthollet also prepared fulminating silver in 1788.

v. 1784-1789. Compact black powder grains were obtained by pressing the cakes with screw presses before corning at Faversham, England.

**2-6. Nineteenth Century Development.** Modern energetic materials technology began with the nineteenth century. New energetic materials began to

displace the black powder formulas that had been the choice for use in weapons, ammunition, and blasting for over 350 years. The discovery of new materials or the practical application of previously known materials (for example, picric acid) greatly influenced the design and performance of weapons and ammunition. In turn, the rapid development of weapons and ammunition, and the increased demands of new and expanding industries further accelerated the search for more effective, less expensive materials. During the nineteenth century, more powerful propellants (such as smokeless powder), better primers, various boosters or detonators, and new high explosives were introduced. There were significant advancements in the science and technology of weapons and ammunition, too. Among these were improved explosive (Congreve) rockets (later adapted for signaling and illumination), rifled arms, revolvers, magazine-loading rifles, machine guns, revolving turrets, armored naval vessels, percussion caps (encapsulated primers), metallic cartridges, time fuzes and impact fuzes for artillery shells, rifled breech-loading field artillery, obturation devices, and spring and hydro-pneumatic recoil mechanisms for artillery. Modern mass production began when Samuel Colt, an American gunsmith, first manufactured standard rifle and revolver parts. Mass production of small arms ammunition began when G. Moore Peters used the first cartridge-loading machinery at his factory in Ohio. Nineteenth century developments of energetic materials follow.

a. 1800. Mercury fulminate was discovered by Edward Howard, an English chemist, who described its detonating properties in a paper before the Royal Society.

b. 1801. Fireworks formulas containing metal salts and ammonium chloride were published by C. F. Ruggieri, an Italian artificer. These salts produced brighter flames because volatile metal chlorides were formed during the combustion reaction.

c. 1807. The principle of using mercury fulminate as a primer was patented by Rev. Alexander J. Forsyth of Aberdeenshire, Scotland.

d. 1823. Chlorates, discovered by C. F. Berthollet in 1786, were first used in fireworks by John Cutbush, an English artificer.

e. 1825. Benzene, creosote, and naphthalene were isolated from coal tar (obtained from bituminous coal) by Rev. Dr. Clayton in England. Most of his products were later nitrated to produce explosives, such as trinitrobenzene and nitronaphthalenes.

f. 1826. Aniline was first prepared by Unverdorben. Later, nitration of aniline resulted in the very powerful explosive called tetranitroaniline.

g. 1831. Safety fuse for blasting was invented by William Bickford of Cornwall, England. The Bickford fuse consisted of a core of black powder tightly wrapped in textiles (mainly jute yarn). The timing, or burning time, for a given length of fuse was very accurate and consistent. This fuse soon replaced the less reliable fuses which were made of straws or quills filled with black powder, thus greatly reducing the hazard of accidental explosions in mining or construction. Later, the Bickford safety fuse was waterproofed by applying a coat of asphalt covered with either a textile or plastic.

h. 1832. Ammonium perchlorate was first prepared by E. Mitscherlich, a German chemist, who also nitrated benzene and toluene in 1833 or 1834.

i. 1833. Nitrostarch was discovered by Henri Braconnot, a French chemist, while dissolving starch in concentrated nitric acid to form a flammable nitric acid ester of starch. This is considered to be the beginning of modern high explosive technology.

j. 1837-1838. Nitrated paper, soluble in ethyl alcohol, and nitrated cotton fibers, insoluble in ethyl alcohol, were prepared by Prof. Theophile Jules Pelouze, a French chemist. These products were highly combustible.

k. 1841. Ammonium picrate was first prepared by Marchand, and was used in 1869 by Brugere as a propellant.

l. 1843. Picric acid, discovered but not identified by Peter Woulfe in 1771, was rediscovered by A. Laurent who found that some of the salts were explosive.

m. 1845. Guncotton was prepared by Christian F. Schoenbein, a German chemist, while at the University of Basel, Switzerland. Upon nitrating cotton with mixed nitric acid and sulfuric acid, he demonstrated that the resulting nitrocellulose was up to four times as powerful as black powder for blasting. The guncotton burned without leaving an ash. Schoenbein also prepared the first nitrosugar, which deflagrated suddenly and violently when heated to a certain point. Schoenbein and R. Boetter of Frankfurt, Germany, who had discovered guncotton independently, obtained patents in 1846 and 1847 under the title: "Improvement in Preparation of Cottonwool and Other Substances as Substitutes for Gunpowder." Serious accidental explosions during early attempts to manufacture guncotton in 1847 delayed its acceptance as an explosive; however, guncotton eventually became accepted universally for use in blasting and for smokeless powder when mixed with nitroglycerin.

n. 1846-1847. Nitroglycerin, an ester of glycerin and nitric acid, was invented by Asconio Sobrero, an Italian chemist. Because nitroglycerin is very sensitive to slight shocks, commercial use was delayed until the invention of dynamite and blasting gelatin. Nitroglycerin was also used later to make smokeless powder.

o. 1847. Mannitol hexanitrate or hexanitro-mannitol was first prepared by A. Sobrero, but the explosive properties were not examined until 1878 when N. K. Sokoloff of Russia investigated these characteristics.

p. 1847. Cyanuric triazide was first prepared by Auguste A. T. Cahours, a French chemist.

q. 1850. A testing device for measuring explosive pressure in cannons was developed by Col. George Bomford of the US Ordnance Department. Bomford inserted pistol barrels in holes drilled along the gun tube and measured velocities of bullet blowout. Based on these data, the weight of guns could be reduced.

r. 1850. An improved testing device for measuring explosive pressures in cannons was designed by LTC Thomas J. Rodman of US Ordnance Department. Pistons with punch-type ends were installed at intervals on the cannon and were forced by the explosion of the propellant into copper blocks. Measuring the depth of the indentations indicated the relative pressures along the length of the gun tube. Rodman also developed a process of casting guns hollow and cooling them from within. The Rodman process put the metal surrounding the bore of the gun under a permanent compressive strain that greatly increased the gun's resistance to interior pressures.

s. 1853. Nitroglycerin absorbed in magnesia was developed by V. F. Petrushevskii, a Russian officer, for use in mining gold in Siberia. This was a precursor of dynamite.

t. 1857-1858. Sodium nitrate deposits found in Chile were originally converted to saltpeter (potassium nitrate) by reaction with potassium chloride, which was also in plentiful supply. Lamont du Pont, an American industrialist, introduced a new formula for black powder using sodium nitrate in lieu of potassium nitrate. Black powder containing potassium nitrate was called blasting powder A, and black powder containing sodium nitrate was called blasting powder B. Blasting powder B was less expensive and more hygroscopic, which made it more suitable for blasting. Powder formulas were considered more suitable for firearms, safety fuses, and fireworks.



u. 1858. Diazo compounds were discovered by Peter Griess, who also prepared dinol or diazodinitrophenol.

v. 1859. Ethylene oxide, ethylene glycol, and ethylene glycol ether were prepared by Charles A. Wurtz. A century later, ethylene oxide was used in fuel-air explosives (FAX) developed by the US Armed Forces. Diethylene glycol was also developed simultaneously in 1859 by Wurtz and A. V. Laurenco.

w. 1860. A caseless propellant, consisting of cakes of compressed black powder cakes or grains with perforations, was developed by T. J. Rodman while working at Frankford Arsenal, Philadelphia. This led to the use of grains shaped into hexagonal prisms about 2.54 cm (1 inch) long and 2.54 cm (1 inch) across. Perforations and grooves in the grains channel the flame from the explosion. As the grains burn inward from the prism surfaces and outward from the perforations, the burning gases flow continuously, thereby permitting the explosive energy to build up gradually until the maximum power is exerted as the projectile leaves the muzzle of the gun. This acceleration imparts a more efficient thrust to the projectile and extends the range of the gun.

x. 1861. Guanidine was formed by the oxidation of guanine by Strecker. Guanine is a derivative of guano, which was formed from manure, especially that of birds and bats.

y. 1863. Trinitrotoluene (TNT) was prepared by J. Willibrand, German scientist. Although TNT was used for many years in the dye industry, TNT was not used as an explosive until 1904. Thereafter, TNT became one of the most used high explosives.

z. 1862-1866. Nitroglycerin production plants were designed for commercial applications by Alfred Bernard Nobel, a Swedish chemist, based on studies conducted with his father, Emmanuel, in 1859-61. In 1862, they built their first plant at Heleneborg, Sweden. Despite the tragic loss of his brother Emil in an explosion at that plant in 1864, Alfred erected two more plants in 1865 and another in 1866.

aa. 1865. Magnesium was first used for pyrotechnics.

bb. 1865. Nitrocellulose was purified by Sir Frederick A. Abel, an English chemist, who also successfully manufactured granulated nitrocotton. Abel pulped, washed, and compressed the nitrocellulose into blocks, sheets, discs, and cylinders, which were particularly useful for blasting.

cc. 1865. Smokeless powder, used as a sporting propellant, was invented by Schultze, a Prussian officer,

through nitrating wood, washing the wood with a dilute solution of sodium carbonate, and drying.

dd. 1866-1867. Dynamite was invented by A. Nobel by absorbing nitroglycerin (75) in kieselguhr (diatomaceous earth) (25). Kieselguhr, an inactive ingredient, stabilized the nitroglycerin, and made dynamite a much safer explosive to handle and use.

ee. 1867. The fulminate blasting cap, a device consisting of mercury fulminate in a copper tube used to detonate explosives, was invented by A. Nobel. This cap was crimped to one end of a safety fuse (e.g. Bickford fuse), and then inserted into the dynamite cartridge.

ff. 1867. Ammonium nitrate, pulverized and mixed with sawdust or charcoal, was proposed as an absorbant for nitroglycerin by J. H. Norribin and C. J. Ohlsson, Swedish inventors.

gg. 1868. Dry compressed guncotton was detonated with a mercury fulminate detonator by E. A. Brown, an English chemist, who also discovered that wet guncotton could be exploded by the initiation of a small quantity of dry guncotton. This important discovery, on the principle of a booster explosive, led to the use of large blocks of wet guncotton in naval mines with comparative safety.

hh. 1869. Dynamites with an active base were patented by A. Nobel. To create an active base dynamite, Nobel mixed nitroglycerin with combustibles (sawdust, charcoal, rosin, and starch), and oxidizers (sodium nitrate or potassium nitrate). This led to a more efficient explosive than guhr dynamite.

ii. 1870. Ohlsson and Norribin's patent for ammonium nitrate dynamite was purchased by A. Nobel, who subsequently began production of ammonium nitrate dynamite.

jj. 1871. Sprengel explosives, which consisted of mixing various combinations of oxidizing agents (chlorates, nitrates, and nitric acid) with combustibles (nitronaphthalene, benzene, and nitrobenzene), were patented by Hermann Sprengel, a German chemist. Oxidizing agents and liquid fuel were mixed on site before using.

kk. 1875. The "Explosives Act" was passed by the British Government after a disastrous explosion at Birmingham killed 53 persons. The Explosives Act established Inspectors of Explosives, who were given the power to inspect all magazines and factories to ensure that operations were carried out in a reasonably safe manner. As a result, the number of deaths in explosives factories was greatly reduced. The provisions of this act have been adopted by many other countries.

ll. 1875. Gelatinous dynamites and blasting gelatins were patented by A. Nobel.

mm. 1877. Nitroguanidine was first prepared by Jousselein, but was not used in propellants until 1900.

nn. 1879. Tetryl, a booster explosive, was first prepared by Michler and Meyer of Germany.

oo. 1879. Ammonium nitrate gelatins, known as ammonogelatins, were patented by A. Nobel.

pp. 1882. Brown or cocoa gunpowder was made by the Germans using partially burned charcoal from rye straw. The grains were made in single, perforated hexagonal or octagonal prisms. Brown powder was of higher quality, but was more sensitive to friction than black powder. The United States used brown powder during the Spanish-American War.

qq. 1883. Tetryl was synthesized from picryl chloride and potassium methylnitramine by van Romburgh, a German chemist.

rr. 1883-1884. Colloided rifle powder was prepared by Max von Duttenhofer by nitrating brown charcoal before mixing the ingredients. This brown powder was adopted by the German Army in 1884.

ss. 1884. Smokeless powder, for military rifles, was invented by Paul Vieille of France. This powder was a completely colloided single-base nitrocellulose propellant. The French Army adopted Vieille's Poudre B. in 1866.

tt. 1884-1885. High-speed photographic cameras were used for ballistic studies by Eugene Mach and P. Salcher of Austria.

uu. 1885. Two flashless powders, ammonpulver and amidpulver, were patented and made by Gaens of Hamburg from ammonium nitrate, potassium nitrate, and charcoal.

vv. 1885. The Hell Gate blast in New York Harbor used 34,000 kg (75,000 lbs) of dynamite, and 11,000 kg (24,000 lbs) of potassium chlorate soaked in nitrobenzene (rack-a-rock) to remove Flood Rock, a menace to navigation. This was the largest amount of explosives used in a single blast until then.

ww. 1885-1888. Eugene Turpin, a French scientist, patented the process of melt-pouring picric acid into artillery shells as a high explosive filler. Sprengel had discovered that picric acid could be initiated by a powerful detonator, but had not exploited this knowledge. The French Government adopted a high explosive shell designed by Turpin using a picric acid filler. They designated the picric acid filler as melinite. In 1888, the British adopted picric acid, which they called lyddite as an high explosive filler.

xx. 1888. The shaped charge effect was accidentally discovered by Charles E. Munroe, an American scientist, at the Naval Academy. Munroe discovered that a concave-shaped explosive charge pierces a steel plate.

yy. 1888. Cyclotrimethylene trinitrosamine was discovered by Griess & Harrow and by Mayer, yet was not used until the Germans, who called it R-salz, used the composition in World War II.

zz. 1888. Ballistite, the first double-base smokeless propellant, was prepared by Alfred Nobel by replacing camphor with nitroglycerin. In 1889, Nobel prepared ballistite from collodion cotton and nitroglycerin using a solventless method.

aaa. 1888-1889. Cordite, the second successful double-base smokeless propellant, was prepared by Dr. W. Kellner in F. Abel's English laboratory. Sir James Dewar, British chemist and physicist, and Abel patented cordite for the British Government, which adopted cordite as a military propellant named Cordite Mark I or CSP (cordite smokeless powder).

bbb. 1890. Tetranitrocarbazole, used in igniter and pyrotechnic compositions, was first prepared by Karl Graebe, a German chemist. The current method of preparation was developed in 1912 by the Leopold Cassella Company in Frankfurt, Germany, a division of the Interessen Gemeinschaft (I. G.) Farben corporation.

ccc. 1889-1890. The development of explosive devices was greatly enhanced by the work of Theodor Curtius, German Nobel prize laureate, who discovered hydrazine in 1889 and hydrogen azide in 1890. He subsequently suggested to the German military the use of metal azides for primer application.

ddd. 1892. Tetranitrooxanilide was prepared by A. G. Perkin, an English scientist, and used as a component in black powder type explosives and pyrotechnic compositions.

eee. 1894. Butanetriol trinitrate, used a half century later as an explosive plasticizer for nitrocellulose, was first prepared by Wagner and Ginsberg.

fff. 1895. Liquid oxygen explosive (LOX), carbon black packed in porous bags and dipped in liquid oxygen, was introduced by Karl P. G. von Linde of Germany. LOX was widely used by Germany during World War I, and in the United States Midwest for strip-mining in the 1950's.

ggg. 1896. A layered smokeless propellant, which was prepared by glueing and compressing together several layers of different components, was patented by A. B. Bofors, Nobelkrut of Sweden. The outer layers were slow-burning, while the burning speed increased progressively towards the inner layers.

hhh. 1897-1898. Cheddite, an explosive for blasting consisting of potassium chlorate or perchlorate mixed with a nitro compound and castor oil, was invented in England by E. Street. Cheddite derives its name from Chedde, France, where it was made.

iii. 1899. Potassium dinitrobenzefuroxan, used in priming compositions, was first prepared by P. von Drost.

jjj. 1899. Cyclonite (RDX) was first prepared by Henning of Germany. Henning used RDX, which he called Hexogen, for medical purposes. The first to recognize the value of RDX as an explosive was E. von Herz of Germany. The first to prepare RDX in quantity was G. C. Hale of Picatinny Arsenal, NJ, in 1925. However, it was not until World War II that the most important work in manufacturing processes and applications of RDX was done.

kkk. 1899. Aluminized explosives, containing aluminum to increase the performance of explosives, were first proposed by R. Escales of Germany and were patented by G. Roth. Ammonal, their first, contained ammonium nitrate, charcoal, and aluminum.

**2-7. Twentieth Century Development through World War I (WW I).** This period saw the use of cordite smokeless powder and repeating rifles by the British during the Boer War (1899-1902) in South Africa; large scale naval battles and full-scale use of machine guns in the Russo-Japanese War (1904-1905); and the introduction of submarine warfare, armored tanks, aerial bombing of civilians by dirigibles, and strafing and bombing by aircraft during World War I (1914-1918). World War I saw concentrated machine gun fire, artillery barrages, firing long ranges from railroad guns and from large guns on battleships, firing torpedoes, laying mines, using depth charges in anti-submarine warfare, and signaling and illuminating with flares. Soldiers were issued steel helmets and gas masks for individual protection.

a. 1900. Cordite smokeless powder, used by the British in the Boer War, caused excessive corrosion in gun barrels. As a result, the formula for cordite was changed to reduce the amount of nitroglycerin from 58% to 30% and to increase the amount of nitrocellulose to 65% with the amount of mineral jelly remaining at 5%.

b. 1900. Picric acid (British lydite) shells were used in the Boer War but did not detonate completely. This was attributed to faulty construction of the detonators.

c. 1900. The Contact Process for manufacturing concentrated sulfuric acid and oleum was discovered by Badische Anilin-und Sodafabrik of Germany. This process was less expensive than the chamber method previously used. As such acid was required for mixed nitric-sulfuric acid to nitrate aromatic hydrocarbons to polysubstitution, trinitrobenzene and trinitrotoluene (TNT) could be inexpensively manufactured.

d. 1900. Chromatography, a physical method of separation in which the components are partitioned between two phases, was invented simultaneously and independently by American geologist D. T. Day and Russian botanist M. S. Tsvet. The qualitative method of separation of ingredients by adsorption was known for centuries.

e. 1900. Regular-delay electric blasting caps for rotational shooting (0.5 to 12 seconds) developed.

f. 1901-1904. A trinitrotoluene (TNT) manufacturing process consisting of three phases was developed by C. Haussermann of Germany. This method, which proved to be more economical than direct nitration of toluene to TNT, was used in the United States until World War II. The German industry adopted this process in 1902, when they adopted TNT as the filler for high explosive shells. They also used TNT for demolition purposes, replacing picric acid.

g. 1902. Detonating cord, developed in France, was improved, leading to adoption in the United States by the Ensign-Bickford Company in 1912.

h. 1902. Antifreeze for dynamite was researched extensively in many countries following a disastrous explosion during defrosting dynamite in Greisnau, Germany. The problem of producing a satisfactory antifreeze remained unsolved until S. Nauckhoff of Sweden published his work in 1905, listing requirements for a satisfactory antifreeze, and compounds which met these requirements.

i. 1903. A muzzle-flash suppressor using vaseline with 1-2% sodium bicarbonate was proposed by Rottweil Fabrik of Germany. This was replaced in 1905 by soap or rosin.

j. 1904. The Obermueller Stability Test, which consisted of heating 1-2 grams of nitrocellulose in a small tube under vacuum at 135-140° and measuring the pressure of evolved gas by vacuum manometer, was introduced.

k. 1904-1905. Methyl picrate (2,4,6-trinitroanisole) was patented for use in smokeless propellants. The powder consisted of an equal amount of methylpicrate and pyrocellulose.

- i. 1905. Nitrostarch was produced in a stable form. Nitrostarch is similar to nitrocellulose but is lower in strength. Nitrostarch does not cause headaches from skin contact as do TNT, nitroglycerin, dynamite, and many other explosives.
- m. 1906. Various substituted ureas, called centralites and akardites, were developed at the Central Laboratory for Scientific and Technical Research at Neubabelsberg, Germany, for chemical stabilizer application in smokeless powders.
- n. 1906. Lead azide was proposed by Col. A. A. Solonina of Russia for use in compound detonators (initiating explosives) in lieu of mercuric fulminate.
- o. 1906. Hexanitroazobenzene was prepared by E. Grandmougin and H. Lehmann of France, and recommended by Tenny L. Davis for use in boosters.
- p. 1907. Diphenylamine, designated as poudre B, was approved as a stabilizer for French naval cannon propellants and other large caliber guns. This stabilizer replaced amyl alcohol after the disastrous explosion in 1907 of the battleship *Lena*.
- q. 1907. Mixed glycol esters, such as dinitroacetin with dinitroformin, were patented as dynamite antifreeze by Vezio Vender of Italy.
- r. 1908. A detonating cord (cordeau detonant) containing TNT instead of blackpowder was patented in France. This detonating cord had a detonation velocity of 4,880 meters (16,000 feet) per second.
- s. 1909. Ammonium picrate (Dunnite or Explosive D) was standardized in the United States as a bursting charge for armor-piercing (AP) shells. These AP projectiles could be fired through 12 inches of armor plate, and could be detonated on the far side by an insensitive primer.
- t. 1909. Low-nitrated aromatic hydrocarbons, because of their stability and insensitivity to shock and to ignition, began to be used in coal mining explosives compositions.
- u. 1909. Solventless powder (or propellant) was discovered by Brunswig and Thieme of Germany, although many others contributed to the development of such propellants.
- v. 1910. Preparation of 2,3,4,6-tetranitroaniline, a powerful explosive, was patented by Flurschein. This explosive was used during World War II by the Germans and Japanese.
- w. 1910. Tetracene was first prepared by K. A. Hofmann in Germany. More extensive studies of the compound were conducted in 1931 by Rinkenbach and Burton.
- x. 1910-1913. Laminated solventless propellants were prepared by Dr. C. Claessen, a German scientist. Making propellants into large solventless grains was less time consuming than making solvent propellants.
- y. 1912. TNT was adopted as the standard bursting charge in high explosive shells for the field artillery of the US Army.
- z. 1912. Nitroisobutylglycerol trinitrate or trimethylol nitromethane trinitrate, used as an explosive gelatinizer for nitrocellulose, was first prepared by Hofwimmer.
- aa. 1912-1913. Tetranitroaniline (TNA) was patented by Dr. B. J. Flurschein, an English scientist.
- bb. 1914. Lead styphnate (trinitroresorcinol), an initiating explosive, was first prepared by E. von Herz of Germany. Col. A. A. Solonina of Russia was the first to propose using lead styphnate in compound detonators.
- cc. *World War I*. The high-explosive technology of the contending powers greatly influenced the conduct of World War I. At the outbreak of war in the summer of 1914, the German General Staff had planned to fight a high-explosives war of great intensity. Their plan was to mount a sudden and overwhelming attack using vast stores of artillery ammunition accumulated over the preceding forty years. After the battle of the Marne in 1914, the Germans realized that explosives production must be expanded; and they turned to their dye industry for this expansion. When the war began, Germany's chemical industry was producing 85% of the world's dyes. The Germans were able to rapidly convert their plants to production of synthetic ammonia, nitric acid, and sulfuric acid, which were required for the manufacture of explosives and chemical warfare agents. When Germany's access to Chilean saltpeter was cut off by the Allied blockade, the key to the German war production of explosives was the Haber process for producing ammonia from atmospheric nitrogen. By expanding their nitrogen plants at Oppau and Mersberg, Germany was able to become independent of foreign countries for the supply of ammonia and nitric acid. Because these chemicals were so essential for the manufacture of explosives and fertilizer for food products, it is doubtful if Germany could have continued the war beyond 1916 without the amazing speed with which the I. G. Farben concern was able to convert their dye plants to explosives plants. For example, at Leverkusen, a TNT plant producing 250 tons per month was put into operation in six weeks. The major powers began accelerating the search for substitutes or supplements to TNT. The most important were mixtures of high explosives, such as TNT, TNX, and TNN, with ammonium nitrate and aluminum. By 1914, the French had already begun

replacing picric acid (melanite) with TNT. In 1915, the British developed amatol (TNT plus ammonium nitrate) to extend the supply of TNT. In 1917, Austrian ammonal T (TNT, aluminum, and ammonium nitrate) was developed by R. Forg to be used in underwater explosives, such as torpedoes and depth charges. Lead azide was introduced as an initiator, and tetryl was used as a booster explosive for artillery shell charges. About 2,500,000 tons of high explosives were used by the contending powers during the war, resulting in an estimated 10 million casualties.

dd. *World War I.* High-explosive aerial bombs were first dropped from German Zeppelins during the 31 May 1915 raid on London. The Germans continued to use these dirigibles, practically unopposed, in their air raids on London and Paris until late in 1916. Then the British and French began to counter these attacks with anti-aircraft gunfire and fighter aircraft. Soon the Germans began using their large Gotha bombers, which they employed throughout 1917 and 1918. In retaliation, the Allies began producing fleets of larger bombers and various high-explosive bombs.

ee. *World War I.* Incendiary bombs were also first used during the German Zeppelin raid over London on 31 May 1915, when one dirigible dropped 90 incendiary bombs. The early incendiaries used by the Germans in their air raids over London and Paris were made from a mixture containing manganese dioxide and magnesium. Later, the French used sulfur-bound thermite, a mixture of iron oxide and powdered aluminum, in an incendiary drop bomb. The British were the first to develop incendiary bomb clusters, which could release either 144 or 272 bomblets. A De Havilland bomber could dispense up to 860 of these 6.5 oz incendiary bomblets, and a Handley-Page V bomber could dispense up to 16,000. By flying in formation, these bombers could cover a large area with a blanket of burning incendiary materials.

ff. *World War I.* Flamethrowers were first introduced by the Germans on the French front on 25 June 1915. Their weapon was a cylindrical steel vessel about 61 centimeters (2 feet) high and 38 centimeters (15 inches) in diameter, fitted with carrying straps. Internally, the cylinder was divided into a compression chamber and an air reservoir. A short hose carried the fuel to the nozzle where it was ignited. The propellant was nitrogen. The fiery spurt of burning oil, the roar of the flame, and the billowing clouds of black smoke had a terrifying effect on troops in trenches. Using this prototype of the modern portable flamethrower, the Ger-

mans drove back a British rifle brigade from trenches near Ypres, Belgium, in 1915. The Americans used a heavy viscous tar and a more fluid, flammable liquid such as crude benzene for their flame fuel mixture. A hydrogen pilot lamp at the flamethrower nozzle was used to ignite the flame fuel. The World War I flamethrowers had a range of about 30 meters. Although effective for assaulting fortifications, the flamethrower was also very hazardous for the operator because of its short range.

gg. *World War I.* Smoke munitions were used both on land and sea by the belligerent powers in World War I. In July 1915, the British were the first to use smoke pots, which were filled with pitch, tallow, black powder, and potassium nitrate. The first large-scale smoke operation occurred on 20 September 1915, when the Canadians fired several thousand smoke shells from trench mortars during the attack against Messines Ridge. Although very successful against the Germans, the British and French tanks of World War I were capable of travelling only four miles per hour, which made them very vulnerable to artillery fire. The British Tank attack at Cambrai on 20 November 1917 was supported by intense artillery smoke shelling, which enabled 350 tanks to break through the German lines. On 15 June 1918, the Austrians used smoke to screen their crossing of the Piave River, from Vidor into San Giovanni, from Italian machine gun concentrations. The Allies generally used white phosphorus (WP) to fill their smoke shells; whereas the Germans, because of a shortage of phosphorus, used a mixture of sulfur trioxide in a chlorosulfonic acid solution. The Germans used this type of smoke (FS) to successfully screen their warships during the battle of Jutland in 1916. Later, the United States adopted FS smoke for use in spotting rounds, for liquid chemical agent shots, and in airplane smoke tanks. FS was reclassified obsolete in November 1975 because WP was considered better for marking targets and FS droplets from aerial spray destroyed the nylon fabric in parachutes. Titanium tetrachloride (FM) was also used as a filler for spotting rounds during both world wars, but was removed from the US inventory because of its high cost. In 1918, tanks carried containers filled with chemicals, which when injected into the vehicle exhaust system formed a cloud of screening smoke. Sulfuric acid, chlorosulfonic acid, oleum, and crude oil were used as the smoke screening agent in these early smoke generators. WP hand and rifle grenades were used by the infantry for screening movements. The main disadvantage was the danger of the user being exposed to falling particles of burning white phosphorus, which is also an incendiary. WP grenades were reclassified obsolete in November 1975 by the US Army.

hh. *World War I.* Incendiary artillery shells and rifle bullets were introduced in 1915 to set fire to buildings, supply dumps, and enemy observation balloons. The Germans used sodium in their 17.5 centimeter artillery shells. They also used thermite or an aluminum-thermite mixture in their other artillery rounds. The Allies used thermite most frequently. Thermite incendiary grenades were issued to raiding parties for hasty destruction of captured enemy weapons that could not be retrieved.

ii. *World War I.* Pyrotechnics for battlefield illumination were used extensively during World War I. The British alone used 10 million position light flares per month. The art of making illuminants had been neglected after the reign of Louis XIV until the twentieth century. In 1913, the German Krupp Works developed an illuminating projectile, which they called a searchlight shell and which later became known as the star shell. The first star shell contained six small tubes, called stars, loaded with an illuminating composition. The mixture used was similar to that in the white Bengal lights for fireworks displays; but ribbons of magnesium were substituted for antimony powder. A folded parachute was placed in the bottom of each tube. The projectile was fired from a cannon or mortar. When the projectile reached a height of 300 meters, a mechanical time fuze set off a small black powder charge releasing the tubes from the shell and igniting the pyrotechnic mixture. Springs were used to open the parachute instantly, and the tube with its burning star floated slowly to earth. The illuminating material burned very brightly for 45 seconds to several minutes depending upon the model. The French constructed a similar projectile containing eight cylinders, which was fired from their 155 millimeter howitzer. However, they preferred using burning-type fuses to set off the powder charge in their star shells. Later, the Germans replaced the star tubes with a six-sided prism, which was more compact and could be adapted for use with rifles, special pistols, and large caliber carbines. By using plates to retard the fall of the star, more space was made available in the star for storing the illuminating mixture; and a light of greater intensity or longer duration was obtained. The Italians used a hand-held, heavy pasteboard tube to discharge a sheet-iron star shell tube, which expelled its illuminating parachute flare. This flare burned about 40 seconds. Many different illuminating devices were developed and used by both sides, but perhaps the simplest and most useful for trench warfare was the illuminating grenade. Thus every soldier on night patrol had his own device for lighting his sector, and exposing the advancing enemy to aimed gunfire.

jj. *World War I.* During World War I, pyrotechnics for signaling included colored smoke cartridges, can-

dles, flares, streamers or trails, star signals, and night signals. Four general designs of firework devices were in constant use by the French and the British armies. These devices were Very-type signal pistols, rifle lights, rockets, and ground or position signals (e.g. candles). (The same type of devices were used for illumination.) The signal-pistol cartridges used by the French were fitted with delay fuzes, which effected the ignition when the projectile reached its maximum height. Some realization of the development in pyrotechnic construction due to the war may be had by considering the latest production of the French 35-millimeter signal cartridge, which included 14 varieties or combinations of signals. Upon entering the war, the United States adopted many of the French signals for Army use. This was mainly because the American forces were to operate in the French sector, which necessitated an identical system of signals. Generally, the fireworks and devices employed by the Germans were similar to those of the French, but there was an important difference in the method of construction for the signal-pistol cartridge. The German cartridge was ignited just after emerging from the barrel of the pistol. Rockets mounted on sticks for stabilization during flight were employed by the Allies. The Germans followed Congreve's construction in the use of metal, but modified the design to eliminate the use of a stick. In the German rocket, the openings for escaping gas were in the base. Before the outbreak of the war, the art of pyrotechny had reached such a point that little difficulty was encountered in securing adequate mixtures for the various colors required in signaling. Different colored flares had been used for many years commercially. The railroad companies regularly employed pyrotechnic devices, such as red railroad fusee, while blue light pyrotechnics were used for signaling at sea. The colors used by the Allies included red, green, yellow, blue, black, various numbers of white stars, and changing colors. The Italians used a tri-color parachute flare, which emitted red, white, and green colors. The Italians also developed a hissing flare, which, when suspended from a parachute, burned with a hissing noise audible over an area of 3,000 meters (3,284 yards) in diameter. This was found particularly effective as a gas alarm. Some of the ingredients used in the WW I pyrotechnics were aluminum, potassium nitrate, sulfur, antimony sulfide, antimony metal, dextrine, meal powder, barium chlorate, potassium chlorate, fine charcoal, barium nitrate, red gum, paris green, shellac, sodium oxalate, magnesium carbonate, strontium carbonate, calomel, copper oxychloride, calcium carbonate, sawdust and grease mixture, sugar, lamp black, ultramarine blue, paranitraniline red, lactose, auramine, chrysoidin, synthetic indigo, phosphorus, paraffin, and arsenic.

**2-8. Developments after World War I through World War II.** The most complicated task confronting the US Army Ordnance Department at the end of World War I lay in the field of ammunition. Combat experience had shown the inadequacies of the ammunition used in 1917-1918, which were inaccuracies, failures, lack of safety features, and a host of needless complexities. But whereas the combat arms could specify exactly what the gun and vehicle requirements should be, their recommendations for the development of explosives, propellants, projectiles, and fuzes had to be couched in general terms. Here were basic research problems that ammunition experts had to define. Often they sought interim solutions, and waited until greater knowledge could supply better answers. Hence the ammunition designers had free reign within budgetary limits. Over the 20 years between the two world wars, the Army dedicated more money to the ammunition program than to any other development work. During these two decades, RDX, PETN, EDNA, DEGN, lead styphnate, and dextrinated lead azide were developed as military explosives. The development in the United States of processes for producing toluene from petroleum removed limitations on the availability of TNT, and permitted development of the powerful and castable explosives like composition B and pentolite. Flashless propellants were developed in the United States, and low-erosion DEGN propellants were developed in Germany and Italy. Diazodinitrophenol was developed as an initiator in the United States, and tetracene was developed in Germany as a new explosive ingredient of priming compositions. World War II (1939-1945) saw the development of rocket propellants based on nitrocellulose-nitroglycerin or nitrocellulose-DEGN mixtures, and the use of nitroguanidine in artillery propellants. New special-purpose binary explosives, such as tetrytol and picratol, were developed for use in demolitions, chemical bombs, and semi-armor-piercing bombs. A number of plastic explosives used for demolition work were developed in Great Britain and the United States, the most important being the C-3 composition based on RDX. The discovery and great value of the blast effect of explosives led to the development of tritonal, torpex, and minol, which contain powdered aluminum and have powerful blast effects. In the spring of 1943, EDNA or haleite was adopted for testing purposes after the DuPont Company, while under contract, overcame the problem of manufacturing ethylene urea, one of haleite's intermediates. But it was not until the end of the war that production of haleite could get started. Incendiaries were found to be even more effective

than high-blast explosives in the destruction of cities. By using improved fire bombs filled with thickened or gelatinized incendiary oil or gasoline mixtures, and large clusters of incendiary bomblets filled with thermate (an improvement of the WW I thermite), the US air forces were able to literally set fire to cities like Dresden and Tokyo. Flamethrowers and smoke munitions were used extensively by both sides. Finally, the extensive use of armor during the war led to the development of anti-tank weapons, armor-piercing shells, and shaped-charge munitions. The application of the shaped-charge principle resulted in the use of special explosives of the pentolite type.

a. 1918-1939. Ammunition research in the first postwar years was inspired not only by new requirements, but also by the problems encountered in preserving ammunition, especially propellants, stored after the Armistice. Research proceeded in three areas: determining the stability of smokeless powder, studying the effects of long term storage on stability, and creating more efficient methods of drying. A good deal of valuable information on these substances was assembled at Picatinny Arsenal, NJ, before 1926, notably that on feasibility of the vapor method of drying, which reduced drying time from months or weeks to days. But a more permanent solution of some phases of the powder storage problem would be to develop new non-hygroscopic powders, which because of their chemical composition would not absorb enough moisture to affect their ballistics or chemical stability even when stored in a damp atmosphere. If, at the same time, flashless and smokeless qualities could be incorporated, the advantages would be even greater. Thus the search for flashless non-hygroscopic (FNH) powders was vigorously pushed. The DuPont Company, under a special agreement with the Ordnance Department, followed one route of investigation, while Picatinny Arsenal followed another. Each achieved considerable success. The peacetime development of complete single-base and double-base non-hygroscopic powders, flashless in many weapons, was one of the most useful accomplishments of the Ordnance Department before 1940. Traditionally, British propellants have been of the double-base type developed prior to World War II and designated as cordites. The cordites were made up of varying percentages of nitrocellulose, nitroglycerin, and mineral jelly. The mineral jelly (petroleum jelly or petrolatum) acted as a stabilizer. A sample of British MD cordite has been found to be of apparently unchanged stability after 30 years of temperature-climate storage.

The search for a compound that was both smokeless and flashless had its beginning in the requirement established by the US Army Ordnance's Westervelt Board in 1919. In the early 1920's, ordnance scientists offered the using arms samples of nitroguanidine, which to a degree unobtainable in any other known propellant, had both properties. But nitroguanidine gave off such noxious ammoniacal fumes in combustion that the Field Artillery vetoed its use. The Ordnance Department, with no customers in prospect, then abandoned all thought of building plants to make nitroguanidine. But ammunition specialists found no satisfactory substitutes. Adding potassium sulfate to propellants for anti-aircraft fire, where flashlessness was all important, helped to solve that problem. However, it was no answer to the demand for a completely smokeless and flashless propellant for field artillery where smoke would obscure a gunner's vision and muzzle flash would reveal the tank or battery position.

b. 1918-1939. Between the two world wars very little was done in the United States to develop the art of rocketry and rocket propellants. A golden opportunity to assume leadership in this field was missed when just before the Armistice in 1918, Dr. Robert H. Goddard, Professor of Physics at Clark University, demonstrated a shoulder-fired "recoilless gun" or "rocket gun" at Aberdeen Proving Ground, MD. The results of Dr. Goddard's demonstration were summarized by Ordnance Department witnesses as proving the validity of his concept of modern rocketry. However, the lack of suitable powder and the need for further work on the electrical firing mechanism along with the Armistice led the Ordnance Department to shelve the project. Goddard died without receiving any acclaim for this pioneering work, although comparison of his rocket gun with the bazooka adopted 24 years later shows how closely the 1918 model resembles the later weapon. During the 1920's, metriol trinitrate or trimethylolethane trinitrate, used as an ingredient in rocket propellants in World War II, was prepared in Italy and Germany. In 1931, the US Army created a one-man rocket unit by assigning Captain Leslie A. Skinner to study the possible use of rockets. Skinner was handicapped by limited funds for research, and by the indifference of superiors. During the mid-thirties, the British began more intensive research on anti-aircraft rockets in anticipation of massive bomber air raids upon their cities. In the meantime, the Germans made great strides in the development of rockets and missiles and the attendant propellants. This was especially due to the work of Wernher von Braun in the late 1930's.

c. 1920. Cardox, a device for breaking coal in gaseous mines by the pressure produced on heating liquefied carbon dioxide, was developed. Similar devices were developed in the United States in 1930, and were improved upon in 1955 (Hydrox) and 1959 (Chemecol).

d. 1927. Diethyleneglycol dinitrate was thoroughly examined by W. H. Rinkenbach, and the current method of preparation was patented in 1928 by A. Hough.

e. 1930-1931. Dextrinated lead azide was adopted for use by the US Army, and began replacing mercuric fulminate in priming compositions.

f. 1931. 2,4-dinitrotoluene (2,4-DNT), obtained earlier as an impurity in crude TNT, was used in some explosive mixtures.

g. 1935. From the 1920's onward, scientists at Picatinny Arsenal had been trying to find a compound that would have the high brisance of RDX without the sensitivity to friction and impact. Research on this problem, principally by Dr. George C. Hale, chief chemist, led to the discovery of ethylenedinitramine (EDNA or haleite) the first entirely American high explosive. More powerful than TNT, EDNA was slightly less powerful than RDX but was also less sensitive. EDNA's stability gave it an important advantage in considerations of manufacturing, loading, storage, transportation, and field use. Designated haleite, in honor of Dr. Hale, this new explosive could be press-loaded into small shells without a desensitizing agent, and its derivative, ednatol, a mixture containing 42 percent TNT, could be melt-loaded into large shells as easily as amatol. These advantages were offset in prewar days by the high manufacturing cost of one of its intermediates, ethylene urea. Delay in solving manufacturing problems prevented haleite from getting into combat in World War II.

h. 1936. Primacord, based on a French patent, was developed by the Ensign-Bickford Company, CT. Primacord consisted of PETN covered with textiles, waterproofing material, and plastics. This detonating cord had a velocity of 6,405 meters (21,000 feet) per second, and has been used extensively by the armed forces for demolition work.

i. 1937. Baratol, a mixture of barium nitrate and TNT, was developed by the British and used extensively in WW II.



j. *World War II. High Explosive Bombs.* When World War II began in September 1939, the standard United States filler for high explosive bombs was trinitrotoluene (TNT). On 5 June 1940, the United States released 8,000 metric tons (9,000 short tons) of TNT to the British under Lend Lease. This came out of a manufacturing surplus of only about 9,000 metric tons (10,000 short tons). Most of the war was fought by the United States with bombs standardized in 1941. The earliest departure from TNT for the fillings was RDX, an explosive known for its great power and brisance but generally considered too sensitive. The British had developed a method of using beeswax to desensitize the RDX, and used this filler with terrible effect in the 2-ton "blockbuster" bombs dropped on Berlin in April 1941. During the following summer, Air Marshall Arthur Harris had pressed for large-scale production of RDX in America. The United States Navy was also interested in the explosive because of its effectiveness under water, especially in a mixture with TNT and aluminum called torpex. But the United States Ordnance Department, while willing to start production for the British and the Navy, held back until May 1943 on the use of RDX in its AAF (Army Air Force) bombs, and then adopted only a less sensitive mixture with TNT known as RDX Composition B. This first significant change in bomb-loading came about as a result of AAF insistence that the large fragmentation bombs developed in 1943 would need the greater power of RDX Composition B to burst their thick walls with the greatest effect. Henceforth, Composition B was used in only about 40 percent of the general purpose bombs. The reasons were twofold. First, the short supply caused by competition between RDX, and high octane gasoline, and synthetic rubber for production facilities and, second, the tendency of Composition B to detonate high-order without fuze action under the shock of impact. RDX was more prone than TNT to prematurely deflagrate (decompose rapidly without detonating) when employed in delayed-action bombs dropped from high altitudes. In the war-long argument over the relative merits of blast and fragmentation, the pendulum now began to swing back toward blast partly because by 1944 the AAF would have aircraft capable of delivering larger and heavier loads. After 1943, the new aluminized fillings were of far greater interest than either RDX Composition B or ednatol. Until WW II, the use of aluminum in explosives had not been extensive. Tests in 1941 in England had failed to indicate any significant difference between aluminized explosives and amatol or Composition B. In

1943, the discovery that German bombs containing aluminum were extremely effective spurred research. This led to the development of minol, a mixture of aluminum with amatol, and tritonal, a mixture of aluminum with TNT. For their 2-ton blockbuster bomb, the British favored Minol 2, a mixture of 20% aluminum, 40% TNT, and 40% ammonium nitrate; and they requested that Minol 2 be used in their blockbuster bombs being loaded in the US. The British, by using new methods of blast measurement and interpretation, had learned that Minol 2 produced an area of demolition approximately 30 percent greater than the area obtained with a TNT filler. US Army Ordnance technicians had independently arrived at a similarly high opinion of the blast effect contributed by aluminum. They arrived at this conclusion by comparing the performance of one- and two-ton blockbuster bombs loaded with minol, TNT, ednatol, and the RDX mixtures. In comparing minol and tritonal, they preferred tritonal, because it contained no ammonium nitrate. When even the slightest degree of moisture was present in the air, aluminum acted on ammonium nitrate and produced "spewing" (the evolution of hydrogen gas) and explosions. Tritonal was much safer, and the British were won over to it. The AAF adopted tritonal for large, light-case bombs for jungle warfare, and for all general purpose bombs. Other bombs were filled with explosives suitable to their particular purposes. For fragmentation bombs, RDX Composition B continued to be the preferred filling because it had more brisance than tritonal. The US one-ton semi-armor-piercing bombs developed in early 1944 were loaded with picratol, a mixture of TNT and ammonium picrate, or with Explosive D. Explosive D was the least sensitive to shock and friction, which made it the best explosive to mix with TNT in a bomb that had to withstand severe shock and stress before detonating.

k. *World War II. Reverse Nitration of TNT.* During 1941 and 1942 the inadequate supply of TNT for high-explosive bombs and shells was a major problem for Ordnance. Because the shortage had been foreseen, plans were made to use a substitute explosive called amatol (a mixture of TNT and ammonium nitrate) for shell or bomb loading until new TNT plants came into full production. Even so, a critical shortage of TNT developed despite these plans. But the shortage suddenly disappeared when a new process appeared on the scene almost by accident. During an inspection of a small Canadian TNT plant at Beloeil near Montreal in 1941, LTC John P. Harris of Ordnance discovered that

the plant was "doing things backward" by putting toluene into the acid instead of putting acid into the toluene. Despite some resistance by US TNT producers, the new process was tried at the partly built Keystone Plant at Meadville, PA. The result was a tripling of TNT output. Lines designed to turn out 16 tons a day produced more than 50 tons a day. The need for TNT substitutes vanished, and the cost per unit was cut in half.

*l. World War II. Toluene from Petroleum.*

Development of a new means of producing toluene, the basic material from which TNT is made, was another highly significant technological advance of World War II. The importance of this chemical stems from the fact that nearly half of every unit of TNT (trinitrotoluene) must come from toluene. In World War I, toluene was derived from coal as a by-product of coke ovens, and some was extracted from natural gas. Yet the supply in 1917-18 was so limited that the Assistant Secretary of War, Benedict Crowell, later called this shortage "the greatest and most pressing of all the problems in regard to existing raw materials." In contrast, during World War II high-explosives production was never seriously hampered by lack of toluene. As early as 1927, Standard Oil of New Jersey had obtained patent rights from a German firm to use a process for producing toluene from petroleum. In 1939, a contract with Standard Oil was placed by Picatinny Arsenal to prepare toluene by this process at Baytown Ordnance Works, which was erected next to the Humble (a Standard Oil subsidiary) refinery in Baytown, TX. By October 1942 this plant was producing toluene at the rate of 246 million liters (65 million gallons) per year, which when compared with a total toluene production of less than 34 million liters (9 million gallons) in the US during 1918 shows us the value of this process.

*m. World War II. Artillery Propellants.* The problem of obtaining artillery propellants that were both flashless and smokeless continued to plague the U.S. Army. Early in the war, the Navy seized upon nitroguanidine as the one feasible answer to novel conditions of combat. For the first time, American ships in the Pacific were preparing to fight in small harbors where maneuvering was all but impossible. Flash at night betrayed the vessel's position, and smoke by day made second rounds inaccurate. Negotiations with Canada in 1943 for the purchase of nitroguanidine, from the one plant upon which British and Canadian forces were also depending, succeeded in meeting Navy needs but left no surplus for the US Army. The Army Ground Forces were not convinced of the value of this propellant until

shortly before D-Day. By then, urgent demand could not allocate facilities to produce nitroguanidine in large quantities, and the Ordnance Department could only procure small lots for testing and experimental firing. Whatever the advantages of nitroguanidine, neither it nor any other composition was ideal for all purposes. Even in conventional artillery and small arms ammunition, where ballisticians understood propellant behavior better than in rockets and recoilless rifle ammunition, compromises were inescapable. The primary requisite for one weapon or one particular use tended to be different from every other weapon or use. In addition to these problems, World War II introduced the problem of climate extremes at which firing had to take place when Allied troops were fighting in arid deserts, damp jungle heat, or in the subzero winter weather of northern Europe and of the Aleutian Islands. Therefore, a series of propellants were needed to cover widely varying contingencies. Since basic research as well as prolonged applied research was necessary, many problems remained unsolved at the end of the war. But the field was explored more thoroughly than ever before in the United States, and lines of investigation were clarified for postwar development. In processing propellants, industry and the Ordnance Department made considerable advances during the course of the war. One new method developed by the Hercules Powder Company for washing nitrocellulose in a continuous filter instead of in large tubs by the old "settle and decant" system, washed the nitrocellulose more thoroughly and thus improved the stability of nitrocellulose. The DuPont Company found that using preheated alcohol during the winter to dehydrate nitrocellulose reduced the hydration time cycle, improved the yield, and made for a more uniform product. This in turn produced a much better powder. The Radford Ordnance Works carried on extensive experiments to improve manufacturing and testing techniques as well as for finding better chemical compositions. Yet in the spring of 1945, reports from the Combined Intelligence Objectives Subcommittee, established to locate data in Europe on Axis research and manufacturing procedures, indicated that Germany had developed several processes more effective than those of the United States. The most novel German method was one of casting propellant grains by adding a paste of moist nitrocellulose and diethyleneglycol dinitrate (DEGN) to molten TNT and pouring the mixture into steel molds to cool. Grains as large as 1,000 millimeters were cast this way. After the war, complete sets of the German equipment deemed most useful and novel went to Picatinny Arsenal for study.

n. *World War II. Wood Pulp and Cotton Linters.* Before the war, the standard practice for making smokeless powder called for the treatment of bleached cotton linters with a mixture of nitric and sulfuric acid. In the summer of 1941, it became apparent that even with a good cotton linters crop and capacity operation of bleacheries, the supply of linters for powder would fall short of requirements. Ordnance chemists, therefore, turned to the use of a special wood pulp that was available in quantity, was suitable for most kinds of powder, and was cheaper than cotton linters. The Hercules Powder Company had made smokeless powder from wood pulp for a number of years, and Ordnance found the product completely acceptable. Use of wood pulp as a supplement of, but not a replacement for, cotton linters was approved promptly except for rifle powder and certain other uses. Soon most plants had one or two lines for nitrating cotton, an equal number of lines for nitrating wood pulp, and several "swing lines", which were adaptable for use of either materials. From January 1942 to the end of the war, Ordnance plants used roughly equal quantities of cotton linters and wood pulp. There was never a concurrent shortage of both materials, although there were times when the supply of one ran low or was expected to run low. At such times, Ordnance drew upon its inventories while converting the swing lines to meet the situation. The use of wood pulp doubled the existing supply of cellulose for powder, and eliminated a serious potential bottleneck in ammunition production.

o. *World War II. Rocket Propellants.* Difficult though the US program was for improving propellants for conventional weapons, the question of developing suitable rocket propulsion was still harder to answer. From the very beginning everyone concerned with rocket research agreed that single-base powders would lack the necessary energy and that double-base powders, that is nitrocellulose and nitroglycerin combined, must be used. Double-base powders, made by the solvent process, had been manufactured in the United States for a number of years for use in intermediate and large caliber artillery. The method used a solvent of acetone and alcohol to make a colloid, from which grains or flakes could then be formed. About 1939, the Hercules Powder Company found a way of producing a solventless double-base propellant, which was plasticized by heat and pressure and then rolled out into sheets for mortar increments. But neither was adaptable for rockets where a solid stick or grain, not sheet propellant, was needed, and where the essential quality of uniform burning precluded using a grain without so

much as a hair crack or fissure. Even a tiny crack in a burning grain of powder would create pressure peaks at particular spots of the encasing rocket mortar tube and thus either burst the tube or cause erratic propulsion. Consequently, to get a safe usable rocket propellant made by the solvent process meant using grains of small cross-section (in technical phraseology, thin-webbed powder) in which malformations occurring in drying would be few and inspection could be exacting. A method of manufacturing solventless double-base propellant by a dry extrusion process had been developed in the late 1930's by the British. This produced much thicker-webbed, and therefore longer-burning, grains, but required enormously heavy presses to extrude or compact, and force out the propellant into the desired shape.

p. *World War II High Explosive Artillery Projectiles.* Considerable power combined with sensitivity, which made for easy loading, stability, and safety in handling and transport, made TNT and amatol the preferred high-explosive fillings for most high-explosive artillery shells at the outset of World War II. This was largely due to their availability in large quantities. As the war progressed and ammunition became more complex in design and more specialized in function, demand arose for improved explosives. This demand could not be met to any extent because the explosives developed between wars did not get into large-scale production in time. Nevertheless, throughout the war the US Army Ordnance Department sought ways of using more powerful new explosives, and ways to adapt old ones to special purposes. There were at hand several explosives of higher shattering effect, or brisance, than TNT. The most important were, first, cyclotrimethylene trinitramine, which the Americans called cyclonite and the British called RDX ("Research Department Explosive"); second, pentaerythritol tetranitrate or PETN; and third, EDNA (later called haleite). RDX and PETN were too sensitive to be used in the pure state in a shell. Therefore, to form usable compositions it was necessary to combine them with oils or waxes or with other explosives. The British had managed to desensitize RDX by adding nine percent beeswax to form Composition A for press-loading into shells; with 39.5 percent TNT and one percent beeswax to form Composition B, chiefly for bomb loading; and with 11.7 percent of a plasticizing oil to form Composition C, for demolition work. These formulas were provided by the British to the US in 1940, and development work was undertaken by the DuPont Company under contract of the Ordnance Department.

The most sensitive of all high explosives was PETN, which was even more readily detonated than RDX. PETN was desensitized by mixing with TNT to form a composition named pentolite, which has been extensively used in detonators, bazooka rockets, rifle grenades, boosting devices, and in the shaped charges of antitank shells. Because of production difficulties, haleite, the most promising of the new high explosives, never saw much use in World War II except in the form of ednatol in mixtures with other explosives.

q. *World War II Armor-Piercing and Antitank Projectiles.* Much of the work of improving high-explosive compositions was directed toward finding the most efficient filling for anti-tank shells. For armor-piercing projectiles, relatively insensitive ammonium picrate, "Explosive D," had long been preferred. As it was not likely to detonate on impact, the shell could penetrate the armor plate before exploding. But experience with heavy German tanks in North Africa showed that something more was needed in the way of power and fragment action coupled with greater incendiary effect within the tank. Chemists at Picatinny Arsenal accordingly tried several expedients. In armor-piercing shell, addition of a small amount of powdered aluminum to cyclotol (a mixture of RDX and TNT), to ednatol, or to TNT produced more brisance than Explosive D and increased sensitivity to impact. In high-explosive antitank shell fillings, conversely, the difficulty was the exact opposite. The high sensitivity of pentolite made it liable to detonation on target impact so that the problem was to desensitize it to the proper degree. Several possibilities considered were the addition of wax to the pentolite, the reduction of the PETN content, and the substitution of ednatol or Composition B. None was entirely satisfactory. The search for an explosive composition of the greatest possible power and brisance took a new turn after analysis of foreign explosives at Picatinny Arsenal during 1943. Hitherto, research had been concentrated on binary explosive compositions such as pentolite, Composition B, or ednatol. The examination of a Soviet 76mm high-explosive armor-piercing round suggested the possibility of employing ternary mixtures. Tests revealed that castable ternary explosive mixtures, such as RDX-Tetryl-TNT and Haleite-PETN-RDX, offered promise not only for armor-piercing projectiles but as fragmentation ammunition for weapons designed to produce blast, and for demolition charges. Further study showed that haleite ternaries were unstable. The best combination seemed to be a mixture of PETN-RDX-TNT designated PTX-2 (Picatinny Ternary Explosive). More brisant than any of

the binary compositions, PTX-2 was more stable than 50/50 pentolite and less sensitive to impact. Preliminary firings at Picatinny indicated that PTX-2 would be particularly adaptable to shaped-charged ammunition; but PTX-2 was still in the testing stage at V-J Day.

r. *World War II. Shaped Charges.* If no new explosive for artillery shell came into use during the war, a new way of employing explosives nevertheless did. The effect of a hollow-charge or shaped-charge projectile against armored targets was first successfully demonstrated by the bazooka and the rifle grenade. The intense forward jet of the charge, serving to focus part of the energy of the explosion in a limited area, gave to the light-weight, low-velocity rocket the armor-piercing advantages hitherto possessed only by high-velocity artillery. The antitank rifle grenade, containing only 113 grams (4 oz) of pentolite, would penetrate up to 102mm (4 inches) of homogeneous armor plate at a normal angle of impact. The first rifle grenade to use this principle was designed by a Swiss inventor, Henri Mohaupt, whose claims of inventing a "new explosive" had interested the British in 1939. However, the price Mohaupt quoted for his discovery was considered too high and the British showed no further interest in his invention. Mohaupt then offered to show the United States particulars of the construction of his device for a fee of \$25,000 paid in advance. Caution on the American part further delayed acquiring the rights until a demonstration by Mohaupt at Aberdeen Proving Ground, MD, was permitted in 1940, doubtlessly because Mohaupt provided 200 grenades for the demonstration. Army and Navy representatives who witnessed the test firings were convinced that this was indeed an important "new form of weapon." A similar proposal by Nevil M. Hopkins, an American inventor, for a shaped-charge bomb had been rejected earlier by the United States Ordnance Department as not being a new concept. By citing a 1911 British patent by Egon Neuman of the "Munroe-Neuman" principle, the Ordnance Patent Section thereupon showed Mohaupt's "secret" to be no secret. Thus the Ordnance was able to conclude a more reasonable contract with Mohaupt's company than the Swiss had originally demanded. An adaption of Mohaupt's design later formed the basis for the M9A1 antitank rifle grenade, and the 2.6-inch antitank "bazooka" rocket. Application of the shaped-charge principle to artillery naturally proceeded. The choice of howitzers was logical because their low velocity made conventional types of armor-piercing projectiles ineffective, whereas for a shaped-charge explosive low velocity was an advantage. Before Pearl Harbor, in an

atmosphere of great secrecy, work began on a shaped-charge shell, specifically the "HEAT" (high-explosive antitank) round, for the 76mm howitzer. The designers, paying careful attention to the length of the ogive, the filler of 50/50 pentolite, and the striking velocity, came up with a round of the same length as the corresponding high-explosive round. The HEAT round, at a muzzle velocity of approximately 305 meters per second, would penetrate 76 millimeters (3 inches) of homogenous armor plate. A similar shell for the 105 millimeter howitzer appeared simultaneously. Standardized in late 1941, HEAT shells were produced in time to take part in the North African tank battles early in 1943. The Ordnance Department had high hopes that the HEAT rounds would succeed in penetrating the heavy German armor plate that had defeated solid armor-piercing ammunition. Although sometimes successful, the performance of shaped charges was not dependable enough. In an effort to find out why, the Ordnance Department, with the help of the National Defense Research Committee (NDRC) and the Navy, intensified its research. In some cases, observers in the field had blamed faulty manufacture, but investigators proceeded on the assumption that design of the round and the principle of operation needed improvement. Because of the difference in behavior of the nonrotating rocket and the rotated shell, the effect of the spin was carefully studied as well as the method of fuzing. One of the most important discoveries was that an increase in plate penetration was directly proportional to an increase, up to approximately three calibers, in "stand-off" distance, that is, the distance from the base of the cone to the target at the moment of detonation. Yet this finding was only a beginning, and the solution to the puzzling behavior of hollow charge projectiles was not found during World War II.

s. *World War II Smoke Screening Munitions.* In the spring of 1940, the Germans demonstrated the value of smoke to screen their advance when they blitzed the Low Countries. Basic developments in smoke employment during World War II were its use to screen river crossings, beach landings, paratrooper assaults, and rear area targets from artillery fire and aircraft observation and attacks. Prewar versions of the HC smoke pots were enlarged, and floating smoke pots were developed for amphibious operations. Aircraft smoke tanks were developed for spraying liquid smoke mixtures. Smoke generators were developed for screening large areas by vaporizing fog oil. White phos-

phorous (WP) was the choice filler for most projectiles, but also had the undesirable disadvantage of sometimes becoming an incendiary. Another disadvantage was that WP tended to melt in hot climates, which affected the stability of the round in flight. Storage in hot climates also resulted in expansion of the WP and subsequent leakage. Despite these shortcomings, WP was very effective for building up smoke screens as particularly demonstrated by the 4.2-inch mortar battalions in Europe and the Pacific. Smoke bombs filled with WP and PWP were used extensively for spotting targets and for screening parachute drops. Plasticized WP or PWP was developed to reduce the pillaring effect of the exploding munition found with pure WP. PWP is obtained by mixing WP with a very viscous solution of synthetic rubber to form a homogenous mass. For loading into munitions where a longer lasting smoke screen is desired, HC (hexachloroethane mixture) was preferred, e.g., smoke pots and base ejection shells. WP was used in rifle grenades. HC was used in hand grenades. US tanks in North Africa were outfitted with smoke grenade launchers to screen the tanks from antitank fire.

t. *World War II. Pyrotechnics for Illumination.* In 1944, the Army Air Forces (AAF) made an important change in doctrine that affected munition development requirements when they initiated 24-hour bombing operations. Night bombing, always favored by the Royal Air Force but hitherto opposed by the United States, gave new importance to pyrotechnics. Aircraft flares came close to the usual bomb design. The AN-M26 aircraft parachute flare, designed to provide illumination for night bombardment, contained its illuminant mixture in a round-nosed, finned-tail cylinder and developed 800,000 candlepower for about three minutes. The most important development concerned high-altitude night photography, and markers to identify targets at night. The prewar M46 photoflash bomb gave only 500 million candlepower. Picatinny Arsenal experimented with different combinations of case, filler, and initiating system. The result was a photoflash bomb that produced approximately three times as much light as the M46. Target identification bombs grew out of a technique evolved by the British to improve the accuracy of their night bombing. Their "Pathfinder Force" equipped with special navigational aids flew over a target in advance of the attacking force and dropped various kinds of candles and flares, some to illuminate the general area and others to mark the special target with color. One muni-

tion designed specifically for this work was a stabilized bomb that ejected sixty-one pyrotechnic candles at a predetermined altitude. In the United States, the earliest research on target identification markers produced five bombs of this type. All were modifications of the 250-lb general purpose bomb and differed one from the other in the type of candle they contained. The candles were small flares that burned with either red, green, or yellow light for about three minutes. Each target identification bomb released its load of these signal candles, which together made a pattern of colored light approximately 100 meters in diameter around or on the target. These signal candles were designed to be visible from altitudes as high as 35,000 feet. To keep the candles from being disturbed while they were on the ground, one type of candle had an explosive charge that would detonate at the end of the burning time of the candle, the time being from one to two minutes. As the AAF extended its night operations, especially low-level bombing and strafing of illuminated targets by fighters and light attack bombers, need arose for ground burning flares that would produce a minimum amount of smoke and thus leave the targets as clear as possible. For this purpose, the Ordnance Department developed flare bombs loaded with smokeless units. At the end of the war Army and Navy experts agreed that future developments must be aimed at greatly increasing the candlepower, burning time, and visibility of all pyrotechnics, especially the photoflash bomb.

u. *World War II. Pyrotechnics for Signaling.* With the use of massive bombing air raids and close ground support by the Army Air Forces came the need for better signaling devices. Especially important were hand signals for downed fliers. Survival kits were developed which included colored smoke and flare distress signals for the aviators to carry. A substantial improvement in the ground signals used by the Armed Forces was made when the US Army Chemical Warfare Service (CWS), now the Chemical Corps, made a change in the method of consolidating the colored smoke mixtures in the grenades used for this purpose. The prewar M1 colored smoke grenades used a slow-burning mixture that burned about two minutes. In 1942, the Army Ground Forces established a requirement for a colored smoke grenade that would form a smoke visible at a slant range of 3,050 meters (10,000 feet) and last about one minute. By devising a method of consolidating the pyrotechnic smoke mixture with heavy presses, CWS engineers were able to provide a grenade meeting the Army

Ground Forces' requirements. After limited testing, the new grenade was type classified as the M18 smoke grenade and was issued in four colors: green, red, violet, and yellow. The M18 grenade remains the most widely used signaling device for ground troops today, which is a remarkable achievement considering that the M18 was adopted for Army use within six weeks of the statement of the requirement. This same loading technique was later applied to artillery base ejection canisters for marking boundaries.

v. *World War II. Flame and Incendiary Munitions.* In the intervening years from World War I to World War II, the development of flame weapons was studied by most nations except the United States. During the Ethiopian War in 1935 and 1936, the Italians employed the first armored vehicle-mounted flamethrowers. The Germans employed a flame tank during the Spanish Civil War and in 1939 used portable flamethrowers in Poland. These instances proved to the United States that the development of flame weapons could no longer be denied. In 1940, the US Army took steps toward developing a flamethrower and a flamethrower tank. These flamethrowers served an important role in the war in the Pacific, particularly in dislodging the determined Japanese soldiers from caves and fortifications. On Okinawa alone, flamethrowers are credited with the capture or death of 20,000 Japanese soldiers who were holed up in the caves while less than 100 American flamethrower operators were killed in the operations. The development of napalm ("nap" for the naphthenic acids and "palm" for the coconut fatty acids which made up the first type of this thickener) by the United States in 1941 made possible the greater use of gasoline for use in flame weapons. This gelled mixture made it possible for aircraft to deliver fire bombs over hard-to-get pinpointed areas and for flamethrowers to project a flame rod over a greater distance than was previously obtainable. By August 1944 the United States AAF Board had come to the conclusion that "where there is vulnerability to fire, the damage by fire is greater than by demolition," a conclusion, to be sure, that observers had reached during the London blitz of 1940 but which had not been acted upon. The decision of the Board in 1944 was to increase the incendiary bomb program to the highest priority. The United States Army CWS provided the Army Air Force with about 48 million incendiary bombs, which were effectively used, especially on the large cities of Japan. Most of these bombs were clustered bomblets containing thermate (TH3 and TH4), a new

incendiary mixture, which replaced the original thermite mixture. When ignited, thermite burns intensely at 2,200°C. Molten iron from burning thermite will melt metal, burn through steel plate, and ignite flammable materials. Oil and metal incendiary mixtures, such as PT1 and PTV, were also used as fillings in large thin-cased bombs. PT1 is a complex mixture based on "goop," a paste comprised of magnesium dust, magnesium oxide, and carbon, with a sufficient amount of petroleum distillate and asphalt to form the paste. PTV is an improved oil and metal incendiary mixture of polybutadiene, gasoline, magnesium, sodium nitrate, and p-aminophenol. However, napalm proved to be one of the most effective aerial incendiary agents in the war. On the evening of 9 March 1945, more than 300 superforts (B29 bombers) swarmed over Tokyo dropping about 2,000 tons of incendiaries, mostly clusters of M69 six-pound bomblets. The M69 bomblet was a tube which contained a black powder propellant charge that ignited and projected the napalm filling from the tube. Aerial photos indicated 16 square miles had been burned out. Tokyo police records, examined after the war, showed that more than 250,000 buildings were destroyed - about one fourth of Tokyo - in this one raid. More than 100,000 tons of incendiaries were dropped on the cities of Japan during World War II. Most of these were M69 bomb clusters. For destroying materiel to prevent enemy use, the CWS developed a thermite grenade, which was standardized as the AN-M14 TH3 incendiary grenade for use by the Army and Navy. Harvard University also developed a napalm fire starter (MI), for use by troops to ignite fires in wet climates. The armament of the American heavy bombers was usually the .50 caliber machine gun. During World War II, enemy fighter aircraft did not have armor plating capable of deflecting a .50 caliber bullet, although, bullet penetration of the plane's armor did not necessarily knock out aircraft. The enemies use of self-sealing fuel tanks necessitated the development of effective incendiary ammunition. Most urgently needed was an effective .50 caliber incendiary round. The first acceptable design was the work of the Remington Arms Company whose staff already had considerable experience in working on Swiss patents for incendiary ammunition. The Remington development was based upon the British .303 B Mark VI Z, and was adopted in September 1941. The bullet was a flat-base type with lead base closure and steel body, and was charged with 35 grains of a incendiary mixture consisting of 50 magnesium alloy and 50 percent barium nitrate. An improved design was developed

shortly thereafter by Frankford Arsenal and was standardized for United States use.

**2-9. Post-World War II Developments.** The nuclear bombs that ended World War II did not end requirements for conventional explosives and ammunition. As was shown by the Korean War (1950-1953) and the Vietnam War (1964-1973), the need for the United States to develop even more effective munitions and more powerful explosives or energetic materials became more apparent than ever. In spite of intensive effort, chemists at the Army's laboratories and arsenals failed during World War II to develop a new explosive composition for shell loading that was both satisfactory and readily available in quantity. The obstacles were often disheartening. The characteristics of an explosive might be considerably affected by impurities that existed in the raw material or which were admitted during manufacture. For example, the instability of PETN was probably due to impurities in the raw material, pentaerythritol. Other variables that had to be taken into account were the different methods of testing compositions and the differences in interpreting results. Assuming a composition had been found that promised to combine greater brisance with less sensitivity, there was still the question of whether it could be economically manufactured, safely handled, and made unchanging in character in temperatures ranging from arctic cold to tropical heat. In the search for explosives with special properties, much work had been done in the field of aluminized explosives, but, although aluminized TNT (tritonol) was used in bombs, much remained to be done. At the end of the war the Ordnance Department felt that deeper study of the fundamental properties of all high explosives was essential to effective developments in the future. Some of the problems of finding suitable high explosives and propellants have been resolved in the decades following World War II. Other problems have cropped up as the expanding techniques of modern warfare lead to more and more specialized requirements for explosives and propellants. Future developments may be expected to take the direction chiefly of mixtures of currently known explosives and other materials. But in some cases, the requirements can be satisfied only by new and more powerful explosives which are presently being sought. As seen by the experience of the two world wars, scientists engaged in the field of energetic materials must keep abreast of foreign technology and be prepared to exploit technical intelligence. The everchanging and rapid advance of

technology makes it necessary to shorten the lead time from research and development to deployment of new ammunition and explosives. But research and development is only the tip of the iceberg; the biggest expenditures for materiel in the Army go to the procurement and management of ammunition. An Army cannot fight for long without the right kinds of ammunition being available in the necessary mix and quantities needed to perform its mission. A responsive, flexible, viable production base and balanced inventories must be maintained to assure a strong readiness posture. With continuing budget restraints, all those in the armaments research and development community must consider these restrictions and exercise close control of the limited resources allocated to them for this purpose. Therefore, scientists and technicians working in this field must direct their priorities for research and development to those projects with the best prospects of being beneficial to armed forces materiel readiness, and avoid projects that may have only marginal applications to wars of the future.

a. 1945. PLX (Picatinny Liquid Explosive), consisting of 95 percent nitromethane and five percent ethylenedinitramine, was developed at Picatinny Arsenal by L. H. Eriksen and J. W. Rowan for use in mine clearing. The Germans had used similar liquid explosives during World War II under the name Myrol.

b. 1945. Tripentaerythritol octanitrate was patented by J. A. Wyler of Trojan Powder Company, PA, for use as a high explosive and possible gelatinizer for nitrocellulose.

c. 1946-1949. Composition C-4, known as Harsite, was developed by K. G. Ottoson at Picatinny Arsenal as a replacement for Composition C-1, C-2, and C-3. Composition C-1, C-2, and C-3 were the United States standard plastic RDX demolition explosives, and were originally derived from Britian's Composition C, which was developed during World War II.

d. 1946-1949. Benite, a black powder substitute, was developed at Picatinny Arsenal for use in igniter compositions of artillery primers, or in base igniter bags for separate-loading ammunition. Benite is in the form of extruded strands consisting of ingredients of black powder in a matrix of nitrocellulose.

e. 1946-1949. Composition D-2, which is not an explosive but serves as an emulsifier and desensitizer of explosives like HBX-1, was developed. Composition D-2 consists of 84 percent wax, two percent lecithin, and 14 percent nitrocellulose.

f. 1950-1953. When World War II ended, the United States had a tremendous inventory of ammunition on hand, but unfortunately it was not a balanced stock. There were enormous quantities of some types of ammunition, and only small amounts of others. The hasty mobilization of manpower for the Korean conflict stripped the Ordnance Department of the military and civilian personnel that might have properly assessed and cared for the huge inventories of ammunition in its custody. During the years preceding the Korean War, powder packed in cotton bags and fuzes made of substitute metals deteriorated. The Army drew too freely upon the large ammunition stockpile for training purposes, yet made no real effort to replace consumption or balance the items in stock. The lack of postwar orders sent the ammunition industry into an eclipse. When the United States entered the Korean struggle so suddenly in 1950, ammunition facilities and plants were at a low ebb, and businessmen were reluctant to reconvert their factories to wartime effort. Another element that restrained a shift to the immediate production of ammunition was the prevalent belief that the Korean War would be short, and did not warrant a sizeable dislocation of the United States industrial effort. Even after this fallacy was shattered by the entry of the Chinese into the war in late 1950, the policy of butter and guns continued, and no large scale mobilization of industry took place. Compounding the situation of unbalanced stocks, the lack of industrial mobilization that normally follows the outbreak of war led to further setbacks in the battle for ammunition production. By the time funds budgeted in 1951 were translated to production in 1953, the war was practically over. In the meantime, the answer to the shortages in Korea was for the Army to reduce the authorized ammunition required supply rates in the belief that the combat units were wasting their ammunition. The net result was a war in which American firepower could not be used to its best advantage. The lesson learned from this is that a need for better industrial mobilization planning, and for closer contact with industry in the development and maintenance of a viable production base exists.



g. 1950-1973. During the Korean conflict, both portable and mechanized flamethrowers were used and found to be very effective. Flame mines, using incendiary bursters to set off 55-gallon drums of napalm, were used in a defensive role. The large batches of napalm required for these operations were mixed in truck-mounted service units. M1 fuel thickening compound was used to gel the gasoline for flamethrowers and landmines. An undesirable feature of M1 thickener is that it absorbed moisture rapidly from the air, which degraded the gelling properties so that the gel became unstable. Army chemists at Edgewood Arsenal, MD, began work on a nonhygroscopic thickener, which was standardized later as M4 flame fuel thickening compound. The M4 flame fuel thickening compound is a di-acid aluminum soap of isooctanoic acids derived from isooctyl alcohol or isooctyl aldehyde, which are obtained from the oxidization of petroleum. Because of the large World War II surplus inventory of M1 thickener, M4 thickener was not produced in quantity until the Vietnam War. The Air Force used tremendous quantities of fire bombs. These bombs were essentially large fuel tanks filled with napalm, which were ignited by pyrophoric igniters (WP or sodium) upon impact. Continuous process mechanical mixers were developed for use at Air Force bases to mix and fill the fire bombs on the spot. M1 thickener could be mixed only in batches, so a new thickener, M2, was developed and fielded. M2 flame fuel thickening compound is an intimate mixture of 95 percent M1 thickener and five percent devolatilized silica aerogel or other approved antiagglomerant. M2 thickener was an improvement of the M1 thickener for use in fire bombs. This is because of the free-flowing and fast-setting characteristics, which allow its use in continuous mechanical mixers. M2 thickener was not suitable for use in flamethrowers, which require an aged gel obtained in the batch process. Napalm B, a special fire bomb fuel formulation, was developed by the Air Force to replace M2 thickener. Napalm B currently consists of 46 percent polystyrene, 21 percent benzene, and 33 percent gasoline by weight. Napalm B withstands high velocity impact dissemination more effectively than M2 thickened gasoline gels, resulting in less fuel burned enroute and more fuel delivered on target.

h. 1950. MOX (metal oxidizer explosives) were developed by National Northern Technical Division of the National Fireworks Ordnance Corporation, West Hanover, Mass, for use mostly in small caliber anti-aircraft shells.

i. 1952. Military medium velocity dynamite was developed by W. R. Baldwin, Jr. at Hercules Powder Company Laboratory.

j. 1952. PB-RDX (plastic-bonded RDX) was developed by the Los Alamos Scientific Laboratory of the University of California for use as a mechanical strength explosive. PB-RDX consisted of 90 percent RDX, 8.5 percent polystyrene, and 1.5 percent dioctylphthalate.

k. 1957. Military low velocity dynamite was developed at Picatinny Arsenal by H. W. Voigt.

l. 1958. HTA-3 (high temperature explosive) consisting of 49 percent RDX, 29 percent TNT, and 22 percent aluminum was prepared at Picatinny Arsenal.

m. 1958. Octols 70/30 and 75/25, mixtures of HMX and TNT, were developed at Northern Corporation as fillers for bombs and shells. Octols are standard high explosive fillers, which have been adopted for Army use.

n. 1958. Slurry explosives were developed by M. A. Cook and H. E. Farnham by adding water to ammonium nitrate to form slurries of the oxidizer salt, ammonium nitrate and sodium nitrate, and a solid fuel sensitizer. Slurry explosives provide three to six times the detonation force of ammonium nitrate-fuel oil (ANFO) explosives.

o. 1960. Detaclad process or explosive cladding, which is also called explosive bonding, was developed by the DuPont Company.

p. 1960. Detacord, detaflex flexible cord explosive, and detasheet flexible sheet explosives were developed by the DuPont Company.

q. 1964-1973. The war in Southeast Asia (SEA) (Vietnam) was characterized by an imbalance of ammunition supplies to meet the peculiar requirements of a longer, different type of war than had been anticipated. In the beginning, much of the war had to be fought with the ammunition surpluses from World War II and Korea. Critical shortages developed on those ammunition items which were best suited for the type of war being fought. Ammunition supply rates had to be adjusted constantly because production problems at home delayed filling vital requirements. The expanded use of the helicopter in this war and the fielding of rapid firing armament, such as the "Gatling" 40mm automatic cannon raised the supply rates far beyond the planners' expectations. The demand for signaling devices, such as the M18 colored smoke grenades, doubled, tripled,

and continued to rise until the ammunition supply rates for the grenades were as much as 100 times the World War II and Korea rates. Due to ammunition shortages, terrain, climate, and guerrilla warfare, the United States troops were often forced to rely upon field expedients during their missions. A new development program called ENSURE (Expedited Non-Standard Urgent Requirement), whose function was to meet troop demands for special items needed to support SEA operations, was established by the Defense Department. Many of the ENSURE items fielded under this program were ammunition related and are now standard items for Army use. For example, although flame-throwers were used extensively in SEA, a stand-off capability to project flame was needed to reduce the vulnerability of the operator to enemy fire. From this ENSURE requirement, a 66mm multishot flame rocket launcher (M202 and M202A1) was developed. The resulting M74 incendiary TPA incendiary 66mm rocket was fielded and is now a standard item. The rocket is filled with TPA (thickened pyrophoric agent), which consists of triethyl aluminum (TEA) thickened with polyisobutylene (PIB). Other significant ENSURE developments were a broad range of various 40mm cartridges and signaling devices, improved mines, and pyrotechnics for battlefield illumination.

r. 1973. The problem of managing a rapidly increasing number of conventional ammunition items in the Army inventory was addressed at the conclusion of the war in Vietnam. Although many items developed as a result of the ENSURE program had justified their existence in combat, others were, by their very nature "field expedients" or were advance prototypes from ongoing development programs.<sup>9</sup> In addition, many of the items in the inventory were obsolescent - left over from Korea, World War II, and even pre-World War II assets. Accordingly, the Deputy Chief of Staff for Logistics (DCSLOG), Department of the Army, established an

Ammunition Proliferation Study Committee staffed with representatives from the developing arsenals (Picatinny, Frankford, and Edgewood), the National Inventory Control Point, and the United States Army Training and Doctrine Command (TRADOC). This committee, chaired by DCSLOG, was assigned to review every conventional ammunition item with a stock number or every ammunition item in development, and recommend deletion of all items considered not essential to the mission of the Army. Hundreds of obsolescent and non-essential items of ammunition and explosives were eliminated. Among these were FS smoke and M1 thickener. Ammunition supply rates were considered. For example, because of a low usage factor, the AN-M14 TH3 incendiary grenade was considered for elimination until it was established that the incendiary grenade was used only when necessary to destroy equipment to prevent enemy use; therefore, ammunition supply rates are not applicable to this item. Retention of the M18 violet smoke grenade was justified because violet was the second most used color for signaling in Vietnam; and more colors, not less, were needed to prevent the enemy from guessing the purpose of the signal.

s. 1973-1976. To protect tanks, the United States Army devoted considerable attention to the problem of rapidly screening tanks from enemy anti-tank rounds and missiles. A DARCOM Project Manager for Smokes and Obscurants was appointed to manage a program of developing and fielding countermeasures. One of the first items adopted for Army use was a British smoke grenade launcher, which fires salvos of red phosphorous (RP) UK L8A1 smoke screening grenades from armored vehicles. After launch, these grenades detonate in the air to form an immediate, dense white smoke cloud that obscures the tank from enemy view. Smoke grenade launchers have been developed for use in many of the armored vehicles in use or development today, including the M1 tank.

## CHAPTER 3

### GENERAL CHARACTERISTICS AND CLASSIFICATION OF ENERGETIC MATERIALS

---

**3-1. Types of Energetic Materials.** Energetic materials are chemical compounds, or mixtures of chemical compounds, that are divided into three classes according to use: explosives, propellants, and pyrotechnics. Explosives and propellants that have been properly initiated evolve large volumes of hot gas in a short time. The difference between explosives and propellants is the rate at which the reaction proceeds. In explosives, a fast reaction produces a very high pressure shock in the surrounding medium. This shock is capable of shattering objects. In propellants, a slower reaction produces lower pressure over a longer period of time. This lower, sustained pressure is used to propel objects. Pyrotechnics evolve large amounts of heat but much less gas than propellants or explosives.

**3-2. Characteristics of Burning and Detonation.** Burning and detonation of energetic materials are exothermic redox reactions. The reaction is self-sustaining after an initial activating energy has been applied. On the basis of mass, the amount of energy released by propellants and explosives is comparable. However, this energy is considerably less than is produced by common fuels such as carbon burning in air. Propellant burning, or deflagration, is the very rapid burning that results from having a fuel and an oxidant in very close contact. In some propellants such as nitrocellulose, the fuel (which consists mainly of hydrogen and carbon) and oxygen are parts of the same chemical compound. In other propellants, finely divided discrete fuels and oxidants are mixed. The fuel may be a hydrocarbon or other readily oxidizable material such as aluminum. The oxidizer is usually an inorganic compound such as ammonium perchlorate or ammonium nitrate which contain oxygen in excess of the amount required for their own oxidation. Deflagration of propellants proceeds the same as normal burning. Combustion takes place on the surface and proceeds into the grain. The rate determining factors in the reaction are the rate of heat transfer into the propellant grain from the burning surface and the rate of decomposition of the propellant formulation. The rate of heat transfer depends on the pressure of the combustion products. The burning rate is defined as the rate at which the burning surface consumes a propellant grain in a direction normal to the grain surface. Detonation of explo-

sives is a completely different process than deflagration. A shock wave moving at supersonic speed proceeds through the explosive causing decomposition of the explosive material. The reaction rate is determined by the velocity of the shock wave, not by the rate of heat transfer. The velocity of the shock wave depends on the physical characteristics of the individual explosive material. The range of velocities is from about 2,000 meters per second to about 9,000 meters per second. The factors that affect the velocity include density, degree of confinement, and geometric configuration of the charge.

**3-3. General Behavior of Pyrotechnic Compositions.** Pyrotechnics is the technology of utilizing exothermic chemical reactions that, generally speaking, are non-explosive, relatively slow, self-sustaining, and self-contained. Pyrotechnic compositions are generally finely divided fuels such as metals, alloys, and hydrocarbons mixed with oxidizers.

**3-4. Classification of Energetic Materials.** There is considerable variation among the properties of the compounds that constitute each of the three major classifications of energetic materials.

a. The variation in the properties of explosives is put to practical use in armaments by an arrangement called an explosive train (figure 3-1). An explosive train consists of elements arranged according to decreasing sensitivity and increasing potency. The first element, the initiator, consists of a small quantity of highly sensitive material. The highly sensitive material consists of a primary explosive and other ingredients. Primary explosives are easily detonated by heat, spark, impact, or friction. In large quantities these materials are extremely hazardous because of their great sensitivity. The other ingredients in the priming composition increase the sensitivity of the mixture to the desired property, such as percussion or heat. The second element, the booster, contains a larger quantity of less sensitive but more powerful material called a secondary or high explosive. The booster is used either as an intermediate stage to detonate material that is too insensitive to be detonated by the relatively weak initiator or to ensure complete detonation of the main charge. The main or bursting

charge, also a secondary explosive, is the least sensitive material but comprises the bulk of the explosive charge. Secondary explosives differ from primary explosives in three major ways. Small, unconfined charges (one to two grams) of secondary explosives, even though ignited, do not transfer easily from a burning or deflagration reaction to a detonation. Except in the case of dust clouds, ignition by electrostatic spark is difficult. The shock required for ignition is much greater for a secondary explosive than for a primary explosive. In some cases, two other elements, a delay and a relay, may be added to the explosive train between the initiator and booster. The delay is calibrated to prevent detonation of the booster for a specified length of time. A delay is considered a pyrotechnic device. A relay may be required to strengthen the relatively weak output of the delay to detonate the booster.

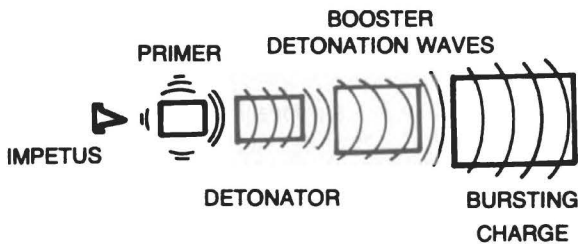

Figure 3-1. Explosive train.

b. An ignition train, which is used to ignite propellant charges, is shown in figure 3-2. The primer contains a priming composition which consists of a mixture of fuels and oxidants that are sensitive to stimuli such as impact, heat, or spark. Application of the appropriate stimulus causes ignition. The primer ignites the igniter which in turn ignites the propellant charge. The igniter is considered a pyrotechnic device.

c. Propellants are divided into four classes: single-base, double-base, triple-base, and composite. Division of the propellants into these classes is on the basis of composition, not use. Single-base compositions are used in cannons, small arms, and grenades; double-base compositions are used in cannons, small arms, mortars, rockets, and jet propulsion units; and triple-base compositions are used in cannon units. Composite compositions are used primarily in rocket assemblies and jet propulsion units. The choice of a propellant for a specific use is determined by ballistic and physical requirements rather than on the basis of composition. A given propellant composition may be suitable for use in several applications.

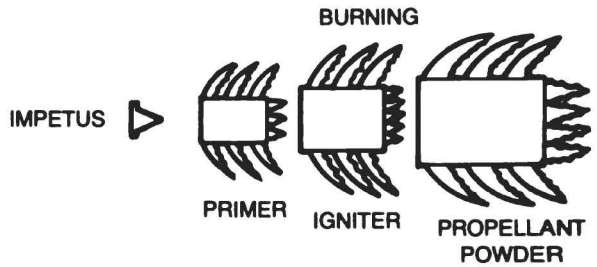

Figure 3-2. Ignition train.

(1) Single-base. These compositions contain nitrocellulose as their chief ingredient. In addition to a stabilizer, they may contain inorganic nitrates, nitro-compounds, and nonexplosive materials, such as metallic salts, metals, carbohydrates, and dyes.

(2) Double-base. This term has been applied generally to compositions containing both nitrocellulose and nitroglycerin. However, since other gelatinizers such as DEGN are used by other countries, a better definition of a double-base composition is one containing nitrocellulose and a liquid organic nitrate which will gelatinize nitrocellulose. Like single-base propellants, double-base propellants frequently contain additives in addition to a stabilizer.

(3) Triple-base. This term is applied to propellants containing three explosive ingredients with nitroguanidine as the major ingredient. The other two explosive ingredients are usually nitroglycerine and nitrocellulose. As in the double-base propellant, other gelatinizers may be substituted for the nitroglycerine. The nitroguanidine in the formulation produces a lower flame temperature and a greater amount of gaseous combustion products. The lower flame temperature considerably reduces erosion of gun barrels and the greater amounts of gas produce a greater force on the projectile. Triple-base propellants also contain additives in addition to a stabilizer.

(4) Mixed nitrate esters. Two propellant compositions were developed in the United States to replace the triple-base formulation due to the shortage of nitroguanidine. The XM35 composition contains nitrocellulose, TMETN, TEGDN and DEGDN. The higher force XM34 formulation contains nitrocellulose, BTTN, TMETN and TEGDN. The combination of mixed nitrate esters give higher gas volumes and lower flame temperatures than nitroglycerin alone.

(5) Composite. Most composite propellants contain neither nitrocellulose nor an organic nitrate. They generally consist of a physical mixture of a fuel such as metallic aluminum, a binder which is normally an organic polymer (generally a synthetic rubber which is also a fuel), and an inorganic oxidizing agent such as ammonium perchlorate. These are heterogeneous physical structures.

d. Pyrotechnic compositions are divided into the following categories according to use.

(1) Flares and signals. Flares burn to produce intense light that is used for illumination. Signals produce colored flames that are used as semaphores.

(2) Colored and white smoke. Colored smoke is used for signaling while white smoke is used for screening.

(3) Tracers and fumers. Tracers and fumers are small, smoke producing charges that are placed in projectiles. During the flight of the projectile, the charge burns. In a tracer, the smoke is used to track the flight of the projectile. A fumer produces smoke at the proper rate to fill the partial vacuum that movement through the air creates behind the projectile. This cuts drag and increases range.

(4) Incendiaries. Incendiaries produce large amounts of heat that cause fires.

(5) Delays and fuses. A delay is an element that consists of an initiator, a delay column, and an output charge or relay in a specially designed inert housing. The delay column burns for a predetermined amount of time. Delays are used to provide an interval between initiation and functioning of a device. A fuse is a cord of combustible material commonly used in demolition.

(6) Photoflash composition. Photoflash powders are loose mixtures of oxidizers with metallic fuels. When ignited, these mixtures burn with explosive violence in a very short time. The mixtures are used to provide light for military aerial photography, and in simulator devices.

(7) Igniters and initiators. These devices are used to ignite propellant charges and initiate detonation in explosive charges.

### 3-5. Chemical Nature of Energetic Materials.

Chemical properties of individual energetic materials are discussed in the appropriate chapters of this manual. The properties discussed for these materials include the following:

a. *Heat of Fusion.* The heat of fusion is the amount of heat necessary to transform (melt or fuse) a unit of solid into a liquid at the same temperature and standard pressure. This quantity is usually expressed in terms of calories per gram.

b. *Heat of Vaporization.* The heat of vaporization is the amount of heat necessary to convert a unit of liquid to vapor at the same temperature. This quantity is usually expressed in terms of calories per gram.

c. *Heat of Sublimation.* The heat of sublimation is the amount of heat necessary to convert a weight of solid directly into vapor in a constant temperature process. This quantity is usually expressed in calories per gram.

d. *Heat of Detonation.* Two quantities are usually given for the heat of detonation, one with liquid water in the reaction products and one with gaseous water in the reaction products. The test used to determine these quantities uses a standard calorimeter. When the water is allowed to condense to liquid, the total heat produced by the detonation reaction is measured. The heat of detonation with gaseous water more accurately reflects the process of detonation in a non-laboratory setting. However, the results are less reproducible.

e. *Heat of Combustion.* The heat of combustion is the amount of heat produced when a material is burned. This differs from the heat of detonation because the products formed are different. Generally, the products formed in combustion are at a lower energy level than the products formed during detonation. For example, carbon monoxide and carbon dioxide may be products of both detonation and combustion for a particular explosive. However, the detonation process might produce more carbon monoxide, while combustion might produce more carbon dioxide.

f. *Sensitivity.* Various external stimuli can cause release of the energy contained in energetic materials. Knowing the response of individual energetic materials to specific stimuli is important from the point of view of safety and in determining the suitability of a material for a specific application.

(1) The response to a blow is called impact sensitivity. Traditionally, explosives have been subjected to falling weights to measure impact sensitivity. The results are then reported as the distance a given weight must fall to produce detonation 50 percent of the time. The physical significance of this type of test has recently been questioned. The results are more qualitative than quantitative. For example, there is no question that lead azide is much more impact sensitive than TNT and that TNT is much safer to handle than lead azide. But the quantitative meaning of "much more impact sensitive" is ill-defined. The results of this test should be considered for general comparisons among explosive compounds. These same remarks are also valid for sensitivity to friction. Tests which are more applicable to specific hazards and applications such as the SUSAN test and 40-foot drop test are discussed in Chapter 5.

(2) Sensitivity of an explosive to shock is a very reproducible quantity. Shocks generated by a donor explosive can cause detonation in another explosive material. The strength of the shock wave required is a relative measure of the sensitivity of the material under test. In practice, a strong shock is produced and attenuated in an inert medium. The width of the medium that will allow detonation in 50 percent of the trials is reported as the test result. These tests are called gap tests. Gap test results are much more reliable data than impact test results, although there is some dependence on the geometry of the test apparatus. Gap test procedures are covered in detail in Chapter 5.

(3) Electrostatic sensitivity is an important quantity because of safety. Some explosives can be detonated from the shock of a person charged with static electricity. The test procedure used to determine electrostatic sensitivity is covered in Chapter 5.

(4) Thermal sensitivity is an important quantity which needs to be determined in considering explosives for applications. In some cases, such as in the warhead of a high speed intercepting missile, the heat generated during flight can cause detonation of explosive charges that are not highly resistant to heat.

g. *Brisance*. Brisance is the shattering capability of an explosive. Several tests are commonly used to determine brisance. In the sand test 0.400 grams of the explosive are placed in 200 grams of sand and detonated. The amount of sand crushed by the explosive is a measure of brisance. The plate dent test, in which a sample of the explosive is detonated in close proximity

to a metal plate, is also used to measure brisance. The size of the dent is proportional to the brisance. Another method of measurement involves detonating a sample of explosive on top of a cylinder made of copper and measuring the contraction in length of the cylinder. The number, size distribution, and velocity of fragments produced by an explosive in a projectile is also related to the brisance of the explosive.

h. *Detonation Velocity*. The detonation velocity is simply the rate at which the detonation reaction proceeds through an explosive. This quantity is closely related to the brisance. With a limited number of exceptions, increased detonation velocity increases brisance.

i. *Power*. The power of an explosive is the total energy available to do work. This is a different quantity than brisance, even though on the surface they appear rather similar. Consider two explosives, ammonium nitrate and RDX. If a charge of each is placed beneath a boulder, the ammonium nitrate might hurl the boulder many meters but the RDX might pulverize the boulder into many fragments. The former quality is power whereas the latter quality is brisance. Power is measured by the Trauzl lead block test in which a sample of the explosive is detonated in a cavity in a lead block. The expansion of the cavity is a measure of the power of the explosive. The ballistic pendulum and ballistic mortar tests are also used to measure power. A heavy weight is accelerated by the detonation of an explosive. The swing of the pendulum or movement of the mortar's weight is a measure of the power of the explosive. The oxygen balance of the explosive is closely related to the power. The oxygen balance is the ratio of oxygen contained in the explosive material to the amount of oxygen required for complete oxidation of the explosive material. Explosive compositions with better oxygen balances are more powerful.

j. *Stability*. Stability is the ability of energetic materials to retain, unaltered, such properties as detonation velocity and sensitivity after long periods of storage under adverse conditions. All energetic materials are unstable to some extent. The degree of instability varies greatly. TNT can be stored for 20 years with no change in stability while other explosives, which are not used by the military or commercially, decompose and/or detonate in a matter of days or minutes. Several tests are used to measure stability of explosives. In the heat tests, a sample of the explosive is subjected to a specified temperature for a given amount of time. The

sample is then weighed and any loss of weight above the evaporation of moisture indicates volatility or decomposition. The heat tests are usually carried out at 75°C or 100°C. In the 75°C test a ten gram sample is heated for 48 hours then cooled and weighed. In the 100°C heat test two samples of the explosive weighing 0.60 grams each are heated to 100°C. One of the samples is withdrawn after 48 hours, cooled, weighed, and replaced in the oven. This sample is then withdrawn after an additional 48 hours of heating, cooled and weighed again. The second sample is left in the oven for 100 hours and any detonation or ignition is reported. The 100°C heat test is a more accurate predictor of stability than the 75°C test. The currently preferred test of this type, however, is Thermal Gravimetric Analysis (TGA). A TGA can be run in two ways. The temperature can be held constant and the weight is monitored continuously. The data is then plotted as weight or percentage of weight change versus time. The other method commonly employed is to vary the temperature at a specified rate and plot the weight or percentage of weight change versus temperature. The results reported in this manual use a sample size of approximately 10 milligrams and a heating rate of 10°C per minute. The vacuum stability test is used extensively to measure stability. In this test a sample of an explosive is subjected to both elevated temperatures and vacuum. The amount of gas evolved after a specified time is recorded as the test result. The test may be run at any temperature but between 100°C and 150°C is the most common temperature range. In Chapter 5 the test procedure is given in detail. A test that is sometimes performed is the KI (potassium iodide) test. In this test a strip of potassium iodide - starch test paper - is suspended in a test tube with the material under test. The top of the strip is saturated with a 50 percent water 50 percent glycerin solution. The sample is heated. As the heating continues, moisture condenses on the test tube up to a certain point. The position of the test paper is moved up so the line of demarcation between the dry and glycerin-water soaked portions is kept level with the ring of condensation. The appearance of discoloration of the upper half of the test paper indicates the test is

finished. The results are reported as the amount of time from the start of heating to the end of the test. A blank is run at the same time to ensure the test results are greater than the time required for the blank to indicate. This test is of limited applicability. The discoloration is caused by acidity, so the major application is testing nitrocellulose at 65.5°C and nitroglycerin at 82.2°C for purity. A test that is performed on explosives to determine stability is the LLNL reactivity test. In this test a sample of explosive is heated at 120°C for 22 hours. A two stage chromatography unit is used to measure the individual volumes of N<sub>2</sub>, NO, CO, NO<sub>2</sub>, and CO<sub>2</sub>. The result is the sum of the volumes of these gasses per 0.25 gram of sample. A test that yields a great deal of useful information is the Differential Thermal Analysis (DTA). Detailed testing procedures for explosives are given in Chapter 5. In the usual DTA analysis, identical containers are set up. The sample under test is placed in one of the containers and a reference substance is placed in the other. The containers are placed in identical thermal geometries with temperature sensors arranged to give both the temperature of each container and the difference in temperatures between containers. The data are displayed as DTA thermograms; the temperature difference is plotted against the temperature of the sample. The standard reference material chosen is one with thermal behavior that does not change rapidly. Such a plot is nearly a straight line if the sample under test also has no rapidly changing thermal behavior. A straight line is also produced if the test sample has thermal characteristics similar to the reference substance. Excursions above and below a background line result from endothermic or exothermic changes. The DTA analyses permit interpretation for phase changes, decomposition and kinetic information, melting points, and thermal stability. Another very useful test is pyrolysis. A sample is placed in a pyrolysis chamber that is then flushed with helium. When the air has been swept out, the temperature of the chamber is raised at a constant rate. Gas evolution is measured as a function of temperature by a bridge formed by two thermal conductivity cells. The pyrolysis test results are plotted with the DTA results for each explosive.

## CHAPTER 4

# CHEMISTRY AND PHYSICS OF ENERGETIC MATERIALS

---

**4-1. Introduction.** This chapter contains a discussion of the physical processes involved in the detonation and deflagration of energetic materials. The initiation phenomenon, blast effects in surrounding media, and shaped charge principles are also discussed.

**4-2. The Ignition-Initiation Process.** Direct ignition or initiation of explosives by an external stimulus is caused by the thermal decomposition of the explosive involved. Impact, friction, electrostatic discharge, gap, and other sensitivity tests produce hot spots in the material under test. A hot spot is a localized region of higher than average temperature. Existence of the hot spots is confirmed by the lag time between the application of the stimulus and the detonation or ignition. For example, if a two kilogram weight falls 30 centimeters on a 20 milligram sample of RDX, ignition occurs within several hundred microseconds. Assuming that the impact energy heated the sample uniformly and that no heat loss occurred, the temperature of the RDX would be about 250°C. At that temperature, the ignition lag for RDX is about one second. In solid explosives, energy is transferred out of the hot spot in the form of shock and rarefaction waves. The shock wave heats the surrounding explosive. Some hot spots fail to detonate the surrounding material. Whether or not an explosion occurs depends upon the initial strength of the shock wave and how rapidly the shock decreases at the hot spot interface. Several modes of hot spot generation which have been proposed include:

a. Adiabatic heating due to compression of gas spaces can operate in impact and friction initiation of pressed solid and liquid explosives.

b. Frictional heating on a confining surface or on a grit particle can cause a hot spot. This mode of initiation can operate in impact and friction initiation of pressed solid and liquid explosives.

c. Hot spots can be caused by the intercrystalline friction of the energetic material. This mode of initiation can operate in impact and friction initiation of pressed solid explosives.

d. Viscous heating at high rates of shear can create hot spots. This mode of initiation is operative only at strong shock inputs. This is the main mode of initiation and propagation in homogeneous liquid explosives or defect-free single crystals.

e. Heating by plastic deformation at a sharp point can cause hot spots. This mode is operative in the shock initiation of solid explosive compacts and explosive liquids containing inhomogeneities.

f. Hot spots can be formed by the mutual reinforcement of relatively weak shock waves at inhomogeneities in the shocked medium. This mode is operative in the shock initiation of solid explosive compacts and explosive liquids containing inhomogeneities.

g. Particles which are spalled off crystallite by an incoming shock wave can form hot spots by impact on the opposite wall of a void. This mode is operative in the shock initiation of solid explosive components or liquid explosives containing inhomogeneities.

h. Micro shaped charged jets which are formed by shock waves acting on concave walls of bubbles, cavities, or voids can cause hot spots. This mode is operative in the shock initiation of solid explosive compacts or liquid explosives containing inhomogeneities.

**4-3. The Deflagration Process.** Deflagration of a propellant proceeds in a direction normal to the surface of the propellant grain. Material is consumed in parallel layers, so the geometry of the grain does not change as the burning takes place. Propellant is volatilized by heat transfer from the flame zone which is in the gas phase above the propellant surface. An increase in the ambient pressure causes the flame zone to move closer to the propellant surface. This increases the rate of heat transfer. The more rapid heat transfer causes an increase in the rate of volatilization of the propellant which correspondingly increases the rate of deflagration. If the flow pattern of the hot combustion gases is perturbed and penetrates the flame zone, an increase in the rate of heat transfer may occur. An increase in the flame temperature also causes an increase in the rate of heat transfer. The flame temperature is a function of the propellant composition. Propellants tend to burn more smoothly at high pressure than at low pressure.



#### 4-4. Deflagration to Detonation Transfer (DDT).

In some energetic materials deflagration can build to detonation. In a DDT, local ignition forms a convective flame front. A convective flame front is an ignition wave which is propagated by the passage of hot combustion gases through the pores of the charge. The hot gases are forced into the pores of the charge by the pressure built up as a result of charge confinement. The hot gases heat the pore walls and are consequently cooled. A continuous flow of gases is required to raise the temperature of the pore walls to the point of ignition. Ignition of the pores causes the convective flame front to advance and as the convective flame front advances, the pressure increases linearly with time. The pressure increase causes compaction of most porous charges. Formation of a post convective or compressive wave marks the beginning of accelerated pressure buildup. Subsequent coalescence of the compressive waves into a shock wave completes the DDT. The degree of compaction of the explosive determines how much material is consumed before the DDT occurs. The runup distance is defined as the length of material which will deflagrate before detonation occurs. The following subparagraphs describe the physical phenomenon involved in the variation of runup distance with density of the explosive material.

a. At crystal density and in cast charges there is no porosity and the explosive is impermeable. A convective flame front cannot form. A DDT can occur only if the explosive is relatively sensitive and there is a rapid pressure rise in the ignition region that produces a sufficiently strong shock wave. Some high explosives when unconfined at this density will burn without detonation. Under sufficient confinement, however, these explosives will detonate. Other more sensitive explosives will explode even without confinement.

b. The introduction of porosity into a charge does not mean that the charge will be permeable since the pores may or may not be interconnected. If the pores are not connected, permeability is very low and essentially negligible. The criteria for DDT in this case will be the same as for cast charges. The runup distance will be smaller, however, because the porosity will increase the exposed surface area of the explosive. This will cause

the rate of change of the pressure with respect to time to be slightly higher than for the cast material. If an explosive does not undergo DDT at crystal density, then there would probably not be a DDT at this density.

c. As the porosity increases, the fraction of pores which are interconnected increases rapidly. However, the permeability of the charge should remain small. Under these conditions a convective flame front can be established. Establishment of the front will depend on the permeability of the charge, the adiabatic flame temperature of the explosive, ignition characteristics of the explosive, and the ability of the confinement to allow a critical driving pressure to be established. The onset of convective burning indicates that nonnegligible amounts of energy can be transported by gas flow beyond the ignition region. However, only very small quantities of gas can flow out of the ignition area over a time period as long as 100 microseconds. The runup distance for DDT in this case would be less than for charges with either lesser or greater porosity.

d. As more porosity is introduced into the charge, the gas flow can no longer be described as choked. Enough pores are connected to permit flow which may be described as steady state. The increased permeability for this case leads to smaller rates of pressure increase near the ignition point. Burning for a longer period of time is required before the rate of pressure increase begins to accelerate. DDT occurs only after the acceleration occurs. A sharp rate of pressure increase is required to produce compressive waves which can coalesce into shock waves. The runup distance is correspondingly increased.

e. For very permeable charges, the runup distance increases with increasing porosity. Energy losses from the burning region can be great enough to prevent a rapid enough rate of pressure rise to cause DDT. In this case, the pressure builds relatively slowly (in one to two hundred microseconds) to a high level. The high pressure crushes the porous material immediately around the ignition region. The greater density crushed material, upon combustion, may then produce a rapid enough pressure rise to cause DDT. The runup distance for this case is the longest of any of the cases discussed.

**4-5. The Detonation Process.**

a. Detonation is caused by a self-sustaining shock wave which passes through an explosive material. The velocity of the shock wave is also called the velocity of detonation. A shock wave is a very rapid, almost discontinuous change in pressure. Beyond the range of the pressures involved in transmission of sound through a medium, the propagation velocity of a pressure wave increases as the pressure increases. Shock waves are formed by a pressure pulse of sufficient amplitude. The high pressure region of the pressure pulse moves faster than the low pressure region and so catches up as shown in figure 4-1. The shock wave will continue to have the sharp pressure rise shown in figure 4-1c until the wave is damped out. The dimension of the x-axis can be either distance or time. Five variables relate the state of the region in front of the shock wave and the region behind the shock wave. The variables are illustrated in figure 4-2. The shock velocity is the velocity at which the shock wave moves through the material. The shock velocity is greater than the sound velocity of the material at a given density. The particle velocity is the velocity attained by the material as a result of the acceleration of the shock wave. Particle velocity is in the same direction as shock velocity. Pressure, density, internal energy, and temperature increase as a result of the passage of the shock wave.

b. To derive relationships between the variables that specify shocked and unshocked material, refer to figure 4-3. We assume the shock front is stationary and the material is moving at the shock velocity through the shock front. Application of the laws of conservation of mass, momentum, and energy yields the following relationships among the variables.

(1) In a given amount of time,  $t$ , mass moves from one side of the shock front to the other side. By definition, mass,  $m$ , is given as a function of density,  $\rho$ , and volume,  $V$ , by the equation:

$$m = \rho V \tag{4-1}$$

The volume,  $V$ , can be expressed in terms of area,  $A$ , and length,  $L$ , by the equation:

$$V = AL \tag{4-2}$$

The length,  $L$ , is the distance a particle travels in our assumed time interval,  $t$ , times the velocity,  $v$ :

$$L = tv \tag{4-3}$$

By figure 4-3 the velocity can be seen to equal:

$$v_0 = (v - u_0) \tag{4-4}$$

and

$$v_1 = (v - u_1) \tag{4-5}$$

By equations 4-1 through 4-5 the mass entering the shock front is:

$$\begin{aligned} m_0 &= \rho_0 v_0 \\ m_0 &= \rho_0 AL \\ m_0 &= \rho_0 At(v - u_0) \end{aligned}$$

Similarly, the mass leaving the shock front is:

$$\begin{aligned} m_1 &= \rho_1 v_1 \\ m_1 &= \rho_1 AL \\ m_1 &= \rho_1 At(v - u_1) \end{aligned}$$

Invoking the principle of conservation of mass:

$$\begin{aligned} m_0 &= m_1 \\ \rho_0 At(v - u_0) &= \rho_1 At(v - u_1) \\ \rho_0(v - u_0) &= \rho_1(v - u_1) \end{aligned} \tag{4-6}$$

(2) In our system the force produced is the pressure difference across the shock acting on the cross-sectional area:

$$F = (P_1 - P_0)A$$

The rate of increase in momentum of the system is the final momentum less the initial momentum per unit time or:

$$\text{momentum change}/t = (mu_1 - mu_0)/t$$

By equations 4-1 through 4-5:

$$\text{momentum change}/t = [\rho_1 Atu_1(v - u_1) - \rho_0 Atu_0(v - u_0)]/t$$

Setting the force equal to the rate of momentum increase per unit time:

$$(P_1 - P_0)A = [\rho_1 Atu_1(v - u_1) - \rho_0 Atu_0(v - u_0)]/t$$

Cancelling and rearranging yields:

$$P_1 - \rho_1 u_1(v - u_1) = P_0 - \rho_0 u_0(v - u_0) \tag{4-7}$$

(3) The rate of work being done on the system,  $w$ , per unit time,  $t$ , is given by the equation:

$$w/t = \rho_1 Au_1 - \rho_1 Au_0$$

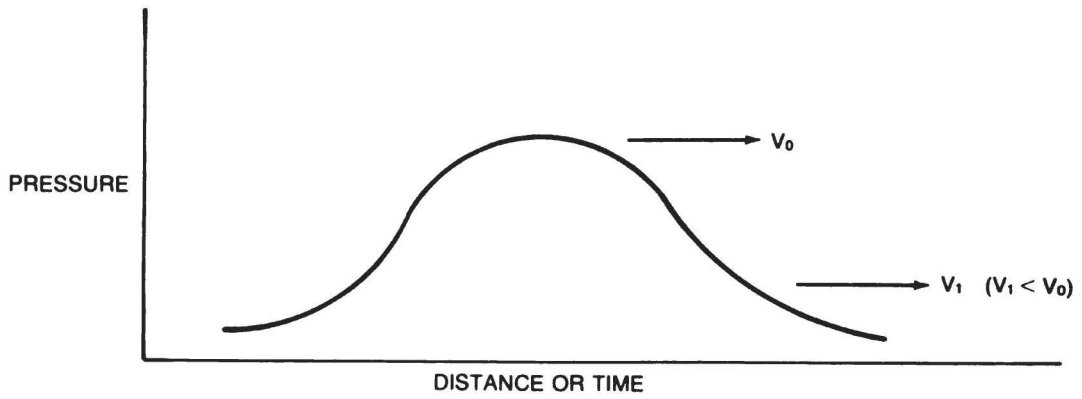

A. A PRESSURE PULSE

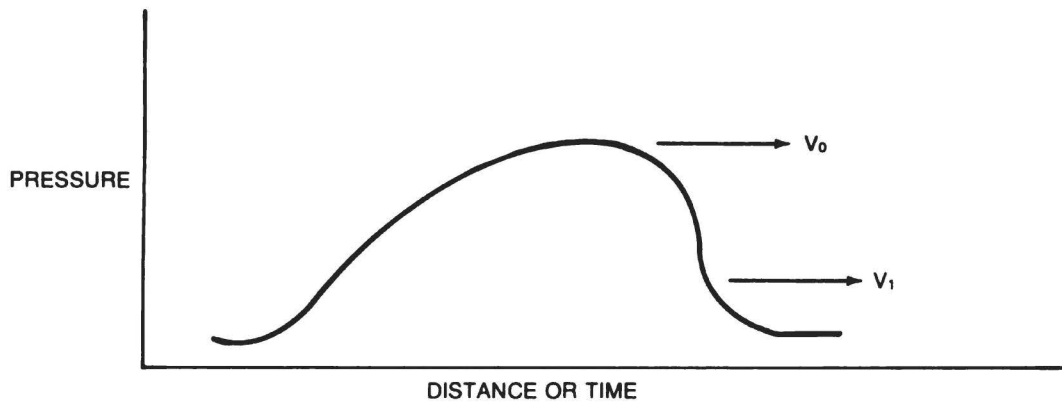

B. DIFFERENTIAL VELOCITY CAUSES THE LEADING EDGE TO BECOME SHARPER

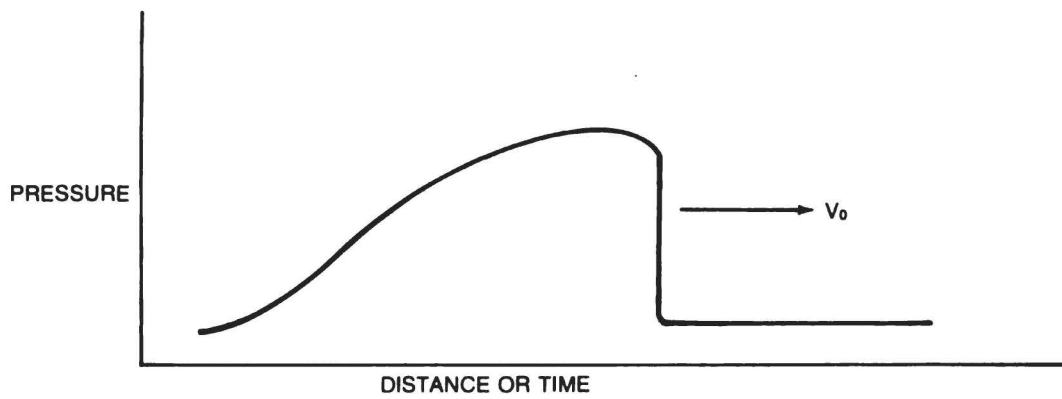

C. A SHOCK WAVE

Figure 4-1. Shock wave formation.

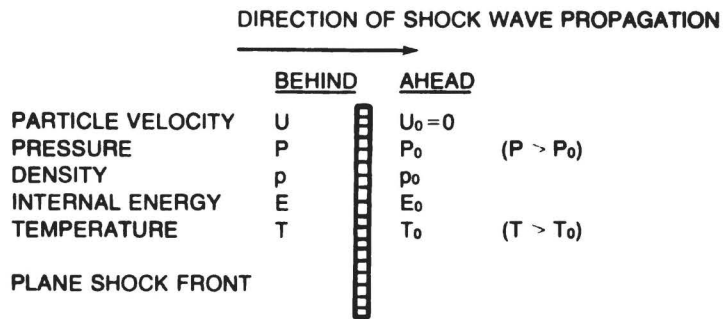

Figure 4-2. Steady plane shock front.

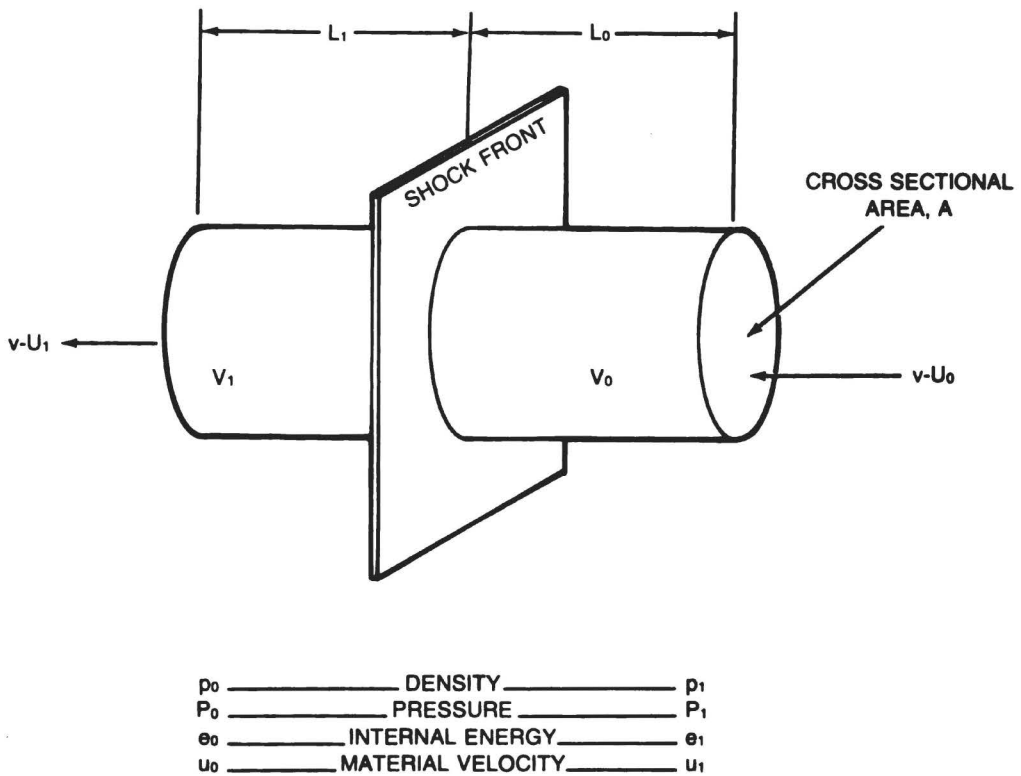

Figure 4-3. Control volume or mass passing through a shock front.

The rate of increase of energy per unit time is the difference between the rate of change of the sum of the internal and kinetic energies in the initial and final state:

$$\text{increase energy}/t = [(p_1 A L_1 e_1 + 0.5 p_1 A L_1 u_1^2) - (p_0 A L_0 e_0 + 0.5 p_0 A L_0 u_0^2)]/t$$

Using equations 4-1 through 4-5 the increased energy can be expressed as:

$$[A t p_1 (e_1 + 0.5 u_1^2) (v - u_1) - A t p_0 (e_0 + 0.5 u_0^2) (v - u_0^2)]/t$$

Equating the work done on the system with the rate of energy increase and cancelling the t's:

$$p_1 u_1 A - p_0 u_0 A = A p_1 (v - u_1) (e_1 + 0.5 u_1^2) - A p_0 (v - u_0) (e_0 + 0.5 u_0^2)$$

Cancelling the A's yields:

$$p_1 u_1 - p_0 u_0 = p_1 (v - u_1) (e_1 + 0.5 u_1^2) - p_0 (v - u_0) (e_0 + 0.5 u_0^2)$$

Rearranging terms yields:

$$p_1 u_1 - p_1 (v - u_1) (e_1 + 0.5 u_1^2) = p_0 u_0 - p_0 (v - u_0) (e_0 + 0.5 u_0^2) \tag{4-8}$$

(4) Equations 4-6, 4-7, and 4-8 are called jump equations because the state variables jump from one value to another very rapidly across the shock. To these, another relationship tying together any of two state variables ( $P, v, u, e, t, p$ ) which is specific for a given material is needed. An equation of state, which completely describes the material is more than is needed. A simpler relationship called the Hugoniot equation suffices. The Hugoniot is determined experimentally. The relationship can be obtained by measuring shock pressure and velocities at various shock states, or shock velocity and particle velocity, or any two of the state variables simultaneously. The Hugoniot which describes the relationship between the shock velocity,  $v$ , and particle velocity,  $u$ , has been found to be:

$$v = c_0 + s u \tag{4-9}$$

where  $c_0$  is the sound velocity in the medium and  $s$  is a constant that is related to the specific heat and thermal expansivity of the material. This relationship is not a path along which the variables change, but is actually a locus of solutions or discreet shock states. Table 4-1 lists the values of  $c_0$  and  $s$  for several explosives in the unreacted state.

Table 4-1. Unreacted Hugoniot Data

Explosive	Density in grams per cubic centimeter	Temperature °C	$c_0$ in millimeters per microsecond	$s$	Range of $u$ (by experiment) in millimeters per microsecond
Ammonium nitrate	0.86	25	0.84	1.42	0.81 - 2.32
Composition B	1.70	25	3.0 ± 0.04	1.73	0.0 - 1.5
Composition B	1.68	25	2.71 ± 0.05	1.86 ± 0.07	0.0 - 0.9
DATB	1.78	25	2.45 ± 0.04	1.89 ± 0.06	0.0 - 1.2
H-6	1.76	25	2.83 ± 0.07	1.70 ± 0.08	0.0 - 1.1
H-6	1.76	25	2.65	1.98	0.0 - 2.0
HBX-1	1.75	25	2.93 ± 0.08	1.65 ± 0.10	0.0 - 1.0
HBX-3	1.85	25	3.13 ± 0.02	1.61 ± 0.02	0.0 - 1.0
HNS	1.38	25	0.61 ± 0.21	2.77 ± 1.09	0.0 - 0.5
HNS	1.57	25	1.00 ± 0.05	3.21 ± 0.10	0.0 - 0.7
75/25 Octol	1.80	25	3.01 ± 0.4	1.72	0.0 - 1.2

Table 4-1. Unreacted Hugoniot Data - Continued

Explosive	Density in grams per cubic centimeter	Temperature °C	c <sub>0</sub> in millimeters per microsecond	s	Range of u (by experiment) in millimeters per microsecond
50/50 Pentolite	1.67	25	2.83 ± 0.4	1.91	0.0 - 1.2
PETN	0.82	25	0.47	1.73	0.76 - 3.50
PETN	1.0	25	0.76	0.66	0.28 - 0.42
PETN	1.59	25	1.33 ± 0.08	2.18 ± 0.27	0.03 - 0.37
PETN	1.60	25	1.32	2.58	0.2 - 0.4
PETN	1.72	25	1.83	3.45	0.2 - 0.6
PETN	1.55	110	-0.6 ± 0.5	8.7 ± 1.7	0.24 - 0.29
RDX	1.0	25	0.40	2.00	0.44 - 2.60
RDX	1.54	25	0.7	3.2	0.25 - 0.6
RDX	1.58	180	0.71 ± 0.24	4.22 ± 0.42	0.25 - 0.32
RDX	1.64	25	0.70 ± 0.18	4.11 ± 0.37	0.35 - 0.47
RDX	1.80	25	2.87	1.61	0.75 - 1.6
RDX	1.64	25	1.93 ± 0.05	0.666 ± 0.168	0.11 - 0.35
TATB	1.85	25	2.34 ± 0.07	2.32 ± 0.08	0.3 - 1.4
TNT	1.62	25	2.93	1.61	0.75 - 1.6
TNT	1.63	25	2.57	1.88	0.0 - 1.25
TNT	1.62	25	2.27 ± 0.30	2.65	0.0 - 0.6
TNT	1.62	25	2.99	1.36	1.0 - 1.5
TNT	1.61	25	2.39 ± 0.03	2.05 ± 0.03	0.0 - 1.4
TNT	1.64	25	2.08 ± 0.13	2.3	0.2 - 1.4
TNT	1.64	25	2.4	2.1	0.1 - 0.5
TNT (liq)	1.47	92	2.14	1.57	0.8 - 1.7

By substituting terms from equations 4-6, 4-7, and 4-8 into equation 4-9 and solving, we can obtain more forms of the Hugoniot, for example:

$$P = \rho_0(c_0 u + s u^2) \tag{4-10}$$

(5) Three planes or two dimensional plots are used to describe the shock properties and shock histories of materials. They are the distance-time (x-t) plane, the pressure-particle velocity plane (P-u) described by equation 4-10, and the pressure-specific volume (P-v<sub>s</sub>) curve.

(a) The x-t plane is used to display the positions of shocks, material surfaces, and rarefactions (the

opposite of a shock) in time and distance. Figure 4-4 shows a simple collision of two materials. (1) is the surface of the target and (2) is the front surface of a flyer plate which is a small mass that impacts the target at a very high velocity. The slope of (2) is the plate velocity, (3) is the impact point when the two materials meet, (4) is the forward going shock in the target, (5) is the interface of the plate and target moving slowly to the right, (6) is the left going shock driven back into the flyer, and (7) is the back surface of the flyer. All slopes on this plot are velocities. As the shocks reflect and rarefactions fan out and the surfaces move, the x-t plot is used to keep track of the variables.

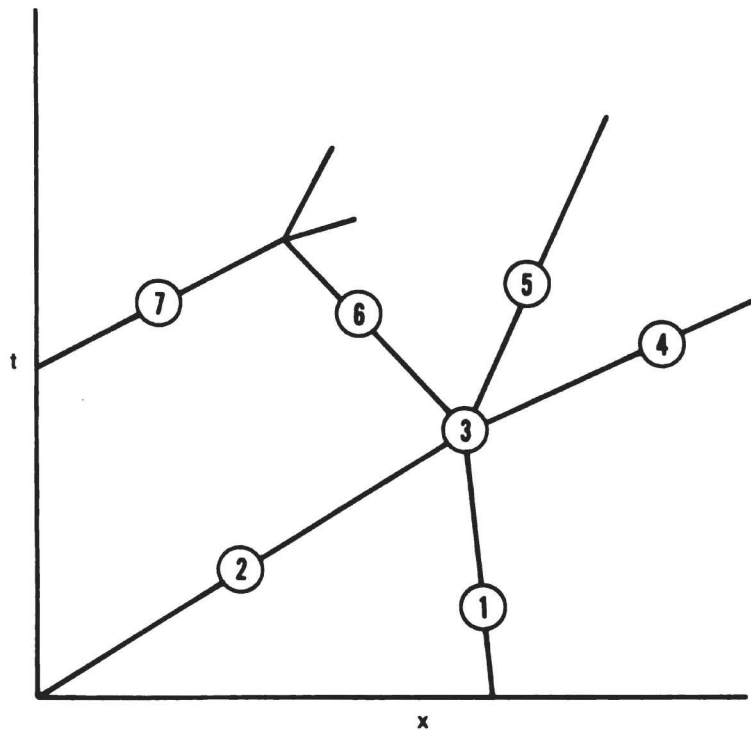

Figure 4-4. Shock properties in the x-t plane.

(b) The P-u plane is where the Hugoniot are normally plotted. An example is shown in figure 4-5. This plot is used to perform graphical solutions to impact problems (uniaxial). Intersections of Hugoniot equations represent simultaneous solutions of two Hugoniot equations. Chords drawn from initial to final states on this plot have slopes proportional to the shock velocities of the final state in that particular material. Figure 4-5 shows the solution of an impact problem where a flyer, material N at a velocity of  $u_0$  impacts a stationary target, material M. The final pressure and particle velocity after the impact are the same in both flyer and target and are  $P_1$  and  $u_1$ , respectively. (1) is the chord drawn from the initial state to the final state of the flyer. The slope is equal to  $-P_0v_1$ , the initial density times the shock velocity in the flyer. (2) is the chord drawn from the initial state to the final state of the target, the slope of the chord is  $P_0v_1$ , the initial density of the target times the shock velocity in the target. The negative slope of  $-P_0v_1$  indicates the shock in the flyer is traveling toward the left. The lines N and M are the P-u Hugoniot of two individual materials. The P-u Hugoniot is not fixed on the plane. The position of the plot relative to the P and u axis is not unique. The physical explanation for that is, a material specimen can exist at any pressure state regardless of bulk or particle velocity. The shape of the Hugoniot and the relation of slope to the axis is unique.

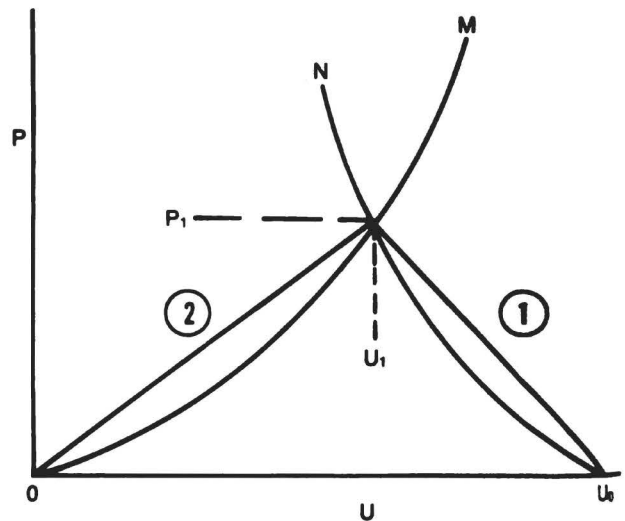

Figure 4-5. Shock properties in the P-u plane.

(c) The specific volume  $V_s$  is defined as the reciprocal of the density. Plots in the  $P-V_s$  plane, as shown in figure 4-6, are useful in describing the thermodynamics of the shock because areas on this plane represent work or energy per unit mass:

$$PV_s = \frac{\text{Force}}{\text{Area}} \times \frac{\text{Volume}}{\text{Mass}} = \frac{\text{Force} \times \text{distance}}{\text{mass}}$$

The Hugoniot position on this plane is unique.

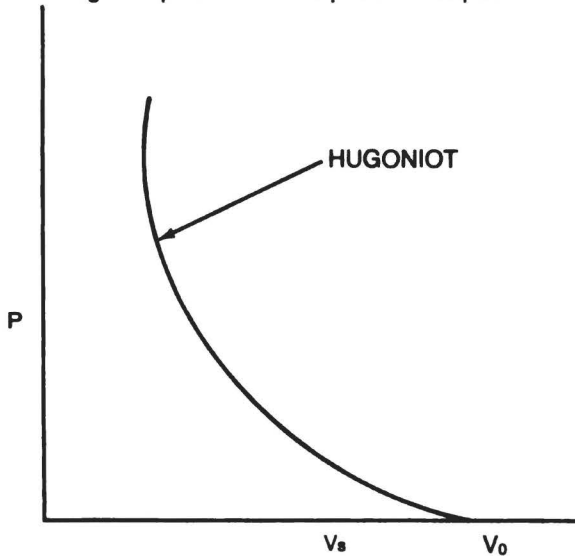

Figure 4-6. Shock properties in the  $P-V_s$  plane.

c. A detonation shock wave is self-sustaining because the energy added by the chemical reaction taking place behind the wave balances the losses due to normal attenuation. Figure 4-7 shows the pressure distribution of a detonation wave that is moving through explosive material. Chapman and Jouquet (CJ) developed the theory of shock wave propagation through explosive materials. The CJ conditions for each explosive are unique for that explosive at some unique or specified density. If we change the initial density, we will change the CJ conditions. The theory is based on these assumptions: that pressure is constant from the shock wave to the CJ point, that the pressure decays in a Taylor wave beyond the CJ point, that the reaction is complete and the products are in equilibrium at the CJ point, and that the energy in the Von Neuman spike is negligible in comparison to the energy in the reaction zone and so can be ignored. Figure 4-8 shows a representative plot of the Hugoniot of unreacted explosive and decomposition products under detonation conditions. The Rayleigh line connects the initial unshocked state,  $V_{s0}$ , with the final shocked state,  $V_f$ . Table 4-2 lists the reaction zone length (i.e., the length of the zone between the shock wave and the CJ point) for various explosives. Table 4-3 lists the detonation pressure in the reacting zone for various explosives. The pressure of the Von Neuman spike can be explained by referring to figure 4-8. The point that the Rayleigh line crosses the unreacted explosive Hugoniot,  $V_f$ , corresponds to the high pressure in the Von Neuman spike. This is obviously at a higher pressure than the CJ point.

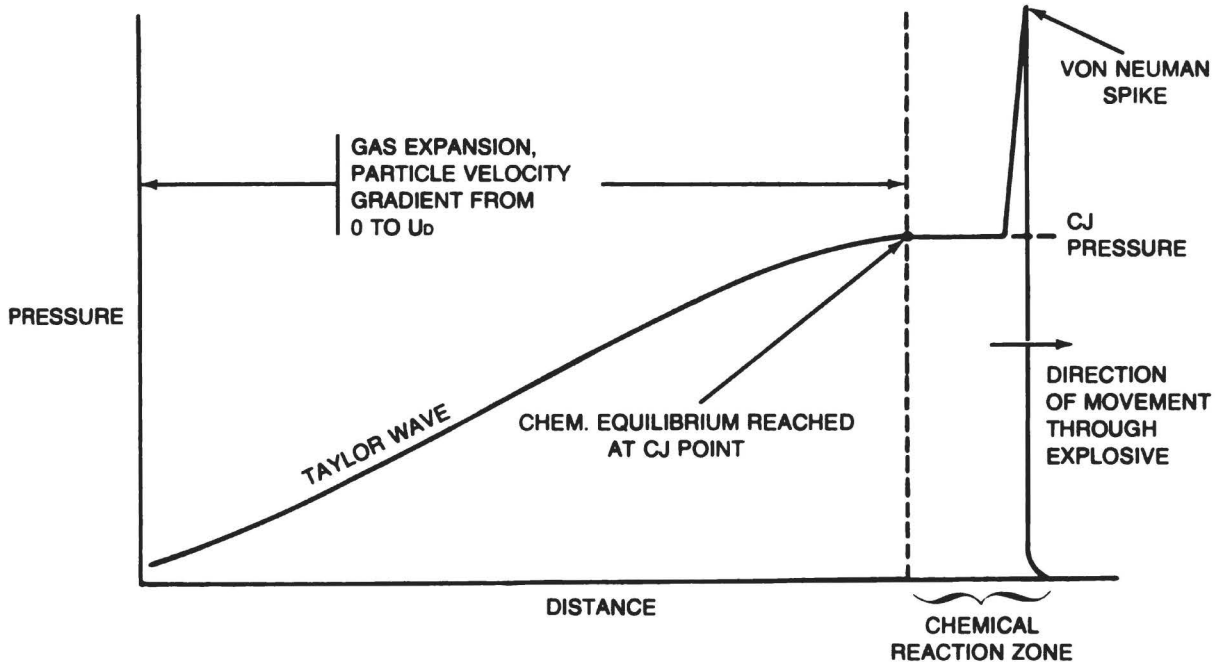

Figure 4-7. Detonation wave.



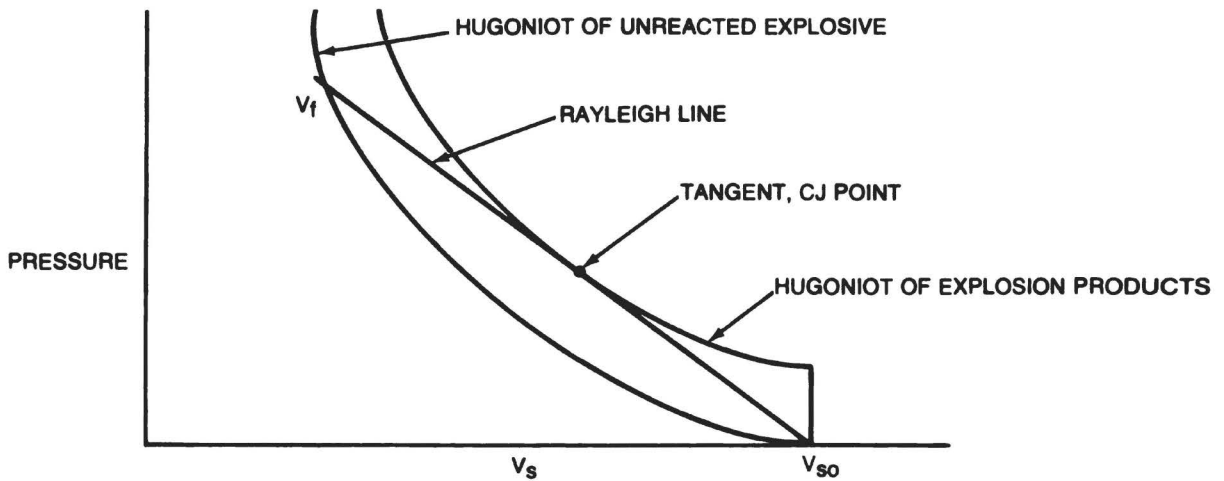

Figure 4-8. P-V<sub>s</sub> plot during detonation.

Table 4-2. Reaction Zone Length

Explosive	Density, in grams per cubic centimeter	Approximate length, in millimeters
Amatol 80/20	1.67	4
Composition B	1.67	0.13
HBX-1	1.60	0.19
Nitroglycerin	--	0.21
RDX		0.826
(microporous)	1.30	1.82
(single crystal)	1.80	2.90
TNT		0.36
	1.00	0.32
	1.55	0.18
	--	0.13
	--	0.21
	1.59	0.70
(pressed)	1.63	0.3
(cast)	1.615	0.42 at 291°K
	1.70	0.55 at 77.4°K
	1.71	0.62 at 20.4°K
(liquid)	--	0.9 at 100°C
	--	1.1 at 100°C
TNT/RDX 50/50	1.67	0.12

d. Several computer programs are available that predict the detonation characteristics of a compound from basic chemical and physical properties. One such program is based on the Becker-Kistiakowsky-Wilson (BKW) equation of state. The BKW program requires information about the initial state of the explosive and about the state of the detonation products. The information required for the initial explosive is elemental composition, heat of formation, density, and formula weight. The information required for the detonation products is elemental composition, heats of formation, co-volumes (the effective size of the molecules), and fits of each products ideal gas entropy as a function of temperature. If any solid detonation products are present, the density, molecular weight, and an equation of state are required. From this information the BKW program computes the equilibrium composition of the detonation products at specified temperatures and pressures, the Hugoniot curve, the CJ pressure, the CJ temperature, the CJ density, the detonation velocity, and the isentrope of the detonation products through the CJ point. The values of pressures and temperatures obtained from the program agree to within 20 percent of the values observed experimentally and the detonation velocity agrees to within 10 percent. This margin of error is caused by the assumption of the BKW equation that detonation is steady state. To perform time-dependent flow calculations of the detonation process, other programs are used. These include SIN, EIC, 2DL, and 2DE. These programs require an equation of state of the detonation products (such as BKW), an equation of state for the unreacted explosive, an equation of state for mixtures of unreacted and totally decomposed explosive, and an equation of state that describes the rate at which the explosive decomposes into detonation products.

Table 4-3. Detonation Pressures

Explosive	Density in grams per cubic centimeter	Pressure in kilobars	
		Measured	Calculated
Composition B, grade A	1.717	295	-
Composition B-3	1.715	287	-
Composition C-4	1.59	-	257
Cyclotol 77/23	1.752	316	-
DATB	1.78	259	250
HBX-1	1.712	220.4	-
HMX	1.89	390	394
HNAB	1.60	205	-
HNS	1.60	-	200
LX-14	1.833	370	-
Nitrocellulose (12.0% N)	1.58	-	200
Nitrocellulose (13.35% N)	1.58	-	210
Nitroglycerin	1.59	253	251
Octol 77.6/22.4	1.821	342	-
Pentolite 50/50	1.70	-	255
PETN	1.77	335	332
PETN	1.67	300	280
PETN	0.99	87	100
RDX	1.767	338	348
TATB	1.88	-	291
Tetryl	1.71	-	260
TNT	1.63	210	223

**4-6. Blast Effects.** When a high explosive is detonated, the solid charge is rapidly converted to gaseous products. This process, which occurs in about 0.001 second, develops very high temperatures and pressures. Of the total energy available, as much as half may be used to expand the bomb casing and the remainder is used to compress the surrounding environment.

a. *Blast Effects in Air.*

(1) When an explosive charge is detonated in air, the gaseous products expand rapidly and compress the surrounding air. The air moves outward with high velocity, thus initiating a shock wave. This layer of compressed air is bounded by an extremely sharp front called the shock front in which the pressure rises abruptly. The shock front moves outward with an initial velocity much greater than that of sound but, after a short distance, the velocity decreases rapidly. The

gaseous products of detonation move as a strong wind behind the shock front and are prevented by their own inertia from decreasing in velocity as rapidly as the pressure at the point of detonation decreases. As a result, a rarefaction effect is produced at this point and the pressure decreases. This condition of reduced pressure also moves outward, trailing the shock front. When the pressure becomes less than atmospheric, the wind reverses in direction and blows backward toward the point of detonation. Any light object, such as a leaf, when struck by the shock front, is rapidly carried away from the point of detonation and then is blown back almost to the original position when the wind reverses. The shock front, the high pressure area behind it, and the following rarefaction form a complete wave to which the terms blast and shock wave, generally, are applied (figure 4-9).

(2) While the duration of the positive pressure portion of the blast wave is about one-fourth that of the portion at less than atmospheric pressure, the amplitude of the pressure at the shock front is much greater than the amplitude of the decrease in pressure below atmospheric. The duration of the positive phase varies with the explosive charge and distance from the point of origin. In one case, the duration of the positive phase is of the order of 0.006 second at a distance of 15.5 meters from the bomb. A wall struck by such a blast wave is first pushed forward by the short, sharp, hammer-like blow of the positive pressure phase and then pulled backward by the much longer negative phase. Whether the wall falls forward or backward depends upon circumstances.

(3) Blast effect is measured by two criteria, peak pressure and impulse. Peak pressure is the pressure increase at the shock front or the highest pressure in the shock wave minus atmospheric pressure. Impulse is mathematically equal to the area under the time-pressure curve for the duration of the positive phase (figure 4-9). This is approximately half the peak pressure multiplied by the duration of the positive phase. Peak pressure represents a measure of the maximum force exerted against a surface by a blast wave, since force is equal to the product of pressure and area. Impulse represents a measure of the force multiplied by the duration.

(4) As the shock front moves outward, the peak pressure decreases and the duration of the positive pressure phase increases. The rates of these changes vary with the magnitude of the peak pressure, but the net effect is decrease in impulse. With increase in distance from the bomb, impulse decreases approximately as the reciprocal of the radius.

(5) In general, two criteria must be satisfied in order to demolish any structure. Both peak pressure and impulse must exceed certain minimum values which depend upon the type of structure. Window glass requires a moderately high peak pressure but only a low impulse value since the positive pressure need not last long to cause fracture. On the other hand, a brick wall withstands only a small peak pressure, but the pressure must be of relatively long duration and therefore the impulse value must be high. The blast from almost any charge that develops sufficient peak pressure will have sufficient impulse to break glass. Most bomb charges that develop sufficient impulse to demolish a brick wall also develop sufficient peak pressure to do so. A general rule is that structures that are strong and light in weight, with respect to the area presented to the shock front, require high peak pressure but no great impulse for demolition. Heavy but relatively weak structures require considerable impulse but not such a high peak pressure.

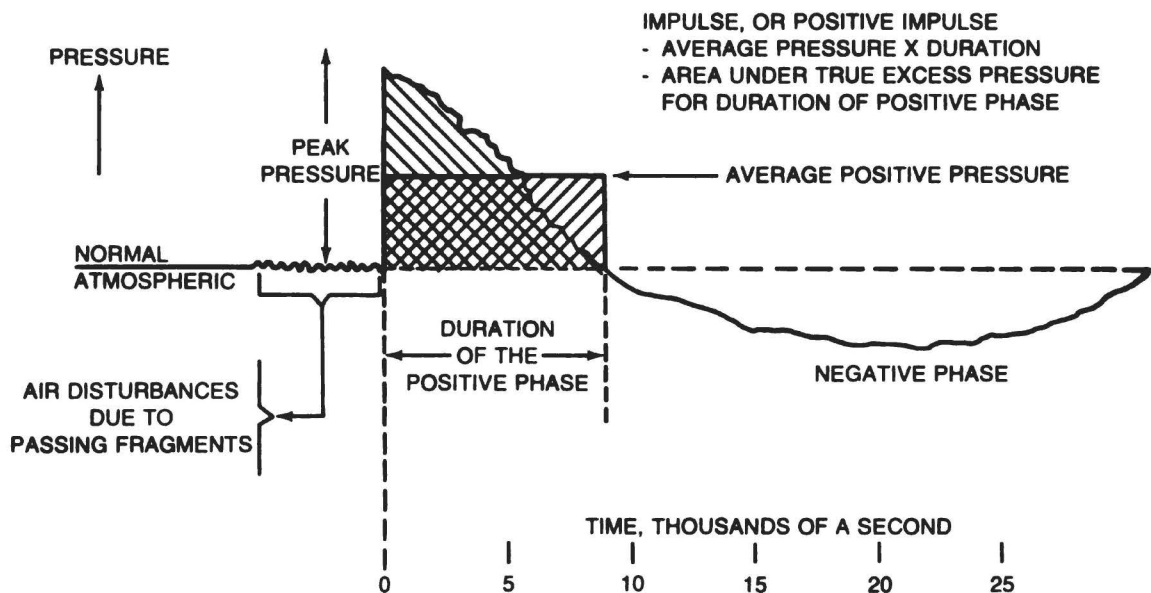

Figure 4-9. Typical pressure-time record for the blast from a bomb.

(6) Blast waves are reflected from solid surfaces but not in the same manner as sound and light waves are reflected. When the incident and reflected waves intersect on the ground, they do not make equal angles with the ground as do sound waves. Refer to figure 4-10. At small angles of incidence (the angle between the normal to the blast front and the normal to the reflecting surface), the angle of reflection is smaller than the angle of incidence, and the pressure behind the reflected wave is greater than behind the incident wave. Such reflection of a blast wave from a bomb that has detonated above the ground gives rise to an increased pressure wave at ground level. When the angle of incidence ( $\alpha$ ) is greater than an extreme angle ( $\alpha_e$ ) (40 degrees for strong to a value approaching 90 degrees for very weak shocks), the incident and reflected waves do not intersect on the ground. This is known as irregular or Mach reflection. Reflection that occurs when the angle of incidence occurs at the extreme angle is known as the extreme regular reflection, whereas, reflection occurring where the angle of incidence is smaller than the extreme is known as regular reflection. When the incident angle exceeds the extreme angle, the reflected and incident waves intersect at some point above the ground. The lower portion of the reflected and the incident waves fuse into one wave which is known as the Mach stem (M, figure 4-10), the point of intersection being known as the triple point (TP, figure 4-10). The resulting existence of three waves, termed the Mach reflection, causes a density discontinuity and a region of high pressure termed the Mach region is formed. The pressure behind the front of the Mach region is approximately twice that of the incident wave. The top of this high-pressure region, the triple point, travels away from the reflecting surface. As pressure and impulse appear to have their maximum values just above and below the triple point, respectively, the region of maximum blast effect is approximately that of the triple point. The region of maximum blast effect is determined by the height above the ground at which the blast occurs. At distances that are large compared to the height of the burst, the incident and reflected waves have fused and proceed outward as a single shock. After the point of complete fusion of the waves, the shock wave is the same as one produced by a double charge detonated on the ground. As the distance from point of the blast increases, the Mach stem becomes normal to the ground.

(7) Blast effects are enhanced by confinement due to the reflection of blast waves by the confining surfaces. A blast wave traveling through a tunnel, corridor, trench, or even a street decreases in intensity much more slowly than in the open. If a bomb detonates

within a building, there is considerable reflection of the blast wave from the walls, even if they are demolished. The rapid reflection of the wave from various walls, in such a case, results in a multiple punch effect on another wall. The overall effect of confinement is increased in the vulnerable radius of demolition of the bomb charge. The analogous vulnerable radius of visible damage (as detected by aerial observation) is also used to evaluate the effects of bombing.

b. *Blast Effects Underground.* An explosive charge, if detonated while buried, exerts pressure on the surrounding earth and causes movement effects over a distance known as radius of rupture. If the depth of burial is less than the radius of rupture, the explosion products blow through the surface of the ground and form a roughly circular depression known as a crater. An explosion on the surface of the ground makes a shallow crater which may be a greater diameter than that produced when the explosive is buried. This is due to the scouring action of gases projected downward from the explosive charge. Important factors in crater formation are the type of earth cratered and the type of explosive used. Explosives of a moderate charge in swampy ground make a relatively huge crater, while in a rock formation only a small crater will be formed. An explosive of low detonation rate that produces a large volume of gases, may form a larger crater than TNT if the charge is well below the surface and the ground is not too hard or rocky. If the charge is on the surface, a low-rate explosion makes a smaller crater than TNT because of the weaker scouring action of the lower velocity gases. If an explosive is buried at a depth exceeding the radius of rupture, the compression effect downward and horizontally and the lifting with subsequent subsidence cause a depression on the surface known as a camouflet.

c. *Blast Effects Under Water.* The detonation of high explosive under water results in shock waves of extremely high pressure which decay rapidly with distance from the charge. Since the total damage is due to both the shock wave and the subsequent bubble pulses, these effects must be separately evaluated. One measurement to make is that of the periods of oscillation of the bubble, that is, the time intervals between successive minima in the bubble radius. The length of the bubble period is related to the energy left after passage of the shock wave. In general, the longer the bubble period the greater the energy. A second measure of the energy may be obtained from a study of the maximum and minimum radii of the bubble. By a combination of radius and period measurements, energy calculations can be made.

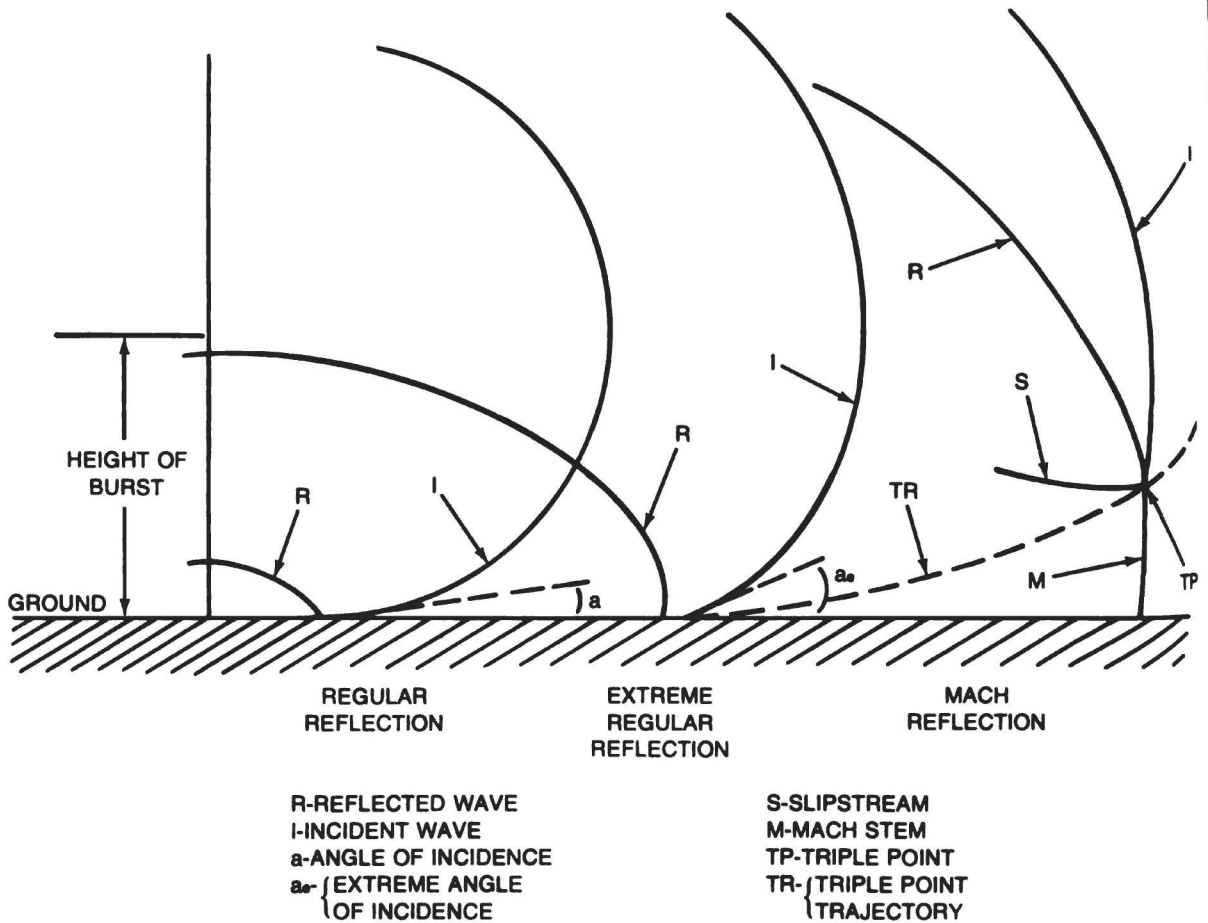

Figure 4-10. Mach reflection of blast wave.

**4-7. Shaped Charge Effect.** A shaped charge (figure 4-11) is a cylindrical explosive charge with a lined conical cavity in one end. The explosive is generally pressed or cast. The higher the detonation velocity and CJ pressure the more effective the shaped charge is.

Very little effect is produced by explosives having rates of detonation less than 5,000 meters per second. The liner focuses the energy of detonation, thus enabling penetration of very thick and very hard targets such as armor.

a. As the charge explodes, the detonation wave passes over the liner. The liner material is accelerated somewhat normal to the explosive-liner interface (figure 4-12). Nearer the apex of the cone, the liner mass to charge ratio is lower so the velocity the liner material attains is higher. Also, nearer the apex of the cone, the metal liner does not have to distort as much as further down. This also causes the velocity to be higher toward the apex. When the liner material converges at the center line, or axis, of the charge, the surface material is squeezed out at high velocity. This material forms the jet. Since the material closest to the apex is at a higher velocity, the portion of the jet which comes from that area is also highest in velocity. Therefore, the jet has a velocity gradient. The material in the leading tip is moving faster than the material toward the rear. The remaining material, which is the bulk of the liner, forms a heavy slug which follows the jet at a much lower velocity. After traveling a distance of about five or six diameters of the original charge, the jet begins to break up because of the velocity gradient and inhomogenities in the charge and liner. Inhomogenities in the charge and liner cause the jet particles to have slightly different directions of flight.

b. The pressure applied by a shaped charge to a target is to the order of several megabars. This is well into the plastic range for almost all materials. Figure 4-13 illustrates the response of the target material to a

shaped charge jet. Penetration occurs as the target material flows out of the hole. The material dislodged in the deeper parts of the hole flows out along the walls. Penetration is affected greatly by the distance of the base of the shaped charge to the target. This is called stand-off and is usually expressed in charge diameters. There is an optimum stand-off distance for maximum penetration. At closer distances, the jet has not fully formed and at further distances the jet is breaking up, causing the particles to hit off center such that they do not contribute to penetration. Generally the optimum stand-off is between two and six charge diameters. Penetration is normally around four to six diameters but could go as high as 11 to 12 diameters. The optimum liner thickness is about three percent of the charge diameter for soft copper. If a different material is used, the thickness should be determined by measuring the weight of soft copper that would be used for the particular charge diameter. This amount of material is then used. Liners made of less dense material will be thicker than the copper counterpart and liners made of more dense material will be thinner. Materials which are commonly used include copper, steel, glass, and aluminum. The angle of the cone apex varies from 42 degrees to 60 degrees in American ammunition and 18 degrees to 90 degrees in foreign ammunition. Forty-two degrees is the optimum angle for maximum penetration.

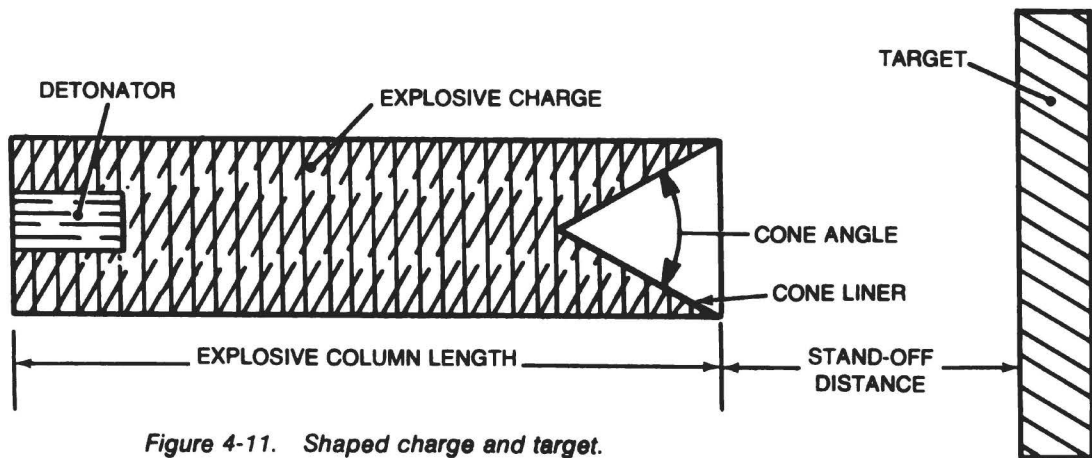
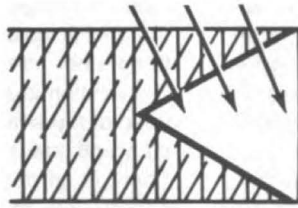
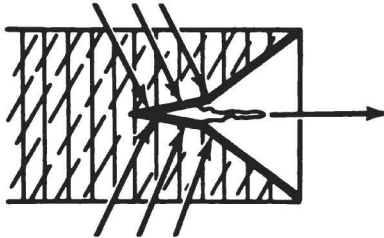

Figure 4-11. Shaped charge and target.



A. LINER IS ACCELERATED NORMAL TO EXPLOSIVE-LINER INTERFACE



B. MATERIAL IS SQUEEZED OUT TO FORM THE JET

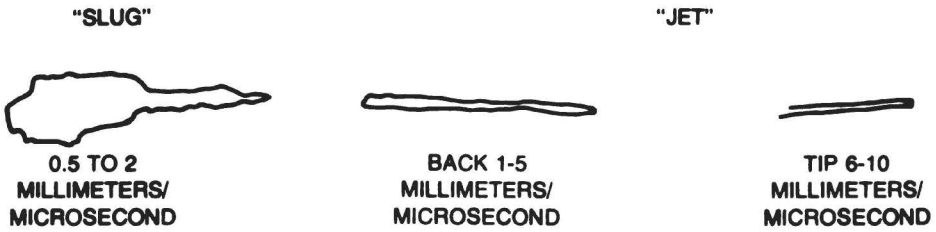

C. SHAPED CHARGE JET

Figure 4-12. Shaped charge jet formation.

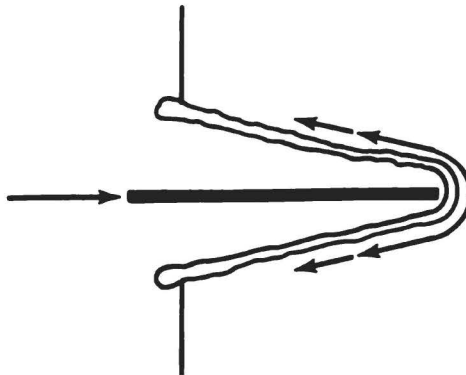

Figure 4-13. Shaped charge penetration.

c. When used in projectiles that rotate, shaped charge penetration is considerably reduced. Projectiles that have conical liners may lose as much as 50 percent of their effectiveness due to rotation. In general, penetration is reduced as spin increases from about zero to 200 revolutions per second, after which further increases have little effect. Rotating shaped charges produces holes of greater diameter than static charges, but rotation does not affect the volume of the hole produced. Changing the apex angle of the cone does not eliminate the reduction in penetration caused by rotation of the charge.

d. The United States uses one other geometry of shaped charge liner, hemispherical. A hemispherical liner produces comparable jet energies to a cone-shaped liner. However, the velocity and mass distribution in the jet are different. Hemispherical liners turn inside out with almost all of the material projected in the jet. As much as 70 to 80 percent of the material in conical liner stays behind to form the slug. In hemispherical shaped charges, however, jet velocity is only about half of that obtained in a conical shaped charge. Hemispherical shaped charges are less sensitive to rotation than conical shaped charges.



## CHAPTER 5 PROPERTIES AND TESTS OF EXPLOSIVES

---

### 5-1. General Requirements of Explosives for Military Applications.

a. *General.* Numerous compounds are explosive, however the number of compounds that can be used militarily is relatively small. This chapter describes the tests used to cull the usable explosives from the many that are unusable. Many explosive items are designed for a minimum lifespan of ten years. These tests are designed to characterize the explosive as much as possible before deployment to avoid problems during the user phase. The types of tests performed on each explosive depend, to a large degree, on the intended use of the explosive. Most of the tests yield data which are used to rank explosives relative to a standard explosive. The relative rank is then used to determine possible applications. Few tests have absolute ranges that explosives must fall into before use in military items is permitted.

b. *Availability and Cost.* In view of the enormous quantity demands of modern warfare, explosives must be produced from cheap raw materials that are nonstrategic and available in great quantity. In addition, manufacturing operations must be reasonably simple, cheap, and safe.

c. *Sensitivity.* A military explosive must be capable of being detonated and yet be as insensitive as possible. Military requirements for sensitivity are strict. Many compounds that detonate are not used as military explosives because of unfavorable sensitivity characteristics.

d. *Brisance and Power.* The brisance and power of an explosive determine applicability for specific purposes. A bursting charge must be brisant, but a ditching charge needs to be powerful and less brisant.

e. *Stability.* Military explosives must be able to withstand long periods of storage under unfavorable conditions. Storage conditions range from extreme heat and humidity in the tropics to the cold of arctic regions.

f. *Density.* The fixed volume available in a round of ammunition necessitates using explosives of maximum energy density. In general, the greater the density of the explosive the greater the energy available. This is not true, however, for some of the metallo-

organic primary explosives. The high density of these compounds is caused by the presence of mercury or lead which does not add to energy content.

g. *Hygroscopicity.* Hygroscopicity, the property of absorbing moisture, can have an adverse effect on the sensitivity, stability, or reactivity of some explosives. Explosives which are hygroscopic must be loaded in moisture-proof containers. This extra precaution is generally undesirable, so explosives which are nonhygroscopic are used. Ammonium nitrate is an exception. Although very hygroscopic, the compound is extremely cheap and readily available.

h. *Volatility.* Volatility can cause loss by evaporation, development of pressure in rounds of ammunition, and separation of ingredients in composite explosives. These undesirable characteristics must be minimized in military explosives.

i. *Reactivity.* A military explosive must be as non-reactive as possible with the materials used in construction of munitions. Compatibility of specific explosives with these materials is discussed in Chapter 8. The reactions, which are accelerated by moisture in many cases, can cause liberation of gaseous products, loss of power, and loss of sensitivity. In some cases, such as with an azide and copper, the metallic salt formed can be dangerously sensitive. When the explosive is to be loaded in contact with or mixed with another explosive or binder, reactivity between the ingredients must be minimized.

j. *Toxicity.* Minimum toxicity is a desirable quality for any military explosive. A discussion of the toxicity of the explosives of military interest is presented in Chapter 12.

k. *Environmental Impact.* The impact of manufacturing and loading operations on the environment must be as small as possible.

l. *Demilitarization.* A military explosive should have favorable demilitarization characteristics. An example is plastic bonded explosives in which a thermally sensitive binder is used. Upon heating, the binder decomposes and the explosive may be totally recovered for reloading.

m. *Vulnerability and Safety During Use.* Explosives must be as invulnerable as possible to conditions that will be encountered during use. The explosives must also be as safe as possible during both manufacture and use.

**5-2. Vacuum Stability Test.** This test can be made at 100°, 120°, or 150°C or any other desired temperature, but a temperature of 100° or 120°C generally is employed. A weighed 1- or 5-gram sample of the dried explosive is placed in a glass heating tube, so designed that the ground neck can be sealed with mercury after a calibrated capillary tube with a ground stopper end has been connected to the heating tube (figure 5-1). The lower end of the capillary tube is attached to a cup in which about seven milliliters of mercury are placed after the connection of the two tubes has been made. The system is evacuated until the pressure is reduced to about five millimeters of mercury. The level of the mercury in the capillary tube rises to near the top and its exact position is marked and recorded. The junction of the two tubes is sealed with mercury. The heating tube is inserted in a constant temperature bath maintained at the desired temperature  $\pm 0.5^\circ\text{C}$ . If an excessive amount of gas (11 + milliliters) is not evolved in less time, heating is continued for 40 or 48 hours. The tube is removed from the bath and cooled to room temperature and the level to which the mercury in the capillary tube has fallen is noted. The volume of gas liberated is calculated from the difference between the initial and final levels, the volume of the capillary per unit of length, the volume of the heating tube, and the atmospheric pressure and temperature conditions at the beginning and end of the test. Vacuum stability test yields reproducible values and when an explosive is subjected to this test at two or more temperatures, a rather complete picture of its chemical stability is obtainable. In some cases, tests at two or more temperatures are required to bring out significant differences in stability between explosives, but a test at 100°C is sufficient to establish the order of stability of an explosive. Vacuum stability test has been found suitable for determining the reactivity of explosives with each other or nonexplosive materials. This is accomplished by making a vacuum stability test of the mixture and determining if the gas liberated is significantly greater than the sum of the volumes liberated by the two materials when tested separately. When used for this purpose, the test generally is made at 100°C.

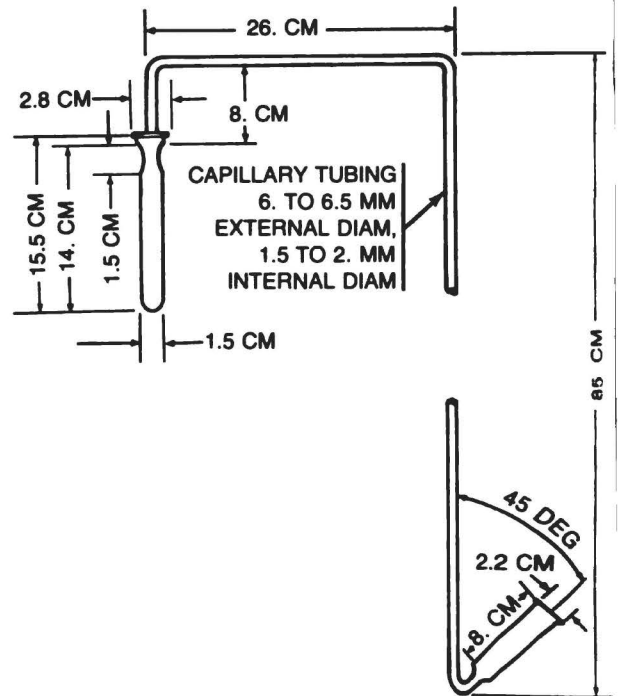

Figure 5-1. Vacuum stability test.

**5-3. Impact Sensitivity.** There are several different impact sensitivity machines in use. One type, the Explosive Research Laboratory (ERL) machine is shown in figures 5-2 and 5-3. The Picatinny Arsenal apparatus is shown in figures 5-4 and 5-5. The Bureau of Mines apparatus is shown in figure 5-6. The following discussion is relevant to the Bureau of Mines and Picatinny Arsenal apparatus. Sensitivity to impact is expressed as the minimum height of fall of a given weight required to cause at least one explosion in 10 trials, or the minimum height of fall of a given weight to cause explosions in 50 percent of the trials. In such tests, the explosive is ground so as to pass through a No. 50 sieve and be retained on a No. 100 sieve. In carrying out the test with the Picatinny apparatus, a steel die cup is filled with the explosive, covered with a brass cover, surmounted with a steel vented plug, placed in a positioned anvil, and subjected to the impact of a weight falling from a predetermined height. The minimum height, in inches, required for explosion is found after repeated trials. In making the test with the Bureau of Mines apparatus, 0.02 gram of the sample is spread uniformly on a hard steel block, over a circular area one centimeter in diameter. A hard steel tip of that diameter, imbedded in a

steel plunger, is lowered so as to rest on the explosive and turned gently so as to ensure uniform distribution and compression of the explosive. The plunger then is subjected to the impact of a weight falling from a pre-determined height. When the minimum height required for explosion is found after repeated trials, this is expressed in centimeters. The Picatinny apparatus can be used for testing explosives having a very wide range of sensitivity, but the Bureau of Mines apparatus cannot cause the explosion of the most insensitive explosives and can be used only for testing explosives no less sensitive than TNT. The Picatinny apparatus can be used for testing solid or liquid explosives. The test with the Bureau of Mines apparatus can be modified so as to be applicable to liquid explosives. This is accomplished by using 0.007 to 0.002 gram (one drop) of the explosive absorbed in a disk of dry filter paper 9.5 millimeters in diameter.

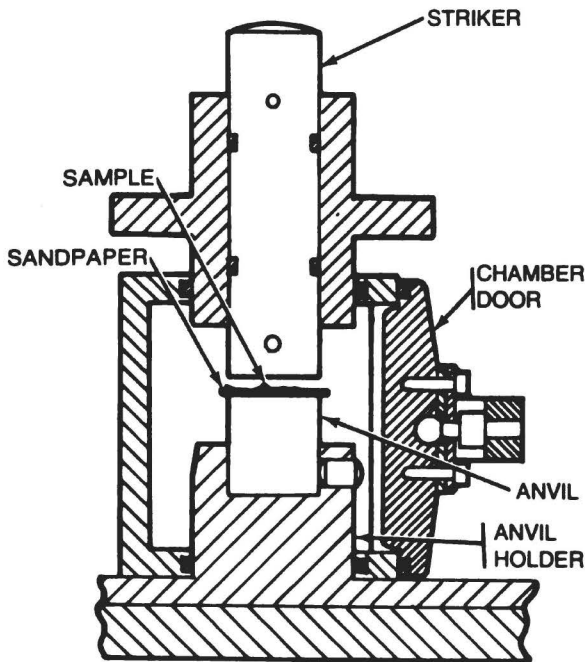

Figure 5-2. Anvil striker arrangement, ERL machine.

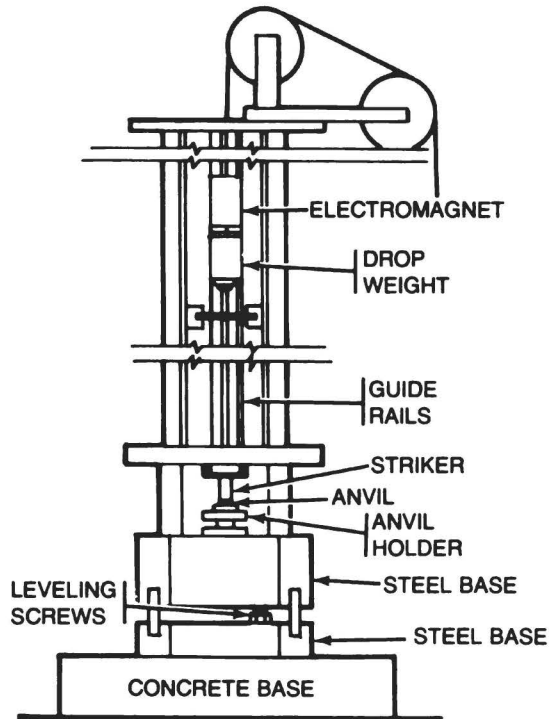

Figure 5-3. Drop weight impact machine, ERL type, type 12 tools.

**5-4. Electrostatic Sensitivity.** At the present time more than one method is used to determine electrostatic sensitivity. In all of the methods a spark gap is formed between an electrode and the explosive sample. A capacitor is charged to a specific voltage then discharged through the gap. Both the size of the capacitor and the voltage are varied to vary the energy in the spark. Compounds which deflagrate or detonate at spark energy levels less than 0.25 joules are not acceptable.

**5-5. Detonation Velocity.** Detonation velocity can be determined in any of several ways; the choice of a method probably depends more on the availability of equipment and well tested procedures than on any inherent advantage of a given method.

a. *Chronographic Method.* The chronographic method is widely used. This method depends on the closing of switches either by the conduction of hot gases between two electrodes or by the forcing together of two electrodes by the pressure induced by the detonation. Precision of the measurements depends on the number of switches or pins that is used on the charge and on the precision of the equipment.

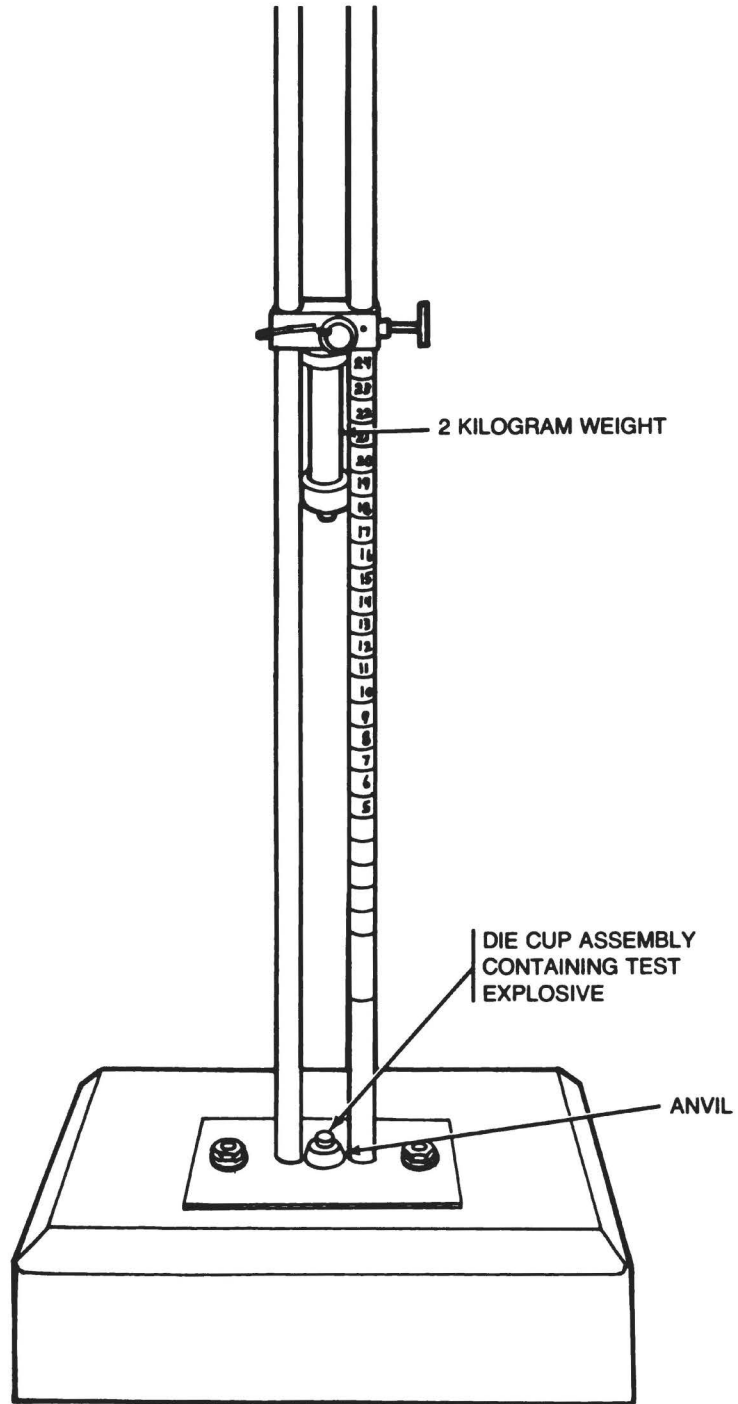

Figure 5-4. *Picatinny Arsenal impact test apparatus.*

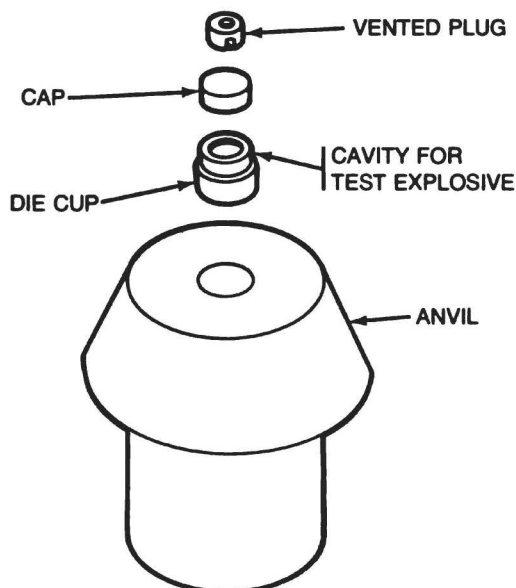

Figure 5-5. Parts of Picatinny Arsenal test apparatus.

b. *Electronic Method.* Another method, which is also entirely electronic, depends on embedding a resistance wire in the explosive. A constant current is maintained in the resistance wire and the return path, which may be a nearby embedded copper wire, a wire or foil on the surface of the charge, or a metal case if the charge is confined. The voltage across the resistance wire is recorded on an oscilloscope. This voltage decreases as the detonation moves along the wire and effectively shortens the wire. This method gives, in effect, the instantaneous position of the detonation front so that the slope of the trace on the record from the oscilloscope is proportional to the detonation velocity. A closely related technique uses a resistance wire which is wound on an insulated wire or other conducting core.

These methods are not recommended for pressed charges. The precision of either version of the resistance technique depends on the quality of the charges, the precision of making the probes, and the precision of the electronics. For smaller diameter charges, the probes and wires may perturb the detonation front so that a true value of the detonation velocity cannot be obtained.

c. *Optical Method.* A commonly used optical method makes use of the streak or smear camera to record the instantaneous position of the detonation front. Because the record gives the instantaneous location of the detonation front, the slope of the streak is proportional to the velocity. Simple data reduction techniques can be used for the application discussed here. The traces are straight so that after digitizing, the data are fitted with a linear relation, the coefficient of the time being the velocity of the detonation. Again, this method can be made to give precise results if sufficient care is taken in preparing the charges and in arranging the experiment.

**5-6. Cook-Off Temperature.** To determine the cook-off temperature, a sample of approximately five milligrams is placed on a melting point bar. The cook-off temperature is the lowest bar temperature at which the sample flashes off.

**5-7. Friction Sensitivity.** Friction sensitivity tests are made to determine the relative safety of an explosive during processing. The test may be run on any of several types of machines. In the Picatinny apparatus, a 20 kilogram shoe with an interchangeable face of steel or fiber is attached to a pendulum. The shoe is permitted to fall from a height of one meter and sweep back and forth across a grooved steel friction anvil. The pendulum is adjusted to pass across the friction anvil  $18 \pm 1$  times before coming to rest when no explosive is present. A seven gram sample of the explosive is then spread evenly in and about the grooved portion of the friction anvil, and the shoe is allowed to sweep back and forth over the anvil until it comes to rest. Tests of 10 portions of the sample are made, and the number of snaps, cracklings, ignitions, and/or explosions is noted. As the steel shoe is the more effective in causing explosions, tests with the fiber shoe sometimes will show differences between explosives indicated by the steel shoe to be of the same degree of sensitivity.

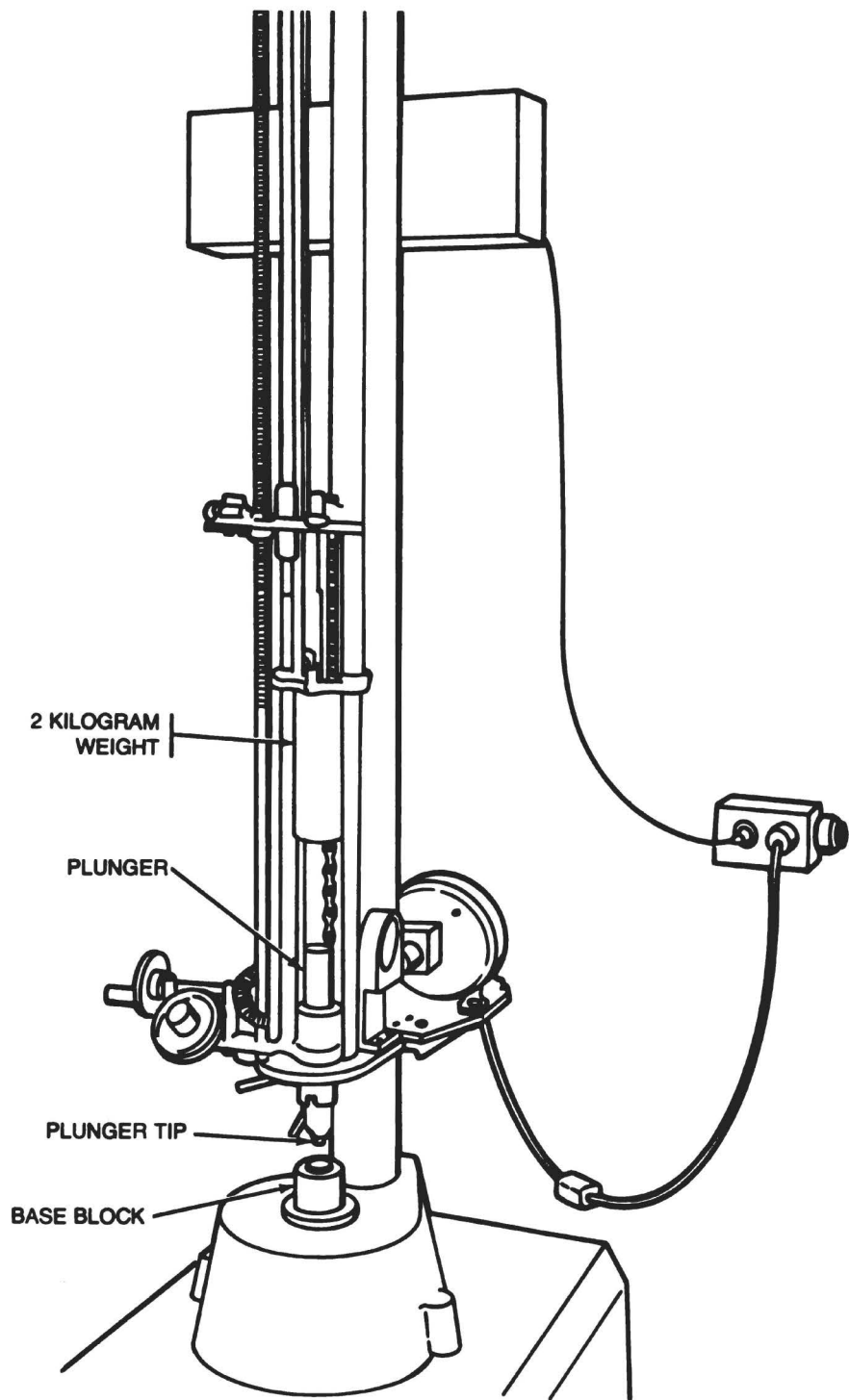

Figure 5-6. Bureau of Mines impact test apparatus.

**5-8. Gap Tests.** The gap test is used to measure the sensitivity of an explosive material to shock. The test results are reported as the thickness of an inert spacer material that has a 50 percent probability of allowing detonation when placed between the test explosive and a standard detonating charge. In general, the larger the spacer gap, the more shock-sensitive is the explosive under test. The values, however, depend on test size and geometry and on the sample (the particular lot, its method of preparation, its density, and percent voids). Gap test results, therefore, are only approximate indications of relative shock sensitivity. Tests have been developed covering a wide range of sensitivities for solid and liquid explosives at Los Alamos National Laboratory (LANL), Naval Surface Weapons Center (NSWC), Mason & Hanger-Silas Mason Co., Inc., Pantex Plant (PX), and Stanford Research Institute (SRI). The test configurations are briefly described below. In all cases, detonation of the acceptor charge is ascertained by the dent produced in a "witness plate." While there are many more potential gap test geometries, these are the test configurations for which results are reported in this manual.

a. *NSWC Small Scale Gap Test (SSGT).*

Donor 25.4 millimeters (1 inch) outer diameter × 38.1 millimeters (1.5 inches) long RDX pellet.

Acceptor 25.4 millimeters (1 inch) outer diameter × 38.1 millimeters (1.5 inches) long.

Spacer 25.4 millimeters (1 inch) diameter Lucite disks of different thicknesses.

Results are reported in millimeters.

b. *LANL Small Scale Gap Test (SSGT).*

Donor Modified SE-1 detonator with PBX-9407 pellet 7.62 millimeter diameter × 5.26 millimeters long (0.0300 inch × 0.207 inch).

Acceptor 12.7 millimeters diameter × 38.1 millimeters long (0.5 inch × 1.5 inches).

Spacer Brass shims in 2.5 millimeter (0.1 inch) increments.

Results are reported in millimeters.

c. *LANL Large Scale Gap Test (LSGT).*

Donor 41.3 millimeters diameter × 102 millimeters long (1.625 × 4 inches) PBX-9205 pellet.

Acceptor 41.3 millimeters diameter × 102 millimeters long (1.625 × 4 inches).

Spacer 41.3 millimeters diameter (1.625 inches) disks of 2020-T4 Dural (aluminum).

Results are reported in millimeters.

d. *PX Gap Test.*

Donor 25.4 millimeters diameter × 38.1 millimeters long (1 inch × 1.5 inches) LX04 pellet.

Acceptor 25.4 millimeters × 25.4 millimeters (1 × 1 inch) right cylinder.

Spacer 25.4 millimeter (1 inch) diameter brass shims in 0.25 millimeter (0.1 inch) increments.

Results are reported in millimeters.

**5-9. Flying Plate Test.** The flying plate test is used to measure the vulnerability of an explosive to high velocity impact. A steel plate is propelled by the detonation of an explosive at the sample under test. The velocity of the plate is adjusted by varying the size of the explosive charge.

**5-10. Transportation Vibration.** This test is performed on an end item to determine if the explosive is satisfactory for that specific application. The test consists of vibrating explosive components according to a specified schedule of frequencies, amplitudes, and durations while being maintained under prescribed temperate conditions.

**5-11. Temperature and Humidity.** This test consists of exposing end items containing explosives to conditions of cycling temperature and humidity.

**5-12. Jolt.** In this test an end item containing explosives is attached to the end of a pivoted arm. The arm is raised to a prescribed height and allowed to drop freely. The end item strikes a leather padded anvil. The test is repeated a prescribed number of times with the end item in a number of different orientations to the anvil.

**5-13. Jumble.** In this test an end item containing explosives is placed in a wood lined steel box. The box is then rotated about two diagonal corners at a speed of 30 revolutions per minute. The rotation is continued for 3,600 revolutions.

**5-14. Forty Foot Drop Test.** In this test, explosive components, such as bombs, are dropped 12.2 meters (40 feet) onto a hard impact surface. The impact surface consists of a steel plate on a concrete pad. The impact area is surrounded by walls of sufficient height and strength to contain the component during rebound. The component is dropped a number of times so different areas of the item are exposed to the impact. This test is used to determine the safety of both the component case and the contained explosive. No cracks, breaks, deformation, or displacement should occur in the component case. No explosion, burning, or charring of the explosive should occur.

**5-15. Growth and Exudation Characteristics.**

When explosives contain liquids as impurities, they often undergo irreversible dimensional changes when subjected to many temperature cycles between  $-54^{\circ}\text{C}$  and  $+71^{\circ}\text{C}$ . In explosives containing TNT, the dinitrotoluenes form low-melting liquid eutectics which cause problems. Mononitrotoluenes added as anti-cracking agents give large irreversible growth in TNT explosives. In the use of pure TNT explosives, one solution to the cracking problem is the use of pure TNT with addition of high melting point eutectic formers which reduce cracking without introducing objectionable irreversible dimensional change during the normal temperature variations encountered. Another cause for irreversible dimensional change is the solid polymorphic transition such as occurs with ammonium nitrate. (Refer to ammonium nitrate in Chapter 8.) Procedures for solids include measuring any cylindrical sample at least 1.27 centimeters in diameter by 1.27 centimeters in height, temperature cycled between  $-54^{\circ}\text{C}$  and  $+60^{\circ}\text{C}$  for 30 cycles or more. If no exudation or excessive growth is noted, an additional test can be made for exudation by placing two cylinders together inside a sealed can. These should be held together by parallel steel face plates and clamped together at an initial pressure of 413.7 kilopascals. The sealed unit is subjected to 30 cycles from ambient to  $140^{\circ}\text{F}$ , maintaining each temperature long enough for the entire sample to reach the temperature of the oven. The sample is then observed for exudation. Any exudate is removed and weighed.

**5-16. Rifle Bullet Impact Test.** Rifle bullet impact tests may use a .30 or .50 caliber bullet. Results reported in this manual use a .30 caliber bullet. In the .30 caliber test a bomb is prepared by screwing a closing cap to one end of a piece of cast iron pipe 7.62 centimeters long, 5.08 centimeters in diameter, and threaded at

both ends. The bomb is filled with the cast, pressed, or liquid explosive and is closed by screwing on a closing cap. With the loaded bomb in a vertical position, a caliber .30 bullet is fired through it from a distance of 30 yards, so that the bullet strikes between the two closing caps and at a right angle to the axis of the bomb. Five or more such tests are made and the percentage of explosions is noted. Those explosives which do not detonate, deflagrate, or burn are considered highly desirable. Those which burn but do not detonate are still generally satisfactory, but those which detonate are used only in applications where detonation from projectile impact is unlikely because of protection, high altitude release, or other considerations.

**5-17. SUSAN Test.** The SUSAN Sensitivity Test is a projectile impact test. The projectile head contains about 0.45 kilograms of explosive and the target is armor-plate steel. Figure 5-7 shows the projectile used in this test. The results of the tests are expressed as a sensitivity curve in which the relative point-source detonation energy released by the explosive on impact is plotted as a function of the projectile velocity. The relative point-source detonation energy can be derived from a transit-time measurement of the air shock from the point of impact to a pressure gauge three meters (10 feet) from the point of impact. The results determined in this manner are somewhat subjective, particularly when the reaction level shows a large but relatively slow increase with time. The currently preferred way to determine the point-source detonation energy is to relate it to the overpressure measured by the pressure gauge. This method gives much more reproducible data and is not subject to many of the errors of the transit-time measurements. On the figures in Chapter 8, the energy scale ranges from zero (no chemical reaction) to about 100 for the most violent detonation-like reactions (all explosive consumed). Less violent burning reactions that appear to consume all of the explosive can give values as low as 40, whereas the energy equivalent of TNT fully reacted as a point source would be 70. In the test material of Chapter 8 details of the impact process pertinent to the impact safety of an explosive are given. Remarks about probabilities of large reactions are relevant to unconfined charges in the 11 kilogram (25 pound) class. Smaller unconfined charges show a trend of decreasing reaction level as the charge size decreases. References to the "pinch" stage of impact refer to the terminal stage of the test when the nose cap has completely split open longitudinally and has peeled back to the steel projectile body, which is rapidly brought to a halt.



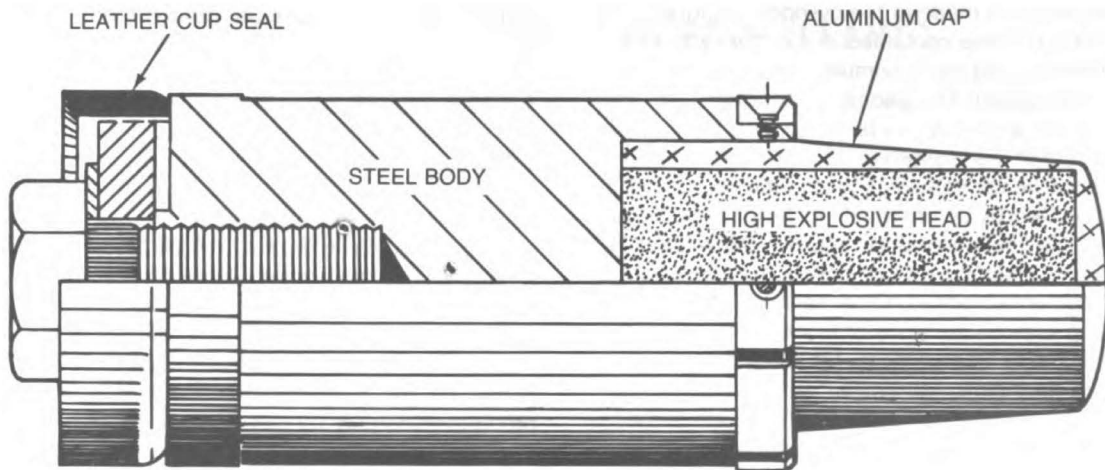

Figure 5-7. Scaled drawing of the SUSAN projectile. The high explosive head is 4 in. long and 2 in. in diameter (.102 m  $\times$  0.051 m).

**5-18. Skid Tests.** A combination of friction and impact is a frequent cause of accidents where large pieces of an explosive can be dropped a few feet. The skid test measures the sensitivity of an explosive material hitting a rigid surface at glancing angle. In one testing configuration a sample of the explosive is dropped vertically onto a hard surface inclined at 45 degrees. In another testing configuration the explosive sample is attached to the end of a pendulum. The pendulum is allowed to swing from a predetermined height.

**5-19. Adiabatic Sensitivity Test.** In the adiabatic sensitivity test a sample of the explosive is placed in an airtight holder. The top of the holder has an air compressing piston that decreases the volume and thus increases the pressure in the test chamber when struck by a falling weight. The results of the test are reported as the height the weight must fall, thus the degree of compression, to produce detonation in 50 percent of the cases.

**5-20. Fragmentation Test.** In the fragmentation test a charge of the explosive under test is loaded into a cylinder or artillery shell and detonated in a pit filled with sand or sawdust. The fragments are separated magnetically and categorized by weight. This test also gives an indication of the brisance of the explosive.

#### 5-21. Cylinder Expansion Test.

a. An important problem faced by the designer of fragmentation warheads is that he must maximize the energy which is transferred from explosive to metal during the detonation. The most frequently encountered configuration is that of an explosive-filled metal cylinder detonated by a wave moving axially. The best scaling law that has been devised for this condition is that of Gurney, who disregarded detonation conditions and shock effects in the metal and assumed implicitly that all the energy of the explosive is conserved. His equation for the cylinders is

$$v = \sqrt{2E \left( \frac{C/M}{1 + 0.5 C/M} \right)}$$

where  $v$  is the velocity to which the metal is accelerated by the explosive,  $E$  is unit energy content of the explosive,  $C$  is the weight of the explosive, and  $M$  is the metal weight. This expression of velocity in terms of  $C/M$  implies that weight-ratio scaling of explosive and metal is of prime importance and that dimensional scaling need not be considered at all. The term  $2E$  has the dimensions of a velocity as was pointed out by Gurney in his original report.

b. Determination of the Gurney constant of a warhead explosive is made in the cylinder expansion test where the explosive contained in a metal cylinder is end-detonated and the maximum lateral velocity of the metal is measured. The geometry resembles that of most fragmentation warheads, particularly as to lateral confinement of the explosive. The dimensions of the cylinder can be chosen so as to give the full run-up to detonation velocity before reaching the location of fragment velocity measurements, and the end-release effects can be kept far enough downstream so as not to affect fragment velocities. Other techniques for evaluating explosives, while of full value in their own contexts, are all less applicable to the prediction of effects in the fragmentation warhead. The plate-push test transfers only about one-fourth as much of the energy of the explosive to the metal as does the cylinder expansion; also, the air cushion between explosive and plate is highly unrepresentative of the warhead configuration. Other rating tests such as the plate dent, ballistic mortar, and the Trauzl lead block are even more unrepresentative geometrically.

c. The cylinder expansion test is any test performed where a metal cylinder (relatively thin walled) is loaded with an explosive and this explosive charge is detonated. As the detonation occurs, the expansion of the cylinder wall is observed and recorded in such a way that the rate at which the wall moves outward can be followed up to the point where the expanding cylinder wall is obscured by the reaction products as they break through the wall.

d. The method for observing the wall's expansion varies. It has been recorded through the use of electronic pin probes and raster oscilloscope recording systems as well as with flash X-ray techniques. It has also been accomplished by the use of streak cameras and framing cameras. The Lawrence Radiation Laboratory method uses a streak camera for the recording of the wall velocity and a pin probe method for determining the detonation velocity of the explosive while it is expanding the walls of the test-cylinder. The Atomic Weapons Research Establishment, UK, uses both electronic pin probe and streak camera methods to record the wall expansion, and pin probes for the detonation velocity. There is some reason to believe that, perhaps in the early stages of the expansion, the pin probe method may be more accurate, but the data reduction is also a bit more difficult in some respects than with the streak camera record.

e. When various explosives are rated in the standard geometry, the relative performance of these explosives becomes readily apparent. This permits the warhead design engineer to select an explosive compound for a specific feature of its performance.

f. It has been demonstrated that cylinder expansion test results scale up or down over a wide range of sizes.

## CHAPTER 6 PROPERTIES AND TESTS OF PROPELLANTS

**6-1. Introduction.** The tests performed on propellants can be divided into three classes: mandatory, prescribed, and optional. The mandatory tests, covered in paragraphs 6-2 through 6-13, are safety tests. These tests must be run on each propellant formulation. The prescribed tests, covered in paragraphs 6-14 through 6-17, provide useful information about a propellant formulation. These tests are generally run on propellant formulations after the mandatory tests. The optional tests, covered in paragraphs 6-18 through 6-23, are only run if warranted by the intended application of the propellant formulation. Tests in which a propellant formulation is heated are called accelerated aging tests.

**6-2. Compatibility.** Compatibility can be measured by any of three methods: Taliani test, vacuum stability test, and differential thermal analysis. The propellant and the inert material being tested for compatibility are mixed together in some ratio which may vary from equal parts of propellant and test material to 10 parts propellant and 1 part inert material. In the vacuum stability test, increased reactivity is indicated by the mixture evolving more than five milliliters of gas over the sum of the amount of gas produced by the ingredients tested separately. In a differential thermal analysis, increased reactivity is indicated by an upward displacement of the curve. In the Taliani test, increased gas production also indicates more reactivity. Increased reactivity is considered evidence of incompatibility.

**6-3. External Heat.** In this test, also called the bonfire test, the propellant formulation is loaded into a standard cartridge assembly or storage container. The sample is mounted 30.5 centimeters (one foot) above a fire which is allowed to burn for 30 minutes. The test is recorded using a 16 millimeter movie camera. The film record of the test is examined to determine if any detonation occurred. No detonation reaction is considered the acceptable criteria for a propellant formulation.

**6-4. Deflagration to Detonation Transition.** In this test, an igniter is placed in the bottom of a tall test container which is then filled with the sample material. Propellants must not undergo detonation when ignited in this manner.

**6-5. Heat Tests.** Heat tests are performed at 134.5°C for single-base propellants and 120°C for

double- and triple-base propellants. These tests measure the stability of the propellant. Specimens of the propellant are placed into the bottom five centimeters (two inches) of a glass test tube. A piece of methyl violet indicator paper is placed vertically in the tube so that the lower end of the paper is 25 millimeters from the specimen. The tube is corked and set into a constant temperature block or a constant temperature reflux bath. The temperature must be maintained to within 0.5°C. The result of the test is reported as the time required for the test paper to change color to salmon pink. For the propellant to pass the test, the color change cannot occur in less than 40 minutes or 60 minutes, depending on the propellant formulation, and the sample may not explode in less than five hours.

**6-6. Vacuum Stability.** Vacuum stability tests are performed at 100°C for single-base propellants and 90°C for double- and triple-base propellants. This test determines propellant stability on the basis of the volume of gas liberated on heating the propellant under vacuum. The propellant specimen is placed in a heating tube which is then connected to a capillary tube. Mercury is placed in a cup on the other end of the capillary tube. The system is then evacuated to approximately five millimeters. The mercury is then allowed to enter the capillary. The heating tube is then placed in a constant temperature reflux bath. The volume of gas liberated during the test is determined by observing the mercury level. If rate data is desired, the volume of gas is observed at regular intervals. If the volume of condensable gases is desired, the volume of gas is calculated based on measurements before the tube is removed from the constant temperature bath. Although there is no specific pass-fail criteria established for this test, the test is stopped when the gas volume reaches 11 + mil.

**6-7. Closed Bomb.** The standard closed bomb is a thick-walled cylindrical vessel capable of withstanding gun pressures. The bomb is equipped with firing electrodes to affect ignition, a pressure transducer, a gas release valve, a thermocouple, and temperature controlled water jacket. The result of the test is a pressure-time plot. There is no pass-fail criteria for this test.

**6-8. Surveillance.** In the surveillance test, a 45 gram sample of the propellant is placed in a 237 milliliter (eight ounce) glass, stoppered bottle which provides an essentially airtight seal. The bottle consists of a special colorless resistance glass which has no more than 0.02 percent alkalinity calculated as potassium hydroxide. The test is performed at 65.5°C. The bottle and contents are placed in a chamber and the temperature is regulated to within one degree centigrade. After 24 hours of heating, the stopper is reseated. Daily observations are then made to check for the appearance of reddish fumes which indicate the presence of oxides of nitrogen. Single-base propellants, when new, should last for fifteen hundred days before fuming. Double-base propellants should last at least 400 days. This test does not yield reliable data for triple-base propellants. For these propellants, the stabilizer content is analyzed at regular time intervals. The rate of stabilizer depletion gives an indication of the maximum storage life of the propellant. A stabilizer depletion test can also be performed on single- and double-base propellants.

**6-9. Card Gap.** The card gap test measures the sensitivity of a propellant formulation to detonation by a shock wave. A sample of the propellant is placed in a cardboard tube with a booster explosive. The explosive and sample are separated by a series of 0.254 millimeter (0.01 inch) cellulose acetate cards. The test results are reported as the number of cards necessary to prevent detonation of the sample. Three successive trials with no detonation are required. Seventy cards represent the dividing line between an explosive and fire hazard material.

**6-10. Cap.** This test determines whether a propellant formulation can be detonated by a shortened number eight blasting cap. The sample and blasting cap are placed on top of a lead cylinder. Whether a detonation occurs is determined by the degree of compression of the cylinder. The test results are reported as either a detonation, sample burned, sample fragmented but no reaction, or no reaction. To pass this test, the propellant must not detonate.

**6-11. Electrostatic Discharge Sensitivity.** This test determines the sensitivity of a propellant formulation to energy from an electrostatic discharge. A test sample of not more than 50 milligrams is placed on a test plate. A capacitor is charged to the desired energy level with a 5,000 volt power source and discharged into the sample through a steel needle. Results are reported as the maximum energy which can be applied without decomposing the sample. Twenty consecutive negative results are required at the specified energy level. High

sensitivity material yields results in the range of 0.001 to 0.00875 joules, medium sensitivity material in the range of 0.00875 to 0.0125 joules, and low sensitivity material in the range of 0.0125 to 12.5 joules.

**6-12. Friction Sensitivity.** This test is performed on an apparatus which consists of a metal sliding block, a stationary metal wheel that is attached to a hydraulic ram, and a weighted pendulum. The sample, amounting to no more than 50 milligrams, is placed on the block under the wheel. Pressure is applied using the hydraulic ram. The pendulum is raised to a 90 degree position and dropped. Results are reported as the maximum force which can be applied to the wheel without causing the sample to decompose. Normally, 20 consecutive negative results must be obtained. The results of this test are compared to those obtained for other propellants. Most standard propellants have values of about 4,360 Newtons.

**6-13. Impact Sensitivity.** This test may be performed on any of the standard impact sensitivity devices. The results of the test are compared with data obtained for other standard propellants.

**6-14. High Loading Rate Compression.** In this test, propellant grains are subject to compressive loading at about the same rate and in the same time frame as occurs in the chamber during firing. The propellant grains are machined to give flat parallel ends with a length to diameter ratio of approximately one. The machined samples are compressed perpendicular to the flat ends using a high rate hydraulic servo. The servo is computer controlled. The results of the test are the maximum compressive strength, the strain at the maximum compressive strength, stress-strain curves, the time to maximum compressive strength, and whether the mode of failure was brittle or ductile. A drop tower apparatus may also be used to obtain higher strain rates.

**6-15. Low Loading Rate Compression.** For this test, propellant grains are machined to give flat parallel ends usually with a length to diameter ratio of one. Solid grains are usually extruded to yield a diameter of approximately 1.27 centimeters (0.5 inches). The device used for this test is a mechanically driven, electronically controlled tester capable of continuously recording the load exerted on a test specimen. The compressive effect on the sample is also measured. The result of the test is a load-displacement curve. From this curve the strain at maximum compressive strength and maximum stress are computed.

**6-16. Taliani.** The Taliani test is used to determine the stability of a propellant. A dry sample of the propellant is placed in a tube, heated to a specified temperature (usually 110°C), and the tube is evacuated. The composition of the atmosphere above the sample is controlled by alternately filling with nitrogen or another gas and evacuating a specified number of times. The pressure is then reduced and heating is continued. The pressure in the tube is measured with a manometer. The increase in pressure as the test progresses is a measure of the rate of decomposition of the sample. The test result is a graph of the time versus the pressure in the tube. The following data is usually reported: the time in minutes required for the pressure to reach 100 millimeters of mercury, the slope of the line at 100 millimeters of mercury, and the slope of the line at 100 minutes.

**6-17. Explosion Temperature.** In this test, a sample of the propellant formulation is loaded into a gilding metal tube and then immersed in a woods metal bath which has been raised to a specified temperature. The time to ignition is recorded. Ignition is detected by noise, flash, or smoke. The ignition time is obtained at several temperatures. A time-temperature plot is made. The result that is reported, the temperature required to ignite the propellant in five seconds, is obtained by extrapolation of the time-temperature plot.

**6-18. Strand Burner.** In this test a strand of propellant that is 17.8 centimeters (seven inches) long and 3.2 millimeters (one-eighth of an inch) in diameter is placed in a bomb in which the temperature and pressure can be regulated. The strand is placed vertically in a jig and ignited at the top. Vertical burning is ensured by coating the strand with a compound that does not interfere with the burning of the propellant. Two wires are inserted through the jig, one 6.4 millimeters (one-quarter of an inch) from the top of the strand and the other 12.7 centimeters (five inches) below the first. As the propellant burns, an electronic circuit through the two wires is broken and an automatic timer is used to determine the burning time. The rate is calculated from the strand length and burning time. The effect of initial temperature and pressure on the burning rate is measured.

**6-19. 90°C Dutch Weight Loss Test.** In this test, a four gram sample of a propellant is placed in a stoppered tube and inserted in a heating block which is maintained at 90°C. Every second day the stoppered tube is removed and cooled to room temperature for 30 minutes. The stopper is then briefly lifted and closed again. The tube is weighed to the nearest milligram and reinserted in the heating block. The test results are then plotted as weight loss percentage versus the time in days, as shown in figure 6-1. The initial bump in the curve, which results from loss of volatiles, is ignored. The results reported are the number of days coinciding with the kink in the curve, which indicates the onset of instability.

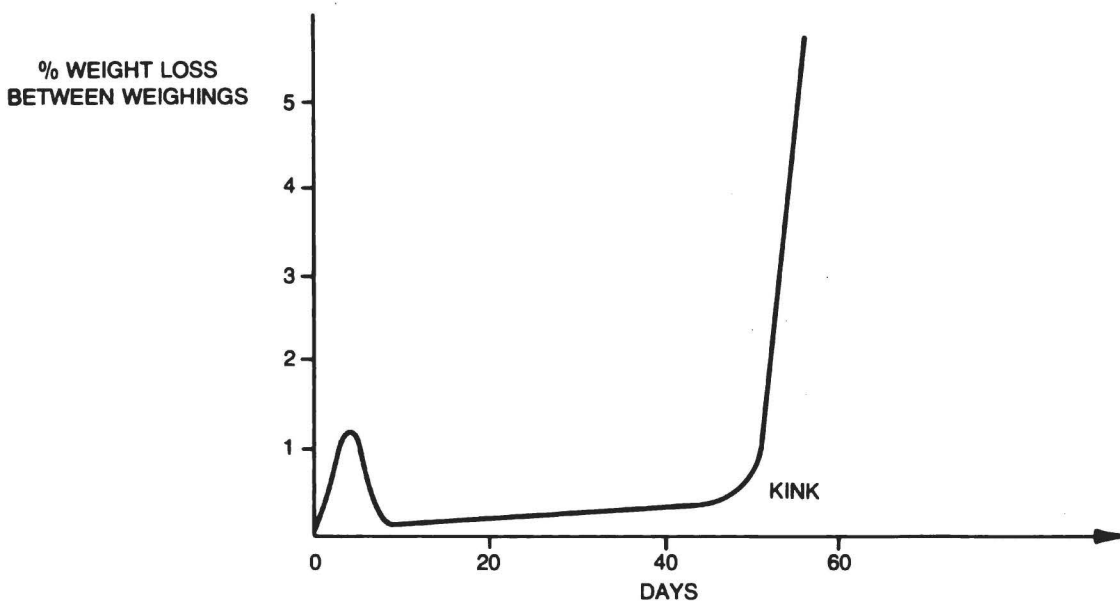

Figure 6-1. 90°C Dutch weight loss test results.

**6-20. Shaped Charge Jet Impact.** This is a vulnerability test. The propellant is loaded into a standard cartridge. The cartridge is placed behind a 1.27 centimeter (one-half inch) steel plate. A shaped charge jet is fired through the steel plate directly at the cartridge. Video tape and film are used to record the reaction of the propellant in the cartridge. The results are compared to the results for other propellants.

**6-21. Shaped Charge Jet Spall.** This is a vulnerability test. The propellant is loaded into a standard cartridge. The cartridge is placed behind a 1.27 centimeter (one-half inch) steel plate. A shaped charge is aligned so that the jet does not impact the cartridge shell when fired through the plate, but the spall from the plate does. Video tape and film are used to record the reaction of the propellant in the cartridge.

**6-22. Single Fragment Impact.** This is a vulnerability test. The propellant is loaded into a standard cartridge. Standard .50 caliber 208 grain fragments are fired into the cartridge at a velocity of about 1,585 meters per second (5,200 feet per second). The velocity of the fragments before impact is recorded and video tape and film are used to record the reaction of the propellant in the cartridge.

**6-23. Multiple Fragment Impact.** This is a vulnerability test. The propellant is loaded into a standard cartridge. Fragments are explosively launched at a velocity of about 2,286 meters per second (7,500 feet per second) in a pattern such that each cartridge is impacted by at least two fragments. The velocity of the fragments before impact is recorded and video tape and film are used to record the reaction of the propellant in the cartridge.

## CHAPTER 7

### UNITED STATES PRIMARY EXPLOSIVES

**7-1. Introduction.** This chapter contains discussions of military primary explosives. The chemical, physical, thermochemical, sensitivity, performance, and stability characteristics of each explosive are covered. The method of manufacture is also given. If known, the chemical structure of each compound is shown. This chapter also contains a discussion of priming compositions.

#### 7-2. Lead Azide.

a. Lead azide,  $Pb(N_3)_2$ , is a salt of hydrazoic acid,  $HN_3$ . The compound is white, has a nitrogen content of 28.86 percent and a molecular weight of 291.26. At the melting point, 245°C to 250°C, decomposition into lead and nitrogen gas occurs. The pure compound has two crystal modifications: an orthorhombic form and a monoclinic form. The orthorhombic form, which is also called the alpha form, has a density of 4.68 grams per cubic centimeter and unit cell dimensions of  $a=11.31$  Angstroms,  $b=16.25$  Angstroms, and  $c=6.63$  Angstroms. The monoclinic form, which is also called the beta form, has a density of 4.87 grams per cubic centimeter and unit cell dimensions of  $a=18.49$  Angstroms,  $b=8.84$  Angstroms, and  $c=5.12$  Angstroms. The compound is usually prepared as colorless, needlelike

crystals. The orthorhombic form is very sensitive. During manufacture, the production of this crystal form must be avoided. Lead azide is soluble in acetic acid and almost insoluble in ether, acetone, alcohol, ammonia, or organic solvents. In water the solubility is 0.02 percent at 18°C and 0.09 percent at 70°C. Lead azide may be dissolved in monoethanolamine or in a 50/50 mixture of monoethanolamine/ammonia. Recovery can be accomplished by adding dilute acetic acid, but the product obtained will be impure. The heat of formation at constant pressure is  $-112$  to  $-126.3$  kilocalories per mole. The calculated heat of detonation is 0.367 kilocalories per gram. Lead azide is used extensively as an ingredient in initiating compositions.

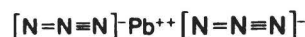

Figure 7-1. Structural formula for lead azide.

b. The forms of lead azide used for military purposes include the following types. Table 7-1 compares the properties of the types of lead azide.

Table 7-1. Various Types of Lead Azide

Properties	DLA (type I, US)	SLA	CLA (type II, US)	PVA-LA (US)	RD-1333	DCLA
Color	Buff	White	White	White to buff	-	-
Lead azide, percent	92.7	98.1	99.9	96.0	98.7	95.3
Total lead, percent	69.3	71.5	71.67	71.6	71.06	69.99
Particle size, mean, microns	24.5	55.0	3.4	19.0	34.5	1.74
Apparent density in grams per cubic centimeter	1.83	-	0.85	-	-	-
Density, pressed at 103,425 kilopascals, (15,000 psi) in grams per cubic centimeter	3.14	3.31	-	3.81	-	-
Sand test values	13.8	-	15.0	-	-	-

Table 7-1. Various Types of Lead Azide (Continued)

Properties	DLA (type I, US)	SLA	CLA (type II, US)	PVA-LA (US)	RD-1333	DCLA
Five second explosion temperature	340	350	344	340	345	-
Impact sensitivity Picatinny Arsenal apparatus with 2 kilogram weight, in inches	4-6	2	2-3	4-5	5	3-6
Charge weight in milligrams Bureau of Mines apparatus with 2 kilogram weight in centimeters	28	37	25	30	23	18
Picatinny Arsenal apparatus with 500 gram weight in inches	13-28	30	-	13-16	15	-
Charge weight in milligrams Bureau of Mines apparatus with 500 gram weight in centimeters	12	-	6	18	15	-
Charge weight in milligrams Bureau of Mines apparatus with 500 gram weight in centimeters	28	-	-	31	21	-
Minimum charge in milligrams required to initiate 60 milligrams of RDX in an M47 detonator	100 +	-	35	100 +	100 +	-
Vacuum stability in milliliters per gram 100° C, gas evolved 120 °C, gas evolved	90	25	-	30	25	-
100°C Heat test: Loss in sample wt in 8 hrs, % Loss in sample wt in 48 hrs, % Loss in sample wt in 96 hrs, % Explosion in 100 hrs	0.32 0.46	- -	- -	0.20 0.44	- 0.43	- -
Hygroscopicity at room temperature and 90% relative humidity for 56 hours	-	0.11	0.12	0.30	-	-
	0.34	0.08	-	0.13	0.30	-
	0.39	0.16	-	-	0.30	-
	None	None	-	None	None	-
	1.18	0.07	0.02	0.03	-	-



(1) Dextrinated Lead Azide (DLA) is also known as type I lead azide. Dextrin is used as a colloiding agent which prevents the formation of large, sensitive crystals and regulates crystal shape during manufacture.

(2) Service Lead Azide (SLA) consists of lead azide crystals each containing a nucleus of lead carbonate. This form of lead azide is used extensively in the United Kingdom. The method of manufacture of this compound is confidential. SLA is practically nonhygroscopic and is superior to DLA in functioning characteristics. Storage under water is considered hazardous due to the possibility of growth of the crystals and formation of agglomerates which detonate spontaneously. Other long term storage tests dispute this result.

(3) Colloidal Lead Azide (CLA) is also known as type II lead azide. CLA is nondextrinated lead azide of very small particle size. The size of the particles is in the range of three to four microns. CLA is not suited for uses requiring good flow characteristics, but, because of the very fine particle size, is ideal as a spot charge and a priming charge in low energy, electric initiators. CLA successfully replaced the milled DLA formerly used for this purpose, thus eliminating the milling operation which was always considered dangerous, even under carefully controlled conditions. In preparing a spot charge for a low energy, electric detonator, dry CLA is mixed with a concentrated solution of nitrocellulose in ether, alcohol, or other organic solvent, and a small quantity of the resulting paste is placed on the bridgewire to form a droplet called a spot. For a type of detonator in which the bridgewire is located inside a cavity, the charge of CLA can be made in the form of a pellet by pressing wet CLA into the cavity.

(4) Polyvinylalcohol Lead Azide (PVA-LA) consists of lead azide crystals coated with polyvinylalcohol. PVA-LA possesses practically the same sensitivity to impact as DLA, but is much more efficient in detonators and is practically nonhygroscopic. The ignitability is about the same as for straight lead azide and better than for DLA. The normal lead azide content is 93 to 96 percent. Other substances, such as polyethylene glycols and ureaformaldehyde polymer, can be used to produce mixtures with properties very similar to PVA-LA.

(5) RD-1333 lead azide is an insensitive form of lead azide. The method of manufacture as well as some properties of RD-1333 are confidential.

(6) Dextrinated Colloidal Lead Azide (DCLA) is essentially DLA with a very small particle size. The particle size is in the range of one to two microns.

c. In the manufacture of DLA two stock solutions must be prepared. Solution A is prepared by dissolving about 73.9 kilograms (169 pounds) of lead nitrate in about 750 liters of water treated by the permutit demineralization process. Care must be taken to remove all grit and insoluble matter. The pH of this solution is in the range of 4.2 to 4.6. To neutralize this acidity 25 to 30 grams of sodium hydroxide in dilute solution are added. The sodium hydroxide will neutralize the occluded acid and the acid formed by the hydrolysis of the lead nitrate. An excess of sodium nitrate must be avoided to prevent the production of elongated crystals which are very sensitive. About 4.08 kilograms of potato dextrin that was previously dissolved in about 100 liters of water is then added and the solution is brought to  $7.325 \pm 0.07$  percent lead nitrate content. Solution B is prepared by diluting a refined solution of 27 percent sodium azide to  $3.175 \pm 0.02$  percent sodium azide content. Then 794 grams of sodium hydroxide in the form of pellets are added. The sodium hydroxide is added to neutralize most of the free acid formed during the interaction of solutions A and B. This quantity of sodium hydroxide is also just sufficient to control the purity of the finished lead azide by precipitating a small quantity of lead as  $Pb(OH)_2$  or  $Pb(OH)N_3$ . The solution is then adjusted to  $3.175 \pm 0.025$  percent sodium azide content. Solution A is then heated to between  $57.5^\circ C$  and  $60^\circ C$  with agitation and 50 liters of solution B are added at the rate of two liters per minute. The slow rate of mixing these two very dilute solutions inhibits the formation of the orthorhombic crystalline polymorph. After solution B has been added, the temperature is lowered to  $90^\circ C$  or lower with continued agitation. When agitation stops the lead azide settles out. The precipitate is caught on filter cloths under vacuum and washed with four changes of

water to remove the acidity. To manufacture colloidal lead azide, a solution of four percent sodium azide is maintained at 25°C. Then a solution of lead acetate or lead nitrate is added with agitation. The lead nitrate or acetate is in slight excess of the amount required by the equation:



The resulting slurry is then filtered and the precipitate washed with several changes of water and dried.

d. The specifications for dextrinated lead azide, type I, and colloidal lead azide, type II, are:

Properties	Type	
	I	II
Color	White to buff	White to buff
Form, dimension maximum	Free from needle shaped crystal	-
Purity, minimum	91.5%	99.0%
Acidity	None	None
Solubility in water, maximum	1.0%	-
Particle size geometric mean, micron maximum	-	5
Largest micron maximum	-	10

A needle shaped crystal is defined as a crystal having a length to diameter ratio of 7 to 1 or greater. Needle shaped crystals are more sensitive than crystals of normal shape and tend to detonate under pressure. RD-1333 lead azide must be precipitated from a solution of sodium carboxymethyl cellulose which is used as the crystal growth agent. The color shall be white to buff. The aggregates shall contain no well defined translucent crystals when examined microscopically. The particles shall be opaque and irregular in size and shape and the powder shall be free flowing. RD-1333 lead azide must have a minimum bulk density of 1.1 grams per milliliter, be 98.5 percent pure, have a pH in the range of 7.5 to 5, and have a maximum solubility of one percent in water. In nitric acid, the insoluble material shall be no more than 0.05 percent and none of the material shall be retained on a US standard sieve 230. In addition there shall be no more than trace quantities of iron, copper, chlorides, nitrates, and acetates. Carboxymethyl cellulose may be present in concentrations of 0.6 to 1.20 percent. Another specification for special use lead azide has the same requirements as stated for RD-1333, except there is no limitation for trace quantities of iron, copper, chlorides, nitrates, and acetates.

e. Dextrinated lead azide is less sensitive to impact than mercury fulminate, lead styphnate, diazodinitrophenol, tetracene, or crystalline lead azide. The small aggregates that pass through a No. 325 sieve are slightly less sensitive than those that pass through a No. 230 sieve and are retained on a No. 270 sieve. When wet with water or 95 percent ethanol, lead azide has the comparative sensitivity values shown by table 7-2. The impact test results are from the Picatinny Arsenal apparatus with a two kilogram weight.

Table 7-2. Sensitivity of Dry and Wet Lead Azide

Composition, percent			Impact test inches	Pendulum friction test			
Lead azide	Water	Ethanol		Fiber shoe		Steel shoe	
				Trials	Detonation	Trials	Detonation
100	-	-	4	1	1	-	-
80	20	-	9	10	0	4	1
80	-	20	4	1	1	-	-
75	25	-	9	10	0	12	0

The five second explosion temperature is 315°C to 345°C for pure lead azide and 275°C for dextrinated lead azide. These temperatures are much greater than the corresponding values for mercury fulminate, lead styphnate, diazodinitrophenol, and tetracene and reflect the greater difficulty in igniting lead azide in practical use. The maximum static discharge for which no ignition takes place is 0.01 joules.

f. When subjected to the sand test, dextrinated lead azide is 95 percent as brisant as the pure crystalline material and 40 percent as brisant as TNT. At maximum density, the rate of detonation is 5,400 meters per second. The rate of detonation for samples with densities of 3.8 and 4.6 grams per cubic centimeter are 4,500 and 5,300 meters per second, respectively. Slightly higher values than these have been reported. The temperature developed on detonation is between 3,420°C and 3,484°C and the pressure developed on detonation is 94,930 kilograms per square centimeter. When lead azide detonates, 308 milliliters of gas are evolved per gram of explosive with the lead produced in the gaseous form. Trauzl lead block tests have shown dextrinated lead azide to be 89 percent as powerful as the pure compound but only 80 percent as powerful as mercury fulminate and 40 percent as powerful as TNT.

g. Lead azide is an excellent initiating agent for high explosives. While not superior to mercury fulminate for detonating the less sensitive explosives such as TNT, lead azide is markedly superior as an initiator for the more sensitive explosives such as tetryl, RDX, and PETN. Unlike diazodinitrophenol, lead azide cannot initiate the detonation of ammonium picrate or cast TNT.

h. The stability of dextrinated as well as pure lead azide is exceptional. This is indicated by 100°C heat and vacuum stability tests and also by storage tests. No change is found with respect to purity or brisance after storage for 25 months at 50°C or under a water-ethanol mixture at ordinary temperature. Storage at 80°C for 15 months caused no decrease in brisance and, after such storage, a priming composition containing lead azide showed no decrease in sensitivity to stab action. The beta form is considerably less stable than the alpha form and undergoes decomposition much more rapidly. Low X-ray dosages cause lead azide crystals to decrepitate with heat and increase in hardness. Higher X-ray dosage produces severe damage. Ninety-eight percent destruction of an SLA sample was observed after an X-ray dose of  $3.5 \times 10^8$  röntgen. Lead azide corrodes copper with the formation of cupric azide. Cupric azide is highly sensitive, so tools of brass, bronze, or copper cannot be used with lead azide. Figure 7-2 shows the DTA curve for lead azide.

### 7-3. Mercury Fulminate.

a. Mercury fulminate,  $\text{Hg}(\text{ONC})_2$ , is a salt of fulminic or paracyanic acid. The acid undergoes polymerization very rapidly in both aqueous and ethereal solutions, and so cannot be isolated. The structure of fulminic acid, and thus the salts of this acid, is undetermined. Mercury fulminate has an oxygen balance to  $\text{CO}_2$  of -17 percent, an oxygen balance to CO of -5.5 percent, a nitrogen content of 9.85 percent, and a molecular weight of 284.65. When mercury fulminate is crystallized from water, a hydrate,  $\text{Hg}(\text{ON:C}) \cdot 1/2\text{H}_2\text{O}$ , is formed that has a nitrogen content of 9.55 percent and a molecular weight of 293.64. The anhydrous form, which is crystallized from alcohol, is white when pure but normal manufacturing yields a gray product of only 98 to 99 percent purity. The crystals formed are octahedral but are usually truncated. Only the smaller crystals are fully developed. The crystal density is 4.43 grams per cubic centimeter. Table 7-3 shows the density of mercury fulminate as a function of loading pressure.

Table 7-3. Loading Density of Mercury Fulminate

Pressure in kilopascals	Pressure in pounds per square inch	Density in grams per cubic centimeter
20,685	3,000	3.0
68,450	10,000	3.6
137,900	20,000	4.0
344,750	50,000	4.3

Pressures of more than 172,375 to 206,850 kilopascals (25,000 to 30,000 pounds per square inch) cause mercury fulminate to be desensitized to the extent of becoming dead pressed. Such material merely ignites and burns when subjected to contact with flame. The dead pressed material can be detonated by a strong blasting cap. If a layer of loose or only slightly pressed mercury fulminate covers the dead pressed material, the ensemble can be detonated by ignition. When the dead pressed material is detonated, the velocity of detonation is greater than for material that has not been dead pressed. Mercury fulminate has a melting point of 160°C, but explodes at that temperature. The solubility in one liter of water is 0.71 grams at 12°C, 1.74 grams at 49°C, and 7.7 grams at 100°C. The solubility in ethanol is slight. Because of these slight solubilities, mercury fulminate can be stored underwater or, if there is danger of freezing, under a mixture of equal volumes of water and ethanol or methanol. After such storage the compound can be dried easily. Aqueous ammonium

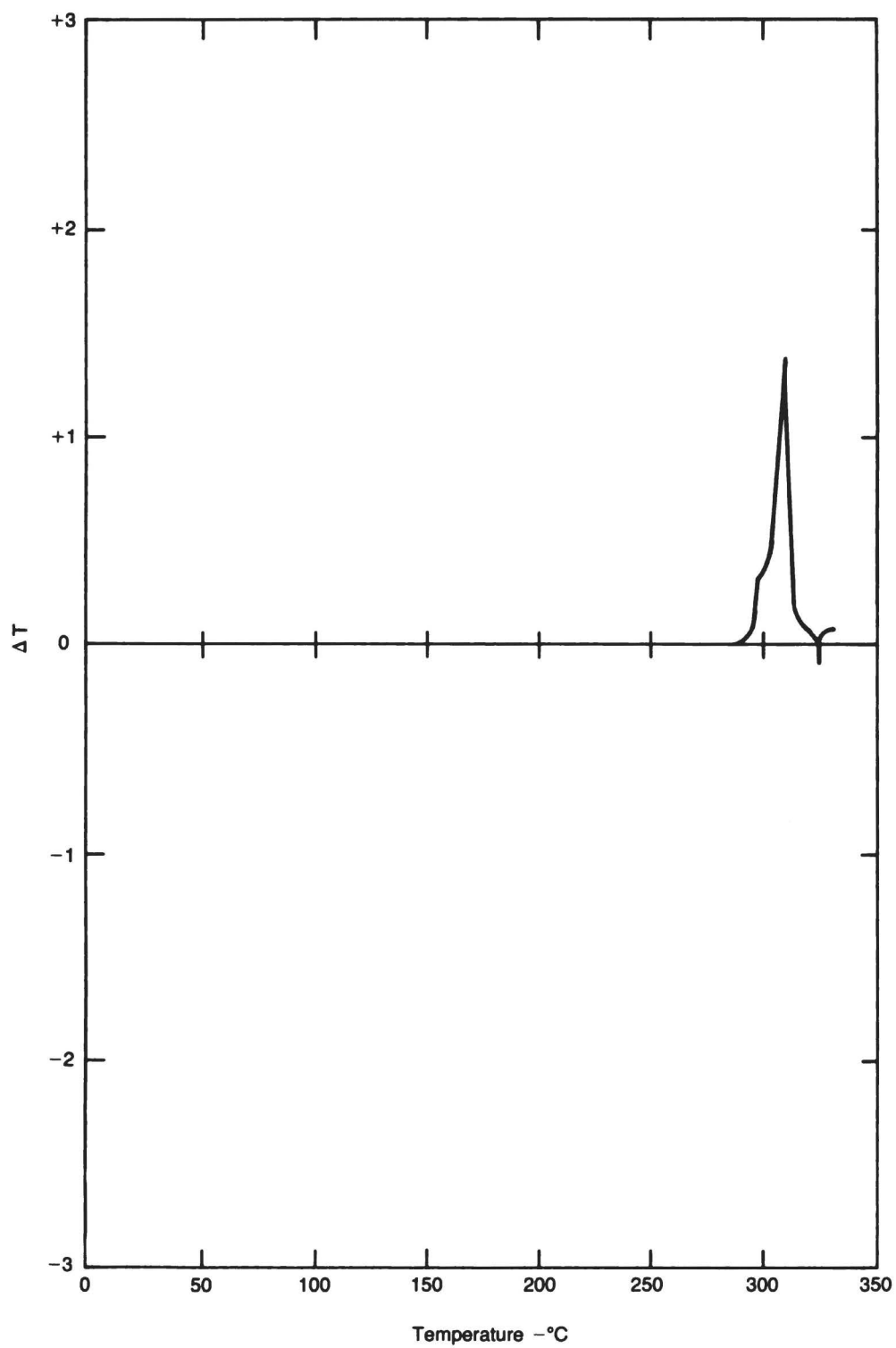
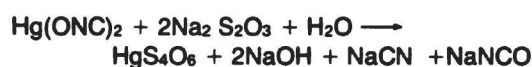

Figure 7-2. DTA curve for lead azide.

hydroxide, aqueous potassium cyanide, and pyridine dissolve mercury fulminate. The compound can be recovered by treating the ammonium or potassium solution with acid and the pyridine solution with water. The heat of formation is 221 to 226 calories per gram, heat of combustion is 938 calories per gram, and the heat of explosion is 427 calories per gram. Mercury fulminate was used extensively as an initiator, however, poor stability has prompted replacement of this compound by such initiators as lead azide.

b. Mercury fulminate reacts with concentrated hydrochloric acid to produce hydroxylamine,  $\text{H}_2\text{N.OH}$ , and formic acid,  $\text{HCOOH}$ . The reaction with sodium thiosulfate in aqueous solution forms mercury tetrathionate according to the equation:



If allowed to stand, a secondary reaction occurs with the formation of sulfate and thiocyanate according to the equation:



The first reaction can be used for the determination of the purity of mercury fulminate. Even in the presence of 0.5 percent moisture, pure mercury fulminate does not react with any of the common metals. However, the standard grade of the compound may contain as much as one percent free mercury, formed by exposure to light or elevated temperatures. The free mercury readily forms amalgams with copper, brass, or bronze, so components containing these metals must be protectively coated if used with mercury fulminate.

c. Mercury fulminate is manufactured in relatively small quantities. About one pound of redistilled mercury is added to an open, earthenware vessel or five liter flask that contains eight to ten pounds of nitric acid with a specific gravity of 1.4. The nitric acid is in excess of the amount required by the equation:



A large number of such charges are usually prepared and allowed to stand overnight until the mercury is completely dissolved. The charges are then poured into a large balloon flask which contains eight to ten pounds of 95 percent ethanol. The flask rests in a bath of running, cold water. This installation has to be either outside or in a building provided with an exhaust system. The flask is fitted with a reflux condenser. About two to three min-

utes after the acidic solution of mercury nitrate is added to the ethanol, a violent reaction starts and the liquid boils with the evolution of white fumes. Most of these fumes are recovered by the condenser. As the reaction approaches the end point, the fumes change color to brownish-red because of the decomposition of nitric acid by heat. A small quantity of dilute alcohol is added at this point to moderate the reaction and prevent the decomposition of the mercury fulminate by the heat of reaction. The reaction normally takes about an hour and a half. The reaction mix is then allowed to cool to room temperature, at which time all the mercury fulminate has settled out. The mercury fulminate crystals are then caught on a screen and washed with cold water until free of acid and five impurities known as fulminate mud. The washed mercury fulminate is then drained and packed into cloth bags which are stored in tanks of water until required for use. The acid mother liquor and the water washings are neutralized with alkali, evaporated to recover the alcohol, and treated to recover any mercury or mercury salts. The yield of the process is 120 to 130 parts per 100 parts of mercury.

d. In the manufacturing process ethyl nitrate ( $\text{C}_2\text{H}_5.\text{ONO}_2$ ), ethyl nitrite ( $\text{C}_2\text{H}_5.\text{ONO}$ ), and nitroethane ( $\text{C}_2\text{H}_5\text{NO}_2$ ) also are produced. The intermediate products of oxidation and nitration involved in the preparation of mercury fulminate are as follows:

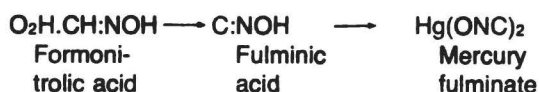
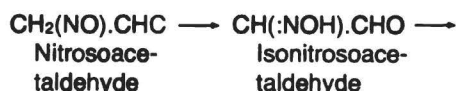
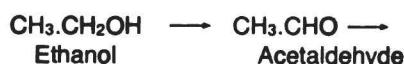

The product so obtained is not more than 99 percent pure. The material can be purified so as to have a fulminate content of 99.75 percent or more by dissolving the impure material in concentrated ammonium hydroxide, filtering the solution, cooling the filtrate, and reprecipitating slowly adding concentrated nitric acid with rapid agitation while keeping the temperature below  $35^\circ\text{C}$ . Conditions can be established so that the

precipitated fulminate is of essentially the same granulation as the impure material. The precipitated pure fulminate is washed with distilled water until free of acid. The yield is 80 to 87 percent.

e. Mercury fulminate for military use consists of one grade. The requirements applying are:

- Appearance: Crystals of sparkling appearance that are white, gray, or light gray with a yellowish tint.
- Granulation: A maximum of 15 percent retained on a No. 100 and a maximum of 75 percent passing through a No. 200 sieve.
- Sand test: 0.400 gram shall crush a minimum of 44 grams of sand.
- Mercury fulminate: Minimum, 98.0 percent.
- Acidity: None.
- Insoluble matter: Maximum, 2.0 percent.
- Free mercury: Maximum, 1.0 percent.
- Chlorine: Maximum, 0.05 percent.

The chlorine content requirement is due to the occasional use of a small quantity of cupric chloride,  $\text{CuCl}_2$ , for the purpose of improving the color of the product. The chloride is added to the solution of mercury in nitric acid. While this improves the color, there is also a decrease in the purity of the product. The insoluble matter represents decomposition products, which are formed as the result of side reactions.

f. The impact sensitivity on the Bureau of Mines apparatus with a 20 milligram sample is five millimeters and on the Picatinny Arsenal apparatus with a nonstandard 2.2 kilogram weight is four inches. This indicates mercury fulminate is more sensitive to impact than lead azide and lead styphnate. Being of the same sensitivity to impact as diazodinitrophenol and tetracene, these three compounds are the most sensitive initiating explosives used in military ammunition. Mercury fulminate is more sensitive to friction than lead azide and lead styphnate, exploding with both the steel and fiber shoe. The five second explosion temperature is  $210^\circ\text{C}$  which indicates mercury fulminate is more sensitive to heat than lead azide or lead styphnate, but less sensitive than diazodinitrophenol and tetracene. The sensitivity of

mercury fulminate to percussion is one of the compound's most advantageous characteristics. Mercury fulminate is highly sensitive to electric spark. A spark from a person charged to less than 5,000 volts causes ignition. This condition is possible in plant operations. The sensitivity to electrostatic discharge is reported to be 0.025 to 0.07 joules.

g. The sand test indicates mercury fulminate is 27.3 to 59 percent as brisant as TNT. The rate of detonation of a charge with a density of 2.0, 3.0, and 4.0 grams per cubic centimeter is 3,500, 4,200, and 5,000 meters per second. When ignited, a single crystal will burn rapidly with a flash, but detonation does not take place. When a layer of crystals is ignited, high order detonation takes place. The Trauzl test indicates a power of 37 to 50 percent of TNT. Mercury fulminate is distinctly more powerful than lead azide.

h. Although mercury fulminate is not as efficient an initiator of detonation as lead azide and diazodinitrophenol, satisfactory results are obtained when used in conjunction with tetryl, RDX, or PETN, the most generally used booster explosives. The number of grams of mercury fulminate required for complete detonation of TNT is 0.25 to 0.36, for tetryl is 0.20 to 0.29, for RDX is 0.19, for PETN is 0.17, and for explosive D is 0.85.

i. Mercury fulminate is no longer used by the United States military because of poor stability. The usual stability tests are not applicable to mercury fulminate, due to explosion in a relatively short time at temperatures above  $85^\circ\text{C}$ . The products of deterioration are nonexplosive solids rather than gases. When the purity of mercury fulminate is reduced to about 92 percent, the initiating efficiency is destroyed although the material will explode when ignited. When purity has been reduced to 95 percent, the stability of mercury fulminate must be considered seriously impaired. Table 7-4 gives a summary of the approximate times of storage required to cause deterioration to 92 percent and 95 percent. Mercury fulminate gains 0.02 percent when exposed to 90 percent relative humidity at  $30^\circ\text{C}$ . When dry, mercury fulminate reacts rapidly with aluminum and magnesium and reacts slowly with copper, zinc, brass, and bronze. When wet, mercury fulminate reacts immediately with aluminum and magnesium and rapidly with copper, zinc, brass, or bronze. Dry or wet, the compound does not effect iron or steel.

Table 7-4. Deterioration of Mercury Fulminate

Storage temperature °C	Time required to reduce purity to					
	95 percent			92 percent		
	Days	Months	Years	Days	Months	Years
80	0.5	-	-	1	-	-
50	-	8	-	-	11	-
30-35	-	-	1.7	-	-	5.8
20	-	-	7	-	-	9
10	-	-	8	-	-	10

**7-4. Diazodinitrophenol (DDNP).**

a. This explosive is also known as 4,5-dinitrobenzene-2-diazo-1-oxide, dinol, diazol and may be referred to as DADNP. The compound (figure 7-3) is a greenish yellow to brown solid with tabular crystals. DDNP has a crystal density of 1.63 to 1.65 grams per cubic centimeter at 25°C and a molecular weight of 210.108. DDNP is not dead pressed even at a pressure of 896,350 kilopascals (130,000 pounds per square inch). The solubility of DDNP in various solvents is shown in table 7-5.

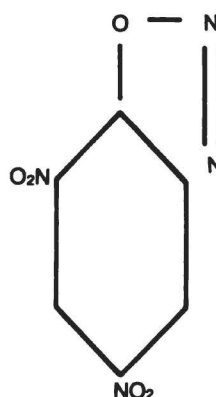

Figure 7-3. Structural formula for DDNP.

Table 7-5. Solubility of Diazodinitrophenol

	Solubility, grams per 100 grams of solvent at-	
	25°C	50°C
Water	0.08	-
Benzene	0.09	0.23
Methanol	0.57	1.25
Ethanol	0.84	2.43
Ether	0.04	-
Chloroform	-	0.11
Ethylene chloride	0.29	-
Acetic acid	1.40	-
Ethyl acetate	-	2.45
Acetone	6.0	-

b. At ordinary temperatures DDNP does not react with water, but the mixture of the two is less sensitive than DDNP alone. DDNP is darkened rapidly by exposure to sunlight, probably because of oxidation at the surface.

c. The process used commercially for the manufacture of DDNP is not available, but the compound can be prepared by the diazotization of picramic acid by means of sodium nitrite and hydrochloric acid. The reactions involved are shown in figure 7-4. Picramic acid may be prepared by evaporating a mixture of an alcoholic solution of ammonium picrate and ammonium sulfide and purifying the product. Ten grams of picramic acid are suspended in 120 milliliters of a five percent aqueous solution of hydrochloric acid. The mixture is cooled with an ice bath and stirred rapidly. A solution of 3.6 grams of sodium nitrite in 10 milliliters of water is added all at once and stirring is continued for 20 minutes. The dark brown, granular material that separates

DDNP is also soluble to some extent in nitroglycerin, nitrobenzene, aniline, pyridine, and concentrated hydrochloric acid. DDNP is nearly insoluble in carbon tetrachloride and carbon disulfide. The heat of formation is 956 calories per gram and the heat of explosion is 820 calories per gram. DDNP is used as an ingredient in priming compositions and in commercial blasting caps.

is caught on a filter and washed with ice water until the washings give no indication of hydrochloric acid or sodium chloride. If this material is dissolved in hot acetone and a large volume of ice water added to the agitated solution, the DDNP is precipitated as a bright yellow, amorphous powder. Recrystallization from a solvent is used to produce the tabular crystals that comprise specification grade material. After manufacture, the DDNP is kept wet with water until used.

d. Only one grade of DDNP is used for military purposes. This complies with the following requirements:

Color:	Greenish yellow to brown.
Form:	Tabular crystals having a maximum length of 0.2 millimeter.
Granulation:	100 percent shall pass through a No. 100 US standard sieve.
Bulk density:	Minimum, 0.4 grams per milliliter.
Acidity:	Maximum, 0.01 percent as hydrochloric acid.
Sand test:	0.40 gram shall crush not less than 33 grams of sand.

e. DDNP is less sensitive to impact than lead azide or mercury fulminate. The friction sensitivity is approximately the same as lead azide but less than mercury

fulminate. The five second explosion temperature is 195°C. A mixture of DDNP and water is desensitized to the extent that a number eight blasting cap cannot cause detonation. DDNP detonates when struck with a sharp blow. An unconfined sample burns with a flash if ignited but even the slightest confinement causes a transition from burning to detonation. A charge of DDNP undergoes detonation when ignited if pressed into a blasting cap shell with a reinforcing cap and a piece of black powder safety fuse crimped in the shell. A spark falling into the open end of such a blasting cap causes only ignition and flashing of the DDNP. The maximum energy of a static discharge that does not cause ignition is 0.25 joules.

f. The sand test indicates DDNP is 94 to 105 percent as brisant as TNT. DDNP is considerably more brisant than mercury fulminate, lead azide, lead styphnate, and tetrazene. At a density of 1.58 grams per cubic centimeter DDNP and TNT have the same velocity of detonation, 6,900 meters per second. At densities of 0.9 and 1.63 grams per cubic centimeter the detonation velocities are 4,100 and 7,100 meters per second, respectively. The Trauzl test and ballistic mortar test indicate that DDNP is 110 percent and 95 percent as powerful as TNT, respectively. The gas volume produced on detonation is 856 liters per kilograms.

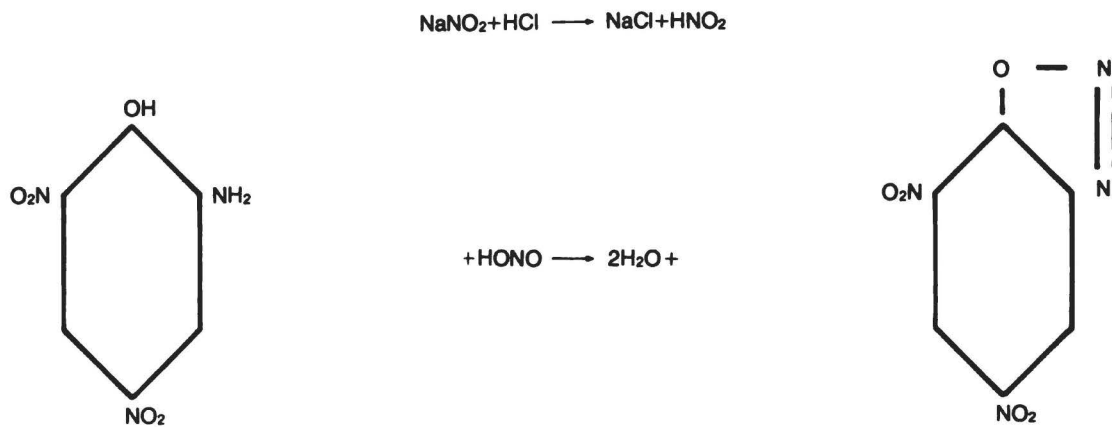

Figure 7-4. Preparation of DDNP.



g. The sand test indicates DDNP is a better initiator of detonation than mercury fulminate or lead azide for less sensitive high explosives. The most marked evidence of this is the ability of DDNP to initiate the detona-

tion of ammonium picrate and cast TNT. For initiation of the more sensitive high explosives, DDNP is not superior to lead azide. Comparative values showing relative initiating efficiencies are given in table 7-6.

Table 7-6. Efficiency of Initiating Compounds

	Minimum detonating charge, gram of initiator required to detonate		
	Tetryl	TNT	Ammonium picrate
Lead azide	0.10	0.26	No detonation
Mercury fulminate	0.19	0.24	No detonation
Diazodinitrophenol	0.12	0.15	0.28

h. In the vacuum stability test at 100°C, 7.6 cubic centimeters of gas are evolved from a five gram sample in 40 hours. In the 100°C heat test, 2.10 percent is lost in the first 48 hours, 2.20 percent in the second 48 hours, and no explosions occur in 100 hours. These results indicate DDNP is not as stable as lead azide, but is markedly more stable than mercury fulminate. Storage tests have shown dry DDNP to withstand storage at 50°C for at least 30 months, as compared with nine months for mercury fulminate. When stored under water, DDNP is of unimpaired brisance for 24 months at ordinary temperature and for 12 months at 50°C. The stability of DDNP, therefore, is considered satisfactory for commercial and military use, and DDNP and lead azide have replaced mercury fulminate in blasting caps to a large extent. DDNP is hygroscopic to the extent of 0.04 percent in an atmosphere of 90 percent relative humidity at 30°C.

#### 7-5. Lead Styphnate.

a. Two forms of lead styphnate are used as primary explosives: basic (figure 7-5) and normal (figure 7-6). Basic lead styphnate has a nitrogen content of six percent and a molecular weight of 705.53. The compound has two crystal forms: yellow needles with a density of 3.878 grams per cubic centimeter and red prisms with a density of 4.059 grams per cubic centimeter. The apparent density is 1.4 to 1.6 grams per cubic centimeter. Normal lead styphnate has a nitrogen content of nine percent and the monohydrate has a

molecular weight of 468.38. The compound has yellow orange or reddish brown, rhombic, needle like crystals with a density of 3.02 grams per cubic centimeter at 30°C. The anhydrous salt has a density of 2.9 grams per cubic centimeter. Both forms of lead styphnate are soluble in aqueous ammonium acetate. Basic lead styphnate is practically insoluble in water; normal lead styphnate is only soluble to the extent of 0.04 percent at room temperature. Normal lead styphnate is even less soluble in methanol and ethanol than in water. Both forms of lead styphnate are insoluble in ether, chloroform, carbon tetrachloride, carbon disulfide, benzene, toluene, concentrated hydrochloric acid, and glacial acetic acid. Normal lead styphnate has a heat of formation of 92.3 calories per gram, a heat of combustion of 1,251 calories per gram, and a heat of detonation of 460 calories per gram. Both forms of lead styphnate are used as ingredients in priming compositions. When used alone, despite a favorable rate of detonation and good power characteristics, lead styphnate is a relatively poor initiator of detonation. Detonation of 60 percent dynamite and sometimes gelatin dynamite is possible. However, of the military high explosives, only unpressed PETN can be detonated. The minimum detonating charge for unpressed PETN is 0.55 gram, as compared to 0.30 gram of mercury fulminate or 0.40 gram of lead azide. The ease of ignition of the compound has led not only to use in priming compositions, but also use as a cover charge for igniting lead azide.

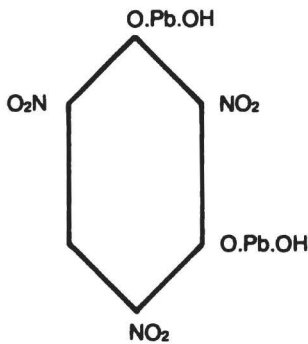

Figure 7-5. Basic lead styphnate.

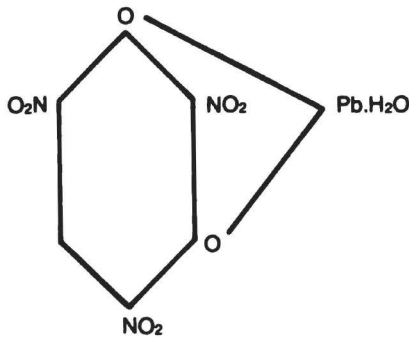

Figure 7-6. Normal lead styphnate.

b. Lead styphnate can be prepared by the reaction of lead nitrate or acetate with either sodium or magnesium styphnate in the presence of an acid. In commercial production, the magnesium salt is used. This is prepared by the reaction of magnesium oxide and styphnic acid (2,4,6-trinitroresorcinol). In one procedure, a boiling solution of lead nitrate is added to a boiling solution of sodium styphnate acidified with acetic acid. In another procedure, solutions of magnesium styphnate and lead acetate are caused to react at 70°C to form a precipitate of basic lead styphnate, which is converted into the normal salt by the addition of dilute

nitric acid. The insoluble product is filtered off and washed with water until free of acid. Like other initial detonating compounds, lead styphnate is kept under water or under a water-isopropyl alcohol mixture until used.

c. For military use basic lead styphnate must comply with the following requirements:

Appearance:	The material shall be free from visible impurities and aggregates of crystals. Type I shall be yellow to orange yellow in color. Type II shall be yellow brown to brown in color.
Crystal form:	Type I material shall consist of discrete crystals in the form of needles. Type II material shall consist of discrete crystals.
Crystal dimensions:	95 percent of the type I crystals shall have a maximum dimension between 7 and 20 microns. The length of the crystal shall not be greater than five times the width of the crystal. 95 percent of the type II crystals shall have lengths between 7 and 35 microns.
Granulation:	100 percent of the type I and II material shall pass through a US standard number 325 sieve.
Apparent density:	The apparent density of the type I material shall be 0.3 to 0.5 grams per milliliter and for the type II material, 1.40 to 1.60 grams per milliliter.
Acidity:	The pH shall be 5.0 to 6.0 in a one percent solution for the type I material, 6.0 to 7.0 for the type II material.
Material insoluble in ammonium acetate:	0.2 percent, maximum, for both type I and II material.
Material soluble in ether:	0.1 percent, maximum, for both type I and II material.
Lead content:	59.6 to 60.2 percent for both type I and II material.
Nitrogen content:	5.97 to 6.17 percent for both type I and II material.
Instantaneous flash point:	330°C to 350°C for both type I and II material.

d. For military use normal lead styphnate must comply with the following requirements:

<b>Appearance:</b>	The material shall be free from visible impurities and aggregates of crystals and be yellow brown to brown in color.
<b>Crystal form:</b>	The material shall consist of the discrete crystals of the monoclinic system and the longest dimension of any crystal shall not be greater than three times the next longest axis. Hexagonal plates are acceptable.
<b>Crystal dimension:</b>	The largest dimension of any crystal shall not exceed 0.5 millimeter.
<b>Granulation:</b>	100 percent of the material shall pass through a US standard number 100 sieve.
<b>Apparent density:</b>	1.30 to 1.60 grams per cubic centimeter.
<b>Acidity:</b>	The pH shall be between 5.0 and 6.0 in a one percent solution.
<b>Material insoluble in ammonium acetate:</b>	0.3 percent, maximum
<b>Material soluble in ether:</b>	0.1 percent, maximum
<b>Lead content:</b>	43.2 to 44.3 percent
<b>Nitrogen content:</b>	8.87 to 9.07 percent
<b>Instantaneous flash point:</b>	310°C to 330°C

e. Normal lead styphnate is slightly less sensitive to impact than mercury fulminate or diazodinitrophenol, but is more sensitive than lead azide. The friction sensitivity is less than that for mercury fulminate or lead

azide. The five second explosion temperature is 282°C, less than that for lead azide but much greater than those of mercury fulminate and diazodinitrophenol. Normal lead styphnate is much more easily ignited by flame or electric spark than mercury fulminate, lead azide, and diazodinitrophenol. The sensitivity to electrostatic static discharge is 0.001 joules. When ignited, the rate of detonation is less than the maximum rate. The calculated activation energy for the decomposition of lead styphnate is 61.5 kilogram-calories per gram molecule as compared with a value to 25.2 kilogram-calories for mercury fulminate.

f. When subjected to the sand test with ignition by a black powder fuse, the brisance of normal lead styphnate (10.5 grams of sand crushed) is much less than that of lead azide (16.7 grams of sand crushed). However, when initiated with a small charge of mercury fulminate or lead azide, the brisance (24 grams of sand crushed) is greater than that of lead azide or mercury fulminate. The range of brisance reported is from 27 to 53 percent of TNT. When initiated with blasting caps, lead styphnate pressed to a density of 2.9 has a rate of detonation of 5,200 meters per second, which is greater than the rate of detonation of either lead azide or mercury fulminate at the same density. Trauzl lead block tests, with large and small blocks, show lead styphnate to be more powerful than lead azide and 42 percent as powerful as TNT.

g. Normal lead styphnate is of a high order of stability as indicated by vacuum stability tests at 100°C and 120°C. In both tests 0.4 cubic centimeters of gas are evolved in 40 hours. The loss of 1.5 percent in the 100°C heat test may be attributable to the removal of the water of crystallization, which is present to the extent of 3.84 percent. Storage at 80°C caused no change in the 120°C vacuum stability test value, although the explosion temperature and sand test values were increased slightly. These changes also may be attributable to loss of the water of crystallization. The stability of lead styphnate is the same as lead azide and better than that of mercury fulminate or diazodinitrophenol. Figure 7-7 shows the DTA curve for lead styphnate and figure 7-8 shows the TGA curve.

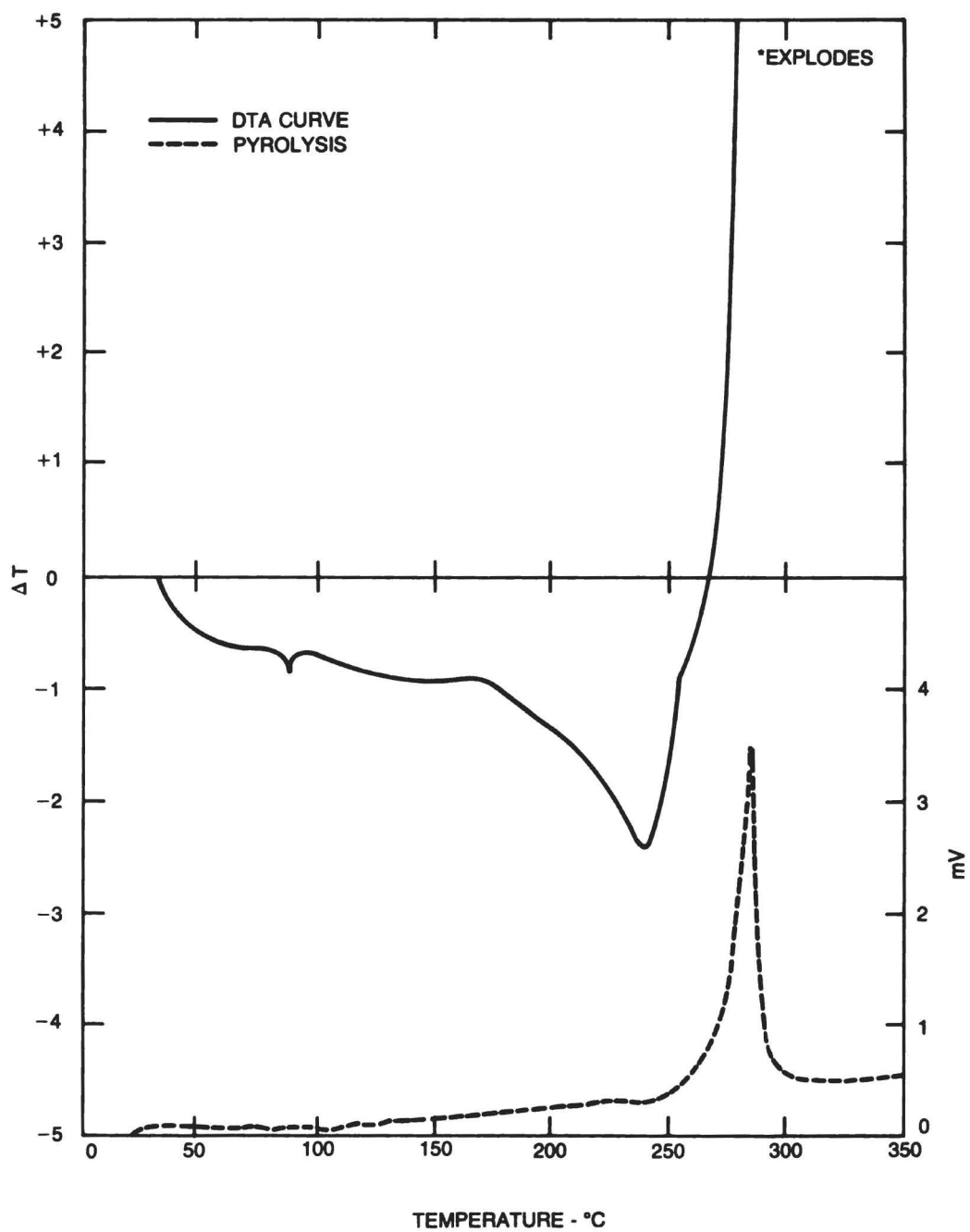

Figure 7-7. DTA curve for lead styphnate.

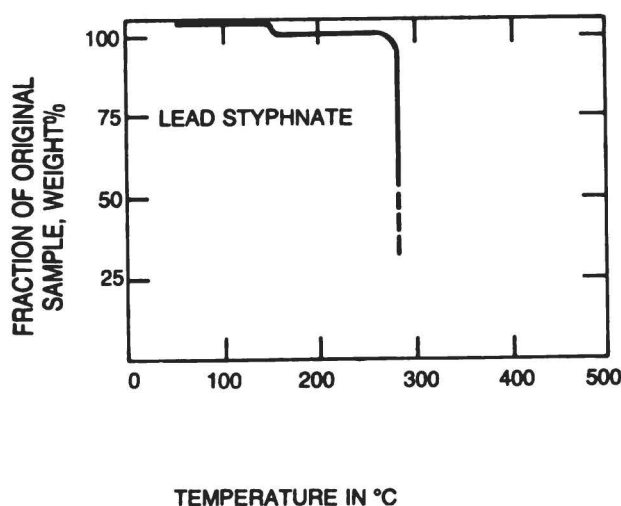

Figure 7-8. TGA curve for lead styphnate.

#### 7-6. Tetracene.

a. Tetracene is also known as guanyldiazoguanyl tetrazene and 4-guanyl-1-(nitrosoaminoguanyl)-1-tetrazene. The compound (figure 7-9) is a colorless to pale yellow, fluffy material with needle crystals, an oxygen balance to  $\text{CO}_2$  of -57.6 percent, an oxygen balance to  $\text{CO}$  of -43 percent, a nitrogen content of 74.4 percent, and a molecular weight of 188.15. Tetracene forms a hydrate with three molecules of water. The melting point of the pure compound is between  $140^\circ\text{C}$  and  $160^\circ\text{C}$  accompanied by decomposition and explosion. The apparent density is only 0.45 grams per cubic centimeter. When compressed at 20,685 kilopascals (3,000 pounds per square inch), the density is 1.05 grams per cubic centimeter. The crystal density is 1.7 grams per cubic centimeter. The compound can be easily dead pressed. Tetracene is practically insoluble in water and ethanol and so can be stored wet with water or a mixture of water and ethanol. The compound is also insoluble in ether, benzene, acetone, carbon tetrachloride, and ethylene dichloride. Tetracene is soluble in dilute nitric acid or strong hydrochloric acid. In a solution with hydrochloric acid, the hydrochloride is precipitated by the addition of ether. Tetracene may then be recovered by treatment with sodium acetate or ammonium hydroxide. The heat of formation is 270 calories

per gram and the heat of detonation is 658 calories per gram. Tetracene can be used in detonators when initiated by another primary explosive. In such cases, the tetracene functions as an intermediate booster or as a sensitizer to flame or heat. In some cases, tetracene is used in primers where as little as two percent tetracene in the composition results in uniformity of percussion sensitivity.

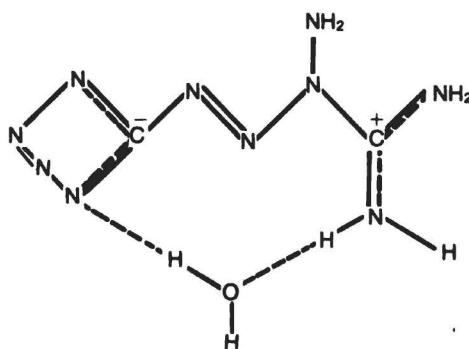

Figure 7-9. Structural formula for tetracene.

b. Boiling water decomposes tetracene liberating two molecules of nitrogen per molecule of tetracene. Hydrolysis with sodium hydroxide yields ammonia, cyanamide, and triazonitrosoaminoguanidine ( $\text{N}_3\text{C}(:\text{NH}).\text{NH}.\text{NH}.\text{NO}$ ). Tetracene reacts with an excess of silver nitrate to form the double salt  $\text{C}_2\text{H}_7\text{N}_{10}\text{OAg}.\text{AgNO}_3.3\text{H}_2\text{O}$  and forms explosive salts such as the perchlorate.

c. To prepare tetracene, 34 grams of aminoguanidine carbonate are dissolved, with warming, in a mixture of 2.5 liters of water and 15.7 grams of glacial acetic acid. After the solution has been filtered and cooled to  $30^\circ\text{C}$ , 27.6 grams of solid sodium nitrite are added. The sodium nitrite is dissolved by stirring. After standing for three or four hours, the solution is shaken to start precipitation and the mixture is allowed to stand for about 20 hours longer. The precipitate of tetracene is separated and washed with water until free from acid. An alternate method is to dissolve five grams of aminoguanidine dinitrate in 30 milliliters of distilled water, cooling to  $0^\circ\text{C}$ , and mixing with a solution of 2.5

grams of sodium nitrite in 15 milliliters of water. While maintaining the temperature at 10°C, 0.5 grams of glacial acetic acid is added to precipitate the tetracene. After allowing the slurry to stand, at least overnight, the precipitate is washed by decantation with several portions of water and then transferred to a filter to be washed more thoroughly with water using suction. Then the product is air dried at room temperature. Another method for the preparation of tetracene uses aminoguanidine sulfate and sodium nitrite in distilled water.

d. Tetracene must meet the following requirements for military use:

Color and appearance:	Tetracene shall be white to light yellow and under the microscope shall appear as needle shaped crystals.
Melting and explosion point:	130 ± 2°C.
Granulation:	100 percent shall pass through a US number 45 standard sieve.
Specific gravity:	1.65 ± 0.05.
Heavy metals:	There shall be no heavy metals present.
Nitrogen content:	74.5 ± 1 percent.

e. Tetracene is of the same order of sensitivity as mercury fulminate and diazodinitrophenol. Using the Bureau of Mines apparatus with a two kilogram weight, the result obtained is seven centimeters as compared to five centimeters for mercury fulminate. Using the Picatinny Arsenal apparatus with a 226.8 gram (eight ounce) weight, the result obtained is eight inches, as compared to nine to ten inches for mercury fulminate. The five second explosion temperature (160°C) is relatively low as compared with the other initial detonating agents. This ease of ignition along with a relatively high heat of explosion and large gas volume produced makes tetracene useful in priming compositions and with lead azide in explosive rivets. When exposed to contact with a flame, tetracene undergoes mild explosion with the production of much black smoke. The minimum detonating charge of mercury fulminate is 0.40 grams.

f. In the sand test, loose tetracene crushes 13.1 grams of sand, but when loaded under a pressure of 20,685 kilopascals (3,000 pounds per square inch), only two grams of sand are crushed. However, tetracene pressed at 20,685 kilopascals crushes 21.1 grams of sand when initiated with mercury fulminate. This

maximum brisance is equal to that of mercury fulminate. The range of brisance values reported are 40 percent to 70 percent of TNT. The volume of gas developed on explosion is 1,190 cubic centimeters per gram. The Trauzl test indicates tetracene has a power of 51 to 63 percent of TNT.

g. Unpressed tetracene, when ignited by a flame, can cause the detonation of loose or pressed PETN, but pressed tetracene does not detonate PETN. Unpressed tetracene can cause low order detonation of tetryl. The unpressed material, however, cannot detonate TNT even when primed with mercury fulminate. Tetracene, therefore, does not have sufficient initiating efficiency to be used with military high explosives.

h. Tetracene is relatively stable at temperatures not greater than 75°C. However, in the 100°C heat test, extreme decomposition occurs in the first 48 hours. The reactivity with water and the slightly high 75°C international test value (0.5 percent) indicate an order of stability approximating that of mercury fulminate. Tetracene gains only 0.77 percent in an atmosphere with 90 percent relative humidity at 30°C.

#### 7-7. Potassium Dinitrobenzofuroxane (KDNBF).

a. KDNBF (figure 7-10) is a red crystalline solid with a nitrogen content of 21.21 percent and molecular weight of 264.20. The oxygen balance of the compound to CO<sub>2</sub>, H<sub>2</sub>O, and K<sub>2</sub>O is -42.4 percent. The anhydrous salt has a density of 2.21 grams per cubic centimeter and a melting point, with explosive decomposition, of 210°C. KDNBF is soluble to the extent of 0.245 grams per 100 grams of water at 30°C. Between the temperatures of -50C to 50°C the specific heat is 0.217 calories per gram per degree centigrade. KDNBF is used in primary compositions.

b. Using a .45 kilogram (one pound) weight in the Picatinny Arsenal impact apparatus, the drop height is only six inches. In the pendulum friction test, KDNBF explodes with both the steel and fiber shoes. The minimum charge required for initiation is 0.30 grams of mercury fulminate or 0.10 grams of lead azide. The sensitivity of KDNBF is between that of mercury fulminate and lead azide.

c. In the sand test, 44.8 grams of sand are crushed, which indicates a brisance of 93 percent of TNT. The volume of gas developed on explosion is 604 cubic centimeters per gram.

d. In the 100°C heat test, the weight loss in the first 48 hours is 0.03 percent and in the second 48 hours 0.05 percent with no explosions in 100 hours. At 30°C and 90 percent relative humidity KDNBF is hygroscopic to the extent of 0.27 percent.

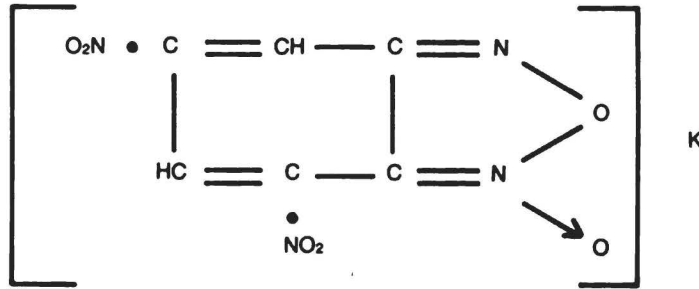

Figure 7-10. Structural formula for KDNBF.

e. The specifications for KDNBF are:

Color:	Light orange to dark red.
Bulk density:	0.2 grams per milliliter, minimum.
Forms:	KDNBF shall be in the form of plate-like crystals. In addition, the dried KDNBF powder shall be easily dispersible.
Granulation:	Through a No. 50 US standard sieve, 98 percent minimum. Retained on a No. 100 US standard sieve, 4 percent maximum. Retained on a No. 200 US standard sieve, 10 to 75 percent. Retained on a No. 270 US standard sieve, 85.0 to 100 percent.
Vacuum stability:	Not more than 1.0 milliliters of gas shall be evolved at $120^{\circ} \pm 0.5^{\circ}\text{C}$ in 40 hours.
Nitrogen content:	19.75 percent $\pm 0.20$ percent.
Differential thermal analysis:	The DTA graph of the tested KDNBF sample shall show only one major exotherm and that exotherm shall occur between $210^{\circ}\text{C}$ and $225^{\circ}\text{C}$ .
Nuclear magnetic resonance:	The NMR spectra of the tested KDNBF sample shall have five distinct peaks one each at 5.77, 5.93, 6.13, 6.27, and 8.63 ppm. The average amplitude of the peaks at 5.93 and 6.13 ppm shall be greater than

thirty percent of the peak at 8.63 ppm. In addition, there shall be no peak at 9.22 ppm greater than five percent of the peak at 8.63 ppm.

**7-8. Lead Mononitroresorcinate (LMNR).**

a. LMNR (figure 7-11) has a nitrogen content of 3.89 percent, an  $\text{NO}_2$  content of 12.77 percent, a lead content of 57.51 percent, and a molecular weight of 360.30. The compound forms microscopic reddish brown crystals. LMNR has slow burning properties and a low combustion temperature. The compound is used in electric detonators with DLA as the spot charge to initiate a PETN base charge, as an upper charge, and as an ingredient in primary compositions.

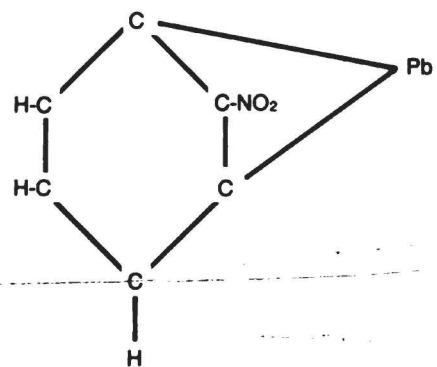

Figure 7-11. Structural formula for LMNR.

b. LMNR is prepared by mononitrating recorcinol then allowing the slurry of mononitrorecorcinol to react with Pb(OH)<sub>2</sub> at elevated temperatures. The LMNR is stored and transported under water with not less than 10 percent denatured alcohol.

c. LMNR must meet the following requirements for military use:

Color and appearance:	LMNR shall be light brown in color.
Apparent density:	0.20 to 0.35 grams per milliliter.
Acidity:	The pH shall be between 5.0 and 6.5 for a solution of one gram of the material in 150 milliliters of water.
Lead content:	70.5 to 72.5 percent.
Nitro group content:	7.2 to 7.6 percent.
Vacuum stability at 120°C:	0.4 milliliters of gas in 40 hours with a 2.3 gram sample, maximum.

**7-9. Primary Compositions.**

a. Primary compositions are mixtures of primary explosives, fuels, oxidizers, and other ingredients used to initiate detonation in high explosive charges or ignite propellants and pyrotechnics. The ingredients and the portions of the ingredients for individual priming compositions are determined empirically from the use the composition is intended for. Fuels commonly used in priming compositions are lead thiocyanate, antimony sulfide, and calcium silicide. The last two also serve to

sensitize the composition to friction or percussion. Oxidizing agents include potassium chlorate and barium nitrate. Other ingredients include primary explosives and binders. The major determining factor in ingredient selection is the impetus which is to detonate the priming composition. The types of impetus commonly used are percussion and electrical.

b. Percussion type primers are used extensively for the ignition of propellants. In the early 1900's this type of priming composition contained mercury fulminates. At the present time, however, mercury fulminate has been replaced by more stable compounds. Potassium chlorate was used in this type of priming composition from about 1917 through World War II. Except for special applications, the use of this compound has been discontinued because of the corrosive action of potassium chloride, a decomposition product of potassium chlorate, on gun barrels. Potassium chlorate is still used in high temperature priming compositions. Table 7-7 lists the composition of two such mixtures. The percentages listed are by weight. Table 7-8 lists several commonly used percussion priming compositions.

Table 7-7. High Temperature Percussion Primers

	G-11	G-16
Potassium chlorate, %	53	53
Antimony trisulfide, %	25	30
Calcium silicide, %	12	17
Temperature resistant explosive, %	10	-

Table 7-8. Percussion Priming Compositions

	FA959	Composition FA982	FA956
Normal lead styphnate, %	35	36	37
Tetracene, %	3.1	12	4
Barium nitrate, %	31	22	32
Antimony sulfide, %	10.3	7	15
Powdered zirconium, %	10.3	9	-
Lead dioxide, %	10.3	9	-
PETN	-	5	5
Aluminum, %	-	-	7
Gum arabic	-	-	0.2 (added)
Autoignition temperature	199°C	240°C	184°C
Decomposition temperature	209°C	262°C	193°C



Table 7-8. Percussion Priming Compositions (Continued)

	FA959	Composition FA982	FA956
Density in grams per cubic centimeter	1.3-2.3(bulk)	1.4-2.4	1.3-2.4
Fuel to oxidizer ratio	0.5 to 1	0.52 to 1	0.69 to 1
Gas volume produced	5-10 milliliters per gram	5-10 milliliters per gram	5-10 milliliters per gram
Electrical spark sensitivity	< 0.05 joules	-	-
Friction sensitivity	yes	-	-

The output of percussion type primers includes hot gases, hot particles, thermal radiation, and a pressure pulse. In some cases the pressure pulse may be a shock wave.

c. Stab detonators are used to directly initiate secondary explosives. As the name implies, a stab detonator is initiated by penetration of a firing pin. The mechanical energy of the firing pin is converted to heat, which causes detonation. Rather than using one homogenous priming mixture as percussion type primers do, stab detonators contain three layers of charges; primary, intermediate, and base. Priming compositions used in the primary charge are shown in table 7-9. The

intermediate charge is an energetic material such as lead azide or black powder. The base charge may be lead azide, black powder, or a more brisant explosive such as RDX or PETN. The base charge initiates the secondary explosive.

- d. Electrical primers are of several types:
- (1) exploding bridge wire
  - (2) hot wire bridge
  - (3) film bridge
  - (4) conductive mixture
  - (5) spark gap

Table 7-9. Stab Detonator Priming Compositions

	NOL 130	Composition PA101	NOL 60
Lead azide, %	20	-	-
Basic lead styphnate, %	40	53	60
Tetracene, %	5	5	5
Barium nitrate, %	20	22	25
Antimony sulfide, %	15	10	10
Powdered aluminum, %	-	10	-
Autoignition temperature	274°C	196°C	210°C
Decomposition temperature	280°C	215°C	227°C
Density in grams per cubic centimeter	1.85 (loading)	1.3-2.0	1.3-2.0
Fuel to oxidizer ratio	0.75 to 1	0.91 to 1	0.4 to 1
Gas volume produced	10-25 milliliters per gram	5-10 milliliters per gram	5-10 milliliters per gram
Electrical spark sensitivity	0.0022 joules	<0.05 joules	0.0022 joules
Friction sensitivity	yes	yes	yes
Hygroscopic	yes	yes	yes

In an exploding bridge wire detonator, a large current is passed through a wire which causes the wire to burst. The bursting of the wire causes a shock wave that is of sufficient strength to cause detonation. With this type of primer no priming composition is used; the wire is placed directly in a charge of RDX or PETN. Hot wire bridges and film bridges use priming compositions.

Examples are listed in table 7-10. In these detonators the wire or film is heated by an electric current. The heat causes ignition of the charge which may then undergo a deflagration to detonation transfer. The functioning of a conductive mixture or spark gap primer is readily apparent from the name. These two types of primers are not commonly used.

Table 7-10. Electric Priming Compositions

	Composition					
	I	II	III	IV	V	VI
Potassium chlorate, %	8.5	55	25	60	66.7	66.7
Lead mononitroresorcinate, %	76.5	-	-	-	-	-
Nitrocellulose, %	15.0	-	-	-	-	-
Lead thiocyanate, %	-	45	-	-	-	-
DDNP, %	-	-	75	20	-	-
Charcoal, %	-	-	-	15	-	-
Nitrostarch, %	-	-	-	5	-	-
Titanium, %	-	-	-	-	33.3	-
Aluminum, %	-	-	-	-	-	33.3
Autoignition temperature	244°C	203°C	396°C	396°C	475°C	446°C
Decomposition temperature	296°C	240°C	451°C	442°C	486°C	465°C
Density in grams per cubic centimeter	1.9-2.6	1.6-2.2	1.6-2.2	1.6-2.4	2.16-2.36	0.6
Fuel to oxidizer ratio	0.9 to 1	0.82 to 1	0.3 to 1	0.25 to 1	0.5 to 1	0.5 to 1
Gas volume produced	-	-	148 milliliters per gram	96 milliliters per gram	286 milliliters per gram	150 milliliters per gram